

Micro Motor Contactor/Contactor Relay J7KNU

Relay-size contactor, smallest in the world!

- AC and DC operated
- Integrated auxiliary contact
- Available as motor contactor and contactor relay
- >3 mm contact clearance acc. to IEC 60335-1 for safety applications
- Reversing contactor with mechanical interlock
- Mirror contacts (NC) acc. to IEC 60947-4-1 for safety applications



Approved Standards

Standard	Guide No (US, C)
UL listed	NLDX, NLDX7
EAC	***

Fulfilled Standards and directives

Standard	Directive
VDE0660	Low Voltage Directive 2006/95/EC
IEC 60947-5-1	EMC Directive 2004/108/EC
EN 60947-5-1... Contactor relay EN 60947-4-1... Motor contactor	RoHS + WEEE 2002/95/EC + "002/96/EC

Ordering information

Micro Motor Contactor/Contactor Relay

J7KNU-□□-□□□-□□□







- 1) Micro Contactor
- 2) Contactor type
- AR: Contactor relay
 - 05: Motor contactor 5A; AC3 400V (Rated motor current)
- 3) Integrated auxilliary contact
- 10: 1 NO; 0 NC (motor contactor)
 - 01: 0 NO; 1 NC (motor contactor)
 - 22: 2 NO; 2 NC (contactor relay)
 - 40: 4 NO; 0 NC (contactor relay)

- 4) R: Reversing contactor
- 5) Coil voltage (AC operated)
- 24: 24 VAC 50/60 Hz
 - 48: 48 VAC 50/60 Hz
 - 90: 100 VAC 50/60 Hz
 - 110: 110–115 VAC 50 Hz/120–125 VAC 60 Hz
 - 180: 200 VAC 50/60 Hz
 - 230: 220–230 VAC 50 Hz/230–250 VAC 60 Hz
- Coil voltage (DC operated)
- 24D: DC 24 V
 - 48D: DC 48 V
 - 60D: DC 60 V
 - 110D: DC 110 V

■ System overview

Micro Motor Contactors







AC Operated

	Ratings		Rated current AC1	Main Contacts		Aux. Contacts ^{*1}		Type	Pack	Weight
	AC2, AC3					Built-in				
	380 V 400 V 415 V kW	660 V 690 V kW	440 V A					Coil Voltage ^{*2} 24 48 90 110 180 230	pcs.	kg/pc.
	Micro Contactors, 3 pole, with Screw Terminals									
	2.2	–	12	3	–	1	–	J7KNU-05-10□□□□□□	10	0.07
	2.2	–	12	3	–	–	1	J7KNU-05-01□□□□□□	10	0.07
	Micro Contactors, 4 pole, with Screw Terminals									
	2.2	–	12	4	–	–	–	J7KNU-05-4□□□□□□	10	0.07
	Micro Reversing Contactors, Mechanical interlocked									
	2.2	–	12	3 × 2	–	–	1 × 2	J7KNU-05-01R□□□□□□	5	0.14

*1 Contacts suitable for electronic circuits, according to EN947-5-4 for rated voltage 24 V DC (test ratings 17 V DC, 5 mA) Positively guided contacts

*2 For Detail Coil information, please see page 3

DC Operated

	Ratings		Rated current AC1	Main Contacts		Aux. Contacts ^{*1}		Type	Pack	Weight
	AC2, AC3					Built-in				
	380 V 400 V 415 V kW	660 V 690 V kW	440 V A					Coil voltage 24 V DC 2.5 W	pcs.	kg/pc.
	Micro Contactors, 3 pole, with Screw Terminals									
	2.2	–	12	3	–	1	–	J7KNU-05-10□□□□□D	10	0.09
	2.2	–	12	3	–	–	1	J7KNU-05-01□□□□□D	10	0.09
	Micro Contactors, 4 pole, with Screw Terminals									
	2.2	–	12	4	–	–	–	J7KNU-05-4□□□□□D	10	0.09
	Micro Reversing Contactors, Mechanical interlocked									
	2.2	–	12	3 × 2	–	–	1 × 2	J7KNU-05-01R□□□□□D	5	0.18

*1 Contacts suitable for electronic circuits, according to EN947-5-4 for rated voltage 24 V DC (test ratings 17 V DC, 5 mA) Positively guided contacts

Micro Contactor Relays 4-pole

AC Operated

	Ratings		Rated Current I_n A	Contacts		Distinc. Number acc. to DIN EN 50011	Type Coil voltage ^{*1} 24 48 90 110 180 230	Pack pcs.	Weight kg/pc.
	230 V A	400 V A		NO	NC				
	4-pole, With Screw Terminals								
	3	1.5	5	4	–	40E	J7KNU-AR-40 □□□□□□	10	0.07
	3	1.5	5	2	2	22E	J7KNU-AR-22 □□□□□□	10	0.07

*1 Other coil voltages see page 3

DC Operated

	Ratings		Rated Current I_n A	Contacts		Distinc. Number acc. to DIN EN 50011	Type Coil voltage 24 48 60 110	Pack pcs.	Weight kg/pc.
	230 V A	400 V A		NO	NC				
	4-pole, With Screw Terminals								
	3	1.5	5	4	–	40E	J7KNU-AR-40 □□□□□ D	10	0.09
	3	1.5	5	2	2	22E	J7KNU-AR-22 □□□□□ D	10	0.09

Snap-On Adapter

	Specification	Type		Pack pcs.	Weight kg/pc.
		P1039	J75KN-P1039		
	For snap-on mounting of J7KNU series on 35 mm DIN-rail acc. DIN EN 50022	P1039	J75KN-P1039	10	0.0061

Coil voltage

Suffix	Voltage Marking at coil		Rated Control Voltage U_s			
	for 50 Hz V	for 60 Hz V	range for 50 Hz		range for 60 Hz	
			min V	max V	min V	max V
24	24	24	22	24	24	24
48	48	48	48	50	48	52
90	100	100	90	100	100	105
110	110–115	120–125	110	115	120	125
180	200	200	185	200	200	210
230	220–230	230–250	220	230	230	250
400	380–400	440	380	400	415	440

Standard voltages in bold type letters. Coil not exchangeable.
Please see datasheet J7KN Motor Contactor for RC-suppressor units.

■ Engineering data and characteristics

Data according to IEC 60947-4-1, EN 60947-4-1, VDE 0660

Main Contacts	Type	J7KNU-05...	J7KNU-05R	J7KNU-AR...	
Rated insulation voltage U_i	V AC	440		440 ¹	
Making capacity I_{eff}	at $U_e = 440$ V AC A	65		—	
Breaking capacity I_{eff} $\cos\varphi = 0,65$	400 V AC A	50		—	
Utilization category AC1					
Switching of resistive load					
Rated operational current $I_e (=I_{th})$ at 40°C, open	A	12		5	
Rated operational power of three-phase resistive loads 50-60Hz, $\cos\varphi = 1$	230 V kW	4.7		1.9	
	240 V kW	4.8		2	
	400 V kW	8.3		3.3	
	415 V kW	8.6		3.5	
Rated operational current $I_e (=I_{th})$ at 60°C, enclosed	A	8		3	
Rated operational power of three-phase resistive loads 50-60Hz, $\cos\varphi = 1$	230 V kW	3.1		1.1	
	240 V kW	3.3		1.2	
	400 V kW	5.5		2	
	415 V kW	5.7		2.1	
Minimum cross-section of conductor at load with $I_e (=I_{th})$	mm ²	1.5		1.5	
Utilization category AC2 and AC3					
Switching of three-phase motors					
Rated operational current I_e open and enclosed	220 V A	6.2		—	
	230 V A	6.2		—	
	240 V A	5.6		—	
	380-400 V A	5		—	
	415-440 V A	5		—	
Rated operational power of three-phase motors 50-60Hz	220-240 V kW	1.5		—	
	380-440 V kW	2.2		—	
Utilization category AC4					
Switching of squirrel cage motors, inching					
Rated operational current I_e open and enclosed	220 V A	4.9		—	
	230 V A	4.9		—	
	240 V A	4.1		—	
	380-400 V A	3.5		—	
	415-440 V A	3.5		—	
Rated operational power of three-phase motors 50-60Hz	220-240 V kW	1.1		—	
	380-440 V kW	1.5		—	
Utilization category DC1					
Switching of resistive load					
Time constant $L/R \leq 1$ ms	1 pole 24 V A	12		5	
Rated operational current I_e	60 V A	12		5	
	110 V A	—		—	
	220 V A	—		—	
	3 poles in series 24 V A	12	12		5
		60 V A	12		5
		110 V A	12		5
		220 V A	—		—

Main Contacts	Type	J7KNU-05...	J7KNU-05R	J7KNU-AR...
Utilization category DC3 and DC5				
Switching of shunt motors and series motors				
Time constant $L/R \leq 15\text{ms}$	1 pole 24 V A	12		—
Rated operational current I_e	60 V A	—		—
	110 V A	—		—
	220 V A	—		—
	3 poles in series 24 V A	12		—
	60 V A	12		—
	110 V A	12		—
	220 V A	—		—
Maximum ambient temperature				
Operation	open °C	-40 to +60 (+90) ²		
	enclosed °C	-40 to +40		
with thermal overload relay	open °C	-25 to +60		
	enclosed °C	-25 to +40		
Storage	°C	-50 to +90		
Short circuit protection				
for contactors without thermal overload relay				
Coordination-type "1" according to IEC 60947-4-1				
Contact welding without hazard of persons				
max. fuse size	gL (gG) A	20		—
Coordination-type "2" according to IEC 60947-4-1				
Light contact welding accepted				
max. fuse size	gL (gG) A	—		—
Contact welding not accepted				
max. fuse size	gL (gG) A	—		—
For contactors with thermal overload relay the device with the smaller admissible backup fuse (contactor or thermal overload relay) determines the fuse size.				
Cable cross-sections				
for contactors				
main connector				
	solid or stranded mm ²	0,5-1.5		
	flexible mm ²	0,5-1.5		
	flexible with multicore cable end mm ²	0,5-1.5		
Cables per clamp		2		
	solid or stranded mm ²	20-14		
Frequency of operations z				
Contactors without thermal overload relay				
	without load 1/h	10000		
	AC3, I_e 1/h	600		—
	AC4, I_e 1/h	120		—
	DC3, I_e 1/h	600		—
Mechanical life				
AC operated	$S \times 10^6$	3 xxx ³		
DC operated	$S \times 10^6$			
Short time current	10s-current A	50		—
Power loss per pole	at $I_e/AC3$ 400V W	0.2		—
Resistance to shock acc. to IEC 68-2-27				
Shock time 20 ms sine-wave	NO g	2.5		2.5
	NC g	2.5		2.5

¹ With reduced control voltage range 0,9 up to $1,0 \times U_s$ and with reduced rated current $I_e/AC1$ according to $I_e/AC3$.

² With reduced control voltage range 0,9 up to $1,0 \times U_s$ and with reduced rated current $I_e/AC1$ according to $I_e/AC3$.

³ Data on request.

Data according to IEC 60947-4-1, EN 60947-4-1, VDE 0660

Auxiliary Contacts	Type	J7KNU-05...	J7KNU-05R	J7KNU-AR...
Rated insulation voltage	U_i V~	440 ^{*1}		
Thermal rated current I_{th} to 440 V				
Ambient temperature	40°C A	5		
	60°C A	3		
Verlustleistung pro Pol	at I_{th} W	0.25		
Utilization category AC15				
Rated operational current I_e	220-240 V A	3		
	380-415 V A	1.5		
	440 V A	1		
Utilization category DC13				
Rated operational current I_e	60 V A	0.5		
Maximum ambient temperature				
Operation	open °C	-40 to +60 (+90) ^{*2}		
	enclosed °C	-40 to +40		
Storage	°C	-40 to +90		
Short circuit protection				
Short-circuit current 1kA, contact welding not accepted				
max. fuse size	gL (gG) A	10		
For contactors with thermal overload relay the device with the smaller admissible control fuse (contactor or thermal overload relay) determines the fuse.				
Power consumption of coils				
AC operated	inrush VA	9		
	sealed VA	4		
	W	1.8		
DC operated	W	2.5		
Operation range of coils				
in multiples of control voltage U_s	AC operated	0.85-1.1		
Switching time at control voltage $U_s \pm 10\%$^{*3,*4}	DC operated	0.8-1.1		
AC operated	make time ms	13-18		
	release time ms	5-10		
	arc duration ms	10-15		
DC operated	make time ms	10-20		
	release time ms	2-10		
	arc duration ms	10-15		
Cable cross-section				
Auxiliary connector	solid mm ²	0.5-1.5		
	flexible mm ²	0.5-1.5		
	flexible with multicore cable end mm ²	0.5-1.5		
Clamps per pole		2		
	solid or stranded AWG	20-14		

^{*1} Suitable at 440 V for: earthed-neutral systems, overvoltage category I to III, pollution degree 3 (standard-industry): $U_{imp} = 4$ kV. Data for other conditions on request.

^{*2} With reduced control voltage range 0,9 up to 1,0 x U_s and with reduced rated current $I_e/AC1$ according to $I_e/AC3$

^{*3} Summary switching time = release time + arc duration.

^{*4} Release time of NC make time of NO increase when suppressor units for voltage peak protection are used (Varistor, RC-units, Diode units).

Data according to UL508

Main Contacts (cULus)	Type	J7KNU-05...	J7KNU-05R...	J7KNU-AR...
Rated operational current "General Use"	A	12		5
Rated operational power of three motors at 60 Hz (3ph)	110-120 V hp	1/2		—
	200-208 V hp	1		—
	220-240 V hp	1		—
	277 V hp	1 1/2		—
Rated operational power of AC motors at 60 Hz (1ph)	110-120 V hp	1/6		—
	200-208 V hp	1/2		—
	220-240 V hp	3/4		—
Fuse/Short-circuit current	A/kA	30/5		—
Rated voltage	VAC	300		300
Auxiliary Contacts (cULus)	heavy pilot duty AC	B300		B300
	standard pilot duty DC	R300		R300

Motor Rating
P_n = AC4
380/ 220/
400V 230V
kW kW

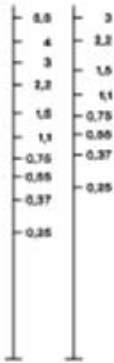

Motor Rating
P_n = AC3
380/ 220/
400V 230V
kW kW



Breaking Current
I_b (= I_e = AC1)
A

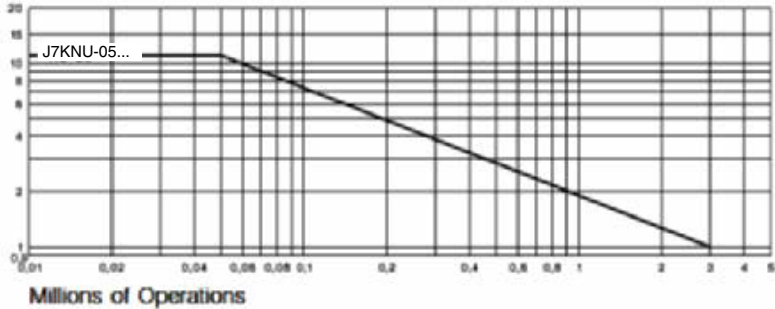

■ Wiring diagrams

Contactors

J7KNU-05-01

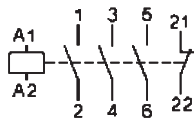

J7KNU-05-10

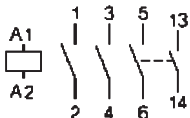

J7KNU-AR-40

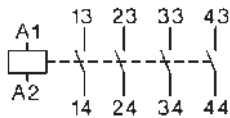

J7KNU-AR-22

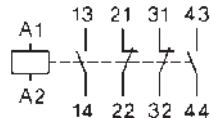

Reversing Contactors

J7KNU-05-01R

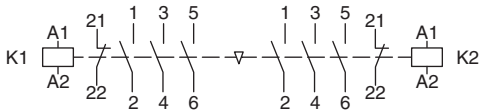

■ Dimensions

Contactors

J7KNU-05...
J7KNU-AR...

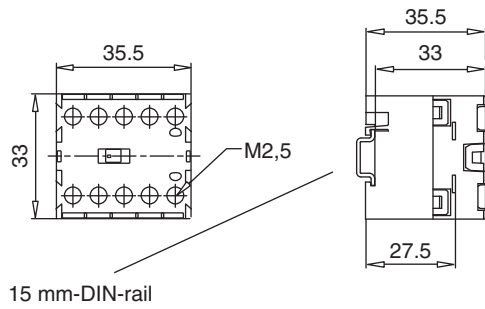

Reversing Contactors

J7KNU-05-01R

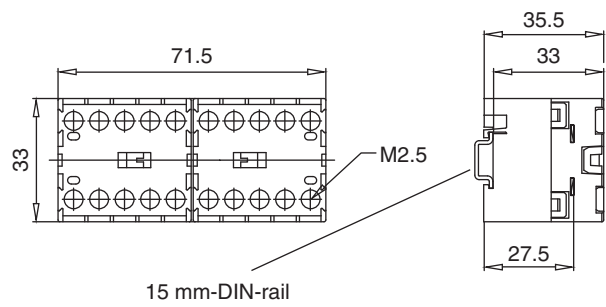

Snap-On Adapter J75KN-P1039

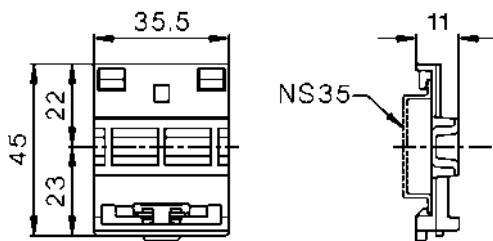

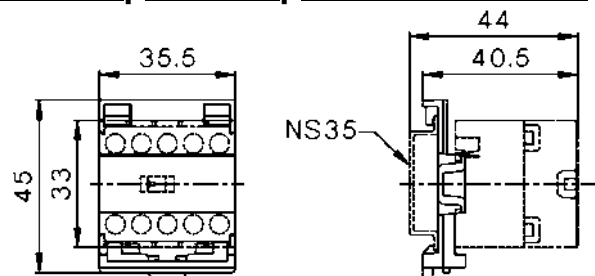

**J7KNU-05-... and J7KNU-AR-...
with Snap-On Adapter J75KN-P1039***







*Adaptor J75KN-P1039 can be used aslo with models J7KNU-05-01R

Discernment at UL-Standards

Recognized Component Industrial Control Equipment	Listed Industrial Control Equipment
UL issues yellow "Guide cards" with Guide- and File-No.	UL issues white "Guide cards" with Guide- and File-No.
Devices have permission to be marked with  on the label	Devices have to be marked with the "UL-Listing Mark" 
Devices as components approved for "factory wiring": devices for employment in control panels, when they are selected, mounted and wired according to the charging conditions by skilled worker.	Devices approved for "field wiring", a) devices for employment in control panels, when they are mounted and wired by skilled worker. b) devices for retail in USA
Valid UL-Standards: UL 508,"Standard for Industrial Control Equipment" (partly limited)	Valid UL-Standards: UL 508,"Standard for Industrial Control Equipment" (unlimited) UL 486"Standard for Wire Connectors and Soldering Lugs"

Are devices approved as "Listed Equipment"  the approval is also valid for using as "Recognized Component" .

Approvals

Country	USA, Canada		Switzerland	Europe	Register of Shipping			CENELEC CB-Certificates
	UL 		SEV 		Great Britain LRS	GUS MRS	Italy RINA	
Type								
Mini Contactors J7KNA and Accessories								
J7KNA-AR...(D)	o	-	-	o	-	-	-	o
J7KNA-09...(D)	o	-	-	o	-	-	-	o
J7KNA-12...(D)	o	-	-	o	-	-	-	-
J73KN-A..., J73KN-AM	o	-	-	o	-	-	-	o
Contactors Series J7KN								
J7KN(G)-10...(D)	o	-	-	o	-	-	-	o
J7KN(G)-14...(D)	o	-	-	o	-	-	-	o
J7KN(G)-18...(D)	o	-	-	o	-	-	-	o
J7KN(G)-22...(D)	o	-	-	o	-	-	-	o
J7KN(G)-24...(D)	o	-	-	o	-	-	-	o
J7KN(G)-32...(D)	o	-	-	o	-	-	-	o
J7KN(G)-40...(D)	o	-	-	o	-	-	-	o
J7KN-50...(D)	o	-	-	o	-	-	-	o
J7KN-62...(D)	o	-	-	o	-	-	-	o
J7KN-74...(D)	o	-	-	o	-	-	-	o
J7KN-85...(D)	o	-	-	o	-	-	-	o
J7KN-110...(D)	o	-	-	o	-	-	-	o
J7KN-151...	o	-	-	o	-	-	-	-
J7KN-176...	o	-	-	o	-	-	-	-
J7KN-200...	-	-	-	o	-	-	-	-
Accessories								
J73KN-B...	o	-	-	o	-	-	-	o
J73KN-C...	o	-	-	o	-	-	-	o
J74KN-B-PT...	o	-	-	o	-	-	-	-
J74KN-A-VG...	o	-	-	o	-	-	-	-
J74KN-B-VG	-	-	-	o	-	-	-	-
J74KN-C...	o	-	-	o	-	-	-	-
J74KN-D...	o	-	-	o	-	-	-	-
Thermal Overload Relays								
J7TKN-A...	o	-	-	o	-	-	-	o
J7TKN-B...	o	-	-	o	-	-	-	o
J7TKN-C...	o	-	-	o	-	-	-	o
J7TKN-D...	o	-	-	o	-	-	-	o
J7TKN-E...	o	-	-	o	-	-	-	o
J7TKN-F...	-	-	-	o	-	-	-	-
Micro Contactors J7KNU								
J7KNU-AR...	o	-	-	o	-	-	-	-
J7KNU-05...	o	-	-	o	-	-	-	o

o In Standard version approved x In Test - Not provided for test until now

Do not use/install these products before having read the applicable precautions as listed in Cat. No. J09-EN-01 available from www.europe.omron.com or on request from OMRON local sales office.

ALL DIMENSIONS SHOWN ARE IN MILLIMETERS.