

## **NB-series**

**NB3Q-TW□□B**

**NB5Q-TW□□B**

**NB7W-TW□□B**

**NB10W-TW01B**

# **Programmable Terminals**

## **STARTUP GUIDE MANUAL**

**OMRON**

## © OMRON, 2011

All rights reserved. No part of this publication may be reproduced, stored in a retrieval system, or transmitted, in any form, or by any means, mechanical, electronic, photocopying, recording, or otherwise, without the prior written permission of OMRON.

No patent liability is assumed with respect to the use of the information contained herein. Moreover, because OMRON is constantly striving to improve its high-quality products, the information contained in this manual is subject to change without notice. Every precaution has been taken in the preparation of this manual. Nevertheless, OMRON assumes no responsibility for errors or omissions. Neither is any liability assumed for damages resulting from the use of the information contained in this publication.

### Trademarks

- Sysmac and SYSMAC are trademarks or registered trademarks of OMRON Corporation in Japan and other countries for OMRON factory automation products.
- Windows, Windows 98, Windows XP, Windows Vista, Windows 7, and Excel are registered trademarks of Microsoft Corporation in the USA and other countries.
- EtherCAT® is registered trademark and patented technology, licensed by Beckhoff Automation GmbH, Germany.
- ODVA, CIP, CompoNet, DeviceNet, and EtherNet/IP are trademarks of ODVA.
- The SD logo is a trademark of SD-3C, LLC. 

Other company names and product names in this document are the trademarks or registered trademarks of their respective companies.

**NB-series**

**NB3Q-TW□□B**

**NB5Q-TW□□B**

**NB7W-TW□□B**

**NB10W-TW01B**

**Programmable Terminals**

**Startup Guide Manual**

*Revised April 2013*



# Introduction

---

Thank you for purchasing an NB-series Programmable Terminal.

NB-Series Programmable Terminals (PTs) are designed to handle information generated in FA production sites. Be sure to understand the functions and performances etc thoroughly before using PT correctly.

## Intended Audience

This manual is intended for the following personnel, who must also have knowledge of electrical systems (an electrical engineer or the equivalent).

- Personnel in charge of introducing FA systems into production facilities.
- Personnel in charge of designing FA systems.
- Personnel in charge of installing and connecting FA facilities.
- Personnel in charge of managing FA systems and facilities

## General Precautions

- The user must operate the product according to the performance specifications described in the operation manuals.
- Do not use the PT touch switch input functions for applications where danger to human life or serious property damage is possible, or for emergency switch applications.
- Before using the product under conditions which are not described in the manual or applying the product to nuclear control systems, railroad systems, aviation systems, vehicles, combustion systems, medical equipment, amusement machines, safety equipment, and other systems, machines and equipment that may have a serious influence on lives and property if used improperly, consult your OMRON representative.
- Make sure that the ratings and performance characteristics of the product are sufficient for the systems, machines, and equipment, and be sure to provide the systems, machines, and equipment with double safety mechanisms.
- This manual provides information for connecting and setting up an NB-Series PT. Be sure to read this manual before attempting to use the PT and keep this manual close at hand for reference during installation and operation.

# NB-series Manuals

NB-series manuals are organized in the sections listed in the following tables. Refer to the appropriate section in the manuals as required.

## Programmable Terminals Startup Guide Manual (Cat. No. V109) (This manual)

Section	Contents
Section 1 NB Overview	This section provide specifications of the NB Unit, describes its names and functions of the various parts.
Section 2 System Design	This section describes the manual structure, takes NB7W as an example to introduce the operation procedures of the NB system.
Section 3 Installation and Wiring	This section describes how to install and wire the NB Unit.
Section 4 Screen Creation	This section describes how to create a demonstration project through NB-Designer.
Section 5 Run	This section describes how to start running at the Host side and prepare to send screen data to NB7W.
Section 6 Maintenance and Troubleshooting	This section describes the maintenance and inspection methods for preventing errors occurring, and troubleshooting measures when errors occur.

## Programmable Terminals NB-Designer Operation Manual (Cat. No. V106)

Section	Contents
Section 1 Introduction	This section provides an outline of the NB-series PTs, including their functions, features, connection types and communication methods.
Section 2 Installation and Startup of NB-Designer	This section describes how to install and start the NB-Designer.
Section 3 Functions of NB-Designer	This section describes the functions of NB-Designer.
Section 4 Functions of NBManager	This section describes the functions of NBManager.
Section 5 Maintenance and Abnormality Handling	This section describes the maintenance and check to prevent the abnormality occurrence and the handling of the abnormalities occurred in NB Unit.
Section 6 Descriptions of New Functions Added into NB□□-TW01B	This section describes the new functions added into NB□□-TW01B, the system attributes and the component attributes.
Section 7 Pictbridge Printing	This section describes the Pictbridge printing function.
Appendices	The appendices provide lists of the NB Units, the Communication Units, the applicable PLCs, the registers supported by PLC, and the list of NB-Designer functions.

## Programmable Terminals Setup Manual (Cat. No. V107)

Section	Contents
<b>Section 1 Part Names and Functions</b>	This section describes the names and functions of the various parts of an NB Unit.
<b>Section 2 Installing the NB Unit and Connecting Peripheral Devices</b>	This section describes the methods used to install the NB Unit and connect peripheral devices.
<b>Section 3 System Setting Mode</b>	This section describes the System Setting Mode.
<b>Section 4 Calibrate Mode</b>	This section describes the Calibrate Mode.
<b>Appendices</b>	The appendices provide information on specifications, dimensions, wirings, and lists of the NB Units, the applicable PLCs and options.

## Programmable Terminals Host Connection Manual (Cat. No. V108)

Section	Contents
<b>Section 1 List for All PLCs Supported by NB series</b>	This section lists all PLCs supported by NB Units.
<b>Section 2 Connecting to SIEMENS PLCs</b>	This section describes the connection to SIEMENS PLCs.
<b>Section 3 Connecting to Mitsubishi PLCs</b>	This section describes the connection to Mitsubishi PLCs.
<b>Section 4 Connecting to Schneider PLCs</b>	This section describes the connection to Schneider PLCs.
<b>Section 5 Modbus Connection</b>	This section describes the connection on Modbus protocol.
<b>Section 6 Connecting to Delta PLCs</b>	This section describes the connection to Delta PLCs.
<b>Section 7 Connecting to LSIS PLCs</b>	This section describes the connection to LSIS PLCs.
<b>Section 8 Connecting to Panasonic Industrial Devices SUNX PLCs</b>	This section describes the connection to Panasonic Industrial Devices SUNX PLCs.
<b>Section 9 Connecting to Allen-Bradley (Rockwell) PLC</b>	This section describes the connection to Allen-Bradley PLC.
<b>Section 10 Connecting to PLC of GE Fanuc Automation Inc.</b>	This section describes the connection to PLC of GE Fanuc Automation Inc.



### WARNING

Failure to read and understand the information provided in this manual may result in personal injury or death, damage to the product, or product failure. Please read each section in its entirety and be sure you understand the information provided in the section and related sections before attempting any of the procedures or operations given.

# Manual Structure

## Page Structure and Icons

The following page structure and icons are used in this manual.

The diagram illustrates the structure of a manual page. It shows a page titled "2 Installing the NB Unit and Connecting Peripheral Devices". Inside, there is a sub-heading "2-1-2 Installation onto the Operation Panel". The text describes installing the NB Unit into an operation panel. A procedure step "1" includes a diagram of "Opening dimensions" (Width and Height) and a table of models and their dimensions. Step "2" describes inserting panel fixators. A "Precautions for Safe Use" section includes icons for safe use, correct use, and additional information. The page number "2-3" is at the bottom right.

Models	Opening Dimension (W H mm)	
NB3Q-TW00B/TW01B	119.0(+0.5/-0)	93.0(+0.5/-0)
NB5Q-TW00B/TW01B	172.4(+0.5/-0)	131.0(+0.5/-0)
NB7W-TW00B/TW01B	191.0(+0.5/-0)	137.0(+0.5/-0)
NB10W-TW01B	258.0(+0.5/-0)	200.0(+0.5/-0)

**Precautions for Safe Use**

- When operating on the operation panel, make sure to keep metal particles from entering the Unit.
- The mounting panel must be between 1.6 and 4.8 mm thick. The NB Unit must be installed in a control panel.
- For the sake of waterproof and dustproof, all the fixators must be evenly tightened to a torque of 0.5-0.6 Nm. If the tightening torque exceeds the specified value, or the tightening is not even, deformation of the front panel may occur.
- Make sure that the operation panel is clean, unbent, and strong enough for the installation process.

This illustration is provided only as a sample and may not literally appear in this manual.

## Special Information

Special information in this manual is classified as follows:

- Precautions for Safe Use**  
Precautions on what to do and what not to do to ensure using the product safely.
- Precautions for Correct Use**  
Precautions on what to do and what not to do to ensure proper operation and performance.
- Additional Information**  
Additional information to increase understanding or make operation easier.



# Terminology

The following terminology is used in this manual.

Terms	Descriptions
NB Unit	Indicates the main Unit of the products in the OMRON NB Series of Programmable Terminal.
NB Series	Indicates products in the OMRON NB□□ Series of Programmable Terminal. In this manual, unless otherwise specified, NB□□ Series is taken as the subject concerned.
PLC	Indicates a Programmable Controller.
CP Series	Indicates the following products in the OMRON CP Series of Programmable Controllers: CP1H, CP1L, CP1E
CS/CJ Series	Indicates the following products in the OMRON CS/CJ Series of Programmable Controllers: CS1G, CS1H, CS1G-H, CS1H-H, CJ1G, CJ1M, CJ2M, CJ2H
NJ Series	Indicates the following OMRON SYSMAC NJ Series of Programmable Controllers: NJ501, NJ301
C Series	Indicates the following products in the OMRON C Series of Programmable Controllers: C200HX(-Z), C200HG(-Z), C200HE(-Z), CQM1, CQM1H, CPM1A, CPM2A, CPM2C
Serial Communication Unit	Indicates a Serial Communication Unit for an OMRON SYSMAC CS/CJ-Series PLC.
Serial Communication Board	Indicates a Serial Communication Board for an OMRON SYSMAC CS/CJ-Series PLC.
Communication Board	Indicates a Communication Board for an OMRON C200HX/HG/HE(-Z) PLC.
CPU Unit	Indicates a CPU Unit in the OMRON CP, CS/CJ or SYSMAC C Series of Programmable Controllers.
NB-Designer	Indicates the OMRON NB-Designer.
Host	Indicates the PLC and other units functioning as the control devices for NB-Series Units.
PT	Indicates an OMRON Programmable Terminal.



# CONTENTS

---

Introduction .....	1
NB-series Manuals .....	2
Manual Structure .....	4
Terminology .....	5
Safety Precautions .....	12
Precautions for Safe Use .....	15
Precautions for Correct Use .....	17
Conformance to EC Directives .....	18
Related Manuals .....	19
<b>Sec. 1 NB Overview .....</b>	<b>1-1</b>
1-1 Models of NB Series .....	1-2
1-2 Part Names and Functions .....	1-3
<b>Sec. 2 System Design .....</b>	<b>2-1</b>
2-1 About this Manual .....	2-2
2-2 Demonstration System .....	2-3
<b>Sec. 3 Installation and Wiring .....</b>	<b>3-1</b>
3-1 Installation.....	3-2
3-2 Equipment Wiring.....	3-5
<b>Sec. 4 Screen Creation .....</b>	<b>4-1</b>
4-1 Starting NB-Designer .....	4-2
4-2 Main Window of NB-Designer.....	4-3
4-3 Creating Project.....	4-5
4-4 Screen Creation .....	4-13
4-5 PT Property .....	4-27
4-6 Save and Load Project .....	4-28

<b>Sec. 5</b>	<b>Run .....</b>	<b>5-1</b>
<hr/>		
5-1	Preparations.....	5-2
5-2	Run NB7W .....	5-5
<b>Sec. 6</b>	<b>Maintenance and Troubleshooting .....</b>	<b>6-1</b>
<hr/>		
6-1	Maintenance .....	6-2
6-2	Checking and Cleaning .....	6-3
6-3	Troubleshooting.....	6-5
6-3-1	Countermeasures for errors .....	6-5
6-3-2	Communication-related Troubles .....	6-26
6-3-3	Hardware Troubles .....	6-30
6-3-4	Errors occurred when the UDP communications with OMRON PLC .....	6-32
6-3-5	Other Troubles.....	6-32
6-4	Unit Replacement Precautions.....	6-34
<b>Revision History .....</b>		<b>1</b>

## ***Read and Understand this Manual***

Please read and understand this manual before using the product. Please consult your OMRON representative if you have any questions or comments.

## ***Warranty and Limitations of Liability***

### ***WARRANTY***

OMRON's exclusive warranty is that the products are free from defects in materials and workmanship for a period of one year (or other period if specified) from date of sale by OMRON.

OMRON MAKES NO WARRANTY OR REPRESENTATION, EXPRESS OR IMPLIED, REGARDING NON-INFRINGEMENT, MERCHANTABILITY, OR FITNESS FOR PARTICULAR PURPOSE OF THE PRODUCTS. ANY BUYER OR USER ACKNOWLEDGES THAT THE BUYER OR USER ALONE HAS DETERMINED THAT THE PRODUCTS WILL SUITABLY MEET THE REQUIREMENTS OF THEIR INTENDED USE. OMRON DISCLAIMS ALL OTHER WARRANTIES, EXPRESS OR IMPLIED.

### ***LIMITATIONS OF LIABILITY***

OMRON SHALL NOT BE RESPONSIBLE FOR SPECIAL, INDIRECT, OR CONSEQUENTIAL DAMAGES, LOSS OF PROFITS OR COMMERCIAL LOSS IN ANY WAY CONNECTED WITH THE PRODUCTS, WHETHER SUCH CLAIM IS BASED ON CONTRACT, WARRANTY, NEGLIGENCE, OR STRICT LIABILITY.

In no event shall the responsibility of OMRON for any act exceed the individual price of the product on which liability is asserted.

IN NO EVENT SHALL OMRON BE RESPONSIBLE FOR WARRANTY, REPAIR, OR OTHER CLAIMS REGARDING THE PRODUCTS UNLESS OMRON'S ANALYSIS CONFIRMS THAT THE PRODUCTS WERE PROPERLY HANDLED, STORED, INSTALLED, AND MAINTAINED AND NOT SUBJECT TO CONTAMINATION, ABUSE, MISUSE, OR INAPPROPRIATE MODIFICATION OR REPAIR.

## ***Application Considerations***

### ***SUITABILITY FOR USE***

OMRON shall not be responsible for conformity with any standards, codes, or regulations that apply to the combination of products in the customer's application or use of the products.

At the customer's request, OMRON will provide applicable third party certification documents identifying ratings and limitations of use that apply to the products. This information by itself is not sufficient for a complete determination of the suitability of the products in combination with the end product, machine, system, or other application or use.

The following are some examples of applications for which particular attention must be given. This is not intended to be an exhaustive list of all possible uses of the products, nor is it intended to imply that the uses listed may be suitable for the products:

- Outdoor use, uses involving potential chemical contamination or electrical interference, or conditions or uses not described in this manual.
- Nuclear energy control systems, combustion systems, railroad systems, aviation systems, medical equipment, amusement machines, vehicles, safety equipment, and installations subject to separate industry or government regulations.
- Systems, machines, and equipment that could present a risk to life or property.

Please know and observe all prohibitions of use applicable to the products.

**NEVER USE THE PRODUCTS FOR AN APPLICATION INVOLVING SERIOUS RISK TO LIFE OR PROPERTY WITHOUT ENSURING THAT THE SYSTEM AS A WHOLE HAS BEEN DESIGNED TO ADDRESS THE RISKS, AND THAT THE OMRON PRODUCTS ARE PROPERLY RATED AND INSTALLED FOR THE INTENDED USE WITHIN THE OVERALL EQUIPMENT OR SYSTEM.**

### ***PROGRAMMABLE PRODUCTS***

OMRON shall not be responsible for the user's programming of a programmable product, or any consequence thereof.

## ***Disclaimers***

### ***CHANGE IN SPECIFICATIONS***

Product specifications and accessories may be changed at any time based on improvements and other reasons.

It is our practice to change model numbers when published ratings or features are changed, or when significant construction changes are made. However, some specifications of the products may be changed without any notice. When in doubt, special model numbers may be assigned to fix or establish key specifications for your application on your request. Please consult with your OMRON representative at any time to confirm actual specifications of purchased products.

### ***DIMENSIONS AND WEIGHTS***

Dimensions and weights are nominal and are not to be used for manufacturing purposes, even when tolerances are shown.

### ***PERFORMANCE DATA***

Performance data given in this manual is provided as a guide for the user in determining suitability and does not constitute a warranty. It may represent the result of OMRON's test conditions, and the users must correlate it to actual application requirements. Actual performance is subject to the OMRON Warranty and Limitations of Liability.

### ***ERRORS AND OMISSIONS***



The information in this manual has been carefully checked and is believed to be accurate; however, no responsibility is assumed for clerical, typographical, or proofreading errors, or omissions.

# Safety Precautions

## Notation Used for Safety Information

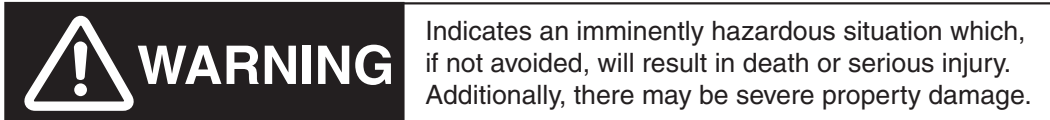
The following notation is used in this manual to provide precautions required to ensure safe usage of the product. The safety precautions that are provided are extremely important to safety. Always read and heed the information provided in all safety precautions.



-  Precautions for Safe Use  
Indicates precautions on what to do and what not to do to ensure using the product safely.
  -  Precautions for Correct Use  
Indicates precautions on what to do and what not to do to ensure proper operation and performance.
- Note** Indicates suggestive information and precautions on operation of the product.

## Symbols



- Prohibition  
Indicates a general prohibition.



- Caution  
Indicates general cautionary, warning, or danger level information.



## WARNING

Do not attempt to take the product apart and do not touch the product inside while the power is being supplied. Otherwise it may result in electric shock.



Always ensure that the personnel in charge confirm that installation, inspection, and maintenance were properly performed for the NB Unit.

“Personnel in charge” refers to individuals qualified and responsible for ensuring safety during machine design, installation, operation, maintenance, and disposal.



Ensure that installation and post-installation checks are performed by personnel in charge who possess a thorough understanding of the machinery to be installed.



Do not use the input functions of the touch switch, etc. of the NB Unit, in applications that involve human life, in applications that may result in serious injury, or for emergency stop switches.



Do not attempt to disassemble, repair, or modify the NB Unit. Otherwise it may impair the safety functions.



Never press more than two points on the touch panel of the NB Unit at a time. Otherwise, it may activate a switch somewhere between the two points.



## Precaution

# WARNING

## Wiring

In the case of the NB Series, when grounding the positive terminal of power supply of 24 V to the NB, do not ground functional grounding terminal at NB side. Some functions of a PC connected to the NB may cause a short circuit and the NB Unit may cause damage.

- Caution:

Depending on the types of PC, SG terminals of RS-232C port or USB port and contour of connector can be connected. As the contour of tool port of the NB and the functional grounding terminal are not insulated, they are connected. Therefore, connecting the PC allows GND terminal and functional grounding terminal of the NB to be connected. If the power supply of 24V to the NB is grounded positively, grounding the functional grounding terminal allows a short circuit as shown in the diagram below and may result in damage.

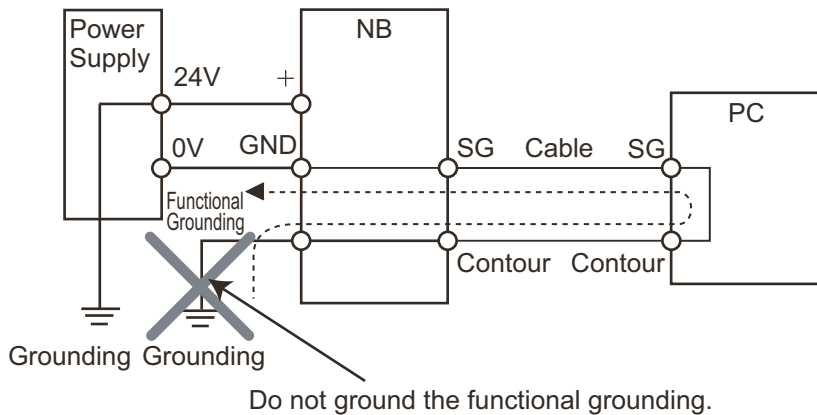

## Test Function

The Test Function is performed on PC so that a problem may occur affected by the timing or the differences with communication route. When the test function is performed, considering possible unexpected circumstances on PC, confirm that any dangerous event will not occur beforehand.

# Precautions for Safe Use

---

- When unpacking the NB Units and the peripheral devices, check carefully for any external scratches or other damages. Also, shake the Units gently and check for any abnormal sound.
- The NB Unit must be installed in a control panel.
- The mounting panel must be between 1.6 and 4.8 mm thick. Tighten the Mounting Brackets evenly to a torque of between 0.5 and 0.6 N·m to maintain water and dust resistance. If the tightening torque exceeds the specified value, or the tightening is not even, deformation of the front panel may occur. What is more, make sure the panel is not dirty or warped and that it is strong enough to hold the Units.
- Do not let metal particles enter the Units when preparing the panel.
- Do not connect an AC power supply to the DC power terminals.
- Use a DC power with a slight voltage fluctuation and reinforced or double insulation, and that will provide a stable output even if the input is momentarily interrupted for 10 ms.  
Rated Power Supply Voltage: DC 24 V (Allowable range DC 20.4 ~ 27.6 V)
- Do not perform a dielectric voltage test.
- Before connecting the power supply to the NB unit, mount the cable on the terminal block. Make the connection by using terminal screws crimping on a twisted-pair cable with a crimping range of 12~26 AWG, and only 6.5 mm of insulation peel of the cable needs to be peeled off. Tighten the terminal screws at a torque of between 0.3 and 0.5 N·m. Make sure the screws are properly tightened. Do not use the terminal block of NB3Q-TW□□B for other models. NB3Q-TW□□B has different pin definitions on the terminal block.
- To prevent malfunctions caused by noise, ground the Unit correctly.
- Do not touch the packaging part of the circuit board with your bare hands. Discharge any static electricity from your body before handling the board.
- When using the No. 6 pin of the serial communication port COM1 connector for a voltage of DC+5V, make sure the supply equipment's current capacity is below 250mA before using it. The DC+5V voltage output of the NB unit is  $+5V\pm 5\%$ , and the maximum current is 250mA. (The serial communication port COM1 of NB3Q-TW□□B is unable to output the current.)
- Turn OFF the power supply before connecting or disconnecting cables.
- Always keep the connector screws firmly tightened after the communication cable is connected.
- The maximum tensile load for cables is 30 N. Do not apply loads greater than this.
- Confirm the safety of the system before turning ON or OFF the power supply, or pressing the reset button.
- The whole system may stop depending on how the power supply is turned ON or OFF. Turn ON/OFF the power supply according to the specified procedure.
- Reset by pressing the reset button, or restart the power supply, once the DIP switch settings are changed.
- To ensure the system's safety, make sure to incorporate a program that can confirm the normal functionality of the NB Unit before running the system.
- Start actual system application only after sufficiently checking screen data, macros and the operation of the program at the host side.
- Do not press the touch panel with a force greater than 30 N.
- Do not use hard or pointed objects to operate or scrub the screen, otherwise, the surface of the screen may be damaged.
- Confirm the safety of the system before pressing the touch panel.
- Signals from the touch switches may not be input if the touch switches are pressed consecutively at high speed. Confirm each input before proceeding to the next one.
- Do not accidentally press the touch panel when the backlight is not lit or when the display does not appear. Make sure of the safety of the system before pressing the touch panel.
- To use numeric input functions safely, always make maximum and minimum limit settings.
- Before initializing screen data, confirm that existing data is backed up at the NB-Designer.

- When changing the password with the screen, do not reset or turn OFF the power supply until writing is finished. Failure to save the password may cause the screen to fail to function.
- When using an equipment monitor, confirm the safety of the system before carrying out the following operations:
  - Changing monitor data.
  - Changing operation mode.
  - Forced set/reset.
  - Changing the current value or the set value.
- Do not connect a USB connector to any device that is not applicable.
- When connecting the equipment with the USB HOST connector, make sure the supply equipment's current capacity is below 150mA before using it. The DC+5V voltage output of the NB Unit is +5V±5%, and the maximum current is 150mA.
- Before connecting a USB connector to a device, make sure that the device is free of damage.
- Commercially available and the recommended USB HUBs are different from the general specifications of the NB Unit. The unit may not function well in an environment subject to noise, static electricity. Therefore, when using a USB HUB, employ sufficient noise and static electricity insulation measures, or install it at a site free of noise or static electricity.
- While uploading or downloading screen data or system programs, do not perform the following operations that may corrupt the screen data or the system program:
  - Turning OFF the power supply of the NB Unit.
  - Pressing the PT's reset switch.
- Dispose of the Units and batteries according to local ordinances as they apply.



- Do not dispose the product into a fire. Doing so may cause the damage with the battery or electronic components.
- Do not apply an impact with the lithium cell, charge it, dispose it into a fire, or heat it. Doing either of them may cause an ignition or a bursting.
- When exporting products with lithium primary batteries containing perchlorate at 6ppb or above to or delivering them through California, USA, the following precautionary measures have to be publicized. Perchlorate material - applicable through special processing. Refer to <http://www.dtsc.ca.gov/hazardouswaste/perchlorate>. NB-Series products contain lithium primary batteries. When exporting products containing this kind of batteries to or delivering them through California, USA, label all the product packages as well as the appropriate delivery packages.
- Do not use benzene, paint thinner, or other volatile solvents, and do not use chemically treated cloths.
- Do not dispose the Units together with general waste at waste yards. When disposing them, follow the related local ordinances or rules.
- Cannot replace the backlight lamp inside the NB Unit.
- Deterioration over time can cause the touch points to move. Calibrate the touch panel periodically.
- Water and oil resistance will be lost if the front sheet is torn or is peeling off. Do not use the Unit, if the front sheet is torn or is peeling off.
- The rubber packing will deteriorate, shrink, or harden depending on the operating environment. Inspect the rubber packing periodically.
- The communication cables of the COM1 and COM2 connectors are not interchangeable. Confirm the pins of the ports before carrying out communications. (NB3Q-TW□□B only has COM1.)
- Periodically check the installation conditions in applications where the PT is subject to contact with oil or water.
- Do not perform the following operations during the communication of the USB memory:
  - Turning off the power supply of the NB Unit.
  - Pressing the Reset button on the NB Unit.
  - Removing the USB memory.
- Do not use the USB memory in the environment subject to strong vibration.

# Precautions for Correct Use

---

- Do not install the unit in any of the following locations:
  - Locations subject to severe changes in temperature
  - Locations subject to temperatures or humidity outside the range specified in the specifications
  - Locations subject to condensation as the result of high humidity
  - Locations subject to corrosive or flammable gases
  - Locations subject to strong shock or vibration
  - Locations outdoors subject to direct wind and rain
  - Locations subject to strong ultraviolet light
  - Locations subject to dust
  - Locations subject to direct sunlight
  - Locations subject to splashing oil or chemicals
- Take appropriate and sufficient countermeasures when installing systems in the following locations:
  - Locations subject to static electricity or other forms of noise
  - Locations subject to strong electric field or magnetic field
  - Locations close to power supply lines
  - Locations subject to possible exposure to radioactivity
- Precautions for software:
  - The update, restoration, uninstall and reinstallation of software in running status is prohibited in order to guarantee the correct use of the product.

# Conformance to EC Directives

NB-Series Programmable Terminals are EMC compliant.

## Concepts

OMRON products are electronic devices that are incorporated in machines and manufacturing installations. OMRON PTs conform to the related EMC Directives (see note) so that the devices and machines into which they are built can more easily conform to EMC Directives. The actual products have been through inspections and are completely in accordance with EMC directives. However, when they are built into customers' systems, whether the systems also comply with these Directives is up to the customers for further inspection.

EMC-related performance of OMRON PTs will vary depending on the configuration, wiring, and other conditions of the OMRON equipment or control panel. The customer must, therefore, perform final checks to confirm that the overall machine or device conforms to EMC standards.

**Note** The applicable EMC (Electromagnetic Compatibility) standards are as follows:  
EMS (Electromagnetic sensitivity): EN61131-2: 2007  
EMI (Electromagnetic Interference): EN61131-2: 2007

## Conformance to EC Directives

NB-Series Programmable Terminals are EC compliant. Heed the following precautions in order to ensure that the customer's overall machine and device conform to EC Directives.

- 1** The PT must be installed in a control panel.
- 2** You must use reinforced insulation or double insulation for the DC power supply and the DC power supply must have minimal voltage fluctuations and provide a stable output even if the power supply input is interrupted for 10 ms.
- 3** The PTs conform to the standard EN 61131-2, but radiated emission characteristics (10m regulations) may vary depending on the configuration of the control panel used, other devices connected to the control panel, wiring, and other conditions. You must therefore confirm that the overall machine or equipment complies with EC Directives.
- 4** This is a Class A product (Product for industry purpose). It may cause radio interference in residential areas, in which case the user may be required to take adequate measures to reduce interference.

# Related Manuals

The related manuals are as follows:

Devices and Software	Manual Name	Manual No.	
NB series	NB Series NB-Designer Operation Manual	V106	
	NB Series Setup Manual	V107	
	NB Series Host Connection Manual	V108	
	NB Series Startup Guide (This manual)	V109	
PLC	SYSMAC CP Series CP1L CPU Unit Operation Manual	W462	
	SYSMAC CP Series CP1H/L CPU Unit Programming Manual	W451	
	SYSMAC CP Series CP1H CPU Unit Operation Manual	W450	
	SYSMAC CP Series CP1E CPU Unit Hardware USER'S Manual	W479	
	SYSMAC CP Series CP1E CPU Unit Software USER'S Manual	W480	
	SYSMAC C200HX/HG/HE(-E/-ZE) Installation Guide	W302	
	SYSMAC C200HX/HG/HE Operation Manual	W303	
	SYSMAC C200HX/HG/HE(-ZE) Operation Manual	W322	
	SYSMAC CPM1A Operation Manual	W317	
	SYSMAC CPM2A Operation Manual	W352	
	SYSMAC CPM1/CPM1A/CPM2A/CPM2C/SRM1(-V2) Programming Manual	W353	
	SYSMAC CPM2C Operation Manual	W356	
	SYSMAC CS1 Series CS1G/H Operation Manual	W339	
	SYSMAC CS/CJ Series Serial Communications Boards and Serial Communications Units Operation Manual	W336	
	SYSMAC CJ Series CJ1G/H(-H) CJ1M CJ1G Operation Manual	W393	
	SYSMAC CS/CJ Series Programming Manual	W394	
	SYSMAC CS/CJ Series INSTRUCTIONS Reference Manual	W340	
	SYSMAC CS/CJ Series Programming Consoles Operation Manual	W341	
	SYSMAC CS/CJ Series Communications Commands Reference Manual	W342	
	SYSMAC CJ Series CJ2 CPU Unit Hardware USER'S Manual	W472	
	SYSMAC CJ Series CJ2 CPU Unit Software USER'S Manual	W473	
	SYSMAC CS/CJ Series CS1W/CJ1W-ETN21 (100Base-TX) Ethernet Units Operation Manual Construction of Networks	W420	
	SYSMAC CS/CJ Series CS1W/CJ1W-ETN21 (100Base-TX) Ethernet Units Operation Manual Construction of Applications	W421	
	SYSMAC CS/CJ Series CS1W/CJ1W-EIP21 (100Base-TX) EtherNet/IP™ Units Operation Manual	W465	
	SYSMAC CP Series CP1L-EL/EM CPU Unit Operation Manual	W516	
	NJ Series CPU Unit Hardware USER'S Manual	W500	
	NJ Series CPU Unit Software USER'S Manual	W501	
	NJ Series CPU Unit Built-in EtherNet/IP™ Port USER'S Manual	W506	
	NJ Series Troubleshooting Manual	W503	
	External Tool	CX-Programmer Ver.9.□ Operation Manual	W446
		Sysmac Studio Version 1 Operation Manual	W504





# 1

## NB Overview

---

This section provide specifications of the NB Unit, describes its names and functions of the various parts.

---

<b>1-1 Models of NB Series</b> .....	<b>1-2</b>
<b>1-2 Part Names and Functions</b> .....	<b>1-3</b>

# 1-1 Models of NB Series

There are 7 models of NB series PTs available now: NB3Q-TW00B/TW01B, NB5Q-TW00B/TW01B, NB7W-TW00B/TW01B and NB10W-TW01B.

With TFT display used, NB series has higher cost performance. The LED backlight used is more environmentally-friendly, energy-efficient and with longer service life compared to traditional CCFL backlight. The display device of NB series (PT: Programmable Terminals) can be used for information display and receive-input operation. It can show operating states of the system and devices in graphic forms to users.

## ● Major Parameters

Models	NB3Q		NB5Q		NB7W		NB10W
	TW00B	TW01B	TW00B	TW01B	TW00B	TW01B	TW01B
<b>Performance Specifications</b>							
Display Size	3.5" TFT LCD		5.6" TFT LCD		7" TFT LCD		10.1" TFT LCD
Resolution	QVGA 320×240		QVGA 320×234		WVGA 800×480		
Display Color	65536 colors						
Backlight	LED						
Memory	128M FLASH + 64M DDR2 RAM (NB□□-TW01B supports the USB storage)						
Downloading Programs	USB / Serial Port / Ethernet (Only NB□□-TW01B supports the Ethernet downloading)						
Pictbridge printing	By the USB Slave port (The user must use the NB-Designer of version 1.22 or later to update the kernel and file system of NB Unit when using the Pictbridge printing function for the first time. For details, refer to <i>Section 7 Pictbridge Printing</i> in <i>NB-Designer Operation Manual</i> .)						
USB Port	Equivalent of USB 2.0 Full speed NB□□-TW00B: USB Slave ×1 NB□□-TW01B: USB Slave ×1, USB Host ×1						
Communication Ports	Serial Port	COM1: RS-232C/422A/485		COM1: RS-232C COM2: RS-232C/422A/485			
	Network Interface	Ethernet					
<b>Electrical Specifications</b>							
Rated Power	5W	9W	6W	10W	7W	11W	14W
Rated Voltage	DC24V						
<b>Structural Specifications</b>							
Case Color	Black						
Dimensions W×H×D(mm)	129.8×103.8×52.8		184.0×142.0×46.0		202.0×148.0×46.0		268.8×210.8×54.0
Weight	300g	305g	620g	627g	710g	715g	1525g
<b>Software Tools</b>							
Version No.	NB-Designer Ver1.2X For download the application programs, please access your local Omron website. If local site cannot be found, please access Omron IA global site " <a href="http://www.ia.omron.com/">http://www.ia.omron.com/</a> " at first and select the area where you are.						

**Note** NB7W is used as the abbreviated name of NB7W-TW□□B hereinafter.

# 1-2 Part Names and Functions

This section describes the names and functions of each part of the NB Unit.

- **NB3Q-TW00B/NB3Q-TW01B model**

Front view

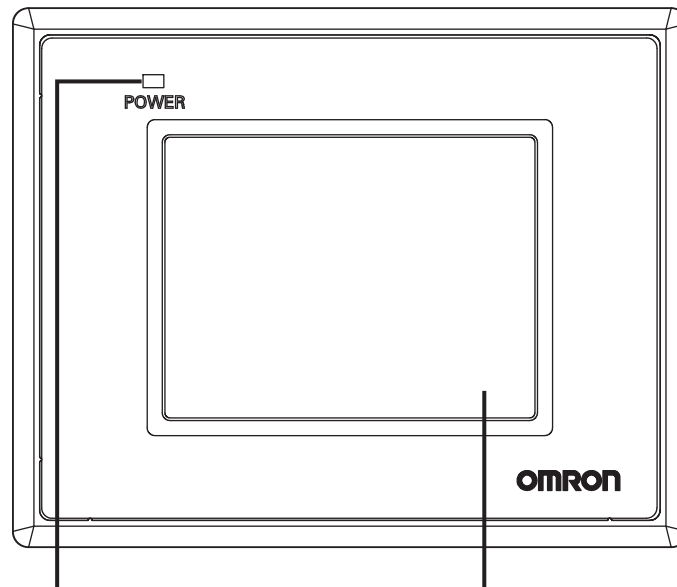

Power Indicator

Display

Back view

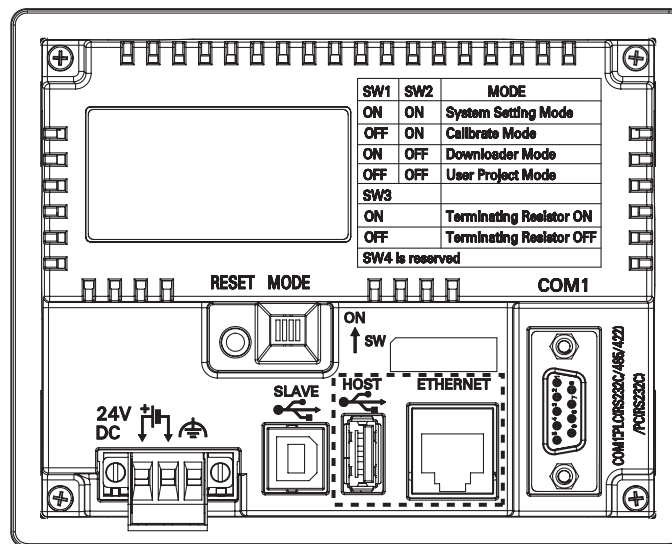

⋯⋯⋯: NB□□-TW01B only



### Precautions for Safe Use

Confirm the safety of the system before turning ON or OFF the power supply, or pressing the reset button.

● NB5Q-TW00B/NB5Q-TW01B model

Front view

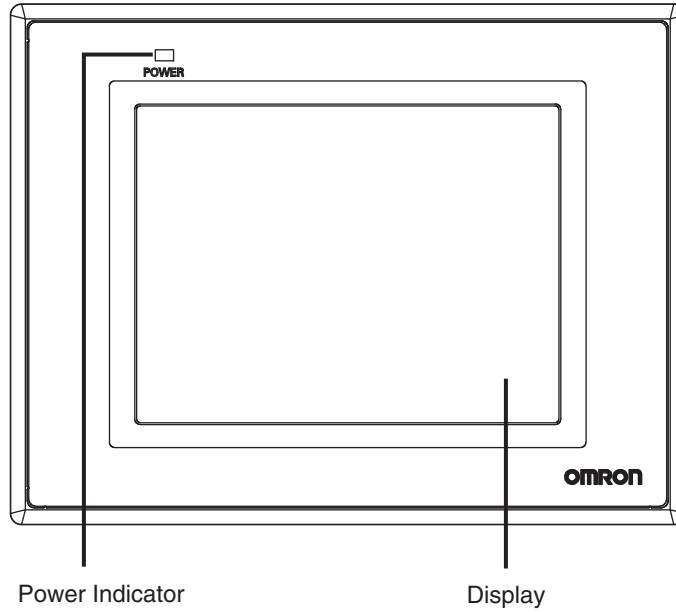

Back view

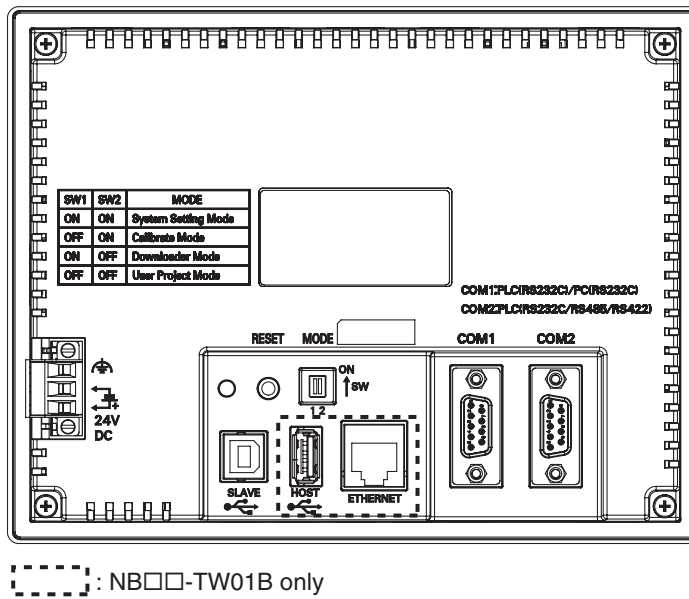

**Precautions for Safe Use**

Confirm the safety of the system before turning ON or OFF the power supply, or pressing the reset button.

● NB7W-TW00B/NB7W-TW01B model

Front view

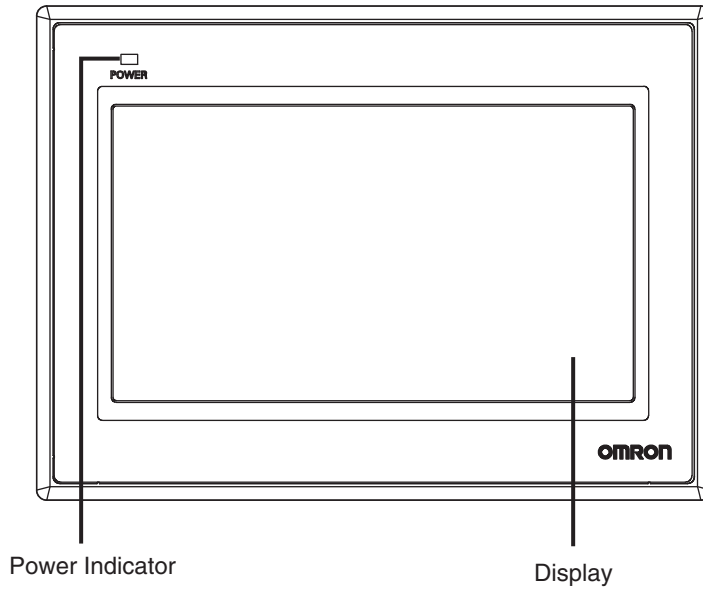

Back view

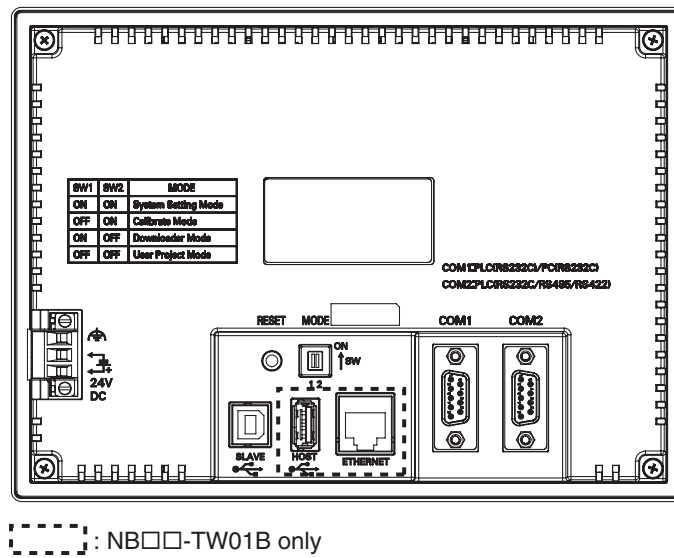

**Precautions for Safe Use**

Confirm the safety of the system before turning ON or OFF the power supply, or pressing the reset button.

● NB10W-TW01B model

Front view

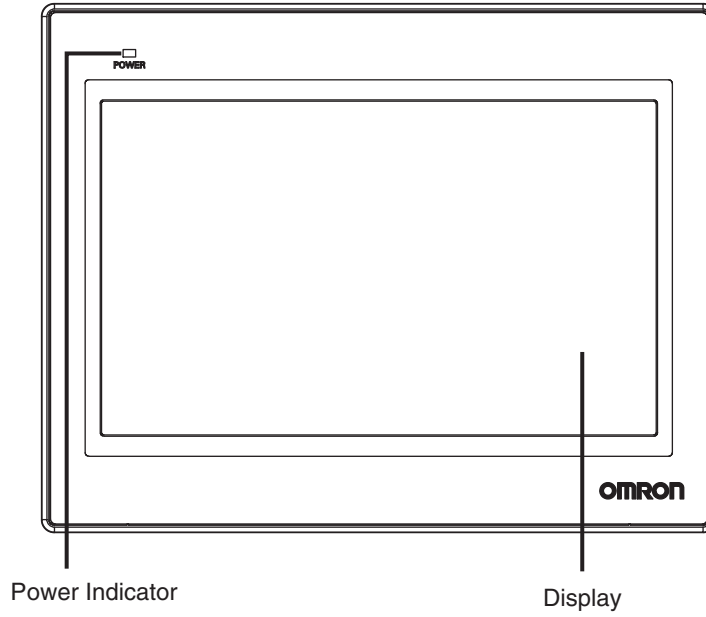

Back view

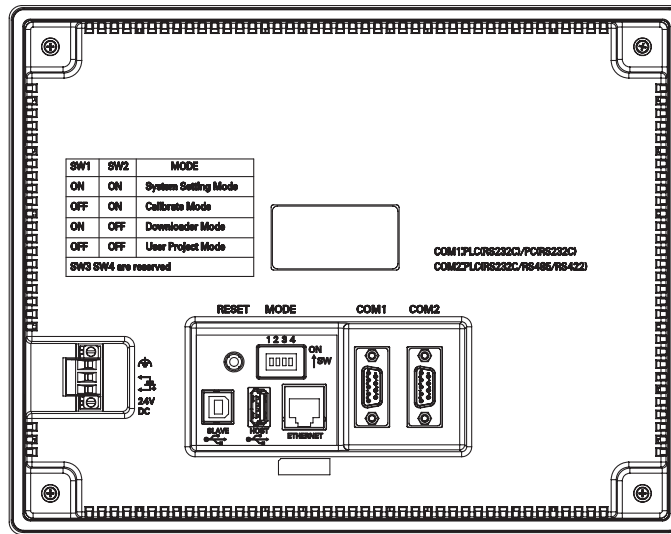

**Precautions for Safe Use**

Confirm the safety of the system before turning ON or OFF the power supply, or pressing the reset button.

## ● Serial Port COM1

- NB5Q/NB7W/NB10W-TW□□B

Serial port COM1 is a 9-pin D-type socket port. This port supports RS-232C communication function, making it connectable to a controller which features RS-232C function, and it can also be used for downloading programs or debugging for the product.

The pins are defined as follows:



Pins	Signals	I/O	Functions
1	NC	-	-
2	SD	O	Sending data
3	RD	I	Receiving data
4	RS(RTS)	O	Request to send*
5	CS(CTS)	I	Clear to send*
6	DC+5V	-	DC+5V output (Max. current: 250mA)
7	NC	-	-
8	NC	-	-
9	SG	-	Signal ground

\* Pins 4 and 5 are not used, thus not compliant with RS or CS functions.



### Precautions for Safe Use

When using the No. 6 pin of the serial communications port COM1 connector for a voltage of DC+5V, make sure the supply equipment's current capacity is below 250 mA before using it. The DC+5V voltage output of the NB Unit is  $+5V \pm 5\%$ , and the maximum current is 250 mA.

- NB3Q-TW□□B

NB3Q-TW□□B has only 1 serial port COM1, and this port supports communication (non-isolated) based on RS-232C, RS-422 and RS-485, of which only 1 connection mode can be applied at one time. By means of the RS-232C mode (PIN 2~5), it can be connected to a controller based on RS-232C, and can also be used for downloading programs, as well as debugging for the product (connected to a PC). While with the RS-422 or the RS-485 mode (PIN 1, PIN 6~8), only a PLC can be connected.

The pins are defined as follows:



Pins	Signals	I/O	Functions		
			RS-232C	RS-485	RS-422A
1	SDB+	I/O	-	-	Sending data(+)
2	SD	O	Sending data	-	-
3	RD	I	Receiving data	-	-
4	RS(RTS)	O	Request to send*	-	-
5	CS(CTS)	I	Clear to send*	-	-
6	RDB+	I/O	-	RS485B Send/Receive data(+)	Receiving data(+)
7	SDA-	I/O	-	-	Sending data(-)
8	RDA-	I/O	-	RS485A Send/Receive data(-)	Receiving data(-)
9	SG	-	Signal ground		

\* Pins 4 and 5 are not used, thus not compliant with RS or CS functions.

## ● Precaution for Cable Fabrication

The COM 2 ports included in this manual and marked by cable manufacturers are intended for the PT of NB5Q/NB7W/NB10W-TW□□B models, therefore when communication connection is carried out with the COM 1 port of NB3Q-TW□□B, please refer to the pin definitions in this section prior to connection.

## ● Serial Port COM2

- NB5Q/NB7W/NB10W-TW□□B

Serial port COM2 is a 9-pin D-type socket port. This port supports RS-232C/RS-485/RS-422A communication function.

The pins are defined as follows:



Pins	Signals	I/O	Functions		
			RS-232C	RS-485	RS-422A
1	SDB+	I/O	-	-	Sending data(+)
2	SD	O	Sending data	-	-
3	RD	I	Receiving data	-	-
4	Terminal R1	-	-	Terminal resistor	
5	Terminal R2	-	-	Terminal resistor	
6	RDB+	I/O	-	Send/Receive data(+)	Receiving data(+)
7	SDA-	I/O	-	-	Sending data(-)
8	RDA-	I/O	-	Send/Receive data(-)	Receiving data(-)
9	SG	-	Signal ground		

## ● USB HOST

NB□□-TW01B is equipped with USB HOST port, which is USB A-type port. Through this port, USB memory can be connected to perform uploading, downloading, project operation and storage of related data. And its pins are defined as follows:

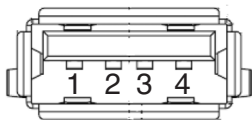

Pins	Signals	Functions
1	Vbus	USB +5V power supply output (Max. current: 150mA)
2	D-	Data -
3	D+	Data +
4	GND	USB power supply ground



### Precautions for Safe Use

When connecting the equipment with the USB HOST connector, make sure the supply equipment's current capacity is below 150mA before using it. The DC+5V voltage output of the NB Unit is +5V±5%, and the maximum current is 150mA.



## ● USB SLAVE

USB SLAVE port is USB B-type port, which can connect the USB port on PC side to perform the uploading, downloading, debugging of the programs for the product and the Picbridge printing. And its pins are defined as follows:

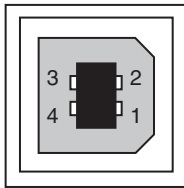

Pins	Signals	Functions
1	Vbus	USB +5V power supply output
2	D-	Data -
3	D+	Data +
4	GND	USB power supply ground

## ● Ethernet Interface

NB□□-TW01B is equipped with Ethernet Interface, which is adaptive RJ-45 type interface with the transmission rate of 10M / 100M. It can be connected with PC to perform the uploading and downloading of the programs and the system refreshing, and can also be used to realize the communication with the controller supporting the Ethernet communication. And its pins are defined as follows:

Pins	Signals	Functions
1	TD+	Sending data +
2	TD-	Sending data -
3	RD+	Receiving data +
4	---	Not used
5	---	Not used
6	RD-	Receiving data -
7	---	Not used
8	---	Not used

TOP

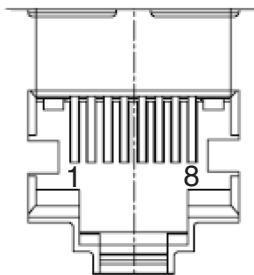

Bottom

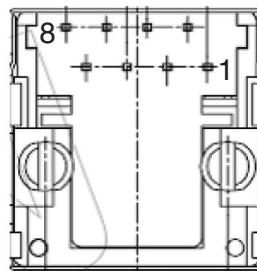

## ● DIP Switch

NB5Q/NB7W only has 2 switches SW1 and SW2, while for the NB3Q and NB10W, there are totally 4 DIP switches, and for all models, SW1 and SW2 feature the same functions. The settings and corresponding operating modes are as follows:

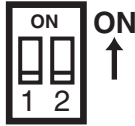

SW1	SW2	Operating modes
ON	ON	System Setting Mode
OFF	ON	Calibrate Mode
ON	OFF	Downloader Mode
OFF	OFF	User Project Mode

- System Setting Mode: The PT will be launched into a built-in system setup screen, and is subject to the user for the settings of brightness, system time, buzzer and Pictbridge printing function.
- Calibrate Mode: When the user touches the panel, a symbol “+” will pop up on the screen, with which the touch control precision level can be calibrated.
- Downloader Mode: This is used for updating Kernel and root file system.
- User Project Mode: This is the User Project Mode of NB-Series PTs. The PT will display the startup screen of the project already downloaded.

As mentioned above, the settings and corresponding operating modes of the switches SW1 and SW2 of NB3Q and NB10W are the same as those of NB5Q/NB7W (see the table above), and the functions of SW3 and SW4 of NB3Q and NB10W are stated as below:

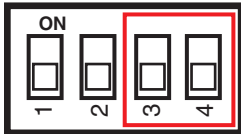

Switch No. (corresponding model(s))	Status	Descriptions of Function
SW3 (NB3Q)	ON	Terminal resistance ON
	OFF	Terminal resistance OFF
SW3 (NB10W)	Reserved	
SW4 (NB3Q/NB10W)	Reserved	

## ● Reset Switch

When pressing the reset switch located on the back side of the PT, the system will be rebooted.



# System Design

---

This section describes the manual structure, takes NB7W as an example to introduce the operation procedures of the NB system.

---

<b>2-1 About this Manual</b> .....	<b>2-2</b>
<b>2-2 Demonstration System</b> .....	<b>2-3</b>

## 2-1 About this Manual

---

This section describes the manual structure and operation procedures of the NB7W system by way of example.

### ● Manual Structure

The case of the system using the NB Series (Take NB7W as an example) is described in the following sequence in this manual:

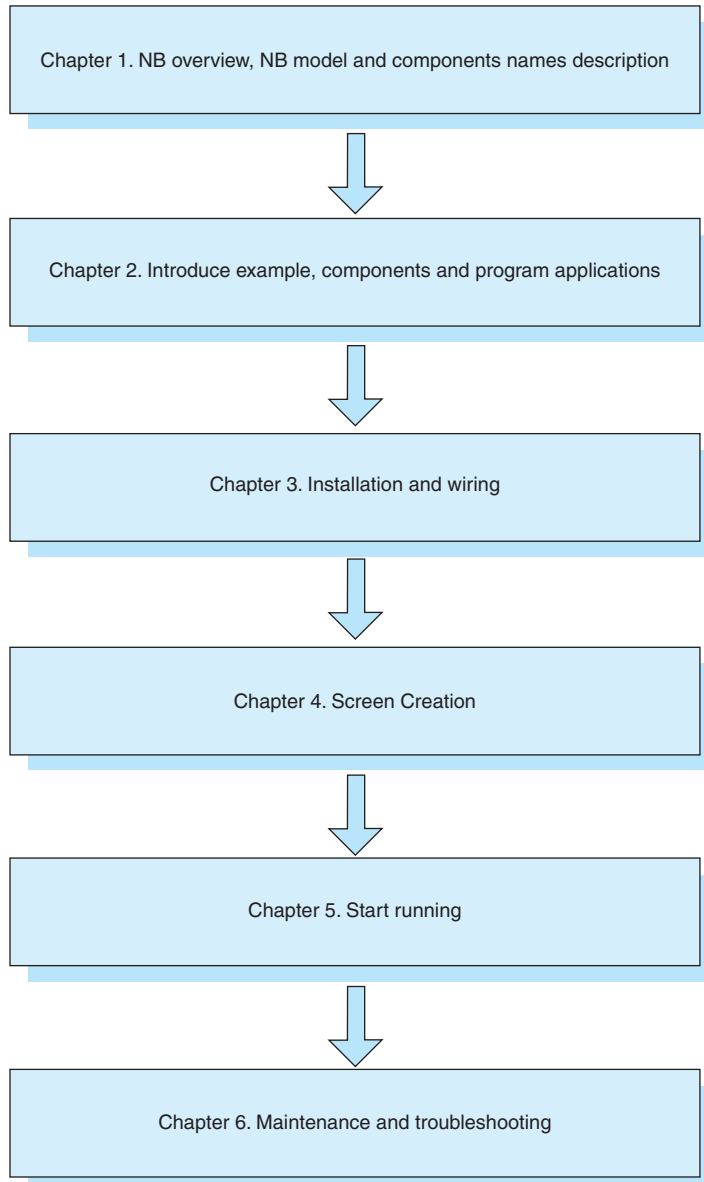

The examples of circuit configuration, wiring and applications are used for reference only. Be sure to refer to the relevant manuals for the specifications, performance and safety of each component when configuring practical systems.

## 2-2 Demonstration System

This section takes garage door control as a demonstration system. After NB-Designer is installed, the project file of this demonstration system will be shown in the Start Menu. Click [Sample Screen(NB7)] in the [Start]-[All Programs]-[OMRON]-[NB-Designer]-[Screen Data] to open the demonstration project. Please note that the demonstration project includes macro files, so it can only be edited by running as an administrator in Vista or Win7 systems. Run the NB-Designer as the administrator, and then open the demonstration project in the [project]-[DemoProject\_NB7W] file of NB-Designer's installation directory.

### ● Operation

- The demonstration project is the system which opens/closes the garage door responding to the inputs from NB7W or the sensor installed to the garage.

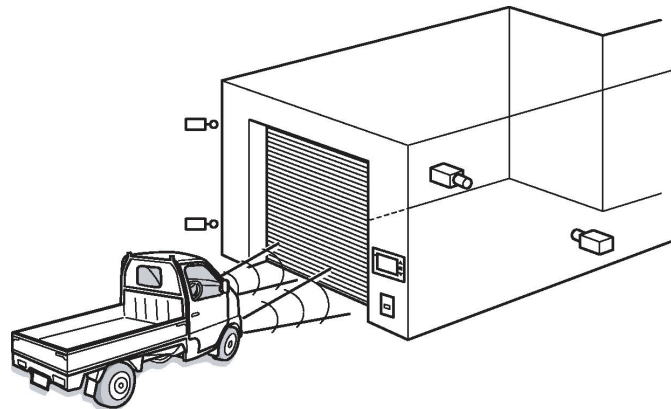

- The garage door opens when sensors detect headlight flashing three times per 10 seconds.

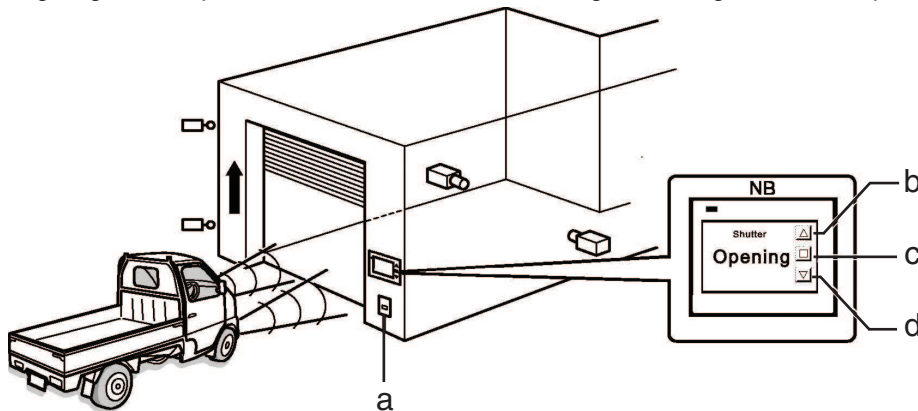

- |                |                |
|----------------|----------------|
| a Light sensor | b OPEN switch  |
| c STOP switch  | d CLOSE switch |

- The state of garage door is displayed on NB7W. The open, close or stop operations of garage door can also be controlled by related switches on display device.

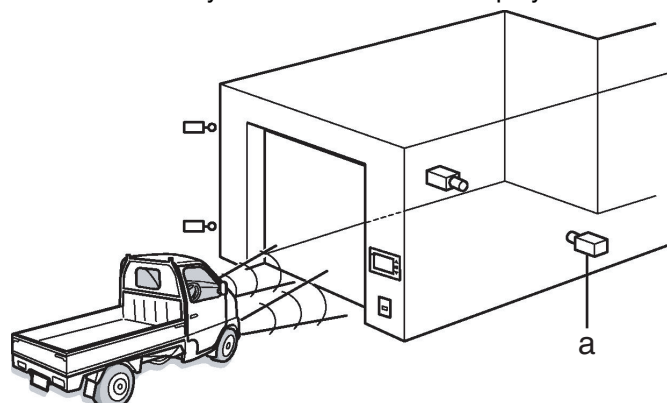

a Vehicle sensor

- The garage door will not be closed before the CLOSE switch is pressed or the vehicle sensor is ON after being fully opened.

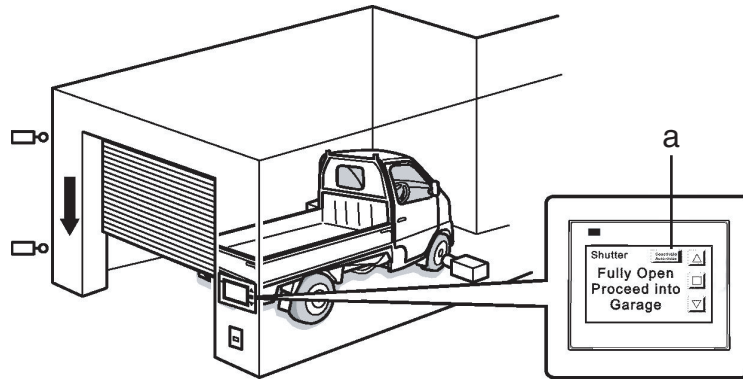

a [Deactivate Auto-close] button

- The garage door will be closed when the sensors detect that the entire vehicle is in the garage.
- If [Deactivate Auto-close] button is pressed, the garage door will not be closed even if the vehicle sensor is ON.
- Please control the garage door using related switches on the display device when the vehicle is being driven out of the garage.

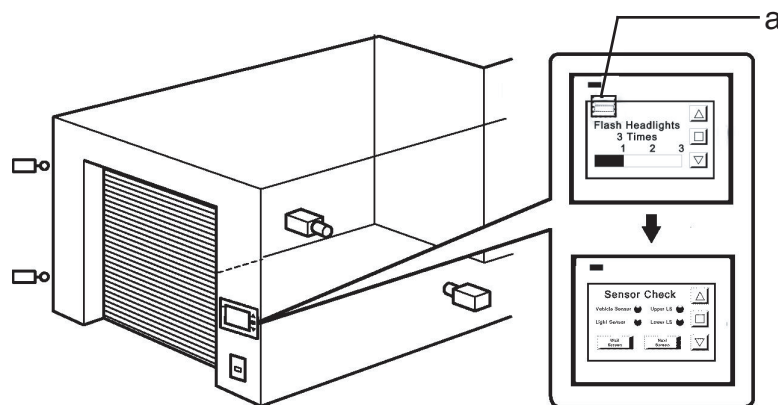

a Maintenance button

- NB7W will display maintenance screen for checking input devices when the maintenance button is pressed.

## ● System Components

The following components are used in the garage door control system:

### Display device

- NB7W-TW□□B
- XW2Z-200T(PT-PLC connecting cable: 2m)
- XW2Z-500T(PT-PLC connecting cable: 5m)

### PLC

- CP1E-N20D□-□ (20-dot I/O type)

### Programming device and software

- Personal computer
- USB cable (A-type connector(male) - B-type connector(female))
- NB-Designer (screen programming tool for NB series)
- CX-Programmer (PLC programming tool)

### Input

- OPEN / STOP / CLOSE switches;  
SW1 / SW2 / SW3 (Function Keys on the NB7W screen)
- Vehicle sensor: SEN1
- Light sensor: SEN2
- Limit switch, being ON when the garage door is fully opened: LS1
- Limit switch, being ON when the garage door is fully closed: LS2

### Output

- The contact for activating the motor controlling the door opening: M01
- The contact for activating the motor controlling the door closing: M02

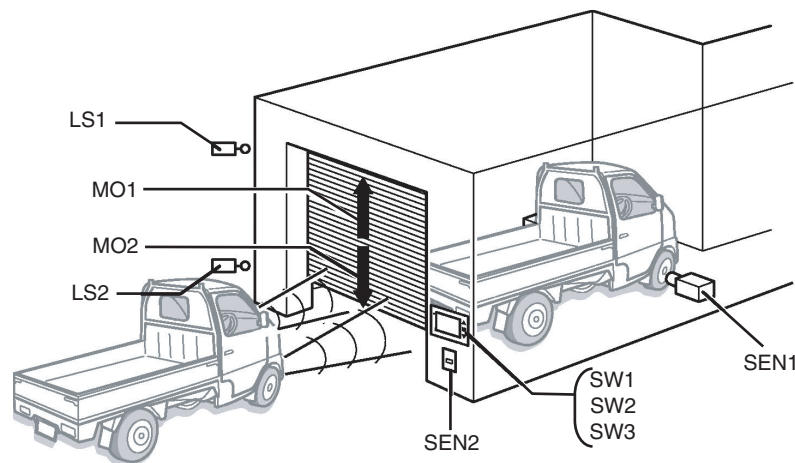

● CP1E

The CP1E is an economical PLC with high performance, which can be ideally used for small-scale manufacturing machines and control systems.

The CP1E-N20D□-□ is shown below:

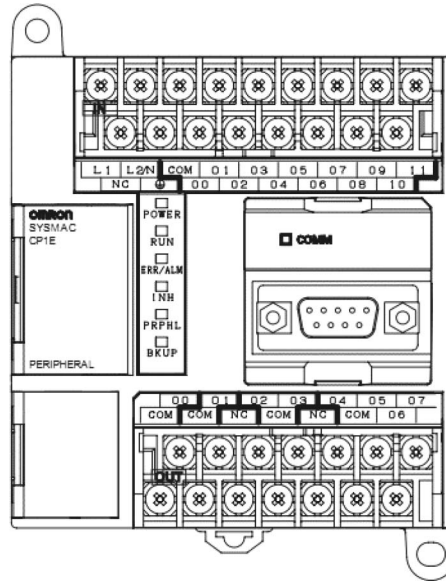

Please refer to the SYSMAC CP series CP1E CPU Unit User Manual for details on CP1E.



## ● Addresses allocation table

Memory allocation table

Addresses	Function	Component Name	Corresponding Screen
W_bit 0.01	Automatically close (disabled)	Bit Button	Fully Open
W_bit 0.02	Start the maintenance screen	Bit Button	Wait
W_bit 1.00	Open	Bit Button/ Bit Lamp	All Screens/Check 2
W_bit 1.01	Stop	Bit Button/ Bit Lamp	All Screens/Check 2
W_bit 1.02	Close	Bit Button/ Bit Lamp	All Screens/Check 2
LW.B 10.0	Texts on screen flash	Bit Lamp	Stop
C 0	Counter address	Level Meter, Number Display	Wait, Check 3
T 0	Timer address	Number Display	Check 3
D 0	Switch Screens	PLC Control	-
D 11	Output Screen No.	PLC Control	-
CIO_bit 0.03~0.06	(See the following table)	Bit Lamp	Check 1

The I/O relays of the PLC are allocated as follows.

Equipments	Contactors	Addresses
Vehicle sensor	SEN1	0.03
Light sensor	SEN2	0.04
Upper limit LS	LS1	0.05
Lower limit LS	LS2	0.06
Motor for opening control (Rise motor)	MO1	100.00
Motor for closing control (Down motor)	MO2	100.01

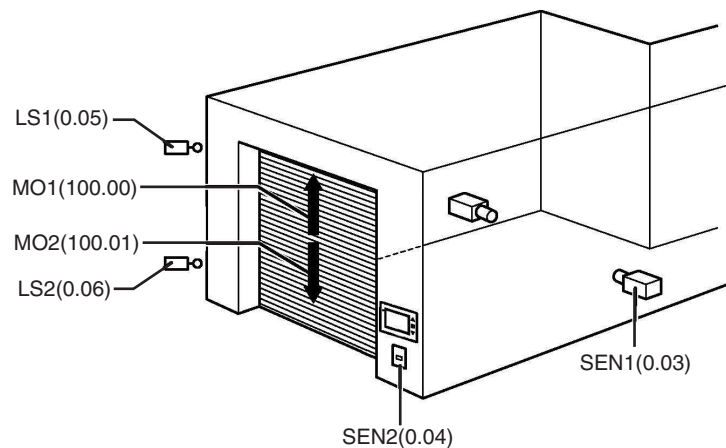

● **NB7W Screen**

The screens below will be displayed on NB7W.

(1) **WAIT**

The screen will be displayed when the garage door is fully closed. The number of flash of headlights is indicated in the form of Level Meter. The transparent button on the upper left corner is used for switching to the maintenance screen.

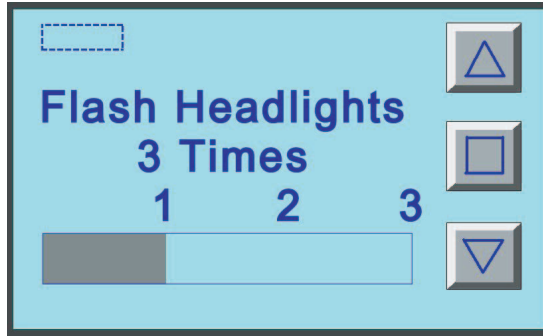

(2) **OPEN**

The screen will be displayed when the motor for opening control is activated.



(3) **CLOSE**

The screen will be displayed when the motor for closing control is activated.

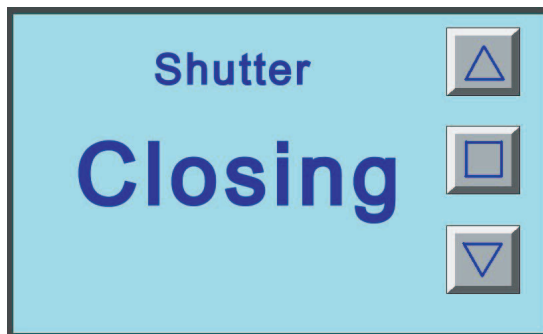

(4) **STOP**

The screen will be displayed when the STOP switch is pressed.



**(5) FULLY OPEN**

The screen will be displayed when the garage door is fully opened. There is a button for keeping the garage door open.

**(6) CHECK 1**

This screen is used for maintenance by displaying the input states of the sensors. The screen will be displayed when the maintenance button on [1 WAIT] screen is pressed.

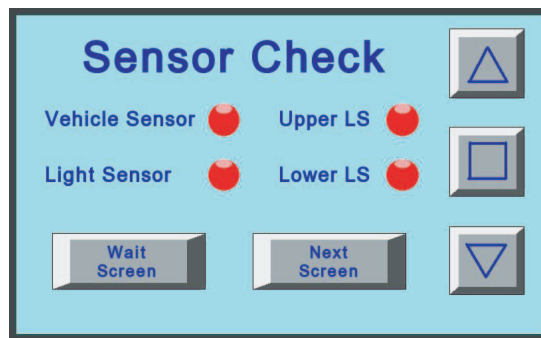
**(7) CHECK 2**

This maintenance screen can check the operation through displaying the input states of Function Keys.

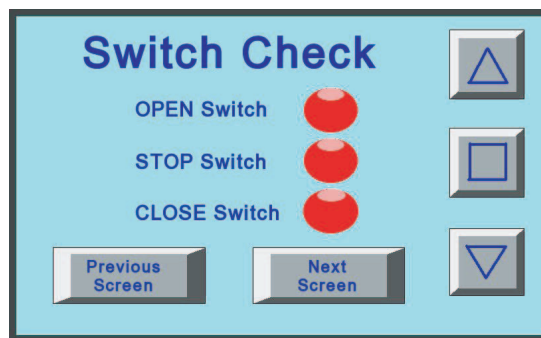
**(8) CHECK 3**

The current values of the timer and counter (used for counting flash times of headlights) are displayed on this screen which is used for maintenance.

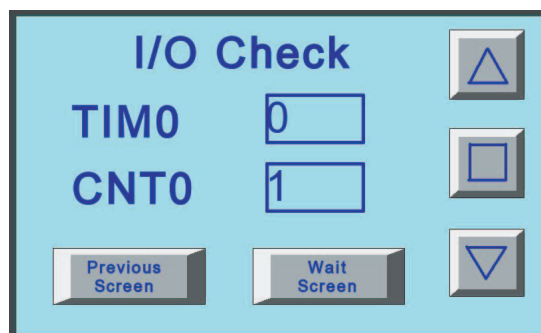

The screen switch flow chart is shown below.

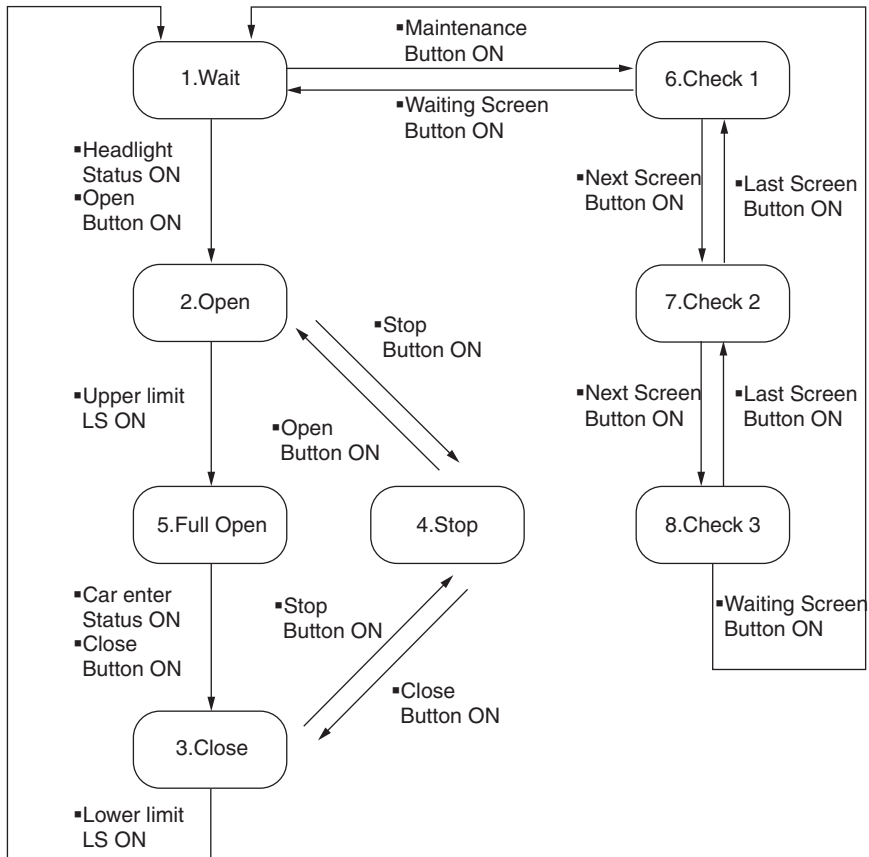

● Ladder programs

The ladder program examples are shown below.

Refer to the SYSMAC CP series CP1E Software Manual and SYSMAC CX-Programmer Operation Manual for details on creating ladder programs.

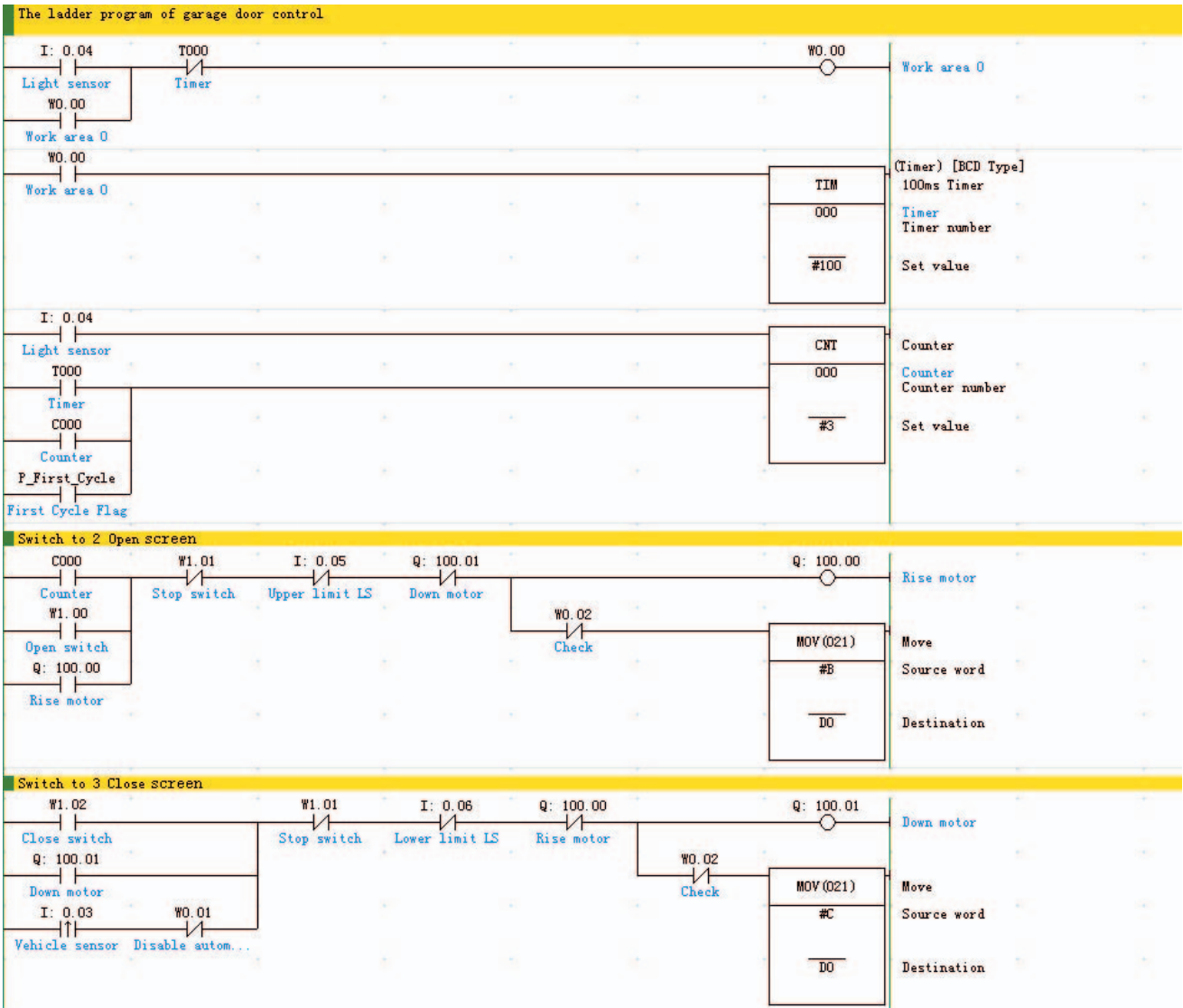

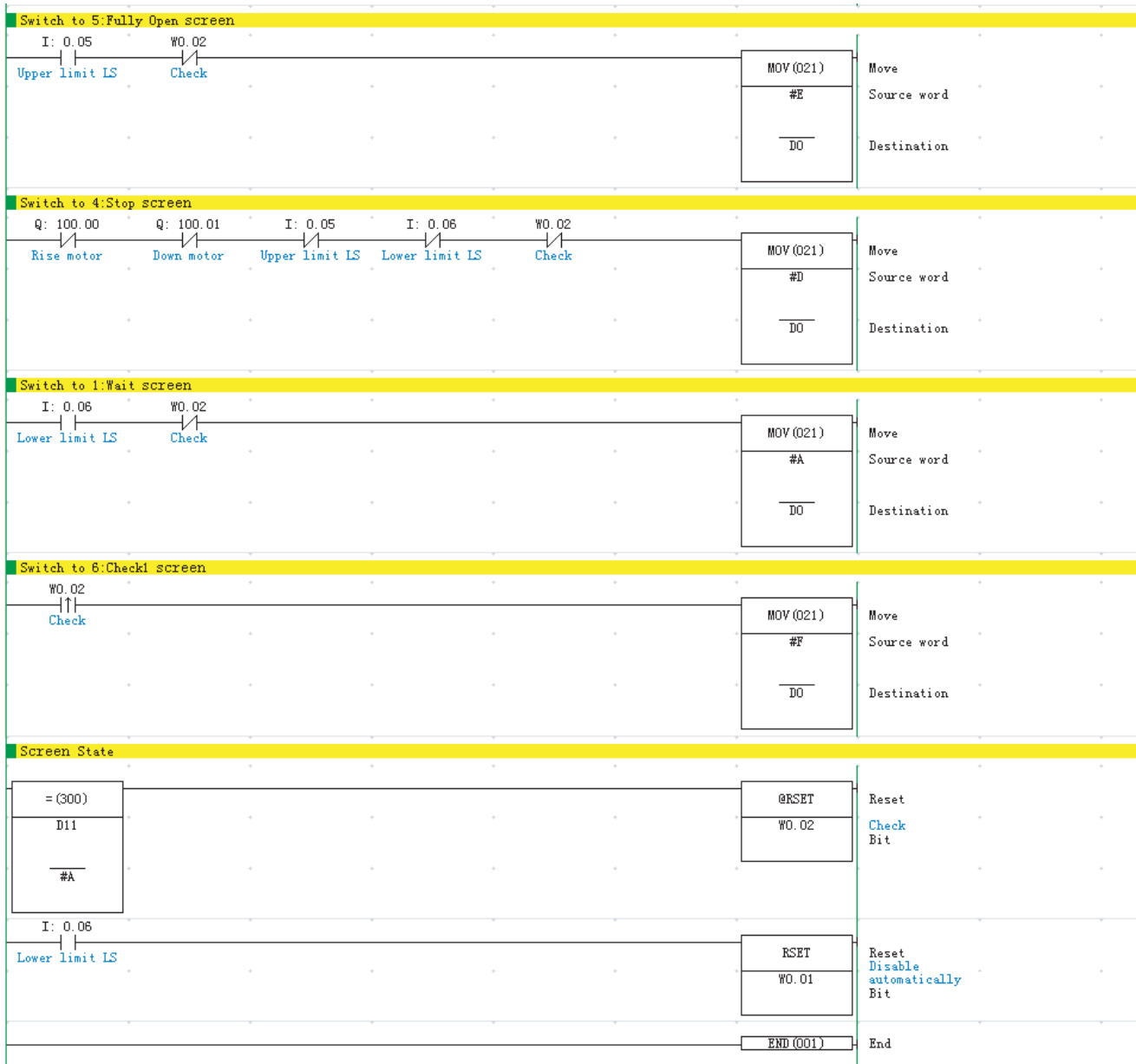

# 3

## Installation and Wiring

This section describes how to install and wire the NB Unit.

---

<b>3-1</b>	<b>Installation</b>	<b>3-2</b>
<b>3-2</b>	<b>Equipment Wiring</b>	<b>3-5</b>

## 3-1 Installation

This section describes the installation environment of the NB Unit and how to mount the NB Unit to the control panel.

When mounting the NB unit onto the operation panel, pay attention to the following precautions.

### WARNING

Always ensure that the personnel in charge confirm that installation, inspection, and maintenance were properly performed for the NB Unit.  
“Personnel In charge” refers to individuals qualified and responsible for ensuring safety during machine design, installation, operation, maintenance, and disposal.



Ensure that installation and post-installation checks are performed by personnel in charge who possess a thorough understanding of the machinery to be installed.



#### Precautions for Correct Use

- Do not install the Unit in any of the following locations:
  - Locations subject to rapid changes in temperature
  - Locations subject to temperatures or humidity outside the range specified in the specifications
  - Locations subject to condensation as the result of high humidity
  - Locations subject to corrosive or flammable gases
  - Locations subject to strong shock or vibration
  - Locations outdoors subject to direct wind and rain
  - Locations subject to strong ultraviolet light
  - Locations subject to dust
  - Locations subject to direct sunlight
  - Locations subject to splashing oil or chemicals
- Take appropriate and sufficient countermeasures when the product is used in the following locations:
  - Locations subject to static electricity or other forms of noise
  - Locations subject to strong electric field or magnetic field
  - Locations close to power supply lines
  - Locations subject to possible exposure to radioactivity



#### Precautions for Safe Use

When unpacking the NB Units and the peripheral devices, check carefully for any external scratches or other damages. Also, shake the Unit gently and check for any abnormal sound.



## ● Mounting NB Unit to Control Panel

Install the NB Unit by embedding it into the operation panel.

Use the panel mounting brackets and Phillips screwdriver installation.

Proceed the installation following the procedures below.

- 1 Panel cutout with dimensions is shown below. Fit the NB Unit into the panel from the front side.

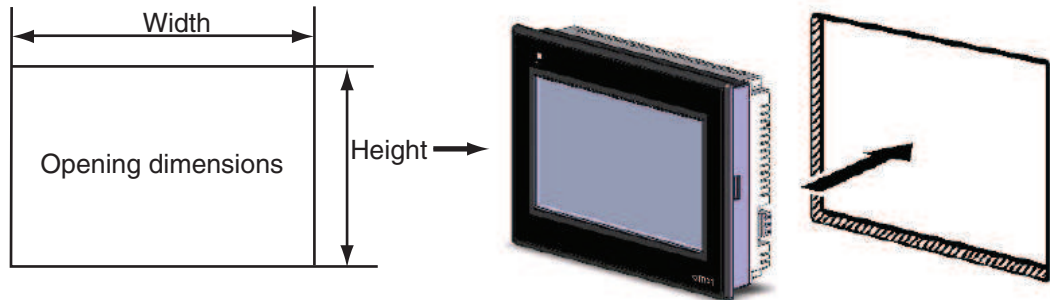

Models	Opening Dimension (W×H mm)
NB3Q-TW00B/TW01B	119.0(+0.5/-0)×93.0(+0.5/-0)
NB5Q-TW00B/TW01B	172.4(+0.5/-0)×131.0(+0.5/-0)
NB7W-TW00B/TW01B	191.0(+0.5/-0)×137.0(+0.5/-0)
NB10W-TW01B	258.0(+0.5/-0)×200.0(+0.5/-0)

- 2 As follows, insert the panel mounting brackets at the locations indicated by red box around the back of the NB Unit. Insert the hooks of positioners into the square holes on the Unit to hold the fixators properly, and tighten the screws firmly with the screwdriver.

## ● NB5Q/NB7W-TW□□B

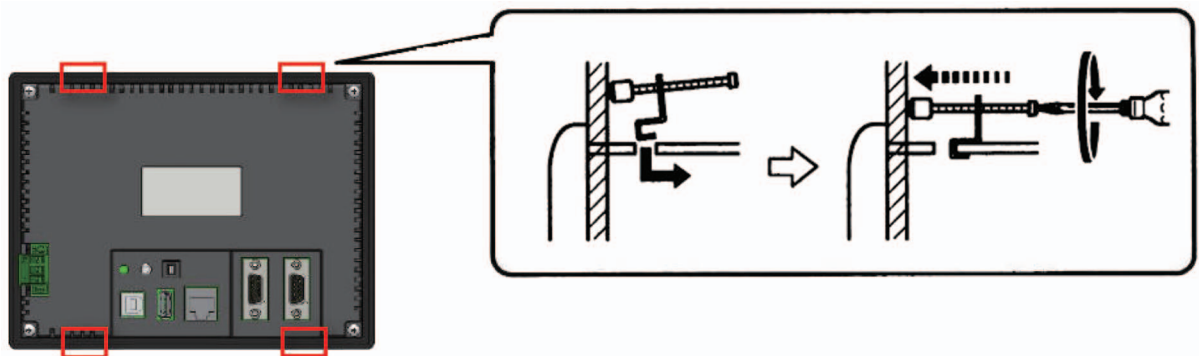

- The insert positions on the body of NB3Q-TW□□B/NB10W-TW01B (same fixing method as above)

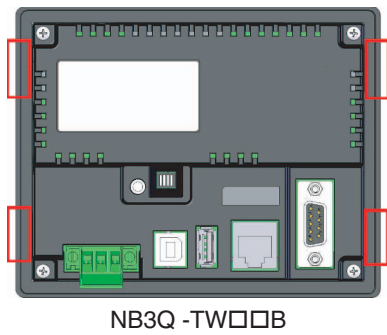

NB3Q -TW□□B

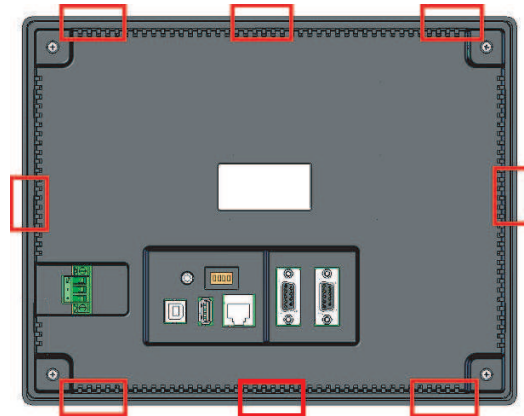

NB10W -TW□□B



**Precautions for Safe Use**

- Do not let metal particles enter the Units when preparing the panel.
- The mounting panel must be between 1.6 and 4.8 mm thick. Tighten the Mounting Brackets evenly to a torque of between 0.5 and 0.6 N·m to maintain water and dust resistance. If the appropriate torque is not used or the torque does not tighten the brackets evenly, the panel may be deformed. What is more, make sure the panel is not dirty or warped and that it is strong enough to hold the Units.

● **Display Mode of NB Series touch panel**

NB Series touch panel has 2 display modes: horizontal and vertical. The display mode can be selected when dragging a PT from the Project library Window into the Configuration and Setup Window.

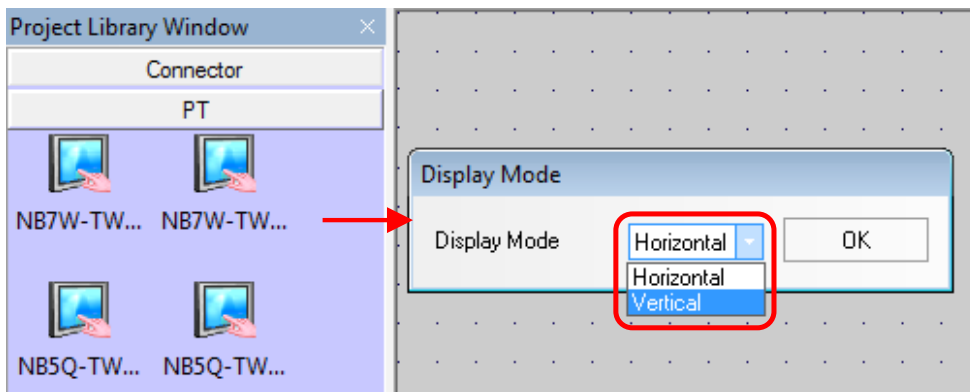

Horizontal display



Vertical display

## 3-2 Equipment Wiring

This section describes the wiring of the NB Unit and CP1E.

### Power Supply



#### Precautions for Safe Use

- Do not connect an AC power supply to the DC power terminals.
- Use a DC power with a slight voltage fluctuation and reinforced or double insulation, and that will provide a stable output even if the input is momentarily interrupted for 10 ms.  
Rated Power Supply Voltage: DC 24 V (Allowable range DC 20.4 ~ 27.6 V)

The connectable power supply specifications are as follows: figure out a suitable power supply specification so as to satisfy the requirement for power supply capacity.

Models	Rated Voltage	Allowable Voltage Range	Power
NB3Q-TW00B	DC24V	DC20.4V to 27.6V	5W
NB3Q-TW01B			9W
NB5Q-TW00B			6W
NB5Q-TW01B			10W
NB7W-TW00B			7W
NB7W-TW01B			11W
NB10W-TW01B			14W

#### ● NB5Q/NB7W/NB10W-TW□□B

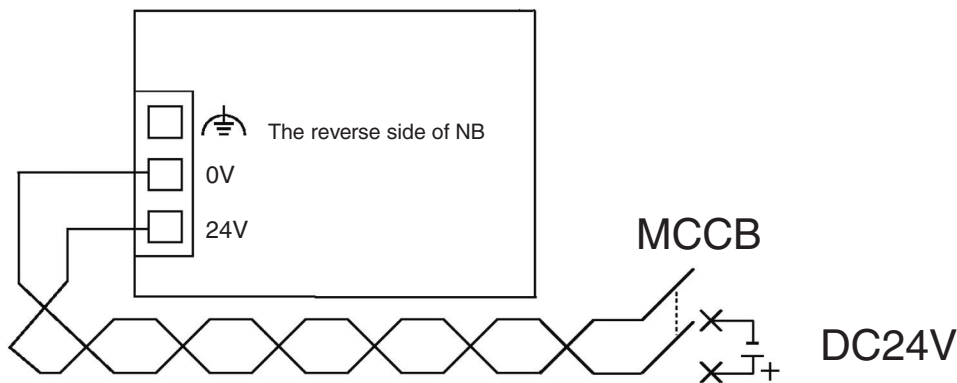

#### ● NB3Q -TW□□B

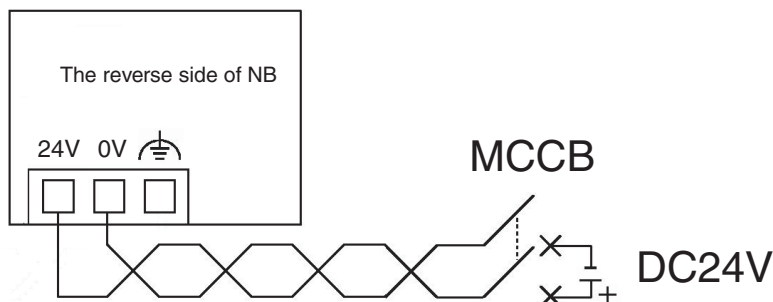



### Precautions for Safe Use

- Firstly, wire the twisted power line to the terminal block, then install the terminal block to the NB Units.  
Use power lines with AWG#12 to #26 thick, peel the coating 6.5 mm length, followed by tightening the screw with 0.3 to 0.5N torque. Make sure the screw of the terminal block is tightened firmly. Only NB3Q-TW□□B has a different pin arrangement of the terminal block. Do not make use of the terminal block of NB3Q-TW□□B for other equipments.

## Grounding

The NB unit has a functional earthing terminal (  ).

Arrange the wiring according to the following conditions.

- 1** When a potential difference occurs between the NB Unit and the host, arrange the earthing as illustrated. If the distance is too long to realize a single-point earthing, do not ground the earthing terminal of the NB Unit.
- 2** When the NB Unit, and noise source equipments such as motors and inverters, etc. are installed on the same panel, do not ground the earthing terminal of the NB unit.

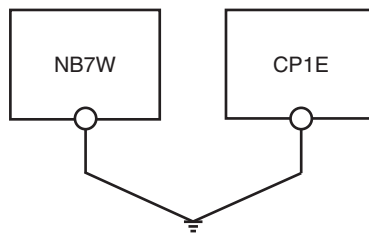

### Precautions for Safe Use

To prevent malfunctions caused by noise, ground the Unit correctly.

## CP1E Wiring

This section provides a brief of grounding wiring as an example.

Please refer to the SYSMAC CP series CP1E CPU Unit User Manual for details on CP1E.

### ● Power Connection and Grounding

Connect power and ground wires to terminal blocks.

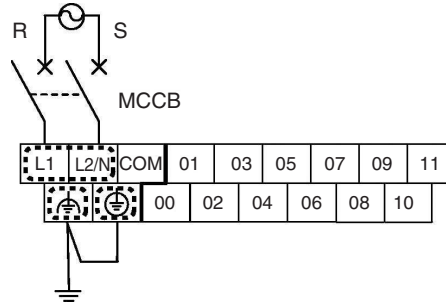

**Note** Tighten the AC power cable to the terminal block at a torque of between 0.3 and 0.5 N·m. Loose screws may occasionally result in fire or failure.

### ● Connecting I/O Devices

Connect I/O devices to the terminal block.

Input

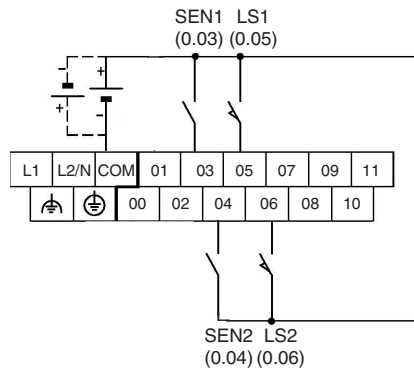

Output

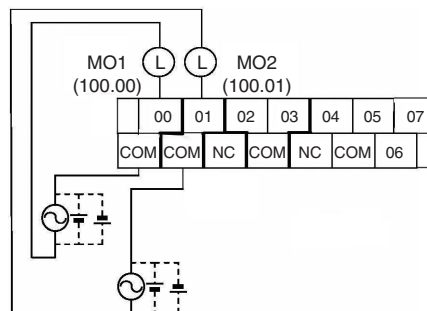

## Connecting NB Unit and CP1E

Execute One-to-one connection between the Host (PLC) and the NB Unit.

Connect CP1E and NB7W with a PT-PLC connecting cable (XW2Z-200T).

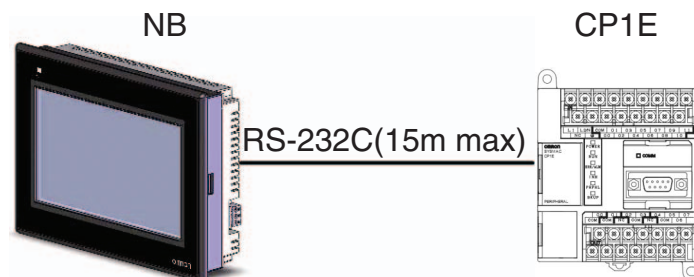

**Note** Please use OMRON PT-PLC connecting cable. Using other cables may result in failure.



### Precautions for Safe Use

- Always keep the connector screws firmly tightened after the communication cable is connected.
- The maximum tensile load for cables is 30 N. Do not apply loads greater than this.
- Always turn OFF the power supply before connecting or disconnecting cables.

# 4

## Screen Creation

This section describes how to create a demonstration project through NB-Designer.

---

<b>4-1 Starting NB-Designer .....</b>	<b>4-2</b>
<b>4-2 Main Window of NB-Designer .....</b>	<b>4-3</b>
<b>4-3 Creating Project .....</b>	<b>4-5</b>
<b>4-4 Screen Creation .....</b>	<b>4-13</b>
<b>4-5 PT Property .....</b>	<b>4-27</b>
<b>4-6 Save and Load Project .....</b>	<b>4-28</b>

## 4-1 Starting NB-Designer

This section describes how to start NB-Designer.

NB-Designer is a programming tool (software) for creating screens displayed on the PT of NB Series. Select [Program]-[OMRON]-[NB-Designer]-[NB-Designer] from the Windows Starting Menu to start NB-Designer.

The startup can also be realized by clicking the shortcut icon  on the desktop.

(Note: When using the NB-Designer on Windows Vista/7 operation systems, run the NB-Designer as an administrator.)

The main window will be displayed after starting NB-Designer completely.

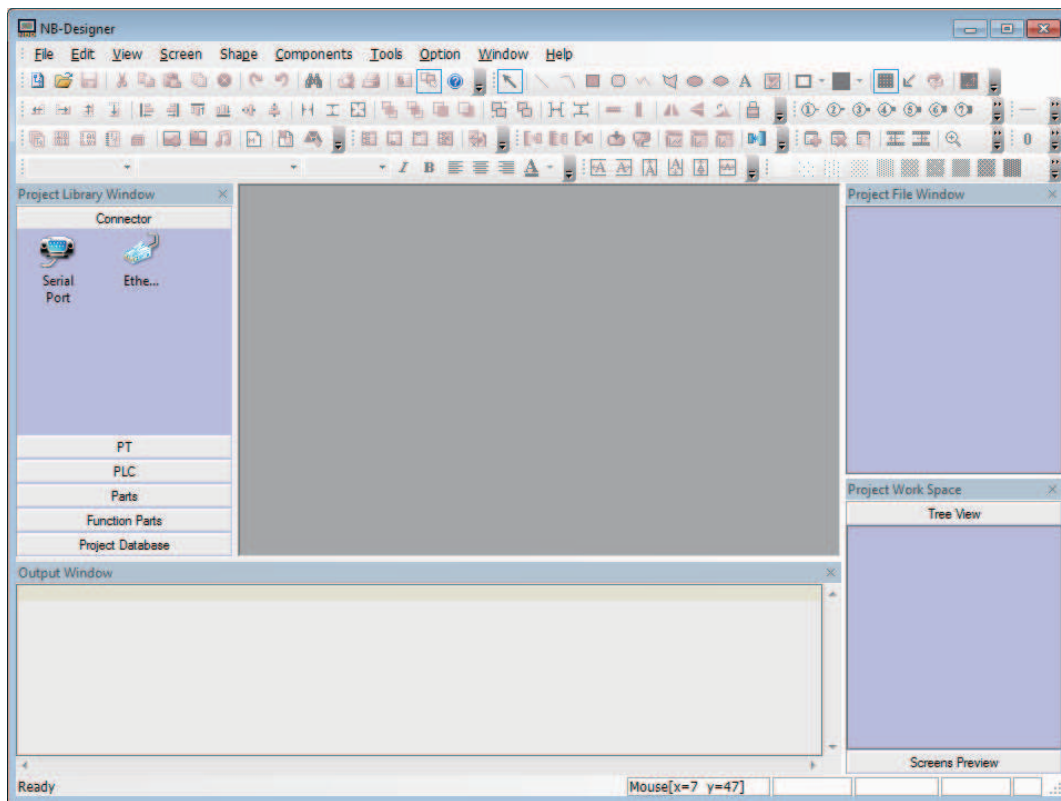

**Note** Please refer to the NB-Designer Operation Manual for details of NB-Designer, such as the operating environment, installation and operation.



## 4-2 Main Window of NB-Designer

This section describes the functions of each part of the main window of NB-Designer.

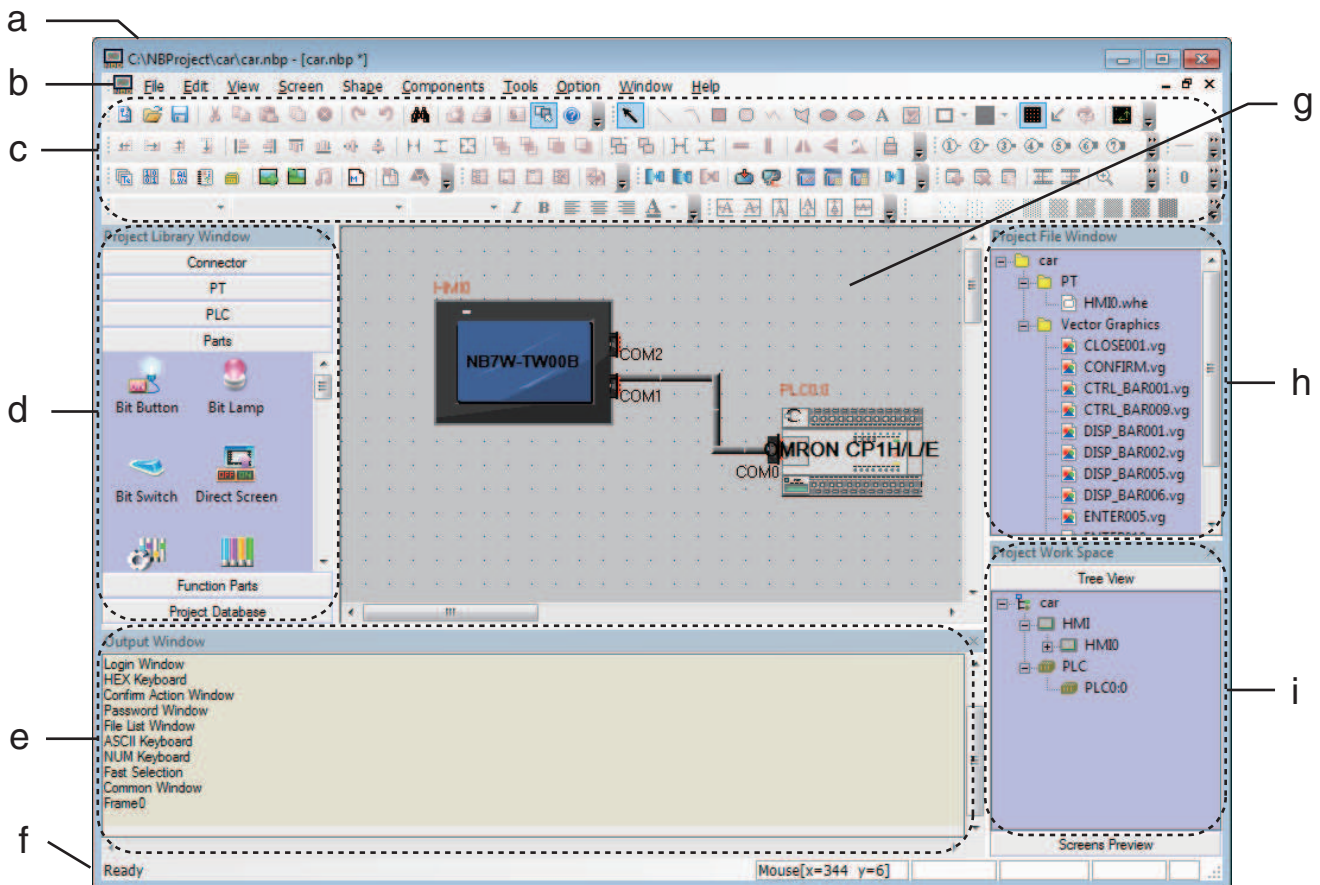

- (a) Title Bar  
Indicating the names of applications.
- (b) Menu Bar  
Classifying the functions of NB-Designer in groups. Grouping functions are indicated in the form of pull-down menu.
- (c) Toolbar  
Displaying icons for common functions. The function names will be indicated when the cursor is put on related icons. In the tool-bar, sub-tool bar includes basic functions is displayed.
- (d) Project Library Window  
The Project Library Window contains: Communication Connection, PT, PLC, Parts, Function Parts and Project Database.
- (e) Output Window  
Displaying the compilation process of a project and providing compilation error information.
- (f) Status Bar  
Displaying information such as the current cursor position, the width/height of the target object and the editing state, etc.
- (g) Edit Window  
The window is used for designing images and setting the communication method between the PT and PLC.

(h) Project File Window

The Window adopts a tree structure to show the correlations between the project-related touch panel and macro files & BMP files.

(i) Project Work Space

The Window displays a tree structure to show configuration of whole the project such as the PLC, the PT, and the screens.

## 4-3 Creating Project

This section describes the procedures to set parameters and create a project effectively for NB7W-TW00B by way of example. The date created through NB-Designer are regarded as “Project”.

### Creating New Project

Project creation should be started with setting the configuration plan when using NB-Designer the first time.

- 1 Select [File]-[New] from the main menu. The [New Project] dialogue border will pop up.

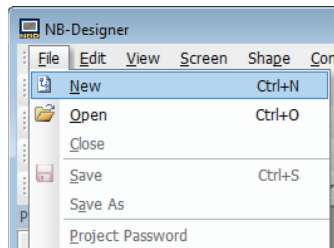

- 2 Select [NB7W-TW00B] from [PT] Project Library, drag PT to the edit window after selecting it with a single-click.

Select “horizontal” for PT display Mode.

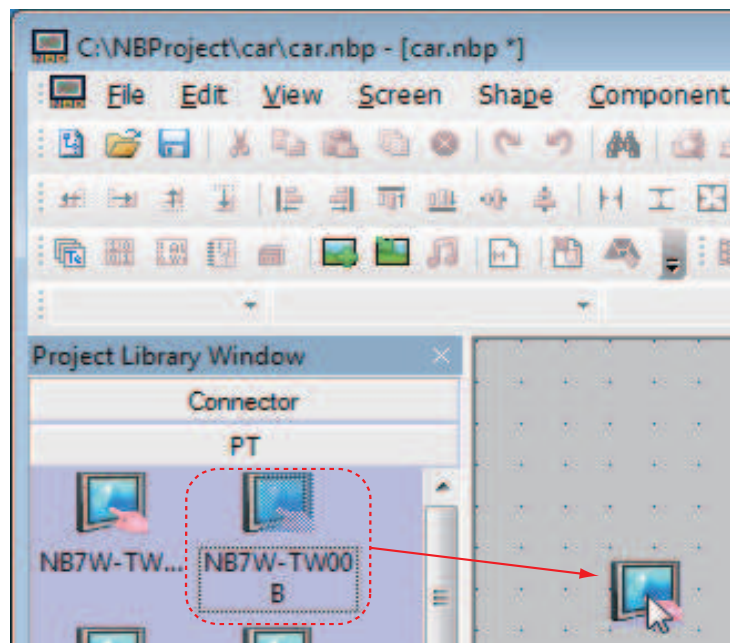

**Note** Even when the other model is used, the project can be created by the same operations.

- 3** Select [OMRON CP1H/L/E] from [PLC] Project Library, drag PLC to the Configuration and Setup Window after selecting it with a single-click.

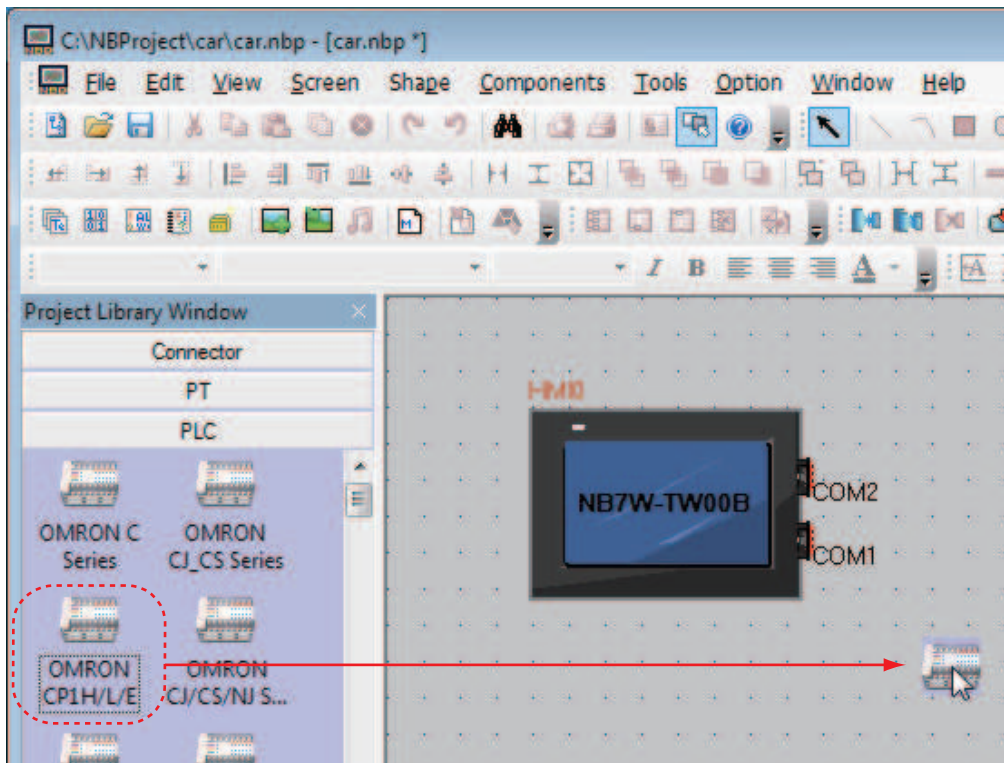

- 4** Select [Serial Port] from [Connector], drag it to the Configuration and Setup Window after selecting it with a single-click.

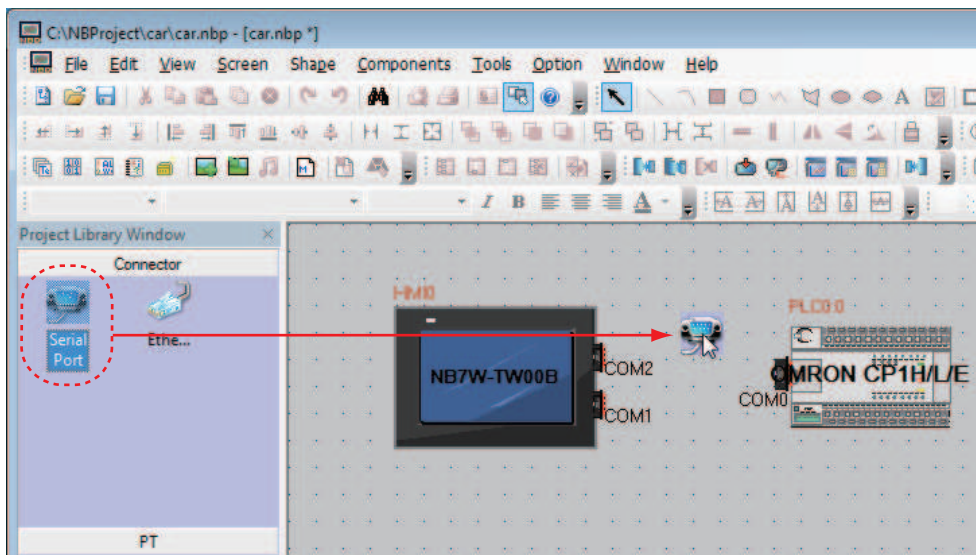

- 5** Adjust the positions of PT and PLC on the Configuration and Setup Window to connect serial communication cables to COM1 of HMI and COM0 of PLC.

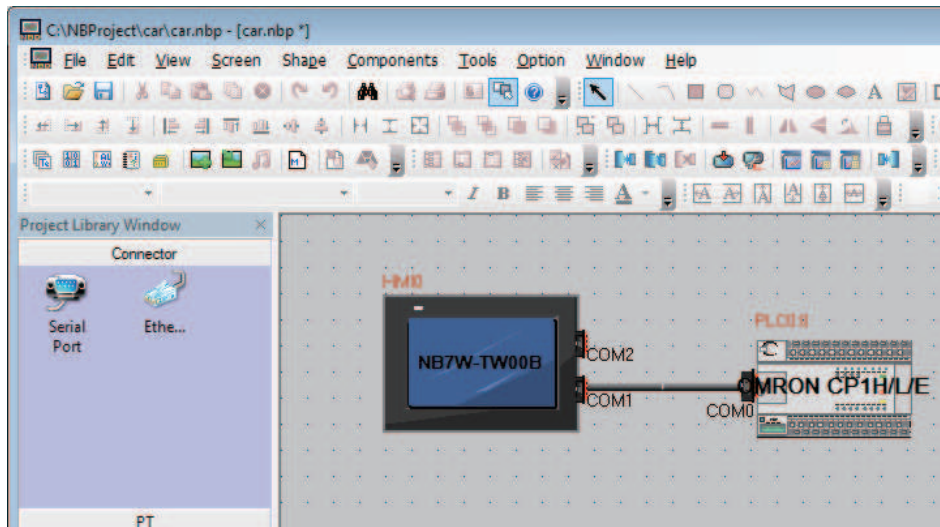

## Communication Setting

- 1** Click the project name on the Project Work Space Window and the connecting diagram of PT and PLC appears. Then double-click the PT and “PT Property” window pops up, select “COM1 Setting” page and set the communication mode to “RS232, 115200, 7, Even Parity Check, 2”. Click OK button and the settings of the communication mode of PT COM1 are completed.

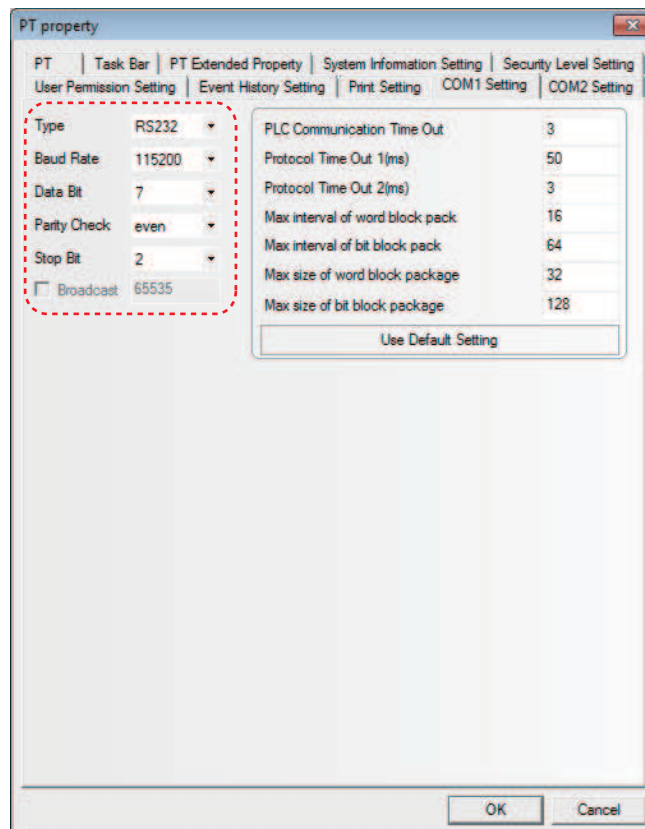

- 2** To setting the PLC: In “CX-Programmer” open the project, in project workspace select [PLC Settings]. Be sure to set the communication mode of PLC [Built-in RS232C Port] to “Mode: Host Link, Baud: 115200, Format: 7,2,E”.

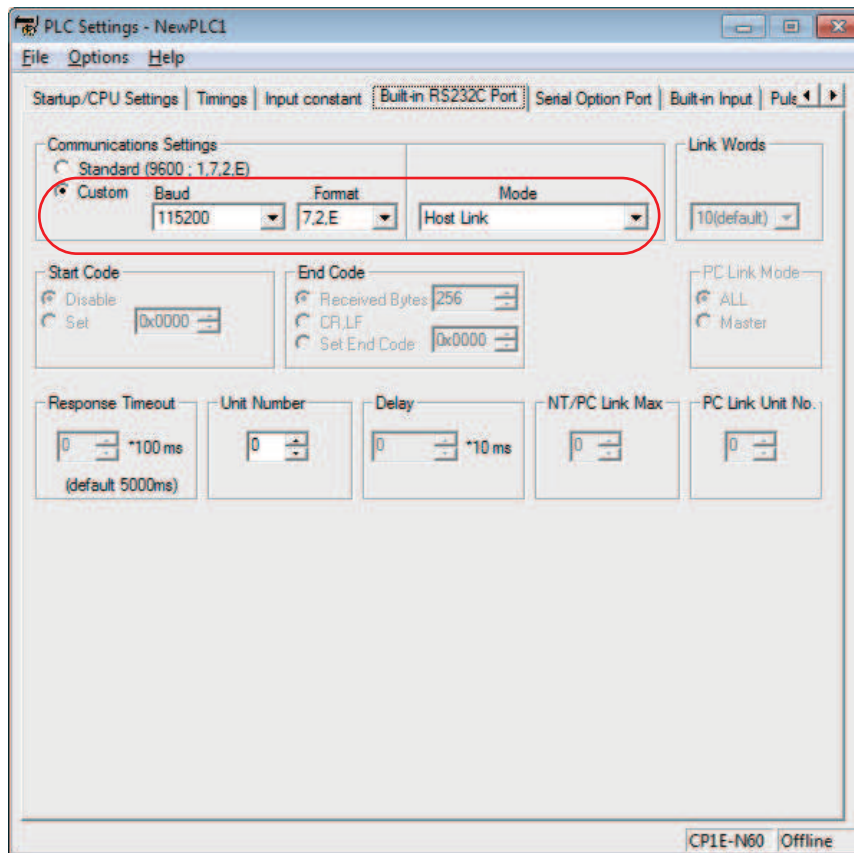

## Creating Macro

This project uses Macro files to initialize the value of LW.B 10.0 to 1, thus initializing the Bit Lamp on the [Stop] screen.

- 1** User could establish a macro file with the icon  through the menus or toolbar.

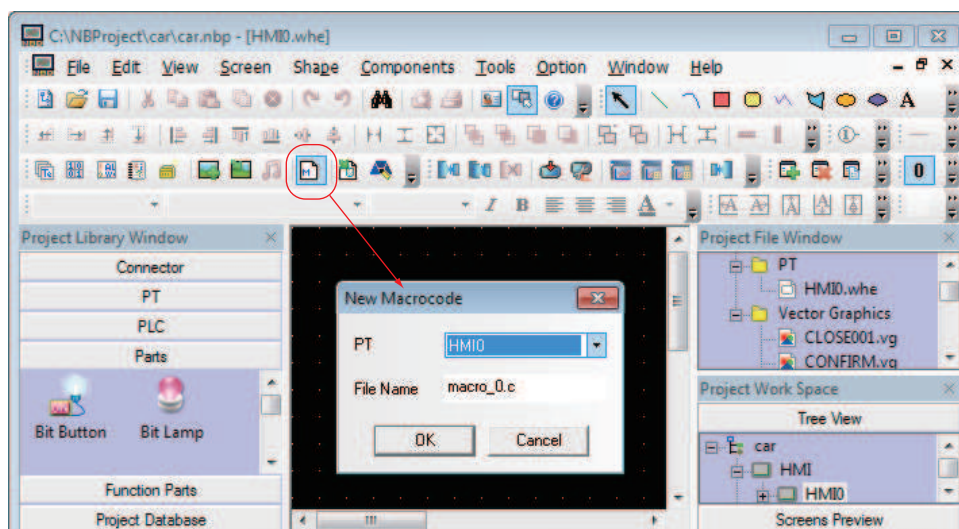

- 2** Then a macro code edit window will appear, use single right click in the “Macro Variable Table” window, select “Add Variable”, a “Macro Variable” window will open, user can define variable parameter with it.

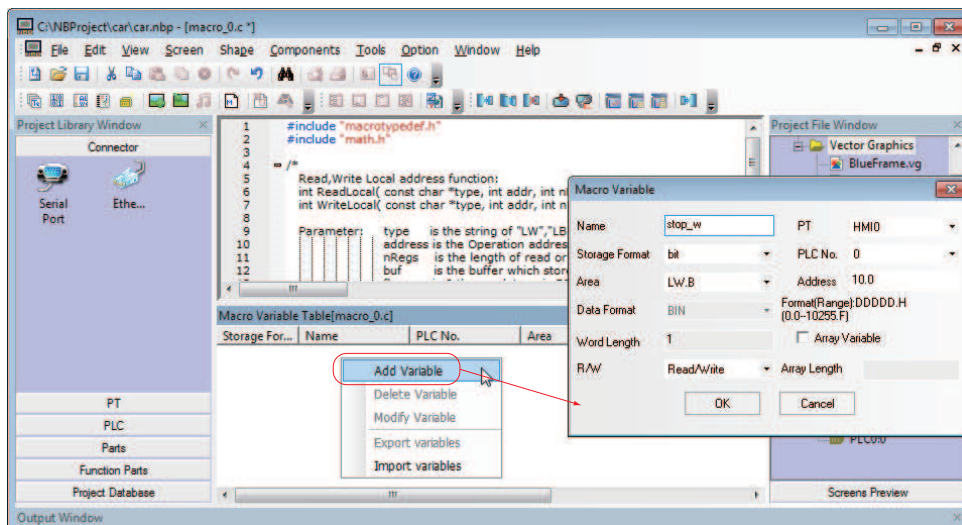

- 3** After click “OK” there is a new variable added in the “Macro Variable Table” window, it can be used in macro program as a defined variable.

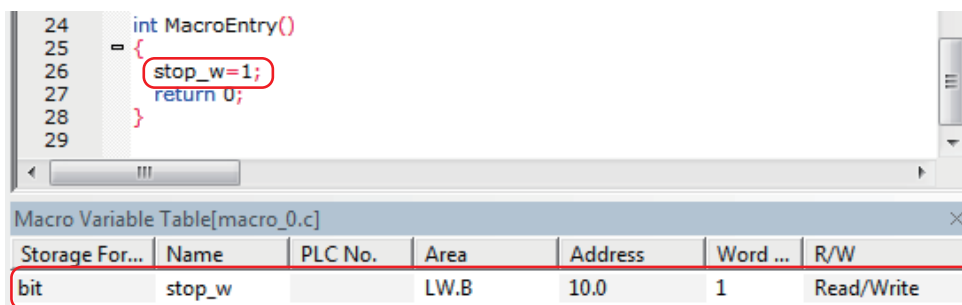

Refer to the *NB Series NB-Designer Operation Manual(V106)* for the detail.

## Creating Vector Graphics

With powerful vector graphics and bitmap libraries function in NB-Designer, users can create any graphics such as switches, lights or tubes at will. Each vector graphic or bitmap contains 256 statuses at max. Users can make the vector graphics in the system as templates, copy them into the new created vector graphics, and then add lines, boxes, words etc. for them to generate the new vector graphics.

- 1** Select [Draw]-[Add Graphics] from the main menu. The [New Graphics] window will appear.

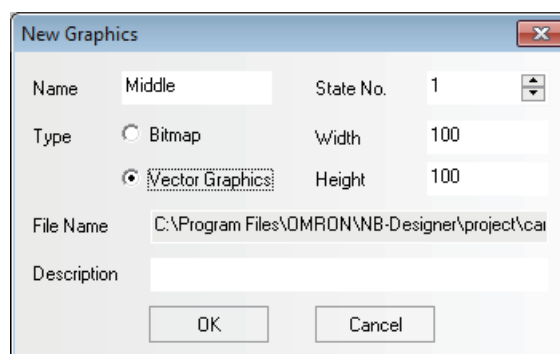

- 2 After create a new graphics, double click to select “CTRL\_BAR001.vg” in the Project File Window, select “state0” and right single click graph below and select “Copy”.

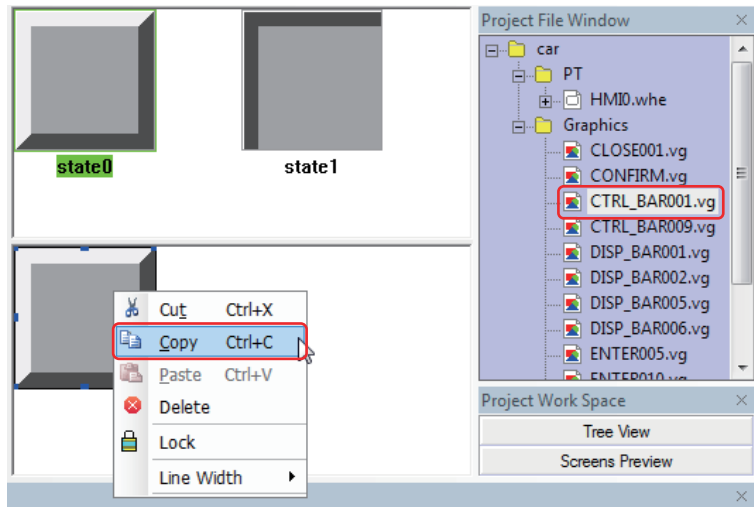

- 3 Then select “Middle.vg” graphics, and copy the graphics to be copied into it. Copy the “state1” into the graphics by the same method, and then select “Rectangle” in the toolbar to draw it into the graphics.

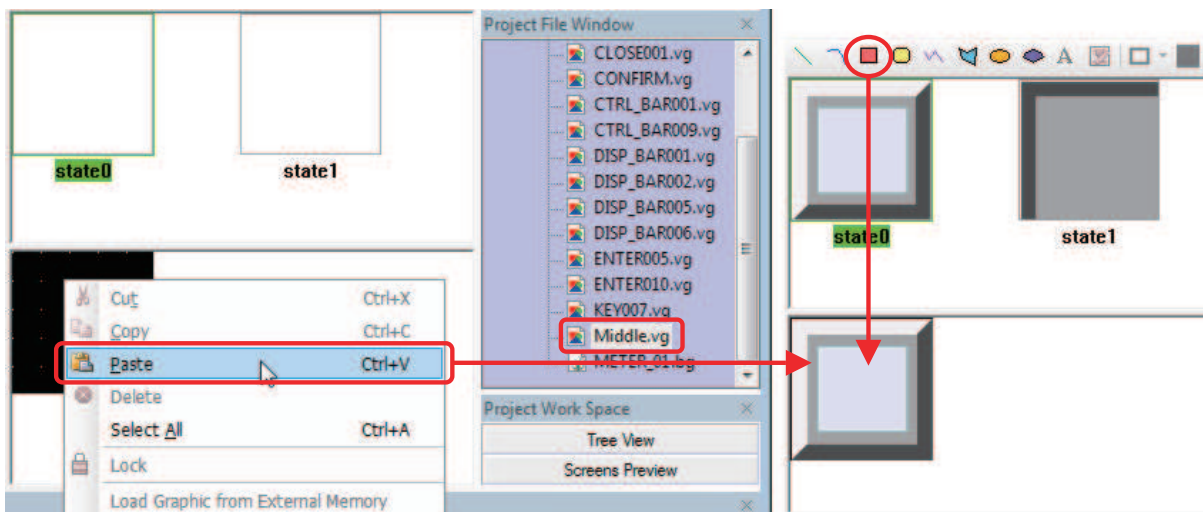



- 4** Then make the settings in the “Shape property” dialog box to the Shape Property, as shown below:

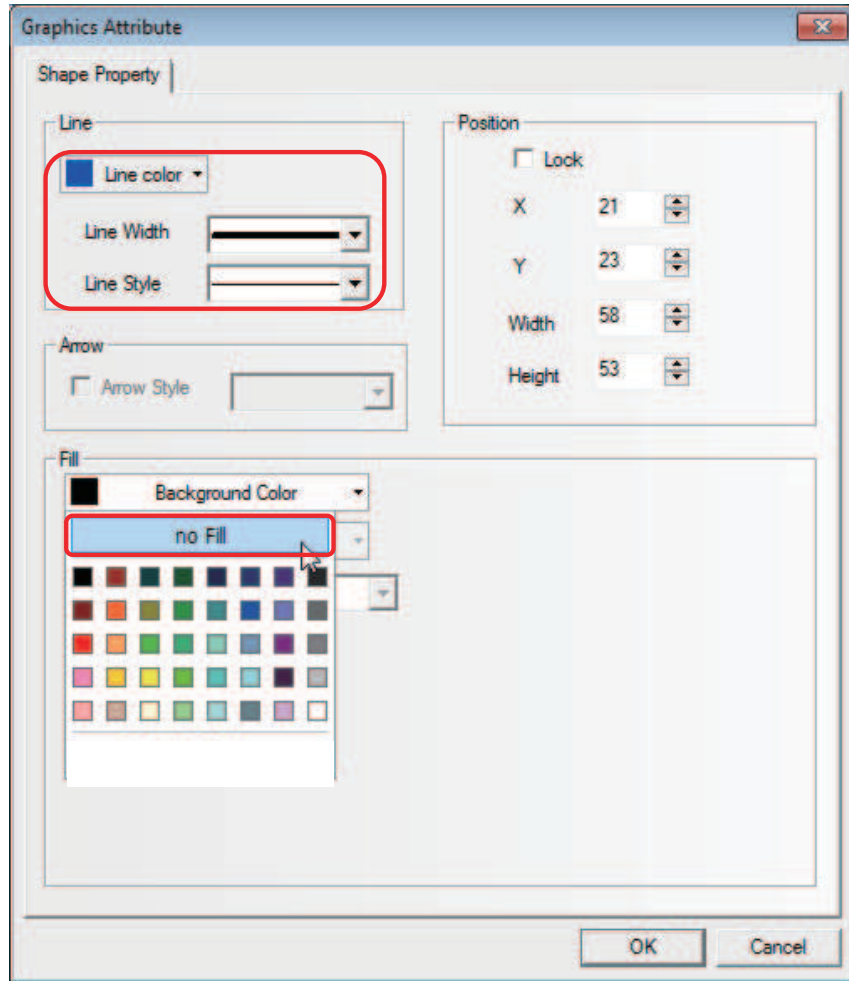

**Note** Please save the project after the completing the creation of vector graphics.

- 5** Please create the vector graphics “Up.vg” (an upward hollow triangle) and “Down.vg” (a downward hollow triangle) referring to the above-mentioned method.

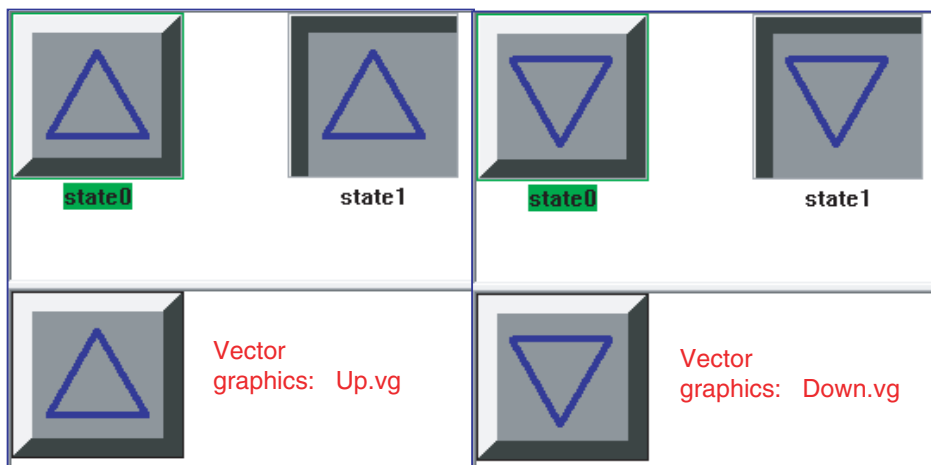

- 6** Create a vector graphics “Dashed.vg”: first add a light cyan rectangle into the graphics, and then make the related settings in the “Shape property” dialog box, as shown below:

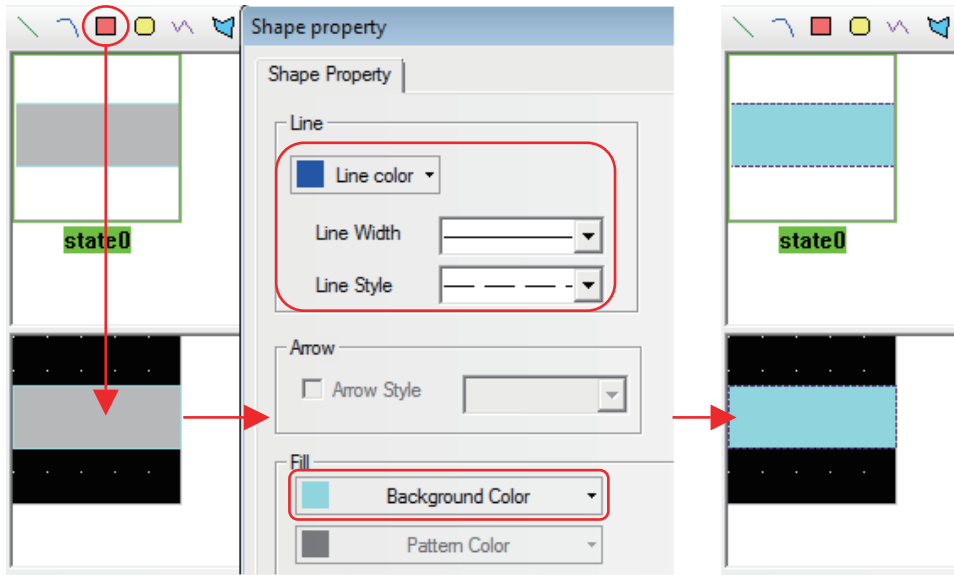

- 7** Create a vector graphics “BlueFrame.vg”: first add a blue hollow rectangle into the graphics, and then make the related settings in the “Shape property” dialog box, as shown below:

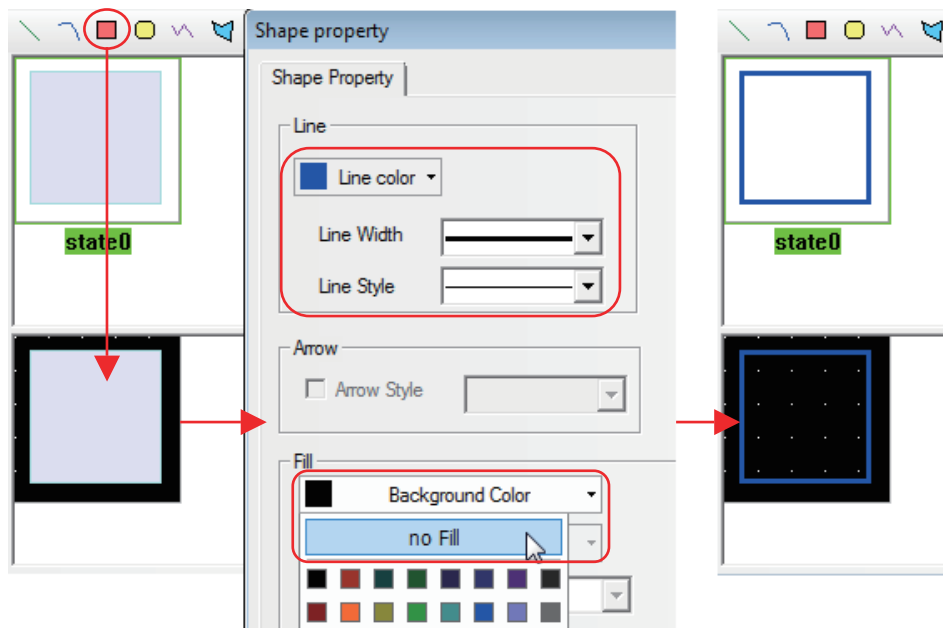

## 4-4 Screen Creation

This part describes how to create screens displayed on NB7W.

### [1 Wait]

[1 Wait] is the first display screen in the garage door control system. The screen will be displayed with the lower limit LS ON.

Configure functions below:

- Level Meter component, indicating numbers of headlights flashing detected by the sensors in forms of graphics.
- Bit Button components, allocated to [Open], [Stop] and [Close] garage door operations respectively.
- Bit Button component, for accessing the maintenance screen. The component turns ON when the button is pressed for 3 seconds.

The whole screen is shown below. The following objects must be created and configured:

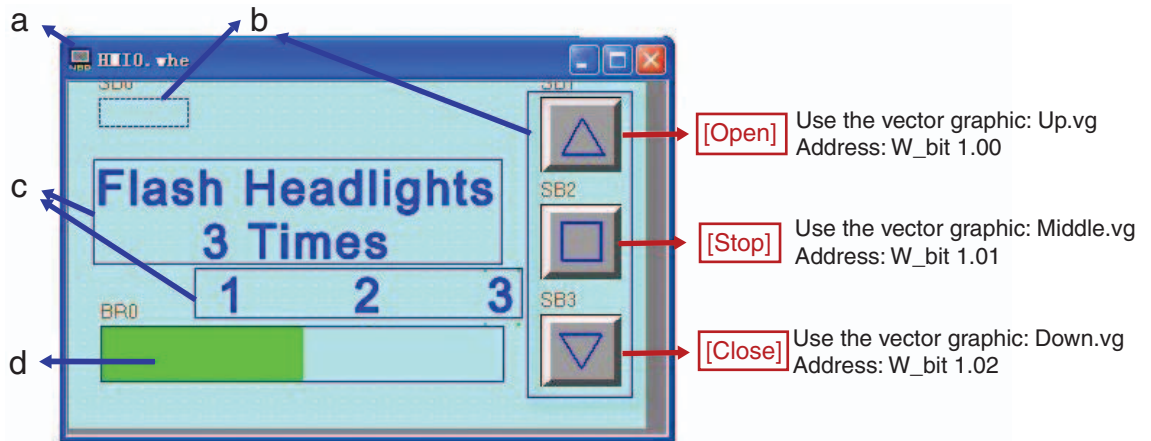

a Screen   b Bit Button components   c Texts   d Level Meter component

### ● Screen

Start the following procedures after the NB7W operation is set.

- 1 Select [Add Screen]  from the toolbar. Input "Wait" at the screen name area.

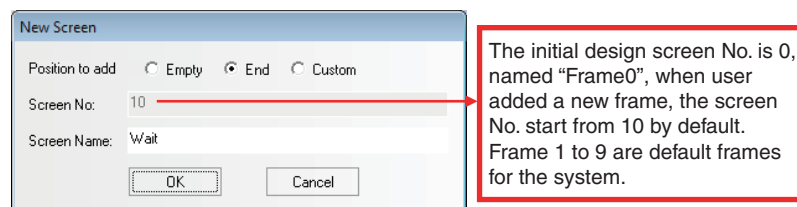

User should use this method to create total 8 screens for this project, the screen No. and names are listed as below:

Screen No	Screen Name
10	Wait
11	Open
12	Close
13	Stop
14	Fully Open
15	Check1
16	Check2
17	Check3

- 2 Double-click “Wait” Screen to open [Screen Property], select “Background Color” and set “Background Color” to “lightCyan”.

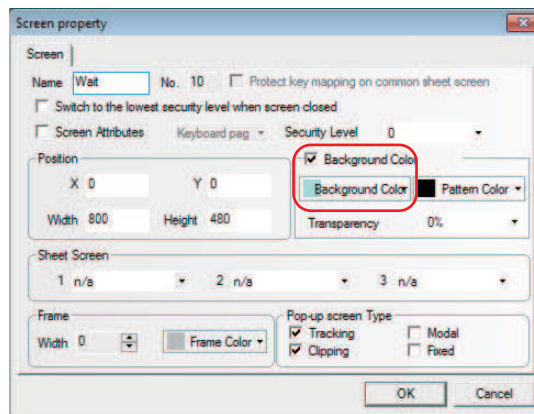

● **Bit Button Component**

- 1 Bit Button component for switching to the maintenance screen

The Bit Button component is placed on the upper left corner of the screen. Pressing this hiding button (Bit Button component) to switch to maintenance screen ([6 Check 1] screen).

Function: Pressing the button and turn ON W\_bit0.02, the display of PT will be switched to [6. check 1] by the ladder program of CP1E. The Function Key is set transparent and will not function until being pressed for 3 seconds for the purpose of avoiding being pressed accidentally.

Select [Bit Button component] from [Parts], drag it to the edit window after selecting it with a single-click.

The property settings are:

Write Address	W_bit0.02
Bit Button Types	On
Graphics	Use the vector graphic: Dashed.vg (A vector graphic created by user, which is a light cyan rectangle)
Control Setting (Security Setting)	ON Delay 3s

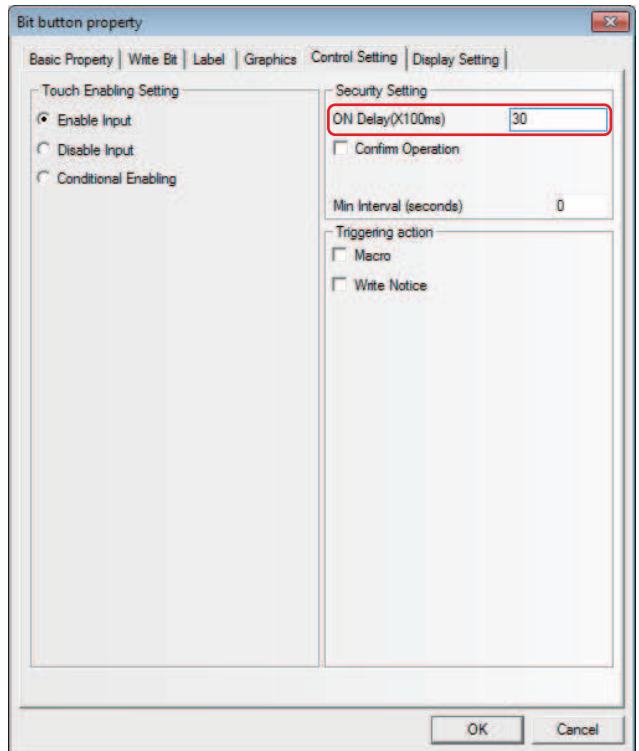
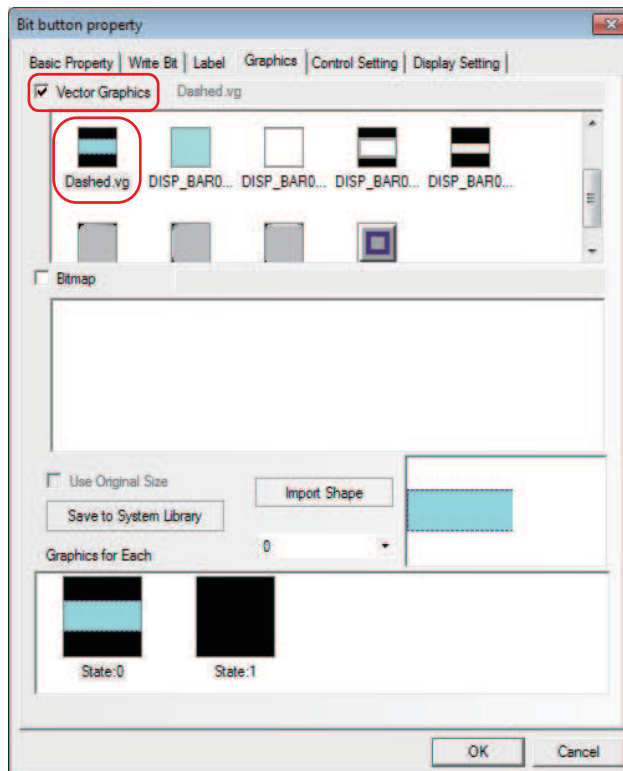
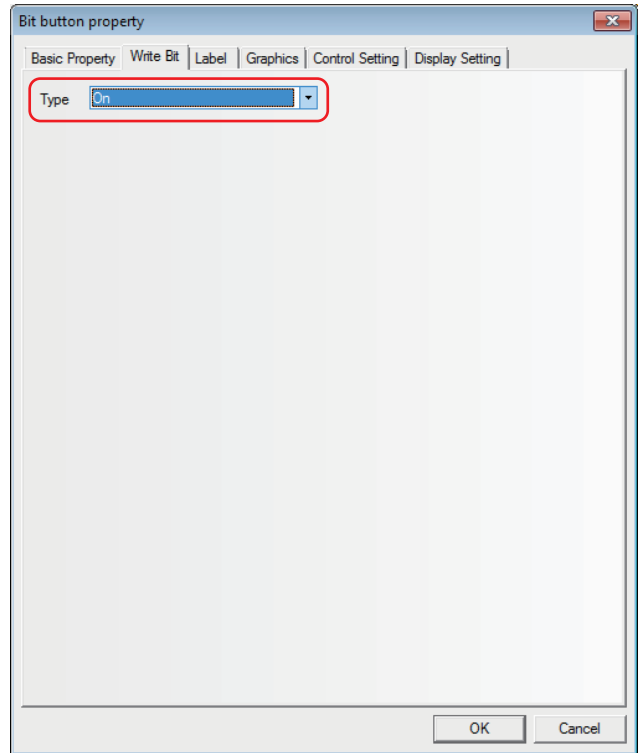
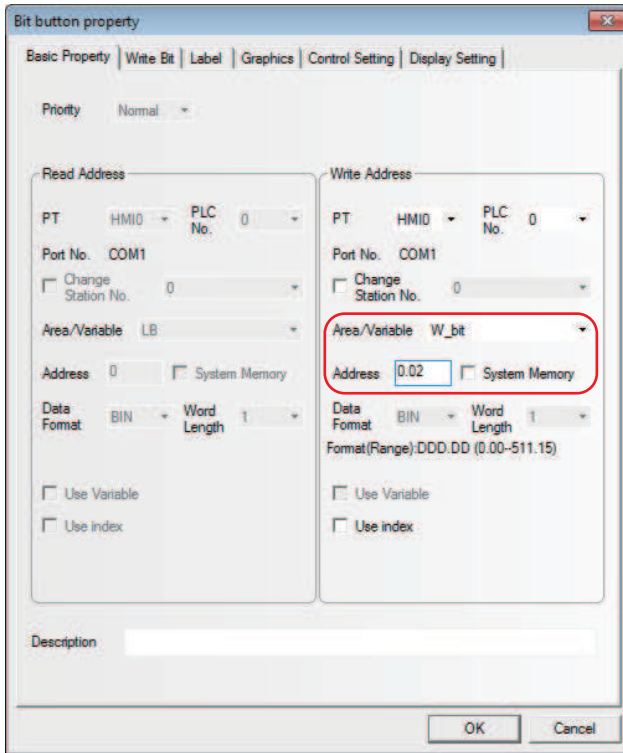

## 2 Bit Button component for Open/Stop/Close

Function: After the component is pressed, the bits set as write address is set to ON, and then is reset. The write addresses for each component is shown in the table below.

The property settings are:

Component Name	Open	Stop	Close
Write Address	W_bit 1.00	W_bit 1.01	W_bit 1.02
Bit Button Type	Reset switch		
Graphics	Use the vector graphic: Up.vg (A vector graphic created by user, which is an upward arrow)	Use the vector graphic: Middle.vg (A vector graphic created by user, which is a square)	Use the vector graphic: Down.vg (A vector graphic created by user, which is a downward arrow)

### ● Fixed Text

Select the “Text” button on the draw toolbar and set the property of fixed text.

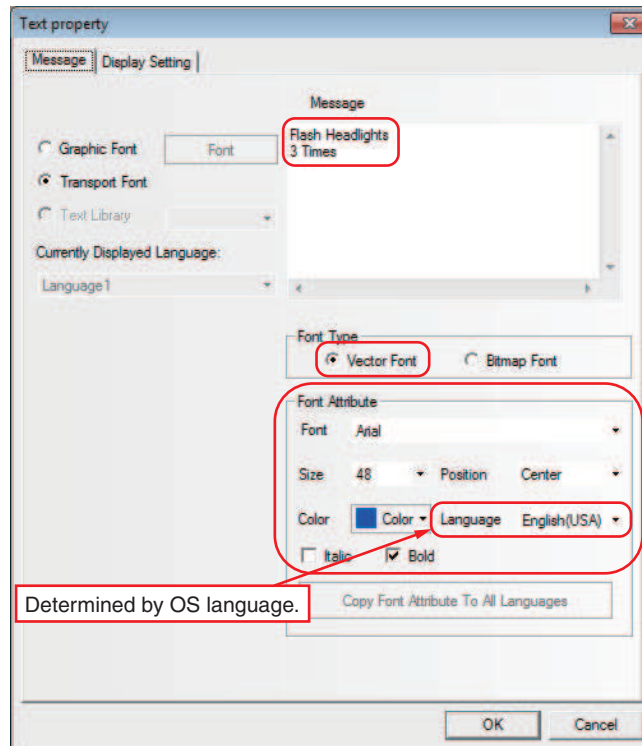

### ● Level Meter Component

The function of the Level Meter Component is to indicate numbers of flash of headlights detected. The times of flash are related to the current value of the ladder program counter. Up to 3 times of flash can be counted when the maximum value of the Level Meter is set to “3”. Put fixed texts [1], [2] and [3] above the Level Meter as the scale to indicate times of flash.

Select [Level Meter] from [Parts], drag it to the edit window after selecting it with a single-click.

The attribute settings are:

Read Address	C 0
Bar Type	Standard
Display Direction	Left
Bar Shape	Rectangle
Frame Color	Blue
Pattern Color	Light grey
Normal Color	Light cyan
Alarm Under Min Color	Light cyan
Min. / Max. Value	0/3
Alarm Under Value	0

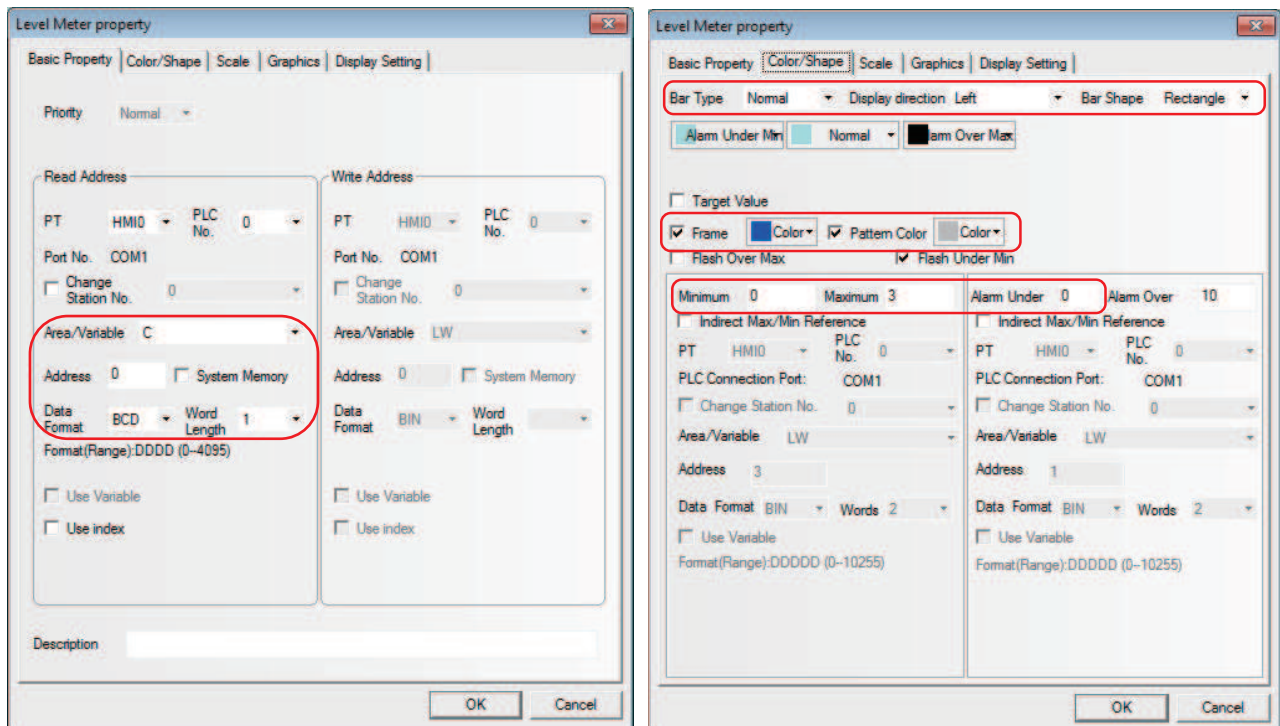

## [2 Open]

The [2 Open] screen will be displayed when the motor for garage door opening control is activated.

Configure functions below:

- Fixed text indicating the garage door state.
- Bit Button components, allocated to [Open], [Stop] and [Close] garage door operations respectively.

The whole screen is shown below. The creating method is the same as that of [1 Wait].



a Screen b Fixed Text c Bit Button components

### [3 Close]

The [3 Close] screen will be displayed when the motor for garage door closing control is activated.

Configure functions below:

- Fixed text indicating the garage door state.
- Bit Button components, allocated to [Open], [Stop] and [Close] garage door operations respectively.

The whole screen is shown below. The creating method is the same as that of [1 Wait].

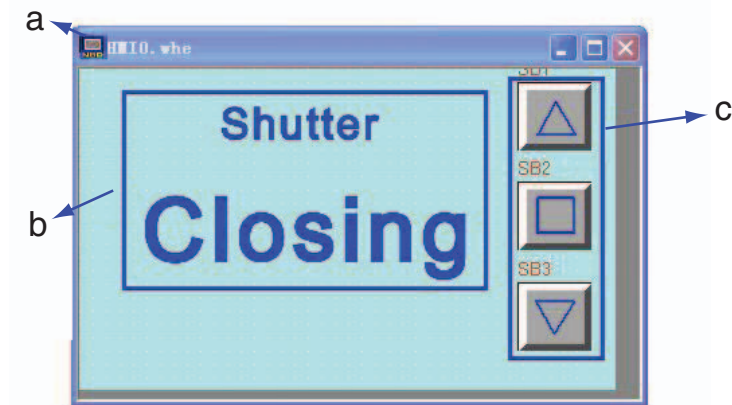

a Screen b Fixed Text c Bit Button components

### [4 Stop]

The [4 Stop] screen will be displayed when all the conditions below are satisfied.

- The opening and closing motors are not activated.
- The upper limit LS and lower limit LS are OFF.
- The Maintenance button is OFF.

Configure functions below:

- Bit Lamp indicating the garage door state. To make the whole screen flashed to call attention.
- Bit Button components, allocated to [Open], [Stop] and [Close] garage door operations respectively.



The whole screen is shown below.

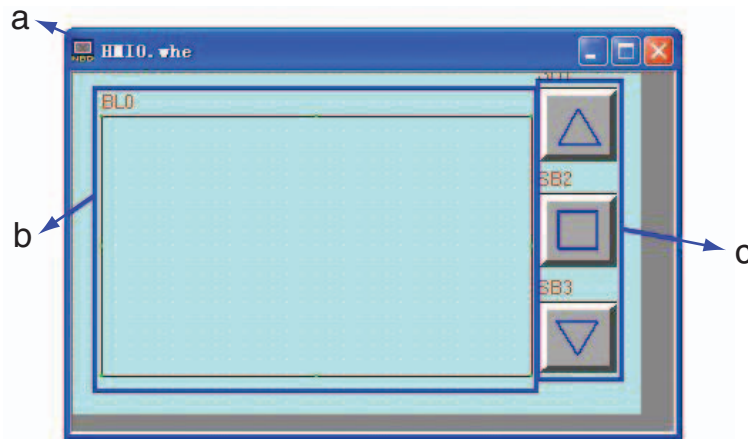

a Screen b Bit Lamp c Bit Button components

The configuration of the Bit Lamp is shown below. The creating method of the Bit Button components is the same as that of [1 Wait].

● **Bit Lamp**

The Bit Lamp and a macro program are used in this project to flash the prompt information.

- 1 Select [Bit Lamp] from [Parts], drag it to the edit window after selecting it with a single-click.

The property settings for the Bit Lamp are:

Read Address	LW.B 10.0
Type	Value 1 Blinking state 1, value 0 Showing state 0
Cycle	5*100 ms
Label	Transport font: 0: blank 1: Shutter Stopped

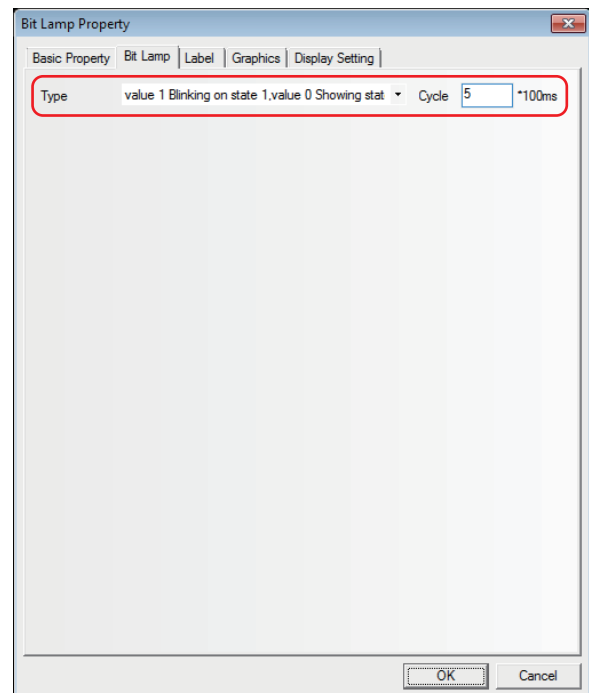
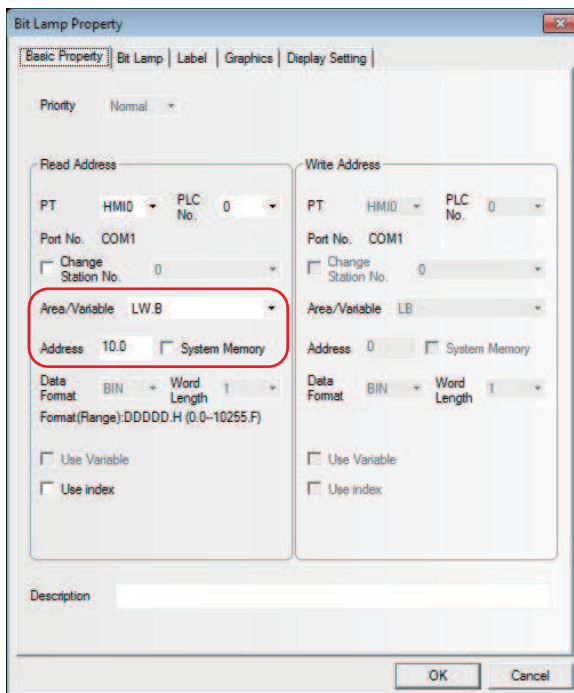

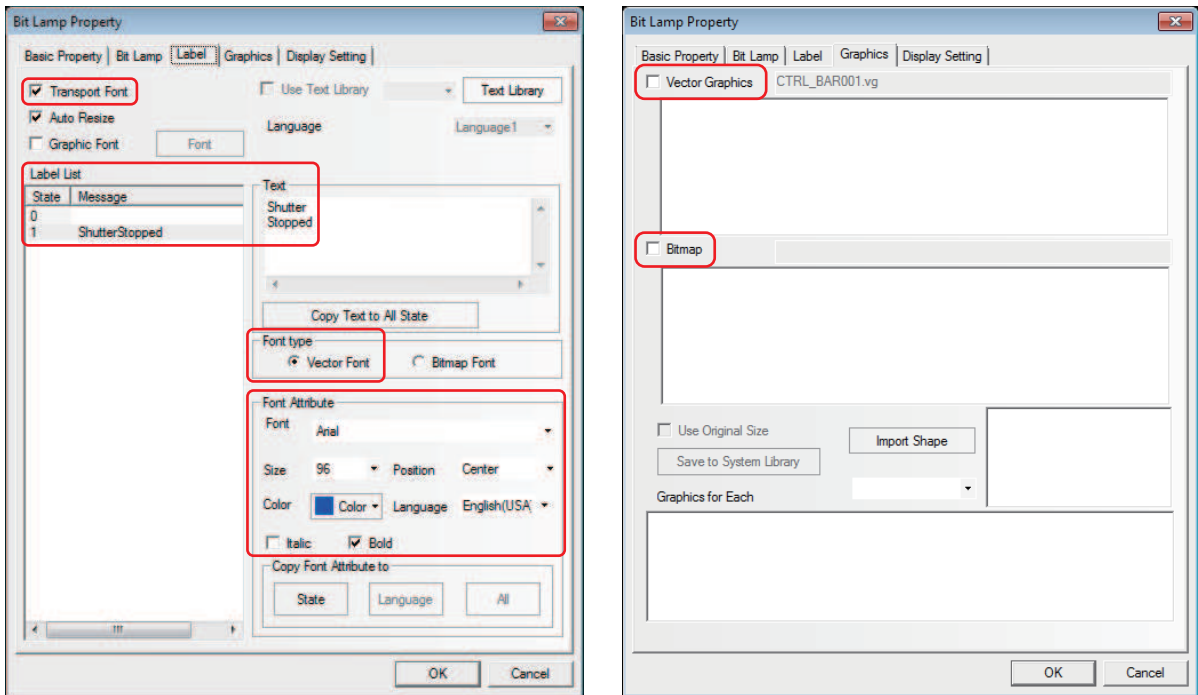

**2** Setting the value of the LW.B 10.0 to 1, the Bit Lamp can be flashed.

The value of LW.B 10.0 can be initialized by the macro below. (Refer to 4-3 *Creating Project* for the procedure to create macro file.) The project allows the initialization by the macro after the project downloading to PT. Accordingly, put a check in the option [Use Macro when loading project] in the tab [PT Extended Property] in the screen [PT Property] and set to execute "macro\_0.c" which was created. (Refer to 4-5 *PT Property* for the setting method).

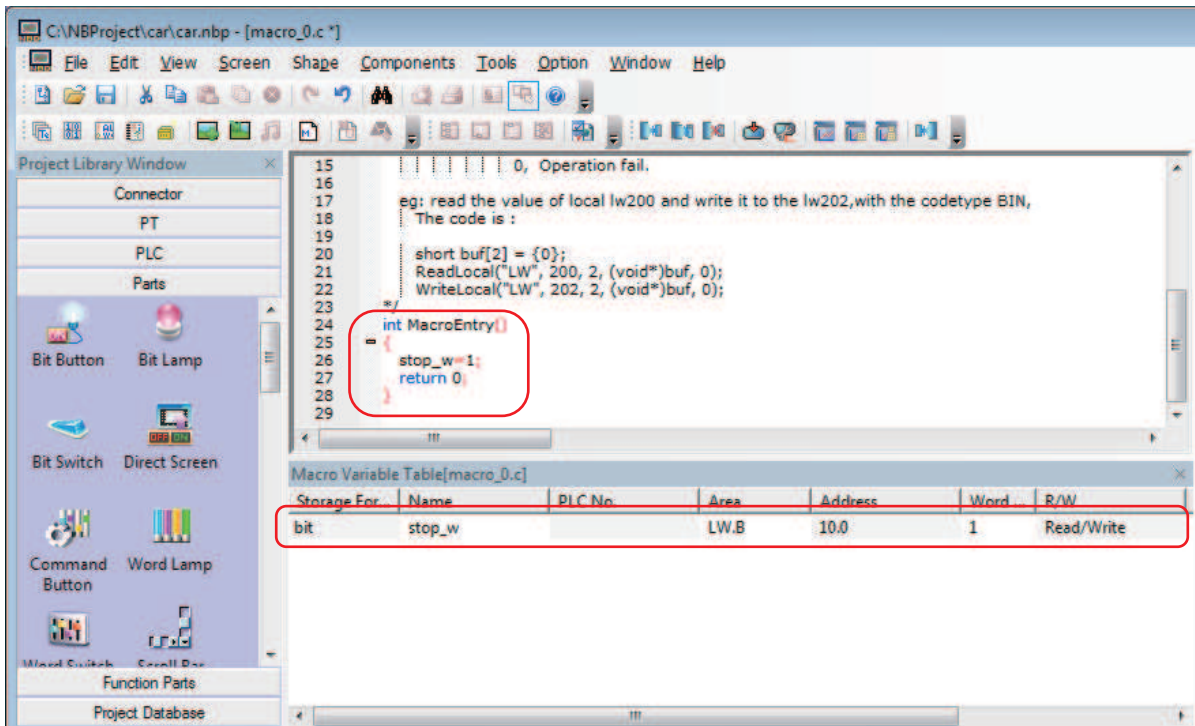

## [5 Fully Open]

The [5 Fully Open] screen will be displayed when the lower limit LS is ON.

Configure functions below:

- Fixed text indicating the garage door state.
- Bit Button components to block the inputs from vehicle sensors to prevent the garage door from closing automatically.
- Bit Button components, allocated to [Open], [Stop] and [Close] garage door operations respectively.

The whole screen is shown below. The creating methods for fixed text and Bit Button components for [Open], [Stop] and [Close] garage door operations are the same as that of [1 Wait].

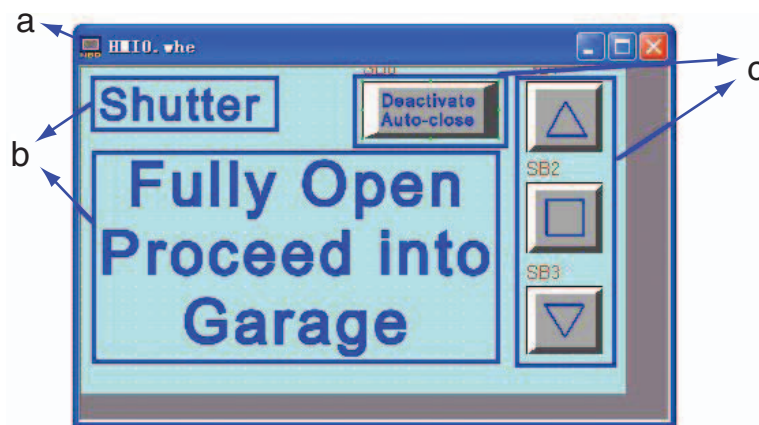

a Screen b Fixed Texts c Bit Button components

### ● Bit Button Components

Function: Block inputs from vehicle sensors. W\_bit0.01 turns ON and the input CIO\_bit0.03 from vehicle sensors is blocked after the component is pressed. Herein, the garage door is to be closed through manual operations on Function Keys. W\_bit0.01 will turn OFF when the garage door is closed and the lower limit LS turns ON.

The property settings are:

Write Address	W_bit0.01
Bit Button Type	On
Label	Transport font: 0: Deactivate Auto-close 1: Deactivate Auto-close
Graphics	Use the vector graphic: CTRL_BAR001.vg

## [6 Check 1]

The [6 Check 1] screen will be displayed when the maintenance button on [1 WAIT] screen is pressed.

Configure functions below:

- Fixed text indicating the garage door state.
- The Bit Lamp components activating relevant lamp when the vehicle sensor, light sensor, upper limit LS or lower limit LS turns ON.
- Function Key components, buttons for switching to [1 Wait] and [7 Check 2] screens.
- Bit Button components, allocated to [Open], [Stop] and [Close] garage door operations respectively.

The whole screen is shown below. The creating methods for fixed text and Bit Button components for [Open], [Stop] and [Close] garage door operations are the same as that of [1 Wait].

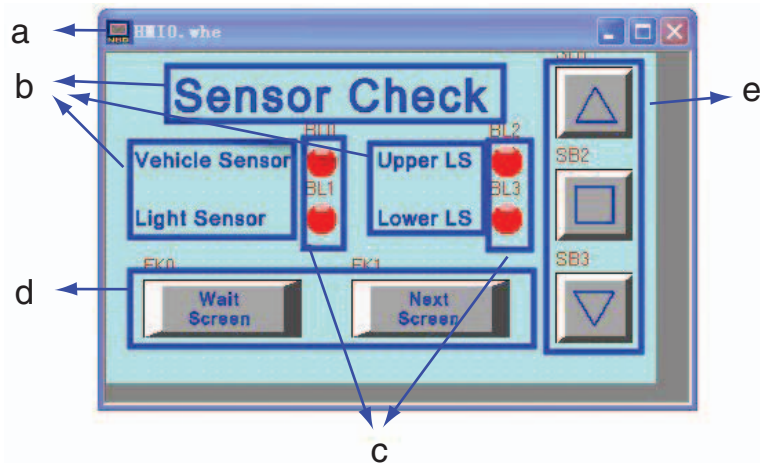

a Screen b Fixed Texts c Bit Lamp d Function Keys e Bit Button components

### ● Bit Lamp Components

The states of the vehicle sensor, light sensor, upper LS and lower LS are shown by the lamp.

The property settings for the Bit Lamp are:

Corresponding Name	Vehicle Sensor	Light Sensor	Upper LS	Lower LS
Read Address	CIO_bit0.03	CIO_bit0.04	CIO_bit0.05	CIO_bit0.06
Type	Normal			
Label	Do not use			
Graphics	Use the vector graphic: Lamp2State1-00.vg			

### ● Function Key Components

These are used for switching to [1 Wait] and [7 Check 2] screens.

The property settings of the Function Key components are:

Screen Name	Wait Screen	Next Screen
Function Key	Change screen [1 Wait]	Change screen [7 Check 2]
Label	Transport font: 0: Wait Screen 1: Wait Screen	Transport font: 0: Next Screen 1: Next Screen
Graphics	Use the vector graphic: CTRL_BAR001.vg	

## [7 Check 2]

The [7 Check 2] screen will appear after the screen-switching button on [6 Check 1] or [8 Check 3] screen is pressed.

Configure functions below:

- Fixed text indicating the garage door state.
- Bit Lamp components activating relevant lamp to check operations when the [OPEN], [STOP] or [CLOSE] Function Key turns ON.
- Function Key component, a button for switching to [6 Check 1] and [8 Check 3] screens.
- Bit Button components, allocated to [Open], [Stop] and [Close] garage door operations respectively.

The whole screen is shown below. The creating methods for fixed text and Bit Button components for [Open], [Stop] and [Close] garage door operations are the same as that of [1 Wait].

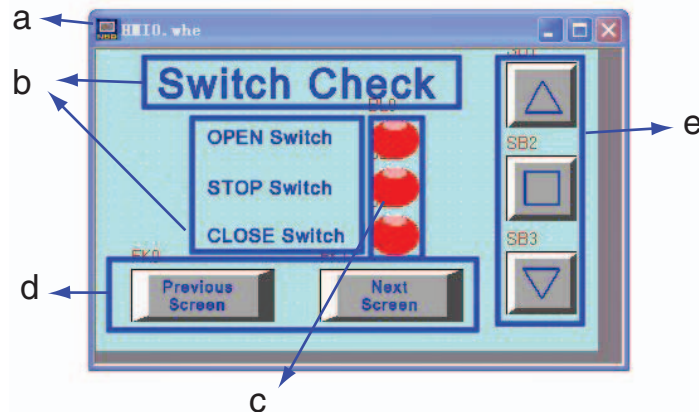

a Screen b Fixed Texts c Bit Lamp d Function Keys e Bit Button components

### ● Bit Lamp Components

The states of the [OPEN], [STOP] and [CLOSE] switches are shown by the lamp.

The property settings for Bit Lamp are:

Corresponding Name	OPEN Switch	STOP Switch	CLOSE Switch
Read Address	W_bit 1.00	W_bit 1.01	W_bit 1.02
Function	Normal		
Label	Transport font: 0: blank 1: OPEN	Transport font: 0: blank 1: STOP	Transport font: 0: blank 1: CLOSE
Graphics	Use the vector graphic: Lamp2State1-00.vg		

### ● Function Key Components

These are used for switching to [6 Check 1] and [8 Check 3] screens.

The property settings for the Function Key components are:

Screen Name	Previous Screen	Next Screen
Function Key	Change Screen[6 Check 1]	Change Screen[8 Check 3]
Label	Transport font: 0: Previous Screen 1: Previous Screen	Transport font: 0: Next Screen 1: Next Screen
Graphics	Use the vector graphic: CTRL_BAR001.vg	

## [8 Check 3]

The [8 Check 3] screen will be displayed when the screen-switching button on the [7 Check 2] screen is pressed.

Configure functions below:

- Fixed text indicating the garage door state.
- Number Display components displaying the current values of TIM0 and CNT0 used in the ladder program.
- Function Key components, buttons for switching to [7 Check 2] and [1 Wait] screens.
- Bit Button components, allocated to [Open], [Stop] and [Close] garage door operations respectively.

The whole screen is shown below. The creating methods for fixed text and Bit Button components for [Open], [Stop] and [Close] garage door operations are the same as that of [1 Wait].

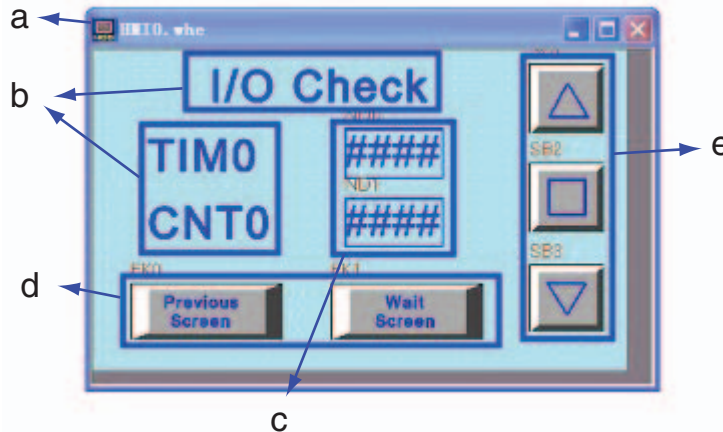

a Screen b Fixed Texts c Number Display components d Function Keys e Bit Button components

● **Number Display Components**

The current values of TIM0 and CNT0 on the ladder program.

The property settings for the Number Display are:

Corresponding Name	TIM0	CNT0
Read Address	T0	C0
Storage Format	Unsigned int	Unsigned int
Graphics	Use the vector graphic: BlueFrame.vg (A vector graphic consists of a Number Display component and a blue border.)	

● **Function Key Components**

These are used for switching to [1 Wait] and [7 Check 2] screens.

The property settings for the Function Key components are:

Screen Name	Previous Screen	Wait Screen
Function Key	Change Screen[7 Check 2]	Change Screen[1 Wait]
Label	Transport font: 0: Previous Screen 1: Previous Screen	Transport font: 0: Wait Screen 1: Wait Screen
Graphics	Use the vector graphic: CTRL_BAR001.vg	

## PLC Control Setting

In this project, the screen is controlled by PLC, to realize this function, the PLC Control component should be used.

Using of PLC Control component allows to change screen from the PLC or to write a number of Current Base Screen to the PLC . When Switch Screens is used, the default Word Length of the specified memory is set to 2. When a value which corresponds to the number of the Current Base Screen is set, the screen is automatically changed to a screen which corresponds to the number. In this example, the value D 0 is used as the corresponding screen number and the number of the Current Base Screen indicated at D 11 is output.

### ● Switch Screens

Select [PLC Control] from [Project Database].

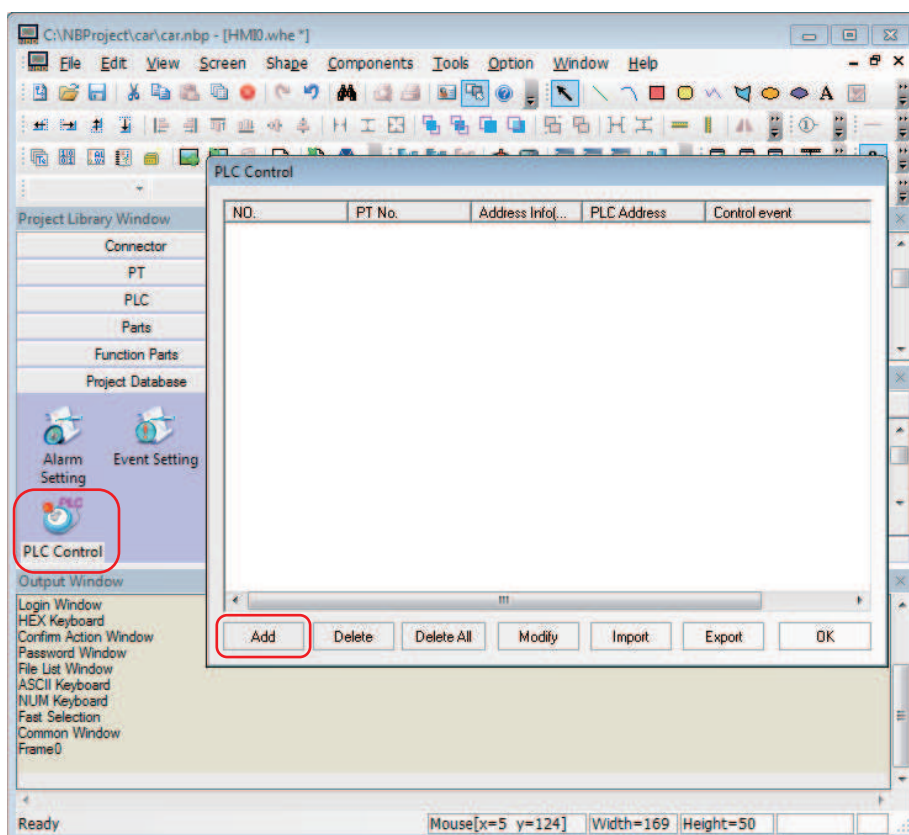

After clicking the Add button, make the settings in the PLC Control dialog box as shown below.

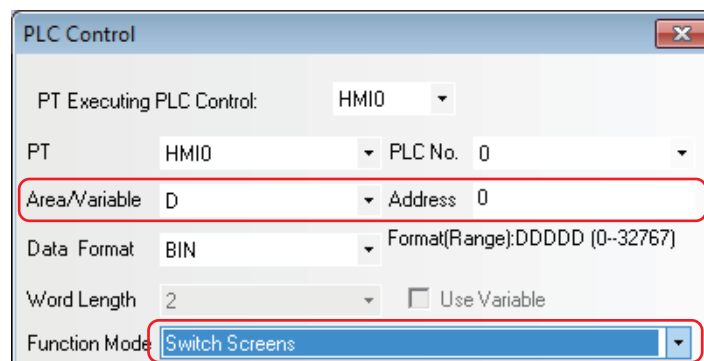

After click [OK], there is a new event added in the list.

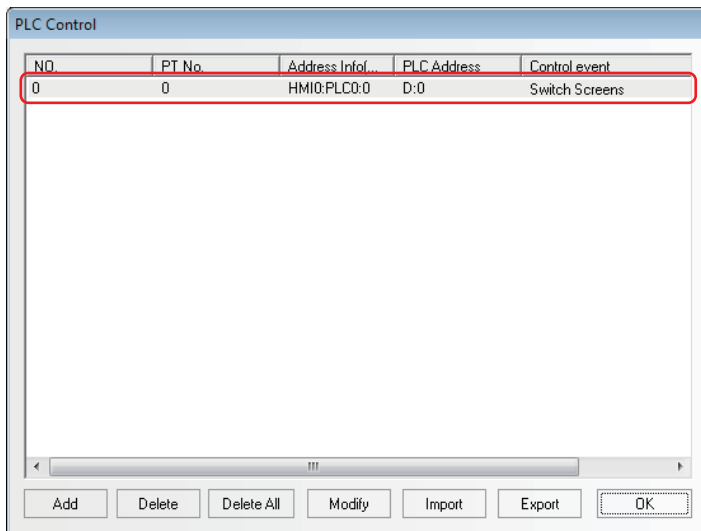

● **Write Data to PLC (Current Base Screen)**

Add a control event which outputs the number of Current Base Screen from the PT to the PLC in the same procedure.

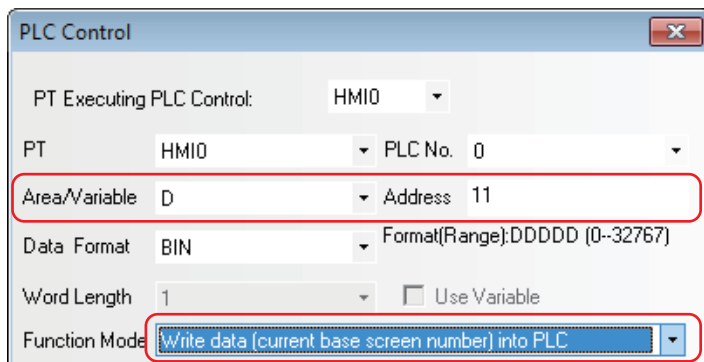

Then the PLC control setting has been done.

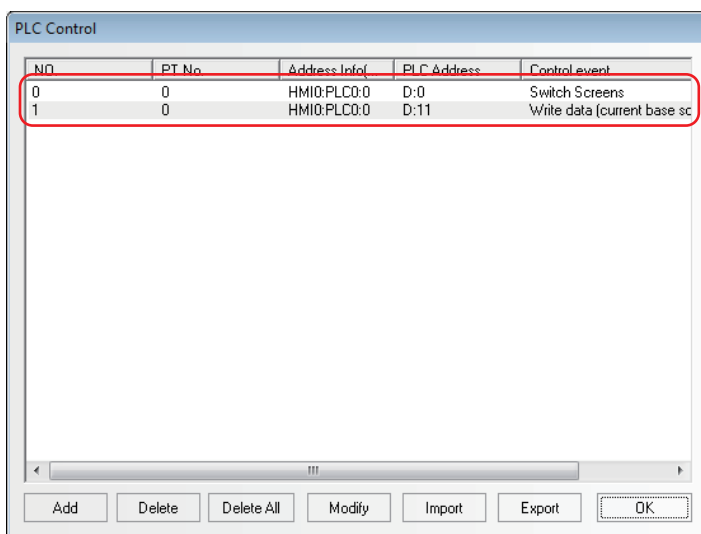

Refer to the *NB Series NB-Designer Operation Manual (V106)* for the details on PLC Control.



## 4-5 PT Property

- 1 Select “Task Bar” page on “PT Property” window and in this project example, the “Display Task Bar” is not checked. Click OK button to save the settings.

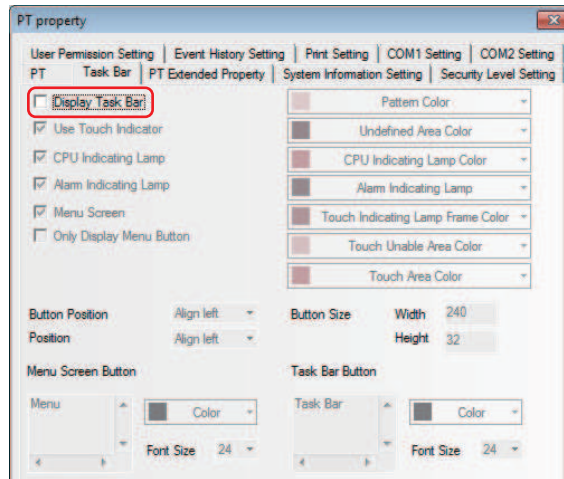

- 2 Select “PT Extended Property” page in “PT Property” window and in this project example, the “Use Macro when loading project” item is selected and the “Initial Screen” is set to “[10 Wait] screen”. Click OK button to save the settings.

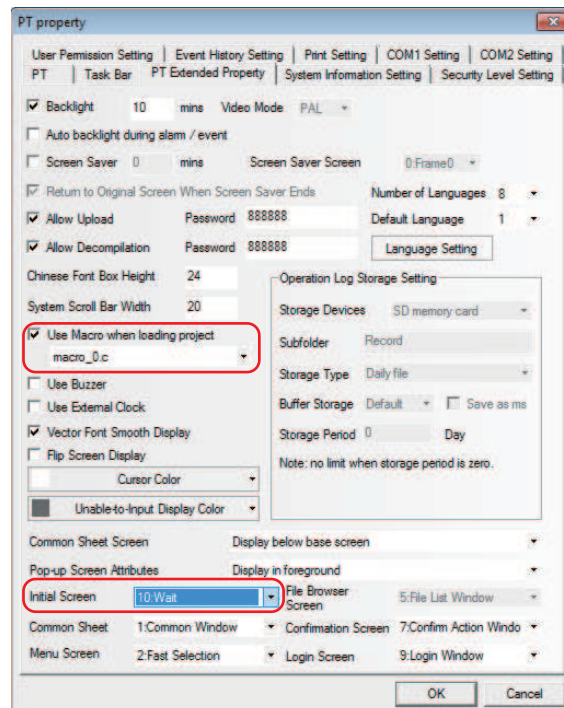

The default “Initial Screen” is “0: Frame0” when PT has not created a screen. The serial number and name of the screen will appear in the pull-down menu of “Initial Screen” after the user establishes the screen.

## 4-6 Save and Load Project

This part describes how to save and open data created. It also provides a brief for test function of creating screen.

### ● Save Project

- 1 Select [File]-[Save As] from the main menu. The [Project Save Path] dialogue border will pop up.

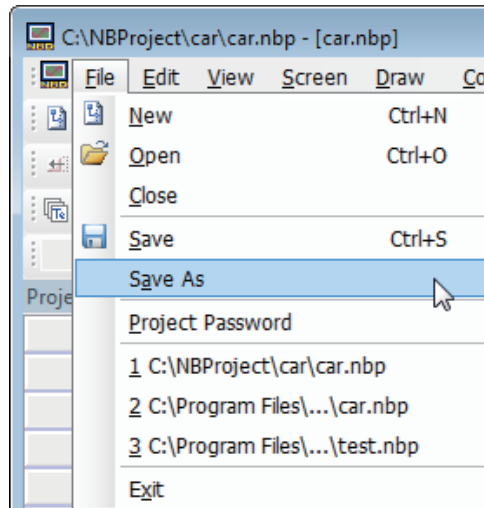

- 2 Designate [Save File] location and input the file name. Click OK. The NB-Designer project file is saved.

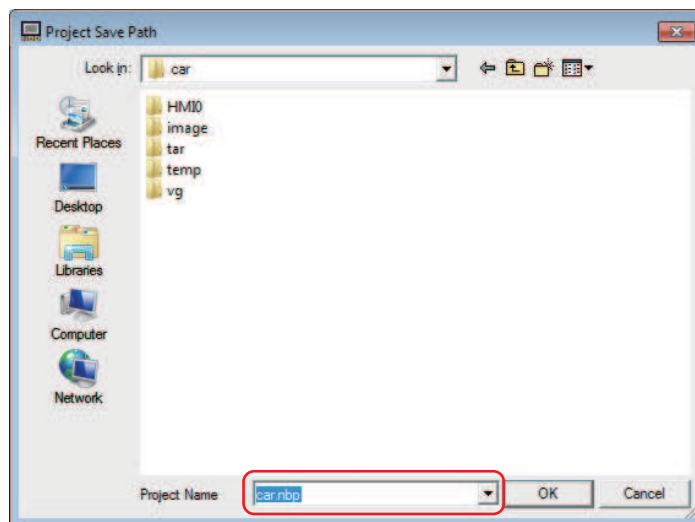

## ● Open Projects

- 1 Select [File]-[Open] from the main menu. The [Open] dialogue border will pop up.

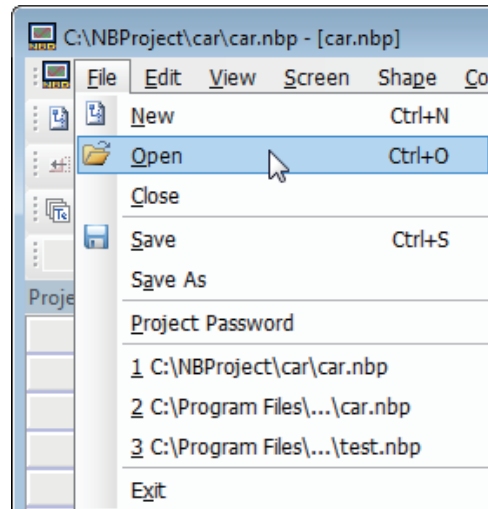

- 2 Designate the [Look in] location and select the file name. Single-click [Open]. Open the NB-Designer project file.

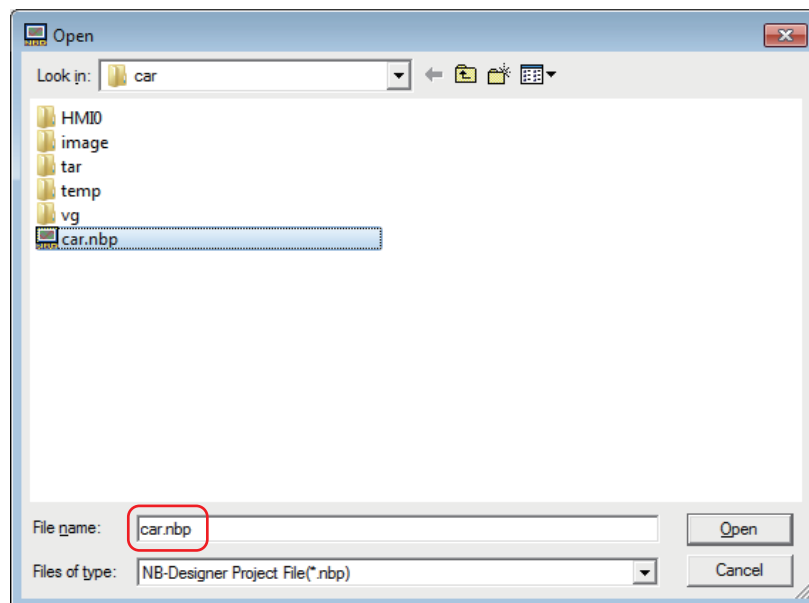

### ● Test function

The display effect of the created screen can be checked by the NB-Designer itself through the offline test without need to connect it to the PLC. Select [Tools] - [Compile] from the main menu. After the successful compilation, select [Tools] - [Offline Test] and then right-click the mouse to select “close” to exit from the test. Please note that it needs to be recompiled and then tested each time when the setting or project is changed.

The offline test is convenient for users to preview the screen effect visually without need to download programs to the PT, thus enhancing the efficient programming substantially, but the offline test can only show the display effect of the project screen. Because this project involves the data sampling and input/output control of PLC, the actual operating effect can be seen only after the edited project being downloaded into PT for operation and the communication with PLC being established. If the user just wants to see the created screen effect, it needs to place one Number Input component in the Common Screen with the address of LW0 (for example), and then add the same address into the PLC Control component with the Control Type of “Switch Screens” in the PLC Control dialog box. In this case, each created screen can be seen after the number of 10 to 17 input into the Number Input component during the offline test. Later, it just needs to delete the Number Input component and the added control conditions after the correct confirmation.

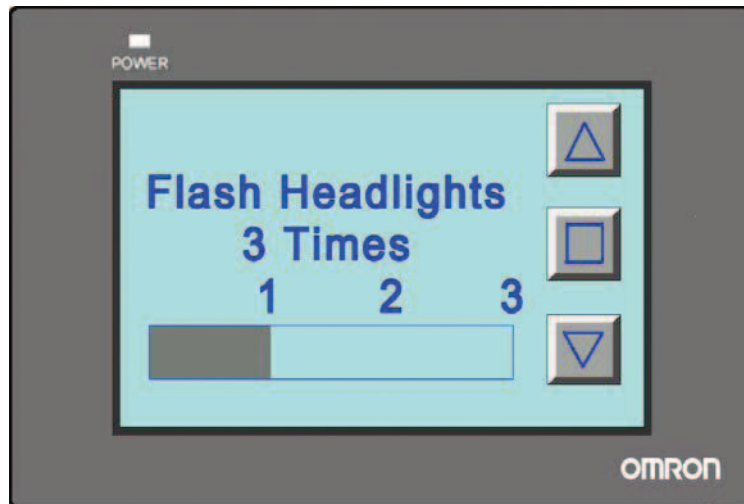

Refer to the *NB Series NB-Designer Operation Manual (V106)* for the details of the test.

# 5

## Run

This section describes how to start running at the Host side and transfer screen data to NB7W.

---

<b>5-1 Preparations .....</b>	<b>5-2</b>
<b>5-2 Run NB7W .....</b>	<b>5-5</b>

## 5-1 Preparations

This part describes how to start running at the Host side (CP1E) and transfer screen data to NB7W.

### Connect CP1E and PC

Use a USB cable to connect CP1E and a PC.

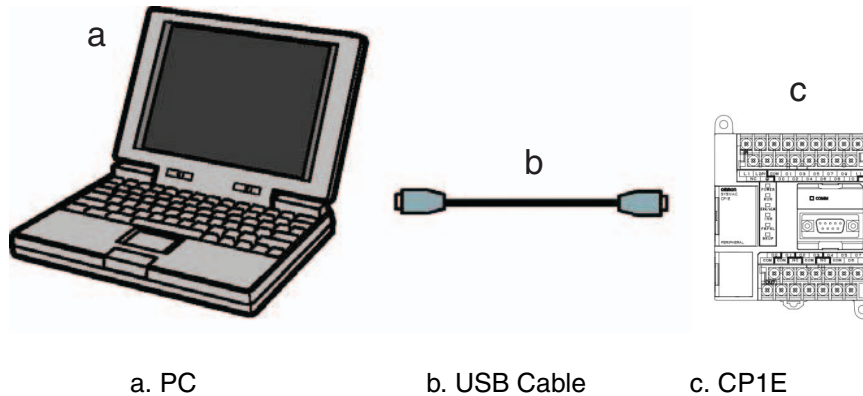

**Note** USB driver is needed to be installed when CP1E is connected to a PC the first time. Refer to the SYSMAC CP series CP1E CPU Unit Operation Manual for details on installing USB driver.

### Connect CP1E

CX-Programmer is a programming tool [software] for creating ladder programs executed by CP1E. Aside from the programming function, it also provides functions for setting and operating CP1E, such as debugging program, indication of current values, monitoring function, PLC settings and remote programming and monitoring through the internet, etc. Please refer to the SYSMAC CX-Programmer Operation Manual for details on CX-Programmer.

Run CP1E after sending programs to CP1E. Create CP1E programs using CX-Programmer.

- 1** Start CX-Programmer and open the created program.
- 2** Select [PLC]-[Work Online] from the main menu of CX-Programmer.

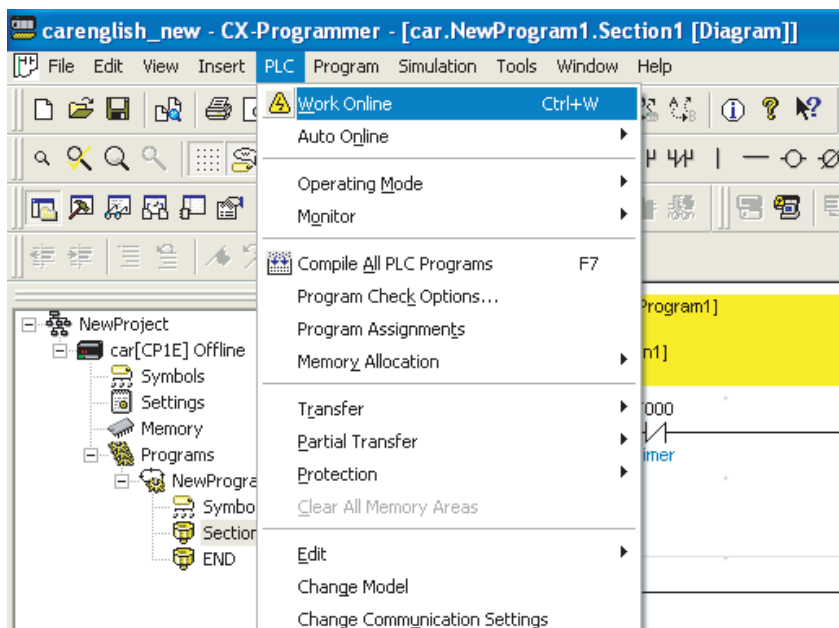

- 3** Select [PLC] - [Transfer] - [To PLC] from the main menu.

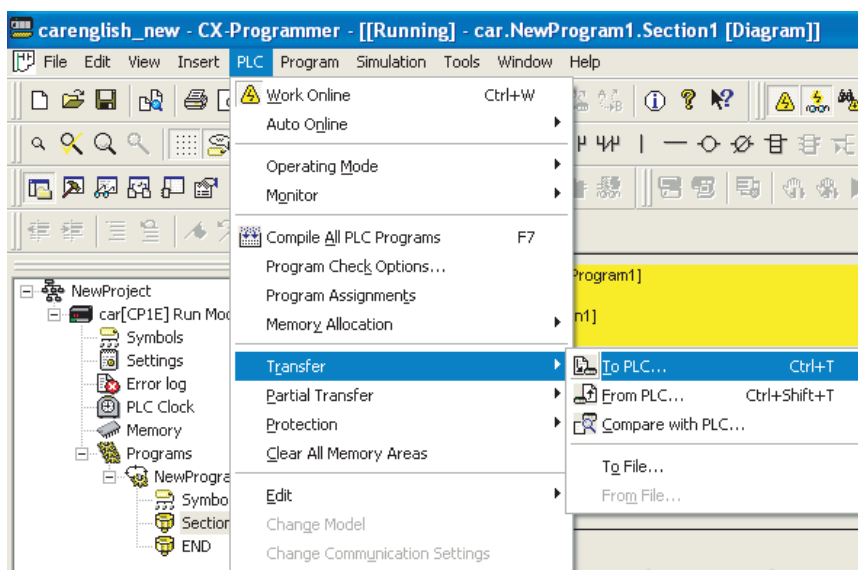

- 4** Send data according to the procedures described on the screen.

- 5** Select [PLC]-[Operating Mode]-[Run] from the main menu.  
CP1E starts running.

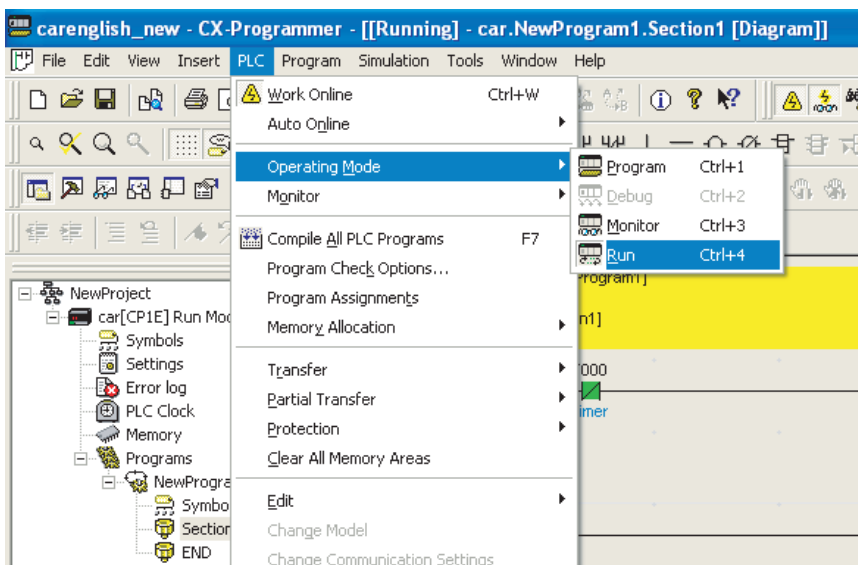

## Connect NB7W and PC

### ● Using a USB cable to connect NB7W and a PC

The screen programs created by NB-Designer can be sent to NB7W.

- Note**
- It is allowed to use USB cables of any standards.
  - Use a USB cable with a maximum length of 5 m.

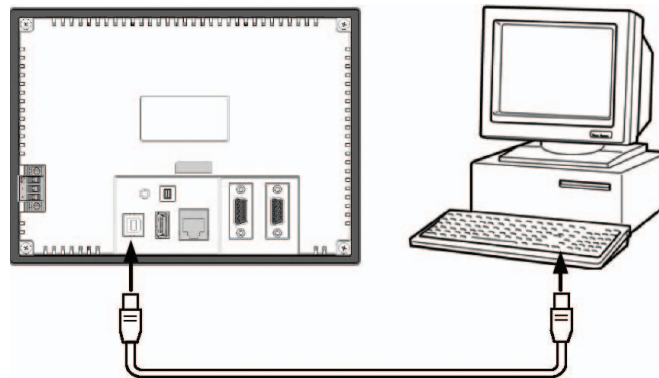

**Note** USB driver for NB Series must be installed in the PC if USB is used to connect NB7W and the PC. The USB driver should be installed automatically when NB-Designer is run on a PC the first time. Refer to the *NB Series NB-Designer Operation Manual (V106)* for the details of USB driver installation.

● **Using Ethernet to connect NB7W (NB□□-TW01B supporting Ethernet connection) with PC**

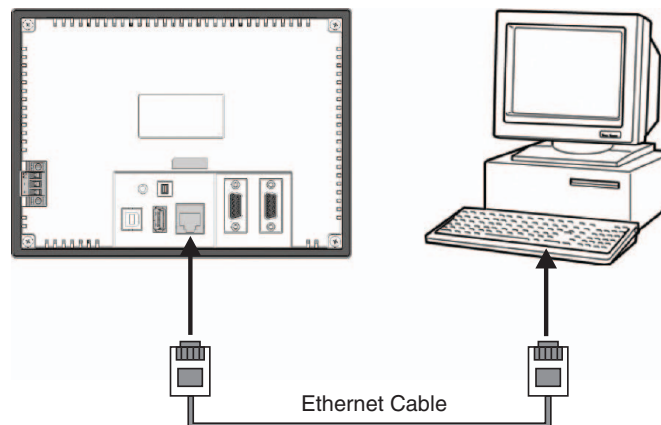

- 1** Make Network Setting in the [PT] tab in [PT Property] dialog box of NB-Designer. (e.g. IP is 192.168.250.1; Subnet Mask is 255.255.255.0 and Default Gateway is 0.0.0.0.)
- 2** Set the DIP Switch of this PT to “1 ON” and “2 ON”, and then make the Network Setting: IP, Port, Subnet Mask and Gateway (Network Setting also available for the PT with Ethernet interface).
- 3** Make the Network Setting in this mode same as that in the PT tab of NB-Designer. (e.g. IP is 192.168.250.1 and Subnet Mask is 255.255.255.0.)
- 4** Restart the PT, and then check if the IP and Subnet Mask are set successfully.
- 5** Set the IP address of PC and that of PT locating in the same network segment with the first 3 parts being same and the last part being different (e.g. IP is 192.168.250.2 and Subnet Mask is 255.255.255.0.).
- 6** Use the network cable to connect PT and PC, and then the project can be downloaded immediately.

**Note** For the details of Ethernet connection, refer to NB-Designer Operation Manual.



## 5-2 Run NB7W

This part describes how to send screen programs of NB-Designer to NB7W .

- 1** Connect NB7W and a PC.
- 2** Start NB-Designer and open the screen program created.
- 3** Select [Tools]-[Compile] from the main menu. Select [Tools]-[Download] after compilation is completed.

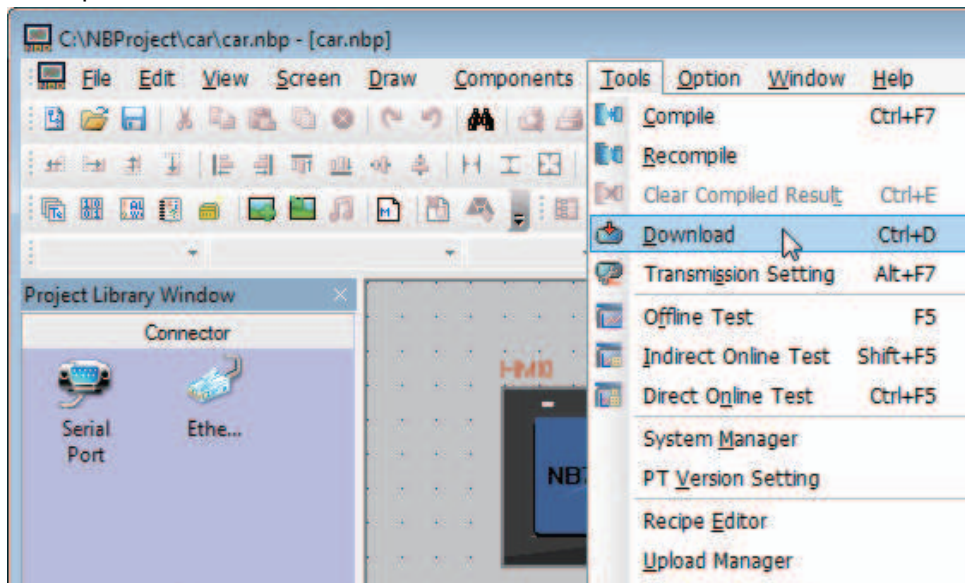

- 4** NB7W restarts after data sending is completed.

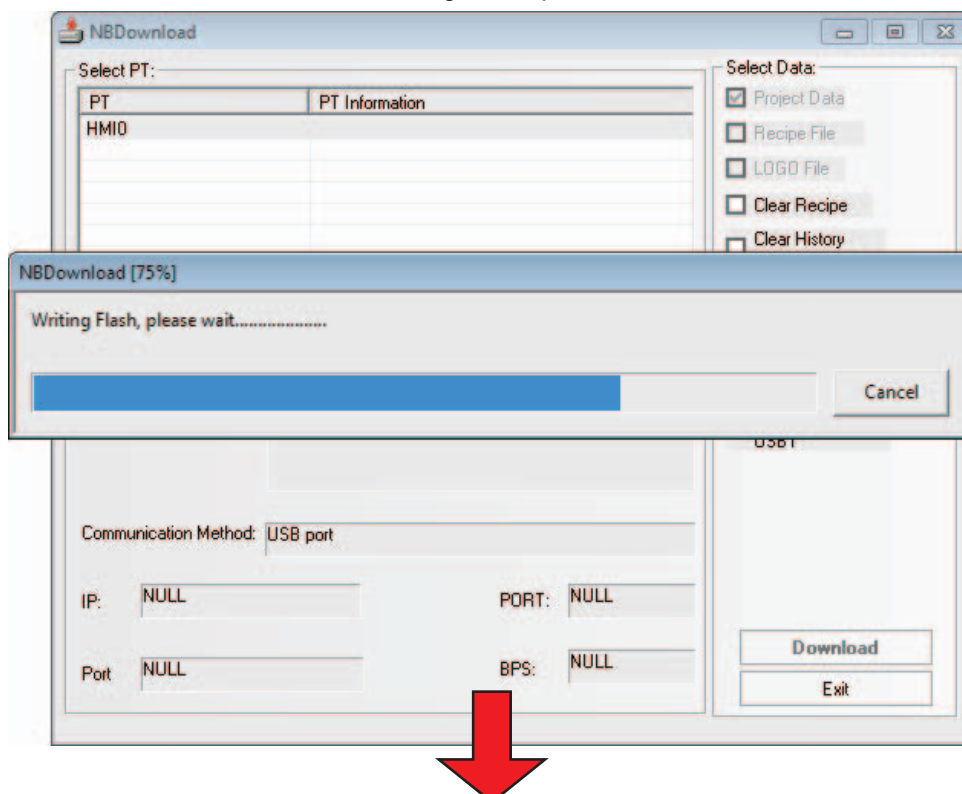

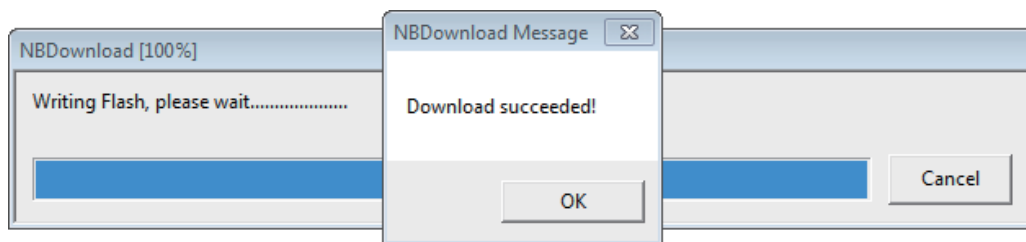

**Note** When downloading the project to USB memory to operate, refer to the *NB Series Setup Manual (V107)*.

In this case, the exemplary project of garage door control system will work normally after the programs are transferred to CP1E successfully by CX-Programmer and the project are downloaded into HMI successfully by NB-Designer, as well as the NB Unit are connected to CP1E and the other devices according to the requirements.



# Maintenance and Troubleshooting

This section describes the maintenance and inspection methods for preventing errors occurring, and troubleshooting measures when errors occur.

---

<b>6-1</b>	<b>Maintenance</b>	<b>6-2</b>
<b>6-2</b>	<b>Checking and Cleaning</b>	<b>6-3</b>
<b>6-3</b>	<b>Troubleshooting</b>	<b>6-5</b>
6-3-1	Countermeasures for errors	6-5
6-3-2	Communication-related Troubles	6-26
6-3-3	Hardware Troubles	6-30
6-3-4	Errors occurred when the UDP communications with OMRON PLC	6-32
6-3-5	Other Troubles	6-32
<b>6-4</b>	<b>Unit Replacement Precautions</b>	<b>6-34</b>

## 6-1 Maintenance

This section describes the maintenance methods for preventing errors occurring.

Maintain the PT to keep it in its optimal condition.

### **WARNING**

Do not attempt to disassemble the units or touch inside of the units while the power is ON. Otherwise it may result in electric shock.



Always the personnel in charge confirm that installation, inspection, and maintenance were properly performed for the NB Units.

“Personnel in charge” is qualified and responsible for obtaining safety in each phase of machine design, installation, operation, maintenance, and disposal.



Do not attempt to disassemble, repair, or remodel the NB units. Otherwise it may impair the proper safety functions.



#### ● **Backup of application**

When the unit needs to be repaired due to the occurrence of some faults or to be replaced by the substitute, be sure to make backup of the applications and keep it in a safe location.

#### ● **Spare part of Unit**

It is recommended to prepare the spare part of NB Unit in advance in order to repair the system when the faults occurred in NB Unit or the screen is not clear due to the backlight life expires.

#### ● **Replace of battery**

The lithium battery is used for the backup of the non-screen data such as calendar data, clock data etc.

The life of the battery is approximate 5 years at 25 °C (1 year = 365 days ×12 hours /day). If the battery is used at high temperature, its life will be reduced. Ask for repairment after backup the project data according to the environment in which you are using the NB units.

## 6-2 Checking and Cleaning

This section describes the inspection and cleaning method for the NB Unit.

Please clean and check the NB Series periodically to ensure the NB Series always in the optimal status.

### ● Cleaning method

If the display part is dirty, then the screen will hard to see. Please perform cleaning periodically according to the following points:

- During the daily cleaning, please use the dry soft cloth. But if use the dry soft cloth to clean forcefully when it is too dirty, the front panel may be damaged. In this case, use the wet cloth to clean it in advance.
- When the dirt cannot be cleaned by dry cleaning, please dip the cloth into the diluted neutral washing agents (concentration of 2%) completely first, and then perform cleaning after the wet cloth is wringed out.
- Waste, ethylene products or tape sticking to the Unit for a long period will generate dirt. If there is dirt sticking to the Unit, please remove it during the cleaning.



### Precautions for Safe Use

Do not use volatile solvents such as benzene or paint thinner, or chemical cloth.

### ● Checking method

Please perform checking once every 6 months to 1 year. But the frequent checking should be necessary when the Unit is used in the extreme environments such as the environment with high temperature, high humidity or more dust etc.

### ● Checking items

Please check the following items for the criterion. If the item does not conform to the criterion, please improve the surrounding environment, retighten the screw etc. to make it conform to the criterion.

Checking Items	Checking Contents	Criterion	Checking Method
Supply voltage	Voltage fluctuation at power terminal	Allowable voltage fluctuation range (DC24V, -15% to +15%)	Multimeter
Surrounding environment state	Ambient temperature (temperature inside operation panel)	0~50 °C	Thermometer
	Ambient humidity (humidity inside operation panel)	10%~90% RH(without condensation)	Hygrometer
	Dirt	Without dirt	Visual check
	Oil mist sticking	No oil penetrating into the space between the front panel and Unit box	Visual check

Checking Items	Checking Contents	Criterion	Checking Method
Installation state	Looseness of fixing metal pieces etc.	Specified torque	Phillips screwdrivers
	Connection state of connector for the cable	Inserted fully and without looseness.	Phillips screwdrivers
	Looseness of screw for external wiring	Without looseness	Phillips screwdrivers
	State of external connection cable	Without abnormality such as disconnection etc.	Visual check + multimeter
Object with expected life	Backlight brightness	With enough brightness Backlight life: approx. 50,000 hours (Typ) at room temperature (25 °C) with 40% brightness.	Visual check
	Battery	5 years (at 25 °C)	NB local time



### Precautions for Safe Use

- Cannot replace the backlight lamp or rubber packing inside the NB Unit.
- Deterioration over time can cause the touch points to move. Calibrate the touch panel periodically.
- Water and oil resistance will be lost if the front sheet is torn or is peeling off. Do not use the Unit, if the front sheet is torn or is peeling off.
- Dispose of the Units and batteries according to local ordinances as they apply.
- Periodically check the installation conditions in applications where the PT is subject to contact with oil or water.
- The rubber packing will deteriorate, shrink, or harden depending on the operating environment. Inspect the rubber packing periodically.
- To replace the battery, the NB units are also necessary to replace. Although it is restricted to NB10W-01B, the battery replacement is available to be dealt as a repairment.

## 6-3 Troubleshooting

This section describes troubleshooting measures when errors occur.

When a problem occurs during operation, refer to the listed problems below for the corresponding solutions.

### 6-3-1 Countermeasures for errors

- 1 The condition of the USB driver for the HMI  
If PT cannot perform download/upload normally it's usually because the USB driver is not set up properly.  
**Setup Method:**  
During the process of the software setup, the PC will automatically prompt you to set up the USB driver. Select an appropriate procedure to install according to the displayed information to complete the USB driver installation. However, if the automatic setup fails, you can still perform the setup manually. Connect the Unit and the PC with a USB cable, energize the Unit, and a prompt to set up new hardware will pop up at the right bottom corner. Following the displayed information, choose [Install from a list specific location (Advanced)], and find the USB driver in the driver file of NB-Designer's installation directory.
- 2 The NB-Designer software can run in Windows Vista/7 systems  
It is compatible with XP, Vista and 7 operating systems.  
Pay attention to the following items when using Windows Vista/7:
  - (a) If you use the NB-Designer on Windows Vista/7, run the program as an administrator.
  - (b) If you have compatibility problems when running the NB-Designer, run the software in compatibility mode. Right-click the mouse on the icon "NB-Designer.exe" to select compatible with Windows XP.

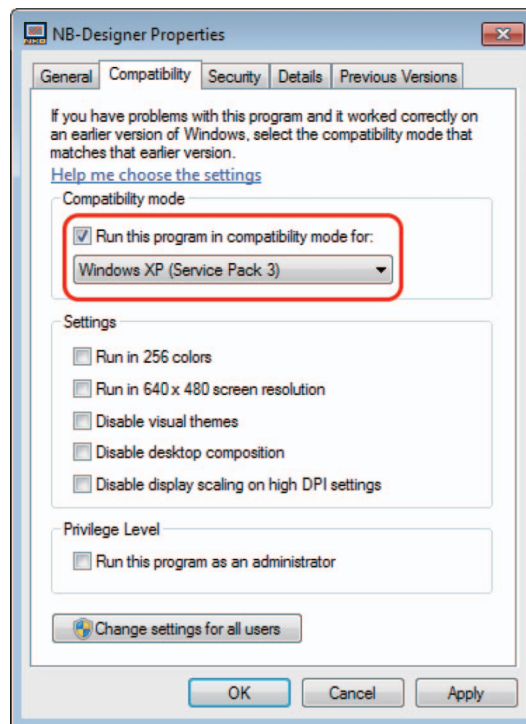

- (c) When running the NB-Designer for the first time, right-click the icon "NBDesigner.exe" located in the folder which you specified at the installation to select "Run this program as an administrator". Then start the software.

### 3 How to change system parameters like user level passwords and Baud rate

These are all controlled by the local special register. These system parameters can be found by double-clicking the component attributes, and selecting [System Memory].

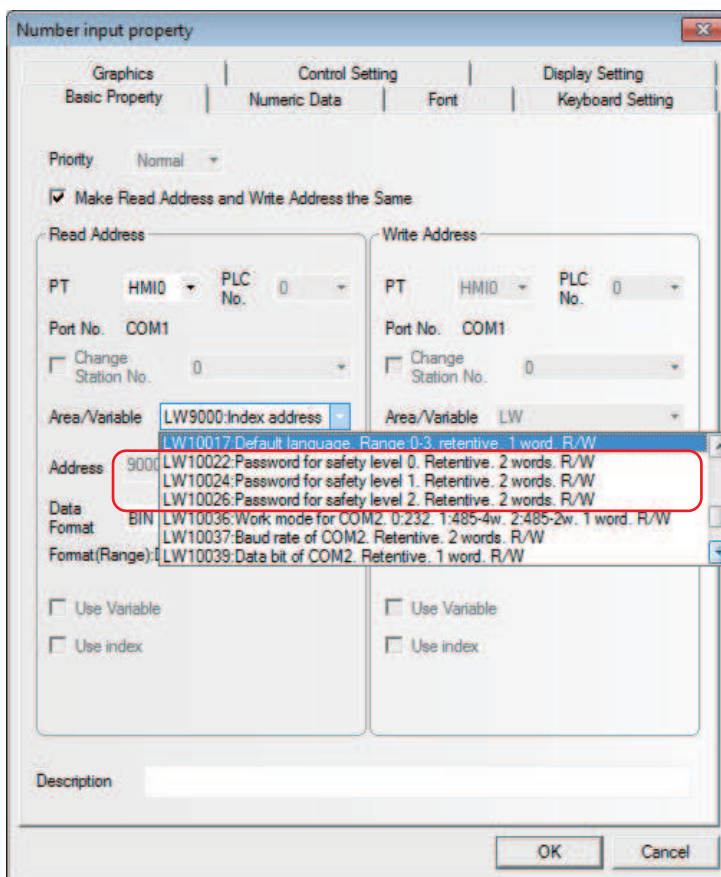
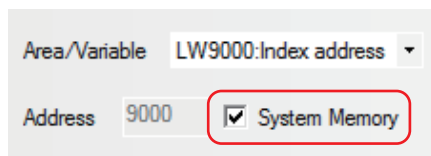

For example, the addresses for changing the password online are provided below:

LW10022~10023 Password for safety level 0, Retentive 2 words

LW10024~10025 Password for safety level 1, Retentive 2 words

LW10026~10027 Password for safety level 2, Retentive 2 words

LW10118~10143 Password for safety level 3~15, Retentive 2 words \* 13.

If the level 2 password needs to be changed, set in the software as follows: First, place a Number Input component on window, check [System Memory], then select LW10026, as shown below



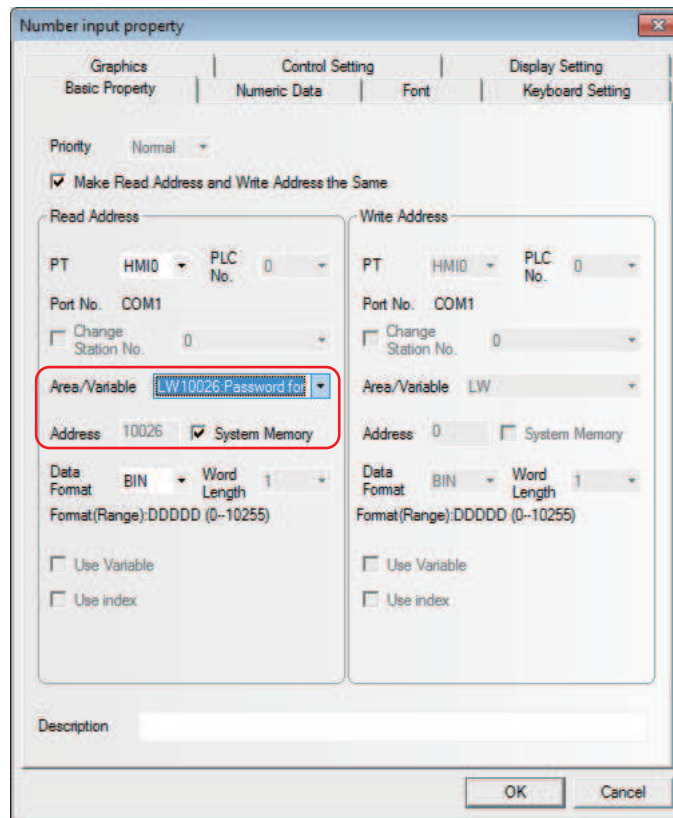

Select [Password] for the Data Type in the attributes page of [Numeric Data], as follows:

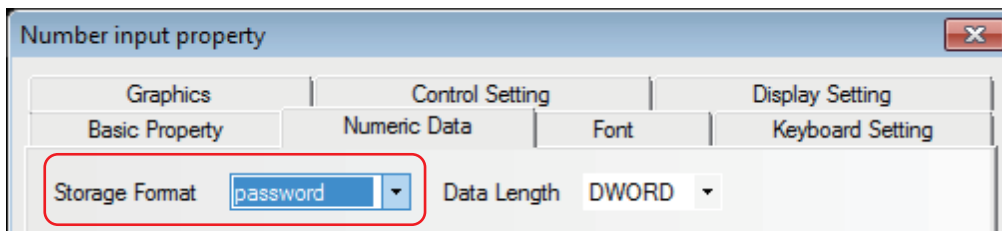

The process is the same for changing other system parameters online. But note that after changing the following system parameters, the PT needs to be rebooted to validate the changes.

**System Parameter Setting: the following addresses will take effect after reboot.**

Addresses	Descriptions	comments
10010	Initial Screen number	0~65535
10011	Screen saver (backlight saver)	0 (OFF, Constant, Screen saver inactivated) 1~600 minutes (activated)
10013	Common Sheet/Pop-up Screen	0: Normal 1: Higher than other screens
10014	Common Sheet/attribute	0: Lower than the Base screen 1: Higher than the Base screen
10015	Storage event number	0~65535
10016	RTC source	0: PLC(Local Word) 1: Internal RTC
10017	Default language	0~3
10018	System reserve	HMI internal use

**4** The difference between User permissions and User levels

User levels: There is a difference between high-level users and low-level users: the high-level users can access to the screens which are set to the high-level, while the low-level users cannot access to the screens which are set to the high-level. Each screen is encrypted based on the user level.

User permissions: The permissions are not restricted for each user level. If user name and password are entered correctly, the user can operate components which are restricted its access. The user permissions allow the user to add or delete user accounts. The user permissions can be set to the components, however, they are invalid to a password which is set to the screen.

**5** What if the uploading password or the online change password of the PT is lost

If the uploading password of PT is lost, data cannot be uploaded, and the only solution is to download the project again to overwrite the original one.

Similarly, if the online change password is lost, it also requires to download the project again and set a new password.

Thus, in order to guarantee the safety of users' projects, please back up the original projects, for decryption is not within our service range.

**6** Why cannot the system time be changed during offline test

Offline test uses the PC's clock, therefore the time cannot be changed. It can only be changed when downloaded to the PT.

**7** How to use the Confirm Operation function

When the user is fabricating a screen, some buttons may require a second confirmation to validate the operation, and at this time, the Confirm Operation function can fit well here. This function can control components. For example, you can check the [Confirm Operation] on the [Control Setting] attributes page of the bit status setting component, as shown below:

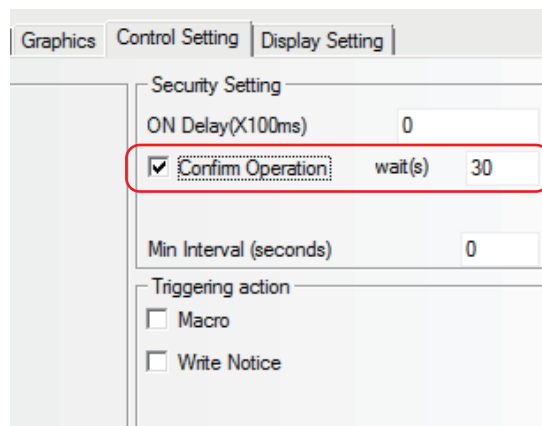

A dialog box as follows will pop up everytime you operate the components once this option is checked:

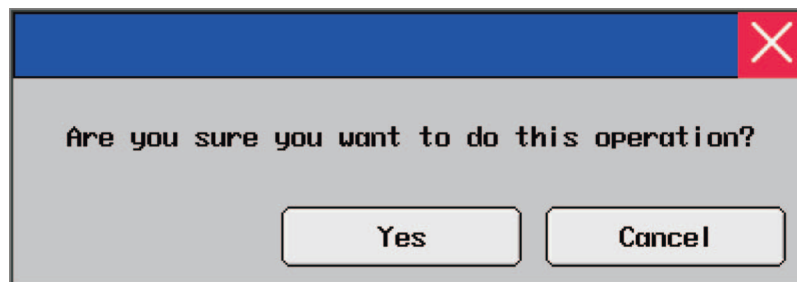



## 8 When opening a project, what if there is a prompt: [Font not existing in the system]

For example: if attempting to open a project involving  in a PC that does not incorporate

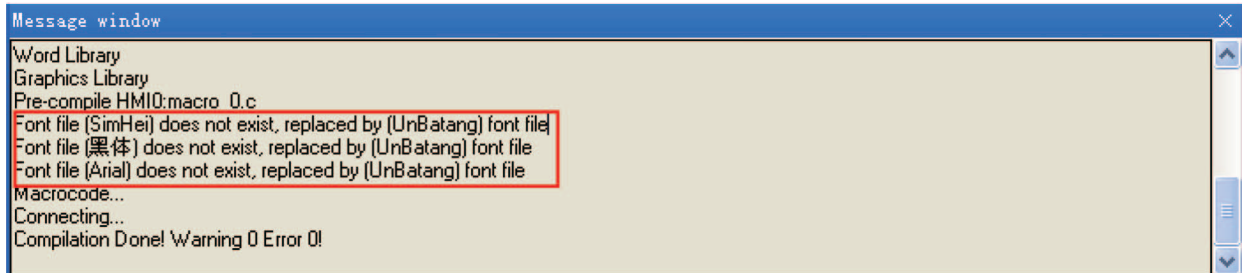

, a prompt “[SimHei] does not exist” will pop up, as follows:



If this font issue is ignored,  will be replaced with a font that exists in the system, eg. UnBatang.

## 9 How to set the addresses of the component for displaying Alarm and Event, and how to inquire Alarm and Event

It's best to use the internal register of the PT - LW for the address type of the component for displaying Alarm and Event, and the address can be designated as any of the vacant address in the project. When we record Alarm and Event on PT, one page is almost certainly not enough, then turn-page inquiring is needed to be set, thus the address in the properties of the component for displaying Alarm and Event takes effect. Take LW10 for an example, as follows:

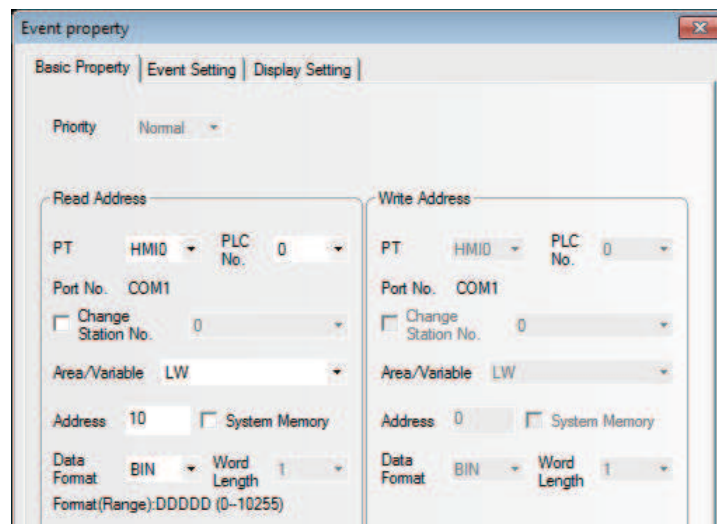

Use two Command Button as the Page Up/Down button, designate the button address the same as the component for display, and set as follows in the properties page of Command Button.

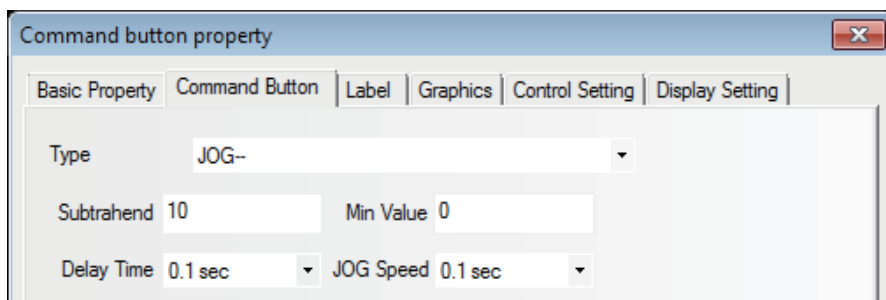
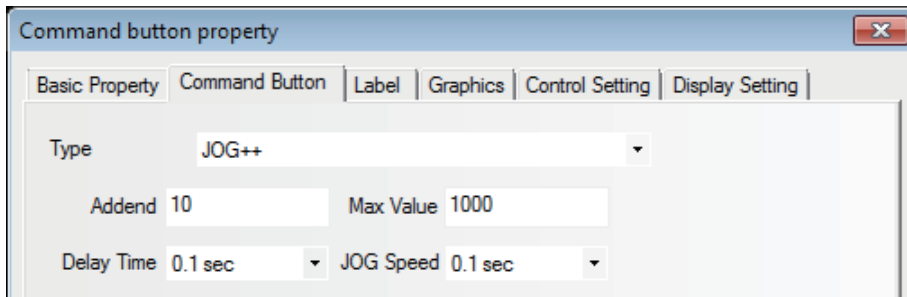

**Note** Incremental upper limit is set as the number of events which you need to record, while the decremental lower limit is recommended to be set to 0.

**10** Why is there one event inquiring record less

When the customer set the Page Up/Down Switching for [Command Button component], the lower limit is set to 1, which will cause the records to be one less. The correct setting is as follows:

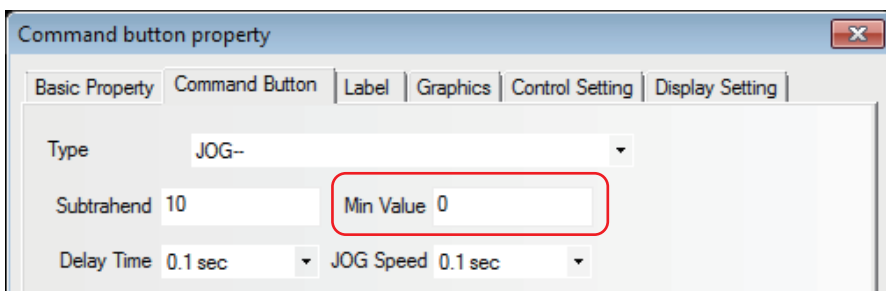

**11** How to keep the time in the event record and in the PLC synchronized

Check [Use External Clock] in [PT Property] — [PT Extended Property], as follows:

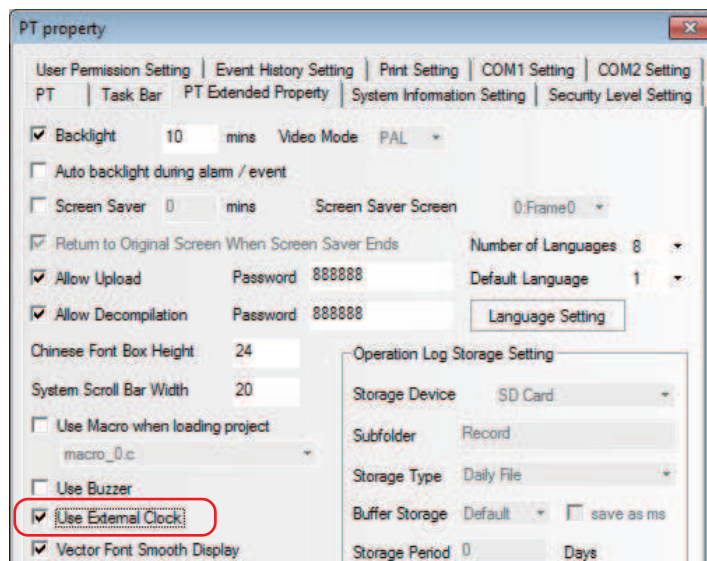

Meanwhile, clock register data inside the PLC is also needed to be transmitted to the local register LW9010-9017. Refer to the *NB Series NB-Designer Operation Manual(V106)* for the details.

```
LW9010:(Local time)second. Range:0-59. 1 word R
LW9011:(Local time)minute. Range:0-59. 1 word R
LW9012:(Local time)hour. Range:0-23. 1 word R
LW9013:(Local time)day. Range:1-31. word R
LW9014:(Local time)month. Range:0-11 1 word R
LW9015:(Local time)year. Range:0-9999. 1 word R
LW9016:(Local time)week. Range:0-6. 1 word R
LW9017:(Local time)millisecond. Range:0-999 1 word R
```

**12** Why cannot the history events be saved even if “saving” is selected

In most of this kind of cases, although the customer selects to save them, the No. of events to be saved which is 0 by default is not changed to the No. the customer needs, thus the problem occurs. In this case, just set the No. of events to be saved to make it work. This is done in [PT Property] --- [Event History Setting], as follows:

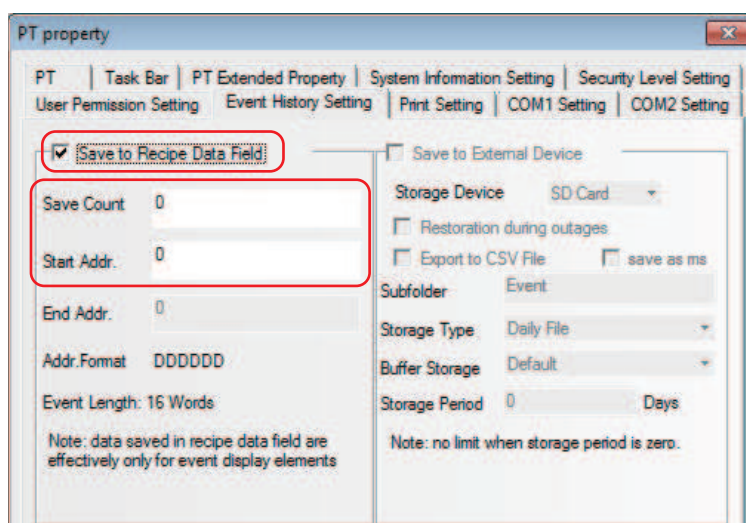

- 13** The cause of PT prompting “RTC Device error” and the solution  
 When PT prompt “RTC Device error”, it’s probably because the clock chip fails.  
 If the recipe component or the system time is not used, this notice can be shielded without affecting other operations. The method to shield it is: place a [Bit Button Component] in the project’s common sheet, with the address set to LW.B 9298.0 and the set type to [Set On when Screen Open] status.
- 14** What if there is one digit less when displaying negative numbers, or it displays “\*\*\*\*”  
 When the data type in the software is decimal, the minus sign also occupies a bit, therefore one more integer bit is needed.
- 15** When switching the screens with PLC control, why cannot the screen being set up be accessed repeatedly  
 It’s likely because the value of the PLC address through which screen switching is set does not change. The screen should be switched with the PLC control, but if switching the screen with the procedure such as screen switching (not by the PLC control), as the value of the PLC address does not change, the screen cannot be accessed repeatedly with PLC control.  
 Solution: add a [Command Button component] to the screen of leaving designated screen, with the address set to the same as the one in [PLC Control Switch Screens], and the property to [Set at Screen Close] (This value can be set as a negative).
- 16** When calling a screen with a direct screen, why does not the target screen show up completely  
 When calling a target screen with a direct screen, the left top corner is taken as the base point. If the size of the direct screen component is smaller than then target screen, the display may be incomplete. Therefore, when editing the target screen, place the component with the left top corner as the base point and make sure that the size of the target screen is the same as that of the direct screen component.
- 17** Components on the screen such as the indicator, button etc. will not show up properly, while offline test still works as normal  
 It may be caused by communication disruption between the PT and the slave. If the communication fails and the component on the screen takes the slave’s address, components like the indicator and buttons will not show up properly. Restoring the communication will solve this problem. With respect to how to restore the disrupted communication, refer to communication-related issues in this manual.
- 18** Can the PT be restarted without interrupting the power supply  
 There are two ways to restart it without interrupting the power supply:  
 Method 1: Press the RESET button on the back of the panel to restart it.  
 Method 2: Make a [Bit Switch] component, with the address as LB9045. When LB9045=1, the PT will restart.

**19** How to make the PT's buzzer sound when an alarm occurs

Set Buzzer Warning in the alarm settings, and the buzzing time can be set as required, as shown below:

**20** Turn the PT backlight ON with the PLC control

Select the PLC control component, then select [Backlight Open], as shown below:

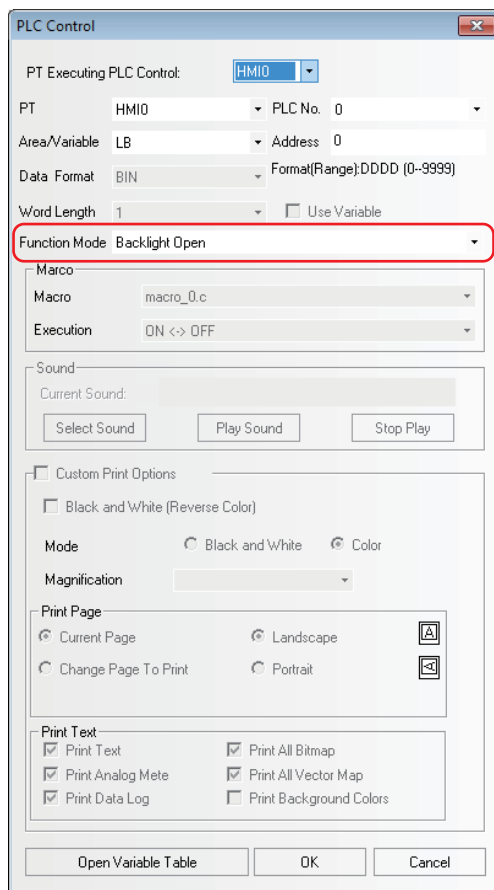

## 21 Why does the character input as text turn up as messy codes

This may be because the text input Component or the Note Book Component involves vector fonts. When inputting Chinese characters, the text input Component and the Note Book Component do not support vector font, but only support Dot Matrix Font, as shown below:

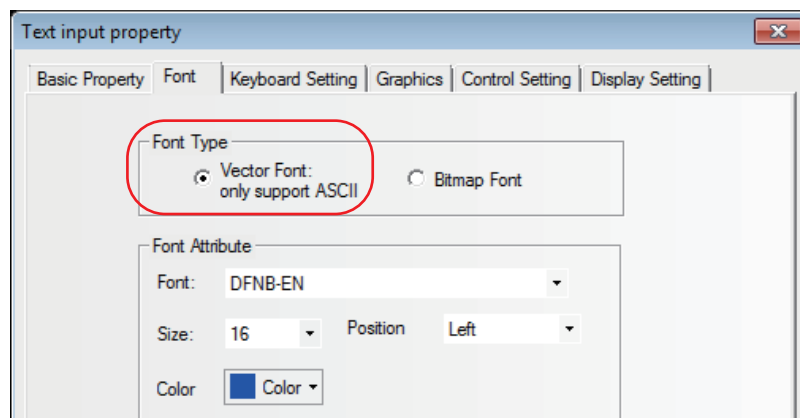

## 22 How to skip to the target screen after inputting the password correctly

Place a “Function Key” Component on the screen, and overlay it with a “Touch Trigger” component. Assume that the device address of the “Touch Trigger” Component is LB10 and the Trigger Type of it is OFF→ON, then select “Trigger Register” in the control settings of the attributes of the Number Input Component for password input. Setting the property to “Notice After Written” allows the LB10 to be turned ON. After Written. When the password is input correctly, it can directly skip to the screen switched by the Function Key.

**Note** The function of the “Touch Trigger” Component is equivalent to clicking the area covered by the “Touch Trigger”. When the trigger condition is satisfied, the components in this area will be executed.



- 23** What if a “warning: no newline at end of file” pop up when compiling a macro program
- When compiling a program, a macro instruction compiling warning “warning: no newline at end of file” pops up on the Output window. No error is found after check, but the warning persists after compiling. In this situation, input an enter at the last row of the macro instruction, as follows:

```

1 #include "macrotypedef.h"
2 #include "math.h"
3
4 int MacroEntry()
5
6
7
8
9 return 0;
10

```

Before hitting Enter ↵

```

1 #include "macrotypedef.h"
2 #include "math.h"
3
4 int MacroEntry()
5 {
6
7
8
9 return 0;
10 }
11

```

After hitting Enter ↵

- 24** Why does a “System Crash: SegV” appear after calling a macro program

The likely causes are as follows:

- The address range specified in the macro instruction exceeds the actual address
- When using array data, the array data range exceeds limits. For example: when defining int array [10], if array [10] is used, there will be an issue of array exceeding limits.
- When proceeding division operation, the denominator is 0, and no judgment is made.
- An endless loop forms in the macro.

- 25** Why cannot the project filename be edited after renaming it by the Explorer

The project file names cannot be changed directly, and the only way to rename a project is to use the [Save As] option in the [File] menu.

- 26** How to achieve indirect addressing with an index register

The function of the index register: realizing the indirect addressing mode of the register. The component's new input/output address = its original input/output address + the word address of the index register.

After checking [Use index], click the arrow and a window as follow will turn up.

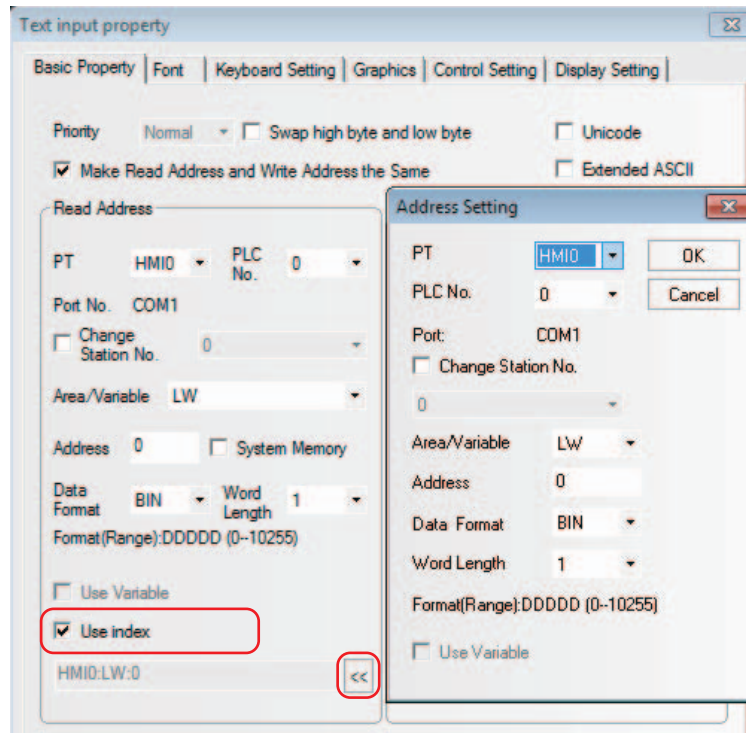

## 27 How to make sure that pictures imported are not distorted

Cut the picture with a drawing tool first. For example, if a 320\*240 picture is to be fitted on a screen with a resolution of 800\*480, use Image Software to set the width at 320 and the height at 240 in Edit→Resize, then import it into the configuration project, as shown below.

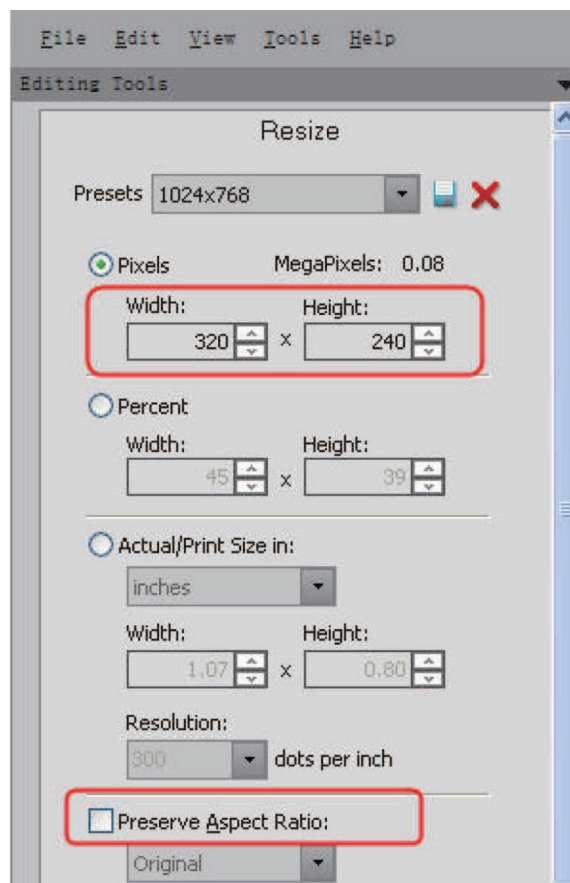

**28** When a new project is created, what roles do the screens pre-existed in the system play respectively, and can they be deleted

It's better not to delete or alter the screens pre-existed in the system, especially for new users, because each screen plays a specific role.

**The indications of the screen are as follows:**

Screen 0: default Startup Screen (Frame 0), which can be used for editing the first page.

Screen 1: Common Sheet, in which there are two direct screens used for ejecting the numeric keyboard coming with the system, and what is more, all the components in the Common Sheet work in any of screens of the project.

Screen 2: Menu Screen, used for ejecting the taskbar, and users can place a page-turning button in this screen.

**Screens pre-existed in the system also include:**

NUM keyboard

ASCII keyboard

HEX Keyboard

Confirmation Screen: this screen is used together with the [Confirm Operation] of the properties page of [Control Setting].

You can change the properties of the screens coming with the system **pre-existed in the system** in [PT Extended Property] of [PT Property], as shown below:

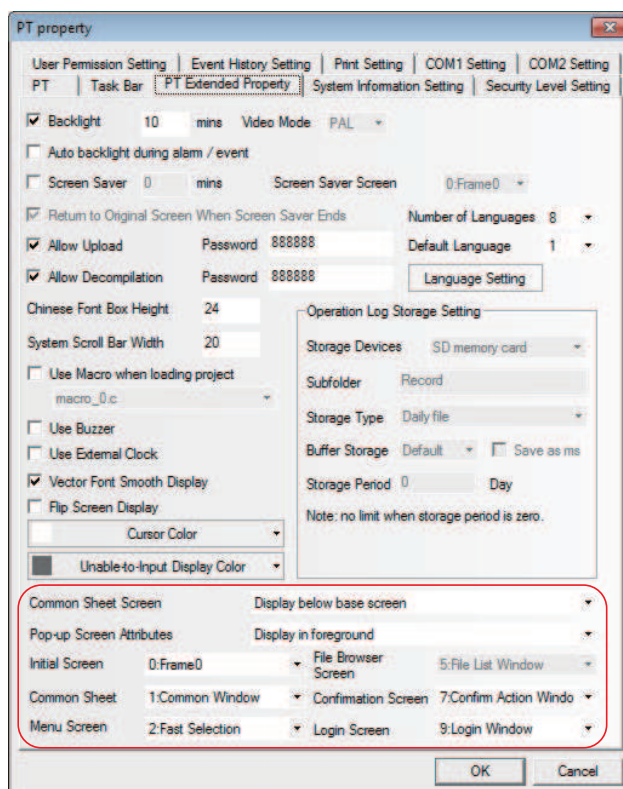

## 29 What methods are there for triggering (executing) macro

There are 5 kinds of triggering methods for macro, from which users can choose the triggering methods they need.

Method 1: [PT Property] → [PT Extended Property] → [Use Macro when loading project]: When the PT is energized and started, the set macro is executed once, as shown below:

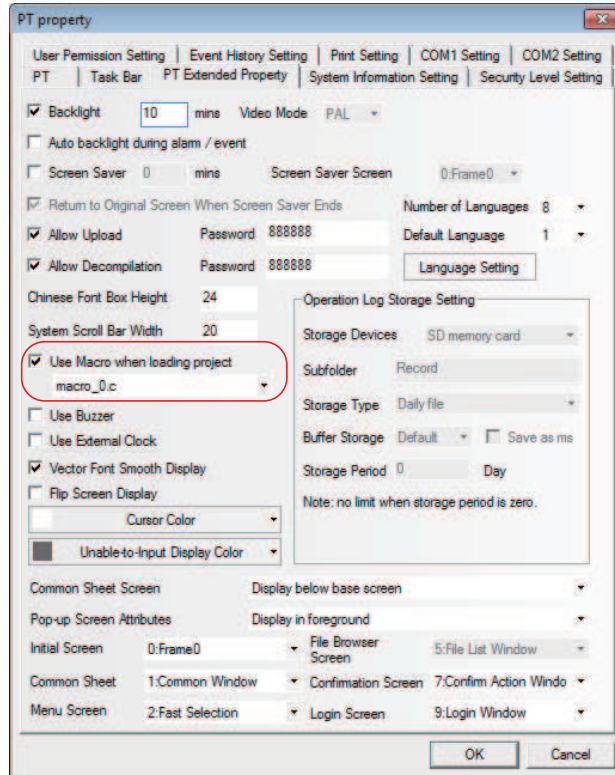

Method 2: [Function Key] → [Execute Macro]: each time the Function Key is clicked, the macro is executed once, as shown below:

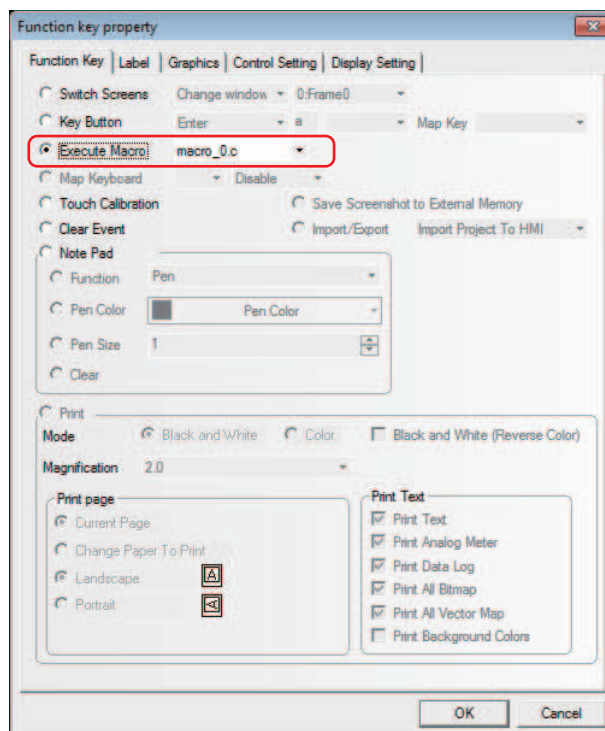

Method 3: [Timer] → [Execute Macro]: The triggering and execution of the macro is controlled by time.

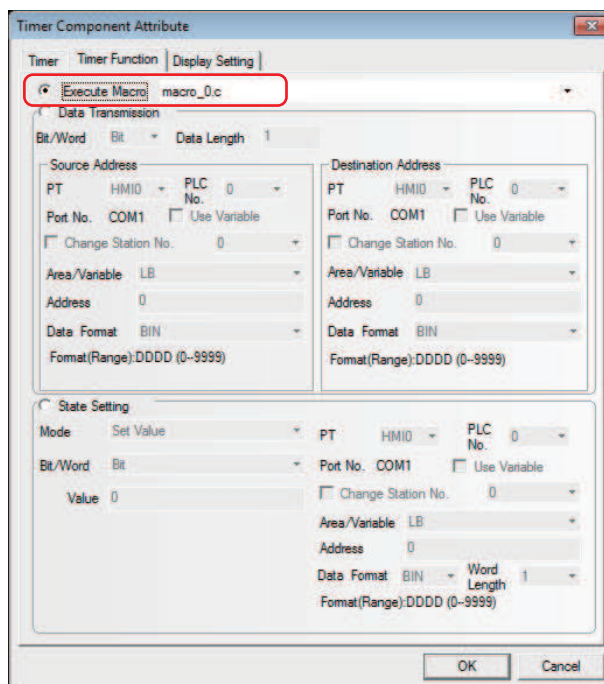

Method 4: [PLC Control] → [Execute Macro]: The execution of the macro is controlled by the PLC address.

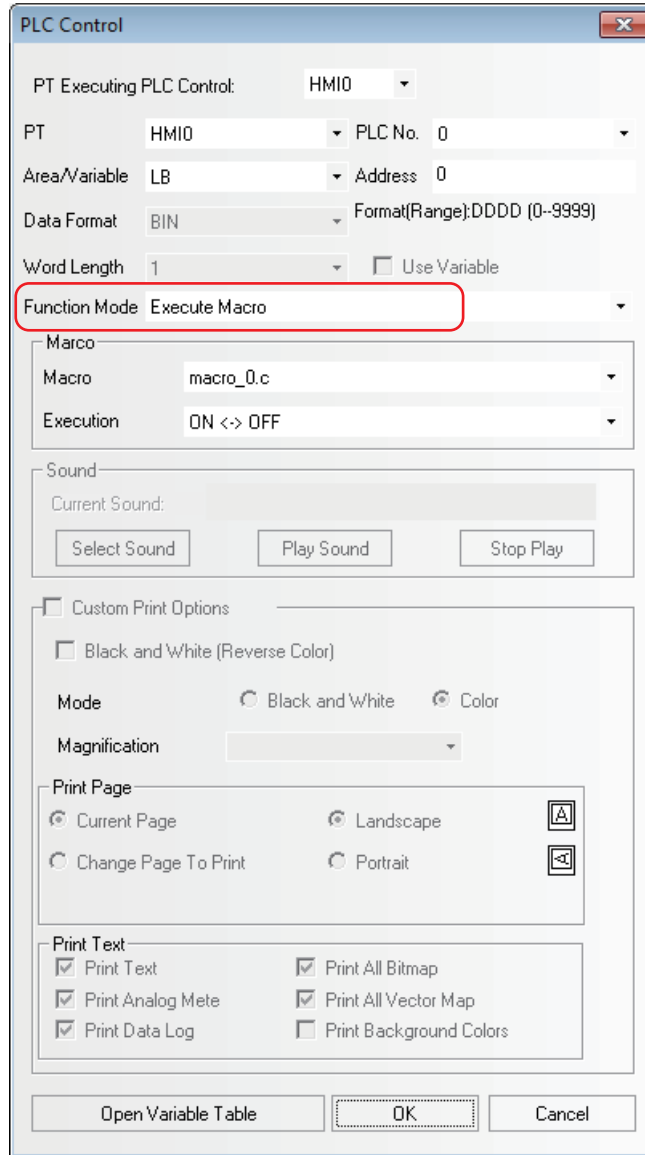

Method 5: Select [Event Setting] and check in the option of [Execute Macro] in the dialog box: the macro is triggered and executed by events, and when the set event condition is satisfied, the macro is executed.

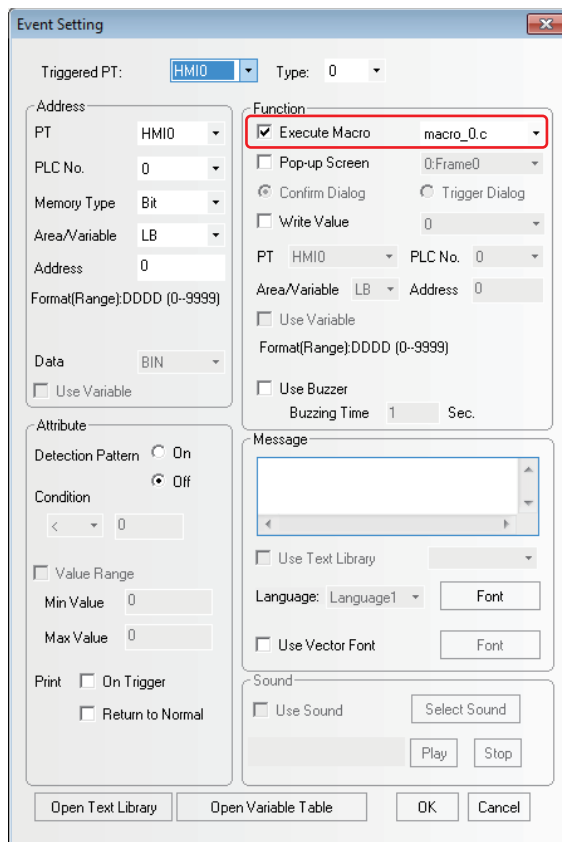

**30** What formats of pictures does NB-Designer support, and how to import these pictures  
The formats of pictures that can be imported include: “.JPG”, “.GIF”, “.BMP” and “.PNG”.  
**Import method:**

- (a) Create a new figure, and select “Bitmap”

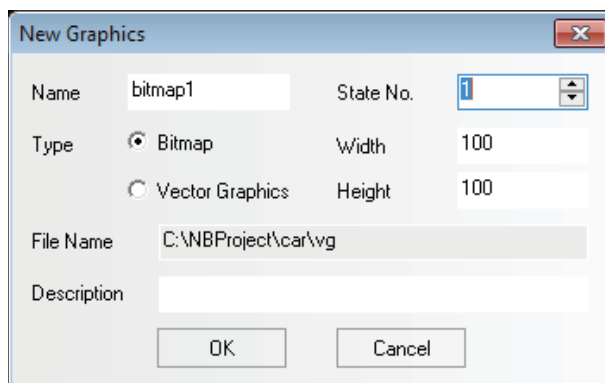

(b) In the dialogue box that pops up, right-click “Load Graphic”.

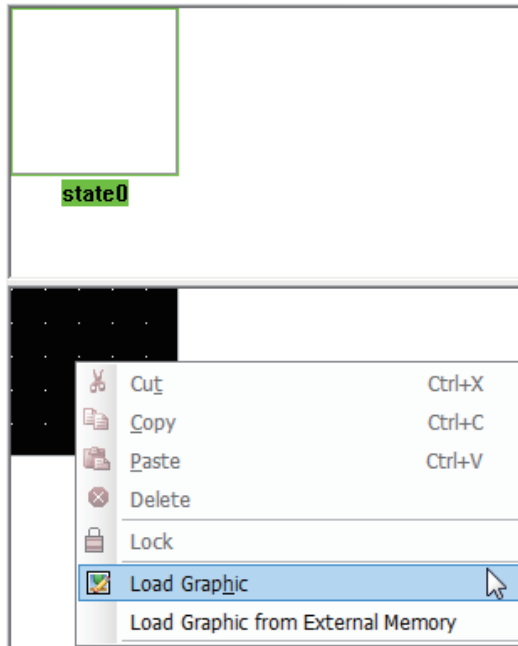

(c) Choose the picture to be imported

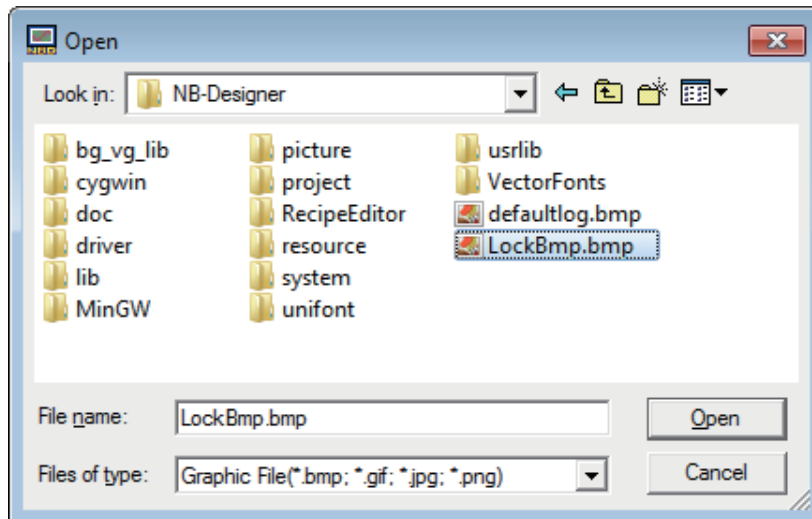

(d) After a successful import, the imported picture can be used in programs

**31** How to restrict programs in the PT from being uploaded

In [PT Property] → [PT Extended Property] → [Allow Upload], set a password to achieve this purpose, as shown below:

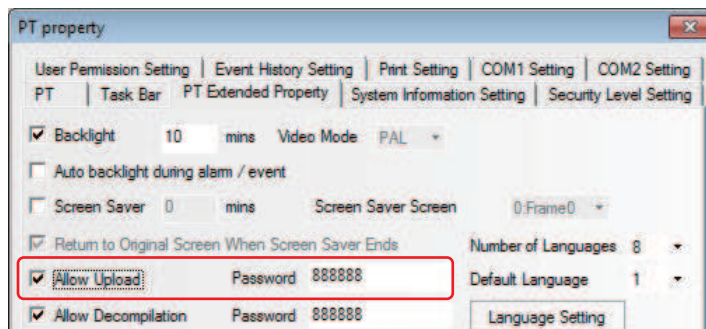



After a password is set, the password needs to be entered correctly to carry out uploading, or not, the uploading cannot proceed; you can disable uploading completely by deselecting [Allow Upload]. If [Allow Decompilation] is selected and a password is set, the correct password is required to be entered to proceed with decompilation. If [Allow Decompilation] is deselected, decompilation cannot be performed even after a project is uploaded.

Note that if the project is large and decompilation is not required, then decompilation can be deselected to save the storage space of the PT.

### 32 How to mask system alarm information - PLC No Response

Place a [Bit Button Component] in the Common Sheet, with the address being LW.B 9296.2 and the setting type being [Set On when Screen Open].

### 33 How to mask system alarm information - Socket Connect Error

Place a [Bit Button Component] in the Common Sheet, with the address being LW.B 9296.4 and the setting type being [Set On when Screen Open].

### 34 How to achieve multi-language switch

Multi-language switch can be achieved through changing the value of the special memory LW9130. The default setting is: LW9130=0, with the corresponding language 1.

NB-Designer supports up to a maximum of 32 languages. The following is an example of Chinese - English switching:

LW9130=0: Language 1→Chinese

LW9130=1: Language 2→English

(a) Create a text in the text library, as shown below:

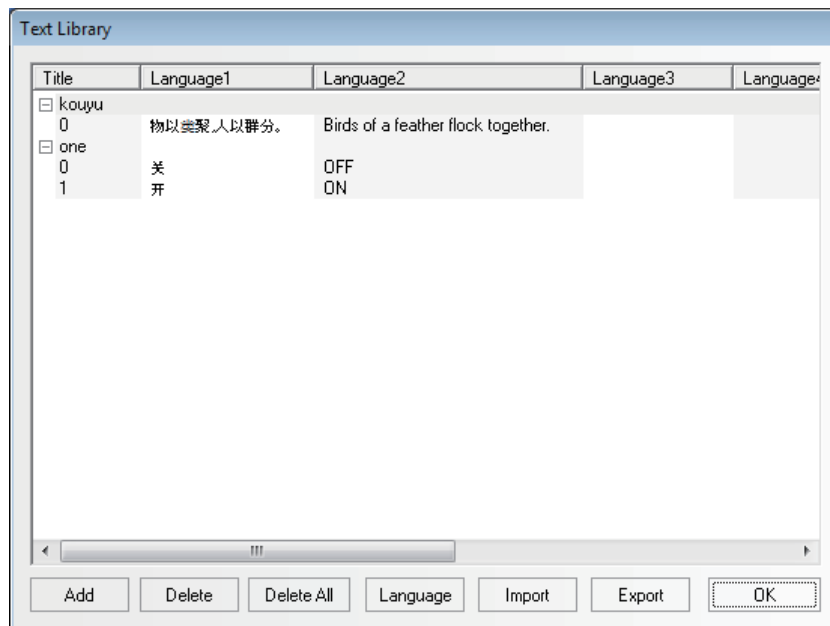

- (b) Add a [Bit Switch] and a static text on the screen, with the “Use Text Library” selected for labels, as shown below:

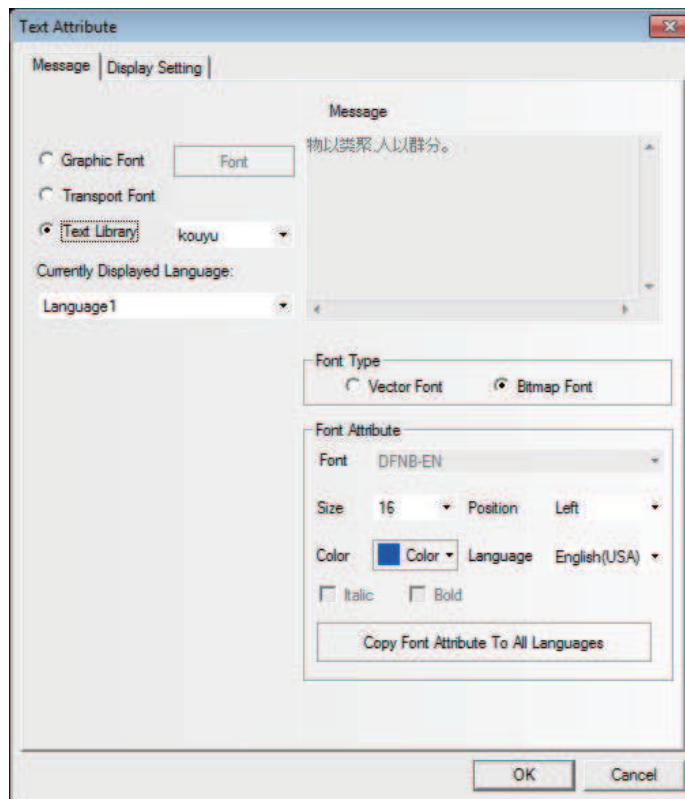
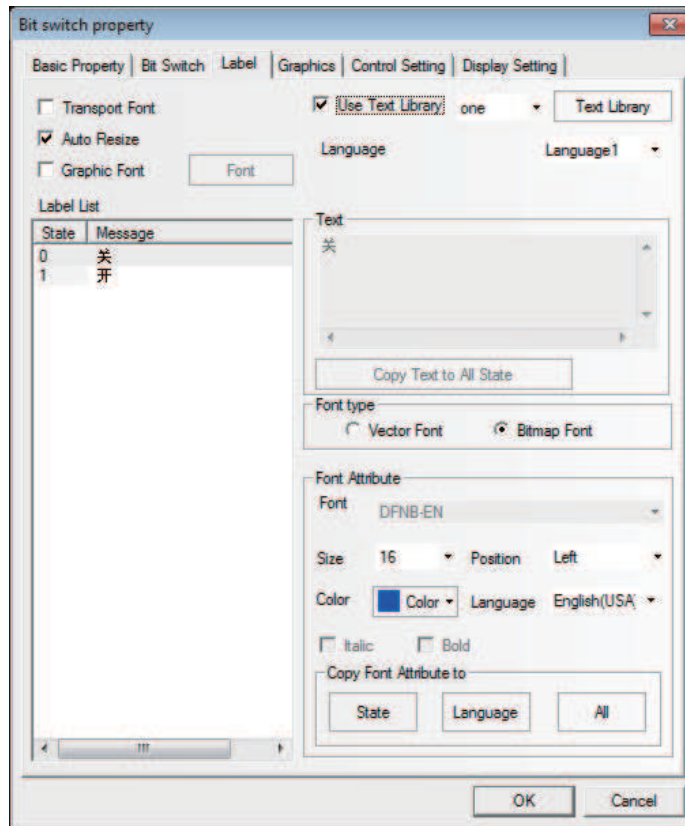

- (c) Add two Command Button Components on the screen, with both of the addresses being LW9130, the setting Mode being “Set Constant”, the values set to 0 and 1 (0: Chinese display, 1: English display); online language switching can be achieved by changing the value of LW9130.
- (d) When activating the “English” button, the screen will be displayed in English, and when activating the “Chinese” button, the screen will be displayed in Chinese, as shown below:

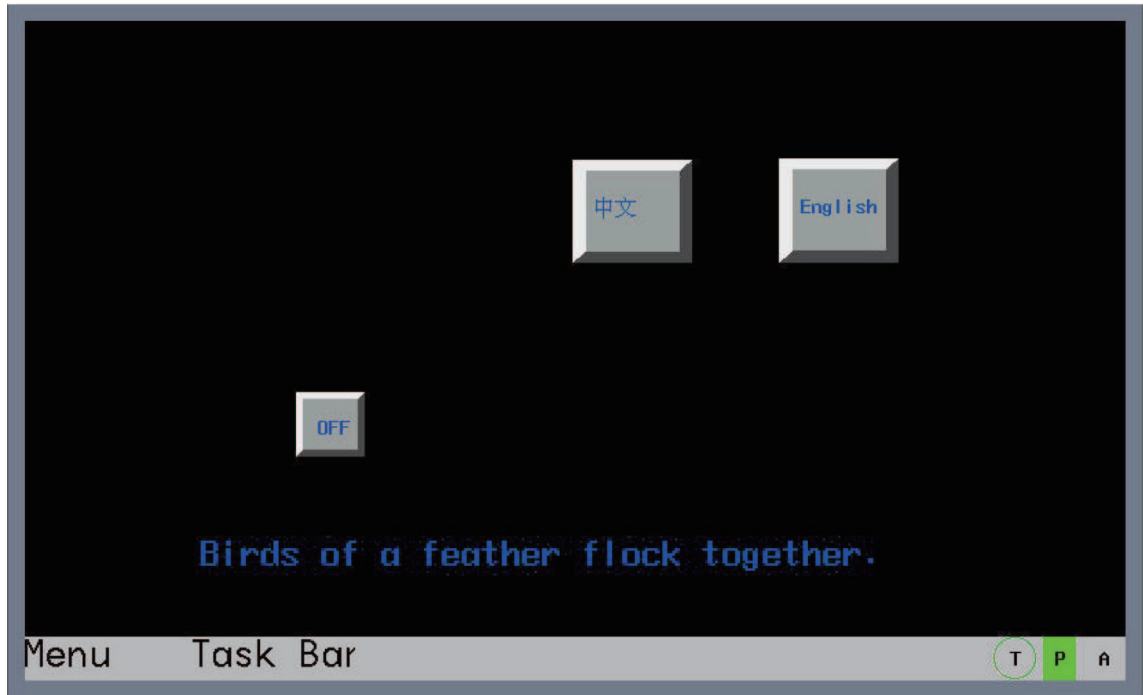

**35** How to do when the Pictbridge printing function cannot be used

- (a) Confirm the [Enable Print] option in the [Print Setting] tab in the [PT Property] dialog box is checked for the project.
- (b) Confirm the [Enable Printer Function] option in System Setting Mode in the NB Unit is checked.
- (c) The user must use the NB-Designer of version 1.22 or later to update the kernel and Rootfs of NB Unit when using the Pictbridge printing function for the first time.
- (d) Check the USB cable between the printer and PT is properly connected.
- (e) Restart the PT (Disconnect the USB cable → Restart → Connect the USB cable).
- (f) If the procedure (e) doesn't work, please restart the printer.
- (g) Check if LB9017 is set to ON. LB9017 is with shielding all printing requests as its functionality, i.e. when this bit is ON, the printing request will be ignored without calling out the Pictbridge, while printing will restore when this bit is OFF.
- (h) If the printing still doesn't work after all the above operations have been performed, please contact the supplier printed on the back cover.

**6-3-2 Communication-related Troubles****1** What if the communication between the PLC and PT fails

Many customers experienced communication problems between the PT and PLC when they used PT. As this happens, follow the procedures below to check what is going wrong.

- (a) Check whether the hardware connections are correct or not, especially whether the fabrication of the communication cable correct or not;
- (b) Check if the parameters such as the Baud Rate, Word Length, and PLC Station No. in [COM1 Setting] or [COM2 Setting] the tab of PT Property setting are set correctly, and make sure the PT serial port communication parameter settings are in consistent with that of the slave Unit;
- (c) Is the communication serial port selected correctly, for example, if COM1 is selected in software configuration, but COM2 is used actually, this would be considered wrong;
- (d) Use the serial programming cable of the PLC to download PLC programs, and make sure the downloading go smoothly. Exit the downloading mode and use the [Direct Online Test] function of the NB-Designer by clicking [Tools] → [Direct Online Test]. If the [Direct Online Test] communication fails, it is likely because the communication parameters of the PT and PLC are inconsistent. In this case, check the communication parameter settings of the PLC and PT;
- (e) If the [Direct Online Test] functions well, please confirm the connection of the communication cable (If it's the user who make the cable, please check whether the male and female pins are deployed in right correspondence, and whether there is false soldering.);
- (f) When the connection is realized by the Ethernet method, please check whether the IP address of PT and that of PLC are correct.
- (g) When the connection is realized by the Ethernet method, please confirm whether PLC supports MODBUS TCP protocol or UDP protocol.
- (h) If all turn right following the above procedures, but communications still will not work, please contact the supplier.

**2** Components cannot be displayed simultaneously after a page-turn, and in some cases, they turn up after a few seconds

This is probably due to a low communication speed. With respect to the solution, refer to [3. Why is the communication between the HMI and slave Unit slow and how to improve it].

### 3 Why is the communication between the HMI and slave Unit slow and how to improve it

#### The possible causes of a slow communication:

- (a) There are too many components on a single screen communicating with the slave Unit, and besides, the addresses are discontinuous;
- (b) The macro uses too many sentences which call addresses of the slave Units directly. It is recommended not to call addresses of the slave units directly in a macro program;
- (c) In the screens such as Common Sheet too many timers are deployed;
- (d) Too many background components such as Data Log, XY Graph and Data History are employed, and the background components are running all the time;
- (e) Alarm and Event Registration addresses are too many and discontinuous;
- (f) Too many PLC control components are used;
- (g) On-site Interference;
- (h) Too many vector font formats are used. Try not to use too many vector font formats in a project to the utmost;
- (i) Too many bitmaps are used;
- (j) Too many screens pop up, such as direct screens and indirect screens;
- (k) There are too many controllers communicating with the PT and too many communication addresses.

#### Solutions:

- (a) Components on a single screen communicating with the slave Unit should be as few as possible;
- (b) Try to keep the addresses of the components on a single screen communicating with the slave Unit continuous;
- (c) Try to use PT's internal addresses as variables for macro. If there is a need for exchanging data between the touch panel and slave Unit communication components, resort to the data transmission function of the timer or data transmission components;
- (d) Keep a minimum of number of channels of background components such as Data Log, XY Graph and Data History components, etc. and make sampling periods as long as possible;
- (e) Try to keep Alarm and Event Registration addresses continuous;
- (f) Do not use too many PLC control components;
- (g) Use a shielded cable for the communication cable. Keep it at least 10 CM away from power lines, and make sure the system is grounded properly;
- (h) Try to use less vector fonts and use bitmaps instead when creating screens. Even if you need to use vector fonts, use the vector fonts at minimum.

### 4 PLC No Response: what is the meaning of XX-XX-X

XX-XX-X means: PT number - PLC station number - PT serial port number. For example, 00-01-01 means the No.0 PT using the serial port COM1 loses communication connection to the controller with the station number 1.

The serial port number is defined as: 01/02 represent COM1/COM2.

### 5 The causes for a project downloading failure

#### Downloading through USB fails:

Check whether hardware connections are still functioning well or not, then check through the following factors

- (a) USB driver is not installed successfully.
- (b) USB driver has been corrupted. Find the driver at NB-Designer/driver and reinstall it;
- (c) The USB cable has been damaged, so replace it;
- (d) The USB port of the PT or the PC fails;

- (e) Electromagnetic interference may affect the USB cable. Make sure the system is grounded properly.
- (f) USB is assigned to the printing function together with “Enable Printer Function” being checked in the System Setting Mode. Please uncheck the “Enable Printer Function” option and restart the NB. (For details, refer to *Section 7 Pictbridge Printing in NB-Designer Operation Manual*.)

**Downloading in the serial mode fails:**

- (a) [Tools] menu → [Transmission Setting] → [COM] is selected.
- (b) Whether Port No. of the PC is correct;
- (c) The serial port is occupied or problems arise to the PC serial port;
- (d) The fabrication of the communication cable is incorrect or the bonding wire falls off;
- (e) The communications cable is plugged incorrectly, and it should be plugged to the COM1 port;
- (f) The serial port of the PT fails (The serial port does not support hot plug, so take care and avoid man-made damage).

**Downloading in the Ethernet mode fails:**

- (a) [Tools] menu -> [Transmission Setting] -> Whether [Ethernet] is selected.
- (b) [Tools] menu -> [Transmission Setting] -> Whether the IP address and port number are same as that in PT settings. In PT System Setting Mode, the network settings for PT Unit can be viewed. (For the operation method, please refer to the *NB Series Setup Manual (V107)*)
- (c) Confirm the IP addresses of the PC and the PT are set in the same network segment.

- 6** How to decide whether communications are normal or not through the internal addresses of the PT  
Decide Deciding which PLC is disconnected with through a bit;  
Serial port 2: LW9432-9447, 16 words are equivalent to 256 bits, with each bit corresponding to a PLC. No response = ON, Normal = OFF.  
See the following diagram:

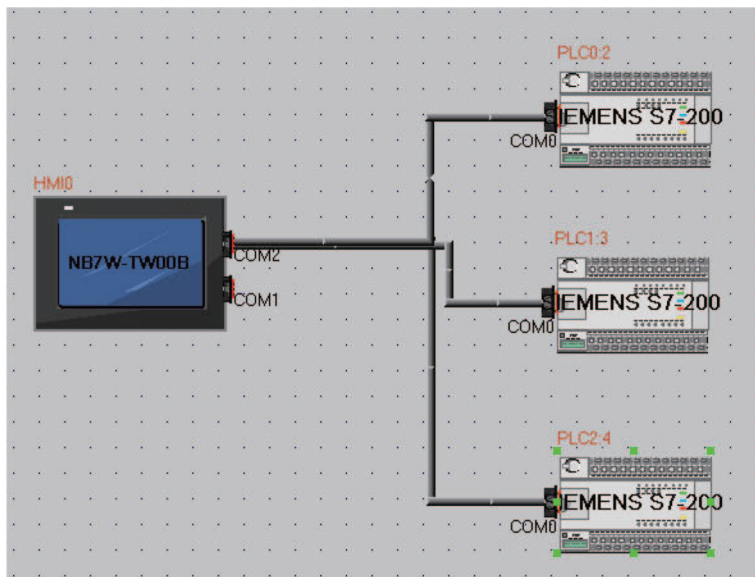

Assume that 3 S7-200 PLCs connect to the COM2 port of NB7W, the station numbers of which are 2, 3, 4 respectively; if the PLCs with the station numbers 2 and 4 fail communication, the internal registers LW.B9432.2 and LW.B9432.4 will turn ON automatically, as shown below:

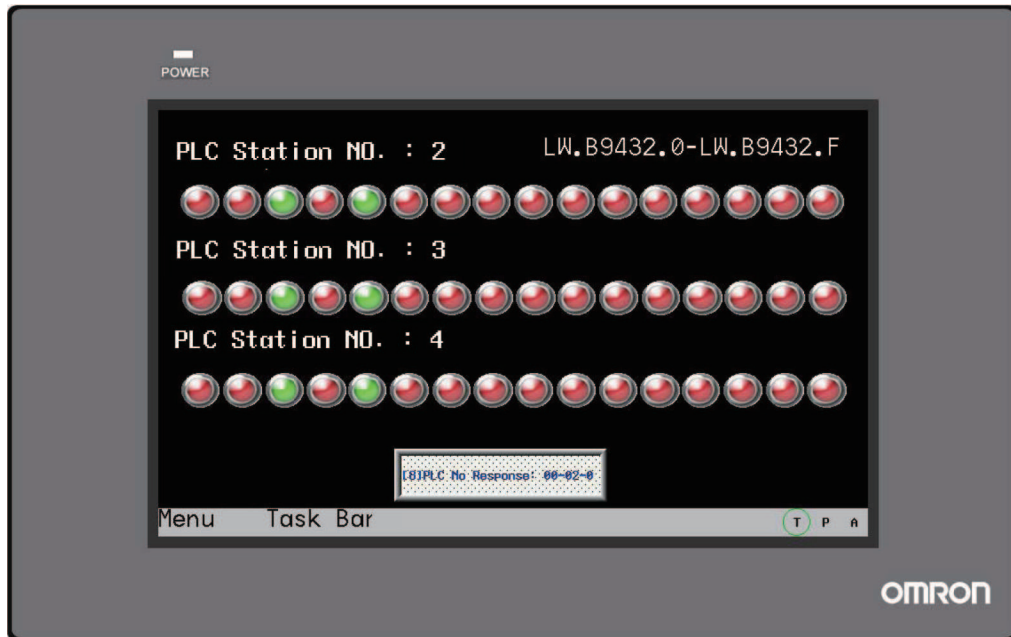

- 7** The communications of the PT and PLC are normal, but why are some numeric values are indicated as “\*\*\*\*\*”  
 When the data coming from registers communicating with the PLC exceeds the setting range of the Number Display or Number Input, “\*\*\*\*\*” will appear. It indicates an overflow of a numeric value. The user can set the integer bit digit number range of the Number Display or Number Input larger through NB-Designer to make numeric value display normal. For example, change the integer bit digit number from 3 to 4.
- 8** Why is the speed of PT operation becoming slow after macro is executed
- When writing code of macro, if a large of number of address variables of the PLC or slave Unit are defined, the execution speed of the PT may suffer. When executing a macro program, the processor picks up the variable addresses defined first, executes the macro, then carries out output. If the macro is executed at a high frequency, a large amount of time is used to perform communication with the slave Unit, thus affecting the execution speed of the PT as a whole.
  - It is because the variable in macro code has used the PLC address. The user can realize the communication and make the macro executed normally by setting the special register LW9535 (time magnification during the communication by PLC variables for macro with its default of 0) to extend the wait time. If the macro cannot executed normally, it is recommended the user to set LW9535 to “2 or above”.

### 6-3-3 Hardware Troubles

#### 1 How to calibrate the system time of the PT

There are 2 methods to calibrate the time:

Method 1: there are 2 DIP switches on the backside of the PT. Tweak both of the DIP switches 1 and 2 to ON, reboot the PT, then the Setup Screen turns up, as shown below: (take NB5Q-TW00B as an example)

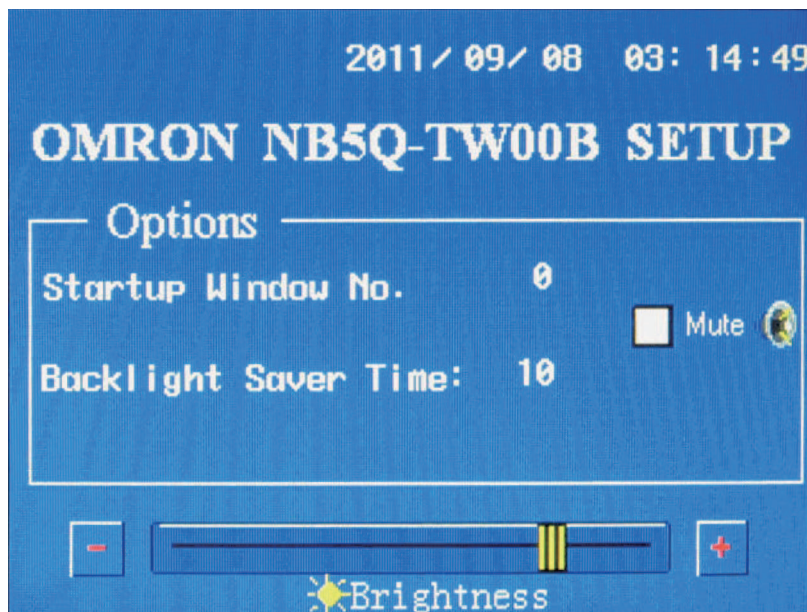

Click the time component, input the current time.

Method 2: Create a new project, and place 7 Number Input components on the screen, with each of the addresses LW10000~LW10006 respectively corresponding to the Second, Minute, Hour, Day, Month, Year and Week. The time can thus be calibrated through changing the values of these 6 Number Input components.

#### 2 The time cannot be saved or the display is not accurate

If the time cannot be saved, the most likely cause is that the battery runs low. When the PT is disconnected from the power supply, the RTC needs to be energized by the battery on the PT mainboard. When the battery voltage descends to an unsustainably low level, it may cause that the time cannot be saved or the display is not accurate, therefore requiring the Unit to be sent back to replace.

#### 3 Why is there no response from touch-control

When operating the touch panel, if clicking a component on the screen does not receive a proper response, the first thing you have to do is to make sure that this button is indeed operable. If it is confirmed, the problem may result from a touch-control shift. The touch panel is a panel of 4-wire precision resistors, and because the resistors are subject to impacts from temperature, humidity and also their own characteristics, it's recommended that touch-control calibration be carried out yearly.

Calibration method: tweak the DIP switches on the backside of the PT, SW1 to OFF, SW2 to ON, and restart the PT. A "+" will appear on the screen. Click it, the "+" will shift after the PT responds. You have to click again and after a total of 5 consecutive clicks, the PT will prompt you whether the calibration is a success. If it is a success, the PT will skip to the user program screen, while if it is not a success, the "+" will pop up again, requiring another round of calibration.

**Note** After a successful calibration, the DIP switch 2 needs to be set back to OFF, or not, the system will prompt you for a calibration every time you turn on the power supply.



#### 4 Why is the PT touch-control not responding or being slow to respond

**The likely causes are as follows:**

- (a) The communications are abnormal, and when this happens, the touch-control may not respond;
- (b) The touch-control shifts, and change of the operation environment or the touch panel characteristics may cause the touch-control to be unable to respond;
- (c) The touch panel may be damaged or the touch-control circuit may be suffered of a poor contact;

**Solutions:**

- (a) Resolve the communication problem;
- (b) Try out a touch-control calibration;
- (c) Please contact the supplier printed on the back cover.

#### 5 Why does the PT screen dim or without backlight

The screens we normally see on a PT are displayed in liquid crystal. However, the liquid crystal itself does not give out light, so it is usually used together with a light source, and so far, the most commonly used light-emitting equipments for industrial PT products are of CCFL or LED backlight. The NB-Series touch panel employs LED backlight.

LED backlight: LED, (i.e. Lighting Emitting Diode), is a kind of semiconductor solid light-emitting device. It uses solid semiconductor chips as the light-emitting material. Surplus energy breaks out during the process of combination of charge carriers in the semiconductor, triggering photon emissions, and this is used to display various kinds of information, such as characters, graphics, images, animations, texts, videos and video signals on display panels. The generally used LED backlight is made up of an array, e.g. an array of 3×4 with a total of 12 LEDs, and if one or even more LEDs are not working normally, the screen will dim. When none of the LEDs is working normally, the screen will have no backlight.

**The possible causes for a black screen are as follows:**

- (a) The power supply to the PT is abnormal;
- (b) The PT enters the screen saver (backlight saver) mode;
- (c) Control backlight OFF is set through the PLC Control Component;
- (d) Backlight broken or the LCD panel is damaged.

**Solutions:**

- (a) Check the power supply to the PT, use a multimeter to measure whether the voltage is within the normal range or whether the output power is too low;
- (b) Click the PT screen to exit the screen saver mode;
- (c) Check whether control backlight OFF is set through the PLC Control Component in the PT program;
- (d) Please contact the supplier printed on the back cover.

#### 6 PT white screen and flickering screen

The causes of a white screen or a flickering screen: the ambient temperature exceeds the range specified on the PT nameplate, or the liquid crystal is damaged.

Solutions: Check the ambient temperature and compare it with that specified on the PT, or please contact the supplier printed on the back cover.

#### 7 The serial port gets heated when the PT communicates with other devices

Check the grounding of the PT and other communication devices. If the grounding is not shared, there is a possible significant voltage difference between the devices, leading to a heavy current, thus causing a heated serial port.

### 6-3-4 Errors occurred when the UDP communications with OMRON PLC

- 1** What consequences will occur if the same IP address is used for two PLCs  
The user should avoid such kind of setting. If it occurs, NB may receive the information from one PLC at a moment while receive the information from the other PLC at the next moment.
- 2** What consequences will occur if the same Node ID is used for two PLCs  
The user should avoid such kind of setting.  
If two PLCs have the same Node ID but different IP address, NB can only connect with the one that is set in the NB-Designer.  
If two PLCs have the same Node ID and IP address, NB may receive the information from one PLC at a moment while receive the information from the other PLC at the next moment.
- 3** What will happen if the NB is connected with PLCs more than 32 units  
No errors occur in NB, but the NB does not respond to the PLC which is not set for NB.

### 6-3-5 Other Troubles

- 1** During Direct Online Test, the internal data of the PLC is readable, but not alterable  
Check whether the internal storage addresses of the PLC is writable or not. If the address is read only, the storage data cannot be changed. then check whether the communication cable is normal or not.
- 2** What is the difference between the USB Host and Slave ports  
USB Slave port is used for downloading/uploading data, executing functions related to the NB-Designer and connecting printers using Pictbridge protocol, and not for communicating with the slave Units. USB Host port can be connected with a USB flash disk to perform the uploading, downloading, project operation and storage of related data. According to the appearance, the Slave port is customarily called [Square port], while like the USB port on a PC, the Host port is customarily called [Flat port]. The USB Slave port is as shown below:

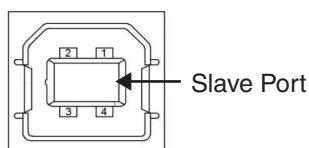

**3** What influences do on-site interferences have on the PT, and what are the countermeasures  
On an industrial site, various kinds of interferences will be encountered inevitably. Interferences may cause the following troubles for the touch panel.

- (a) A small information window displaying “PLC NO RESPONSE” appears intermittently;
- (b) Communications with the PT breaks off, whenever an inverter, motor, transformer or some other equipment alike starts;
- (c) The PT crashes;
- (d) The touch-control of the PT becomes slow to respond.

The interference issue is a rather complicated one, and the commonly used methods for handling this issue include:

- (a) Anti-strong-electricity-interference - Keep weak electricity cables such as communication cables, signal cables and control cables away from strong electricity, and do not lay them parallel with strong electricity cables. If possible, wire them through iron tubes, and if the cable duct is multilayered, lay the weak electricity cables below the strong electricity ones.
- (b) Anti-inner-cabinet-interference - It's recommended that the alternating current cables and the direct current cables be laid in separate channels, and if laid in the same channel, the weak electricity cables and the strong electricity ones need to be bundled separately, and be kept as far away as possible.
- (c) Anti-inverter-interference - Connect a filter to the power-supply side of the inverter, and shroud it with a metal casing.
- (d) Every equipment needs to be grounded properly.
- (e) Use a separate switching power supply for the PT.

## 6-4 Unit Replacement Precautions

---

When the Unit should be replaced for the defectiveness found during the checking, please pay attentions to the following points:

- Perform backup of the screen data of NB Unit in advance.
- The screen data may be deleted when the Unit is repaired by our company.
- Be sure to turn OFF the power supply before the replacement.
- After the replacement, please confirm whether the abnormality still exists or not.
- When the defect device is returned for repair, please attach the paper with the detailed description of the problem to the Unit, and contact the supplier printed on the back cover.

# Revision History

A manual revision code appears as a suffix to the catalog number on the front cover of the manual.

Cat. No. V109-E1-□



Revision code	Date	Revised content
01	October 2011	Original production
02	February 2012	<ul style="list-style-type: none"> <li>• Added PLC settings in [communication setting] of [4-3 Creating Project].</li> <li>• Added create macro detail in [creating macro] of [4-3 Creating Project].</li> <li>• Added create vector graph detail in [creating vector graphics] of [4-3 Creating Project].</li> <li>• Modify contents of [4-4 Screen creation]</li> <li>• Modify illustration of [HMI Attribute]</li> <li>• Modify contents of [4-6 Save and Load Project]</li> </ul>
03	April 2012	<ul style="list-style-type: none"> <li>• Added the descriptions of NB5Q/NB7W-TW01B.</li> <li>• Added the descriptions of Ethernet connection and the storage of USB disk.</li> </ul>
04	August 2012	<ul style="list-style-type: none"> <li>• Added the descriptions of NB3Q-TW00B/TW01B and NB10W-TW01B.</li> </ul>
05	December 2012	<ul style="list-style-type: none"> <li>• Correction related to the backlight lamp, rubber packing and battery maintenance.</li> <li>• Added the descriptions of Pictbridge printing function.</li> </ul>
06	December 2012	<ul style="list-style-type: none"> <li>• Adding descriptions of the power supply and wire connection in Precautions for Safe Use.</li> </ul>
07	April 2013	<ul style="list-style-type: none"> <li>• Changes and corrections</li> </ul>





**OMRON Corporation Industrial Automation Company**

Tokyo, JAPAN

Contact: [www.ia.omron.com](http://www.ia.omron.com)

**Regional Headquarters**

**OMRON EUROPE B.V.**

Wegalaan 67-69-2132 JD Hoofddorp  
The Netherlands

Tel: (31)2356-81-300/Fax: (31)2356-81-388

**OMRON ASIA PACIFIC PTE. LTD.**

No. 438A Alexandra Road # 05-05/08 (Lobby 2),  
Alexandra Technopark,  
Singapore 119967

Tel: (65) 6835-3011/Fax: (65) 6835-2711

**OMRON ELECTRONICS LLC**

One Commerce Drive Schaumburg,  
IL 60173-5302 U.S.A.

Tel: (1) 847-843-7900/Fax: (1) 847-843-7787

**OMRON (CHINA) CO., LTD.**

Room 2211, Bank of China Tower,  
200 Yin Cheng Zhong Road,  
PuDong New Area, Shanghai, 200120, China

Tel: (86) 21-5037-2222/Fax: (86) 21-5037-2200

**Authorized Distributor:**

© OMRON Corporation 2011 All Rights Reserved.  
In the interest of product improvement,  
specifications are subject to change without notice.

**Cat. No. V109-E1-07**

0413