

Reflectors for photoelectric sensors

E39-R

The E39-R series of reflectors for photoelectric sensors features a wide range of models with different sizes, shapes, mounting types and materials. The reflectors provide high accuracy, reflectivity and lifetime for standard applications as well as for challenging environments.











- Standard reflectors with different sizes and shapes
- Detergent and heat resistant reflectors
- Screw mounting, snap-in or self-adhesive types

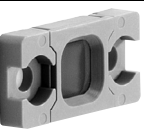











Ordering information

Shape	Type	Housing material	Features	Size in mm	Applicable Sensor	Order code
	General purpose reflectors	ABS base Acrylic surface	Surface screw mounting (diagonal holes)	40×60×7.5	Retro-reflective photoelectric sensors – without M.S.R Retro-reflective photoelectric sensors – with M.S.R.*1	E39-R1S
			Surface screw mounting (holes on one side only)	35.4×42.3×8		E39-R9
				51.4×60.3×8.5		E39-R42
	Small size		Side screw mounting or surface selfadhesive	41.8×22.5×11		E39-R3
				23×13.7×4.9		E39-R4
	Large size		Surface screw mounting			100×100×9
				84.5×84.5×8.7	E39-R40	

*1 Mirror Surface Rejection (MSR) is realized by using polarization filters

Shape	Type	Housing material	Features	Size in mm	Applicable Sensor	Order code
	High precision	ABS base Acrylic surface	Microtripel for improved performance with fine beam sensors	52×40×4.8	Recommended for fine beam coaxial models (E3C-LR, E3Z-LR, E3T-SR4)	E39-R6
				30×45		E39-R12
				14×23×1		E39-R37-CA
				12×24		E39-R13
	Simple mounting	ABS base Acrylic surface	Round shape with centered mounting hole for simple screw mounting	Diameter: 84 Depth: 7.4	Photoelectric sensors with and without M.S.R. ^{*1}	E39-R7
	Snap mounting		Snap mounting for fast installation	Diameter: 30 Diameter of snap mount tool: 5		Recommended for snap mounting sensor E3FZ
	Enhanced detergent resistance	PVC	Surface screw mounting IP69k after DIN 40050 part 9	40×60×7.5	Recommended for harsh environment sensors	E39-R50
				20×60×6		E39-R51
	Highest detergent resistance	SUS316L Borosilicat	Surface screw mounting	43×30×5		E39-R16
	Heat resistant	Borosilicat	Surface screw mounting 450°C heat resistance Suitable for vacuum environment	95×51×8		E39-R47
	Non-fogging reflector	ABS Acrylic surface	Anti-fogging coating	40×60×7.5		E39-R1K

*1 Mirror Surface Rejection (MSR) is realized by using polarization filters

Shape	Type	Housing material	Features	Size in mm	Applicable Sensor	Order code	
	Special polarizing	ABS base PMMA surface	Special polarizing filter to PET	40×80×8.5	E3ZM-B	E39-RP1	
	General purpose tape reflectors	Acrylic	Self adhesive Pre cut	35×10×0.7	Photoelectric sensors with and without M.S.R.*1	E39-RS1	
				40×35×0.7		Optimised for E3T-SR4	E39-RS1-CA
				80×70×0.6			E39-RS2
				25 mm × 5 m		Optimised for E3T-SR4	E39-RS2-CA
				25 mm × 22.8 m			E39-RS3
				50 mm × 5 m		Optimised for E3T-SR4	E39-RS3-CA
				50 mm × 22.8 m			E39-RS25 5 m
							E39-RS25 22.8 m
	High precision tape reflectors		Self adhesive Pre cut	195×22	Recommended for fine beam and laser sensors (E3Z-LR, E3C, E3X)	E39-RS4	
				108×46		E39-RS5	

*1 Mirror Surface Rejection (MSR) is realized by using polarization filters

Dimensions

E39-R1S
E39-R1K *



Material, reflective surface: acrylic
Rear surface: ABS

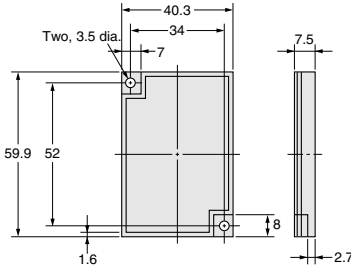

*E39-R1 only
Coating on reflective surface

E39-R9



Material, reflective surface: acrylic
Rear surface: ABS

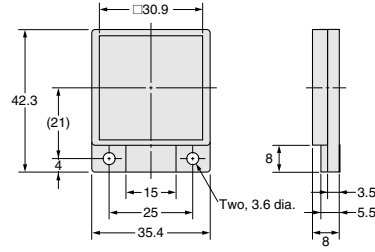

E39-R42

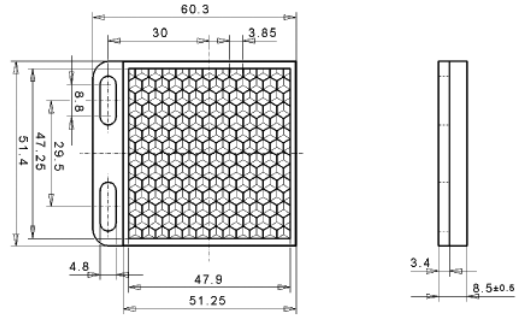

E39-R7

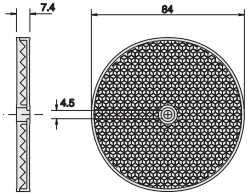

E39-R40

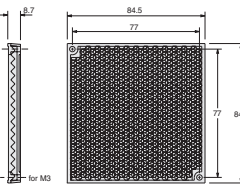
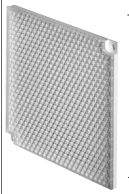

E39-R8

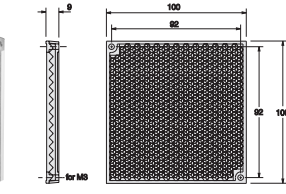

E39-R3

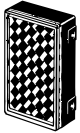

Material, reflective surface: acrylic
Rear surface: ABS

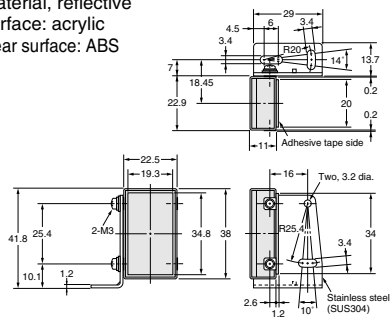

E39-R4



Material:
Reflective surface: acrylic
Rear surface: ABS

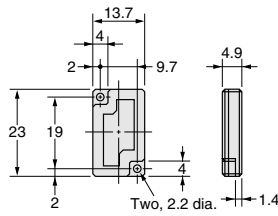

E39-R6

Material, reflective surface: acrylic
Rear surface: ABS

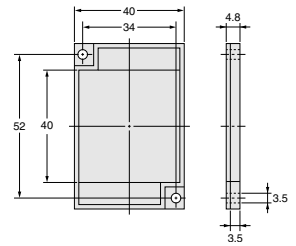
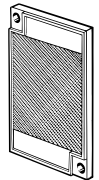

E39-R37-CA

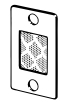

Material:
Mounting plate: stainless steel (SUS301)
Reflective surface: acrylic

Note: The reflective plate and mounting plate (1) come as a set.

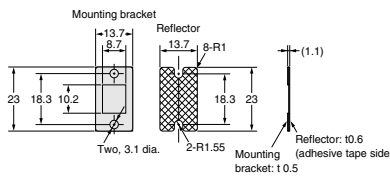

E39-R12/-R14

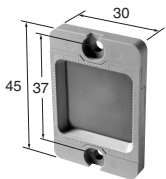

E39-R13

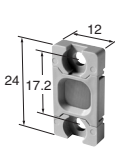

E39-RP1

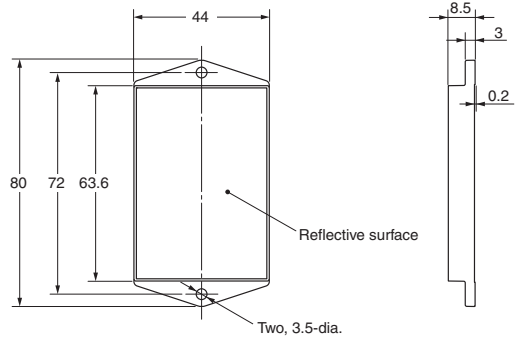

Read and Understand This Catalog

Please read and understand this catalog before purchasing the products. Please consult your OMRON representative if you have any questions or comments.

Warranty and Limitations of Liability

WARRANTY

OMRON's exclusive warranty is that the products are free from defects in materials and workmanship for a period of one year (or other period if specified) from date of sale by OMRON.

OMRON MAKES NO WARRANTY OR REPRESENTATION, EXPRESS OR IMPLIED, REGARDING NON-INFRINGEMENT, MERCHANTABILITY, OR FITNESS FOR PARTICULAR PURPOSE OF THE PRODUCTS. ANY BUYER OR USER ACKNOWLEDGES THAT THE BUYER OR USER ALONE HAS DETERMINED THAT THE PRODUCTS WILL SUITABLY MEET THE REQUIREMENTS OF THEIR INTENDED USE. OMRON DISCLAIMS ALL OTHER WARRANTIES, EXPRESS OR IMPLIED.

LIMITATIONS OF LIABILITY

OMRON SHALL NOT BE RESPONSIBLE FOR SPECIAL, INDIRECT, OR CONSEQUENTIAL DAMAGES, LOSS OF PROFITS OR COMMERCIAL LOSS IN ANY WAY CONNECTED WITH THE PRODUCTS, WHETHER SUCH CLAIM IS BASED ON CONTRACT, WARRANTY, NEGLIGENCE, OR STRICT LIABILITY.

In no event shall the responsibility of OMRON for any act exceed the individual price of the product on which liability is asserted.

IN NO EVENT SHALL OMRON BE RESPONSIBLE FOR WARRANTY, REPAIR, OR OTHER CLAIMS REGARDING THE PRODUCTS UNLESS OMRON'S ANALYSIS CONFIRMS THAT THE PRODUCTS WERE PROPERLY HANDLED, STORED, INSTALLED, AND MAINTAINED AND NOT SUBJECT TO CONTAMINATION, ABUSE, MISUSE, OR INAPPROPRIATE MODIFICATION OR REPAIR.

Application Considerations

SUITABILITY FOR USE

OMRON shall not be responsible for conformity with any standards, codes, or regulations that apply to the combination of products in the customer's application or use of the products.

At the customer's request, OMRON will provide applicable third party certification documents identifying ratings and limitations of use that apply to the products. This information by itself is not sufficient for a complete determination of the suitability of the products in combination with the end product, machine, system, or other application or use.

The following are some examples of applications for which particular attention must be given. This is not intended to be an exhaustive list of all possible uses of the products, nor is it intended to imply that the uses listed may be suitable for the products:

- Outdoor use, uses involving potential chemical contamination or electrical interference, or conditions or uses not described in this catalog.
- Nuclear energy control systems, combustion systems, railroad systems, aviation systems, medical equipment, amusement machines, vehicles, safety equipment, and installations subject to separate industry or government regulations.
- Systems, machines, and equipment that could present a risk to life or property.

Please know and observe all prohibitions of use applicable to the products.

NEVER USE THE PRODUCTS FOR AN APPLICATION INVOLVING SERIOUS RISK TO LIFE OR PROPERTY WITHOUT ENSURING THAT THE SYSTEM AS A WHOLE HAS BEEN DESIGNED TO ADDRESS THE RISKS, AND THAT THE OMRON PRODUCTS ARE PROPERLY RATED AND INSTALLED FOR THE INTENDED USE WITHIN THE OVERALL EQUIPMENT OR SYSTEM.

PROGRAMMABLE PRODUCTS

OMRON shall not be responsible for the user's programming of a programmable product, or any consequence thereof.

Disclaimers

CHANGE IN SPECIFICATIONS

Product specifications and accessories may be changed at any time based on improvements and other reasons.

It is our practice to change model numbers when published ratings or features are changed, or when significant construction changes are made. However, some specifications of the products may be changed without any notice. When in doubt, special model numbers may be assigned to fix or establish key specifications for your application on your request. Please consult with your OMRON representative at any time to confirm actual specifications of purchased products.

DIMENSIONS AND WEIGHTS

Dimensions and weights are nominal and are not to be used for manufacturing purposes, even when tolerances are shown.

PERFORMANCE DATA

Performance data given in this catalog is provided as a guide for the user in determining suitability and does not constitute a warranty. It may represent the result of OMRON's test conditions, and the users must correlate it to actual application requirements. Actual performance is subject to the OMRON Warranty and Limitations of Liability.

ERRORS AND OMISSIONS

The information in this document has been carefully checked and is believed to be accurate; however, no responsibility is assumed for clerical, typographical, or proofreading errors, or omissions.

Cat. No. E90E-EN-01

In the interest of product improvement, specifications are subject to change without notice.

OMRON EUROPE B.V.

Wegalaan 67-69,
NL-2132 JD, Hoofddorp,
The Netherlands
Phone: +31 23 568 13 00
Fax: +31 23 568 13 88
www.industrial.omron.eu