



Product Information

Industrial Safety Systems
Safety light curtains –
cost-effective solutions worldwide.

SICK



Is it possible
for man and
machine
to co-operate
safely?

Sure.

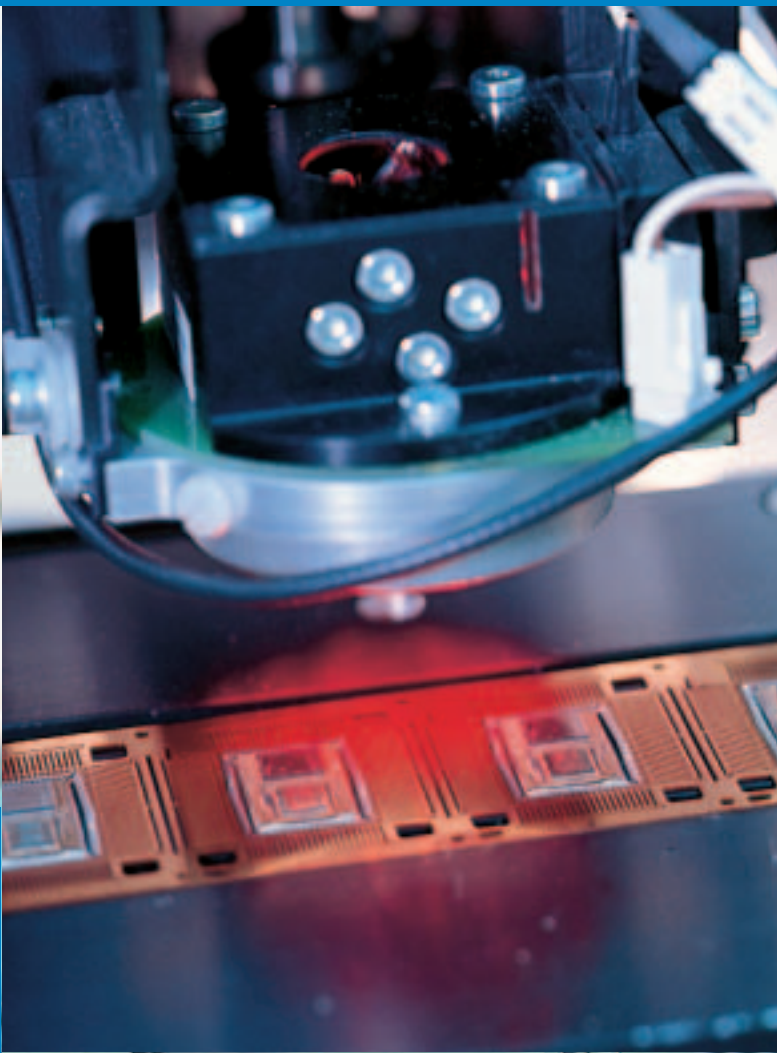

- ▶ Increasing system productivity
- ▶ Optimising cost structures
- ▶ Increasing availability
- ▶ Reducing time-to-market
- ▶ Securing the future



Industrial safety needs more than just technology.

Superior quality

With the decision for a safety solution from SICK, you are not just selecting uncompromising state-of-the-art technology. You acquire much more: Quality that covers the whole process from consultation through commissioning to after-sales service.

Straightforward integration

SICK stands for standardised integration in all automation environments: from the relay through safe controls to fieldbus. Problem-free due to uniform CDS user interface for all programmable SICK safety products.

Solutions that generate sustainable added value.

How is it possible to maintain one's position in the industrial safety world after 5 decades at the top?

By means of safety solutions that support your success.

By means of innovative sensor solutions for all important sectors and applications.

By means of product development and services that address all requirements.

We give you the safety that you need every day.



Is the system safe?
Hazard potential?
Safety distances?
Access protection?
Area protection?
Hand protection?
Finger protection?
Safety category?

Complete know-how

Knowledge of the specific requirements in a sector is the prerequisite for productive solutions. With our application support, you can benefit from our wealth of experience, without this support you would have to build up this know-how.

Comprehensive service

Value-added service. We place the emphasis on more: Services throughout the entire life cycle of a system. Support during planning, commissioning, maintenance and training.

Contents

C 4000 family	06
C 4000 applications	08
C 4000 cost effectiveness analysis	10
Application examples for light curtains	12
Product overview light curtains	20
Industrial Safety Management	22
Industrial Safety Systems	24



Effective protection for personnel and machines – SICK offers a comprehensive solution regardless of the task you want to solve. A wide range of safety light curtains are the prerequisite for productive plant operation.

SICK is one of the world's leading producers of safety systems. Our success is the result of innovative products, well-founded expertise and close contacts with our customers in all branches.

Up to date safety.
Light curtains in the
C 4000 product family.



Cost-effective

Only invest in what you actually need.



We make the connection to diverse automation environments.



System and user advantages

- ▶ Cost-effective solutions due to leading technology
- ▶ Cost-saving complete systems with integrated functions for a wide range of requirements
- ▶ High availability due to sensors immune to interference
- ▶ Reduced engineering and stockholding costs due to universal interface
- ▶ Short delivery times due to worldwide presence



Exploit complete solution competence from the No. 1.

Safety and productivity go hand-in-hand. With the widest product range in the market and specific application know-how, SICK is able to offer you tailor-made solutions.

Impressive solutions

System and user advantages

- ▶ Shorter setup times, increased availability
- ▶ User-friendly due to integrated functions
- ▶ Cost-saving due to
 - Removal of additional components
 - Simpler wiring
- ▶ More space in the control cabinet

Control switches can be connected directly to the device. As a result an additional reset/emergency stop button module is not necessary and the wiring effort is reduced.

Increased flexibility due to integrated functions. A hand, for example, is reliably detected while material is blanked.

Space saving due to removal of additional evaluation devices.

Rapid commissioning due to integrated alignment aid per sensor pair.

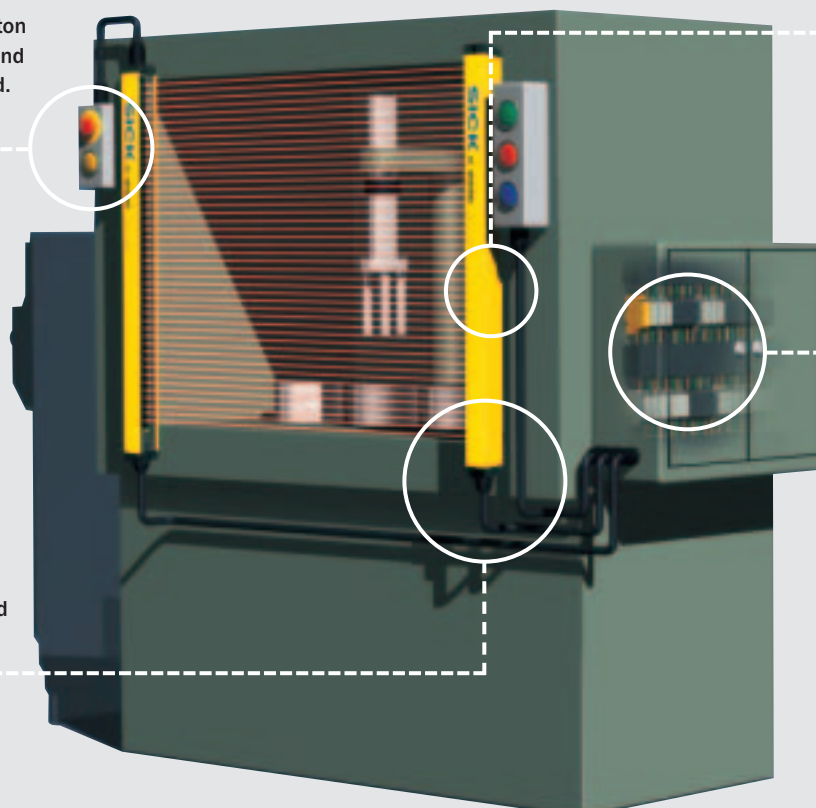



Teach-in blanking: Rapid reading of blanking areas at the push of a button shortens setup times and increases availability.

Fixed blanking means that objects can be present permanently in the protective field.

Fixed blanking with "increased size tolerance" enables material to be transported up to the size defined.

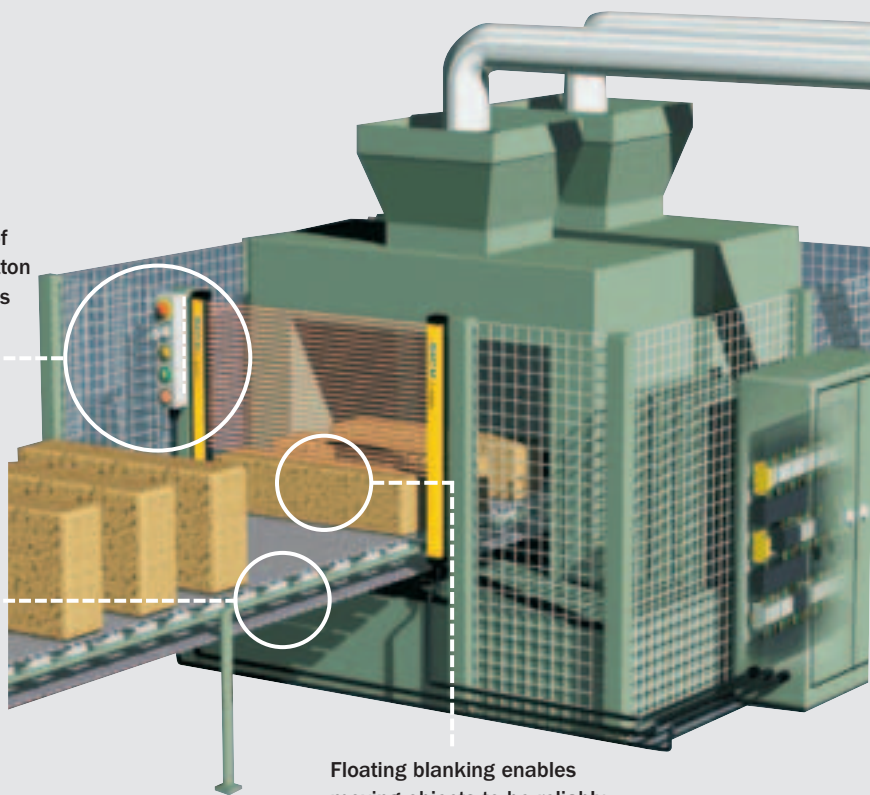

Floating blanking enables moving objects to be reliably detected.

Rapid commissioning due to:

CDS user software

- Easier configuration, display of information and analysis
- Faster detection of problems by means of display of information on bus master, independent of location

Plug & Play

- Pre-configured device parameters
- Customer-specific presettings available from the factory
- Commissioning can be performed without a PC



Greater efficiency, lower safety costs.

Innovative safety technology helps to save money. Reduced control cabinet requirements, reduced stockholding costs and less wiring effort along with quicker commissioning mean that investments in safety rapidly pay for themselves.

Mounting and operation made easy

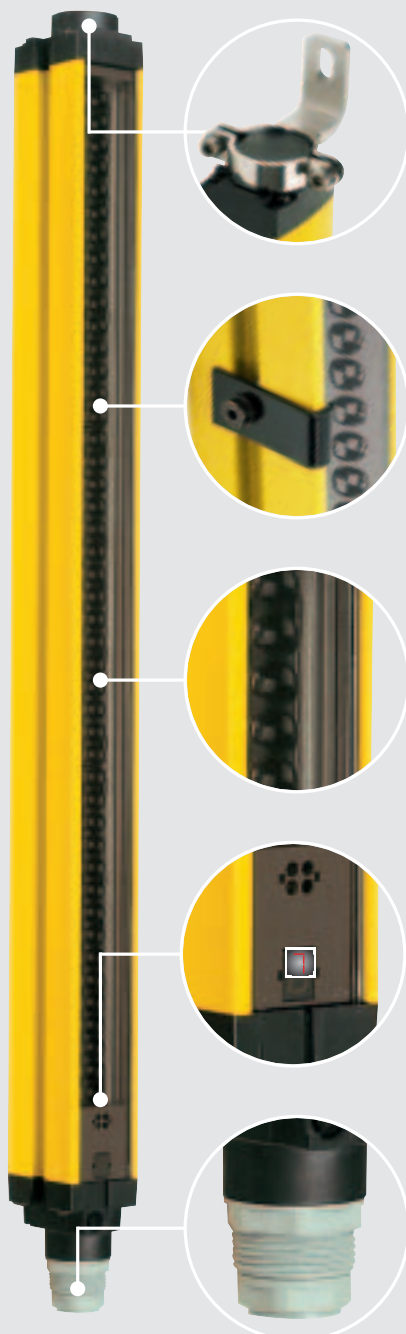

Comprehensive range of mounting solutions and accessories provides a wide range of installation options.



Heavy-duty additional front screen for use in environments with welding sparks

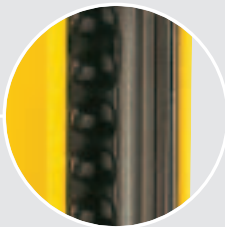

Atex applications in explosion-protected zones 2 and 22 possible with additional package (II Cat. 3G/3D).



7-segment display for device status
A display that can be rotated by 180° also provides the right reading position on a device installed upside down and thus prevents errors when interpreting the indications.



A universal interface
All peripheral technologies can be incorporated using a universal interface: from the relay through safe control to the bus.

System and user advantages

- ▶ Reduced stock-holding costs due to universal interface. One device for everything
- ▶ Quicker commissioning and diagnostics due to simplified alignment using 7-segment display
- ▶ Mutual interference between multiple systems prevented by beam coding



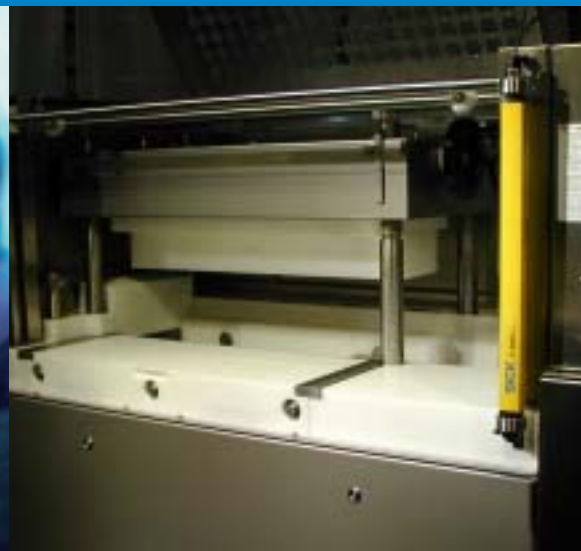

Cost-saving with the C 4000 system solution

- Monitoring of the receiver cable over its entire length due to semiconductor outputs on the safety light curtain
- Direct connection of the emergency stop and reset control switch to the C 4000
- Removal of emergency stop and light curtain evaluation devices
- Uniform diagnostics and configuration
- Lower control cabinet space requirement
- Lower wiring effort
- Simpler engineering, as fewer components need to be taken into account
- Reduced stock-holding costs, as fewer components need to be taken into account

Expected savings per machine
→ min. 200 €

For 100 units
→ min. 20,000 €

Safety solution with integrated functions

Direct connection of the command switches, as a result the wiring effort is reduced

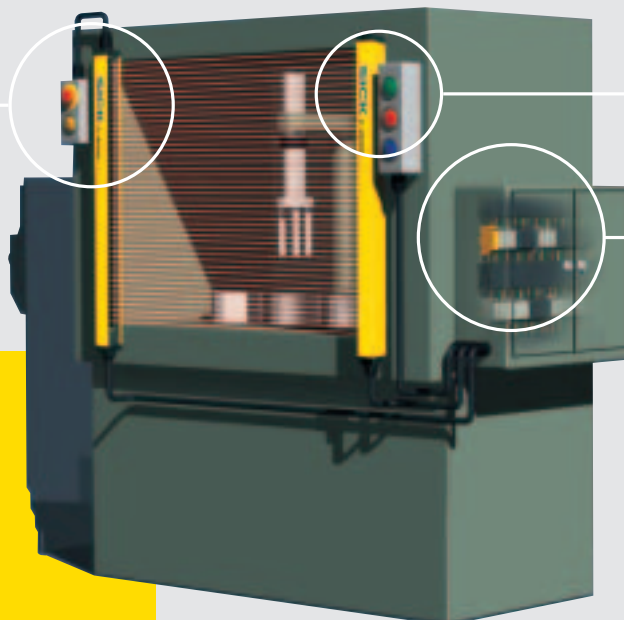

Additional savings in components due to de-centralised sensor intelligence, e.g., blanking, reduced resolution, etc.

Space-saving due to removal of additional evaluation devices

**Tell us your application.
We will develop the
most cost-effective
solution with C 4000.**

To get productivity moving.

In complex manufacturing environments, e. g. the car industry, the safety of the person and the maximum availability of the systems have top priority. With specific, tailor-made solutions, SICK has been your technology partner for decades.

Full availability



Quality and availability in series production.

- Uniform arrangement of sender and receiver throughout – C 4000 beam coding minimises optical interaction on machines connected in series
- Convenient integration with little wiring effort
- Cascadable – up to 3 linked protective fields are possible, only one output signal
- Rapid commissioning due to integrated alignment aid per sensor pair
- Shorter downtimes due to localisation of diagnostics message (7-segment display) and indication of information via the bus
- Installation with 3 m long cable between linked pairs of sensors



Revolutionary access protection with integrated differentiation between man and material (muting alternative): C 4000 Entry/Exit.

Increased productivity can be seen at each process step. C 4000 Entry/Exit is used wherever material needs to be transported automatically into the hazardous area of a machine and access by persons must be reliably excluded at the same time.

System and user advantages

- ▶ Financial gain due to savings in additional sensors or other protection measures
- ▶ Very high availability due to self-teach distance monitoring
- ▶ Reduced mounting effort due to single pair of sensors
- ▶ Maximum safety due to continuously active light curtain – tampering is very difficult
- ▶ Insensitive to welding sparks due to internal evaluation logic

Cost-effective

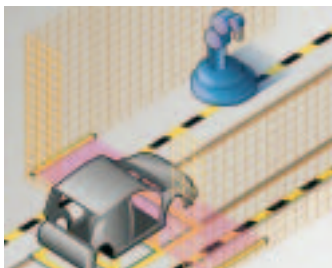

A horizontal light curtain without additional sensors and mechanics.

Available

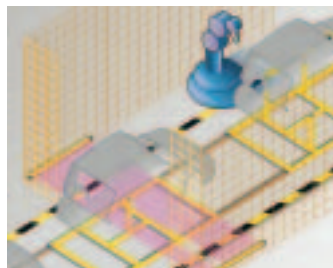

Different transport equipment is detected automatically.

Safe

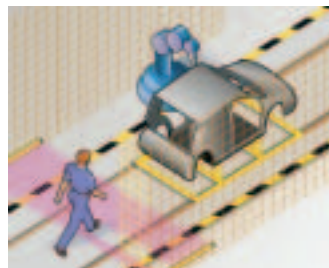

Invalid objects or asynchronous movements result in immediate shut down.

Savings in the order of several hundred percents are possible.

Request our cost-effectiveness analysis.



C 4000 Entry/Exit

Self-teach dynamic blanking – the safe way to reliably and economically solve industrial transport processes

A safe investment in the future.

Innovative safety technology is required for machines to become faster, more cost-effective and productive. Presses with integrated PSDI evaluation on the safety sensors work up to 30 % faster than with two-hand control.

Productivity increase



Get the safety of your system up to date.

- Increased productivity due to integrated functions, such as blanking, PSDI, reduced resolution, etc.
- Profitable system operation due to sensor systems with high immunity to interference
- Optimised initial costs and life cycle costs due to high availability
- Collaboration across industry sectors, know-how transfer for your solution



Integrated PSDI mode with defined PSDI window provides up to 30% higher productivity.

- Operating modes that can be selected with a mode switch (with UE 402) help to reduce setup times and shorten downtimes on operating mode changes
- The unique PSDI window is a defined part of the protective field that interprets an interruption as a PSDI
 - increased productivity due to reduction of unintentional cycle starts
 - and increased safety as hazardous areas of the machine continue to be protected
- Light beam interruption automatically triggers machine cycle
- High production performance as a two-hand control is not needed for starting

System and user advantages

- ▶ Shortened setup times on tool change by selecting saved configurations with the safety evaluation unit UE 402
- ▶ Increased production performance due to PSDI mode and use of a PSDI window
- ▶ Increased safety, material gate in the protective field prevents unintentional starts in the PSDI mode



Safety evaluation unit UE 402

intelliface
the intelligent interface



Defined PSDI window prevents unintentional cycle start due to reaching above or reaching below



Automatic cycle start without two-hand control



Protective function during the cycle



**C 4000 Standard/
C 4000 Advanced**

Interested in better results.

Aggressive cleaning agents, permanent humidity, strict hygiene regulations – these are the conditions under which sensors must work safely.



Robust



Universally applicable for type 2 or type 4 in accordance with IEC 61496.

- C 2000 Standard, version
150 to 1,200 mm protective field height
- C 4000 Micro
150 to 1,200 mm protective field height

Accident prevention that is washed with everything.

- Operating temperatures from 0 to 55 °C
- Damp areas with up to 95 % air humidity
- Resistant materials: stainless steel caps and brackets, acrylic glass PMMA
- Goretex® membranes prevent the acrylic tubes misting up and prevent the entry of liquids

System and user advantages

- ▶ IP-67 protective housing: Safety that can also resist extreme environmental conditions
- ▶ The solution for aggressive cleaning agents and increased hygiene requirements
- ▶ Can be used with large temperature fluctuations as well as in wet areas



C4000
Micro

C 2000

IP67
Housing

Produce quality safely.

Whether wafer production, chip manufacture or circuit board control – SICK safety solutions contribute to market-oriented production worldwide. With know-how and uncompromising quality, SICK provides the electronics industry maximum benefits.

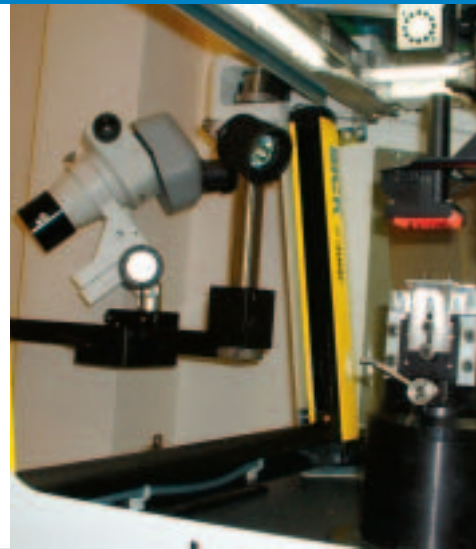

Immune to interference



Space-saving safety light curtains for tight spaces.

- Safety light curtain C 4000 Micro (type 4)
- Safety light curtain C 2000 (type 2) (SEMI-S2-0200-certified)
- Safety light curtain LGT (type 2) (SEMI-S2-0200-certified)

System and user advantages

- ▶ Extremely slender safety light curtain with separate connection box
- ▶ Immune to interference due to high EMC performance
- ▶ Maximum benefit and productive systems due to integrated functions
- ▶ High quality and service competence worldwide

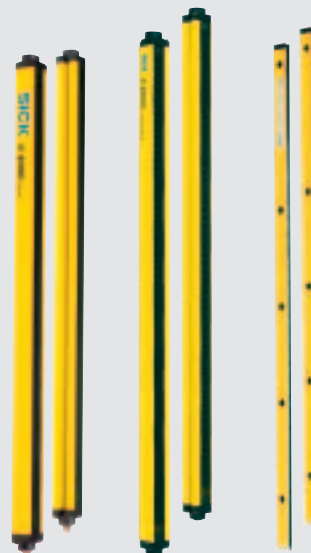

C 4000
Micro

C 2000

LGT



Secure competitive advantages in time.

Nowadays machine solutions must address the needs of the users at the end customers. Manufacturing must be flexible, in close proximity to the customer and cost-effective. C 4000 crucially increases the freedom of manoeuvre of machine manufacturers. Profit from our wide ranging know-how when developing new product lines.

Profitable and tailor-made





Custom safety application.

Profit from the comprehensive know-how that will benefit you and your users in the realisation of your application.

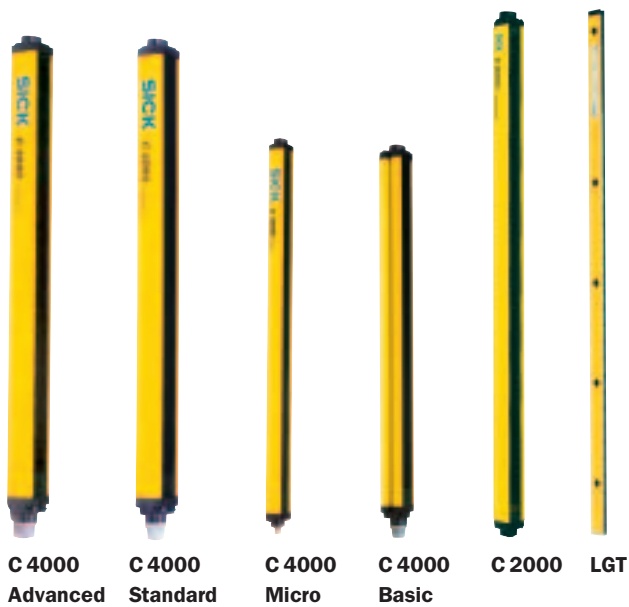

System and user advantages

- ▶ Low safety distances due to fast response times
- ▶ Cost reduction due to optimal adaptation. With four resolutions the system can be optimally adapted to the required safety distance
- ▶ Reduced engineering and stockholding costs due to interface of universal application (relay, safe control, bus)
- ▶ Time-saving on device replacement due to parameter information saved in the safety controller
- ▶ Reduced control cabinet requirements due to integrated functions











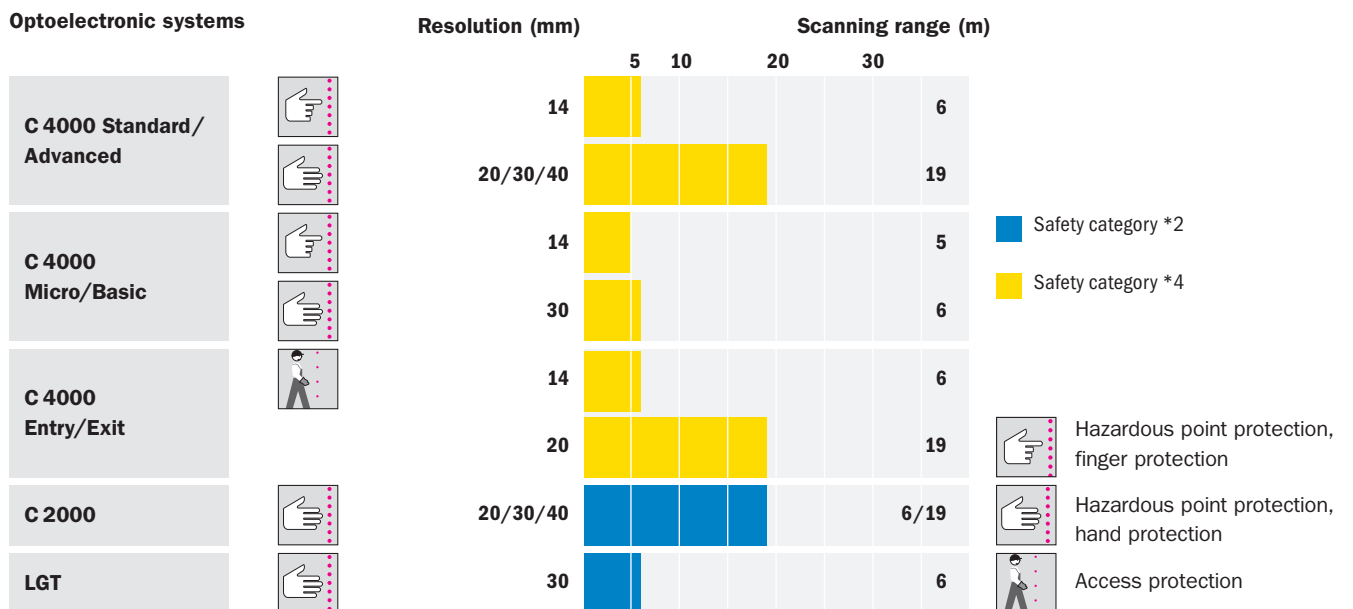









Many tasks, one program.



Whether finger protection, hand protection or access protection – choose and decide for yourself which SICK solution is the most suitable for your application. We will support you during the implementation of your safety system. Simply contact us.

Optoelectronic systems



Products	Type/category	Applications	Technical specifications
C 4000 Standard/Advanced   	Type 4 in compliance with IEC 61496 IEC 61508 SIL3	<ul style="list-style-type: none"> Automotive Shaping machine tools Plastic and rubber Electronics industry Robotics industry Printing and paper industry Wood processing Palettisers Storage/conveyor technology 	<ul style="list-style-type: none"> Protective field height (depending on type) 300 to 1,800 mm Scanning range (depending on type) 0 to 6 m/0 to 19 m Resolution (depending on type) 14 mm, 20 mm, 30 mm, 40 mm Enclosure rating IP 65 External device monitoring/restart interlock Beam coding Fixed blanking Floating blanking Reduced resolution Teach-in blanking Operating mode selection using UE 402 PSDI mode using UE402 Bypass
C 4000 Micro   	Type 4 in compliance with IEC 61496 IEC 61508 SIL3	<ul style="list-style-type: none"> Electronics industry Packaging machines Handling machines Special machine-tool manufacture Food industry 	<ul style="list-style-type: none"> Small, compact design Protective field height (depending on type) 150 to 1,200 mm Scanning range (depending on type) 0 to 5 m/0 to 6 m Resolution (depending on type) 14 mm, 30 mm Enclosure rating IP 65 External device monitoring Restart interlock
C 4000 Basic   	Type 4 in compliance with IEC 61496 IEC 61508 SIL3	<ul style="list-style-type: none"> Car industry Machine tool manufacture 	<ul style="list-style-type: none"> Protective field height (depending on type) 300 to 1,800 mm Scanning range (depending on type) 0 to 5 m/0 to 6 m Resolution (depending on type) 14 mm, 30 mm Enclosure rating IP 65 Protective function External device monitoring
C 4000 Entry/Exit   	Type 4 in compliance with IEC 61496 IEC 61508 SIL3	<ul style="list-style-type: none"> Car industry Storage and conveyer technology 	<ul style="list-style-type: none"> Protective field height (depending on type) 900 to 1,500 mm Scanning range (depending on type) 0.5 to 6 m/0.5 to 19 m Resolution (depending on type) 14 mm, 20 mm, 30 mm, 40 mm Enclosure rating IP 65 Self-teach dynamic blanking of moving objects in the protective field level Remote diagnostics and configuration by means of interface to bus modules Restart interlock/external device monitoring Beam coding Option of connection to switching amplifier UE402
C 2000   	Type 2 in compliance with IEC 61496	<ul style="list-style-type: none"> Storage and conveyer technology Wood industry Textile industry Stone production Electronics industry Packaging industry 	<ul style="list-style-type: none"> Protective field height (depending on type) 150 mm to 1,800 mm Scanning range (depending on type) 0 m to 6 m/2.5 m to 19 m Resolution (depending on type) 20 mm, 30 mm, 40 mm Enclosure rating IP 65 Restart interlock External device monitoring Self-testing 7-segment display Diagnostics Alignment aid Beam coding
LGT  	Type 2 according to prEN 50100	<ul style="list-style-type: none"> Storage and conveyer technology Wood industry Textile industry Stone production Electronics industry Packaging industry 	<ul style="list-style-type: none"> Small design Protective field height (depending on type) 150 mm to 900 mm Scanning range (depending on type) 0.1 m to 6 m Resolution 30 mm Enclosure rating IP 65 Integrated restart interlock External device monitoring Diagnostics Alignment aid Blanking



SICK – value-added services

- ▶ Reducing time-to-market
- ▶ Increasing machine availability
- ▶ Increasing system productivity
- ▶ Securing technical lead
- ▶ Minimising costs and financial risks



Safety Consulting

- ▶ Application consulting
- ▶ Technical advice on site
- ▶ Project support
- ▶ Preparation of safety concepts

Access to a wide range of application and sector know-how provides comprehensive problem solutions and shortens planning times.

Training & Education

- ▶ Product training
- ▶ Seminars
- ▶ User training
- ▶ Specialist training modules

Flexible seminar and training programmes generate knowledge that can be utilised directly and secure quality.

Assured success with safety.

Industrial Safety Management.

Safety Inspection

- ▶ Initial commissioning inspection
- ▶ Periodic inspections
- ▶ Stoptime measurements
- ▶ Service contracts

Safety inspections ensure maximum system availability and very high quality system safety as well as documented and traceable results.



Product Service

- ▶ Technical information line
- ▶ Support during commissioning
- ▶ Repair and exchange service

Broad support for your SICK sensor solution ensures reliable and productive system operation.

SICK safety systems – the right decision for today and tomorrow

Linking safety-relevant signals with Intelliface series interface modules

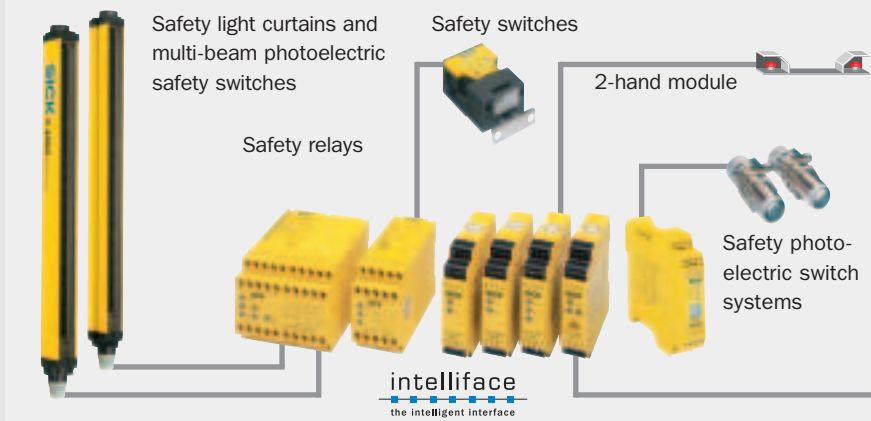
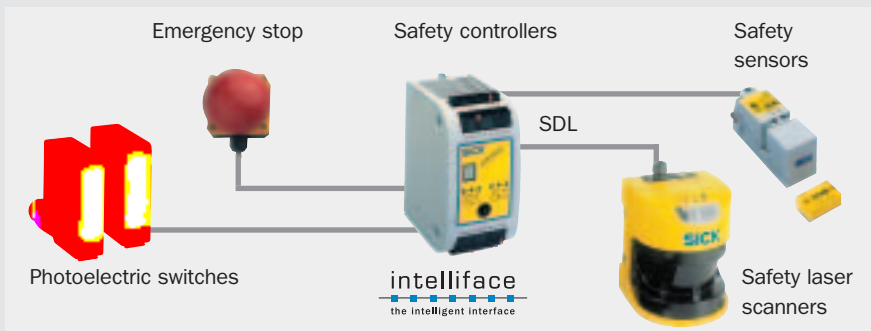
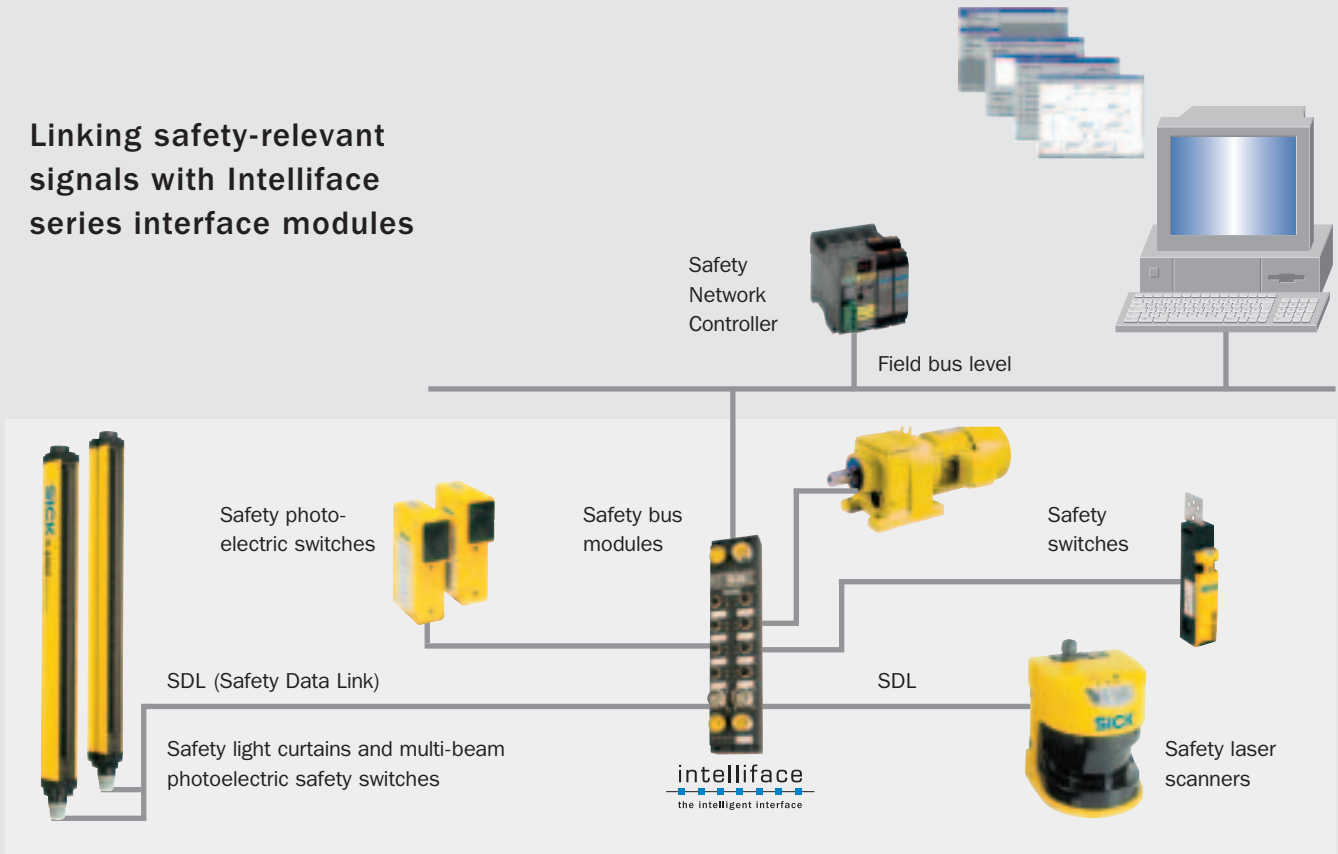

Safexpert

Safety engineering on machines and systems:
Safe design, risk assessment and documentation



SICK Industrial Safety Systems

Safety laser scanners and Safety camera system

- S 3000
- PLS
- PLS short range
- RLS
- V 4000 Press Brake

Safety light curtains

- C 4000 Micro
- C 4000 Basic
- C 4000 Standard/Advanced
- C 4000 Entry/Exit
- C 4000 Palletizer in preparation
- C 2000
- LGT

Multiple light beam safety devices

- M 4000 in preparation
- MSL
- MSL/MSM
- M 2000

Safety photoelectric switches

- L 4000 system
- WSU/WEU 26/2
- WS/WE 12-2 with LE 20
- WS/WE 18-2 with LE 20
- WS/WE 24-2 with LE 20
- WS/WE 27-2 with LE 20
- VS/VE 18-2 with LE 20

Safety switches, sensors and operating devices

- Safety position switches
- Safety switches with separate actuator
- Safety locking devices
- Safety sensors
- Safety operating devices

SICK Industrial Safety Systems

Safety bus modules and Safety network controller UE 1000 series

- UE 4120, UE 4150, UE 4155
- UE 3212, UE 4215, UE 4231, UE 4232
- UE 4420, UE 4421, UE 4450, UE 4470

Safety controllers UE 100 series

- UE 440
- UE 470

Safety relays UE 10 series

- UE 10 to UE 48

Safety software

- Safexpert



www.sick.de

- ▶ eCatalog
- ▶ Product finder
- ▶ Applications
- ▶ and much more





Our complete range of sensors provides answers to suit any application in the field of automation. Even under rugged ambient conditions objects are reliably detected, counted and positioned in respect of their form, location and surface finish, as well as their distances established with pin-point accuracy.



Comprehensive safeguarding of both personnel and machinery! As specialists in Sensor Technology, SICK develops and manufactures pioneering products for providing protection in hazardous zones, dangerous locations and for safeguarding access points. By providing services, which encompass all aspects of machine safety and security, SICK is setting new standards in Safety Technology.



System control, maintaining setpoints, optimising process control and monitoring the flow of materials – the instruments and services for Analysis and Process Measurement, supplied by SICK-MAIHAK, are setting the standards for these applications in terms of Technology and Quality.



Whether the tasks involve identification, handling, classification or volume measurement, innovative Auto Ident systems and laser measuring systems function extremely reliably, even under rapid cycle times. They conform to the latest Standards and can be simply and speedily integrated in all industrial environments and external applications.

SICK Sensor Intelligence.

Contact:

Australia

Phone +61 3 9497 4100
1800 33 48 02 – tollfree
E-Mail sales@sick.com.au

Belgium/Luxembourg

Phone +32 (0)2 466 55 66
E-Mail info@sick.be

Brasil

Phone +55 11 5091-4900
E-Mail sac@sick.com.br

Ceská Republika

Phone +420 2 57 91 18 50
E-Mail sick@sick.cz

China

Phone +852-2763 6966
E-Mail ghk@sick.com.hk

Danmark

Phone +45 45 82 64 00
E-Mail sick@sick.dk

Deutschland

Phone +49 (0)2 11 53 01-260
E-Mail vzdinfo@sick.de

España

Phone +34 93 480 31 00
E-Mail info@sick.es

France

Phone +33 1 64 62 35 00
E-Mail info@sick.fr

Great Britain

Phone +44 (0)1727 831121
E-Mail info@sick.co.uk

Italia

Phone +39 02 27 40 93 19
E-Mail ced@sick.it

Japan

Phone +81 (0)3 3358 1341
E-Mail info@sick.jp

Korea

Phone +82-2 786 6321/4
E-Mail kang@sickkorea.net

Nederlands

Phone +31 (0)30 229 25 44
E-Mail info@sick.nl

Norge

Phone +47 67 81 50 00
E-Mail austefjord@sick.no

Österreich

Phone +43 (0)22 36 62 28 8-0
E-Mail office@sick.at

Polska

Phone +48 22 837 40 50
E-Mail info@sick.pl

Schweiz

Phone +41 41 619 29 39
E-Mail contact@sick.ch

Singapore

Phone +65 6744 3732
E-Mail admin@sicksgp.com.sg

Suomi

Phone +358-9-25 15 800
E-Mail sick@sick.fi

Sverige

Phone +46 8 680 64 50
E-Mail info@sick.se

Taiwan

Phone +886 2 2365-6292
E-Mail sickgrc@ms6.hinet.net

Türkiye

Phone +90 216 388 95 90 pbx
E-Mail info@sick.com.tr

USA/Canada/México

Phone +1(952) 941-6780
1800-325-7425 – tollfree
E-Mail info@sickusa.com

More representatives and agencies in all major industrial nations at www.sick.com

SICK