

Small Round Water-resistive Connectors

- Water-resistive, compact connector meets IP67 requirements.
- Conventional M8 screw-mounting models are available along with S8 snap-in models that connect and disconnect with one touch.
- Ideal for a wide variety of FA and OA applications.
- Connectors on both cable ends require no harness work.
- Some new M8 models with 3 or 5 poles.



 Refer to *Safety Precautions* on page 19.

Ratings and Specifications

Item	Model	XS3F/H/W/P/M	XS3F-M52□-5□□-A	XS3M-M524-1□	XS3R
Rated current		1 ADC	3 ADC		1 ADC
Rated voltage		125 VDC *2	30 VDC		125 VDC
Contact resistance (connector)		40 mΩ max. (20 mV max., 100 mA max.)			60 mΩ max. (20 mVDC max., 100 mA max.)
Insulation resistance		1,000 MΩ min. (at 500 VDC)			
Dielectric strength (connector)		1,000 VAC for 1 min (leakage current: 1 mA max.)	650 VAC for 1 min (leakage current: 1 mA max.)		1,000 VAC for 1 min (leakage current: 1 mA max.)
Degree of protection		IP67 (IEC60529)			
Insertion tolerance		200 times			
Cable tensile strength *1		50 N			
Ambient operating temperature range		-25 to 70°C	-25 to 85°C		-25 to 70°C

*1. Models with cable only

*2. Except 5poles

Materials and Finish

Connector

Item	Type Model	M8			S8		
		XS3F/H/W/R	XS3P/M *	XS3M-M524-1□	XS3F/W (Socket side)	XS3H/W (Plug side)	XS3P
Contact block		PBT resin (UL94 V-0) light gray or black					
Contacts		Phosphor bronze/nickel base, 0.4-μm gold plating	Brass/nickel base, 0.4-mm gold plating		Phosphor bronze/nickel base, 0.4-μm gold plating	Brass/nickel base, 0.4-μm gold plating	
Thread bracket		Brass/nickel plating or SUS316L		—	Brass/nickel plating		—
Body		—	Brass/nickel plating	Nickel-plated zinc alloy	—		
Shell		—					TPEE
C-Ring		—		Phosphor bronze/tin plating	—		
Grounding fixture		—		Phosphor bronze/tin plating	—		
Nut		—	Brass/nickel plating		—		
Cover		Soft PBT resin (UL94 V-0)	—		TPEE	—	
O-ring		Rubber					

*Except 5poles

Note: The XS3M is for both M8 and S8.

Cables

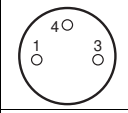
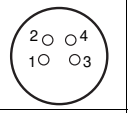
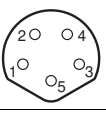
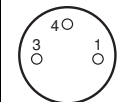
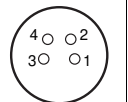
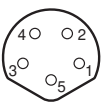

Item	Pins	3 pin	4 pin	5 pin
		Standard cable	Diameter: 4 mm dia. Cross section area: 0.2 mm ² (18 / 0.12 mm dia.)	4.7 mm dia. 0.2 mm ² (11 / 0.16 mm dia.)
Vibration-proof robot cable	Diameter: 4 mm dia. Cross section area: 0.2 mm ² (40 / 0.08 mm dia.)	—	—	—

Pin Arrangement (Engaged Side)

Item	Pins	3 pin	4 pin	5 pin
DC	Plug			
	Socket			

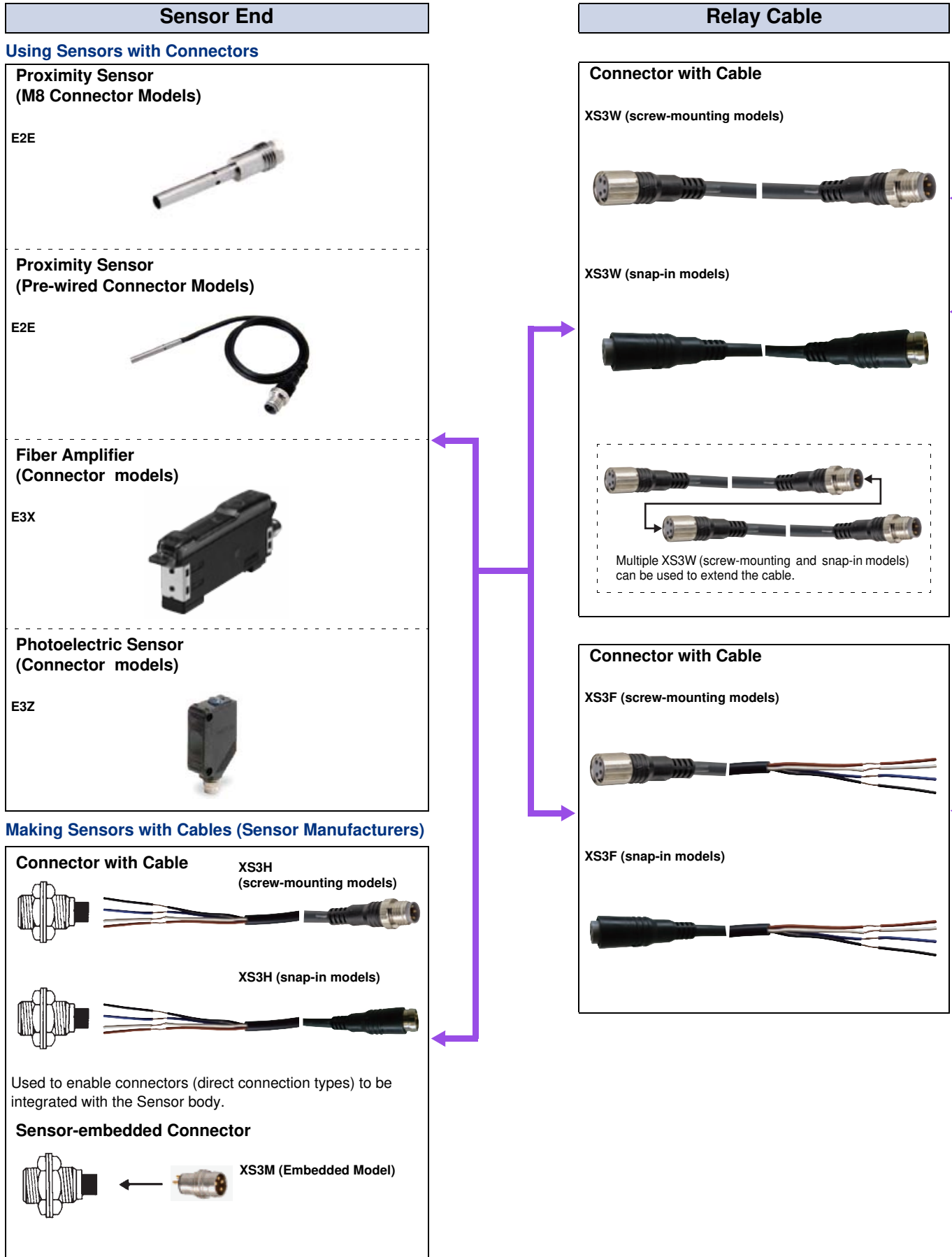
Wiring System Configuration



( indicates mating connectors, and  indicates wiring connections.)

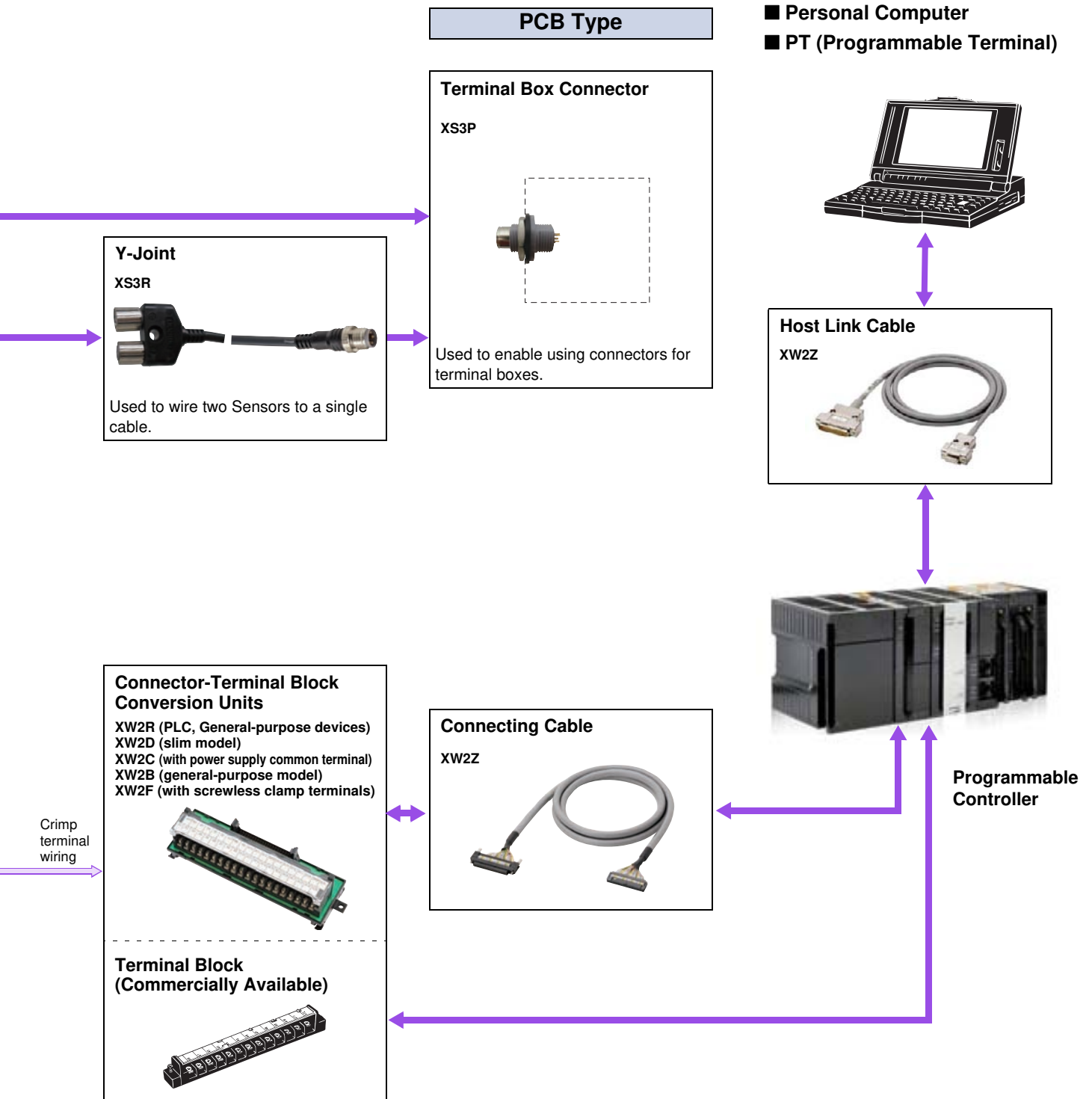

XS3W

● M8 Screw-mounting Connectors with Vibration-proof Robot Cable

XS3W-M□□□-□□□□-R

Dimensions

(Unit: mm)

Straight/Straight Connectors

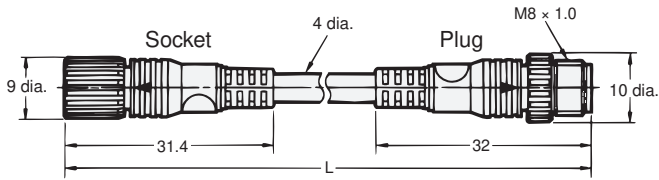

Straight/Right-angle Connectors

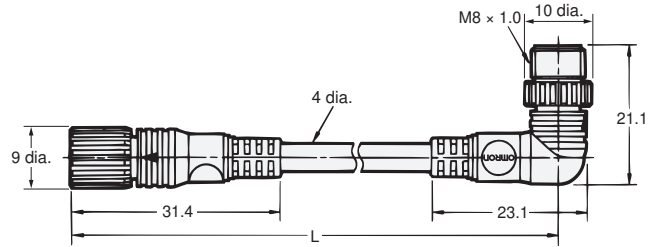

Right-angle/Right-angle Connectors

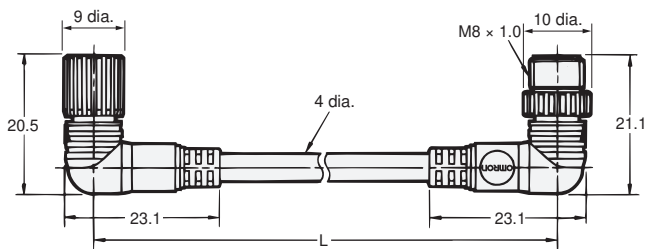

Right-angle/Straight Connectors

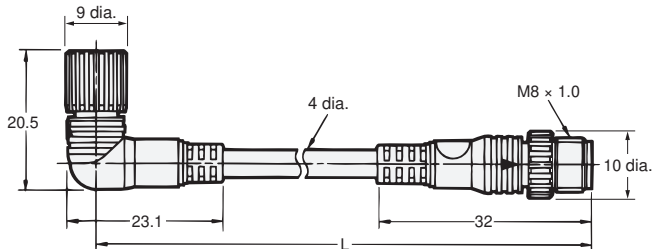

● S8 Snap-in Connectors with Vibration-proof Robot Cable

XS3W-S42□-4□□□-R

Dimensions

(Unit: mm)

Straight/Straight Connectors

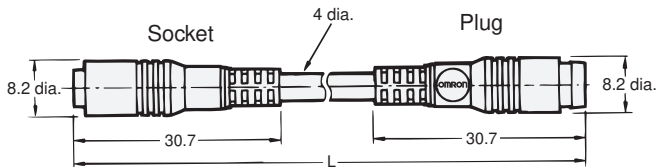

Straight/Right-angle Connectors

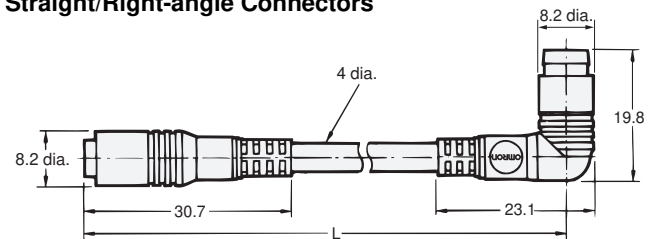

Right-angle/Right-angle Connectors

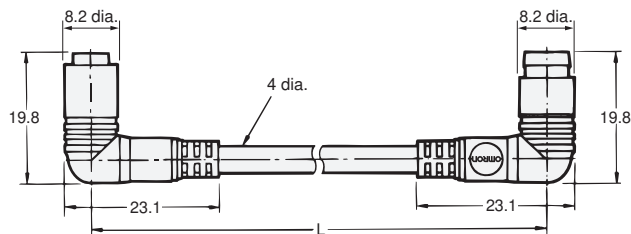

Right-angle/Straight Connectors

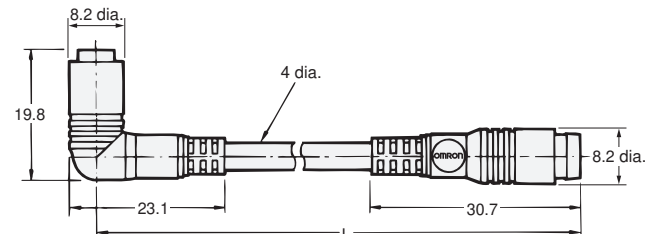

Model Number Legend

Use this model number legend to identify products from their model number. When ordering, use a model number from the table in *Ordering Information*.

XS3W- **2** **-R**

1
2
3
4
5
6

1. Fastening Method

M: M8
S: S8

2. Connector Poles

3: 3 poles
4: 4 poles

3. Cable Connection Direction

1: Straight (socket/XS3F)/
Straight (plug/XF3H)
2: Right-angle (socket/XS3F)/
Right-angle (plug/XF3H)
3: Straight (socket/XS3F)/
Right-angle (plug/XS3H)
4: Right-angle (socket/XS3F)/
Straight (plug/XS3H)

4. Connections

Pin No.
① ③ ④
3: Brown Blue Black
Pin No.
① ② ③ ④
4: Brown White Blue Black

5. Cable Length

01: 1 m
02: 2 m
05: 5 m

6. Cable Specifications

R: Vibration-proof
robot cable

Wiring Diagram/Engaged Side

3 poles

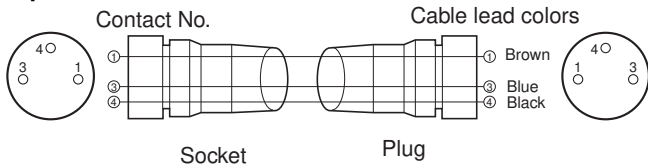

4 poles

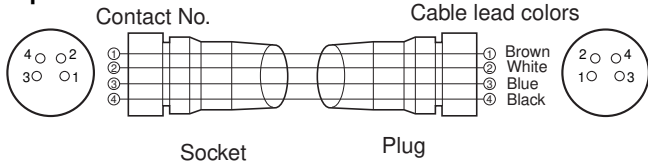

Mating Connectors

Item	Socket side	Plug side
XS3W (M8)	XS3M (M8/S8) XS3H (M8)	XS3F (M8) XS3W (M8) XS3P (M8)
XS3W (S8)	XS3M (M8/S8) XS3H (M8)	XS3F (S8) XS3W (S8) XS3P (S8)

Note 1. Cables can be extended with more than one XS3W.

2. M8 screw models and S8 snap-in models cannot be connected to each other.

Ordering Information

M8 Screw-mounting Connectors

No. of cable cores	Cable connection direction	Cable length L (m)	Model
3	Straight/Straight	1	XS3W-M321-301-R
		2	XS3W-M321-302-R
		5	XS3W-M321-305-R
4	Straight/Straight	1	XS3W-M421-401-R
		2	XS3W-M421-402-R
		5	XS3W-M421-405-R
	Right-angle/Right-angle	2	XS3W-M422-402-R
		5	XS3W-M422-405-R
	Straight/Right-angle	2	XS3W-M423-402-R
		5	XS3W-M423-405-R
	Right-angle/Straight	2	XS3W-M424-402-R
		5	XS3W-M424-405-R

S8 Snap-in Connectors

No. of cable cores	Cable connection direction	Cable length L (m)	Model
4	Straight/Straight	1	XS3W-S421-401-R
		2	XS3W-S421-402-R
		5	XS3W-S421-405-R
	Right-angle/Right-angle	2	XS3W-S422-402-R
		5	XS3W-S422-405-R
	Straight/Right-angle	2	XS3W-S423-402-R
		5	XS3W-S423-405-R
	Right-angle/Straight	2	XS3W-S424-402-R
		5	XS3W-S424-405-R

XS3F Sockets on One Cable End

● M8 3 pin Screw-on Cables with Vibration-proof Robot Cable/Standard Cable

XS3F-M32□-3□□-□

Dimensions

(Unit: mm)

Straight Connectors

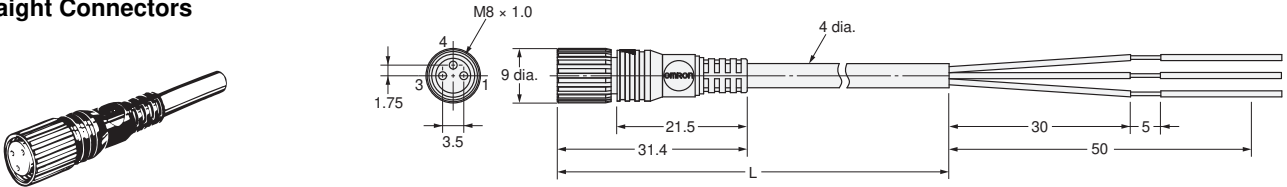

Right-angle Connectors

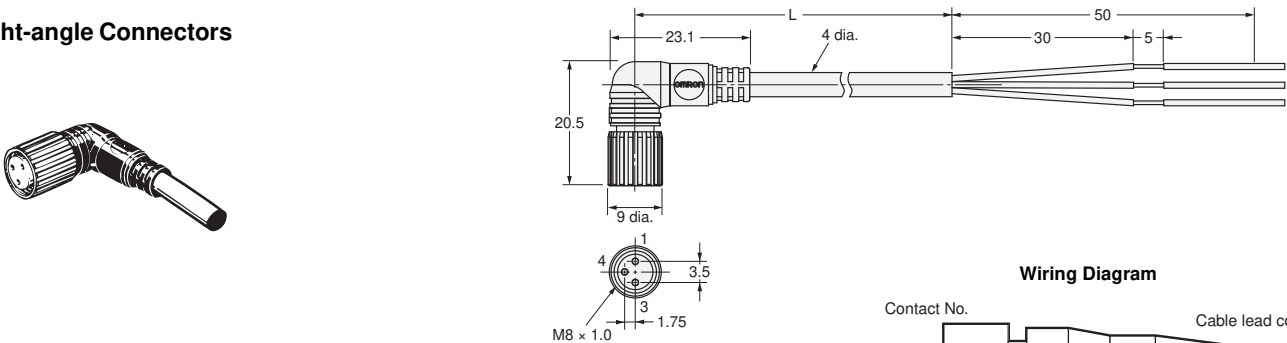

Wiring Diagram

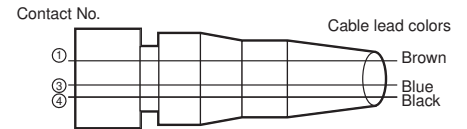

● M8 4 pin Screw-on Cables with Vibration-proof Robot Cable/Standard Cable

XS3F-□42□-4□□-□

Dimensions

(Unit: mm)

Straight Connectors

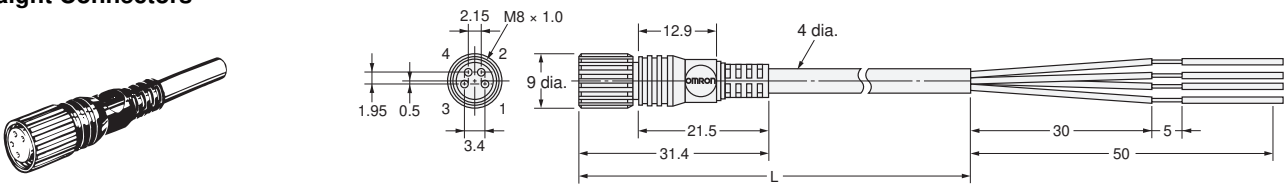

Right-angle Connectors

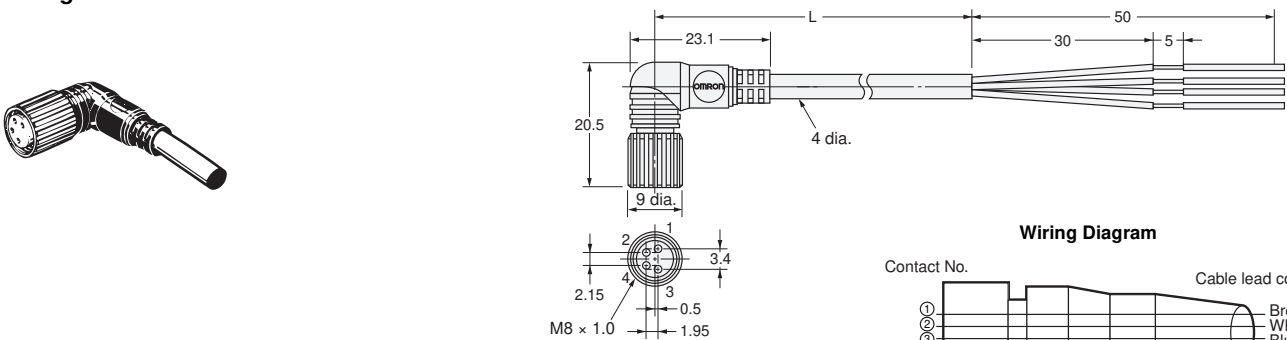

Wiring Diagram

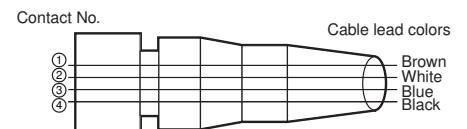

● M8 5 pin Screw-on Cables with Standard Cable

XS3F-M52□-5□□-A

Dimensions

(Unit: mm)

Straight Connectors

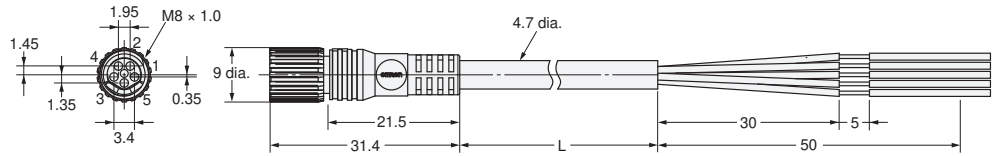

Right-angle Connectors

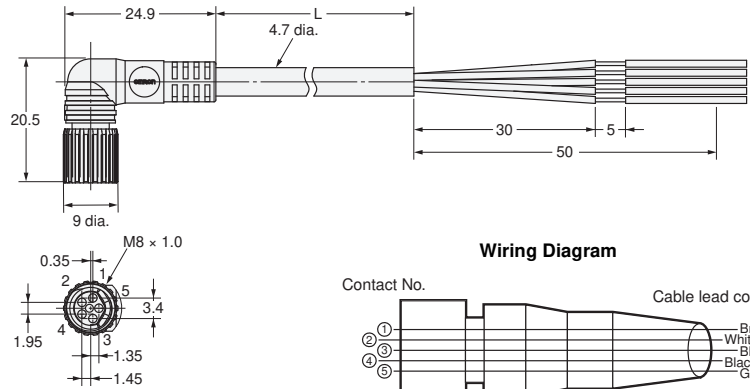

Wiring Diagram

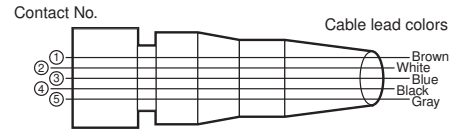

● S8 Snap-in Connectors with Vibration-proof Robot Cable

XS3F-S42□-4□□-R

Dimensions

(Unit: mm)

Straight Connectors

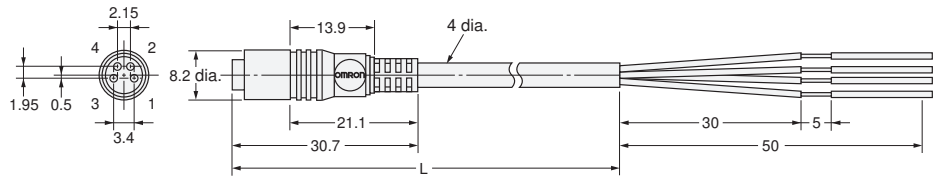

Right-angle Connectors

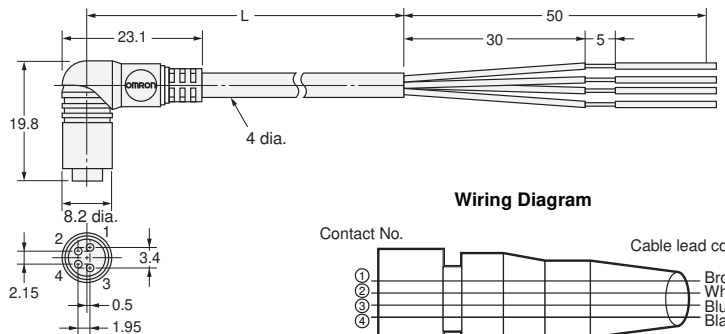
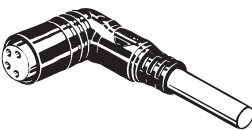

Wiring Diagram

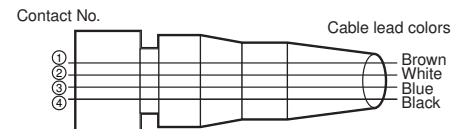

Model Number Legend

Use this model number legend to identify products from their model number. When ordering, use a model number from the table in *Ordering Information*.

XS3F- **2** **-** **-**

1
2
3
4
5
6

1. Fastening Method

- M: M8
- S: S8
- E: M8
- SUS316L Lock

2. Connector Poles

- 3: 3 poles
- 4: 4 poles
- 5: 5 poles

3. Cable Connection Direction

- 1: Straight
- 2: Right-angle

4. Connections

- Pin No.
- ① ③ ④
- 3: Brown Blue Black
- Pin No.
- ① ② ③ ④
- 4: Brown White Blue Black
- Pin No.
- ① ② ③ ④ ⑤
- 5: Brown White Blue Black Gray

5. Cable Length

- 01: 1 m
- 02: 2 m
- 05: 5 m
- 10: 10 m

6. Cable Specifications

- A: Standard cable
- R: Vibration-proof robot cable

Mating Connectors

Item	Model
XS3F(M8)	XS3M (M8/S8), XS3H (M8), XS3W (M8)
XS3F(S8)	XS3M (M8/S8), XS3H (M8), XS3W (M8)

Note: M8 screw models and S8 snap-in models cannot be connected to each other.

Ordering Information

M8 Screw-on Cables

No. of cable cores	Item	Cable connection direction	Cable length L (m)	Model
3	Standard cable	Straight	2	XS3F-M321-302-A
			5	XS3F-M321-305-A
		Right-angle	2	XS3F-M322-302-A
	5		XS3F-M322-305-A	
	Vibration-proof robot cable	Straight	2	XS3F-M321-302-R
			5	XS3F-M321-305-R
Right-angle		2	XS3F-M322-302-R	
		5	XS3F-M322-305-R	
4	Standard cable	Straight	2	XS3F-M421-402-A
			5	XS3F-M421-405-A
		Right-angle	2	XS3F-M422-402-A
			5	XS3F-M422-405-A
	Vibration-proof robot cable	Straight	1	XS3F-M421-401-R
			2	XS3F-M421-402-R
			5	XS3F-M421-405-R
		Right-angle	1	XS3F-M422-401-R
			2	XS3F-M422-402-R
			5	XS3F-M422-405-R
	Standard SUS316L cable lock	Straight	2	XS3F-E421-402-A
			5	XS3F-E421-405-A
Right-angle		2	XS3F-E422-402-A	
		5	XS3F-E422-405-A	
5	Standard cable	Straight	2	XS3F-M521-502-A
			5	XS3F-M521-505-A
			10	XS3F-M521-510-A
		Right-angle	2	XS3F-M522-502-A
			5	XS3F-M522-505-A
			10	XS3F-M522-510-A

S8 Snap-in Connectors

No. of cable cores	Item	Cable connection direction	Cable length L (m)	Model
4	Vibration-proof robot cable	Straight	1	XS3F-S421-401-R
			2	XS3F-S421-402-R
			5	XS3F-S421-405-R
		Right-angle	1	XS3F-S422-401-R
			2	XS3F-S422-402-R
			5	XS3F-S422-405-R

XS3H Plugs on One Cable End

● M8 3 pin Screw-on Connectors with Vibration-proof Robot Cable

XS3H-M321-3□□-R

Dimensions

(Unit: mm)

Straight Connectors

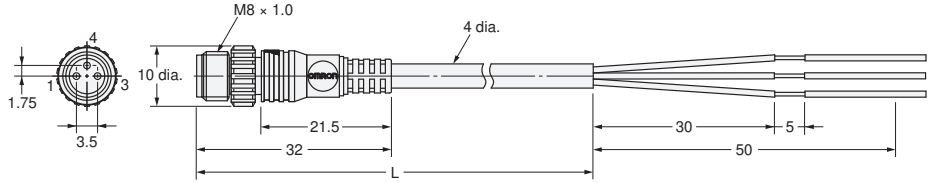

Wiring Diagram

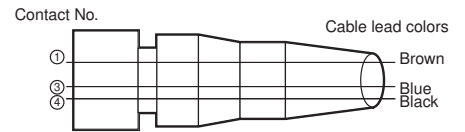

● M8 4 pin Screw-on Connectors with Vibration-proof Robot Cable

XS3H-M42□-4□□-R

Dimensions

(Unit: mm)

Straight Connectors

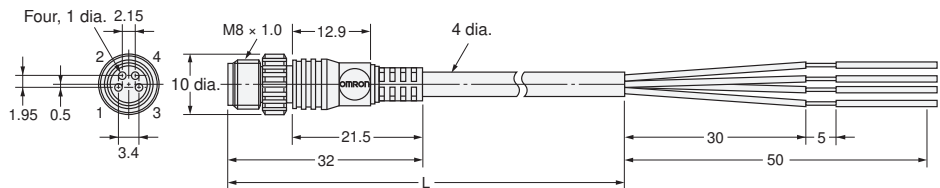
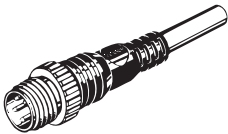

Wiring Diagram

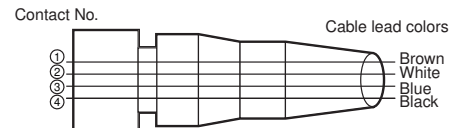

Right-angle Connectors

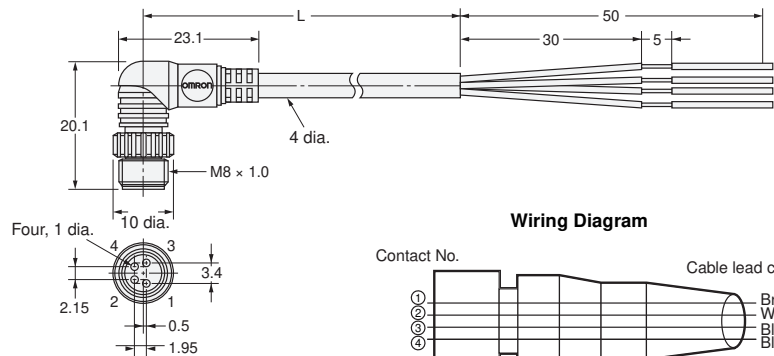
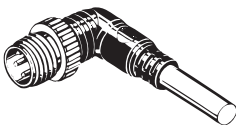

Dimensions

(Unit: mm)

Straight Connectors

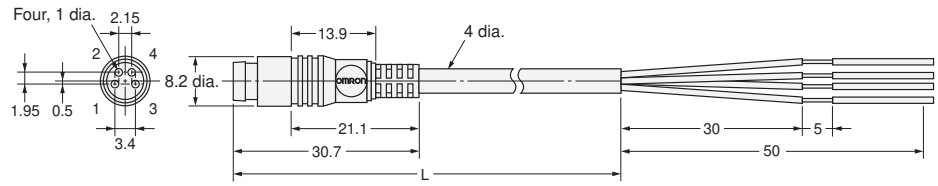
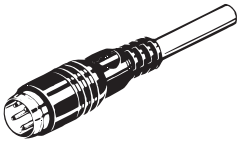

Right-angle Connectors

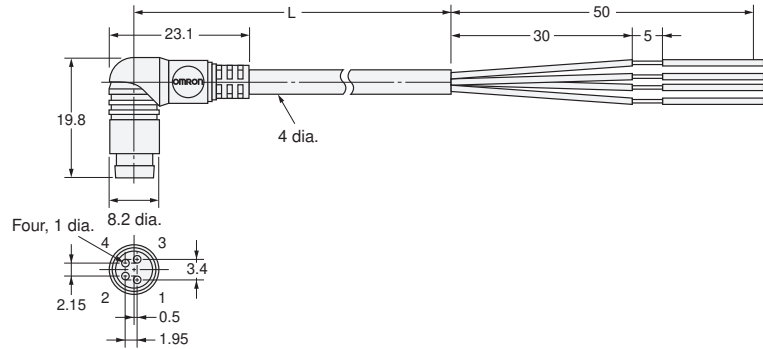
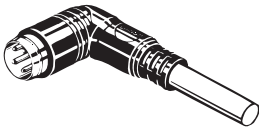

Model Number Legend

Use this model number legend to identify products from their model number. When ordering, use a model number from the table in *Ordering Information*.

XS3H-□□2□-□□□-R

1
2
3
4
5
6

1. Fastening Method

M: M8
S: S8

3. Cable Connection Direction

1: Straight
2: Right-angle

5. Cable Length

C3: 0.3 m
01: 1 m

2. Connector Poles

3: 3 poles
4: 4 poles

4. Connections

Pin No.
① ③ ④
3: Brown Blue Black
Pin No.
① ② ③ ④
4: Brown White Blue Black

6. Cable Specifications

R: Vibration-proof robot cable

Mating Connectors

Item	Model
XS3H(M8)	XS3F (M8), XS3W (M8), XS3P (M8)
XS3H(S8)	XS3F (S8), XS3W (S8), XS3P (S8)

Note: M8 screw models and S8 snap-in models cannot be connected to each other.

Ordering Information

M8 Screw-on Connectors

No. of cable cores	Cable connection direction	Cable length L (m)	Model
3	Straight	0.3	XS3H-M321-3C3-R
		1	XS3H-M321-301-R
4	Straight	0.3	XS3H-M421-4C3-R
		1	XS3H-M421-401-R
	Right-angle	0.3	XS3H-M422-4C3-R
		1	XS3H-M422-401-R

S8 Snap-in Connectors

No. of cable cores	Cable connection direction	Cable length L (m)	Model
4	Straight	0.3	XS3H-S421-4C3-R
		1	XS3H-S421-401-R
	Right-angle	0.3	XS3H-S422-4C3-R
		1	XS3H-S422-401-R

XS3P Panel-mounting Sockets for Terminal Boxes

- M8 Screw-mounting Sockets with DIP Pins
- M8 Screw-mounting Sockets with Solder Cup Pins
- M8 Screw-mounting Sockets with Solder Cup Pins

XS3P-M421-1
 XS3P-M421-2
 XS3P-M422-2

Dimensions

(Unit: mm)

XS3P-M421-1 (DIP Pins)
 Front lock or rear lock

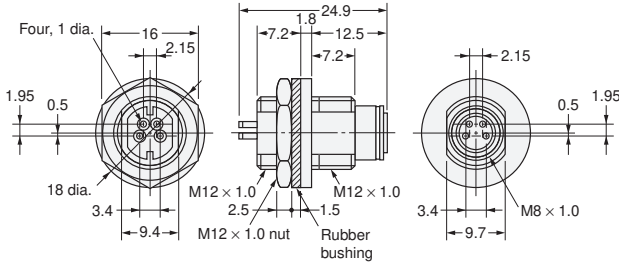

XS3P-M421-2 (Solder Cup Pins)
 Front lock or rear lock

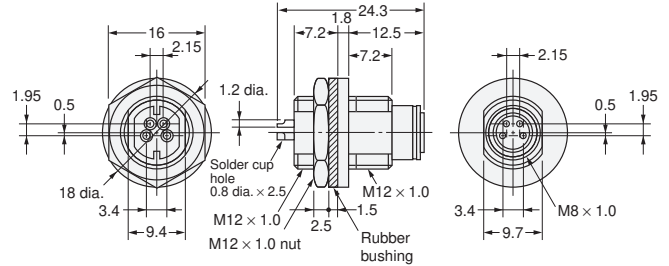

XS3P-M422-2 (Solder Cup Pins), Rear Lock Slim Models

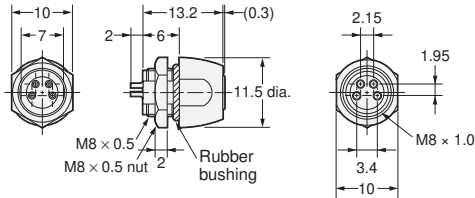

- S8 Snap-in Sockets with DIP Pins
- S8 Snap-in Sockets with Solder Cup Pins

XS3P-S421-1
 XS3P-S421-2

Dimensions

(Unit: mm)

XS3P-S421-1 (DIP Pins)
 Front lock or rear lock

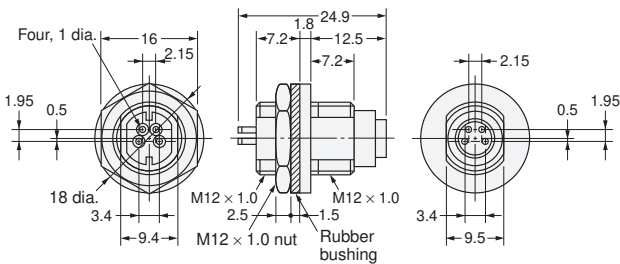

XS3P-S421-2 (Solder Cup Pins)
 Front lock or rear lock

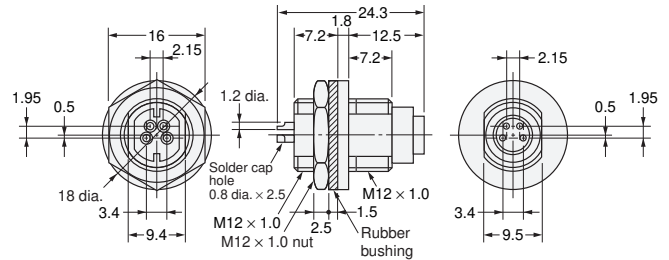

Mounting Dimensions for XS3P Screw-on Models and Snap-in Models

(Unit: mm)

Panel Cutouts

XS3P-□421-□

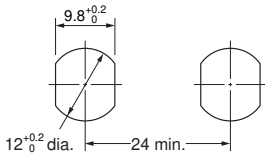

Note: The panel thickness is 1 to 3 mm.

XS3P-M422-2

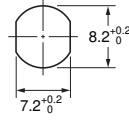

PCB-mounting Dimensions

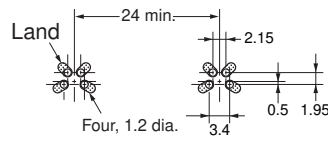

Note: The panel thickness is 2.4 mm maximum.

Panel-mounting Dimensions

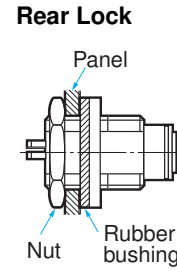

Front Lock

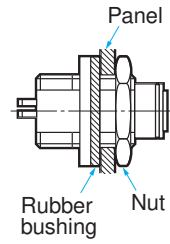

Mating Connectors

Item	Model
XS3P(M8)	XS3H (M8), XS3W (M8)
XS3P(S8)	XS3H (S8), XS3W (S8)

Note: M8 screw models and S8 snap-in models cannot be connected to each other.

Ordering Information

Connection method	Panel mounting	Pin shape	Model	Minimum order
M8 screw-mounting	Front lock or rear lock	DIP pins	XS3P-M421-1	50
		Solder cup pins	XS3P-M421-2	
	Rear lock	Solder cup pins	XS3P-M422-2	
S8 snap-in	Front lock or rear lock	DIP pins	XS3P-S421-1	
		Solder cup pins	XS3P-S421-2	

Note: Orders are accepted in multiples of the minimum order.

Safety Precautions

In addition to the following information, also refer to *Safety Precautions* on page 19

Precautions for Correct Use

Panel Mounting

- When mounting XS3P Panel-mounting Connectors to panels, refer to *Panel-mounting Dimensions* and provide rubber bushings and nuts for the Connectors. Apply a tightening torque of between 0.4 and 0.6 N·m to mount the Connectors.

XS3M Sensor Embedded Plugs

- Embedded Plugs with Screw Threads and DIP Pins
- Embedded Plugs with Screw Threads and Solder Cup Pins

XS3M-K421-1
XS3M-K421-2

Dimensions

(Unit: mm)

XS3M-K421-1

Embedded Model with DIP Pins

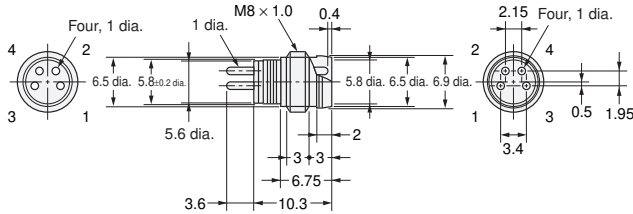
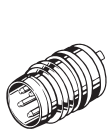

Mounting Dimensions

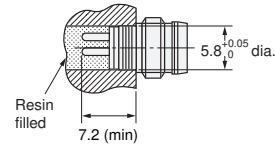

XS3M-K421-2

Embedded Model with Solder Cup Pins

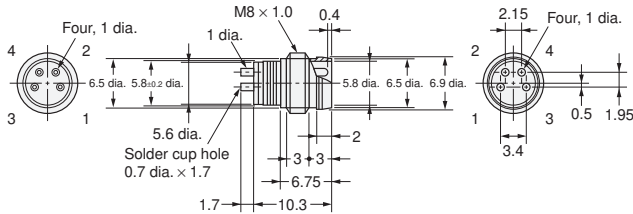

Mounting Dimensions

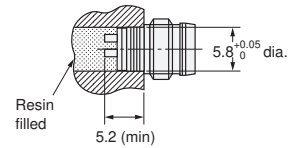

Mating Connectors

Item	Model
XS3M	XS3F (M8/S8), XS3W (M8/S8)

Note: The plug can be connected to both M8 screw and S8 snap-in models.

Ordering Information

Connection method	Pin shape	Model	Minimum order
Embedded model	DIP pins	XS3M-K421-1	200
	Solder cup pins	XS3M-K421-2	

Note: Orders are accepted in multiples of the minimum order.

XS3M Panel-mounting Plugs

● Front lock DIP pins (5 pins)

XS3M-M524-□□

Dimensions

(Unit: mm)

XS3M-M524-10

Front Lock with DIP Pins 4.5 mm (for Either Round Holes or Solder Cups), Without Shield Terminal

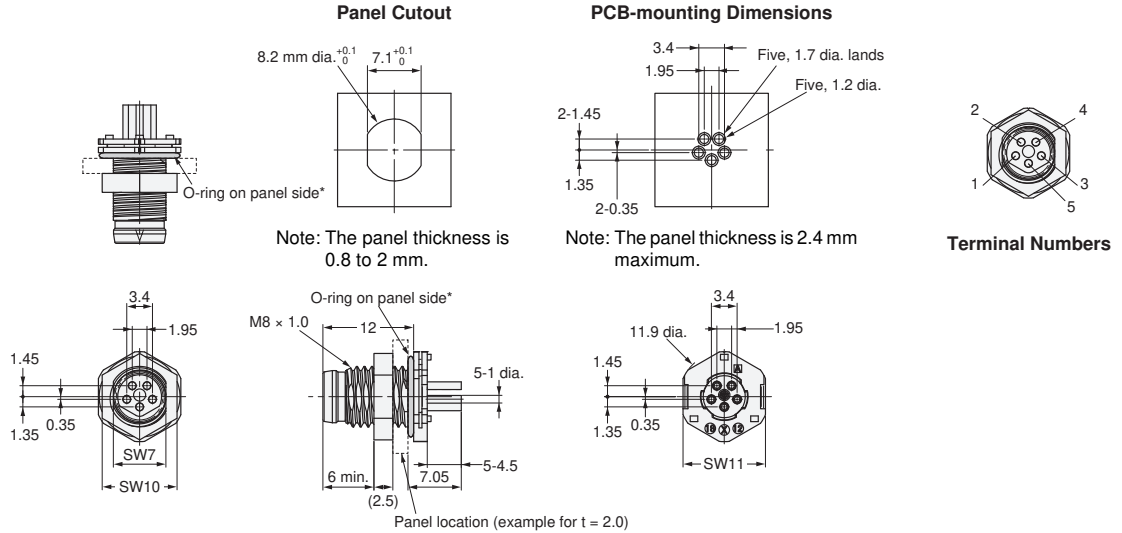
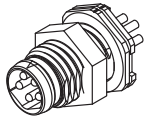

*The O-ring on the panel side maintains a waterproof structure (IP67) between the panel and Connector.

XS3M-M524-11

Front Lock with DIP Pins 4.5 mm (for Either Round Holes or Solder Cups), With Shield Terminal

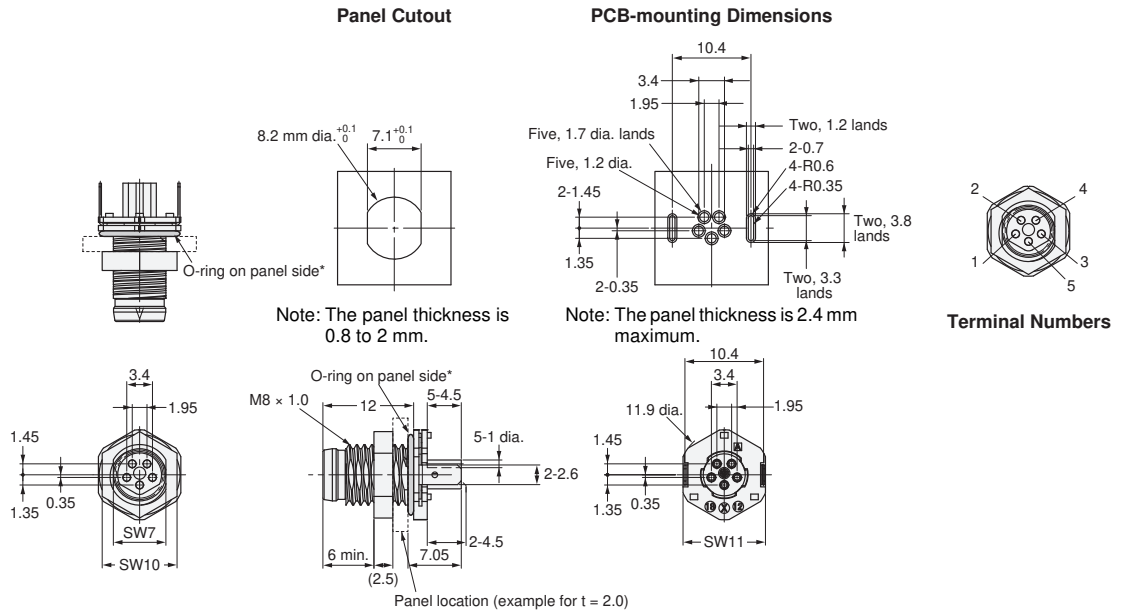
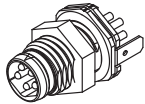

*The O-ring on the panel side maintains a waterproof structure (IP67) between the panel and Connector.

Mating Connectors

Item	Model
XS3M-M524-1□	XS3F-M52□-5□□-A

Ordering Information

Lock method	Pin shape	Shield terminal	Model
Front lock	DIP pins 4.5 mm (for either round holes or solder cups)	No	XS3M-M524-10
		Yes	XS3M-M524-11

Note: Orders are accepted in multiples of the minimum order.

Safety Precautions

In addition to the following information, also refer to *Safety Precautions* on page 19

Precautions for Correct Use

XS3M-M524-□□ Mating

To mate the Connectors, align the mating marks on the Plug and Socket (see following figure), insert the Connectors completely, and tighten the lock nut, being careful not to damage the threads.

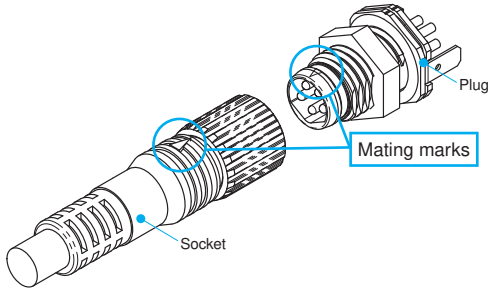

XS3M-M524-□□ Panel Mounting

After you mount the Connector to the panel, attach the nut and tighten it to a suitable torque (0.4 N·m).

XS3 M8/S8 Connector Cover

Dust Cover

XS3Z-13

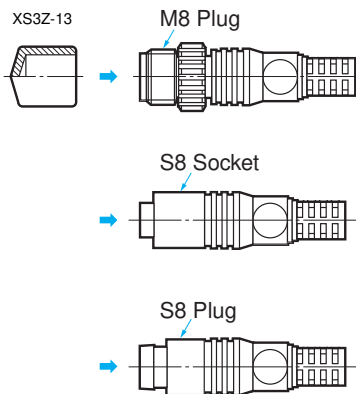

XS3Z-15

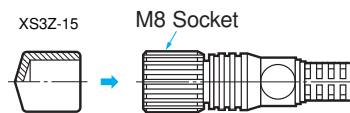

The Dust Cover is for dust prevention and does not ensure IP67. When mounting the Dust Cover to a Connector, be sure to press the Dust Cover onto the Connector until the Connector is fully inserted into the Dust Cover.

Model	Material	Suitable connector	
		Model	Mounting portion
XS3Z-13	PVC resin/red	XS3H/XS3W/XS3R	M8 plug
		XS3F/XS3W	S8 socket
		XS3H/XS3W	S8 plug
		XS3M	M8/S8 plug
XS3Z-15		XS3F/XS3W/XS3R	M8 socket

XS3R Y-Joint Plug/Socket Connectors

● Screw-on Models (M8)

With Standard Cable:
Without Cable:

XS3R-M426-1□□□-A
XS3R-M426-□

Dimensions

(Unit: mm)

XS3R-M426-1□□□-A

Connectors on Both Cable Ends (Y-Joint Plug/Socket)

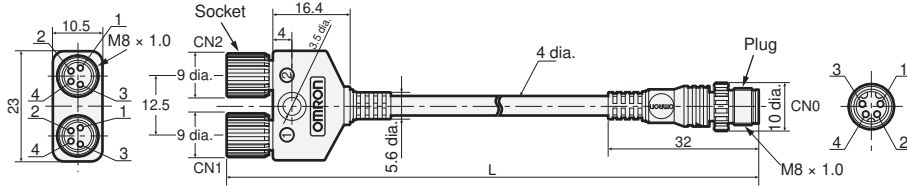

XS3R-M426-1□□□0-A

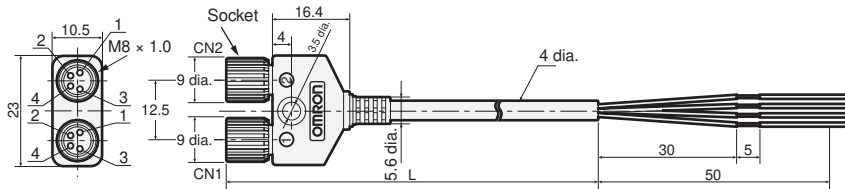

XS3R-M426-□

Connector on Both Ends (Y-Joint Plug/Socket) without Cable

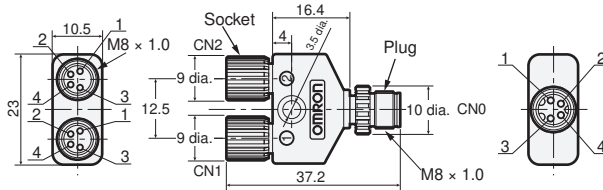

Wiring Diagram

XS3R-M426-1□□□-A

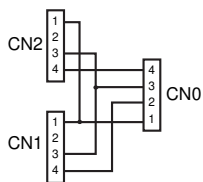

XS3R-M426-1□□□0-A

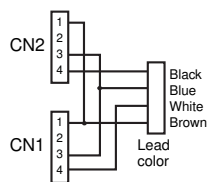

XS3R-M426-1

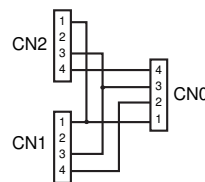

XS3R-M426-5

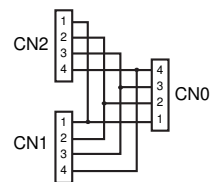

Mating Connectors

Item	Model
XS3R(M8)	XS3F(M8)
	XS3H(M8)
	XS3W(M8)
	XS3P(M8)

Ordering Information

For M8 Connectors

Cable	Connector	Cable length L (m)	Model	Minimum order
With cable	Connectors on both cable ends	0.5	XS3R-M426-1C51-A	5
		1	XS3R-M426-1011-A	
		2	XS3R-M426-1021-A	
		3	XS3R-M426-1031-A	
	Connector on one cable end	2	XS3R-M426-1020-A	
Without cable	Connectors on both cable ends	5	XS3R-M426-1050-A	10
		---	XS3R-M426-1	
		---	XS3R-M426-5	

Safety Precautions

Precautions for Correct Use

Do not use the product in atmospheres or environments that exceed product ratings.

Connections

- The XS3 and XS2 Sensor I/O Connectors cannot be connected to each other.
- You cannot mate Connectors that have a different number of poles.
- When using Sensors with Connectors or Limit Switches, use the Sensor I/O Connectors specified in the catalog.
- Do not connect M8 screw models and S8 snap-in models together, otherwise the proper degree of protection of the Connectors will not be maintained.

Connector Connection and Disconnection

- Before connecting or disconnecting Connectors, make sure that no power is being supplied to the Connectors.
- When connecting or disconnecting Connectors, be sure to hold the Connectors by hand. Do not disconnect the Connectors by pulling the cable.
- Do not touch the engagement side of any Connector with wet hands. If there is any water on the Connector or near the Connector, be sure to wipe off the water before connecting or disconnecting the Connector, otherwise the Connector may short-circuit internally or not ensure good insulation.
- Make sure that engagement side of any Connector is free of metal dust or power.
- Do not use pliers to tighten mounting the thread bracket, otherwise the thread bracket may be damaged. Be sure to tighten each thread bracket by hand within a torque of 0.2 N·m. If the thread bracket is not tightened securely, the Connector may not maintain its proper degree of protection or the thread bracket may fall off due to vibration.
- When you tighten or loosen a lock nut, hold onto only the lock nut.
If you hold onto the cover or cable, excessive rotational force will be applied to the Connector and may damage it.
- Fully insert S8 snap-in models until the Connectors are hidden by the metal casing of the opposite parts, otherwise the Connectors will not maintain their proper degree of protection or the thread brackets may become loose due to vibration.

Degree of Protection

- Do not impose external force continuously on the joints of pin blocks and covers, otherwise the Connectors may not keep its proper degree of protection (i.e., IP67).
- Connectors are not fully watertight. Do not use them underwater.
- The Connectors are not oil-resistant. Do not use them where they would be subject to oil.
- If Connectors are used in places with vibration or shock, secure the engaged side of each Connector, otherwise the Connectors may be disconnected or fail to maintain their proper degree of protection.
- Connectors are of resin mold construction. Do not impose excessive force on them.

Storage

Do not store Connectors for long periods of time in the following locations

- Locations subject to dust or high humidity
- Locations subject to ammonia gas or sulfide gas

Installation

- Do not make any cable bends near the base of the Unit.
- Any bends made must have a minimum radius of 36 mm.

Terms and Conditions Agreement

Read and understand this catalog.

Please read and understand this catalog before purchasing the products. Please consult your OMRON representative if you have any questions or comments.

Warranties.

(a) Exclusive Warranty. Omron's exclusive warranty is that the Products will be free from defects in materials and workmanship for a period of twelve months from the date of sale by Omron (or such other period expressed in writing by Omron). Omron disclaims all other warranties, express or implied.

(b) Limitations. OMRON MAKES NO WARRANTY OR REPRESENTATION, EXPRESS OR IMPLIED, ABOUT NON-INFRINGEMENT, MERCHANTABILITY OR FITNESS FOR A PARTICULAR PURPOSE OF THE PRODUCTS. BUYER ACKNOWLEDGES THAT IT ALONE HAS DETERMINED THAT THE PRODUCTS WILL SUITABLY MEET THE REQUIREMENTS OF THEIR INTENDED USE.

Omron further disclaims all warranties and responsibility of any type for claims or expenses based on infringement by the Products or otherwise of any intellectual property right. (c) Buyer Remedy. Omron's sole obligation hereunder shall be, at Omron's election, to (i) replace (in the form originally shipped with Buyer responsible for labor charges for removal or replacement thereof) the non-complying Product, (ii) repair the non-complying Product, or (iii) repay or credit Buyer an amount equal to the purchase price of the non-complying Product; provided that in no event shall Omron be responsible for warranty, repair, indemnity or any other claims or expenses regarding the Products unless Omron's analysis confirms that the Products were properly handled, stored, installed and maintained and not subject to contamination, abuse, misuse or inappropriate modification. Return of any Products by Buyer must be approved in writing by Omron before shipment. Omron Companies shall not be liable for the suitability or unsuitability or the results from the use of Products in combination with any electrical or electronic components, circuits, system assemblies or any other materials or substances or environments. Any advice, recommendations or information given orally or in writing, are not to be construed as an amendment or addition to the above warranty.

See <http://www.omron.com/global/> or contact your Omron representative for published information.

Limitation on Liability; Etc.

OMRON COMPANIES SHALL NOT BE LIABLE FOR SPECIAL, INDIRECT, INCIDENTAL, OR CONSEQUENTIAL DAMAGES, LOSS OF PROFITS OR PRODUCTION OR COMMERCIAL LOSS IN ANY WAY CONNECTED WITH THE PRODUCTS, WHETHER SUCH CLAIM IS BASED IN CONTRACT, WARRANTY, NEGLIGENCE OR STRICT LIABILITY.

Further, in no event shall liability of Omron Companies exceed the individual price of the Product on which liability is asserted.

Suitability of Use.

Omron Companies shall not be responsible for conformity with any standards, codes or regulations which apply to the combination of the Product in the Buyer's application or use of the Product. At Buyer's request, Omron will provide applicable third party certification documents identifying ratings and limitations of use which apply to the Product. This information by itself is not sufficient for a complete determination of the suitability of the Product in combination with the end product, machine, system, or other application or use. Buyer shall be solely responsible for determining appropriateness of the particular Product with respect to Buyer's application, product or system. Buyer shall take application responsibility in all cases.

NEVER USE THE PRODUCT FOR AN APPLICATION INVOLVING SERIOUS RISK TO LIFE OR PROPERTY OR IN LARGE QUANTITIES WITHOUT ENSURING THAT THE SYSTEM AS A WHOLE HAS BEEN DESIGNED TO ADDRESS THE RISKS, AND THAT THE OMRON PRODUCT(S) IS PROPERLY RATED AND INSTALLED FOR THE INTENDED USE WITHIN THE OVERALL EQUIPMENT OR SYSTEM.

Programmable Products.

Omron Companies shall not be responsible for the user's programming of a programmable Product, or any consequence thereof.

Performance Data.

Data presented in Omron Company websites, catalogs and other materials is provided as a guide for the user in determining suitability and does not constitute a warranty. It may represent the result of Omron's test conditions, and the user must correlate it to actual application requirements. Actual performance is subject to the Omron's Warranty and Limitations of Liability.

Change in Specifications.

Product specifications and accessories may be changed at any time based on improvements and other reasons. It is our practice to change part numbers when published ratings or features are changed, or when significant construction changes are made. However, some specifications of the Product may be changed without any notice. When in doubt, special part numbers may be assigned to fix or establish key specifications for your application. Please consult with your Omron's representative at any time to confirm actual specifications of purchased Product.

Errors and Omissions.

Information presented by Omron Companies has been checked and is believed to be accurate; however, no responsibility is assumed for clerical, typographical or proofreading errors or omissions.

2013.7

In the interest of product improvement, specifications are subject to change without notice.

OMRON Corporation
Industrial Automation Company

<http://www.ia.omron.com/>

(c)Copyright OMRON Corporation 2013 All Right Reserved.