

R88A-MCW151-E
R88A-MCW151-DRT-E

Motion Control Option Board

OPERATION MANUAL

OMRON

MCW151 Series Motion Control Option Board

Models:

**R88A-MCW151-E
R88A-MCW151-DRT-E**



Operation Manual

Produced March 2003

Notice:

OMRON products are manufactured for use according to proper procedures by a qualified operator and only for the purposes described in this manual.

The following conventions are used to indicate and classify precautions in this manual. Always heed the information provided with them. Failure to heed precautions can result in injury to people or damage to property.

-  **DANGER** Indicates an imminently hazardous situation which, if not avoided, will result in death or serious injury.
-  **WARNING** Indicates a potentially hazardous situation which, if not avoided, could result in death or serious injury.
-  **Caution** Indicates a potentially hazardous situation which, if not avoided, may result in minor or moderate injury, or property damage.

OMRON Product References

All OMRON products are capitalized in this manual. The word “Unit” is also capitalized when it refers to an OMRON product, regardless of whether or not it appears in the proper name of the product.

The abbreviation “Ch”, which appears in some displays and on some OMRON products, often means “word” and is abbreviated “Wd” in documentation in this sense.

The abbreviation “PC” means Programmable Controller and is not used as an abbreviation for anything else.

Visual Aids

The following headings appear in the left column of the manual to help you locate different types of information.

Note Indicates information of particular interest for efficient and convenient operation of the product.

1,2,3... Indicates lists of one sort or another, such as procedures, checklists, etc.

Trademarks and Copyrights

DeviceNet is a registered trademark of the Open DeviceNet Vendor Association, Inc.

© OMRON, 2003

All rights reserved. No part of this publication may be reproduced, stored in a retrieval system, or transmitted, in any form, or by any means, mechanical, electronic, photocopying, recording, or otherwise, without the prior written permission of OMRON.

No patent liability is assumed with respect to the use of the information contained herein. Moreover, because OMRON is constantly striving to improve its high-quality products, the information contained in this manual is subject to change without notice. Every precaution has been taken in the preparation of this manual. Nevertheless, OMRON assumes no responsibility for errors or omissions. Neither is any liability assumed for damages resulting from the use of the information contained in this publication.

About this Manual:

This manual describes the installation and operation of the R88A-MCW151-E and R88A-MCW151-DRT-E Motion Control Option Boards (MC Units) and includes the sections described below.

Please read this manual and the related manuals listed in the following table carefully and be sure you understand the information provided before attempting to install or operate the MC Unit. Be sure to read the precautions provided in the following section.

Name	Cat. No.	Contents
MCW151 Series R88A-MCW151-E R88A-MCW151-DRT-E Operation Manual	I203	Describes the installation and operation of the R88A-MCW151-E and MCW151-DRT-E Motion Control Units. (This manual)
OMNUC W-series R88M-W□ (AC Servomotors) R88D-W□ (AC Servo Drivers) User's manual	I531	Describes the installation and operation of the W-series Servo Driver and Servomotor.
DeviceNet Operation Manual	W267	Describes the configuration and construction of a DeviceNet network, including installation procedures and specifications for cables, connectors, and other connection devices, as well as information on the communications power supply.
DeviceNet Configurator Operation Manual	W328	Describes the operation of the DeviceNet Configurator to allocate remote I/O areas according to application needs, as well as procedures to set up a DeviceNet network with more than one master.

Precautions provides general precautions for using the MC Unit and related devices.

Section 1 describes the features and system configuration of the R88A-MCW151-E and R88A-MCW151-DRT-E Motion Control Units and concepts related to their operation.

Section 2 describes the MC Unit components and provides the information for installing the MC Unit.

Section 3 describes the different Motion Control features of the MCW151. Also the functionality of the Servo Driver related commands are explained.

Section 4 describes the communication components of the MCW151-E and MCW151-DRT-E. The functionality of the serial communication protocols and the DeviceNet interface are explained.

Section 5 provides an overview of the fundamentals of multitasking BASIC programs and the methods by which programs are managed in the MC Unit.

Section 6 describes all commands, functions and parameters required for programing the motion control application using the MC Unit.

Section 7 describes the operation of the Motion Perfect programming software package. Motion Perfect provides the user a tool to program, monitor and debug motion based applications for the MC Unit.

Section 8 describes error processing and troubleshooting procedures needed to keep the system operating properly.

Section 9 explains the maintenance and inspection procedures that must be followed to keep the MC Unit operating in optimum condition. It also includes proper procedures when replacing an MC Unit.

The **Appendices** provide the required parameter settings for the Servo Driver, the DeviceNet protocol specification and some general programming examples.

	<p>WARNING Failure to read and understand the information provided in this manual may result in personal injury or death, damage to the product, or product failure. Please read each section in its entirety and be sure you understand the information provided in the section and related sections before attempting any of the procedures or operations given.</p>
---	---

TABLE OF CONTENTS

PRECAUTIONS	xi
1 Intended Audience	xii
2 General Precautions	xii
3 General Warnings and Safety Precautions	xii
4 Storage and Transportation Precautions	xiv
5 Installation and Wiring Precautions	xiv
6 Operation and Adjustment Precautions	xv
7 Maintenance and Inspection Precautions	xv
8 Conformance to EC Directives	xv
 SECTION 1	
Features and System Configuration	1
1-1 Features	2
1-2 System Configuration	5
1-3 Motion Control Concepts	7
1-4 Control System Configuration	14
1-5 Specifications	19
1-6 Comparison between Firmware Versions	21
 SECTION 2	
Installation	23
2-1 Components and Unit Settings	24
2-2 Installation	28
2-3 Wiring	30
2-4 Servo System Precautions	39
2-5 Wiring Precautions	40
 SECTION 3	
Motion Control Functions	43
3-1 Overview	44
3-2 System Set-up	46
3-3 System Functions	47
 SECTION 4	
Communication Interfaces	59
4-1 Serial Communications	60
4-2 DeviceNet (MCW151-DRT-E only)	68

TABLE OF CONTENTS

SECTION 5

Multitasking BASIC Programming	85
5-1 Overview	86
5-2 BASIC Programming	86
5-3 Motion Execution	89
5-4 Command Line Interface	90
5-5 BASIC Programs	90
5-6 Task Operation Sequence	93
5-7 Error Processing	94

SECTION 6

BASIC Motion Control Programming Language	97
6-1 Overview	102
6-2 Command Reference List	103
6-3 Command, function and parameter description	111

SECTION 7

Motion Perfect Software Package	197
7-1 Features and Requirements	198
7-2 Connecting to the MC Unit	198
7-3 Motion Perfect Projects	199
7-4 Desktop Appearance	201
7-5 Motion Perfect Tools	204
7-6 Suggestions and Precautions	217

SECTION 8

Troubleshooting	219
8-1 Error Indicators	220
8-2 Error Handling	221
8-3 Problems and Countermeasures	227

SECTION 9

Maintenance and Inspection	233
9-1 Routine Inspections	234
9-2 Replacing a MC Unit	235

Appendices

Appendix A Servo Driver Parameter List	237
Appendix B Device Protocol (MCW151-DRT-E only)	239
Appendix C Programming Examples	245

Index	255
--------------------	------------

Revision History	261
-------------------------------	------------

PRECAUTIONS

This section provides general precautions for using the Motion Control Unit and related devices.

The information contained in this section is important for the safe and reliable application of the Motion Control Unit. You must read this section and understand the information contained before attempting to set up or operate a Motion Control Unit and Servo Driver.

1	Intended Audience	xii
2	General Precautions	xii
3	General Warnings and Safety Precautions	xii
4	Storage and Transportation Precautions	xiv
5	Installation and Wiring Precautions	xiv
6	Operation and Adjustment Precautions	xv
7	Maintenance and Inspection Precautions	xv
8	Conformance to EC Directives	xv
8-1	Concepts	xvi
8-1-1	Conformance to EC Directives	xvi

1 Intended Audience

This manual is intended for the following personnel, who must also have knowledge of electrical systems (an electrical engineer or the equivalent).

- Personnel in charge of installing FA systems.
- Personnel in charge of designing FA systems.
- Personnel in charge of managing FA systems and facilities.

2 General Precautions

The user must operate the product according to the performance specifications described in the operation manuals. You should assume that anything not described in this manual is not possible.

Before using the product under the following conditions, consult your OMRON representative, make sure the ratings and performance characteristics of the products are good enough for the systems, machines, or equipment, and be sure to provide the systems, machines, or equipment with double safety mechanisms.

1. Conditions not described in the manual.
2. The application of the product to nuclear control systems, railroad systems, aviation systems, vehicles, combustion systems, medical equipment, amusement machines, or safety equipment.
3. The application of the product to systems, machines, or equipment that may have a serious influence on human life and property if they are used improperly.

 **WARNING** It is extremely important that Motion Control Units and related devices be used for the specified purpose and under the specified conditions, especially in applications that can directly or indirectly affect human life. You must consult with your OMRON representative before applying Motion Control Units and related devices to the above mentioned applications.

3 General Warnings and Safety Precautions

Observe the following warnings when using the MC Unit and all peripheral devices.

Consult your OMRON representative when using the product after a long period of storage.

 **WARNING** Always connect the frame ground terminals of the Servo Driver and the Servomotor to a class-3 ground (to 100 Ω or less). Not connecting to a class-3 ground may result in electric shock.

 **WARNING** The product contains dangerous high voltage inside. Turn OFF the power and wait for at least five minutes to allow power to discharge before handling or working with the product.









 **WARNING** Do not touch the inside of the Servo Driver. Doing so may result in electric shock.

 **WARNING** Do not remove the front cover, terminal covers, cables, Parameter Units, or optional items while the power is being supplied. Doing so may result in electric shock.



 **WARNING** Installation, operation, maintenance, or inspection must be performed by authorized personnel. Not doing so may result in electric shock or injury.

 **WARNING** Wiring or inspection must not be performed for at least five minutes after turning OFF the power supply. Doing so may result in electric shock.















 **WARNING** Do not damage, press, or put excessive stress or heavy objects on the cables. Doing so may result in electric shock, stopping operation of the product, or burning.

-  **WARNING** Do not touch the rotating parts of the Servomotor in operation. Doing so may result in injury.
-  **WARNING** Do not modify the product. Doing so may result in injury or damage to the product.
-  **WARNING** Provide safety measures in external control circuits (i.e., not in the MC Unit) to ensure safety in the system if an abnormality occurs due to malfunction of the MC Unit, incorrect or unintended configuration and programming of the MC Unit or external factors affecting the operation of the MC Unit. Not providing sufficient safety measures may result in serious accidents, or property damage.
- The MC Unit outputs may remain ON or OFF due to deposits on or burning of the output relays, or destruction of the output transistors. As a counter-measure for such problems, external safety measures must be provided to ensure safety in the system.
 - Provide an external emergency stopping device that allows an instantaneous stop of operation and power interruption. Not doing so may result in injury.
 - Emergency stop circuits, interlock circuits, limit circuits, and similar safety measures must be provided in external control circuits.
 - When the 24-VDC output (service power supply to the Unit) is overloaded or short-circuited, the voltage may drop and result in the outputs being turned OFF. As a counter-measure for such problems, external safety measures must be provided to ensure safety in the system.
-  **WARNING** It is the nature of high speed motion control and motion control language programming and multi-tasking systems, that it is not always possible for the system to validate the inputs to the functions or to validate the combination of functions.
-  **WARNING** It is the responsibility of the programmer to ensure that the various BASIC statements are invoked correctly with the correct number of parameters and inputs, that the values are correctly validated prior to the actual calling of the functions, and that the BASIC program(s) provide the desired functionality for the application. Failure to do so may result in unexpected behaviour, loss or damage to the machinery.
-  **Caution** When the SERVO_PERIOD parameter has been set to change the servo cycle period of the MC Unit, a power down or software reset (using DRV_RESET) must be performed for the complete system. Not doing so may result in undefined behaviour.
-  **Caution** Use the Servomotors and Servo Drivers in a specified combination. Using them incorrectly may result in fire or damage to the product.
-  **Caution** Do not operate the control system in the following locations:
- Locations subject to direct sunlight.
 - Locations subject to temperatures or humidity outside the range specified in the specifications.
 - Locations subject to condensation due to radical temperature changes.
 - Locations subject to corrosive or inflammable gases.
 - Locations subject to dust (especially iron dust) or salts.
 - Locations subject to vibration or shock.
 - Locations subject to exposure to water, oil or chemicals.
-  **Caution** Do not touch the Servo Driver radiator, Regeneration Resistor, or Servomotor while the power is being supplied or soon after power is turned OFF. Doing so may result in a skin burn due to the hot surface.











4 Storage and Transportation Precautions

-  **Caution** Do not hold the product by the cables or motor shaft while transporting it. Doing so may result in injury or malfunction.
-  **Caution** Do not place any load exceeding the figure indicated on the product. Doing so may result in injury or malfunction.
-  **Caution** Use the motor eye-bolts only for transporting the Motor. Using them for transporting the machinery may result in injury or malfunction.



5 Installation and Wiring Precautions

-  **Caution** Do not step or place a heavy object on the product. Doing so may result in injury.
-  **Caution** Do not cover the inlet or outlet ports and prevent any foreign objects from entering the product. Doing so may result in fire.
-  **Caution** Be sure to install the product in the right direction. Not doing so may result in malfunction.
-  **Caution** Provide the specified clearance between the Servo Driver and the control panel or with other devices. Not doing so may result in fire or malfunction.
-  **Caution** Do not apply any strong impact. Doing so may result in malfunction.
-  **Caution** Be sure to wire correctly and securely. Not doing so may result in motor runaway, injury, or malfunction.
-  **Caution** Be sure that all mounting screws, terminal screws, and cable connector screws are tightened securely. Incorrect tightening may result in malfunction.
-  **Caution** Use crimp terminals for wiring. Do not connect bare stranded wires directly to terminals. Connection of bare stranded wires may result in fire.
-  **Caution** Always use the power supply voltages specified in the manual. An incorrect voltage may result in malfunction or burning.
-  **Caution** Take appropriate measures to ensure that the specified power with the rated voltage and frequency is supplied. Be particularly careful in places where the power supply is unstable. An incorrect power supply may result in malfunction.
-  **Caution** Install external breakers and take other safety measures against short-circuiting in external wiring. Insufficient safety measures against short-circuiting may result in burning.
-  **Caution** Take appropriate and sufficient countermeasures when installing systems in the following locations. Not doing so may result in damage to the product.
 - Locations subject to static electricity or other sources of noise.
 - Locations subject to strong electromagnetic fields.
 - Locations subject to possible exposure to radiation.
 - Locations near power supply lines.
-  **Caution** Do not reverse the polarity of the battery when connecting it. Reversing the polarity may damage the battery or cause it to explode.
-  **Caution** Before touching a Unit, be sure to first touch a grounded metallic object in order to discharge any static build-up. Not doing so may result in malfunction or damage.

6 Operation and Adjustment Precautions

-  **Caution** Confirm that no adverse effects will occur in the system before performing the test operation. Not doing so may result in damage to the product.
-  **Caution** Check the modified user programs, newly set parameters and switches for proper execution before actually running them. Not doing so may result in damage to the product.
-  **Caution** Do not make any extreme adjustments or setting changes. Doing so may result in unstable operation and injury.
-  **Caution** Separate the Servomotor from the machine, check for proper operation, and then connect to the machine. Not doing so may cause injury.
-  **Caution** When an alarm occurs, remove the cause, reset the alarm after confirming safety, and then resume operation. Not doing so may result in injury.
-  **Caution** Do not come close to the machine immediately after resetting momentary power interruption to avoid an unexpected restart. (Take appropriate measures to secure safety against an unexpected restart.) Doing so may result in injury.
-  **Caution** Confirm that no adverse effect will occur in the system before attempting any of the following. Not doing so may result in an unexpected operation or damage to the product.
- Changing the present values or set values.
 - Changing the parameters.
 - Modifying (one of) the application programs.
-  **Caution** Do not save data into the flash memory during memory operation or while the motor is running. Otherwise, unexpected operation may be caused.
-  **Caution** Do not turn OFF the power supply to the Unit while data is being written to flash memory. Doing so may cause problems with the flash memory.
-  **Caution** Do not turn OFF the power supply to the Unit while data is being transferred. Doing so may result in malfunction or damage to the product.
-  **Caution** Do not download any firmware to the MC Unit that has not been distributed by OMRON or that has not been authorized and approved by OMRON for downloading into the MCW151 series. Failure to do so may result in permanent or temporary malfunction of the Unit or unexpected behaviour.

7 Maintenance and Inspection Precautions

-  **WARNING** Do not attempt to disassemble, repair, or modify any Units. Any attempt to do so may result in malfunction, fire, electric shock, or injury.
-  **Caution** Resume operation only after transferring to the new Unit the contents of the data required for operation. Not doing so may result in an unexpected operation or damage to the product.

8 Conformance to EC Directives

Applicable Directives

- EMC Directives
- Low Voltage Directive

8-1 Concepts

EMC Directives

OMRON devices that comply with EC Directives also conform to the related EMC standards so that they can be more easily built into other devices or machines. The actual products have been checked for conformity to EMC standards (see the following note). Whether the products conform to the standards in the system used by the customer, however, must be checked by the customer. EMC-related performance of the OMRON devices that comply with EC Directives will vary depending on the configuration, wiring, and other conditions of the equipment or control panel in which the OMRON devices are installed. The customer must, therefore, perform final checks to confirm that devices and the over-all machine conform to EMC standards.

Note Applicable EMC (Electromagnetic Compatibility) standards are as follows:

EMS (Electromagnetic Susceptibility): EN61000-6-2, EN50082-2

EMI (Electromagnetic Interference): EN55011 Class A Group 1

Low Voltage Directive

Always ensure that devices operating at voltages of 50 to 1,000 VAC or 75 to 1,500 VDC meet the required safety standards.

8-1-1 Conformance to EC Directives

The W-series Servo Driver complies with EC Directives. To ensure that the machine or device in which a Servo Driver and MC Unit are used complies with EC directives, the Servo System must be installed as follows (refer to *OMNUC W-series User's manual (1531)*):

- 1,2,3...**
1. The Servo Driver must be mounted in a metal case (control box). (It is not necessary to mount the Servomotor in a metal box.)
 2. Noise filters and surge absorbers must be inserted in power supply lines.
 3. Shielded cable must be used for I/O signal cables and encoder cables. (Use soft steel wire.)
 4. Cables leading out from the control box must be enclosed within metal ducts or conduits with blades.
 5. Ferrite cores must be installed for cables with braided shields, and the shield must be directly grounded to a ground plate.

SECTION 1

Features and System Configuration

This section describes the features and system configuration of the R88A-MCW151-E and R88A-MCW151-DRT-E Motion Control Units and concepts related to their operation.

1-1	Features	2
1-1-1	Overview	2
1-1-2	Description of Features	3
1-2	System Configuration	5
1-3	Motion Control Concepts	7
1-3-1	PTP-control	8
1-3-2	CP-control	10
1-3-3	EG-Control	11
1-3-4	Other Operations	13
1-4	Control System Configuration	14
1-4-1	Servo System Principles	14
1-4-2	Encoder Signals	17
1-5	Specifications	19
1-5-1	General Specifications	19
1-5-2	Functional Specifications	19
1-5-3	DeviceNet Specifications (MCW151-DRT-E only)	21
1-6	Comparison between Firmware Versions	21

1-1 Features

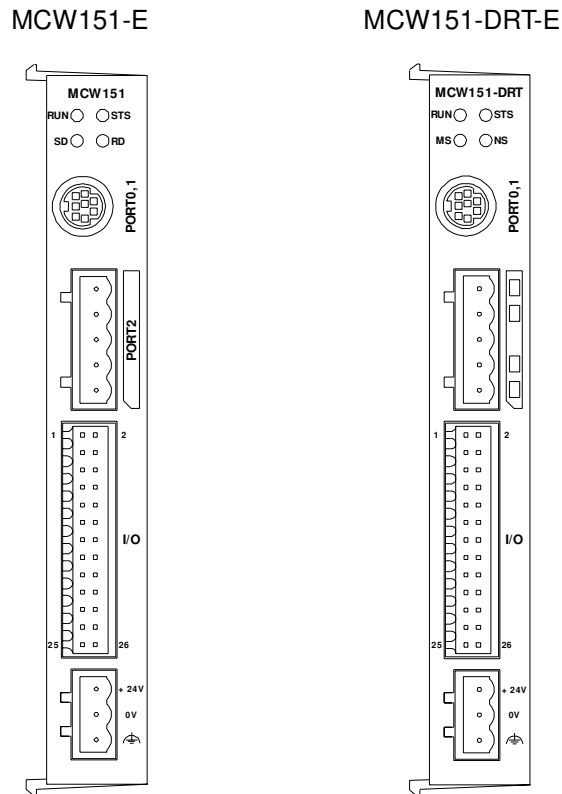

1-1-1 Overview

The R88A-MCW151 is a 1.5-axis Motion Control (MC) Unit which is connected to the W-series Servo Driver. The MC Unit provides direct control of the Servo Driver, enables both speed and torque control and has access to detailed Servo Driver data. To support a multi-axis control application, the MC Unit features both an encoder input and output connection.

There are two types of the MCW151 Motion Controllers, according to the communication interface which is integrated into the Unit.

Communication Interface	Model
RS-422A/485 Serial Communication	R88A-MCW151-E
DeviceNet	R88A-MCW151-DRT-E

The multi-tasking BASIC motion control language provides an easy to use tool for programming advanced motion control applications.

Three types of motion control are possible: point-to-point, continuous path and electronic gearing.

Point-to-point Control

Point-to-point (PTP) control enables positioning independently for each axis. Axis specific parameters and commands are used to determine the paths for the axes.

Continuous Path Control

Continuous path (CP) control enables the user not only to control the start and end positions, but also the path between those points. Possible multi-axis paths are linear interpolation and circular interpolation. Also user defined paths can be realized with the CAM control.

Electronic Gearing

Electronic gearing (EG) enables controlling an axis as a direct link to another axis. The MC Units supports electronic gear boxing, linked moves and CAM movements and adding all movements of one axis to another.

1-1-2 Description of Features

	<p>The MC Unit provides the following features.</p>
Motion Control	<p>The direct connection to the Servo Driver provides a high performance / high precision control system. Operation will be processed in optimal synchronization.</p> <ul style="list-style-type: none">• Supports both speed and torque control modes of the Servo Driver.• Supports switching between the modes during operation.• Supports speed limit during torque control using the speed reference.• Selectable MC Unit servo period cycle which can be set to either 0.5 ms or 1.0 ms.
Servo Driver Access	<p>Apart from the motion control operation with the Servo Driver, the MC Unit provides the following features:</p> <ul style="list-style-type: none">• Monitor the detailed Servo Driver alarm status.• Monitor various monitor signals (rotation speed, command torque).• Monitor the Servo Driver digital inputs and analog input to include in the application.• Read and write of the Servo Driver Parameters.• Execution of several Driver functions from the MC Unit. Examples are Print Registration, Origin Search, Driver Alarm Reset and Driver Reset.
Easy Programming with BASIC Motion Control Language	<p>The multi-task BASIC motion control language is used to program the MC Unit. A total of 14 programs can be held in the Unit and up to 3 tasks can be run simultaneously. The MC Unit is programmed using a Windows-based application called ¹Motion Perfect. Motion Perfect allows extremely flexible programming and debugging.</p>
Encoder Input and Output	<p>To achieve a solution for multi-axis applications, the MC Unit is provided with an encoder axis. This axis provides either to have an encoder input for external encoders or to have an encoder output to cascade position data to another MC Unit.</p>
DeviceNet Interface (MCW151-DRT-E only)	<p>The MCW151-DRT-E can be connected easily in an existing DeviceNet network. The DeviceNet network has a maximum communication distance of 500 m, so an MC Unit in a remote location can be controlled from the Master. The MC Unit supports both remote I/O and explicit message communications.</p> <ul style="list-style-type: none">• Remote I/O communications Remote I/O communications can exchange data (4 input words and 4 output words max.) with the MC Unit at high speed and without programming, just like regular I/O.• Explicit message communications Large data transfers to and from the MC Unit memory can be performed by sending explicit messages from the Master when required.
Serial Communications	<p>The MC Unit has three (MCW151-E) or two (MCW151-DRT-E) serial ports for communication to several external devices. Next to the connection to the Personal Computer for configuring, the MC Unit can be connected with PCs, Programming Terminals (PTs) and other MC Units. The serial ports support the Host Link Master and Slave protocols.</p>
Absolute Encoder Support	<p>By using a Servomotor with absolute encoder, the motor position is updated automatically in the MC Unit at start-up of the system. No origin search sequence will be necessary in the system initiation phase.</p>

1.Motion Perfect is a product of Trio Motion Technology Limited.

Virtual Axes

The MC Unit contains a total of 3 axes, of which two can be configured as virtual axis. The virtual axes are internal axes and are used for computational purposes. They act as perfect servo axes and are very useful for creating profiles. They can be linked directly to the servo axes.

Hardware-based Registration Inputs

There is a high-speed registration input for the encoder input and output axis. On the rising or falling edge of a registration input, the MC Unit will store the current position in a register. The registered position can then be used by the BASIC program as required. The registered positions are captured in hardware.

General-purpose Input and Output Signals

Starting, stopping, limit switching, origin searches and many other functions can be controlled by the MC Unit. The general I/O can have specific functions (such as the registration, limit switches), but also can be freely used.

Reduced Machine Wear

The traditional trapezoidal speed profile is provided to generate smooth starting and stopping. The trapezoidal corners can be rounded off to S-curves.

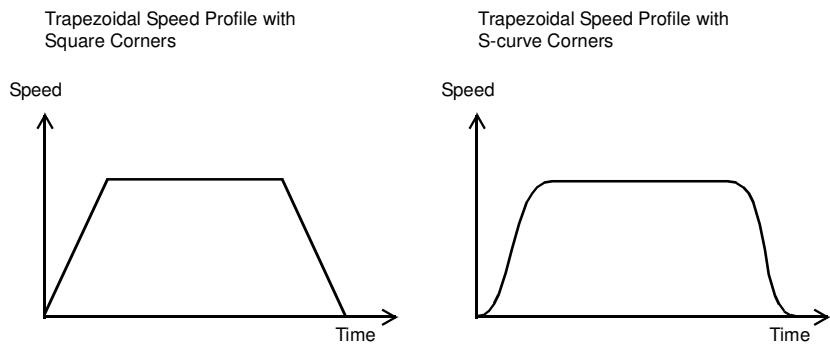

1-2 System Configuration

Basic Configuration

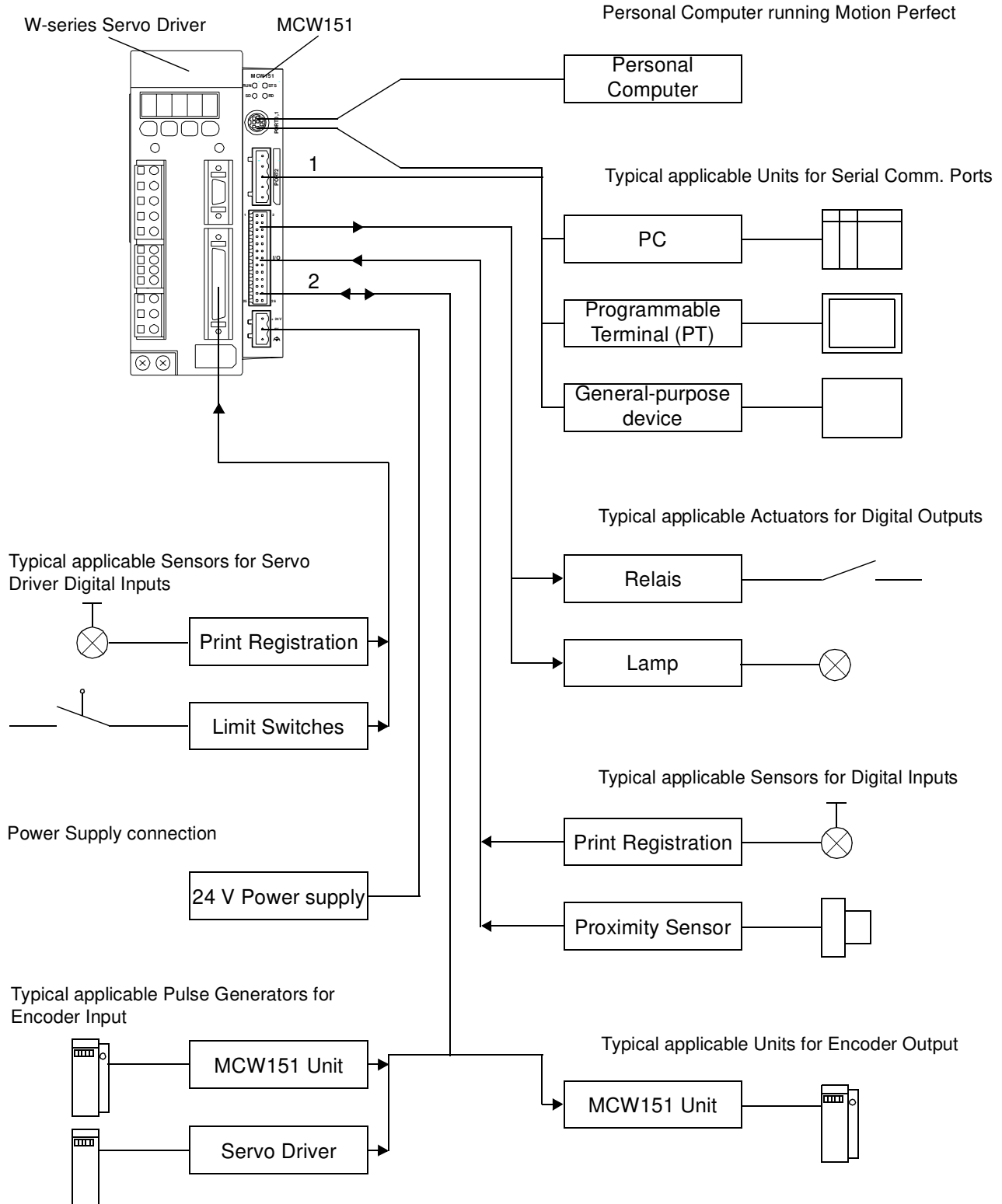

- Note**
1. The RS-422A/485 Serial Port 2 is only available on the MCW151-E Unit.
 2. The MC Unit has one encoder axis. Either the encoder input or the encoder output can be used.

The equipment and models which can be used in the system configuration are shown in the following table.

Device	Model
Motion Control Unit	R88A-MCW151-E R88A-MCW151-DRT-E
Servo Driver (see note)	R88D-WT□
Servomotor	R88M-W□
Control Devices (using Host Link)	Programmable Terminals CPU Units
Personal Computer (for Motion Perfect)	IBM Personal Computer or 100% compatible
Motion Perfect	Version 2.0 or later

Note The MC Unit must be used with a Servo Driver with software version 14 or later. The MC Unit cannot be used with software version 8.

**DeviceNet Configuration
(MCW151-DRT-E only)**

A DeviceNet system can be constructed in two ways: fixed allocation or free allocation.

Fixed Allocation

A DeviceNet system can be constructed easily without the Configurator. With fixed allocation, predetermined words are allocated to each node for the Slave's I/O.

An OMRON Master must be used in order to perform fixed allocation. Moreover, with fixed allocation only one Master Unit can be used in a DeviceNet network and only one Master Unit may be mounted to a PC.

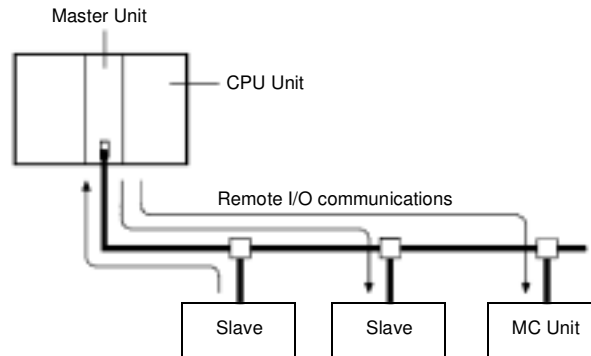

Free Allocation

The Configurator can be used to freely allocate the words used by each Slave. With free allocation, more than one Master Unit can be connected in a DeviceNet network and each Master's Slave I/O can be set independently. More than one Master Unit may be mounted to each PC and those Masters can be used independently. Furthermore, other companies' Masters can be

used. For details, refer to the *DeviceNet Configurator Operation Manual (W328)*.

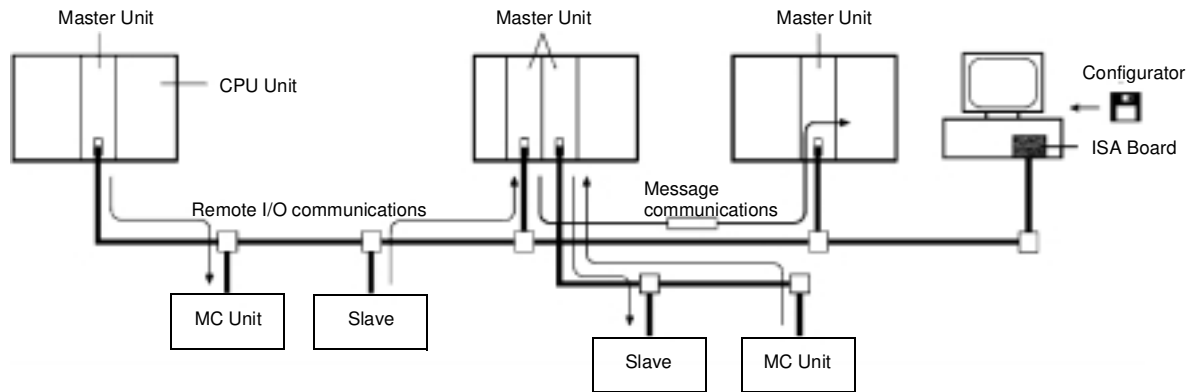

The following OMRON Master Units can be used.

Applicable PC	Master Unit model number	Mounting position	Max. number of Units	
			With Configurator	Without Configurator
CS1 Series	CS1-DRM21	CPU Rack or Expansion I/O Rack (Classified as Special I/O Units)	16	1
C200HZ/HX/HG/HE	C200HW-DRM21-V1	CPU Rack or Expansion I/O Rack (Classified as Special I/O Units)	10 or 16 (see note)	1

Note Some CPUs can control 16 Master Units and other CPUs can control 10.

1-3 Motion Control Concepts

The MC Unit offers the following types positioning control operations.

1. Point-to-point control
2. Continuous Path control
3. Electronic Gearing

This section will introduce some of the commands and parameters as used in the BASIC programming of the motion control application. Refer to *SECTION 6 BASIC Motion Control Programming Language* for details.

Coordinate System

Positioning operations performed by the MC Unit are based on an axis coordinate system. The MC Unit converts the position data from either the connected Servo Driver or the connected encoder into an internal absolute coordinate system.

The engineering unit which specifies the distances of travelling can be freely defined for each axis separately. The conversion is performed through the use of the unit conversion factor, which is defined by the UNITS axis parameter. The origin point of the coordinate system can be determined using the DEFPOS command. This command re-defines the current position to zero or any other value.

A move is defined in either absolute or relative terms. An absolute move takes the axis to a specific predefined position with respect to the origin point. A relative move takes the axis from the current position to a position that is defined relative to this current position. The following diagram shows gives an exam-

ple of relative (command MOVE) and absolute (command MOVEABS) linear moves.

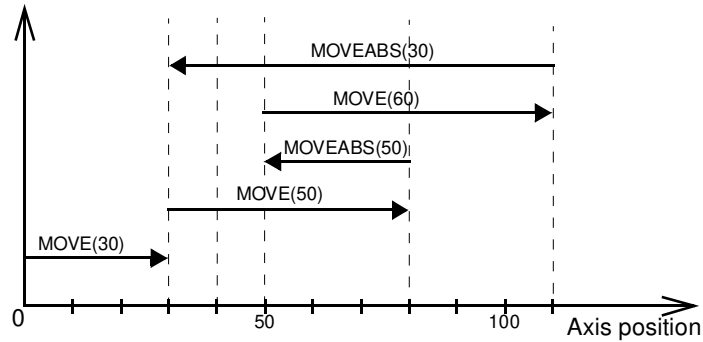

1-3-1 PTP-control

In point-to-point positioning, each axis is moved independently of the other axis. The MC Unit supports the following operations.

- Relative move
- Absolute move
- Continuous move forward
- Continuous move reverse

Relative and Absolute Moves

To move a single axis either the command MOVE for a relative move or the command MOVEABS for an absolute move is used. Each axis has its own move characteristics, which are defined by the axis parameters.

Suppose a control program is executed to move from the origin to an axis no. 0 coordinate of 100 and axis no. 1 coordinate of 50. If the speed parameter is set to be the same for both axes and the acceleration and deceleration rate are set sufficiently high, the movements for axis 0 and axis 1 will be as illustrated below.

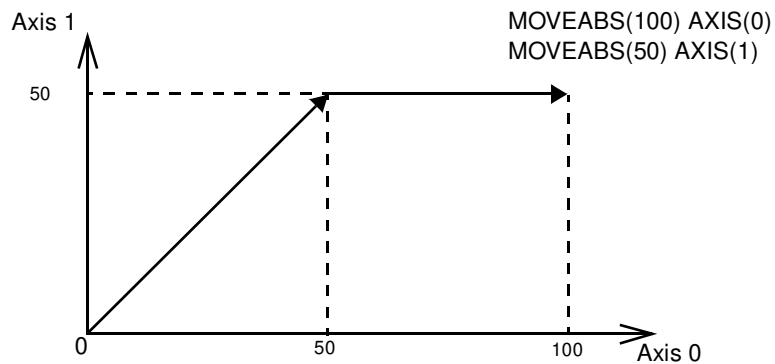

At start, both the axis 0 and axis 1 will move to a coordinate of 50 over the same duration of time. At this point, axis 1 will stop and the axis 0 will continue to move to a coordinate of 100.

Relevant Axis Parameters

As mentioned before the move of a certain axis is determined by the axis parameters. Some relevant parameters are given in the next table.

Parameter	Description
UNITS	Unit conversion factor
ACCEL	Acceleration rate of an axis in units/s ²
DECEL	Deceleration rate of an axis in units/s ²
SPEED	Demand speed of an axis in units/s

Defining moves

The speed profile below shows a simple MOVE operation. The UNITS parameter for this axis has been defined for example as meters. The required maximum speed has been set to 10 m/s. In order to reach this speed in one second and also to decelerate to zero speed again in one second, both the acceleration as the deceleration rate have been set to 10 m/s². The total distance travelled is the sum of distances travelled during the acceleration, constant speed and deceleration segments. Suppose the distance moved by the MOVE command is 40 m, the speed profile will be given by the following graph.

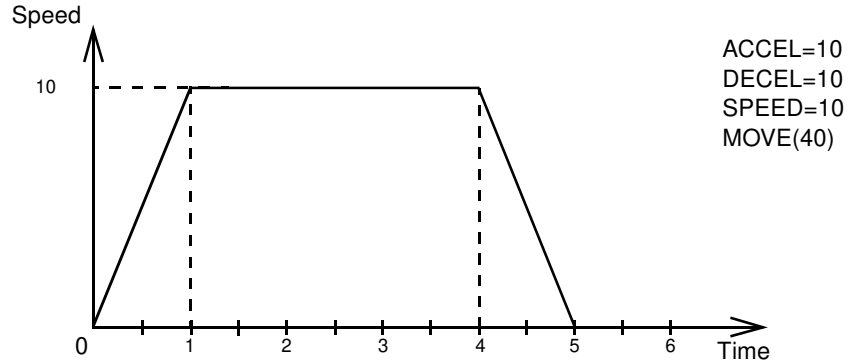

The following two speed profiles show the same movement with an acceleration time respectively a deceleration time of 2 seconds.

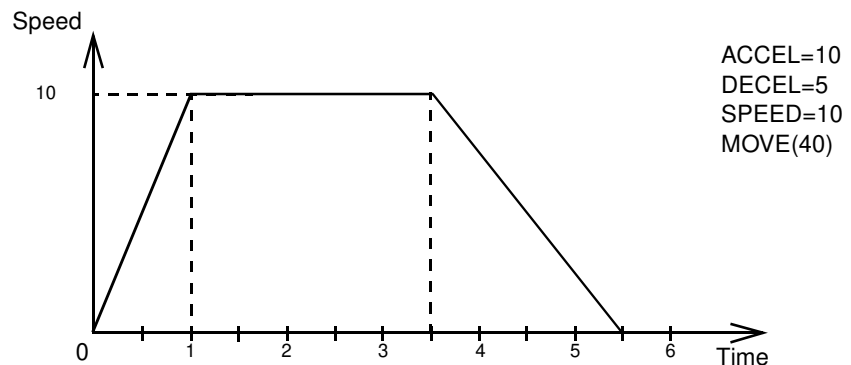
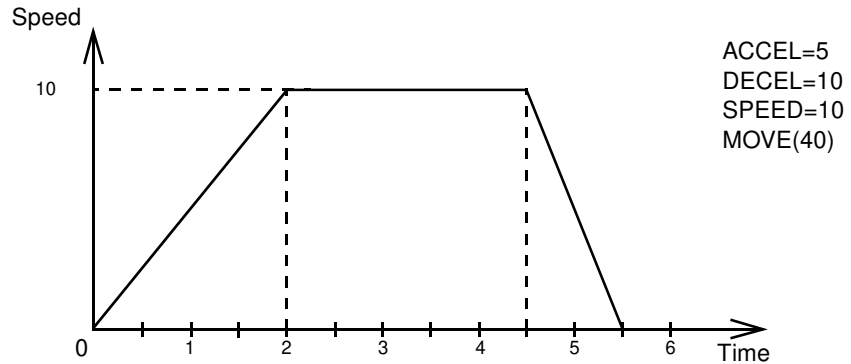

Move Calculations

The following equations are used to calculate the total time for the motion of the axes. Consider the moved distance for the MOVE command as D , the demand speed as V , the acceleration rate a and deceleration rate d .

$$\begin{aligned}
 \text{Acceleration time} &= \frac{V}{a} \\
 \text{Acceleration distance} &= \frac{V^2}{2a} \\
 \text{Deceleration time} &= \frac{V}{d} \\
 \text{Deceleration distance} &= \frac{V^2}{2d} \\
 \text{Constant speed distance} &= D - \frac{V^2(a+d)}{2ad} \\
 \text{Total time} &= \frac{D}{V} + \frac{V(a+d)}{2ad}
 \end{aligned}$$

Continuous Moves

The FORWARD and REVERSE commands can be used to start a continuous movement with constant speed on a certain axis. The FORWARD command will move the axis in positive direction and the REVERSE command in negative direction. For these commands also the axis parameters ACCEL and SPEED apply to specify the acceleration rate and demand speed.

Both movements can be canceled by using either the CANCEL or RAPID-STOP command. The CANCEL command will cancel the move for one axis and RAPIDSTOP will cancel moves on all axes. The deceleration rate is set by DECEL.

1-3-2 CP-control

Continuous Path control enables to control a specified path between the start and end position of a movement for one or multiple axes. The MC Unit supports the following operations.

- Linear interpolation
- Circular interpolation
- CAM control

Linear Interpolation

In applications it can be required for a set of motors to perform a move operation from one position to another in a straight line. Linearly interpolated moves can take place among several axes. The commands MOVE and MOVEABS are also used for the linear interpolation. In this case the commands will have multiple arguments to specify the relative or absolute move for each axis. Consider the following three axis move in a 3-dimensional plane.

MOVE(50,50,50)

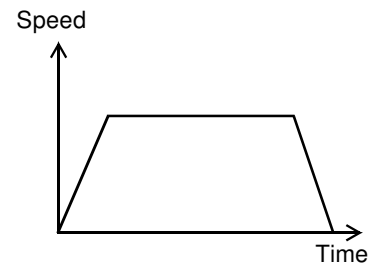
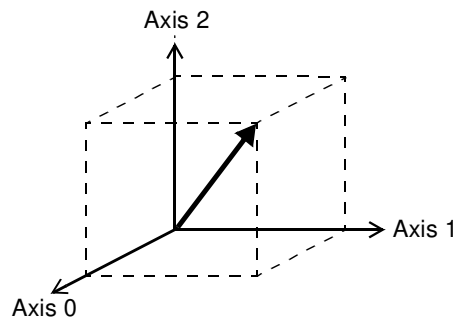

The speed profile of the motion along the path is given in the diagram. The three parameters SPEED, ACCEL and DECEL which determine the multi axis movement are taken from the corresponding parameters of the base axis. The MOVE command computes the various components of speed demand per axis.

Circular Interpolation

It may be required that a tool travels from the starting point to the end point in an arc of a circle. In this instance the motion of two axes is related via a circular interpolated move using the MOVECIRC command. Consider the following diagram.

```
MOVECIRC(-100,0,-50,0,0)
```

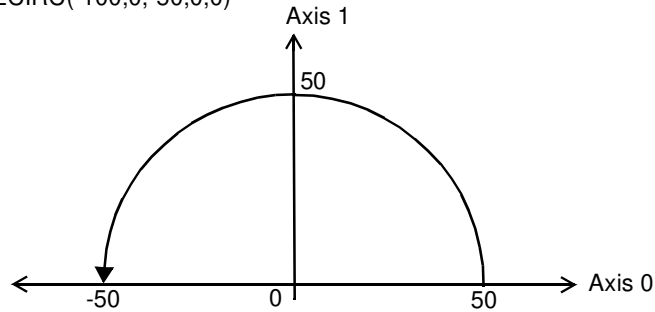

The centre point and desired end point of the trajectory relative to the start point and the direction of movement are specified. The MOVECIRC command computes the radius and the angle of rotation. Like the linearly interpolated MOVE command, the ACCEL, DECEL and SPEED variables associated with the base axis determine the speed profile along the circular move.

CAM Control

Additional to the standard move profiles the MC Unit also provides a way to define a position profile for the axis to move. The CAM command will move an axis according to position values stored in the MC Unit Table array. The speed of travelling through the profile is determined by the axis parameters of the axis.

```
CAM(0,99,100,20)
```

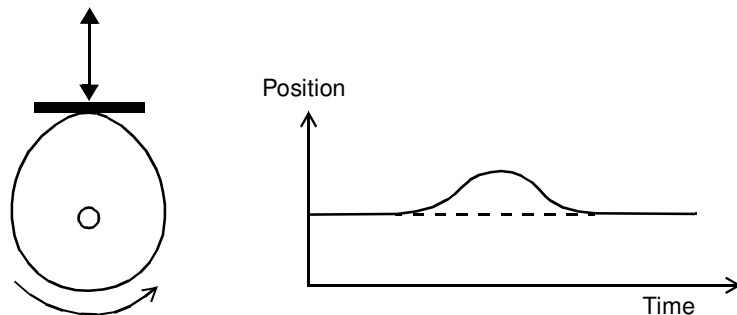

1-3-3 EG-Control

Electronic Gearing control allows you to create a direct gearbox link or a linked move between two axes. The MC Unit supports the following operations.

1. Electronic gearbox
2. Linked CAM
3. Linked move
4. Adding axes

Electronic Gearbox

The MC Unit is able to have a gearbox link from one axis to another as if there is a physical gearbox connecting them. This can be done using the CONNECT command in the program. In the command the ratio and the axis to link to are specified.

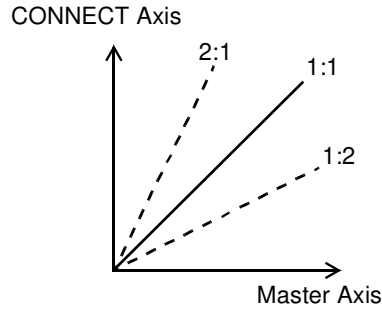

Axes		Ratio	CONNECT command
0	1		
		1:1	CONNECT(1,0) AXIS(1)
		2:1	CONNECT(2,0) AXIS(1)
		1:2	CONNECT(0.5,0) AXIS(1)

Linked CAM control

Next to the standard CAM profiling tool the MC Unit also provides a tool to link the CAM profile to another axis. The command to create the link is called CAMBOX. The travelling speed through the profile is not determined by the axis parameters of the axis but by the position of the linked axis. This is like connecting two axes through a cam.

```
CAMBOX(0,99,100,20,0) AXIS(1)
```

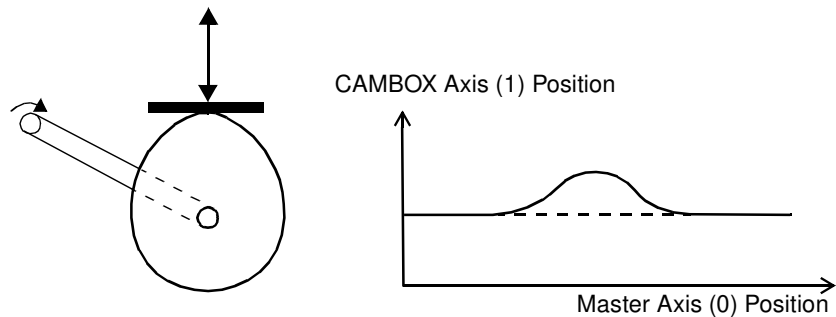

Linked Move

The MOVELINK command provides a way to link a specified move to a master axis. The move is divided into an acceleration, deceleration and constant

speed part and they are specified in master link distances. This can be particularly useful for synchronizing two axes for a fixed period.

```
MOVELINK(50,60,10,10,1) AXIS(0)
```

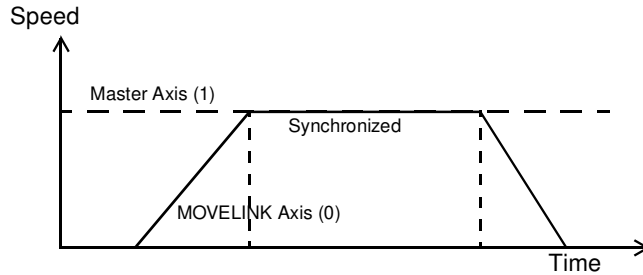

Adding Axes

It is very useful to be able to add all movements of one axis to another. One possible application is for instance changing the offset between two axes linked by an electronic gearbox. The MC Unit provides this possibility by using the ADDAX command. The movements of the linked axis will consist of all movements of the actual axis plus the additional movements of the master axis.

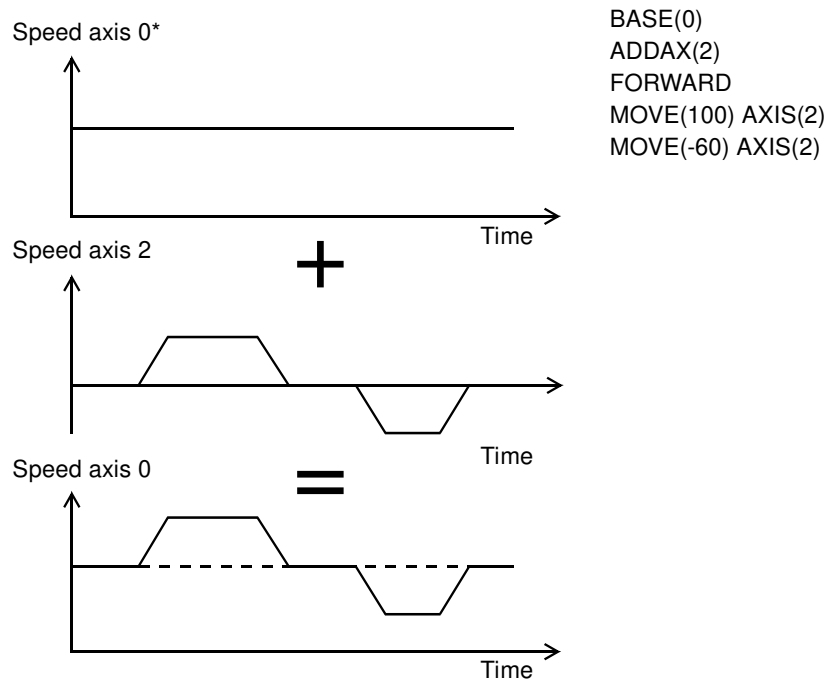

1-3-4 Other Operations

Canceling Moves

In normal operation or in case of emergency it can be necessary to cancel the current movement from the buffers. When the CANCEL or RAPIDSTOP commands are given, the selected axis respectively all axes will cancel their current move.

Origin Search

The encoder feedback for controlling the position of the motor is incremental. This means that all movement must be defined with respect to an origin point. The DATUM command is used to set up a procedure whereby the MC Unit goes through a sequence and searches for the origin based on digital inputs and/or Z-marker from the encoder signal.

Print Registration

The MC Unit can capture the position of an axis in a register when an event occurs. The event is referred to as the print registration input. On the rising or falling edge of an input signal, which is either the Z-marker or an input, the MC Unit captures the position of an axis in hardware. This position can then be used to correct possible error between the actual position and the desired position. The print registration is set up by using the REGIST command.

The position is captured in hardware, and therefore there is no software overhead and no interrupt service routines, eliminating the need to deal with the associated timing issues.

Merging Moves

If the MERGE axis parameter is set to 1, a movement will always be followed by a subsequent movement without stopping. The following illustrations will show the transitions of two moves with MERGE value 0 and value 1.

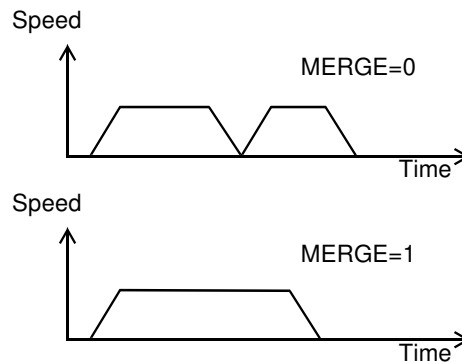
**Jogging**

Jogging moves the axes at a constant speed forward or reverse by manual operation of the digital inputs. Different speeds are also selectable by input. Refer to the FWD_JOG, REV_JOG and FAST_JOG axis parameters.

1-4 Control System Configuration

1-4-1 Servo System Principles

The servo system used by and the internal operation of the MC Unit are briefly described in this section. Refer to *2-4 Servo System Precautions* for precautions related to servo system operation.

Semi-closed Loop System

The servo system of the MC Unit uses a semi-closed or inferred closed loop system. This system detects actual machine movements by the rotation of the motor in relation to a target value. It calculates the error between the target value and actual movement, and reduces the error through feedback.

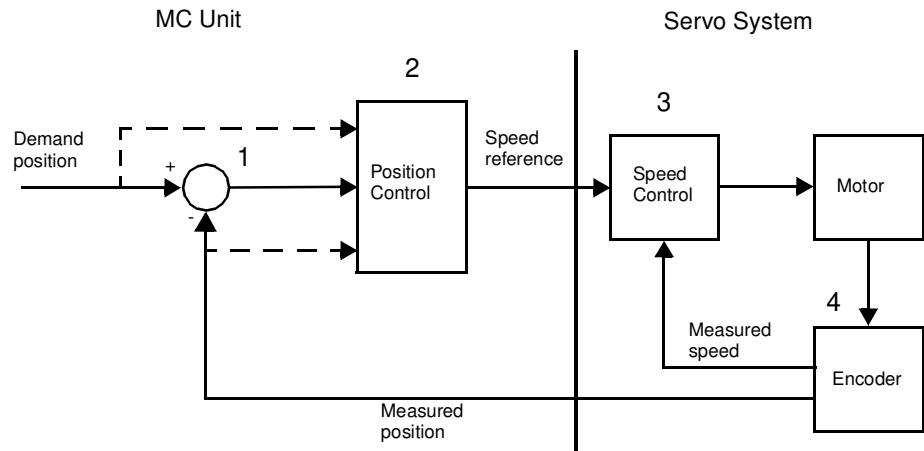

Internal Operation of the MC Unit

1,2,3...

Inferred closed loop systems occupy the mainstream in modern servo systems applied to positioning devices for industrial applications. The following graph shows the basic principle of the Servo System as used in the MC Unit.

1. The MC Unit performs actual position control. The main input of the controller is the following error, which is the calculated difference between the demand position and the actual measured position.
2. The Position Controller calculates the required speed reference output determined by the following error and possibly the demanded position and the measured position. The speed reference is provided to the Servo Driver.
3. The Servo Driver controls the rotational speed of the Servomotor corresponding to the speed reference. The rotational speed is proportional to the speed reference.
4. The rotary encoder will generate the feedback pulses for both the speed feedback within the Servo Driver speed loop and the position feedback within the MC Unit position loop.

Motion Control Algorithm

The servo system controls the motor by continuously adjusting the speed reference to the Servo Driver. The speed reference is calculated by the MC Unit's Motion Control algorithm, which is explained in this section.

The Motion Control algorithm uses the demand position, the measured position and the following error to determine the speed reference. The following error is the difference between the demanded and measured position. The demand position, measured position and following error are represented by axis parameters MPOS, DPOS and FE. Five gain values have been implemented for the user to be able to configure the correct control operation for each application.

The Motion Control algorithm of the MC Unit is shown in the diagram below.

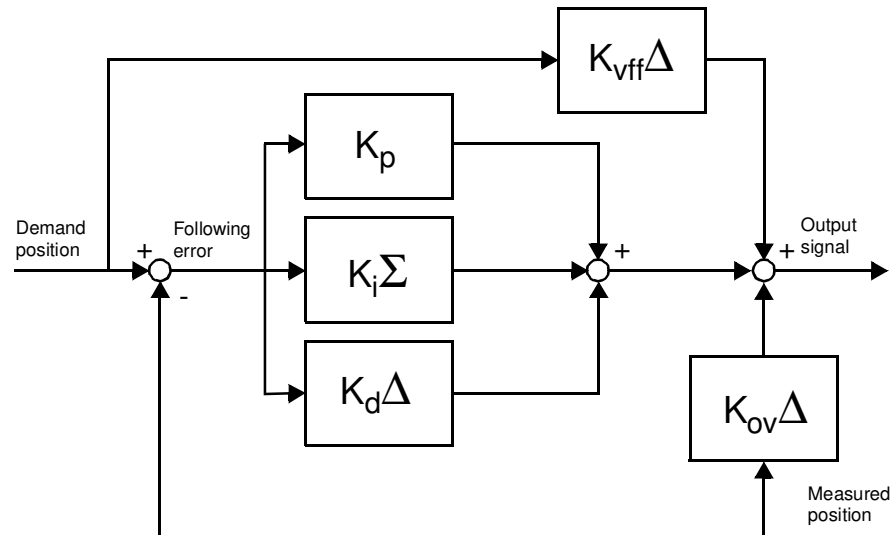

Proportional Gain

The proportional gain K_p creates an output O_p that is proportional to the following error E .

$$O_p = K_p \cdot E$$

All practical systems use proportional gain. For many just using this gain parameter alone is sufficient. The proportional gain axis parameter is called P_GAIN.

Integral Gain

The integral gain K_i creates an output O_i that is proportional to the sum of the following errors E that have occurred during the system operation.

$$O_i = K_i \cdot \sum E$$

Integral gain can cause overshoot and so is usually used only on systems working at constant speed or with slow accelerations. The integral gain axis parameter is called I_GAIN.

Derivative Gain

The derivative gain K_d produces an output O_d that is proportional to the change in the following error E and speeds up the response to changes in error while maintaining the same relative stability.

$$O_d = K_d \cdot \Delta E$$

Derivative gain may create a smoother response. High values may lead to oscillation. The derivative gain axis parameter is called D_GAIN.

Output Speed Gain

The output speed gain K_{ov} produces an output O_{ov} that is proportional to the change in the measured position P_m and increases system damping.

$$O_{ov} = K_{ov} \cdot \Delta P_m$$

The output speed gain can be useful for smoothing motions but will generate high following errors. The output speed gain axis parameter is called OV_GAIN.

Speed Feedforward Gain

The speed feedforward gain K_{vff} produces an output O_{vff} that is proportional to the change in demand position P_d and minimizes the following error at high speed.

$$O_{vff} = K_{vff} \cdot \Delta P_d$$

The parameter can be set to minimise the following error at a constant machine speed after other gains have been set. The speed feed forward gain axis parameter is called VFF_GAIN.

Default Values

The default settings are given below along with the resulting profiles. Fractional values are allowed for gain settings.

Gain	Default
Proportional Gain	0.1
Integral Gain	0.0
Derivative Gain	0.0
Output Speed Gain	0.0
Speed Feedforward Gain	0.0

1-4-2 Encoder Signals

Standard OMRON equipment is designed for an advanced phase-A for forward rotation and an advanced phase-B for reverse rotation. For the encoder input and output signals, the MC Unit is designed to comply with this phase definition, allowing the MC Unit to be connected to other equipment without problems.

With this arrangement, the direction of rotation can be easily detected by monitoring the relative phase of both signals. If channel A leads channel B, indicating clockwise (CW) movement, the counter will increment. Conversely, if channel B leads channel A, indicating counterclockwise (CCW) movement, the counter will decrement.

Typically, rotary encoders also provide an additional Z-marker as a reference pulse within each revolution. By properly decoding and counting these encoder signals, the direction of motion, speed, and relative position can be determined.

Encoder input

For the MC Unit encoder input, the pulse ratio is 4. Every encoder edge (pulse edge for either A or B phase) is one internal count.

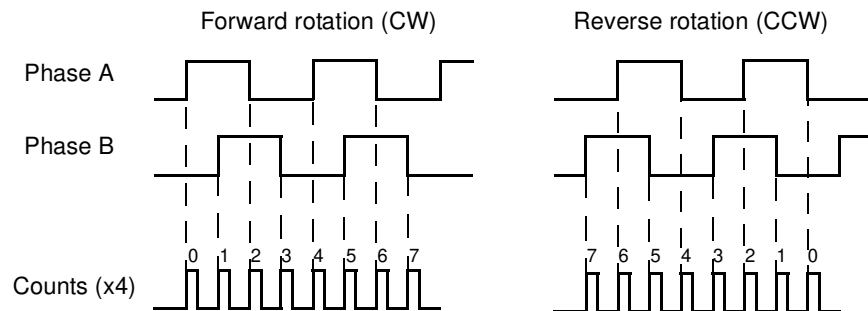

The signals A, B and Z appear physically as A+ and A-, B+ and B- and Z+ and Z-. These appear as differential signals on twisted-pair wire inputs, ensuring that common modes are rejected and that the noise level is kept to a minimum.

When using encoders by other makers, check carefully the encoder specification for phase advancement. If the definition differs from the ones given above, reverse the B-phase wiring between the MC Unit and the Servo Driver. In most cases, this should resolve the problem.

Encoder output

For encoder output, the pulse ratio is 64. For every 16 internal counts one encoder edge for one of the two phases will be produced.

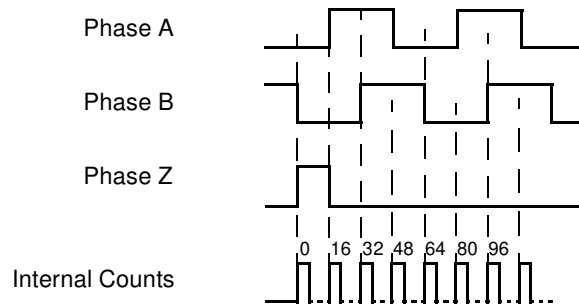

The Z-phase signal has the following specification:

- The Z-marker has a period of 4096 generated edges.
- The pulse has a width of a quarter pulse period length (when both phase A and B are low).
- The Z-phase signal is active after power-on.

The generated frequency is limited to the maximum allowable frequency. If the internal speed would result in a frequency above this maximum, an axis status flag will be set. See *8-2-1 MC Unit Error Handling* for details.

1-5 Specifications

1-5-1 General Specifications

The MC Unit provides the following general specifications.

Item		Contents
Applicable Servo Driver		R88D-W Series (software version 14 or later, see note)
Servomotors	Type	R88M-W Series
	Encoder	Incremental / Absolute
Installation Method		Mounted on the CN10 connector on the Servo Driver side.
Basic Specifications	Power Supply Method	5 VDC (supplied from the control power supply of the Servo Driver)
		24 VDC (supplied from external power supply)
	Total Power Consumption	4.0 W
	External Dimensions	20 x 142 x 128 mm (H x W x D)
	Approx. Mass	200 g
	Current Consumption	170 mA for 24 VDC
	Output Power Supply	5 VDC, maximum 160 mA (to external encoder)
Environment	Ambient Operating Temperature	0 to 55°C
	Ambient Operating Humidity	90 % RH or less (non-condensing)
	Ambient Atmosphere	Free from corrosive gasses
	Ambient Storage Temperature	-20 to 75°C
	Ambient Storage Humidity	90 % RH or less (non-condensing)
	Vibration Resistance	4.9 m/s ²
	Impact Resistance	Acceleration 19.6 m/s ² or less (when the impact is applied three times in each X, Y, Z direction)

Note The MC Unit cannot be used with software version 8.

1-5-2 Functional Specifications

The MC Unit provides the following functional specifications.

Item		Contents
Type of Unit		Optional board for W-series Servo Driver
Motion Control	Speed Control	Inferred closed loop with PID, output speed and speed feed forward gains Speed reference (open loop) Possible torque limit operation
	Torque Control	Torque reference Possible speed limit operation
	Control Switch	Speed / Torque control switching during operation
Configuration	Maximum No. of axes	3
	No. of controlled servo axes	1
	Maximum No. of encoder in- or output axes	1
	Maximum No. of virtual axes	2
Servo Loop Cycle		Selectable to 0.5 ms or 1.0 ms.
Measurement Units		User definable

Item		Contents
Positioning operations	Linear interpolation	Linear interpolation for any number of axes
	Circular interpolation	Circular interpolation for any two axes
	CAM profile	CAM profile movement for any axis
	Electronic gearbox	Electronic gearbox link between any two axes
	Linked CAM	Linked CAM profile movement for any two axes
	Linked move	Linked move for any two axes
	Adding axes	Adding any two axes
Acceleration/deceleration curves		Trapezoidal or S-curve
Servo Driver Access	Motion Control	Speed Control Torque Control Position Feed-back Driver Enable Driver Print Registration
	Monitoring	Driver Alarm and Warning Status General Driver Status Driver Digital Input Driver Analogue Input Driver Limit Switches
	General Control	Driver Alarm Reset Driver Reset
	Parameter Access	Read and Write Pn-parameters Read Un parameters
External connected devices		Personal Computer with Motion Perfect Programming Software
Serial Communications	RS-232C	Port 0: Connection to PC (Motion Perfect Software) Port 1: Host Link Master protocol Host Link Slave protocol General-purpose
	RS-422A/485 (MCW151-E only)	Port 2: Host Link Master protocol Host Link Slave protocol General-purpose
External I/O	Encoder Input	Line receiver input; maximum response frequency: 1500 kHz pulses (before multiplication) Pulse multiplication: x4
	Encoder Output	Line receive output; maximum frequency: 500 kHz pulses Internal counts to output pulse ratio: 64 : 1
	Digital Inputs	Total of 8 digital inputs can be wired and used for instance for limit switches, emergency stop and proximity inputs. Two inputs can be used for registration of the encoder input/output axis.
	Digital Outputs	Total of 6 digital outputs can be wired and used for position dependent switching or other general purposes.
	Registration inputs	Two registration inputs can be used (simultaneously) to capture the position in hardware.
Switch setting		DeviceNet settings (MCW151-DRT-E only) General purpose (MCW151-E only)
Power supply for general and axis I/O		Provided externally

Item		Contents
Task program management	Programming language	BASIC
	Number of tasks	Up to 3 tasks running simultaneously plus the Command Line task
	Max. number of programs	14
	Data storage capacity	251 (VR) + 8000 (Table) max.
Saving program data	MC Unit	Random Access Memory (RAM) and Flash memory backup. (See note)
	Personal Computer	Motion Perfect software manages a backup on the hard disk of the personal computer.
Self diagnostic functions		Detection of memory corruption via checksum Detection of error counter overrun

Note The service life for the flash memory is 100,000 writing operations.

1-5-3 DeviceNet Specifications (MCW151-DRT-E only)

The MC Unit provides the following DeviceNet specifications.

Item		Contents
Communications protocol		DeviceNet
Supported connections (communications)		Master-Slave: Remote I/O and explicit messages Both conform to DeviceNet specifications
Connection forms (see note)		Combination of multi-drop and T-branch connections (for trunk or drop lines)
Baud rate		500 kbps, 250 kbps, 125 kbps (switchable)
Communications media		Special 5-wire cables (2 signal lines, 2 power lines, 1 shield line)
Communications distances	500 kbps	Network length: 100 m max. (100 m max.) Drop line length: 6 m max. Total drop line length: 39 m max.
	250 kbps	Network length: 250 m max. (100 m max.) Drop line length: 6 m max. Total drop line length: 78 m max.
	125 kbps	Network length: 500 m max. (100 m max.) Drop line length: 6 m max. Total drop line length: 156 m max.
	Parentheses indicate the length when Thin Cables are used.	
Communications power supply		11 to 25 VDC (Supplied from the communications connector)

Note Terminating resistors are required at both ends of trunk line.

Refer to the *DeviceNet Operation Manual (W267)* for other communication specifications, such as communication cycle times.

1-6 Comparison between Firmware Versions

The following table shows a comparison between the two current versions of the R88A-MCW151-E and R88A-MCW151-DRT-E Motion Control Units. The changes are only related to firmware (not hardware) and the firmware is common for both types. Verify the current version of the MC Unit using the VERSION parameter.

 **Caution** The R88A-MCW151-E FW 1.62 is fully backward compatible with the previous version FW 1.61. For the R88A-MCW151-DRT-E FW 1.62 many DeviceNet implementation changes have been done. For both Units caution must be taken when upgrading.

Item		FW 1.61	FW 1.62
Commands and instructions	ADD_DAC	No.	Yes. Command to enable dual feedback control.
DeviceNet (MCW151-DRT-E only)	Software reset of MC Unit	Possible by either bit in Remote I/O Output word 1 or Explicit Message command RESET.	Possibly only by Explicit Message command RESET.
	Explicit messages (read and write)	Different maximum transfer amount for read and write.	Maximum amount of elements to transfer (read/write) is 39 (three-word format) and 119 (one-word format). <i>See 4-2-2 Explicit DeviceNet Messages.</i>
	Device objects	-	Update of Device objects. <i>See Appendix B Device Protocol (MCW151-DRT-E only).</i>

SECTION 2 Installation

This section describes the MC Unit components and provides the information required for installing the MC Unit.

2-1	Components and Unit Settings	24
2-2	Installation	28
2-2-1	Installation Conditions	28
2-2-2	Installation Method	28
2-2-3	Dimensions	29
2-3	Wiring	30
2-3-1	Control Connections	30
2-3-2	Serial Port Connections	31
2-3-3	DeviceNet Connection	36
2-3-4	I/O Specifications	36
2-3-5	Connection examples	38
2-4	Servo System Precautions	39
2-5	Wiring Precautions	40

2-1 Components and Unit Settings

The following diagram shows the main components of the MC Unit.

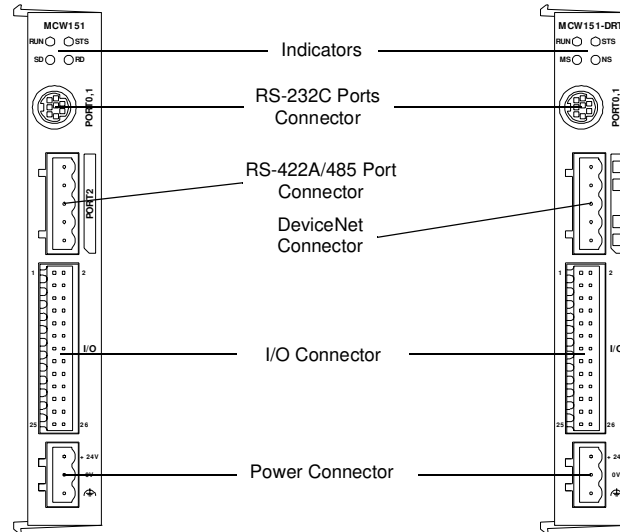

Indicators

The following table describes the indicators on the front of the MC Unit.

■ Motion Control

Indicator	Color	Status	Meaning
RUN	Green	ON	The MC Unit is operating normally.
		OFF	The MC Unit did not start properly or is not powered on.
		Flashing with STS	An error occurred in the communication with the Servo Driver.
STS	Red	ON	The axis has been disabled. The Servo Enable is not ON.
		OFF	The axis is enabled.
		Flashing alone	A motion error has occurred. The Servo Driver has been disabled.
		Flashing with RUN	An error occurred in the communication with the Servo Driver.

■ RS-422A/485 (MCW151-E only)

Indicator	Color	Status	Meaning
SD	Green	ON	Transmitting data.
		OFF	No communication.
RD	Green	ON	Receiving data.
		OFF	No communication.

■ **DeviceNet (MCW151-DRT-E only)**

Indicator	Color	Status	Definition	Meaning
MS	Green	ON	Device Operational	Normal operating status.
		Flashing	Device in Standby	Reading switch settings.
	Red	ON	Unrecoverable Fault	Unit hardware error: Watchdog timer error.
		Flashing	Minor Fault	Switch settings incorrect.
	---	OFF	No Unit Power	Unit power is not supplied, waiting for initial processing to start, or the Unit is being reset.
NS	Green	ON	Link OK. Online, Connected.	Network is operating normally (communications established).
		Flashing	Online, Not connected	Network is operating normally, but communications have not yet been established.
	Red	ON	Critical Link Failure	A fatal communications error has occurred. Network communications are not possible.
		Flashing	Connection Timeout	Communications timeout.
	---	OFF	No Fieldbus Power / Not Online	Checking for node address duplication on the Master, switch settings are incorrect, or fieldbus power is not supplied.

Switch Settings

The MCW151 Units are equipped with the following DIP-switches.

■ **DeviceNet Switch Settings (MCW151-DRT-E only)**

The external switch settings will set the Slaves' node address setting and baud rate setting.

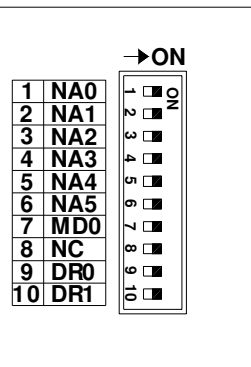

Node address

The node address of the slave is set with pins 1 through 6 of the DIP switch. Any node address within the setting range can be used as long as it is not already set on another node.

DIP switch setting						Node address
Pin 6	Pin 5	Pin 4	Pin 3	Pin 2	Pin 1	
0	0	0	0	0	0	0 (default)
0	0	0	0	0	1	1
0	0	0	0	1	0	2
...						...
1	1	1	1	0	1	61
1	1	1	1	1	0	62
1	1	1	1	1	1	63

0: OFF, 1: ON

Baud rate

Pins 9 and 10 are used to set the baud rate as shown in the following table.

Pin 10	Pin 9	Baud rate
OFF	OFF	125 kbps (default)
OFF	ON	250 kbps
ON	OFF	500 kbps
ON	ON	Not allowed

- Note**
1. Always turn OFF the MC Unit's power supply (including the communications power supply) before changing the baud rate setting.
 2. Set the same baud rate on all of the nodes (master and slaves) in the Network.

Other settings

Pin 7 is used to select the I/O Slave Messaging mode. This determines the allocation of the I/O Slave Messaging mode area.

Pin 7	I/O Slave Messaging Mode
OFF	Mode I (default)
ON	Mode II

Pin 8 is not used.

■ **General Switch Settings (MCW151-E only)**

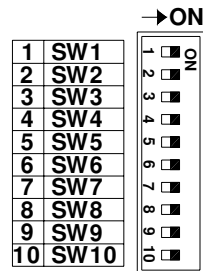

For the MCW151-E the external DIP switch can be used for general purpose. The value of the switch can be accessed using the SWITCH_STATUS parameter.

DIP switch setting										Parameter value
Pin 10	Pin 9	Pin 8	Pin 7	Pin 6	Pin 5	Pin 4	Pin 3	Pin 2	Pin 1	
0	0	0	0	0	0	0	0	0	0	0 (default)
0	0	0	0	0	0	0	0	0	1	1
0	0	0	0	0	0	0	0	1	0	2
...										...
1	1	1	1	1	1	1	1	0	1	1021
1	1	1	1	1	1	1	1	1	0	1022
1	1	1	1	1	1	1	1	1	1	1023

0: OFF, 1: ON

■ Internal Switches

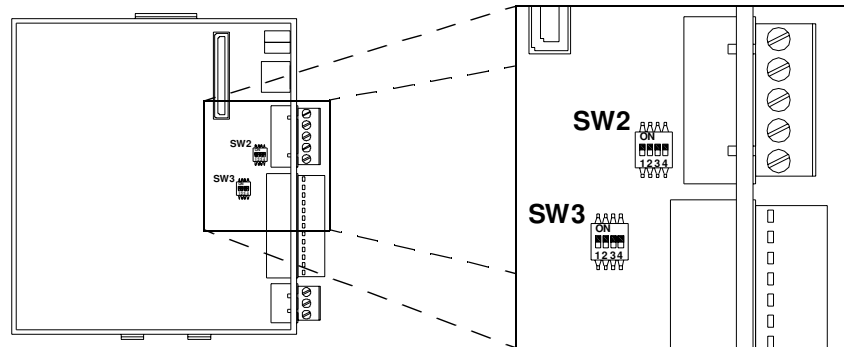

Switch SW2 (MCW151-E only)

Pin 1 and 2 select the serial communication for port 2.

Pin 2	Pin 1	Selection
OFF	OFF	RS-422A (default)
ON	ON	RS-485
Other not allowed		

Pin 3 selects the termination resistor between receive pins (RD+ / RD -) for port 2.

Pin 3	Selection
OFF	Termination disabled (default)
ON	Termination enabled

Pin 4 is not used.

Switch SW3

Pin 1 through 3 enable the termination resistor for the encoder channel A, B and Z.

Pin 3 (channel Z)	Pin 2 (channel B)	Pin 1 (channel A)	Selection
OFF			Termination disabled for channel (default)
ON			Termination enabled

Pin 4 is not used.

2-2 Installation

2-2-1 Installation Conditions

Follow the procedure below to install multiple Servo Drivers side by side in a control panel.

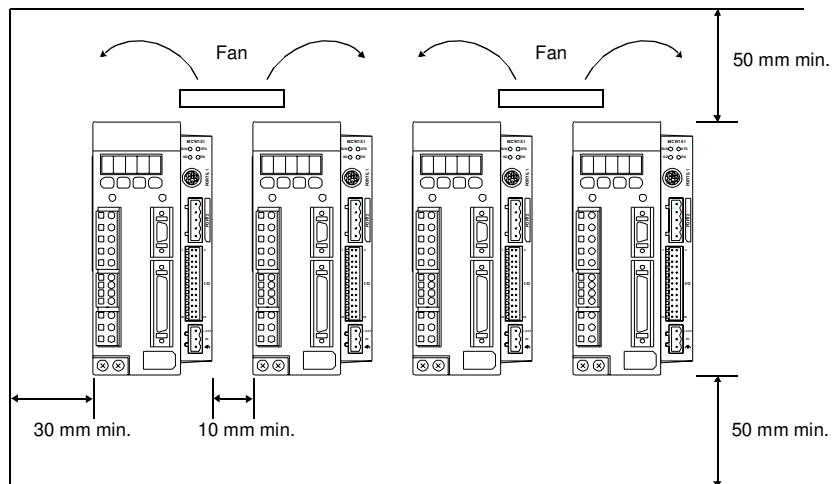

■ Servo Driver Orientation

Install the Servo Driver perpendicular to the wall so that the front panel (display and setting section) faces forward.

■ Cooling

As shown in the figure above, provide sufficient space around each Servo Driver for cooling by cooling fans or natural convection.

■ Side-by-side Installation

When installing Servo Drivers side-by-side as shown in the figure above, provide at least 10 mm between and at least 50 mm above and below each Servo Driver. Install cooling fans above the Servo Drivers to avoid excessive temperature rise and to maintain even temperature inside the control panel.

■ Environmental Conditions

- Ambient operating temperature: 0 to 55°C
- Ambient operating humidity: 20% to 90% RH (no condensation)
- Vibration: 4.9 m/s²

2-2-2 Installation Method

When installing the MC Unit

- 1,2,3...**
1. Insert the lower two extensions into the bottom mounting holes on the right side of the Servo Driver.
 2. Move the upper side of the MC Unit towards the Driver and verify the Servo Driver connector will directly fit into the MC Unit connector. Click the higher extension into the upper mounting hole.

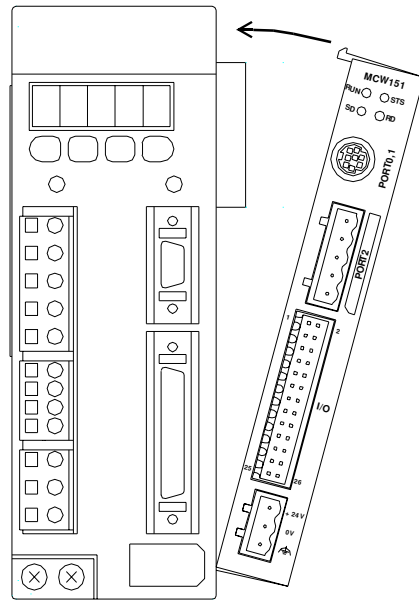

When removing the MC Unit, press down the top of the MC Unit case and remove the upper extension from the Driver.

2-2-3 Dimensions

The basic dimensions of the MC Unit are shown below.

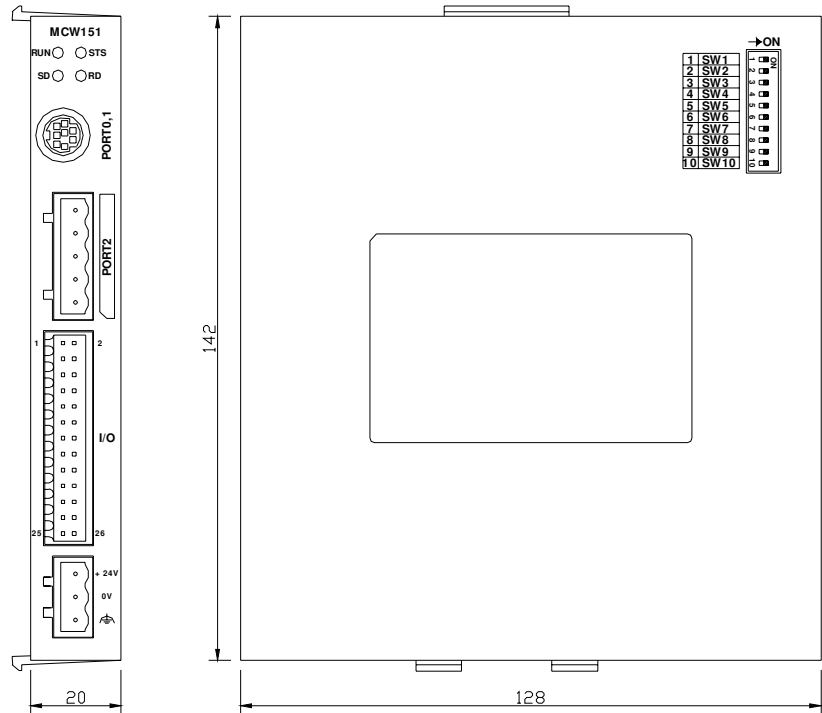

2-3 Wiring

2-3-1 Control Connections

I/O Connector

The I/O Connector is used for wiring to the digital I/O and the connection for the encoder input or encoder output. Refer to 2-3-4 I/O Specifications for electrical specifications.

Connector pin arrangement

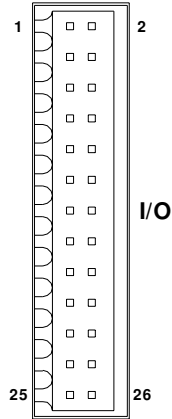

A+	1	2	A-
B+	3	4	B-
Z+	5	6	Z-
0V_ENC	7	8	5V_ENC
I0 / R0	9	10	FG
I2	11	12	I1 / R1
I4	13	14	I3
I6	15	16	I5
0V_IN	17	18	I7
O8	19	20	O9
O10	21	22	O11
O12	23	24	O13
0V_OP	25	26	24V_OP

I/O Connector Pin Functions

Pin	Signal	
	Name	Function
1	A+	Encoder phase A+ (Input / Output)
2	A-	Encoder phase A- (Input / Output)
3	B+	Encoder phase B+ (Input / Output)
4	B-	Encoder phase B- (Input / Output)
5	Z+	Encoder phase Z+ (Input / Output)
6	Z-	Encoder phase Z- (Input / Output)
7	0V_ENC	Encoder 0V common
8	5V_ENC	Encoder 5V power supply output
9	I0 / R0	(Registration) Input 0
10	FG	Frame Ground
11	I2	Input 2
12	I1 / R1	(Registration) Input 1
13	I4	Input 4
14	I3	Input 3
15	I6	Input 6
16	I5	Input 5
17	0V_IN	Inputs 0V common
18	I7	Input 7
19	O8	Output 8
20	O9	Output 9
21	O10	Output 10
22	O11	Output 11
23	O12	Output 12
24	O13	Output 13
25	0V_OP	Outputs 0V common
26	24V_OP	Outputs 24V power supply input

I/O Connector Type
Wiring Instructions

Weidmüller B2L 3.5/26 SN SW (included in package)

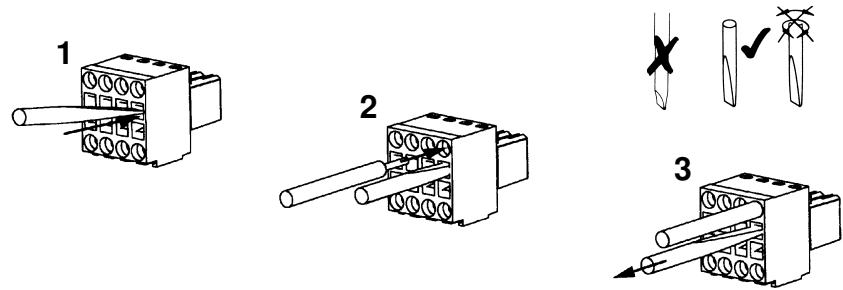

Power Connector

The Power Connector is used to connect the 24V power supply to the MC Unit.

Connector pin arrangement

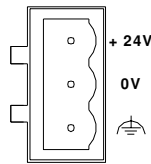

Pin	Name	Function
1	+24 V	Power Supply 24V
2	0 V	Power Supply 0V
3	FG	Frame Ground

Power Connector Type

Phoenix MSTB 2.5/3-ST-5.08 (included in package)

2-3-2 Serial Port Connections

RS-232C Connections

The MC Unit has two serial RS-232C ports for communication with external devices.

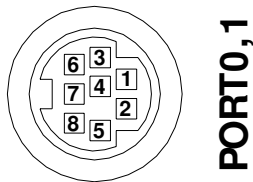

Pin	Symbol	Name	Port	Direction
1	-	Not used	-	
2	RS-1	Request to send	1	Output
3	SD-0	Send data	0	Output
4	SG-0	Signal ground	0	-
5	RD-0	Receive data	0	Input
6	SD-1	Send data	1	Output
7	SG-1	Signal ground	1	-
8	RD-1	Receive data	1	Input

RS-232C Interface Specifications

Item	Specifications	
Electrical characteristics	Conform to EIA RS-232C	
Synchronization	Start-stop synchronization (asynchronous)	
Baud rate	1200 / 2400 / 4800 / 9600 / 19200 / 38400 bps	
Transmission Format	Databit Length	7 or 8 bit
	Stop Bit	1 or 2 bit
	Parity Bit	Even/Odd/None
Transmission Mode	Point-to-point (1:1)	

Item	Specifications	
Transmission Protocol	Port 0	Motion Perfect Protocol
	Port 1	Host Link Protocol (Master / Slave) General-purpose
Galvanic Isolation	No	
Connector type	8-pin miniDIN	
Communication buffers	254 bytes (port 1)	
Recommended Cables	R88A-CCM002P4	Programming Port 0 Connection Cable to Personal Computer
	R88A-CCM001P5-E	Splitter cable for serial ports 0 and 1
Cable length	15 m max.	

RS-422A/485 Connection (MCW151-E only)

The MCW151-E has one serial RS-422A/485 port for communication with external devices.

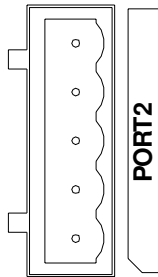

Pin	Symbol	Name	Port	Direction
1	RD-	Receive data (-)	2	Input
2	RD+	Receive data (+)	2	Input
3	FG	Frame Ground	2	-
4	SD-	Send data (-)	2	Output
5	SD+	Send data (+)	2	Output

RS-422A/485 Interface Specifications (MCW151-E only)

Item	Specifications	
Electrical characteristics	Conform to EIA RS-422A/485	
Synchronization	Start-stop synchronization (asynchronous)	
Baud rate	1200 / 2400 / 4800 / 9600 / 19200 / 38400 bps	
Transmission Format	Databit Length	7 or 8 bit
	Stop Bit	1 or 2 bit
	Parity Bit	Even/Odd/None
Transmission Mode	Point-to-multipoint (1:N)	
Transmission Protocol	RS-422A	Host Link Protocol (Master / Slave) General Purpose
	RS-485	General Purpose
Galvanic Isolation	Yes	
Connector type	Phoenix MSTB 2.5/5-ST-5.08 (included in package).	
Communication buffers	254 bytes	
Flow control	None	
Terminator	Yes, internal 220 Ω selectable by DIP-switch SW2	
Cable length	500 m max.	

Connection Examples

■ Direct Connections Using RS-232C Port 0
IBM PC/AT or Compatible Computers

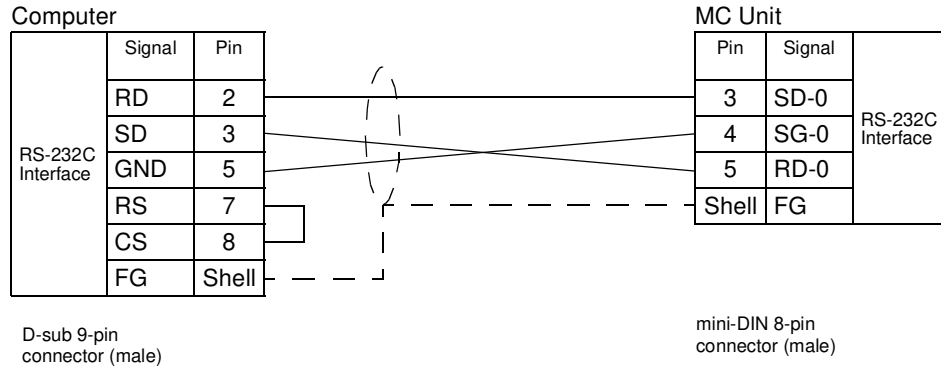

■ Direct Connections Using RS-232C Port 1
Programming Terminal (PT)

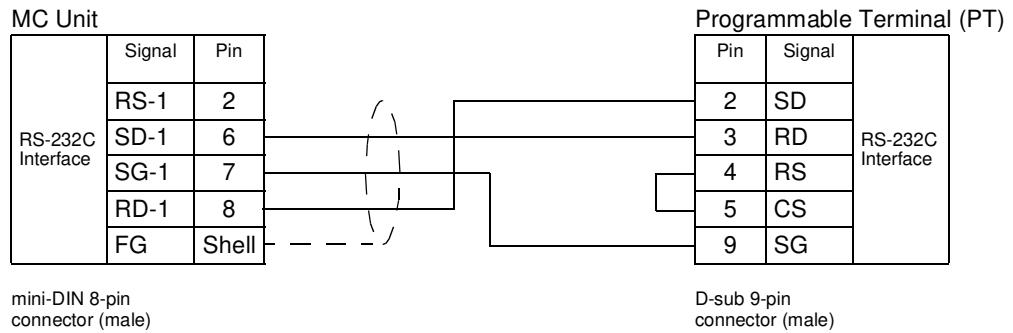

Note MC Unit Communication Mode: Host Link Slave
PC

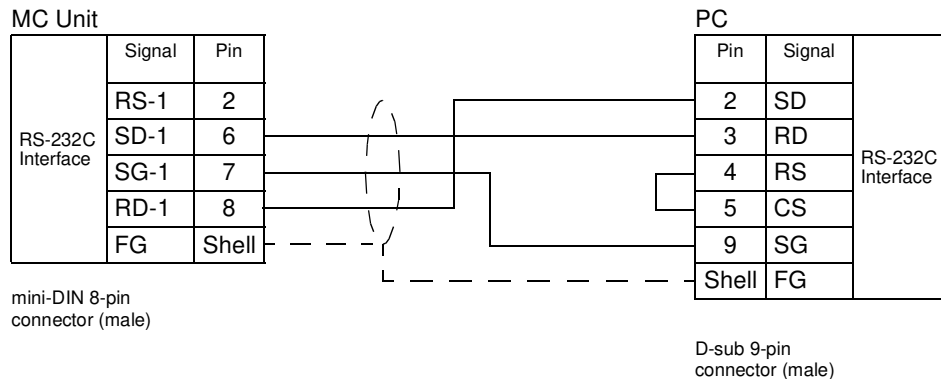

Note MC Unit Communication Mode: Host Link Master

1:N Connections Using RS-232C Port 1

Use the NT-AL001-E Converter Link Adapter

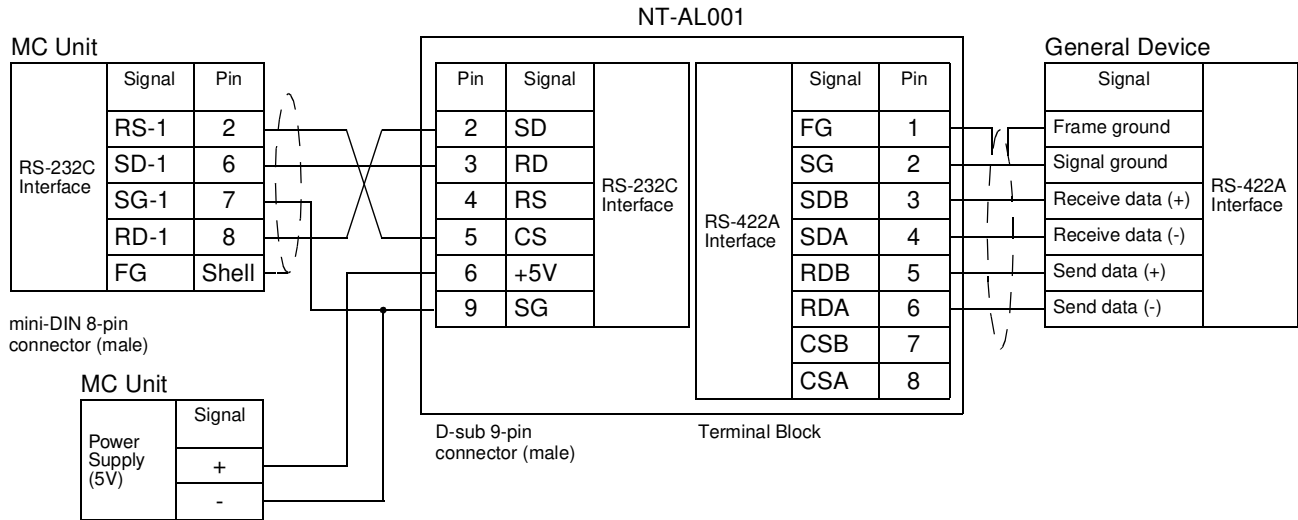

1:1 Connections Using RS-422A/485 Port 2 (MCW151-E only)

Programming Terminal (PT)

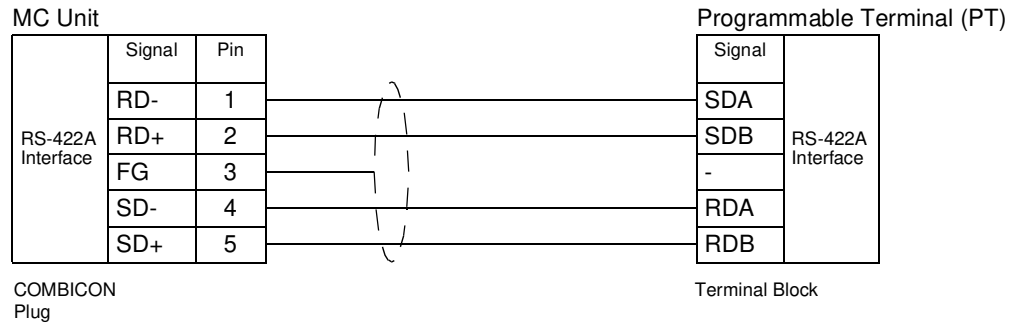

Note MC Unit Communication Mode: Host Link Slave
PC (Serial Communication Board)

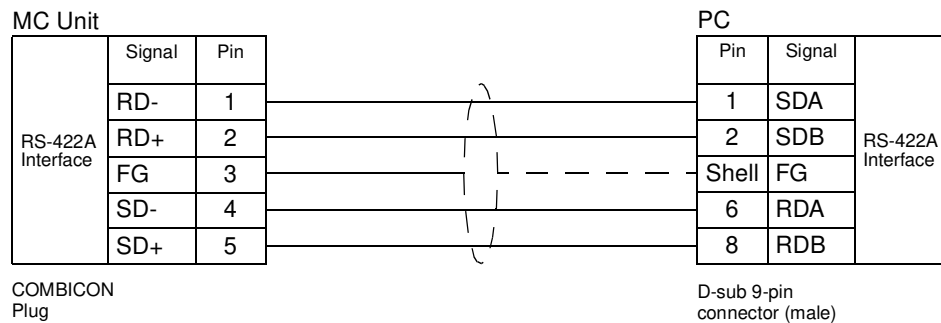

Note MC Unit Communication Mode: Host Link Master

1:N, 4-wire Connections Using RS-422A/485 Port 2 (MCW151-E only)

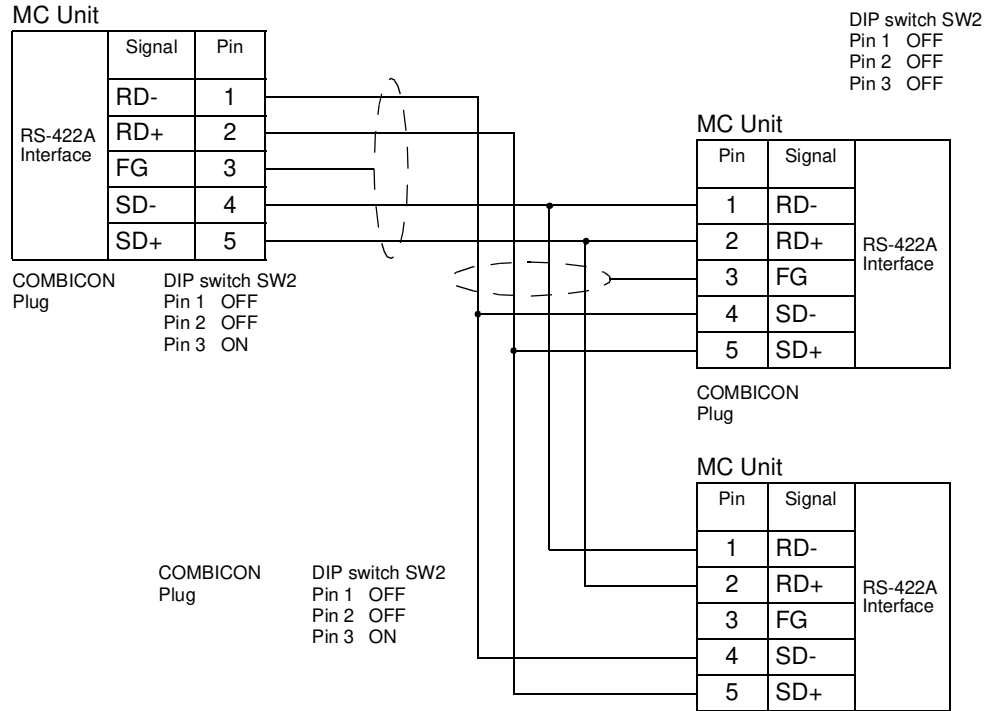

Note MC Unit Communication Modes: Host Link Master and Slave

1:N, 2-wire Connections Using RS-422A/485 Port 2 (MCW151-E only)

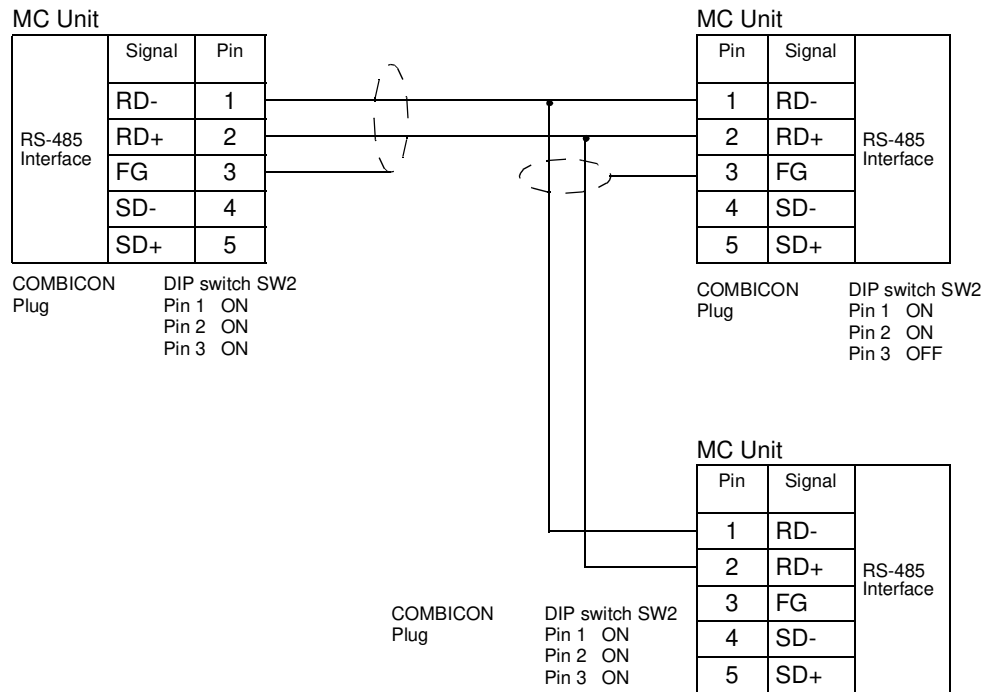

- Note**
1. MC Unit Communication Mode: General-purpose
 2. For the 2-wire system (Switch SW2: pin 1,2 =ON), the RD- and SD- resp. the RD+ and SD+ are interconnected within the MC Unit.

2-3-3 DeviceNet Connection

This section explains the pin allocation of the DeviceNet connector for the DeviceNet network. For further details on how to connect the DeviceNet network, refer to *DeviceNet Operation Manual (W267)*.

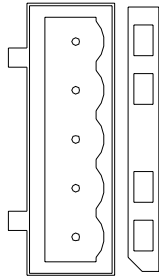

Pin	Symbol	Signal	Color of Cable
1	V+	Power line, positive voltage	Red
2	CAN-H	Communications line, high	White
3	Shield	Shield	-
4	CAN-L	Communications line, low	Blue
5	V-	Power line, negative voltage	Black

2-3-4 I/O Specifications

The following tables provide specifications and circuits for the I/O and Encoder connections.

Digital Inputs

Digital inputs: I0 to I7		
Item	Specification	Circuit Configuration
Type	PNP	
Maximum voltage	24 VDC + 10%	
Input current	7.0 mA at 24 VDC	
ON voltage	11 V min.	
OFF voltage	1 V max.	

Input Response times

The response times given in the following table are the times between the change in the input voltage and the corresponding change in the IN parameter.

These times are depending on the MC Unit's Servo Period and the priority of the corresponding BASIC task and they include the physical delays in the input circuit.

Task Priority \ Servo Period	0.5 ms	1.0 ms
High Priority	1.8 ms (max.)	2.3 ms (max.)
Low Priority	2.8 ms (max.)	3.3 ms (max.)

Print Registration delay time

The print registration is used to capture position data in hardware triggered by either a digital input or the Z-marker encoder signal. For the encoder axis 1 the print registration delay times are given by

Description	Delay Time
Digital Input I0/R0 and I1/R1 (rising edge)	50 μs
Digital Input I0/R0 and I1/R1 (falling edge)	150 μs
Z-marker (rising edge)	2 μs
Z-marker (falling edge)	2 μs

Digital Outputs

Digital outputs: O8 to O13		
Item	Specification	Circuit Configuration
Type	PNP	
Current capacity	100 mA each output (600 mA total for group of 6)	
Maximum voltage	24 V + 10%	
Protection	Over current, over temperature and 2 A fuse on common	

Output response times

The response times given in the following table are the times between a change in the OP parameter and the corresponding change in the digital output circuit.

These times are mainly depending on the MC Unit's Servo Period and they include the physical delays in the output circuit.

Servo Period	Response time
0.5 ms	0.8 ms (max.)
1.0 ms	1.3 ms (max.)

Encoder Input

Item	Specification	Circuit Configuration
Signal level	EIA RS-422A Standards	
Input impedance	48 kΩ min.	
Response frequency	1500 kp/s	
Termination	Yes, 220Ω selectable by switch	
Galvanic isolation	No	

Encoder Output

Item	Specification	Circuit Configuration
Signal level	EIA RS-422A Standards	
Maximum frequency	500 kp/s	
Galvanic isolation	No	

2-3-5 Connection examples

Cascading encoder signal (MCW151 to MCW151)

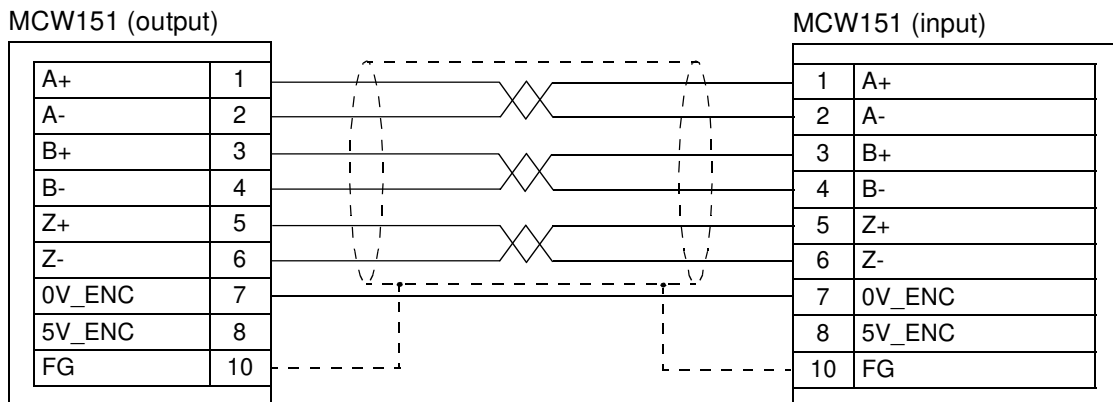

Connecting master encoder input signal from W-series Servo Driver

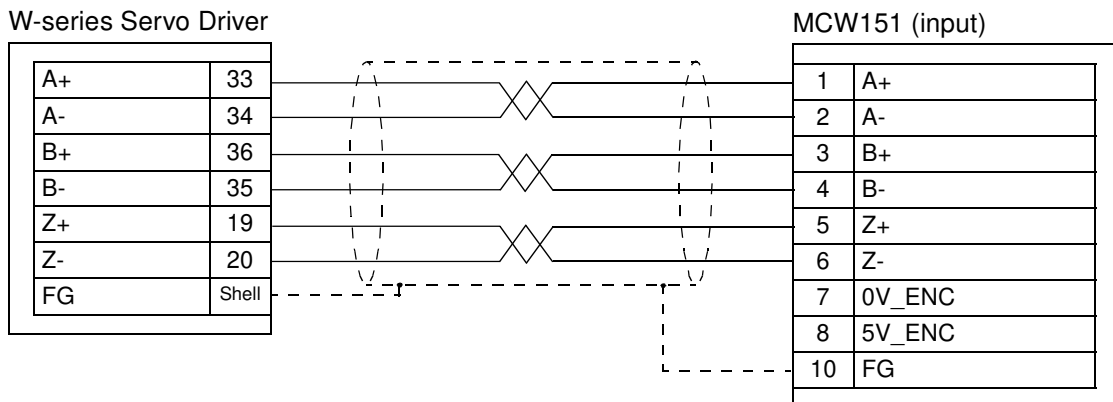

Connecting master external encoder signal

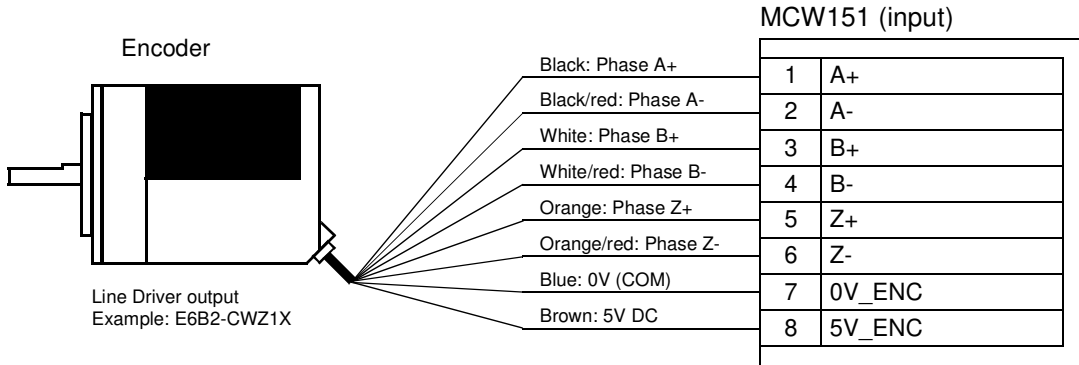

2-4 Servo System Precautions

The following precautions are directly related to the operation of the servo system. Refer to 1-4-1 Servo System Principles for a description of servo system operation.

The direct connection of the MC Unit to the Servo Driver provides a safe interface without the risk of disconnected or faulty wiring. The interface provides the MC Unit good monitoring operation to check the state of the Servo Driver at any given time. The Servo Driver Alarms and Warnings can be quickly distinguished and appropriate action can be taken.

If the communications between the MC Unit and Servo Driver fail, this is detected by either of the Units. The system will be halted into a fail-safe state. For any details about the MC Unit and Servo Driver error handling and alarm definitions, refer to SECTION 8 Troubleshooting.

Precautions for safe operation

In a servo system employing a Servomotor, an unforeseen event may cause the Servomotor to run out of control. Therefore, careful attention must be paid to include sufficient safety measures into the system design.

To guarantee fail-safe operation for any circumstances or occurrences, the following precautions must be taken.

Following Error Limit Setting

An important motion control safety precaution of the MC Unit is the following error limit checking. When the Servomotor is controlled to follow a specific demanded motion profile, this will always produce a following error between the demanded and actual measured position.

The maximum allowable value for this following error can be set with the FE_LIMIT axis parameter. When the following error at one moment exceeds the limit, a Motion Error will occur. The Servo Driver will be disabled and all motion will come to a halt. The user must be sure that this does not have an adverse effect on the machine. Determine the value of following error limit carefully according to the operating conditions of the application. See 6-3-74 FE_LIMIT for details.

External Limit Switches

The second safety precaution which is required is the use of limit switches. Monitoring sensors are installed at the edges of the workpiece's range of movement to detect abnormal workpiece movement and stop operation if a runaway occurs.

Although the limit switches can be connected either to the MC Unit as to the Servo Driver, it is strongly recommended to connect the limit switches to the

Servo Driver. This will achieve a fast response of both the Servo Driver and MC Unit.

For the Servo Driver, the limit switches should be connected to pins CN1-42 (FWD) and CN1-43 (REV). When using the MC Unit, the switches can be connected to any of the inputs. In both cases the axis parameters FWD_IN and REV_IN for axis 0 are used to assign the limit switch inputs for the MC unit. When the Servo Driver inputs are used, define FWD_IN=18 and REV_IN=19.

When the limits are connected to the Servo Driver and the correct settings are set, the Driver will apply the dynamic brake to stop the Servomotor. Also the appropriate bit of the AXISSTATUS axis parameter will be set.

2-5 Wiring Precautions

Electronically controlled equipment may malfunction because of noise generated by power supply lines or external loads. Such malfunctions are difficult to reproduce, and determining the cause often requires a great deal of time. The following precautions will aid in avoiding noise malfunctions and improving system reliability.

- Use electrical wires and cables of the designated sizes as specified in the operation manual for the Servo Driver. Use larger size cables for FG lines of the Servo Driver and ground them over the shortest possible distances.
- Separate power cables (AC power supply lines and motor power supply lines) from control cables (encoder lines and external input signal lines). Do not group power cables and control cables together or place them in the same conduit.
- Use shielded cables for control lines.
- Use the ready-made cables designed for MC Unit to reduce connectivity problems.
- Connect a surge absorbing diode or surge absorber close to relays. Use a surge-absorbing diode with a voltage tolerance of at least five times greater than the circuit voltage.

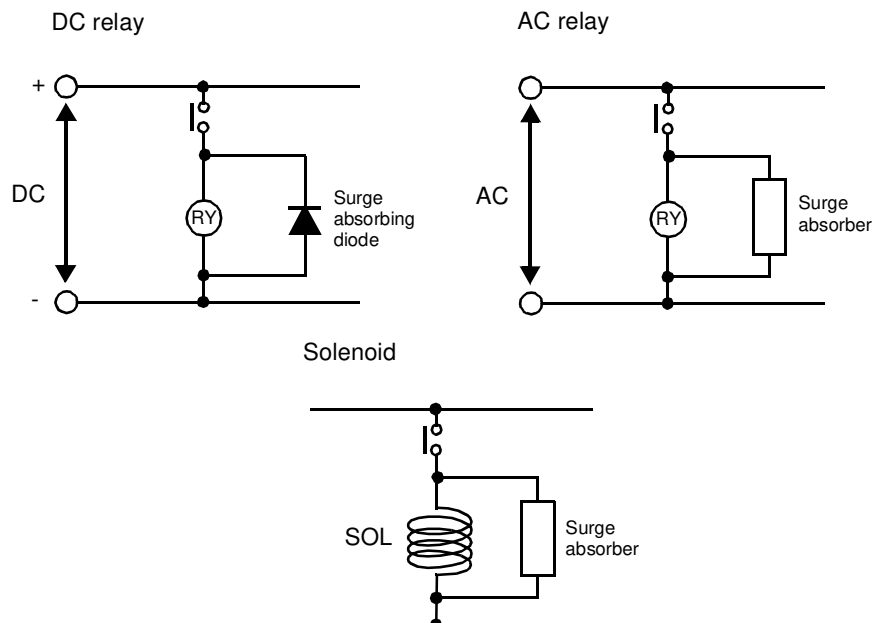

- Noise may be generated on the power supply line if the same power supply line is used for an electric welder or electrical discharge unit. Connect

an insulating transformer and a line filter in the power supply section to remove such noise.

- Use twisted-pair cables for power supply lines. Use adequate grounds (i.e., to 100 Ω or less) with wire cross sections of 1.25 mm² or greater.
- Use twisted-pair shielded cables for control voltage output signals, input signals and encoder signals.
- The maximum distance for the encoder signal from an encoder to the MC Unit must not exceed 20 m.
- The input terminals that operate the 24 V system are isolated with optical couplers to reduce external noise effects on the control system.

SECTION 3

Motion Control Functions

This section describes the different Motion Control functions of the MC Unit. Also the functionality of the Servo Driver related commands are explained.

3-1	Overview	44
3-2	System Set-up	46
3-3	System Functions	47
3-3-1	Servo Driver Control.....	47
3-3-2	Digital I/O	50
3-3-3	Monitoring Data	52
3-3-4	Absolute Encoder	54
3-3-5	Other Servo Driver Commands	57

3-1 Overview

The MC Unit together with the Servo Driver combine into one complete Servo System which is able to control the application. All Motion Control commands and data transfers are directly communicated between the MC Unit and the Servo Driver.

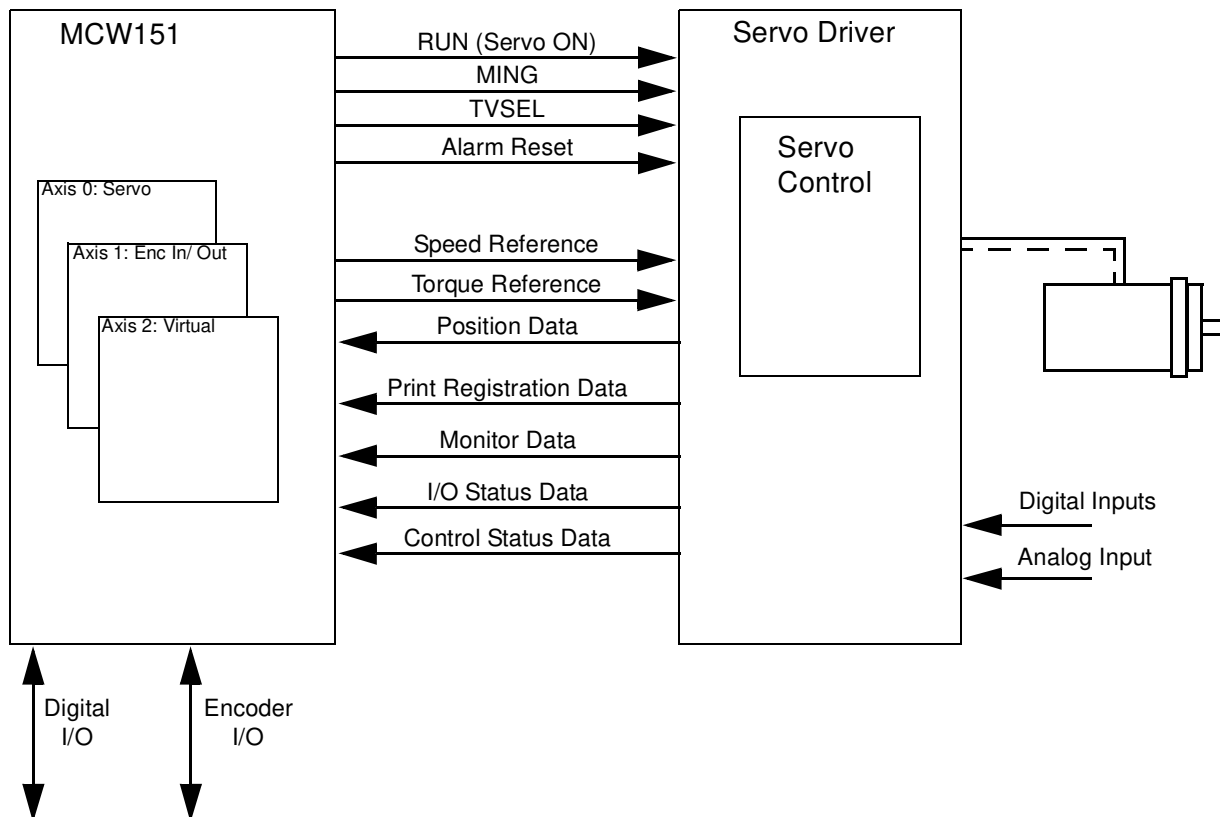

MC Axis Configuration

The MC Unit has 3 axes in total, which can be used for different motion control purposes depending on the application. The following table lists the different available axis types. The type of each axis is set by using the ATYPE axis parameter.

Axis number	Axis type	ATYPE value
0	Servo	13
1	Virtual	0
	Servo	2
	Encoder input (default)	3
	Encoder output	14
2	Virtual	0

■ Servo Axis

The servo axis for axis 0 controls the movement of the connected servo system. The Servomotor can be controlled in both speed control as in torque control.

Speed control can be achieved in closed loop and in open loop. In closed loop, the speed reference to the Servo Driver based on the calculated

(demanded) movement profile in the MC Unit and the actual (measured) position feedback from the Servomotor according to the control gain settings. In open loop, a set speed reference value is outputted to the Servo Driver.

The torque control is achieved by outputting a set torque reference value to the Driver. The axis is capable of switching between torque and speed control during operation.

The servo axis for axis 1 can provide a second servo control loop to enable dual feed-back control. More details can be found at the ADD_DAC command description.

■ **Encoder Input Axis**

The encoder input axis provides an axis which counts the position data from a connected pulse generator such as a Servo Driver or an external encoder. The encoder input axis can be used for for measurement, registration and/or synchronisation functions.

Item	Specification
Input pulse multiplication	x4

■ **Encoder Output Axis**

The encoder output axis provides a way of generating an encoder signal which is cascaded to another device. The encoder signal is controlled by the internal position of this axis.

All move commands and axis parameters available for the servo axis are available.

Item	Specification
Output pulse ratio	64 : 1 (internal counts : output encoder pulses)
Z-marker period	4096 generated encoder edges

■ **Virtual Axis**

A virtual axis is used for computational purposes to create a move profile without physical movement on any actual Servo Driver.

The virtual axis behaves like a perfect servo axis (measured position is equal to the demand position). All move commands and axis parameters available for the servo axis are available.

Using the Parameter Unit or Front Panel

Apart from the MC Unit there are three ways of accessing the Servo Driver:

- Using the Front Panel on the Servo Driver.
- Using the Hand-held Parameter Unit of the Servo Driver.
- Using Servo Driver Monitoring Software on the personal computer.

These three methods enables the user to perform parameter settings, speed and current monitoring, I/O monitoring, autotuning, jogging and other operations.

■ **Limitations on using Parameter Unit together with the MC Unit**

If the MC Unit is mounted to the Servo Driver, it is not allowed to have the Parameter Unit or the Servo Driver Software connected to the Servo Driver when performing the following operations:

- During start-up of the system (either by power-up or software reset).
- During reading or writing Servo Driver parameters using commands DRV_READ and DRV_WRITE.
- During execution of any Driver Command in the MC Unit such as DRV_RESET and DRV_CLEAR.

■ **Front Panel Display Area**

The Front Panel Display Area of the Servo Driver will not be lit in the following circumstances.

- The Display will not be lit for some seconds during start-up (either by power-up or software reset).
- The Display will not be lit for some time when the following commands are executed in the MC Unit:
 - Reading and writing Servo Driver parameters.
 - Clearing the alarm status of the Servo Driver.

3-2 System Set-up

Servo Driver Settings

The Servo Driver is required to have the following settings. Refer to the *OMNUC W-series User's manual (I531)* for details.

Parameter No.	Parameter Name	Required Setting	Explanation	Remark
Pn000.1	Control Mode Selection	0	Speed Control	
		9	Torque / Speed Control	
Pn002.0	Torque command input (during speed control)	0	Not used	
		1	Use TREF as analog torque limit input	
Pn002.1	Speed command input (during torque control)	0	Not used	
		1	Use (S)REF as analog speed limit input	
Pn003.0	Monitor 1	2	Torque Reference Monitor	
Pn003.1	Monitor 2	0	Motor Speed Monitor	
Pn50A.0	Input Signal Allocation Mode	1	User-defined	
Pn50A.1	RUN Signal Input Allocation	8	Always disabled	Switch is controlled by the MC Unit.
Pn50A.2	MING Signal Input Allocation	8	Always disabled	Switch is controlled by the MC Unit.
Pn50A.3	POT Signal Input Allocation	2	Assigned to CN1, pin 42 (valid for low input)	
		8	Always disabled	
Pn50B.0	NOT Signal Input Allocation	3	Assigned to CN1, pin 43 (valid for low input)	
		8	Always disabled	
Pn50B.1	RESET Signal Input Allocation	8	Always disabled	Switch is controlled by the MC Unit.
Pn50C.3	TVSEL Signal Input Allocation	8	Always disabled	Switch is controlled by the MC Unit.
Pn511.0	-	8	Always disabled	
Pn511.1	-	8	Always disabled	
Pn511.2	-	8	Always disabled	
Pn511.3	/EXT3 (Print Registration) Signal Input Allocation	6	Assigned to CN1, pin 46 (valid for low input)	Print registration on rising edge.
		F	Assigned to CN1, pin 46 (valid for high input)	Print registration on falling edge.

Servo Cycle Period Setting

The MC Unit SERVO_PERIOD system parameter can be used to set the MC Unit Servo Cycle and the Servo Driver communication access time. The following values are valid:

SERVO_PERIOD = 500 μ s (default)

SERVO_PERIOD = 1000 μ s

 **Caution** When the parameter has been set, a power down or software reset (using DRV_RESET) must be performed for the complete system. Not doing so may result in undefined behaviour.

3-3 System Functions

This section explains all different functions of the MC Unit. The BASIC commands, functions and parameters can also be found in *SECTION 6 BASIC Motion Control Programming Language*.

3-3-1 Servo Driver Control

Speed Control

The Speed Control mode is the main operation of the motion controller. The speed control mode enables all different speed profiles determined by the motion commands and possibly input encoder data. For an overview of the available motion control commands which can be used, refer to *6-2-1 Motion Control Commands*.

For setting up a Motion Application with Speed Control, use one of the following settings in the Servo Driver.

Parameter No.	Parameter Name	Required Setting	Explanation
Pn000.1	Control Mode Selection	0	Speed Control
		9	Torque / Speed Control

The following BASIC parameters need to be considered to set up the application in the MC Unit.

Parameter	Description
WDOG	The WDOG parameter is the software switch used to control the Driver's Servo ON input, which enables the driver.
SERVO	The SERVO parameter determines whether the base axis runs under position control (ON) or open loop (OFF). When in open loop the output speed reference voltage is determined by the S_REF parameter.
S_REF	The S_REF parameter contains the speed reference value which is applied to the Servo Driver when the base axis is in open loop.
P_GAIN	The P_GAIN parameter contains the proportional gain for the axis.
I_GAIN	The I_GAIN parameter contains the integral gain for the axis.
D_GAIN	The D_GAIN parameter contains the derivative gain for the axis.
VFF_GAIN	The VFF_GAIN parameter contains the speed feed forward gain for the axis.
OV_GAIN	The OV_GAIN parameter contains the output speed gain for the axis.

■ Speed Reference

The Servomotor rotational speed is proportional to the speed reference value resulting from either servo control or open loop (S_REF parameter). The speed reference characteristics are given in the following graph.

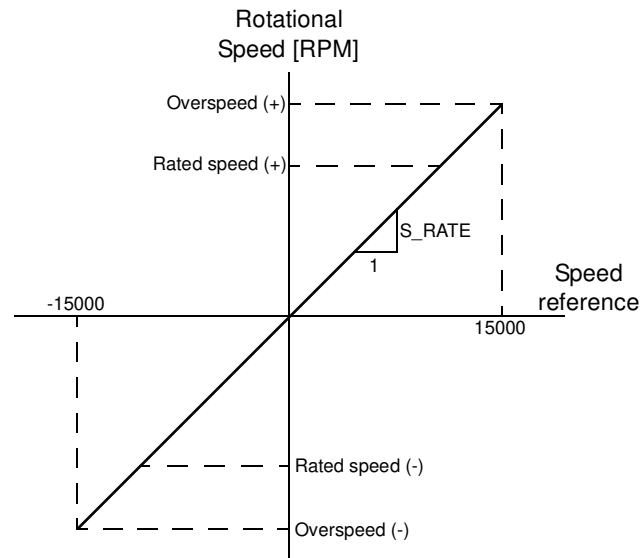

The speed characteristics are Servomotor dependent. The S_RATE axis parameter specifies the speed reference rate of the attached motor. This rate is defined as the amount of Rotational speed (in RPM) per unit of speed reference.

$$\text{Rotational Speed [RPM]} = \text{Speed Reference} \cdot \text{S_RATE}$$

■ Programming Example

In the following example a simple motion application including initiation for a single axis is shown.

```
init:
    BASE (0)
    P_GAIN=.5: I_GAIN=0: D_GAIN=0
    VFF_GAIN=0: OV_GAIN=0
    ACCEL=1000
    DECEL=1000
    SPEED=500
    WDOG=ON
    SERVO=ON

loop:
    MOVE (500)
    WAIT IDLE
    WA (250)
    MOVE (-500)
    WAIT IDLE
    WA (250)
    GOTO loop
```

■ Torque Limit Settings

During speed control, it is possible to limit the torque applied by the Servo Driver by using the torque reference. The required Servo Driver setting is Pn002.0=1 and refer to the Torque control section below for details on the torque reference.

Torque Control

The Torque Control mode is used to apply a fixed torque, independent of the travelling speed. This mode can be used for specific applications which require a constant pressure.

To set up a Motion Application with Torque Control, the following setting in the Servo Driver is required.

Parameter No.	Parameter Name	Required Setting	Explanation
Pn000.1	Control Mode Selection	9	Torque / Speed Control

The output no. 16 is used to control the switch between speed and torque control during operation. Speed control will be applied when OP(16)=OFF, and torque control will be enabled when OP(16)=ON. The torque control reference value is set by the T_REF axis parameter.

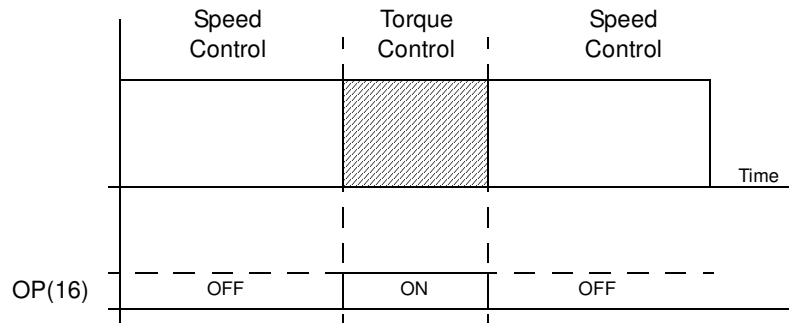

■ **Torque Reference**

The torque applied to the Servomotor is proportional to the torque reference value defined by the T_REF axis parameter. The torque reference characteristics are given in the following graph.

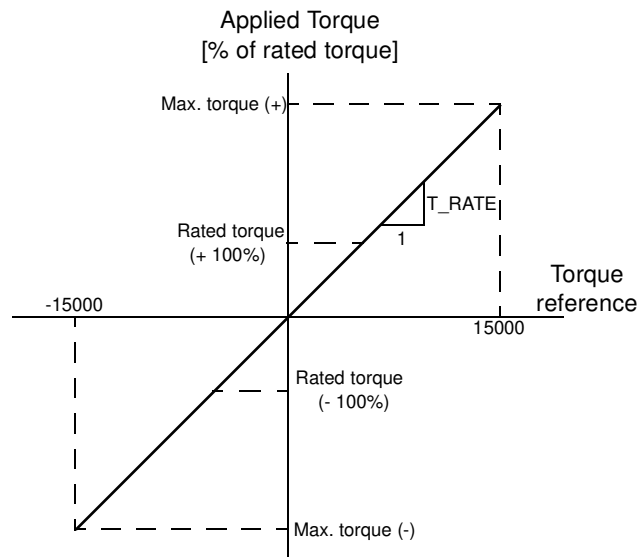

The torque characteristics are Servomotor dependent. The actual applied torque of the Servomotor as percentage of the rated torque can be determined by using the T_RATE axis parameter.

$$\text{Applied Torque [\% of rated torque]} = T_REF \cdot T_RATE$$

■ Speed Limit Settings

During torque control, it is advisable to limit the Servomotor speed by using the speed reference. The required Servo Driver setting is Pn002.1=1 and please refer to the Speed Control section above for details on the speed reference in open loop.

3-3-2 Digital I/O

The MC Unit has two different types of digital I/O. These are the digital I/O on the MC Unit and the mapping of the Servo Driver digital I/O. The inputs and outputs are accessible by using the IN and OP commands in BASIC.

Type	Description	Range (amount)
Input mapping	MC Unit Digital Inputs	0 - 7 (8)
	Servo Driver Digital Inputs	16 - 22 (7)
	Servo Driver Output Signals	24 - 31 (8)
Output mapping	MC Unit Digital Outputs	8 - 13 (6)
	Servo Driver Control Signals	16 - 17 (2)

Input Mapping

■ MC Unit Digital Inputs

The MC Unit inputs are freely allocable to different functions. Some of the functions are origin search, limit switches, jog inputs and so on. The MC Unit uses axis parameters to allocate a certain function to an input. The following table introduces the related axis parameters.

Parameters	Description
DATUM_IN	Selection origin switch input
FAST_JOG	Selection of fast jog input
FHOLD_IN	Selection of feedhold input
FWD_IN	Selection of forward limit input
FWD_JOG	Selection of forward jog input
REV_IN	Selection of reverse limit input
REV_JOG	Selection of reverse jog input

■ Servo Driver Digital Inputs

The digital inputs of the Servo Driver (CN1-40 to CN1-46) can be directly accessed from the MC Unit. The mapping of the inputs is specified in the following table.

Input nr.	Servo Driver Input	Description (according to required Servo Driver settings)
16	CN1-40	General purpose 1
17	CN1-41	General purpose 2
18	CN1-42	Forward drive prohibit (POT) / General purpose 3
19	CN1-43	Reverse drive prohibit (NOT) / General purpose 4
20	CN1-44	General purpose 5
21	CN1-45	General purpose 6
22	CN1-46	Registration input / General purpose 7

■ Servo Driver Output Signals

The relevant Servo Driver output signals can be monitored in the MC Unit. The mapping of the output signals is specified in the following table.

Input nr.	Servo Driver Signal	Description
24	ALM	Alarm output
25	WARN	Overload or regenerative overload warning output

Input nr.	Servo Driver Signal	Description
26	VCMP	Speed conformity output
27	TGON	Servomotor rotation detection output
28	READY	Servo ready output
29	CLIMIT	Current limit detection output
30	VLIMIT	Speed limit detection output
31	SVON	Servo ON complete

Print Registration

For both the Servo Driver axis 0 as the encoder input / output axis 1 the REGIST command can be used to perform print registration on the axis. Print registration captures an axis position as soon as a registration event occurs. The registration event can be defined to be the moment when a registration input or the Z-marker has been detected. Check the description of the REGIST command for further details on print registration.

■ Print registration axis 0

Print registration on axis 0 is done by using the mechanism of the Servo Driver. The registration can be triggered by either the Servomotor encoder Z-marker or by the CN1-46 input of the Servo Driver. When the input is used, one of the following settings is required.

Parameter No.	Parameter Name	Required Setting	Explanation	Remark
Pn511.3	/EXT3 (Print Registration) Signal Input Allocation	6	Assigned to CN1, pin 46 (valid for low input)	Print registration on rising edge.
		F	Assigned to CN1, pin 46 (valid for low input)	Print registration on falling edge.

■ Print registration axis 1

Print registration on axis 1 is done by using the MC Unit registration mechanism. The registration can be triggered by either the input I0/R0, input I1/R1 or the encoder input Z-marker of the MC Unit.

Two registration registers are provided for the axis. This allows for two simultaneous registration events for which the difference in positions can be determined.

Driver Limit Switches

The limit switches should be connected to the Servo Driver. In this case both the Servo Driver and the MC Unit are able to put the system into a safe state. In order to use the Driver POT and NOT signals also in the MC Unit, the following settings are required:

FWD_IN=18 and REV_IN=19

If one of the limits is reached, appropriate countermeasures will be performed. See *SECTION 8 Troubleshooting* for details.

Output Mapping

■ MC Unit Digital Outputs

The physical outputs are freely allocable to any user defined functions. An output can be set and reset depending on the current axis position by using the command PSWITCH.

■ **Servo Driver Control Signals**

Two output signals are implemented as Servo Driver control signals. The control signals are the TVSEL and MING signals and they are specified as follows:

Output nr.	Signal Name	Description	States
16	TVSEL	Control Mode Switch	OFF: Speed control
			ON: Torque control
17	MING	Gain reduction Input	OFF: Speed control by PI control
			ON: Speed control by P control

3-3-3 Monitoring Data

The Servo Driver speed command (REF) analog input of the Servo Driver provides the system an analog input which can be used for general purpose. Furthermore, detailed Servo Driver speed and torque signals can be monitored in the MC Unit.

■ **AIN0: Analog Input**

The analog input is connected to CN1-5 and 6 and uses the Servo Driver input circuit.

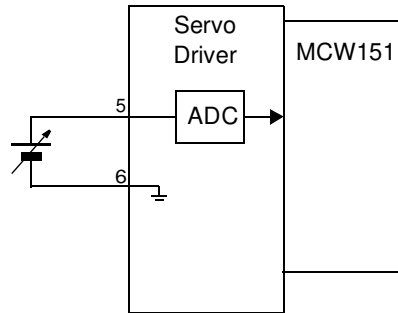

Item	Specification
Input Voltage	Range: (-12 V, 12 V)
Resolution	16-bit over (- 15 V, 15 V)

■ **AIN1: Torque Command Value**

Analog input 1 contains the torque command data from the Servo Driver.

Item	Specification
Output Range	(-15000, 15000)
Resolution	Given by T_RATE axis parameter. <div style="text-align: center;"> </div> <p style="text-align: center;">Torque command [% of rated torque] = AIN1*T_RATE</p>

■ **AIN2: Servomotor Rotation Speed**

Analog input 2 contains the actual Servomotor Rotation Speed data from the Servo Driver.

Item	Specification
Output Range	(-15000, 15000)
Resolution	Given by S_RATE axis parameter. <div style="text-align: center;"> </div> <p style="text-align: center;">Rotation Speed [RPM] = AIN2*S_RATE</p>

■ **AIN3: Torque Monitor Value**

Analog input 3 contains the Torque Monitor Value from the Servo Driver.

Item	Specification
Output Range	(-15000, 15000)
Resolution	Given by T_RATE axis parameter.

Torque Monitor [% of rated torque] = AIN3*T_RATE

3-3-4 Absolute Encoder

If the Servo Driver uses a Servomotor with an absolute encoder, the MC Unit will obtain the absolute encoder position each start-up.

As a result, operation can be performed immediately without any origin search operation at start-up. Use one of the following Servomotors with absolute encoder.

Servo Driver	Servomotor Model	Encoder Resolution
Single-phase 100 V AC	R88M-W□□S-□	16-bit
Single-phase 200 V AC	R88M-W□□T-□	16-bit
Three-phase 400 V AC	R88M-W□□C-□	17-bit

A backup battery is required when using an absolute encoder. Install the battery into the Servo Driver's battery holder.

Item	Specification
R88A-BAT01W	Absolute Encoder Backup Battery Unit Battery: Toshiba ER3V, 3.6 V, 1000 mA

■ **Setting up the encoder**

Set-up the use of the absolute encoder by performing the following setting.

Parameter No.	Parameter Name	Required Setting	Explanation
Pn002.2	Operation switch when using absolute encoder	0	Use as absolute encoder

■ **Multi-turn limit setting**

If an absolute encoder is used, the counter counts the number of rotations from the setup position and output the number of rotations from the Servo Driver to the MC Unit. For some applications it is convenient to reset the multi-turn data back to 0 after a certain amount of turns.

The multi-turn limit settings will set this amount of multi-turn rotations

Parameter No.	Parameter Name	Setting Range	Unit	Default Setting	Restart Power?
Pn205	Absolute encoder multi-turn limit setting	0 - 65535	Rotation	65535	Yes

With the default setting (Pn205=65535), the Servomotor multi-turn data will be as follows:

Multi-turn data

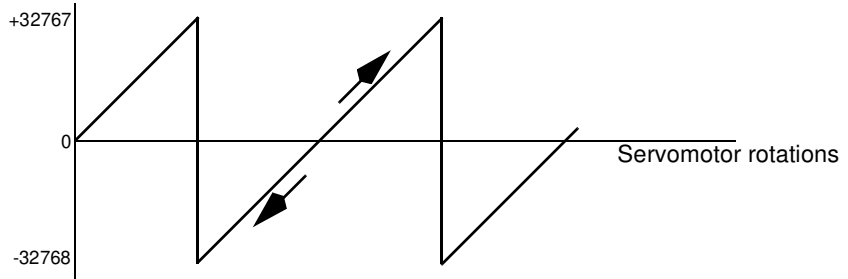

With any other setting than 65535, the Servomotor multi-turn data will be as follows:

Multi-turn data

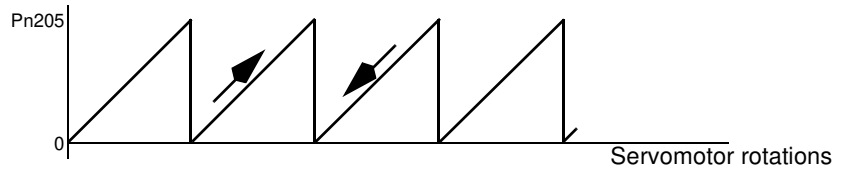

When the value is other than the default setting, the maximum value supported by the MC Unit is 32767.

Absolute Encoder Data

The absolute encoder position will be determined at start-up by retrieving the following information

Variable	Description
M	Number of rotations
R	Resolution of the encoder
P_i	Incremental position within one rotation
P_e	Current position read by the encoder and updated in MC Unit at start-up
P_s	Incremental position within one rotation read at setup (to be determined by user)
P_m	Current position required for system

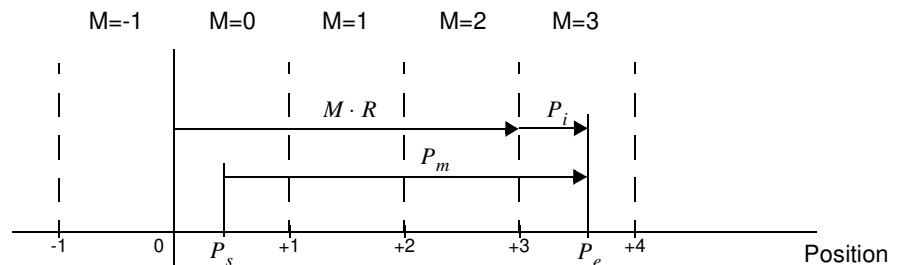

At start-up the internal measured position of the MC Unit will be determined by using the following formula.

$$P_e = M \cdot R + P_i$$

As the relevant position for the application is the current position read by the encoder relative to the origin point determined at setup, the following operation needs to be applied.

$$P_m = P_e - P_s$$

Absolute Encoder Setup Procedure

Perform the setup operation for the absolute encoder in the following cases:

- When using the machine for the first time.
- When the backup alarm (A.81) is generated.
- When the Servo Driver's power is turned OFF and the encoder cable is removed.

The operation can be done by using the Parameter Unit, the front panel on the Servo Driver, or using the personal computer monitoring software. Be sure to follow the procedure carefully. Any mistakes in performing the procedure may lead to faulty operation.

■ Absolute Encoder Setup

At the setup of the application the incremental position of the origin P_s needs to be determined. Perform the following actions:

- Set the correct Servo Driver settings. When the Servo Driver is set up for absolute encoder, the MC Unit position will be automatically updated.
- Put the Servomotor into the origin position for the system.
- Execute the Servo Driver absolute encoder setup function (Fn008) to reset the multi-turn data. Note that performing this operation will stop communication between Servo Driver and MC Unit.
- Power down the system and put the power back on. The MC Unit measured position of axis 0 has now been set and is equal to the P_s . The measured position is represented by the MPOS axis parameter. The value can be used in the start-up routine of the application.

Determining absolute position

At every startup the measured position will be updated to the actual position of the Servomotor. This position P_e is the position as read by the encoder and will need to be compensated for the origin point position P_s . The application initiation routine should contain the following steps.

- Define the current position relative to the origin point position. This possible by using the OFFPOS axis parameter or the DEFPOS command.
- During the parameter setting the UNITS axis parameter is used determining the unit conversion factor. The absolute position is modified accordingly.

Note The coordinate system of the MC Unit is not synchronized to the coordinate system of the Servo Driver. The user must verify that the range of the Servomotor position falls into the MC Unit range. If not, the position will be adjusted within range and the position data is invalid.

3-3-5 Other Servo Driver Commands

Access Servo Driver Parameters

For applications which require online Servo Driver parameter changes or to set-up a new Servo Driver, the MC Unit provides the BASIC commands DRV_READ and DRV_WRITE. Using these commands it is possible to read from and write to all Servo Driver parameters directly from the MC Unit user program.

Reset Servo Driver and MC Unit

The DRV_RESET command will software reset both the Servo Driver and the MC Unit. This may be necessary for instance after a Servo Driver parameter write using DRV_WRITE or for clearing a Servo Driver Alarm.

SECTION 4

Communication Interfaces

This section describes the communication components of the MCW151-E and MCW151-DRT-E. The functionality of the serial communication protocols (including Host Link Master and Slave) and the DeviceNet interface are explained.

- 4-1 Serial Communications 60
 - 4-1-1 Host Link Master 60
 - 4-1-2 Host Link Slave 65
 - 4-1-3 General-purpose 67
- 4-2 DeviceNet (MCW151-DRT-E only) 68
 - 4-2-1 Remote I/O Communications 68
 - 4-2-2 Explicit DeviceNet Messages 72

4-1 Serial Communications

Both the MCW151-E as the MCW151-DRT-E provide serial ports for communication with host-computers, PCs, Programmable Terminals (PTs) and other general-purpose devices. The MC Units are provided with the following protocols.

- Motion Perfect protocol:
For connection to personal computer
- Host Link:
For connection to PCs, Programmable Terminals, other MC Units
- General-purpose:
For connection to general-purpose external devices

MC Unit	Serial Ports	Motion Perfect Protocol	Host Link Master (note 3)	Host Link Slave (note 3)	General Purpose
MCW151-E	Port 0: RS-232C (See note 1)	Yes	No	No	No
	Port 1: RS-232C	No	Yes	Yes	Yes
	Port 2: RS-422A/485 (See note 2)	No	Yes	Yes	Yes
MCW151-DRT-E	Port 0: RS-232C (See note 1)	Yes	No	No	No
	Port 1: RS-232C	No	Yes	Yes	Yes
Devices to connect		Personal Computer	PCs, MCW151s	Programmable Terminals, MCW151s	General-purpose external devices

- Note**
1. The programming port 0 (RS-232C) can only be used for connection to a personal computer with the Motion Perfect configuration software.
 2. A 4-wire RS-422A connection must be used when using Host Link Communication.
 3. For connection to a PC (Host Link Slave), configure the MC Unit as a Host Link Master. For connection to a Programmable Terminal (Host Link Master), configure the MC Unit as a Host Link Slave. When using the Host Link protocol to communicate between two (or more) MCW151, configure one MC Unit as Host Link Master and the others as Host Link Slave.

4-1-1 Host Link Master

In Host Link Master mode, Host Link commands can be sent from the MC Unit to a Host Link Slave such as a PC by using BASIC commands. The BASIC task execution will be paused until the response has been received from the other device. The following BASIC commands can be used:

BASIC Command	Description
SETCOM	SETCOM configures the serial communication port, including enabling the Host Link protocols.
HLM_READ	HLM_READ reads data from the Host Link Slave to either VR or Table memory.
HLM_WRITE	HLM_WRITE writes data to the Host Link Slave from either VR or Table memory.
HLM_COMMAND	HLM_COMMAND executes a specific Host Link command to the Slave.
HLM_STATUS	HLM_STATUS represents the status of the last Host Link Master command.
HLM_TIMEOUT	HLM_TIMEOUT defines the Host Link Master time-out time.

Refer to *SECTION 6 BASIC Motion Control Programming Language* for further details on the commands.

Host Link Master Commands

The following Host Link commands are supported for Host Link Master. A full description of the Host Link protocol can be found in *SYSMAC CS/CJ Series Communications Commands Reference Manual (W342)*.

Type	Header Code	Name	Function
I/O memory reading	RR	CIO AREA READ	Reads the specified number of words beginning with the designated CIO/IR word.
	RL	LR AREA READ	Reads the specified number of words beginning with the designated LR word.
	RH	HR AREA READ	Reads the specified number of words beginning with the designated HR word.
	RD	DM AREA READ	Reads the specified number of words beginning with the designated DM word.
	RJ	AR AREA READ	Reads the specified number of words beginning with the designated AR word.
	RE	EM AREA READ	Reads the specified number of words beginning with the designated EM word.
I/O memory writing	WR	CIO AREA WRITE	Writes the specified data in word units beginning with the designated CIO/IR word.
	WL	LR AREA WRITE	Writes the specified data in word units beginning with the designated LR word.
	WH	HR AREA WRITE	Writes the specified data in word units beginning with the designated HR word.
	WD	DM AREA WRITE	Writes the specified data in word units beginning with the designated DM word.
	WJ	AR AREA WRITE	Writes the specified data in word units beginning with the designated AR word.
	WE	EM AREA WRITE	Writes the specified data in word units beginning with the designated EM word.
CPU Unit status	SC	STATUS WRITE	Changes the CPU Unit's operating mode.
Testing	TS	TEST	Returns, unaltered, a single block that was sent from the Master
PC model code reading	MM	PC MODEL READ	Reads the model code of the CPU Unit
Host Link communications processing	XZ	ABORT (command only)	Aborts the operation being performed by a Host Link command, and returns to the initial status.
	**	INITIALIZE (command only)	Initializes the transfer control procedures for all Host Link Units.
	IC	Undefined command (response only)	This is the response when the command header code is invalid.

The Host Link Master protocol supports the commands only in single frame and can be used with the BASIC commands as shown in the next table. The table also shows for which operating mode of a CPU Unit (Slave) the command is valid.

Header Code	Name	BASIC Command required	CPU Unit Operating Mode		
			RUN	MON	PRG
RR	CIO AREA READ	HLM_READ	Valid	Valid	Valid
RL	LR AREA READ	HLM_READ	Valid	Valid	Valid
RH	HR AREA READ	HLM_READ	Valid	Valid	Valid
RD	DM AREA READ	HLM_READ	Valid	Valid	Valid
RJ	AR AREA READ	HLM_READ	Valid	Valid	Valid
RE	EM AREA READ	HLM_READ	Valid	Valid	Valid

Header Code	Name	BASIC Command required	CPU Unit Operating Mode		
			RUN	MON	PRG
WR	CIO AREA WRITE	HLM_WRITE	Not Valid	Valid	Valid
WL	LR AREA WRITE	HLM_WRITE	Not Valid	Valid	Valid
WH	HR AREA WRITE	HLM_WRITE	Not Valid	Valid	Valid
WD	DM AREA WRITE	HLM_WRITE	Not Valid	Valid	Valid
WJ	AR AREA WRITE	HLM_WRITE	Not Valid	Valid	Valid
WE	EM AREA WRITE	HLM_WRITE	Not Valid	Valid	Valid
SC	STATUS CHANGE	HLM_COMMAND	Valid	Valid	Valid
TS	TEST	HLM_COMMAND	Valid	Valid	Valid
MM	PC MODEL READ	HLM_COMMAND	Valid	Valid	Valid
XZ	ABORT (command only)	HLM_COMMAND	Valid	Valid	Valid
**	INITIALIZE (command only)	HLM_COMMAND	Valid	Valid	Valid
IC	Undefined command (response only)	-	Valid	Valid	Valid

End Code Summary

These are the end codes as they can be defined in the HLM_STATUS parameter.

End code	Contents	Probably cause	Corrective measures
00	Normal completion	No problem exists	---
01	Not executable in RUN mode	The command that was sent cannot be executed when the PC is in RUN mode.	Check the relation between the command and the PC mode.
13	FCS error	The FCS is wrong	Most likely influence from noise, transfer the command again.
14	Format error	The command format is wrong, or a command that cannot be divided has been divided, or the frame length is smaller than the minimum length for the applicable command.	Check the format and transfer the command again.
15	Entry number data error	The data is outside the specified range or too long.	Correct the command arguments and transfer the command again.
18	Frame length error	The maximum frame length of 131 bytes was exceeded.	Check the command and transfer the command again.
19	Not executable	Access right was not obtained.	Obtain access rights.
21	Not executable due to CPU Unit CPU error	The command cannot be executed because a CPU error has occurred in the CPU Unit.	Cycle the CPU Unit's power supply.

Set-up Host Link Master

The SETCOM is required to set-up the serial communication port for the Host Link Master protocol. After setting the following command:

```
SETCOM (baudrate, data_bits, stop_bits, parity, port, 6)
```

the HLM_READ, HLM_WRITE and HLM_COMMAND commands can be used to read and write data using Host Link.

Host Link Master Timeout

The timeout mechanism is implemented to avoid the BASIC task is paused for a long time due to bad or no communication. The timeout time is specified by the HLM_TIMEOUT parameter and is defined as the maximum amount of time the program task will be paused to send the command and receive the response.

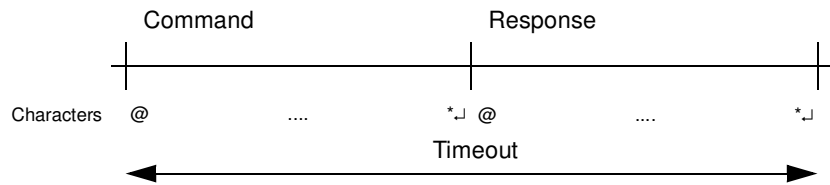

In case the total timeout time has elapsed, the correct status will be defined using HLM_STATUS and the BASIC task will continue. The HLM_TIMEOUT parameter specifies the timeout time for all commands and for all ports.

Host Link Master Status

In the process of sending a Host Link command and receiving a response several problems may occur:

1. The Slave detects an error within the command and will send a corresponding end code indication.
2. The Slave cannot decode the command header code and sends a IC response.
3. The Master detects an error within the response. The corresponding end code will be defined in the status.
4. The timeout time has elapsed for the Master.

The HLM_STATUS BASIC parameter represents the Host Link Master status on the specific port.

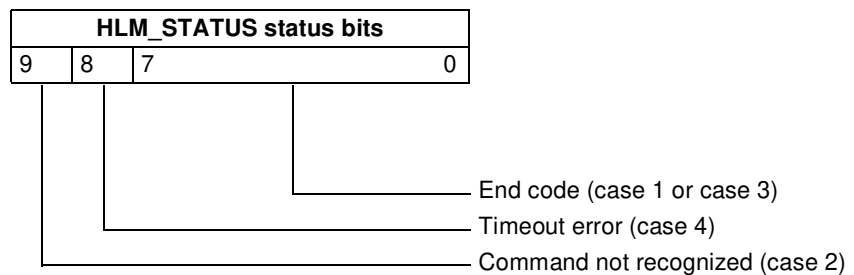

If no error did occur the HLM_STATUS will have value 0. In case of a non-zero value, any appropriate action such as a re-try or emergency stop needs to be programmed in the user BASIC program.

Programming Precautions:

Consider the following precautions when programming the Host Link communications.

1. The Host Link Master commands are required to be executed from one program task only to avoid any multi-task timing problems.
2. The Host Link Master commands provide the tools to exchange data with the Host Link Slave. The user program should contain proper error handling routines to deal with communication failure and perform retries if necessary.

Examples:

Consider the following operations for a MC Unit connected to a PC using port 2 (RS-422A). The Slave PC has node address 13.

■ **Reading data from PC using HLM_READ**

BASIC program:

```
\ Set up Host Link Master for port 2
SETCOM(9600,7,2,2,2,6)
```

```
\ Source address:      CIO/IR 002
\ Amount of data:      2 words
\ Destination address: VR(0)
HLM_READ(2,13,PLC_IR,2,2,MC_VR,0)
```

Host Link Communication:

```
HLM -> HLS: @13RR0002000242*
HLS -> HLM: @13RR000101010241*
```

Result:

VR address	value
0	257.0000
1	258.0000

■ **Writing data to PC using HLM_WRITE**

BASIC program:

```
\ Source address:      Table(18)
\ Amount of data:      2 words
\ Destination address: LR 014
TABLE(18,$0701,$0702)
HLM_WRITE(2,13,PLC_LR,14,2,MC_TABLE,18)
```

Host Link Communication:

```
HLM -> HLS: @13WL0014070107025F*
HLS -> HLM: @13WL0059*
```

Result:

LR address	value
0	701 (Hex)
1	702 (Hex)

■ **Send TS (test) command to PC using HLM_COMMAND**

BASIC program:

```
HLM_COMMAND(HLM_TEST,2,13)
```

Host Link Communication:

```
HLM -> HLS: @13TSMCW151 TEST STRING2A*
HLS -> HLM: @13TSMCW151 TEST STRING2A*
```

Result:

HLM_STATUS PORT(2) = 0, which implies correct communication.

■ **Set PC in MONITOR mode using HLM_COMMAND**

BASIC program:

```
HLM_COMMAND(HLM_STWR,2,13,2)
```

Host Link Communication:

```
HLM -> HLS: @13SC0250*
HLS -> HLM: @13SC0052*
```

Result:

The PC is running in MON mode. Note that this is necessary for writing data to the PC using HLM_WRITE.

■ **Reading PC model code using HLM_COMMAND (timeout)**

BASIC program:

```
HLM_TIMEOUT=500
` Destination address: VR(100)
HLM_COMMAND (HLM_MREAD, 2, 13, MC_VR, 100)
```

Host Link Communication:

```
HLM -> HLS: @13MM42*
HLS -> HLM: no response
```

Result:

As no response has been received from the PC, after 500 servo cycles the HLM_STATUS PORT(2) will have value 256 (bit 8 is set).

4-1-2 Host Link Slave

In Host Link Slave mode, a Host Link Master such as a Programmable Terminal can read data from and write data to the MC Unit. The MC Unit will have the following mapping for the Host Link Slave.

MCW151 Memory	Host Link Mapping	Address Range
VR	CIO	0 to 250
Table	DM	0 to 7999

The following BASIC commands are used:

BASIC Command	Description
SETCOM	SETCOM configures the serial communication port, including enabling the Host Link protocols.
HLS_NODE	HLS_NODE defines the Slave unit number for the Host Link Slave protocol.
HLS_MODEL	HLS_MODEL defines the MC Unit model code for the Host Link Slave protocol.

Refer to *SECTION 6 BASIC Motion Control Programming Language* for further details on the commands.

Host Link Slave Commands

The list of Host Link commands that are supported for the Host Link Slave are listed here below. The protocol supports both single frame and multiple frame transfer. A full description of the Host Link protocol can be found in *SYSMAC CS/CJ Series Communications Commands Reference Manual (W342)*.

Type	Header Code	Name	Function
I/O memory reading	RR	CIO AREA READ	Reads the specified number of words from VR memory beginning with the designated word.
	RD	DM AREA READ	Reads the specified number of words from Table memory beginning with the designated word.
I/O memory writing	WR	CIO AREA WRITE	Writes the specified data in word units to VR memory beginning with the designated word.
	WD	DM AREA WRITE	Writes the specified data in word units to Table memory beginning with the designated word.

Type	Header Code	Name	Function
Testing	TS	TEST	Returns, unaltered, a single block that was sent from the Master.
PC model code reading	MM	PC MODEL READ	Reads the model code of the MC Unit as specified by the HLS_MODEL parameter.
I/O memory area registration and reading	QQMR	REGISTER I/O MEMORY	Registers the I/O table with the contents of the actual I/O configuration
	QQIR	READ I/O MEMORY	Reads the registered I/O memory words/bits all at once.
Host Link communications processing	XZ	ABORT (command only)	Aborts the operation being performed by a Host Link command, and returns to the initial status.
	**	INITIALIZE (command only)	Initializes the transfer control procedures for all Host Link Units.
	IC	Undefined command (response only)	This is the response when the command header code is invalid.

End Code Summary

These are the response end codes that can be returned in the response frame.

End code	Contents	Probably cause	Corrective measures
00	Normal completion	No problem exists	---
13	FCS error	The FCS is wrong	Check the FCS calculation method. If there was influence from noise, transfer the command again.
14	Format error	The command format is wrong, or a command that cannot be divided has been divided, or the frame length is smaller than the minimum length for the applicable command.	Check the format and transfer the command again.
15	Entry number data error	The data is outside the specified range or too long.	Correct the command arguments and transfer the command again.
18	Frame length error	The maximum frame length of 131 bytes was exceeded.	Check the data and transfer the command again.
19	Not executable	An I/O memory batch was executed when items to read were not registered.	Register items to read before attempting batch read.
A3	Aborted due to FCS error in transmission data	An FCS error occurred in the second or later frame.	Correct the command data and transfer the command again.
A4	Aborted due to format error in transmission data	The command format did not match the number of bytes in the second or later frame.	
A5	Aborted due to entry number data error in transmission data	There was an entry number data error in the second or later frame or a data length error.	
A8	Aborted due to frame length error in transmission data	The length of the second or later frames exceeded the maximum of 128 bytes.	

Set-up Host Link Slave

The SETCOM is required to set-up the serial communication port for the Host Link Slave protocol. After setting the following command:

```
SETCOM (baudrate, data_bits, stop_bits, parity, port, 5)
```

the MC Unit will respond to any Host Link command from the master with the specified node number as set with the HLS_NODE parameter.

Example:

Consider a MCW151-E connected to the NT11S Programmable Terminal using port 2 (RS-422A). The Host Link Slave can be configured by using the following program:

```

` Define Host Link Slave node
HLS_NODE = 15
` Define Host Link Slave model code
HLS_MODEL = $FA
` Set up Host Link Slave for port 2
SETCOM(9600,7,2,2,2,5)

```

The MC Unit is now set up to communicate with the Programmable Terminal.

4-1-3 General-purpose

The MCW151 provide a set of commands to implement any user-defined protocol. The list of commands is provided here.

BASIC Command	Description
SETCOM	SETCOM configures the serial communication port, including enabling the Host Link protocols.
GET	GET assigns the ASCII code of a received character to a variable.
INPUT	INPUT will assign numerical input string values to the specified variables.
KEY	KEY returns TRUE or FALSE depending on if a character has been received.
LINPUT	LINPUT assigns the ASCII code of the characters to an array of variables.
PRINT	PRINT outputs a series of characters to a serial port.

Refer to *SECTION 6 BASIC Motion Control Programming Language* for further details on the commands.

Example:

Consider a MCW151-E connected to a general-purpose device using port 2 (RS-422A). The following program will receive a series of data elements and write it to VR variables:

```

` Set up General-purpose protocol for port 2
SETCOM(9600,7,2,2,2,0)
` Receive input
FOR i=0 to 99
  INPUT#2, VR(i)
NEXT i

```

4-2 DeviceNet (MCW151-DRT-E only)

The MCW151-DRT-E is connected to the DeviceNet network as a DeviceNet Slave. This allows data from any area in the MC Unit to be read or written from the Master. Through the DeviceNet, the MC Unit memory can be accessed using one of the following two methods.

Accessing MC Unit memory through remote I/O areas

Remote I/O communication enables automatic exchange of I/O data between the MC Unit and a PC with DeviceNet Master Unit without special programming in the PC. For the MC Unit, the input and output areas can each contain up to 4 words.

Once the MC Unit's memory input and output areas have been set, the MC Unit memory can be read and written. The input area is regularly read by the Master and the output is regularly written from the Master. This process maintains consistency between the Slave's input and output areas and the input and output areas allocated to the Master.

The data is transferred automatically at high speed so it is useful to use this for data which requires regular data transfers with the Master.

Accessing MC Unit memory with Explicit Message Communications

When larger amount of data needs to be exchanged with the MC Unit, explicit message communications can be used.

Transferring data with explicit message communications takes more time than transferring data with the input and output areas, but all of the MC Unit memory can be accessed.

Use this feature for large data transfers which can be performed when required, such as transferring position profile data.

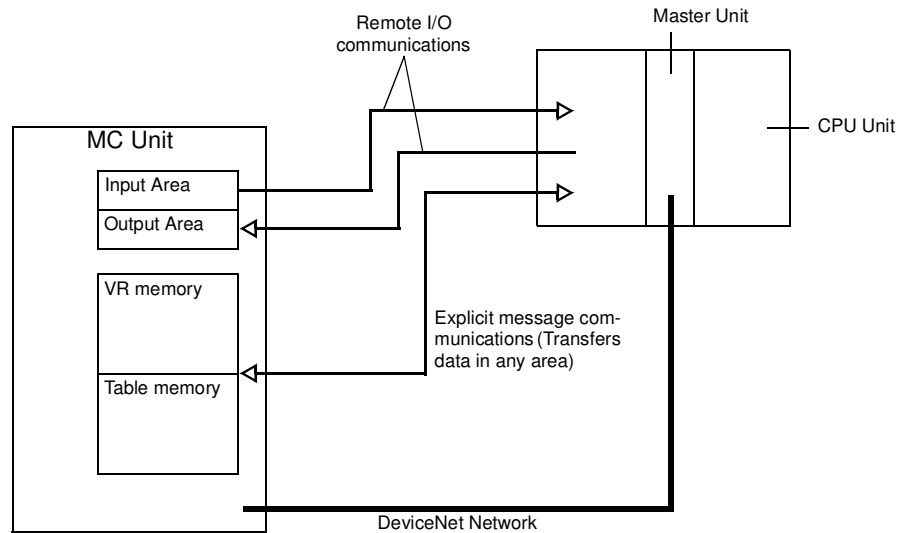

Refer to *Appendix B Device Protocol (MCW151-DRT-E only)* for the Device Protocol definition.

4-2-1 Remote I/O Communications

The Master and Slaves can communicate as described below with DeviceNet remote I/O communications.

- **Input Area:**
Inputs at the Slave are read automatically and mirrored in the Master's input area.
- **Output Area:**
Data written in the output area allocated in the Master's memory are automatically output to the corresponding Slave.

Allocating Input and Output Areas to the Master

Note The names of the input and output areas indicate the direction of I/O from the perspective of the Master.

The MC Unit's input and output areas are allocated to the Unit as a DeviceNet Slave in the Master's I/O memory.

■ **Fixed Allocation**

With fixed allocation, words in the CPU Unit are allocated in the order of node numbers starting from node 00. The words are divided into an output area and an input area. The specific words that are allocated depend on the model of PC being used.

Each node address is allocated one input and one output word. If a Slave requires more than one input or one output word, then it is assigned more than one node address. If a Slave requires less than one word, it simply uses the rightmost bits in the word allocated to it.

The MC Unit will occupy the number of words (number of node numbers) set for the input and output areas using the external DIP switch pin 7.

Pin 7	Mode	Description
OFF	Mode I (default)	Input: 2 words Output: 2 words
ON	Mode II	Input: 4 words Output: 4 words

For example when the MC Unit has been selected to Mode II and the node number is set to 5, the input area will occupy the words for nodes 5 through 8 and the output area will also occupy the words for nodes 5 through 8.

■ **Free Allocation**

A Configurator can be used to allocate a total of 4 blocks, blocks 1 and 2 in the output area and input blocks 1 and 2 in the input area in any order.

Slaves and blocks can be allocated in any order. The number of words (number of bytes) that are used depends upon the addresses. The minimum is one byte and the maximum is 64 bytes (32 words).

Area Allocation

■ DeviceNet Input

The table below specifies the input data allocation of the status of the MC Unit.

Input word	Bit	Name	Function
1	00	Unit Operating Flag	1: MC Unit is operating.
			0: MC Unit is not operating.
	01	Servo Driver Enable Flag	1: Servo Driver enabled.
			0: Servo Driver disabled.
	02	Axis 0 Servo ON	1: Servo is ON for Servo Driver axis 0. The axis is in closed loop.
			0: Servo is OFF for Servo Driver axis 0. The axis is in open loop.
	03	MC Unit Motion Error Flag	1: Motion error has occurred for one of the axes.
			0: No motion error.
	04	MC Unit Motion Warning Flag	1: Motion warning has occurred for Servo Driver axis 0. The following error warning limit is exceeded.
			0: No motion warning.
	05	Servo Driver Alarm Flag	1: Servo Driver alarm (ALM) has occurred.
			0: No Servo Driver alarm.
	06	Servo Driver Warning Flag	1: Servo Driver warning (WARN) has occurred.
			0: No Servo Driver warning.
	07	Servo Driver Communication Error	1: Communication error between MC Unit and Servo Driver has occurred.
0: No communication error.			
08	Axis 0 Forward Limit Flag	1: Forward limit is set for Servo Driver axis 0.	
		0: No forward limit.	
09	Axis 0 Reverse Limit Flag	1: Reverse limit is set for Servo Driver axis 0.	
		0: No reverse limit.	
10	Axis 0 Datuming Flag	1: Datuming (origin search) in progress for Servo Driver axis 0.	
		0: No datuming.	
11	Axis 0 Feedhold Flag	1: Feedhold input is set for Servo Driver axis 0.	
		0: No feedhold.	
12	Axis 0 Following Error Limit Flag	1: Following error limit is reached for Servo Driver axis 0.	
		0: No following error limit.	
13	Task 1 Flag	1: Program is running on task no. 1.	
		0: No program is running on task.	
14	Task 2 Flag	1: Program is running on task no. 2.	
		0: No program is running on task.	
15	Task 3 Flag	1: Program is running on task no. 3.	
		0: No program is running on task.	
2	00 to 15	User defined	Contents is allocated by using the FB_SET parameter.
3 (see note)	00 to 15	User defined	Contents is set by VR(2).
4 (see note)	00 to 15	User defined	Contents is set by VR(3).

Note The input words no. 3 and 4 will only be transferred when I/O Slave messaging mode II is selected.

Input word 2

The allocation of input word 2 is determined by the FB_SET parameter. The following settings are supported.

FB_SET value	Bit	Name	Function
0	00 to 15	User defined	Contents is set by VR(0)
1	MC Unit I/O Mapping		
	00	(Registration) Input 0	1: Input is ON 0: Input is OFF
	01	(Registration) Input 1	1: Input is ON 0: Input is OFF
	02	Input 2	1: Input is ON 0: Input is OFF
	03	Input 3	1: Input is ON 0: Input is OFF
	04	Input 4	1: Input is ON 0: Input is OFF
	05	Input 5	1: Input is ON 0: Input is OFF
	06	Input 6	1: Input is ON 0: Input is OFF
	07	Input 7	1: Input is ON 0: Input is OFF
	08	Output 8	1: Output is ON 0: Output is OFF
	09	Output 9	1: Output is ON 0: Output is OFF
	10	Output 10	1: Output is ON 0: Output is OFF
	11	Output 11	1: Output is ON 0: Output is OFF
	12	Output 12	1: Output is ON 0: Output is OFF
	13	Output 13	1: Output is ON 0: Output is OFF
	14 to 15	Reserved	
2	Servo Driver I/O Mapping		
	00	Input CN1-40	1: Input is ON 0: Input is OFF
	01	Input CN1-41	1: Input is ON 0: Input is OFF
	02	Input CN1-42	1: Input is ON 0: Input is OFF
	03	Input CN1-43	1: Input is ON 0: Input is OFF
	04	Input CN1-44	1: Input is ON 0: Input is OFF
	05	Input CN1-45	1: Input is ON 0: Input is OFF
	06	Input CN1-46	1: Input is ON 0: Input is OFF
	07	Reserved	
	08	ALM	1: Servo Driver alarm occurred
			0: No Servo Driver alarm
	09	WARN	1: Servo Driver warning occurred
			0: No Servo Driver warning
	10	VCMP	1: Speed match
			0: No speed match
	11	TGON	1: Servomotor rotating
0: Servomotor not rotating			
12	READY	1: Servo ready	
		0: Servo not ready	
13	CLIMT	1: Torque limit	
		0: No torque limit	
14	VLIMIT	1: Speed limit	
		0: No speed limit	
15	SVON	1: Servo ON complete	
		0: Servo ON not complete	

■ **DeviceNet Output**

The table below specifies the output data allocation of the status of the MC Unit.

Output word	Bit	Name	Function
1	00 to 15	User defined	Contents is set at VR(1).
2	00 to 15	User defined	Contents is set at VR(4).
3 (see note)	00 to 15	User defined	Contents is set at VR(5).
4 (see note)	00 to 15	User defined	Contents is set at VR(6).

Note The output words no. 3 and 4 will only be transferred when I/O Slave messaging mode II is selected.

4-2-2 Explicit DeviceNet Messages

Explicit DeviceNet messages (commands) can be sent from the Master to write and read data to and from both the VR and Table memory of the MC Unit.

This section presents the explicit messages supported by the MC Unit, and provides usage examples. For further details on using explicit messages on the Master Unit, refer to the Master Unit's Operation Manual.

■ **MC Unit Explicit Message List**

Explicit message	Function	Page
TABLE DATA READ (THREE-WORD FORMAT)	Reads the specified MC Unit's Table data. The data is converted into three-word format.	75
VR DATA READ (THREE-WORD FORMAT)	Reads the specified MC Unit's VR data. The data is converted into three-word format.	76
VR DATA READ (ONE-WORD FORMAT)	Reads the specified MC Unit's VR data in words.	76
TABLE DATA WRITE (THREE-WORD FORMAT)	Writes the specified MC Unit's Table data. The data is three-word format and will be converted into floating point.	77
VR DATA WRITE (THREE-WORD FORMAT)	Writes the specified MC Unit's VR data. The data is three-word format and will be converted into floating point.	78
VR DATA WRITE (ONE-WORD FORMAT)	Writes the specified MC Unit's VR data in words.	79
RESET	Will perform a software reset of both the MC Unit and the Servo Driver.	80

■ **Data Formats**

The MC Unit explicit messaging supports two data format types.

One-word format

The data is transferred word by word from each PC memory location to each variable in the MC unit and vice versa. The value in the MC Unit is always the integer equivalent of the hexadecimal value in the PC (no 2's complement). From the floating-point data in the MC unit only the integer part will be transferred. The valid range is [0,65535].

Three-word format

The data in the PC is represented by three memory elements, in total three words. The following is the configuration of a BCD position data item.

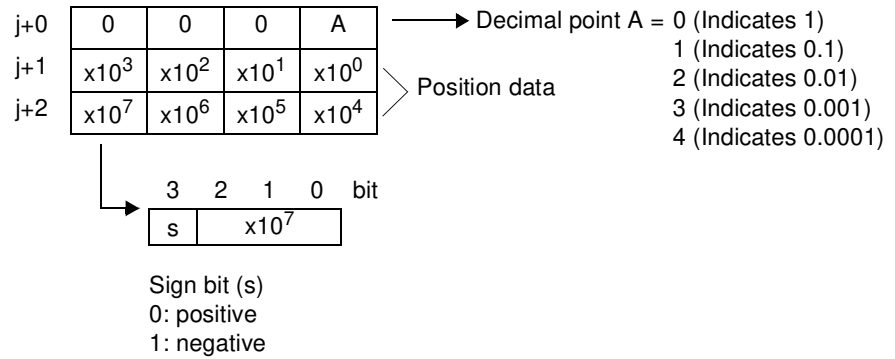

Example 1: The three-word format of value 56143 is given by

j+0	0	0	0	0
j+1	6	1	4	3
j+2	0	0	0	5

Example 2: The three-word format of value -48.89 is given by

j+0	0	0	0	2
j+1	4	8	8	9
j+2	8	0	0	0

One data item uses three words. Therefore the total words for data transfers should be the amount of data transferred multiplied by three.

4-2-2-1 Message Communications

When sending explicit messages from an OMRON Master Unit, use the CMND or IOWR instruction to send the message data as an EXPLICIT MESSAGE SEND (28 01) FINS command.

Command Block

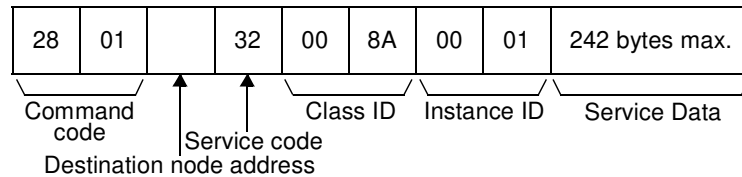

Response Block

Normal Response

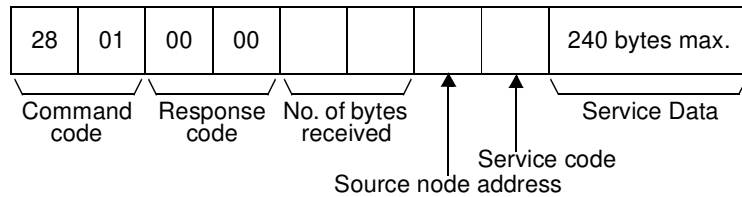

Note For a normal response, the leftmost bit of the service code specified in the command will be turned ON and then returned. For example, a command service code of 32 Hex is returned as B2 Hex in the response.

Error Response

The following response is returned if an error occurs for the explicit message.

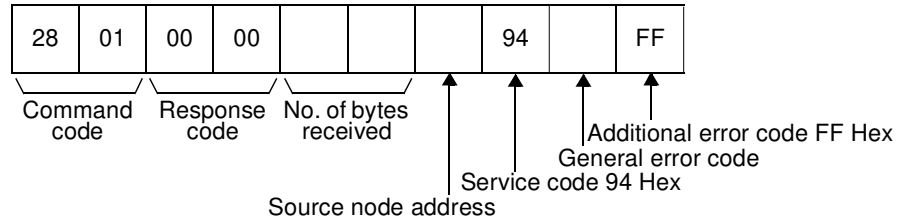

Parameters

Destination node address (command)

The node address of the destination of the explicit message.

Service code (command, response)

A service code defined for DeviceNet. In a normal response, bit 15 of the service code specified will be turned ON and returned. For an error response, the service code will always be 94 Hex.

Class ID (command)

The class ID of the destination of the explicit message. The class ID is always 008A Hex when reading or writing the MC Unit memory.

Instance ID (command)

The instance ID of the destination of the explicit message. The instance ID is always 0001 Hex when reading or writing the MC Unit memory.

Service data (command, response)

The data defined for the services codes.

No. of bytes received (response)

The number of bytes received from the destination node address (local node).

Source node address (response)

The node address of the OMRON I/O Slave Unit or slave manufactured by another company of which the explicit message was sent is returned.

General error code (response)

The following error codes may be returned.

General error code	Error name	Cause of error
08 Hex	Service not supported	The requested service was not implemented or was not defined for this Object Class/Instance.
09 Hex	Invalid attribute value	Invalid attribute data detected.
11 Hex	Reply data too large	The data to be transmitted in the response buffer is larger than the allocated response buffer.
13 Hex	Not enough data	The service did not supply enough data to perform the specified operation.
15 Hex	Too much data	The service supplied more data than was expected.
16 Hex	Object does not exist	The object does not exist in the device.
20 Hex	Invalid parameter	A parameter associated with the request was invalid.

- Note**
1. Unlike other FINS commands, this command is addressed to the local node's DeviceNet Master Unit. The actual destination of the explicit message is given in the command data, as described above. Always specify the local node's DeviceNet Master Unit in the control code of the CMND or IOWR instruction. An error will occur if another node's Master Unit is specified.
 2. If the DeviceNet Master Unit receives an explicit message, it will automatically return a response.

4-2-2-2 Explicit Messages

TABLE DATA READ (THREE-WORD FORMAT)

TABLE DATA READ (THREE-WORD FORMAT) will read Table data. The data will be converted in three-word format.

Command Block

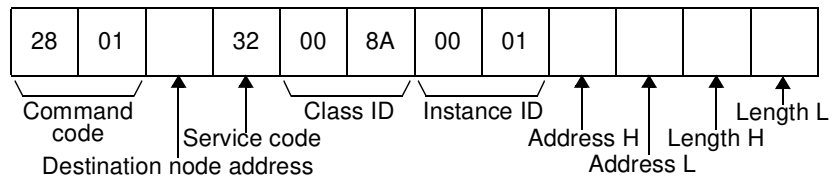

Response Block

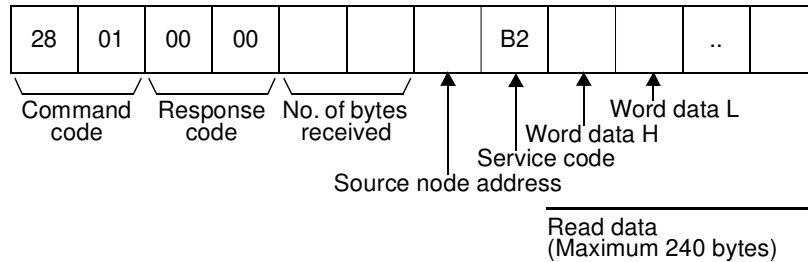

Parameters

Service code (command, response)

In the command, 32 Hex is specified. In the response, the leftmost bit is turned ON and B2 Hex is returned.

Address H, Address L (command)

The address in hexadecimal of the first word of data to be read.

Address H: Leftmost 2 digits of the address in 4-digit hexadecimal.

Address L: Rightmost 2 digits of the address in 4-digit hexadecimal.

For the Table memory, the maximum value is 7999 (1F3F Hex).

Length H, Length L (command)

The number of Table memory elements to read.

Length H: Leftmost 2 digits of the length in 4-digit hexadecimal (ignored for MC Unit).

Length L: Rightmost 2 digits of the length in 4-digit hexadecimal.

When an OMRON Master is being used, the maximum is 39 elements (27 Hex). The 39 Table elements imply 234 bytes to be transferred.

Read data (response)

The specified data is returned from word H (leftmost byte: bits 08 to 15) to word L (rightmost byte: bits 00 to 07).

- Note** The user should be aware that the MC Unit does not check if the MC Unit memory data is within range of the three-word format.

VR DATA READ (THREE-WORD FORMAT)

VR DATA READ (THREE-WORD FORMAT) will read VR data. The data will be converted in three-word format.

Command Block

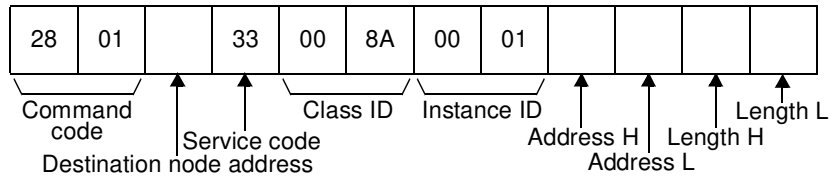

Response Block

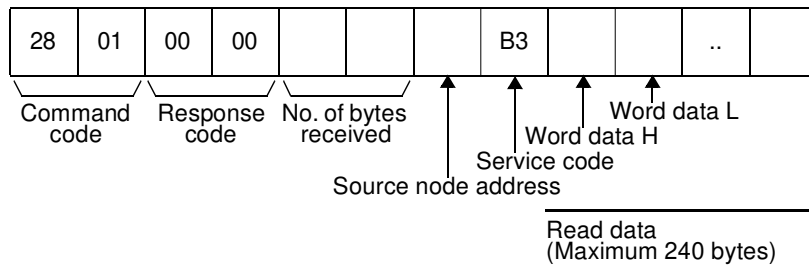

Parameters

Service code (command, response)

In the command, 33 Hex is specified. In the response, the leftmost bit is turned ON and B3 Hex is returned.

Address H, Address L (command)

The address in hexadecimal of the first word of data to be read.

Address H: Leftmost 2 digits of the address in 4-digit hexadecimal (ignored for MC Unit).

Address L: Rightmost 2 digits of the address in 4-digit hexadecimal.

For the VR memory, the maximum value is 250 (FA Hex).

Length H, Length L (command)

The number of VR memory elements to read.

Length H: Leftmost 2 digits of the length in 4-digit hexadecimal (ignored for MC Unit).

Length L: Rightmost 2 digits of the length in 4-digit hexadecimal.

When an OMRON Master is being used, the maximum is 39 elements (27 Hex). The 39 VR elements imply 234 bytes to be transferred.

Read data (response)

The specified data is returned from word H (leftmost byte: bits 08 to 15) to word L (rightmost byte: bits 00 to 07).

Note The user should be aware that the MC Unit does not check if the MC Unit memory data is within range of the three-word format.

VR DATA READ (ONE-WORD FORMAT)

VR DATA READ (ONE-WORD FORMAT) will read VR data. The data will be converted in one-word format.

Command Block

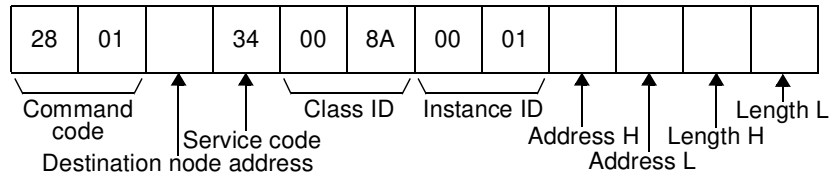

Response Block

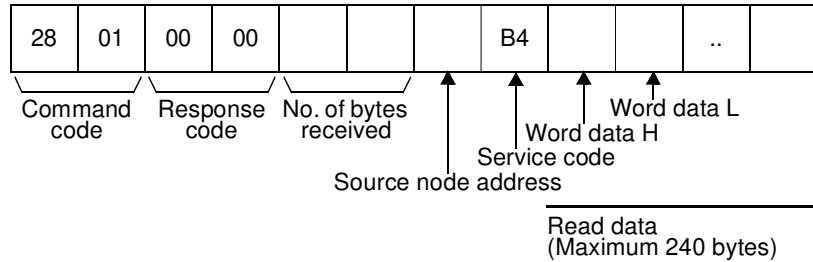

Parameters

Service code (command, response)

In the command, 34 Hex is specified. In the response, the leftmost bit is turned ON and B4 Hex is returned.

Address H, Address L (command)

The address in hexadecimal of the first word of data to be read.

Address H: Leftmost 2 digits of the address in 4-digit hexadecimal (ignored for MC Unit).

Address L: Rightmost 2 digits of the address in 4-digit hexadecimal.

For the VR memory, the maximum value is 250 (FA Hex).

Length H, Length L (command)

The number of VR memory elements to read.

Length H: Leftmost 2 digits of the length in 4-digit hexadecimal (ignored for MC Unit).

Length L: Rightmost 2 digits of the length in 4-digit hexadecimal.

When an OMRON Master is being used, the maximum is 119 elements (77 Hex). The 119 VR elements imply 238 bytes to be transferred.

Read data (response)

The specified data is returned from word H (leftmost byte: bits 08 to 15) to word L (rightmost byte: bits 00 to 07).

TABLE DATA WRITE (THREE-WORD FORMAT)

TABLE DATA WRITE (THREE-WORD FORMAT) will write Table data. The Table data will be defined according to the three-word format.

Command Block

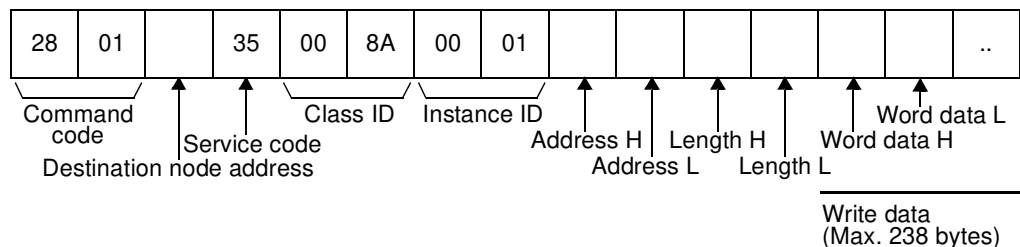

Response Block

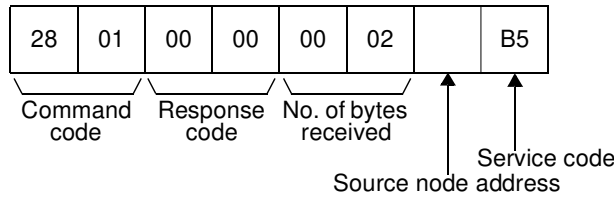

Parameters

Service code (command, response)

In the command, 35 Hex is specified. In the response, the leftmost bit is turned ON and B5 Hex is returned.

Address H, Address L (command)

The address in hexadecimal of the first word of data to be read.

Address H: Leftmost 2 digits of the address in 4-digit hexadecimal.

Address L: Rightmost 2 digits of the address in 4-digit hexadecimal.

For the Table memory, the maximum value is 7999 (1F3F Hex).

Length H, Length L (command)

The number of Table memory elements to write.

Length H: Leftmost 2 digits of the length in 4-digit hexadecimal (ignored for MC Unit).

Length L: Rightmost 2 digits of the length in 4-digit hexadecimal.

When an OMRON Master is being used, the maximum is 39 elements (27 Hex). The 39 Table elements imply 234 bytes to be transferred.

Write data (command)

The specified data should be written from word H (leftmost byte: bits 08 to 15) to word L (rightmost byte: bits 00 to 07).

Note The user should be aware that the MC Unit does not check if the PC memory data complies to the three-word format.

VR DATA WRITE (THREE-WORD FORMAT)

VR DATA WRITE (THREE-WORD FORMAT) will write VR data. The VR data will be defined according to the three-word format.

Command Block

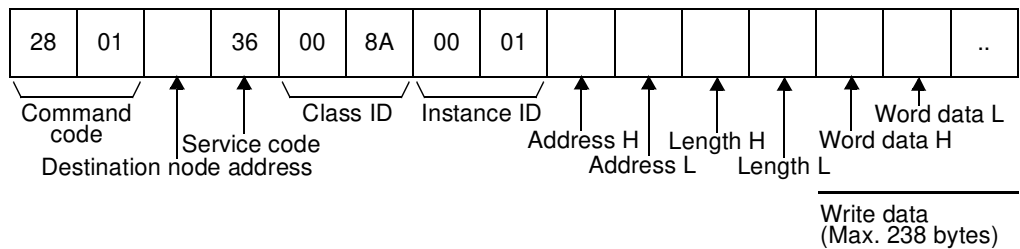

Response Block

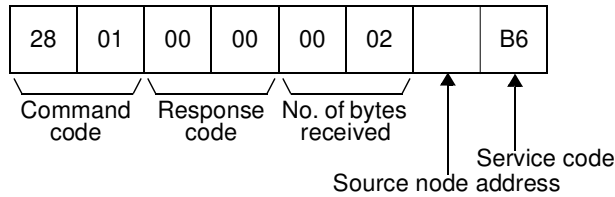

Parameters

Service code (command, response)

In the command, 36 Hex is specified. In the response, the leftmost bit is turned ON and B6 Hex is returned.

Address H, Address L (command)

The address in hexadecimal of the first word of data to be read.

Address H: Leftmost 2 digits of the address in 4-digit hexadecimal (ignored for MC Unit).

Address L: Rightmost 2 digits of the address in 4-digit hexadecimal.

For the VR memory, the maximum value is 250 (FA Hex).

Length H, Length L (command)

The number of VR memory elements to read.

Length H: Leftmost 2 digits of the length in 4-digit hexadecimal (ignored for MC Unit).

Length L: Rightmost 2 digits of the length in 4-digit hexadecimal.

When an OMRON Master is being used, the maximum is 39 elements (27 Hex). The 39 VR elements imply 234 bytes to be transferred.

Write data (command)

The specified data should be written from word H (leftmost byte: bits 08 to 15) to word L (rightmost byte: bits 00 to 07).

Note The user should be aware that the MC Unit does not check if the PC memory data complies to the three-word format.

VR DATA WRITE (ONE-WORD FORMAT)

VR DATA WRITE (ONE-WORD FORMAT) will write VR data. The VR data will be defined according to the one-word format.

Command Block

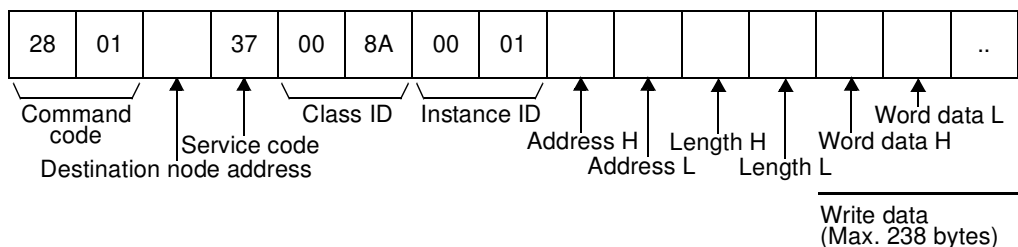

Response Block

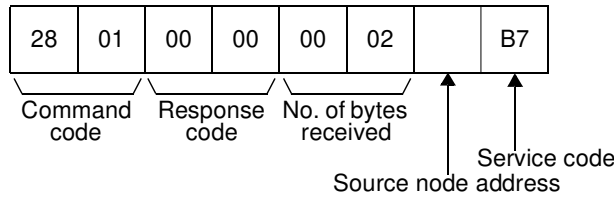

Parameters

Service code (command, response)

In the command, 37 Hex is specified. In the response, the leftmost bit is turned ON and B7 Hex is returned.

Address H, Address L (command)

The address in hexadecimal of the first word of data to be read.

Address H: Leftmost 2 digits of the address in 4-digit hexadecimal (ignored for MC Unit).

Address L: Rightmost 2 digits of the address in 4-digit hexadecimal.

For the VR memory, the maximum value is 250 (FA Hex).

Length H, Length L (command)

The number of VR memory elements to write.

Length H: Leftmost 2 digits of the length in 4-digit hexadecimal (ignored for MC Unit).

Length L: Rightmost 2 digits of the length in 4-digit hexadecimal.

When an OMRON Master is being used, the maximum is 119 elements (77 Hex). The 119 VR elements imply 238 bytes to be transferred.

Write data (command)

The specified data should be written from word H (leftmost byte: bits 08 to 15) to word L (rightmost byte: bits 00 to 07).

RESET

RESET will perform a software reset of both the MC Unit and the Servo Driver (as DRV_RESET command).

Command Block

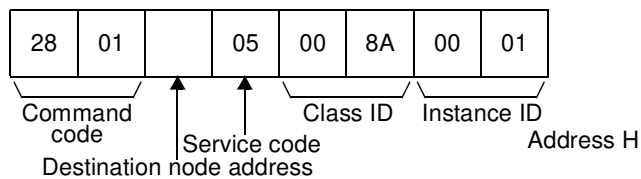

Response Block

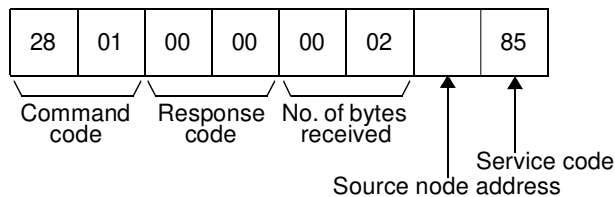

Parameters

Service code (command, response)

In the command, 05 Hex is specified. In the response, the leftmost bit is turned ON and 85 Hex is returned.

4-2-2-3 Sample Programs

Using the CMD(490) instruction to read data

In the following example, the CMD(490) instruction is used to read data (one-word format) from VR(200) to VR(203) (4 words) on the Slave Unit, and store them to the Master (CS1 PCs) from D02000 onwards. For more information on explicit messages, refer to the *DeviceNet Master Unit Operation Manual* or for information on the CMD(490) instruction, refer to the *PCs Operation Manual*.

Example Conditions

Master node address: 0
 Slave network address: 1
 Slave node address: 2

Example: Using CMD(490)

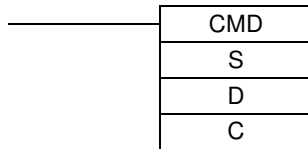

Command Words (S: First Command word)

Word	Contents (Hex)	Meaning
S	28 01	EXPLICIT MESSAGE SEND command code: 28 01 Hex
S+1	02 34	Slave node address: 2 VR DATA READ (ONE-WORD FORMAT) command service code: 34 Hex
S+2	00 8A	Class ID: 008A Hex
S+3	00 01	Instance ID: 0001 Hex
S+4	00 C8	Read start address VR(200): 00C8 Hex
S+5	00 04	Number of Table elements to write: 0004 Hex

D: Response Words (D: First Response Word)

Results are stored as shown in the following table.

Word	Contents (Hex)	Meaning
D	28 01	EXPLICIT MESSAGE SEND command code: 28 01 Hex
D+1	00 00	Response code (0000 Hex: Normal completion)
D+2	00 0A	No. of received bytes (data length after D02003): 10 bytes
D+3	02 B4	Slave node address: 2 VR DATA READ (ONE-WORD FORMAT) response service code: B4 Hex
D+4	00 0F	Data read from the MC Unit's VR(200). One-word format: 15
D+5	00 BF	Data read from the MC Unit's VR(201). One-word format: 191

Word	Contents (Hex)	Meaning
D+6	0A 33	Data read from the MC Unit's VR(202). One-word format: 2611
D+7	FF FF	Data read from the MC Unit's VR(203). One-word format: 65535

Control Words (C: First Control Word)

Word	Contents (Hex)	Meaning
C	00 0C	No. of bytes of command data: 12 bytes of command data, S
C+1	00 10	No. of bytes of response data: 16 bytes of response data, D
C+2	00 01	Destination node network address: 1
C+3	00 FE	Master's node address: 0 Master's Unit address: FE Hex
C+4	00 00	Response returned, communication port No.: 0, No. of retries: 0
C+5	00 64	Response monitoring time: 10 s

Using the CMD(490) instruction to write data

In the following example, the CMD(490) instruction is used to write data (three word format) to Table(10) to Table(12) on the Slave Unit, from the Master (CS1 PCs). For more information on explicit messages, refer to the *DeviceNet Master Unit Operation Manual* or for information on the CMD(490) instruction, refer to the *PCs Operation Manual*.

Example Conditions

Master node address: 0
Slave network address: 1
Slave node address: 2

Example: Using CMND(490)

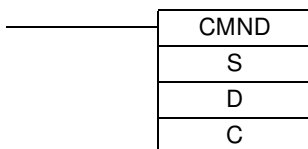

Command Words (S: First Command Word)

Word	Contents (Hex)	Meaning
S	28 01	EXPLICIT MESSAGE SEND command code: 28 01 Hex
S+1	02 35	Slave node address: 2 TABLE DATA WRITE (THREE-WORD FORMAT) command service code: 35 Hex
S+2	00 8A	Class ID: 008A Hex
S+3	00 01	Instance ID: 0001 Hex
S+4	00 0A	Write start address Table(10): 000A Hex
S+5	00 03	Number of Table elements to write: 0003 Hex
S+6	00 00	Data written to the MC Unit's Table(10).
S+7	92 78	Three word format: 279278
S+8	00 27	

Word	Contents (Hex)	Meaning
S+9	00 01	Data written to the MC Unit's Table(11). Three word format: -1428.6
S+10	42 86	
S+11	80 01	
S+12	00 00	Data written to the MC Unit's Table(12). Three word format: 928824
S+13	88 24	
S+14	00 92	

D: Response Words (D: First Response Word)

Results are stored as shown in the following table.

Word	Contents (Hex)	Meaning
D	28 01	EXPLICIT MESSAGE SEND command code: 28 01 Hex
D+1	00 00	Response code (0000 Hex: Normal completion)
D+2	00 02	No. of received bytes (data length after D02003): 2 bytes
D+3	02 B5	Slave node address: 2 TABLE DATA WRITE (THREE-WORD FORMAT) response service code: B5 Hex

Control Words (C: First Control Word)

Word	Contents (Hex)	Meaning
C	00 1E	No. of bytes of command data: 30 bytes of command data, S
C+1	00 08	No. of words of response data: 8 bytes of response data, D
C+2	00 01	Destination node network address: 1
C+3	00 FE	Master's node address: 0 Master's Unit address: FE Hex
C+4	00 00	Response returned, communications port No.: 0, No. of retries: 0
C+5	00 64	Response monitoring time: 10 s

SECTION 5

Multitasking BASIC Programming

This section provides an overview of the fundamentals of multitasking BASIC programs and the methods by which programs are managed in the MC Unit.

5-1	Overview	86
5-2	BASIC Programming	86
5-2-1	Axis, System and Task Statements	86
5-2-2	Data Structures and Variables	87
5-2-3	Mathematical Specifications	88
5-3	Motion Execution	89
5-4	Command Line Interface	90
5-5	BASIC Programs	90
5-5-1	Managing Programs	91
5-5-2	Program Compilation	91
5-5-3	Program Execution	92
5-6	Task Operation Sequence	93
5-7	Error Processing	94

5-1 Overview

The MCW151-E and MCW151-DRT-E Motion Control Units feature a multitasking version of the BASIC programming language. The motion control language is largely based upon a tokenised BASIC and the programs are compiled into the tokenised form prior to their execution.

Multitasking is simple to set up and use and allows very complex machines to be programmed. Multitasking gives the MC Unit a significant advantage over equivalent single task systems. It allows modular applications where the logically connected processes can be grouped together in the same task program, thus simplifying the code architecture and design.

The MC Unit can hold up to 14 programs if memory size permits. A total of 3 tasks can be allocated to the programs. The execution of the programs is user controlled using BASIC.

The BASIC commands, functions and parameters presented here can be found in *SECTION 6 BASIC Motion Control Programming Language*.

5-2 BASIC Programming

The BASIC language consists among others of commands, functions and parameters. These BASIC statements are the building blocks provided to control the MC Unit operation.

Commands

Commands are words recognized by the processor that perform a certain action but do not return a value. For example, PRINT is a recognized word that will cause the value of the following functions or variables to be printed on a certain output device.

Functions

Functions are words recognized by the processor that perform a certain action and return a value related to that action. For example, ABS will take the value of its parameter and return the absolute value of it to be used by some other function or command. For example ABS(-1) will return the value 1, which can be used by the PRINT command, for example, to generate a string to be output to a certain device.

Parameters

Parameters are words recognized by the processor that contain a certain value. This value can be read and, if not read only, written. Parameters are used to determine and monitor the behavior of the system. For example, ACCEL determines the acceleration rate of a movement for a certain axis.

5-2-1 Axis, System and Task Statements

The commands, functions and parameters apply either to (one of) the axes, the tasks running or the general system.

Axis Statements

The motion control commands and the axis parameters apply to one or more axes. Axis parameters determine and monitor how an axis reacts on commands given and how it reacts to the outside world. Every axis has a set of parameters, so that all axes can work independently of each other. The motion control commands are able to control one or more of the axes simultaneously, while every axis has its own behavior. The axis parameters are reset to their default values for each startup.

The commands and parameters work on some base axis or group of axes, specified by the BASE command. The BASE command is used to change this base axis group and every task has its own group which can be changed at any time. The default base axis is 0.

Individual axis dependent commands or parameters can also be programmed to work on a temporary base axis by including the AXIS function as a modifier

in the axis dependent command. A temporary base axis is effective only for the command or parameter after which AXIS appears.

Task Statements

The task parameters apply to a single task. The task parameters monitor the task for example for error handling. The PROC modifier allows the user to access a parameter of a certain task. Without PROC the current task is assumed. The BASE command (see above) is task specific and can be used with the PROC modifier.

System Statements

These statements govern the overall system features, which are basically all statements which do not belong to the first two groups.

5-2-2 Data Structures and Variables

BASIC programs can store numerical data in various types of variables. Some variables have predefined functions, such as the axis parameters and system parameters; other variables are available for the programmer to define as required in programming. The MC Unit's Table, global and local variables are explained in this section. Furthermore also the use of labels will be specified.

Table Variables

The Table is an array structure that contains a series of numbers. These numbers are used for instance to specify positions in the profile for a CAM or CAMBOX command. They can also be used to store data for later use, for example to store the parameters used to define a workpiece to be processed. The Table is common to all tasks on the MC Unit, i.e., the values written to the Table from one task can be read from other tasks.

Table values can be written and read using the TABLE command. The maximum length of the array is 8000 elements, from TABLE(0) to TABLE(7999). The Table array is initialized up to the highest defined element.

Global Variables

The global variables, also called VR variables, are common to all tasks on the MC Unit. This means that if a program running on task 2 sets VR(25) to a certain value, then any other program running on a different task can read that same value from VR(25). This is very useful for synchronizing two or more tasks, but care must be taken to avoid more than one program writing to the same variable at the same time. The controller has 251 global variables, VR(0) to VR(250). The variables are read and written using the VR command.

Precautions for using Table and VR variables

1. The Table and VR data can be accessed from the different running tasks. When using either VR or Table variables, be sure to use only one task to write to one particular variable. This to avoid problems of two program tasks writing unexpectedly to one variable.
2. The Table and VR data in RAM are not backed up and will be lost when the power of the MC Unit is switched OFF. If valid data needs to be recovered during start-up, write the data into Flash memory using the FLASHVR command.

Local Variables

Named variables or local variables can be declared in programs and are local to the task. This means that two or more programs running on different tasks can use the same variable name, but their values can be different. Local variables cannot be read from any task except for the one in which they are declared. Local variables are always cleared when a program is started. The local variables can be cleared by using either the CLEAR or the RESET command.

A maximum of 255 local variables can be declared. Only the first 16 characters of the name are significant. Undefined local variables will return zero. Local variables cannot be declared on the command line.

Labels

The BASIC programs are executed in descending order through the lines. Labels can be used to alter this execution flow using the BASIC commands

Using Variables and Labels

GOTO and GOSUB. To define a label it must appear as the first statement on a line and it must be ended by a colon (:). Labels can be character strings of any length, but only the first 15 characters are significant.

Each task has its own local labels and local variables. For example, consider the two programs shown below:

```

start:
  FOR a = 1 to 100
    MOVE (a)
    WAIT IDLE
  NEXT a
  GOTO start

start:
  a=0
  REPEAT
    a = a + 1
    PRINT a
  UNTIL a = 300
  GOTO start
    
```

These two programs when run simultaneously in different tasks and have their own version of variable “a” and label “start”.

If you need to hold data in common between two or more programs, VR variables should be used, or alternatively, if a large amount of data is to be held, the Table can be used.

To make a program more readable when using a VR variable, a named local variable can be used as a constant in the VR variable. The constant, however, must be declared in each program using the variable. In the example below, VR(3) is used to hold a length parameter.

```

start:
  GOSUB initial
  VR(length) = x

  ...Body of program

initial:
  length = 3
  RETURN

start:
  GOSUB initial
  MOVE (VR(length))
  PRINT VR(length)

  ...Body of program

initial:
  length = 3
  RETURN
    
```

5-2-3 Mathematical Specifications

Number format

The MC Unit has two main formats for numeric values: single precision floating point and single precision integer.

The single precision floating point format is internally a 32 bit value. It has an 8 bit exponent field, a sign bit and 23 bit fraction field with an implicit 1 as the 24th bit. Floating point numbers have a valid range of $\pm 5.9 \cdot 10^{-39}$ to $\pm 3.4 \cdot 10^{38}$.

Integers are essentially floating point numbers with a zero exponent. This implies that the integers are 24 bits wide. The integer range is therefore given from -16777216 to 16777215. Numeric values outside this range will be floating point.

 **WARNING** All mathematical calculations are done in floating point format. This implies that for calculations of/with larger values the results may have limited accuracy. The user should be aware of this when developing the motion control application.

Hexadecimal format

The MC Unit supports assigning and printing hexadecimal values. A hexadecimal number is inputted by proceeding the number by character \$. Valid range is from 0x0 to 0xFFFFFFFF. Example:

```
>> VR(0)=$FF
>> PRINT VR(0)
255.0000
```

A value can be printed in hexadecimal by using the HEX function. Negative values result in the 2's complement hexadecimal value (24-bit). Valid range is from -8388608 to 16777215. Example:

```
>> TABLE(0,-10,65536)
>> PRINT HEX(TABLE(0)),HEX(TABLE(1))
FFFFFF6      10000
```

Positioning

For positioning, the Unit will round up if the fractional encoder edge distance calculated exceeds 0.9. Otherwise the fractional value will be rounded down. The internal measured and demanded position of the axes, represented by the MPOS and DPOS axis parameters, have 32-bit counters. Note that printing the MPOS and DPOS parameters will give the 24-bit integer value (see above description).

Floating point comparison

The comparison functions considers small difference between values as equal to avoid unexpected comparison results. Therefore any two values for which the difference is less than $1.19 \cdot 10^{-6}$ are considered equal.

Precedence

The precedence of the operators is given below:

```
Unary Minus, NOT
^
/ *
MOD
+ -
= <> > >= <= <
AND OR XOR
Left to Right
```

The best way to ensure the precedence of various operators is through the use of parentheses.

5-3 Motion Execution

Every task on the MC Unit has a set of buffers that holds the information from the motion commands given. The motion commands include MOVE, MOVE-ABS, MOVEMODIFY, MOVECIRC, FORWARD, REVERSE, MOVELINK, CONNECT, CAM and CAMBOX. Refer to *6-2-1 Motion Control Commands* for details on specific commands.

Motion Generator

The motion generator, a background process that prepares and runs moves, has a set of two motion buffers for each axis. One buffer holds the Actual Move, which is the move currently executing on the axis. The MTYPE axis parameter contains the identity number of this move. For example the MTYPE will have value 10 if currently the FORWARD move is executed. The other buffer holds the Next Move, which is executed after the Actual Move has finished. The NTYPE axis parameter contains the identity number of this next move.

The BASIC programs are separate from the motion generator program, which controls moves for the axes. The motion generator has separate functions for each axis, so each axis is capable of being programmed with its own axis parameters (for example speed, acceleration) and moving independently and simultaneously or they can be linked together using special commands.

When a move command is processed, the motion generator waits until the move buffers for the required axes are empty and then loads these buffers with the move information.

Note If the task buffers are full, the program execution is paused until buffers are available again. This also applies to the command line task and no commands can be given for that period. Motion Perfect will disconnect in such a case. The PMOVE task parameter will be set to TRUE when the task buffers are full and will be reset to FALSE when the task buffers are available again.

Task buffers

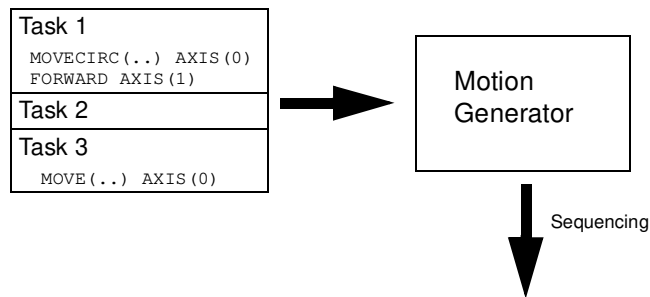

Move buffers

Axis	0	1	2
Next Move (NTYPE)	MOVE (1)	FORWARD (10)	IDLE (0)
Actual Move (MTYPE)	MOVECIRC (4)	MOVECIRC (4)	IDLE (0)

↓ Move Loading

Sequencing

On each servo cycle interrupt (see 5-5-3 Program Execution), the motion generator examines the NTYPE buffers to see if any of them are available. If there are any available then it checks the task buffers to see if there is a move waiting to be loaded. If a move can be loaded, then the data for all the specified axes is loaded from the task buffers into the NTYPE buffers and the corresponding task buffers are marked as idle. This process is called sequencing.

Move Loading

Once sequencing has been completed, the MTYPE buffers are checked to see if any moves can be loaded. If the required MTYPE buffers are available, then the move is loaded from the NTYPE buffers to the MTYPE buffers and the NTYPE buffers are marked as idle. This process is called move loading. If there is a valid move in the MTYPE buffers, then it is processed. When the move has been completed, the MTYPE buffers are marked as idle.

5-4 Command Line Interface

The Command Line Interface provides a direct interface for the user to execute commands and access parameters on the system. There are two options to use the command line interface:

- Use the Terminal Window within Motion Perfect and the MC Unit connected. See SECTION 7 Motion Perfect Software Package for details.
- Use a VT100 Terminal to connect to the MC Unit. This is similar to using the Terminal Window within Motion Perfect when the MC Unit is disconnected.

The MC Unit puts the last 10 commands given on the command line in a buffer. Pressing the Up and Down Cursor Key will cycle through the buffer to execute the command again.

5-5 BASIC Programs

The MC Unit can store up to 14 programs in memory, provided the capacity of memory is not exceeded. The MC Unit supports simple file-handling instructions for managing these program files rather like the DOS filing system on a computer.

The Motion Perfect software package is used to store and load programs to and from a computer for archiving, printing and editing. It also has several controller monitor and debugging facilities. Refer to *SECTION 7 Motion Perfect Software Package* for details on Motion Perfect.

5-5-1 Managing Programs

Motion Perfect automatically creates a project which contains the programs to be used for an application. The programs of the project are kept both in the controller as on the computer. Whenever a program is created or edited, Motion Perfect edits both copies in order to always have an accurate backup outside the controller at any time. Motion Perfect checks that the two versions of the project are identical using a cyclic redundancy check. If the two differ, Motion Perfect allows copying the MC Unit version to disk or vice versa.

Programs on the computer are stored in ASCII text files. They may therefore be printed, edited and copied using a simple text editor. The source programs are held in the MC Unit in a tokenised form and as a result, the sizes of the programs will be less on the MC Unit compared to the same programs on the computer.

Storing Programs

Programs on the MC Unit must be held in Flash memory when power is turned OFF. Similar to the Table and VR variable data, the data will be lost when the Unit is powered OFF. When a session will be ended, the current programs in RAM must be copied to Flash memory by using the EPROM command. The Motion Perfect package provides a button on the control panel to perform the operation. It will also prompt the user when the program is closed.

At each start-up before operation the program data in Flash memory will be copied to RAM.

Program Commands

The MC Unit has a number of BASIC commands to allow creation, manipulation and deletion of programs. Motion Perfect provides buttons which also perform these operations.

Command	Function
SELECT	Selects a program for editing, deleting etc.
NEW	Deletes the current selected program, a specified program or all programs.
DIR	Lists the directory of all programs.
COPY	Duplicates a specified program.
RENAME	Renames a specified program.
DEL	Deletes the current selected program or a specified program.
LIST	Lists the current selected program or a specified program.

5-5-2 Program Compilation

The MC Unit system compiles programs automatically when required. It is not normally required to force the MC Unit to compile programs, but programs can be compiled under the Program Menu in Motion Perfect.

The MC Unit automatically compiles programs at the following times.

- The selected program is compiled before it is executed if it has been edited.
- The selected program is compiled if it has been edited before switching the selected program to another program.
- The selected program is compiled by using the COMPILER command.

The program syntax and structure are checked during compilation. If compilation is unsuccessful, a message will be provided and no program code will be generated. A red cross will appear in the Motion Perfect directory box. Programs cannot be run when compilation errors occur. The errors should be corrected and the program recompiled.

The compilation process also includes the following:

- Removing comments.
- Compiling numbers into the internal processor format.
- Converting expressions into reverse Polish Notation format for execution.
- Precalculating variable locations.
- Calculating and embedding loop structure destinations.

⚠ WARNING As the compiling process requires some free memory, un-expected compiling errors may be occurring when the amount of free memory is not sufficient.

5-5-3 Program Execution

The timing of the execution for the different tasks and the refreshing of the I/O of the MC Unit revolves around the servo cycle period of the system. The servo cycle period is determined by the SERVO_PERIOD system parameter. The MC Unit will either have a servo cycle period of 0.5 or 1.0 ms.

I/O Refresh

The I/O status of the MC Unit is refreshed at the beginning of every servo cycle.

- The captured status of the digital inputs is transferred to the IN system input variable. Note that this is the status captured in the previous servo cycle.
- The analogue outputs for the speed references are updated.
- The digital outputs are updated conform the status of the OP system output variable.
- The status of the digital inputs is captured.

Note that no automatic processing of the I/O signals is taking place, except for registration. This implies that all actions must be programmed in the BASIC programs.

Relevant commands

Motion Perfect provides several ways of executing, pausing and stopping the programs using buttons on the control panel and the editing windows. The following commands can be given on the command line to control the execution.

Command	Function
RUN	Run the current selected program or a specified program, optionally on a specified task number.
STOP	Stop the current selected program or a specified program.
HALT	Stop all programs on the system
PROCESS	Displays all running tasks.

The user can explicitly allocate the task priority on which the BASIC program is expected to run. When a user program is run without explicit task allocation, it is assigned the highest available task priority. Tasks 3 has high priority and task 2 and 1 have low priority.

Setting Programs to Run at Start-up

Programs can be set to run automatically at different priorities when power is turned ON. If required, the computer can be left connected as an operator interface or may be removed and the programs run “stand-alone”.

Programs are set in Motion Perfect to run automatically at start-up using the Set Power Up Mode... selection under the Program Menu. This operation

sets which program to run automatically and at which priority. This can also be accomplished by the RUNTYPE BASIC command. The current status can be seen using the DIR command.

5-6 Task Operation Sequence

The allocation of the system tasks and the program tasks with the different priorities over the available processing time is explained in the following section. The MC Unit generates a fixed interrupt every 250 μ s, which result in 4 routines to be executed each millisecond. Each interrupt will start the next routine.

Depending on the setting of the Servo Period (using the SERVO_PERIOD parameter), the motion sequence is executed every 500 μ s or every 1000 μ s.

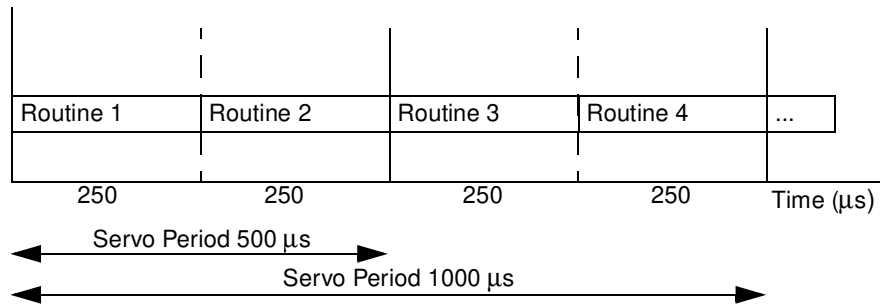

The tasks (simplified) of each individual routine is shown in the next table.

Routine 1	Routine 2
<ul style="list-style-type: none"> • Motion Sequence • Program task execution (low priority) 	<ul style="list-style-type: none"> • Low level serial communication • Program task execution (high priority)
Routine 3	Routine 4
<ul style="list-style-type: none"> • Motion Sequence (if period is 500 μs) • LEDs update • Program task execution (high priority) 	<ul style="list-style-type: none"> • Communications (DeviceNet, Host Link)

Motion Sequence

The motion sequence which will be executed at the beginning of each Servo Period will contain the following elements:

1. Transfer any moves from BASIC process buffers to motion buffers (see 5-3 Motion Execution).
2. Read digital inputs.
3. Load moves. (See note).
4. Calculate speed profile. (See note).
5. Calculate axis positions. (See note).
6. Execute position servo. For axis 0 this also includes the Servo Driver communications. (See note).
7. Update outputs.

Note Each of these items will be performed for each axis in turn before moving on to the next item.

Program task execution

There are three slots available for the BASIC tasks execution. The slots will be allocated to the different tasks based on the task priorities. Tasks 3 and 2 have high priority and task 1 and 0 (command line) have low priority.

For each period (1 ms) the high priority tasks are always allocated the two time slots for high priority (routine 2 and 3). Use this task for programs which

have higher execution requirements for demanding calculations or processing and which task may not vary in execution speed.

The lower priority task 1 and 0 (command line) will be allocated to the single time slot of routine 1. These tasks get less execution time and also the execution is depending on how many other low priority task are running.

If all running tasks have the same priority, the tasks will be allocated to all available slots.

The following examples show the different allocations of the tasks.

Example 1: Tasks 1 & 3 and command line task 0 running

1 ms				1 ms			
Task 0	Task 3	Task 3		Task 1	Task 3	Task 3	

The task 3 is allocated two time slots each millisecond. The other time slot is equally allocated to the other tasks over multiple cycles.

Example 2: Tasks 1,2 & 3 and command line task 0 running

1 ms				1 ms			
Task 0	Task 3	Task 2		Task 1	Task 3	Task 2	

Both high priority tasks (3 and 2) are allocated to the two time slots. The other time slot is equally allocated to the other tasks over multiple cycles.

5-7 Error Processing

For the safety of the application it is very important that proper safety measures are taken for the different problems which may occur in the system. For safe operation at all times the user must make use of the several options to check for these errors in both the MC Unit and Servo Driver.

As for the MC Unit, the BASIC programming language provide the programmer with the freedom to include a lot of safety measures or not. This requires a sensible solution, which covers all possible behaviour of the system.

This section will present the possible errors that may occur and suggest the way to detect them. For a full description of the error handling refer to section 8-2 *Error Handling*.

 **Caution** The MC Unit outputs may have undefined status due to deposits on or burning of the output relays, or destruction of the output transistors. As a countermeasure for such problems, external safety measures must be provided to ensure safety in the system.

BASIC Errors

If a BASIC error is generated during the execution of a BASIC command in some task, the program will be halted immediately or the user can define a specific error routine structure to stop the system. The error routine can stop the driver, put the digital I/O in a safe status and notify the PC Unit of the error. Please refer to section 6-3-31 *BASICERROR* on the way to include an error subroutine in a BASIC program.

Motion Error

In case a motion error occurs, the MC Unit will disable the control of the driver automatically. The user has the ability to decide for each axis which motion errors will disable the driver by using the *ERRORMASK* parameter (see section 6-3-67 *ERRORMASK*). After detection of the motion error the user is free to program the necessary countermeasures for the other axes and the complete system.

Host Link Master

The Host Link Master protocol uses the *HLM_STATUS* parameter to define the different error states. The *HLM_STATUS* parameter will contain error states like Timeout and invalid Host Link strings received from the master. The required actions such as a re-try for the error states are required to be

programmed in BASIC. See *4-1-2 Host Link Slave* for details on Host Link error handling.

Host Link Slave

The Host Link Slave protocol will respond with the proper end code to the Master when some error has been detected. No programmed error routine in BASIC is necessary, all error handling is done by the Host Link Master.

DeviceNet

Although most error handling will be at the DeviceNet master, the MC Unit as DeviceNet slave has a status parameter. The FB_STATUS will return the status of the Remote I/O Communication with the Master.

Please refer to *Appendix C Programming Examples* to find an implementation of the master shell program. The master shell program is used for the configuration of the MC Unit and Servo Driver, for the control of the application program tasks and for the continuous checking any error event that may occur. It is strongly recommended to use this program or a similar program for every application.

SECTION 6

BASIC Motion Control Programming Language

This section describes all commands, functions and parameters required for programing the motion control application using the MC Unit.

6-1	Overview	102
6-2	Command Reference List	103
6-2-1	Motion Control Commands	103
6-2-2	I/O Commands and Functions	103
6-2-3	Loop and Conditional Structures	104
6-2-4	Program Commands and Functions	104
6-2-5	System Commands and Parameters	105
6-2-6	Mathematical and Logical Functions	106
6-2-7	Constants.	107
6-2-8	Motion Perfect Commands, Functions and Parameters	107
6-2-9	Axis Parameters	107
6-2-10	Task Commands and Parameters	109
6-2-11	Servo Driver Commands and Parameters	110
6-2-12	Host Link Commands and Parameters	110
6-2-13	DeviceNet Commands and Parameters	110
6-3	Command, function and parameter description	111
6-3-1	Multiply: *	111
6-3-2	Power: ^	111
6-3-3	Add: +	111
6-3-4	Subtract: -	112
6-3-5	Divide: /	112
6-3-6	Is Less Than: <	112
6-3-7	Is Less Than Or Equal To: <=	112
6-3-8	Is Not Equal To: <>	113
6-3-9	Is Equal To: =	113
6-3-10	Is Greater Than: >	113
6-3-11	Is Greater Than or Equal To: >=	113
6-3-12	Hexadecimal input: \$	114
6-3-13	Statement separator: ":"	114
6-3-14	Comment field: '	114
6-3-15	ABS	114
6-3-16	ACCEL	115
6-3-17	ACOS	115
6-3-18	ADD_DAC	115
6-3-19	ADDAX_AXIS	116
6-3-20	ADDAX	117
6-3-21	AIN	117
6-3-22	AND	118
6-3-23	ASIN	119
6-3-24	ATAN	119
6-3-25	ATAN2	119
6-3-26	ATYPE	119
6-3-27	AUTORUN	120
6-3-28	AXIS	120
6-3-29	AXISSTATUS	121
6-3-30	BASE	121

6-3-31	BASICERROR	122
6-3-32	CAM	123
6-3-33	CAMBOX	124
6-3-34	CANCEL	125
6-3-35	CHECKSUM	126
6-3-36	CLEAR	126
6-3-37	CLEAR_BIT	126
6-3-38	CLOSE_WIN	126
6-3-39	CLUTCH_RATE	126
6-3-40	COMMSERROR	127
6-3-41	COMPILE	127
6-3-42	CONNECT	127
6-3-43	CONTROL	128
6-3-44	COPY	128
6-3-45	COS	128
6-3-46	CREEP	129
6-3-47	D_GAIN	129
6-3-48	DATUM	129
6-3-49	DATUM_IN	130
6-3-50	DECEL	131
6-3-51	DEFPOS	131
6-3-52	DEL	131
6-3-53	DEMAND_EDGES	132
6-3-54	DIR	132
6-3-55	DPOS	132
6-3-56	DRV_CLEAR	133
6-3-57	DRV_READ	133
6-3-58	DRV_RESET	134
6-3-59	DRV_STATUS	134
6-3-60	DRV_WRITE	135
6-3-61	EDIT	135
6-3-62	ENCODER	136
6-3-63	ENDMOVE	136
6-3-64	EPROM	136
6-3-65	ERROR_AXIS	136
6-3-66	ERROR_LINE	136
6-3-67	ERRORMASK	137
6-3-68	EXP	137
6-3-69	FALSE	137
6-3-70	FAST_JOG	137
6-3-71	FB_SET	138
6-3-72	FB_STATUS	138
6-3-73	FE	138
6-3-74	FE_LIMIT	138
6-3-75	FE_RANGE	139
6-3-76	FHOLD_IN	139
6-3-77	FHSPEED	139
6-3-78	FLASHVR	139
6-3-79	FOR TO STEP NEXT	140
6-3-80	FORWARD	141
6-3-81	FRAC	141
6-3-82	FREE	141
6-3-83	FS_LIMIT	142

6-3-84	FWD_IN	142
6-3-85	FWD_JOG	142
6-3-86	GET	142
6-3-87	GOSUB RETURN	143
6-3-88	GOTO	143
6-3-89	HALT	144
6-3-90	HLM_COMMAND	144
6-3-91	HLM_READ	146
6-3-92	HLM_STATUS	147
6-3-93	HLM_TIMEOUT	147
6-3-94	HLM_WRITE	148
6-3-95	HLS_MODEL	149
6-3-96	HLS_NODE	149
6-3-97	I_GAIN	150
6-3-98	IF THEN ELSE ENDIF	150
6-3-99	IN	151
6-3-100	INDEVICE	151
6-3-101	INPUT	152
6-3-102	INT	152
6-3-103	JOGSPEED	153
6-3-104	KEY	153
6-3-105	LAST_AXIS	153
6-3-106	LINK_AXIS	154
6-3-107	LINPUT	154
6-3-108	LIST	154
6-3-109	LN	155
6-3-110	LOCK	155
6-3-111	MARK	155
6-3-112	MARKB	156
6-3-113	MERGE	156
6-3-114	MOD	156
6-3-115	MOTION_ERROR	156
6-3-116	MOVE	157
6-3-117	MOVEABS	158
6-3-118	MOVECIRC	159
6-3-119	MOVELINK	160
6-3-120	MOVEMODIFY	163
6-3-121	MPOS	163
6-3-122	MSPEED	163
6-3-123	MTYPE	163
6-3-124	NEW	164
6-3-125	NIO	164
6-3-126	NOT	164
6-3-127	NTYPE	165
6-3-128	OFF	165
6-3-129	OFFPOS	165
6-3-130	ON	165
6-3-131	ON	166
6-3-132	OP	166
6-3-133	OPEN_WIN	167
6-3-134	OR	167
6-3-135	OUTDEVICE	168

6-3-136	OUTLIMIT	168
6-3-137	OV_GAIN	168
6-3-138	P_GAIN	169
6-3-139	PI	169
6-3-140	PMOVE	169
6-3-141	PP_STEP	169
6-3-142	PRINT	170
6-3-143	PROC	171
6-3-144	PROC_LINE	171
6-3-145	PROC_STATUS	172
6-3-146	PROCESS	172
6-3-147	PROCNUMBER	172
6-3-148	PSWITCH	172
6-3-149	RAPIDSTOP	173
6-3-150	READ_BIT	174
6-3-151	REG_POS	174
6-3-152	REG_POSB	174
6-3-153	REGIST	174
6-3-154	REMAIN	177
6-3-155	RENAME	177
6-3-156	REP_DIST	177
6-3-157	REP_OPTION	178
6-3-158	REPEAT UNTIL	178
6-3-159	RESET	179
6-3-160	REV_IN	179
6-3-161	REV_JOG	179
6-3-162	REVERSE	179
6-3-163	RS_LIMIT	180
6-3-164	RUN	180
6-3-165	RUN_ERROR	180
6-3-166	RUNTYPE	181
6-3-167	S_RATE	181
6-3-168	S_REF	182
6-3-169	S_REF_OUT	182
6-3-170	SCOPE	182
6-3-171	SCOPE_POS	183
6-3-172	SELECT	184
6-3-173	SERVO	184
6-3-174	SERVO_PERIOD	184
6-3-175	SET_BIT	185
6-3-176	SETCOM	185
6-3-177	SGN	185
6-3-178	SIN	186
6-3-179	SPEED	186
6-3-180	SQR	186
6-3-181	SRAMP	186
6-3-182	STEPLINE	186
6-3-183	STOP	187
6-3-184	SWITCH_STATUS	187
6-3-185	T_RATE	188
6-3-186	T_REF	188
6-3-187	TABLE	188
6-3-188	TAN	189

6-3-189 TICKS.....	189
6-3-190 TRIGGER.....	190
6-3-191 TROFF	190
6-3-192 TRON	190
6-3-193 TRUE	191
6-3-194 TSIZE.....	191
6-3-195 UNITS.....	191
6-3-196 VERSION.....	191
6-3-197 VFF_GAIN	192
6-3-198 VP_SPEED.....	192
6-3-199 VR.....	192
6-3-200 WA	193
6-3-201 WAIT IDLE	193
6-3-202 WAIT LOADED.....	194
6-3-203 WAIT UNTIL.....	194
6-3-204 WDOG	195
6-3-205 WHILE WEND	195
6-3-206 XOR	195

6-1 Overview

This section contains the description of the commands, functions and parameters of the MC Unit. All items can be found in alphabetical order. For quick command reference, check the following section.

Group Structure

The complete set of commands, functions and parameters is divided in the following groups.

1. Motion Control Commands
2. I/O Commands and Functions
3. Loop and Conditional Structures
4. Program Commands and Parameters
5. System Commands and Parameters
6. Mathematical Functions
7. Constants
8. Motion Perfect Commands and Parameters
9. Axis Parameters
10. Task Functions and Parameters
11. Servo Driver Commands and Parameters
12. Host Link Commands and Parameters
13. DeviceNet Commands and Parameters

Notation Used in this Section

Each of the descriptions of the commands, functions and parameters will contain some of the following attributes. Individual attributes are omitted when not applicable.

Type:

The classification is given for command, function or parameter.

Syntax:

Standard BASIC notation is used to show command or function syntax. Syntax definition:

- Syntax code is given in *typewriter font*. Text must be typed exactly as given.
- Argument names are given in *italic font with underscores_for_spaces*. Replace these with the actual arguments.
- Optional items are denoted with square brackets “[]” in the syntax notation. The items are optional and can be omitted.
- Repetition items are denoted with “{ }” brackets in the syntax notation. Items enclosed in these brackets are repeated zero or more times.

Alternative:

Any alternative form of a command, function or parameter is given.

Description:

This field describes the purpose and application of the command, function or parameter.

Precautions:

Specific precautions related to programming are provided.

Arguments:

The name of each argument is given in ***bold italic*** font followed by the description of the argument.

See also:

In this field the related commands, functions and parameters are given.

Example:

One or more application examples are given for most commands, functions, and parameters.

6-2 Command Reference List

6-2-1 Motion Control Commands

The table below outlines the motion control commands. Refer to the specified pages for details.

Name	Description	Page
ADD_DAC	ADD_DAC allows a secondary encoder to be used on a servo axis to achieve dual feed-back control.	115
ADDAX	ADDAX sets a link to a superimposed axis. All demand position movements for the superimposed axis will be added to any moves that are currently being executed.	117
BASE	BASE is used to set the base axis to the axis specified with axis.	121
CAM	CAM moves an axis according to values of a movement profile stored in the Table variable array.	123
CAMBOX	CAMBOX moves an axis according to values of a movement profile stored in the Table variable array. The motion is linked to the measured motion of another axis to form a continuously variable software gearbox.	124
CANCEL	CANCEL cancels the move on an axis.	125
CONNECT	CONNECT connects the demand position of an axis to the measured movements of the axis specified for <i>driving_axis</i> to produce an electronic gearbox.	127
DATUM	DATUM performs one of 7 origin search sequences to position an axis to an absolute position or reset a motion error.	129
DEFPOS	DEFPOS defines the current position as a new absolute position.	131
FORWARD	FORWARD moves an axis continuously forward at the speed set in the SPEED parameter.	141
MOVE	MOVE moves one or more axes at the demand speed, acceleration and deceleration to the position specified as increment from the current position.	157
MOVEABS	MOVEABS moves one or more axes at the demand speed, acceleration and deceleration to the position specified as absolute position, i.e., in reference to the origin.	158
MOVECIRC	MOVECIRC interpolates 2 orthogonal axes in a circular arc.	159
MOVELINK	MOVELINK creates a linear move on the base axis linked via a software gearbox to the measured position of a link axis.	160
MOVEMODIFY	MOVEMODIFY changes the absolute end position of the current single-axis linear move (MOVE or MOVEABS).	163
RAPIDSTOP	RAPIDSTOP cancels the current move on all axes.	173
REVERSE	REVERSE moves an axis continuously in reverse at the speed set in the SPEED parameter.	179

6-2-2 I/O Commands and Functions

The table below outlines the I/O commands and functions. Refer to the specified pages for details.

Name	Description	Page
AIN	AIN provides four analog channels which contain the Servo Driver monitor data signals.	117
GET	GET waits for the arrival of a single character and assigns the ASCII code of the character to <i>variable</i> .	142
IN	IN returns the value of digital inputs.	151
INDEVICE	INDEVICE parameter defines the default input device.	151

Name	Description	Page
INPUT	INPUT waits for a string to be received and assigns the numerical value to <i>variable</i> .	152
KEY	KEY returns TRUE or FALSE depending on if character is received.	153
LINPUT	LINPUT waits for a string and puts it in VR variables.	154
OP	OP sets one or more outputs or returns the state of the first 24 outputs.	166
OUTDEVICE	OUTDEVICE defines the default output device.	168
PRINT	PRINT outputs a series of characters to a serial port.	170
PSWITCH	PSWITCH turns ON an output when a predefined position is reached, and turns OFF the output when a second position is reached.	172
REGIST	REGIST captures an axis position when a registration input or the Z mark on the encoder is detected.	174
SETCOM	SETCOM sets the serial communications.	185

6-2-3 Loop and Conditional Structures

The table below outlines the loop and conditional structure commands. Refer to the specified pages for details.

Name	Description	Page
FOR TO STEP NEXT	FOR ... NEXT loop allows a program segment to be repeated with increasing/decreasing <i>variable</i> .	140
GOSUB RETURN	GOSUB jumps to a subroutine at the line just after <i>label</i> . The program execution returns to the next instruction after a RETURN is given.	143
GOTO	GOTO jumps to the line containing the <i>label</i> .	143
IF THEN ELSE ENDIF	IF controls the flow of the program base on the results of the <i>condition</i> .	150
ON GOSUB or GOTO	ON GOSUB or ON GOTO enables a conditional jump to one of several labels.	166
REPEAT UNTIL	REPEAT ... UNTIL loop allows the program segment to be repeated until the <i>condition</i> becomes TRUE.	178
WHILE WEND	WHILE ... WEND loop allows the program segment to be repeated until the <i>condition</i> becomes FALSE.	195

6-2-4 Program Commands and Functions

The table below outlines commands used for general programming purposes. Refer to the specified pages for details.

Name	Description	Page
Statement separator: “.”	The statement separator enables more statements on one line.	114
Comment field: “ ‘ ”	The single quote enables a line not to be executed.	114
AUTORUN	AUTORUN starts all the programs that have been set to run at start-up.	120
COMPILE	COMPILE compiles the current program.	127
COPY	COPY copies an existing program in memory to a new program.	128
DEL	DEL deletes a program from memory.	131
DIR	DIR displays a list of the programs held in memory, their size and their RUNTYPE.	132
EDIT	EDIT allows a program to be modified using a VT100 Terminal.	135

Name	Description	Page
EPROM	EPROM stores the BASIC programs in the MC Unit in the Flash memory.	136
FREE	FREE returns the amount of available memory.	141
HALT	HALT stops execution of all programs currently running.	144
LIST	LIST prints the lines of a program.	154
NEW	NEW deletes all the program lines in MC Unit memory.	164
PROCESS	PROCESS returns the running status and task number for each current task.	172
RENAME	RENAME changes the name of a program in the MC Unit directory.	177
RUN	RUN executes a program.	180
RUNTYPE	RUNTYPE determines if a program is run at start-up, and which task it is to run on.	181
SELECT	SELECT specifies the current program.	184
STEPLINE	STEPLINE executes a single line in a program.	186
STOP	STOP halts program execution.	187
TROFF	TROFF suspends a trace at the current line and resumes normal program execution.	190
TRON	TRON creates a breakpoint in a program.	190

6-2-5 System Commands and Parameters

The table below outlines the system commands and parameters. Refer to the specified pages for details.

Name	Description	Page
Hexadecimal input: "\$"	Command \$ assigns a hexadecimal number to a variable.	114
AXIS	AXIS sets the axis for a command, axis parameter read, or assignment to a particular axis.	120
BASICERROR	BASICERROR is used to run a specific routine when an error occurs in a BASIC command.	122
CHECKSUM	CHECKSUM contains the checksum for the programs in RAM.	126
CLEAR	CLEAR clears all global variables and the local variables on the current task.	126
CLEAR_BIT	CLEAR_BIT clears the specified bit of the specified VR variable.	126
COMMSERROR	COMMSERROR contains all the communications errors that have occurred since the last time that it was initialised.	127
CONTROL	CONTROL contains the type of MC Unit in the system.	128
ERROR_AXIS	ERROR_AXIS contains the number of the axis which caused the motion error.	136
FLASHVR	FLASHVR is used to store VR or Table variable data into the Flash memory.	139
LAST_AXIS	LAST_AXIS contains the number of the last axis processed by the system.	153
LOCK	LOCK prevents the programs from being viewed or modified.	155
MOTION_ERROR	MOTION_ERROR contains an error flag for axis motion errors.	156
NIO	NIO contains the number of inputs and outputs connected to the system.	164
READ_BIT	READ_BIT returns the value of the specified bit in the specified VR variable.	174
RESET	RESET resets all local variables on a task.	179

Name	Description	Page
SERVO_PERIOD	SERVO_PERIOD sets the servo cycle period of the MC Unit.	184
SET_BIT	SET_BIT command sets the specified bit in the specified VR variable to one.	185
SWITCH_STATUS	SWITCH_STATUS contains the status of the 10 external DIP-switches on the MC Unit.	187
TABLE	TABLE writes and reads data to and from the Table variable array.	188
TSIZE	TSIZE returns the size of the currently defined Table.	191
VERSION	VERSION returns the version number of the BASIC language installed in the MC Unit.	191
VR	VR writes and reads data to and from the global (VR) variables.	192
WA	WA holds program execution for the number of milliseconds specified.	193
WAIT IDLE	WAIT IDLE suspends program execution until the base axis has finished executing its current move and any buffered move.	193
WAIT LOADED	WAIT LOADED suspends program execution until the base axis has no moves buffered ahead other than the currently executing move.	194
WAIT UNTIL	WAIT UNTIL repeatedly evaluates the <i>condition</i> until TRUE.	194
WDOG	WDOG contains the software switch which enables the Servo Driver.	195

6-2-6 Mathematical and Logical Functions

The table below outlines the mathematical and logical functions. Refer to the specified pages for details.

Name	Description	Page
Multiply: *	* multiplies any two valid expressions.	111
Power: ^	^ takes the power of any two valid expressions	111
Add: +	+ adds any two valid expressions.	111
Subtract: -	- subtracts any two valid expressions.	112
Divide: /	/ divides any two valid expressions.	112
Is Less Than: <	< returns TRUE if <i>expression_1</i> is less than <i>expression_2</i> , otherwise FALSE.	112
Is Less Than Or Equal To: <=	<= returns TRUE if <i>expression_1</i> is less than or equal to <i>expression_2</i> , otherwise FALSE.	112
Is Not Equal To: <>	<> returns TRUE if <i>expression_1</i> is not equal to <i>expression_2</i> , otherwise FALSE.	113
Is Equal To: =	= returns TRUE if <i>expression_1</i> is equal to <i>expression_2</i> , otherwise FALSE.	113
Is Greater Than: >	> returns TRUE if <i>expression_1</i> is greater than <i>expression_2</i> , otherwise FALSE.	113
Is Greater Than or Equal To: >=	>= returns TRUE if <i>expression_1</i> is greater than or equal to <i>expression_2</i> , otherwise FALSE.	113
ABS	ABS returns the absolute value of <i>expression</i> .	114
ACOS	ACOS returns the arc-cosine of <i>expression</i> .	115
AND	AND performs an AND operation on corresponding bits of the integer parts of two valid BASIC expressions.	118
ASIN	ASIN returns the arc-sine of <i>expression</i> .	119
ATAN	ATAN returns the arc-tangent of <i>expression</i> .	119
ATAN2	ATAN2 returns the arc-tangent of the nonzero complex number (<i>expression_2</i> , <i>expression_1</i>).	119

Name	Description	Page
COS	COS returns the cosine of <i>expression</i> .	128
EXP	EXP returns the exponential value of <i>expression</i> .	137
FRAC	FRAC returns the fractional part of <i>expression</i> .	141
INT	INT returns the integer part of <i>expression</i> .	152
LN	LN returns the natural logarithm of <i>expression</i> .	155
MOD	MOD returns the <i>expression_2</i> modulus of an <i>expression_1</i> .	156
NOT	NOT performs an NOT operation on corresponding bits of the integer part of the expression.	164
OR	OR performs an OR operation between corresponding bits of the integer parts of two valid BASIC expressions.	167
SGN	SGN returns the sign of <i>expression</i> .	185
SIN	SIN returns the sine of <i>expression</i> .	186
SQR	SQR returns the square root of <i>expression</i> .	186
TAN	TAN returns the tangent of <i>expression</i> .	189
XOR	XOR performs an XOR function between corresponding bits of the integer parts of two valid BASIC expressions.	195

6-2-7 Constants

The table below outlines the constants. Refer to the specified pages for details.

Name	Description	Page
FALSE	FALSE returns the numerical value 0.	137
OFF	OFF returns the numerical value 0.	165
ON	ON returns the numerical value 1.	165
PI	PI returns the numerical value 3.1416.	169
TRUE	TRUE returns the numerical value -1.	191

6-2-8 Motion Perfect Commands, Functions and Parameters

The table below outlines the Motion Perfect commands, functions, and parameters. Refer to the specified pages for details.

Name	Description	Page
SCOPE	SCOPE programs the system to automatically store up to 4 parameters every sample period to the Table variable array.	182
SCOPE_POS	SCOPE_POS contains the current Table position at which the SCOPE command is currently storing its first parameter.	183
TRIGGER	TRIGGER starts a previously set SCOPE command.	190

6-2-9 Axis Parameters

The table below outlines the axis parameters. Refer to the specified pages for details.

Name	Description	Page
ACCEL	ACCEL contains the axis acceleration rate.	115
ADDAX_AXIS	ADDAX_AXIS returns the number of the axis to which the base axis is currently linked to by ADDAX.	116
ATYPE	ATYPE contains the axis type.	119
AXISSTATUS	AXISSTATUS contains the axis status.	121
CLOSE_WIN	CLOSE_WIN defines the end of the window in which a registration mark is expected.	126

Name	Description	Page
CLUTCH_RATE	CLUTCH_RATE defines the change in connection ratio when using the CONNECT command.	126
CREEP	CREEP contains the creep speed.	129
D_GAIN	D_GAIN contains the derivative control gain.	129
DATUM_IN	DATUM_IN contains the input number to be used as the origin input.	130
DECEL	DECEL contains the axis deceleration rate.	131
DEMAND_EDGES	DEMAND_EDGES contains the current value of the DPOS axis parameter in encoder edges.	132
DPOS	DPOS contains the demand position generated by the move commands.	132
ENCODER	ENCODER contains a raw copy of the encoder hardware register.	136
ENDMOVE	ENDMOVE holds the position of the end of the current move.	136
ERRORMASK	ERRORMASK contains the mask value which determines if a Motion Error occurs depending on the axis status.	137
FAST_JOG	FAST_JOG contains the input number to be used as the fast jog input.	137
FE	FE contains the following error.	138
FE_LIMIT	FE_LIMIT contains the maximum allowable following error.	138
FE_RANGE	FE_RANGE contains the following error warning range limit.	139
FHOLD_IN	FHOLD_IN contains the input number to be used as the feedhold input.	137
FHSPEED	FHSPEED contains the feedhold speed.	139
FS_LIMIT	FS_LIMIT contains the absolute position of the forward software limit.	142
FWD_IN	FWD_IN contains the input number to be used as a forward limit input.	142
FWD_JOG	FWD_JOG contains the input number to be used as a jog forward input.	142
I_GAIN	I_GAIN contains the integral control gain.	150
JOGSPEED	JOGSPEED sets the jog speed.	153
LINK_AXIS	LINK_AXIS contains the axis number of the link axis during any linked move.	154
MARK	MARK contains TRUE when a registration event has occurred.	155
MERGE	MERGE is a software switch that can be used to enable or disable the merging of consecutive moves.	156
MPOS	MPOS is the position of the axis as measured by the encoder.	163
MSPEED	MSPEED represents the change in the measured position in the last servo period.	163
MTYPE	MTYPE contains the type of move currently being executed.	163
NTYPE	NTYPE contains the type of the move in the Next Move buffer.	165
OFFPOS	OFFPOS contains an offset that will be applied to the demand position without affecting the move in any other way.	165
OPEN_WIN	OPEN_WIN defines the beginning of the window in which a registration mark is expected.	167
OUTLIMIT	OUTLIMIT contains the limit that restricts the speed reference output from the MC Unit.	168
OV_GAIN	OV_GAIN contains the output velocity control gain.	168
P_GAIN	P_GAIN contains the proportional control gain.	169
PP_STEP	PP_STEP contains an integer value that scales the incoming raw encoder count.	169

Name	Description	Page
REG_POS	REG_POS contains the position at which a registration event occurred.	174
REMAIN	REMAIN is the distance remaining to the end of the current move.	177
REP_DIST	REP_DIST contains sets the repeat distance.	177
REP_OPTION	REP_OPTION controls the application of the REP_DIST axis parameter.	178
REV_IN	REV_IN contains the input number to be used as a reverse limit input.	179
REV_JOG	REV_JOG contains the input number to be used as a jog reverse input.	179
RS_LIMIT	RS_LIMIT contains the absolute position of the reverse software limit.	180
S_RATE	S_RATE contains the speed reference rate for the attached Servomotor.	181
S_REF	S_REF contains the speed reference value which is applied when the axis is in open loop.	182
S_REF_OUT	S_REF_OUT contains the speed reference value being applied to the Servo Driver for both open as closed loop.	182
SERVO	SERVO determines whether the axis runs under servo control or open loop.	184
SPEED	SPEED contains the demand speed in units/s.	186
SRAMP	SRAMP contains the S-curve factor.	186
T_RATE	T_RATE contains the torque reference rate for the attached Servomotor.	188
T_REF	T_REF contains the torque reference value which is applied to the Servomotor.	188
UNITS	UNITS contains the unit conversion factor.	191
VFF_GAIN	VFF_GAIN contains the speed feed forward control gain.	192
VP_SPEED	VP_SPEED contains the speed profile speed.	192

6-2-10 Task Commands and Parameters

The table below outlines the task commands and parameters. Refer to the specified pages for details.

Name	Description	Page
ERROR_LINE	ERROR_LINE contains the number of the line which caused the last BASIC program error.	136
PMOVE	PMOVE contains the status of the task buffers.	169
PROC	PROC allows a process parameter from a particular process to be accessed.	171
PROC_LINE	PROC_LINE returns the current line number of the specified program task.	171
PROC_STATUS	PROC_STATUS returns the status of the process specified.	172
PROCNUMBER	PROCNUMBER contains the number of the task in which the currently selected program is running.	172
RUN_ERROR	RUN_ERROR contains the number of the last BASIC error that occurred on the specified task.	180
TICKS	TICKS contains the current count of the task clock pulses.	189

6-2-11 Servo Driver Commands and Parameters

The table below outlines the Servo Driver commands and parameters. Refer to the specified pages for details.

Name	Description	Page
DRV_CLEAR	DRV_CLEAR clears the alarm status of the Servo Driver.	133
DRV_READ	DRV_READ reads the specified parameter of the Servo Driver.	133
DRV_RESET	DRV_RESET will software reset both the Servo Driver as the MC Unit.	134
DRV_STATUS	DRV_STATUS contains the current servo alarm code of the Servo Driver.	134
DRV_WRITE	DRV_WRITE writes a specific value to the specified parameter of the Servo Driver.	135

6-2-12 Host Link Commands and Parameters

The table below outlines the Host Link commands and parameters. Refer to the specified pages for details.

Name	Description	Page
HLM_COMMAND	HLM_COMMAND executes a specific Host Link command to the Slave.	144
HLM_READ	HLM_READ reads data from the Host Link Slave to either VR or Table variable array.	146
HLM_STATUS	HLM_STATUS represents the status of the last Host Link Master command.	147
HLM_TIMEOUT	HLM_TIMEOUT defines the Host Link Master timeout time.	147
HLM_WRITE	HLM_WRITE writes data to the Host Link Slave from either VR or Table variable array.	148
HLS_MODEL	HLS_MODEL defines the MC Unit model code for the Host Link Slave protocol.	149
HLS_NODE	HLS_NODE defines the Slave unit number for the Host Link Slave protocol.	149

6-2-13 DeviceNet Commands and Parameters

The table below outlines the DeviceNet commands and parameters. Refer to the specified pages for details.

Name	Description	Page
FB_SET	FB_SET sets the Remote I/O Messaging data to be transferred for input word 2.	138
FB_STATUS	FB_STATUS returns the status of the communications of the MC Unit with the DeviceNet master.	138

6-3 Command, function and parameter description

This section describes the commands, functions and parameters which are used in the BASIC programming language.

 **WARNING** It is the responsibility of the programmer to ensure that the motion functions are invoked correctly, with the correct number of parameters and values. Failure to do so may result in unexpected behavior, loss or damage to the machinery.

6-3-1 Multiply: *

Type: Arithmetic Operation

Syntax: *expression_1* * *expression_2*

Description: The multiply operator "*" multiplies any two valid expressions.

Arguments: ***expression_1***
Any valid BASIC expression.
expression_2
Any valid BASIC expression.

Example: `factor = 10*(2.1+9)`
The parentheses are evaluated first, and then the result, 11.1, is multiplied by 10. Therefore, *factor* would contain the value 111

6-3-2 Power: ^

Type: Arithmetic Operation

Syntax: *expression_1* ^ *expression_2*

Description: The power operator "^" raises *expression_1* to the power of *expression_2*.

 **WARNING** This operation uses floating point algorithms and may give small deviations for integer calculations.

Arguments: ***expression_1***
Any valid BASIC expression.
expression_2
Any valid BASIC expression.

Example: `thirtytwo = 2^5`
This sets the variable *thirtytwo* to 32.

6-3-3 Add: +

Type: Arithmetic Operation

Syntax: *expression_1* + *expression_2*

Description: The add operator "+" adds any two valid expressions.

Arguments: ***expression_1***
Any valid BASIC expression.
expression_2
Any valid BASIC expression.

Example: `result = 10+(2.1*9)`
The parentheses are evaluated first, and the result, 18.9, is added to 10. Therefore, *result* would contain the value 28.9.

6-3-4 Subtract: –

Type: Arithmetic Operation

Syntax: *expression_1* – *expression_2*

Description: The subtract operator “–” subtracts any two valid expressions.

Arguments: ***expression_1***
Any valid BASIC expression.
expression_2
Any valid BASIC expression.

Example: `VR(0) = 10 – (2.1*9)`
The parentheses are evaluated first, and the result, 18.9, is subtracted from 10. Therefore, VR(0) would contain the value –8.9.

6-3-5 Divide: /

Type: Arithmetic Operation

Syntax: *expression_1* / *expression_2*

Description: The divide operator “/” divides any two valid expressions.

Arguments: ***expression_1***
Any valid BASIC expression.
expression_2
Any valid BASIC expression.

Example: `a = 10 / (2.1+9)`
The parentheses are evaluated first, and then 10 is divided by the result, 11.1. Therefore, a would contain the value 0.9009

6-3-6 Is Less Than: <

Type: Logical Operation

Syntax: *expression_1* < *expression_2*

Description: The less than operator “<” returns TRUE if *expression_1* is less than *expression_2*, otherwise it returns FALSE.

Arguments: ***expression_1***
Any valid BASIC expression.
expression_2
Any valid BASIC expression.

Example: `IF VR(1) < 10 THEN GOSUB rollup`
If the value returned from VR(1) is less than 10, then subroutine “rollup” would be executed.

6-3-7 Is Less Than Or Equal To: <=

Type: Logical Operation

Syntax: *expression_1* <= *expression_2*

Description: The less than or equal to operator “<=” returns TRUE if *expression_1* is less than or equal to *expression_2*, otherwise it returns FALSE.

Arguments: ***expression_1***
Any valid BASIC expression.
expression_2
Any valid BASIC expression.

Example: `maybe = 1 <= 0`

In the above line, 1 is not less than or equal to 0 and, therefore, variable *maybe* would contain the value 0 (FALSE).

6-3-8 Is Not Equal To: <>

- Type:** Logical Operation
- Syntax:** *expression_1* <> *expression_2*
- Description:** The not equal to operator "<>" returns TRUE if *expression_1* is not equal to *expression_2*, otherwise it returns FALSE.
- Arguments:** ***expression_1***
Any valid BASIC expression.
expression_2
Any valid BASIC expression.
- Example:** IF MTYPE <> 0 THEN GOTO 3000
If the base axis is not idle (MTYPE=0 indicates an axis idle), then a jump would be made to label 3000.

6-3-9 Is Equal To: =

- Type:** Logical Operation
- Syntax:** *expression_1* = *expression_2*
- Description:** The equal to operator "=" returns TRUE if *expression_1* is equal to *expression_2*, otherwise it returns FALSE.
- Arguments:** ***expression_1***
Any valid BASIC expression.
expression_2
Any valid BASIC expression.
- Example:** IF IN(7) = ON THEN GOTO label
If input 7 is ON, then program execution will continue at line starting "label:".

6-3-10 Is Greater Than: >

- Type:** Logical Operation
- Syntax:** *expression_1* > *expression_2*
- Description:** The greater than operator ">" returns TRUE if *expression_1* is greater than *expression_2*, otherwise it returns FALSE.
- Arguments:** ***expression_1***
Any valid BASIC expression.
expression_2
Any valid BASIC expression.
- Examples:** **Example 1**
VR(0) = 1 > 0
In the above line, 1 is greater than 0 and, therefore, VR(0) would contain the value -1
- Example 2**
WAIT UNTIL MPOS > 200
Program execution will wait until the measured position is greater than 200.

6-3-11 Is Greater Than or Equal To: >=

- Type:** Logical Operation
- Syntax:** *expression_1* >= *expression_2*

Description: The greater than or equal to operator ">=" returns TRUE if *expression_1* is greater than or equal to *expression_2*, otherwise it returns FALSE.

Arguments: *expression_1*
Any valid BASIC expression.
expression_2
Any valid BASIC expression.

Example: `IF target >= 120 THEN MOVEABS(0)`
If the variable *target* holds a value greater than or equal to 120, then the base axis will move to an absolute position of 0.

6-3-12 Hexadecimal input: \$

Type: System Command

Syntax: *\$hex_number*

Description: The hexadecimal input command (character \$) assigns a hexadecimal number to a variable. The hexadecimal number is inputted by proceeding the number by the \$ character. This operation will write the decimal equivalent to the VR, Table or local variable.

Arguments: *hex_number*
Any hexadecimal number (characters 0-9,A-F). Range: [0, FFFFFFF] Hex.

See also: HEX (PRINT)

Example:
`>>TABLE(0,$F,$ABCD)`
`>>print TABLE(0),TABLE(1)`
15.0000 43981.0000

6-3-13 Statement separator: ":"

Type: Program command

Syntax: `<statement>: <statement>`

Description: The statement separator, represented by the colon ":", can be used to separate BASIC statements on a multi-statement line. This separator can be used both on the command line as in programs.

Example: `PRINT "THIS LINE": GET low : PRINT "DOES THREE THINGS"`

6-3-14 Comment field: ‘

Type: Program command

Syntax: `‘ [<Comment field>]`

Description: The single quote “ ‘ ” can be used in a program to mark a line as being comment which will not be executed. The single quote can be put at the beginning of a line or after any valid statement.

Example:
`` This line will not be printed.`
`PRINT "Start"`

6-3-15 ABS

Type: Mathematical Function

Syntax: `ABS (expression)`

Description: The ABS function converts a negative number into its positive equal. Positive numbers are unaltered.

Arguments: *expression*
Any valid BASIC expression.

Example: `IF ABS(VR(0)) > 100 THEN PRINT "VR(0) Outside ±100"`

6-3-16 ACCEL

Type: Axis parameter

Description: The ACCEL axis parameter contains the axis acceleration rate. The rate is set in units/s². The parameter can have any positive value including zero.

See also: AXIS, DECEL, UNITS

Example:

```
BASE(0)
ACCEL = 100           `Set acceleration rate
PRINT "Acceleration rate: ";ACCEL;" mm/s/s"
ACCEL AXIS(2) = 100 `Sets acceleration rate for axis (2)
```

6-3-17 ACOS

Type: Mathematical Function

Syntax: `ACOS (expression)`

Description: The ACOS function returns the arc-cosine of the *expression*. The *expression* value must be between -1 and 1. The result in radians will be between 0 and PI. Input values outside the range will return zero.

Arguments: ***expression***
Any valid BASIC expression.

Example:

```
>> PRINT ACOS(-1)
3.1416
```

6-3-18 ADD_DAC

Type: Motion Control Command

Description: The ADD_DAC command can provide dual feedback control by allowing a secondary encoder (axis 1) to be used on the servo axis (axis 0). The command allows the output of 2 servo loops to be summed to determine the speed reference to the servo driver.

This command is typically used in applications such as a roll-feed where a secondary encoder would be required to compensate for slippage.

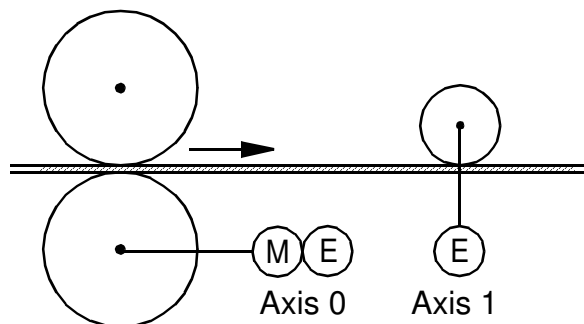

For using ADD_DAC it is necessary for the two axes with physical feedback to link to a common axis on which the required moves are executed. Typically this would be achieved by running the moves on one of the two axes and using ADDAX or CONNECT to produce a matching demand position (DPOS) for both axes. The servo loop gains need to be set for both axes. The servo

loop outputs are summed to the speed reference output of the servo axis (axis 0). Use ADD_DAC(-1) to cancel the link.

ADD_DAC works on the default basis axis (set with BASE) unless AXIS is used to specify a temporary base axis.

- Note**
1. Be aware that the control loop gains for both axes need to be determined with care. As different encoders with different resolutions are used, the gains are not identical.
 2. To create a servo loop on axis 1, set the ATYPE parameter of that axis to servo (value 2).
 3. Set the OUTLIMIT parameter of axis 1 to the same value as the value for axis 0, which is 15000. Otherwise the output reference axis 1 will be limited.

Arguments: *axis*

The axis from which to sum the speed reference output to the base axis. Set the argument to -1 to cancel the link and return to normal operation.

See also: AXIS, ADDAX, OUTLIMIT

Examples: **Example 1**

The following example shows controlling the Servo Driver axis 0 with dual feedback control using both axis 0 and axis 1.

```
BASE(0)
OUTLIMIT AXIS(1) = 15000
ADD_DAC(1) AXIS(0)
ADDAX(0) AXIS(1)
```

```
WDOG = ON
SERVO AXIS(0) = ON
SERVO AXIS(1) = ON
```

` Execute moves on axis 0

Example 2

The following example shows controlling the Servo Driver axis 0 with using only encoder feedback on axis 1.

```
BASE(0)
OUTLIMIT AXIS(1) = 15000
ADD_DAC(1) AXIS(0)
```

```
WDOG = ON
SERVO = OFF
S_REF = 0
```

```
BASE(1)
SERVO = ON
```

` Execute moves on axis 1

6-3-19 ADDAX_AXIS

Type: Axis parameter

Description: The ADDAX_AXIS axis parameter returns the number of the axis to which the base axis is currently linked to by ADDAX.

Note This parameter is read-only.

See also: AXIS, ADDAX

Example:

```
>> BASE(0)
>> ADDAX(2)
```

```
>> PRINT ADDAX_AXIS
2.0000
```

6-3-20 ADDAX

Type: Motion Control Command

Syntax: ADDAX (*axis*)

Description: The ADDAX command takes the demand position changes from the superimposed axis as specified by the *axis* argument and adds them to any movement running on the axis to which the command is issued.

After the ADDAX command has been issued the link between the two axes remains until broken. Use ADDAX (-1) to cancel the axis link. ADDAX allows an axis to perform the moves specified for 2 axes added together. Combinations of more than two axes can be made by applying ADDAX to the superimposed axis as well.

ADDAX works on the default basis axis (set with BASE) unless AXIS is used to specify a temporary base axis.

 **WARNING** Beware that giving several ADDAX commands in a system can create a dangerous loop when for instance one axis is linked to another and vice versa. This may cause instability in the system.

Arguments: *axis*
The axis to be set as a superimposed axis. Set the argument to -1 to cancel the link and return to normal operation.

See also: ADDAX_AXIS, AXIS

Example: Pieces are placed onto a continuously moving belt and further along the line are picked up. A detection system gives an indication as to whether a piece is in front of or behind its nominal position, and how far.

In the example below, axis 0 is assumed to be the base axis and it executes a continuous forward movement and a superimposed move on axis 2 is used to apply offsets according to the offset calculated in a subroutine.

```
FORWARD                'Set continuous move
ADDAX(2)               'Add axis 2 for correction
REPEAT
  GOSUB getoffset      'Get offset to apply
  MOVE(offset) AXIS(2)
UNTIL IN(2) = ON      'Until correction is done
```

6-3-21 AIN

Type: System Parameters

Syntax: AIN0, AIN1, AIN2, AIN3

Description: The AIN parameters provide four analog channels which contain the Servo Driver monitor data signals. The channels return a decimal representation of the internal Servo Driver data. The following data can be accessed.

Parameter	Description	Range
AIN0	Servo Driver analog input (REF), connected to CN1 pin 5 and 6.	(-26214, 26213) => (- 12 V, 12 V)
AIN1	Servo Driver torque command signal.	(-15000, 15000) => (- max. torque, max. torque)
AIN2	Servomotor rotation speed signal.	(-15000, 15000) => (- overspeed, overspeed)
AIN3	Servo Driver torque monitor signal.	(-15000, 15000) => (- max. torque, max. torque)

For the AIN2 channel the S_RATE axis parameter can be used to convert the data into a value in round per minute. For both the AIN1 and AIN3 channels the T_RATE axis parameter can be used to convert the value into a percentage of the rated torque.

See also: IN, S_RATE, T_RATE

Example: Consider an application where the speed of movement is determined by the analog input voltage.

```
MOVE (10000)
WHILE MTYPE<>0
  sp = AIN0
  IF sp < 0 THEN sp = 0
  SPEED = sp*0.1
WEND
```

6-3-22 AND

Type: Logical Operator

Syntax: *expression_1* AND *expression_2*

Description: The AND operator performs the logical AND function on the corresponding bits of the integer parts of two valid BASIC expressions.

The logical AND function between two bits is defined as follows:

Bit 1	Bit 2	Result
0	0	0
0	1	0
1	0	0
1	1	1

Arguments: *expression_1*
Any valid BASIC expression.

expression_2
Any valid BASIC expression.

Examples: **Example 1**

```
VR(0) = 10 AND (2.1*9)
```

The parentheses are evaluated first, but only the integer part of the result, 18, is used for the AND operation. Therefore, this expression is equivalent to the following:

```
VR(0) = 10 AND 18
```

The AND is a bit operator and so the binary action is as follows:

Therefore, VR(0) will contain the value 2.

```

          01010
AND      10010
-----
          00010

```

Example 2

```
IF MPOS AXIS(0) > 0 AND MPOS AXIS(1) > 0 THEN GOTO cycle1
```

6-3-23 ASIN

Type: Mathematical Function

Syntax: ASIN(*expression*)

Description: The ASIN function returns the arc-sine of the *expression*. The *expression* value must be between -1 and 1 . The result in radians will be between $-\pi/2$ and $\pi/2$. Input values outside the range will return zero.

Arguments: *expression*
Any valid BASIC expression.

Example:
>> PRINT ASIN(-1)
-1.5708

6-3-24 ATAN

Type: Mathematical Function

Syntax: ATAN(*expression*)

Description: The ATAN function returns the arc-tangent of the *expression*. ATAN can have any value. The result will be in radians and will be between $-\pi/2$ and $\pi/2$.

Arguments: *expression*
Any valid BASIC expression.

Example:
>> PRINT ATAN(1)
0.7854

6-3-25 ATAN2

Type: Mathematical Function

Syntax: ATAN2(*expression_1*, *expression_2*)

Description: The ATAN2 function returns the arc-tangent of the nonzero complex number (*expression_2*, *expression_1*), which is equivalent to the angle between a point with coordinate (*expression_1*, *expression_2*) and the x-axis. If *expression_2* ≥ 0 , the result is equal to the value of ATAN (*expression_1* / *expression_2*). The result in radians will be between $-\pi$ and π .

Arguments: *expression_1*
Any valid BASIC expression.
expression_2
Any valid BASIC expression.

Example:
>> PRINT ATAN2(0, 1)
0.0000

6-3-26 ATYPE

Type: Axis parameter

Description: The ATYPE axis parameter sets the axis type for the axis. The valid values is depending on the axis

Axis number	Axis type	ATYPE value
0	Servo	13 (fixed)
1	Virtual	0
	Servo	2
	Encoder input	3 (default)
	Encoder output	14
2	Virtual	0 (fixed)

The ATYPE parameters are set by the system at start-up to the default value of the axis. Refer to 3-3 System Functions for more details on the different axis types.

See also: AXIS

Example: The following command will set axis 1 as encoder output axis.
 >> ATYPE AXIS(1)=14

6-3-27 AUTORUN

Type: Program Command

Syntax: AUTORUN

Description: The AUTORUN command starts all the programs that have been set to run at start-up.

See also: RUNTYPE

6-3-28 AXIS

Type: System Command

Syntax: AXIS (*axis_number*)

Description: The AXIS modifier sets the axis for a single motion command or a single axis parameter read/write to a particular axis. AXIS is effective only for the command or program line in which it is programmed. Use the BASE command to change the base axis for all following command lines.

Arguments: *axis_number*
 Any valid BASIC expression specifying the axis number.

Precautions: The AXIS command can be used to modify any axis parameter expression and the following axis dependent commands: ADDAX, CAM, CAMBOX, CANCEL, CONNECT, DATUM, DEFPOS, FORWARD, MOVEABS, MOVECIRC, MOVELINK, MOVE, MOVEMODIFY and REVERSE. Other commands for which AXIS is used are: REGIST, WAIT IDLE and WAIT LOADED.

See also: BASE

Examples:

Example 1
 BASE (0)
 PRINT VP_SPEED AXIS (2)

Example 2
 MOVE (300) AXIS (0)

Example 3
 REPDIST AXIS (1) = 100

6-3-29 AXISSTATUS**Type:** Axis Parameter**Description:** The AXISSTATUS axis parameter contains the axis status. The AXISSTATUS axis parameter definition for the three axes are shown in the following table.

Bit number	Description	Value	Character (as used in Motion Perfect)	Axis 0 (Servo Driver)	Axis 1 (Encoder in/out, virtual)	Axis 2 (Virtual)
0	-	1	-	-	-	-
1	Following Error Warning	2	w	x	-	-
2	Servo Driver Communication Error	4	a	x	-	-
3	Servo Driver Alarm	8	m	x	-	-
4	Forward Limit	16	f	x	x	x
5	Reverse Limit	32	r	x	x	x
6	Datuming	64	d	x	x	x
7	Feed Hold Input	128	h	x	x	x
8	Following Error Limit	256	e	x	-	-
9	Forward Software Limit	512	x	x	x	x
10	Reverse Software Limit	1024	y	x	x	x
11	Cancelling Move	2048	c	x	x	x
12	Encoder Out Overspeed	4096	o	-	x	-

The AXISSTATUS parameter is used for the motion error handling of the unit. Refer to *8-2 Error Handling* for more detailed information on error handling.

Note This parameter is read-only.**See also:** AXIS, ERRORMASK**Example:** `IF (AXISSTATUS AND 16)>0 THEN PRINT "In forward limit"`**6-3-30 BASE****Type:** Motion Control Command**Syntax:** `BASE (axis_1 [,axis_2 [, axis_3]])`
BASE**Alternative:** `BA (axis_1 [, axis_2 [, axis_3]])`
BA**Description:** The BASE command is used to set the default base axis or to set a specified axis sequence group. All subsequent motion commands and axis parameters will apply to the base axis or the specified axis group unless the AXIS command is used to specify a temporary base axis. The base axis is effective until it is changed again with BASE.

Each BASIC process can have its own axis group and each program can set its own axis group independently. Use the PROC modifier to access the parameter for a certain task.

The BASE order grouping can be set by explicitly assigning the order of axes. This order is used for interpolation purposes in multi-axes linear and circular moves. The default for the base axis group is (0,1,2) at start-up or when a program starts running on a task. The BASE command without any arguments returns the current base order grouping.

- Arguments:** *axis_i*
The number of the axis set as the base axis and any subsequent axes in the group order for multi-axis moves.
- See also:** AXIS
- Examples:** **Example 1**
It is possible to program each axis with its own speed, acceleration and other parameters.
- ```
BASE(1)
UNITS = 2000 'Set unit conversion factor for axis 1
SPEED = 100 'Set speed for axis 1
ACCEL = 5000 'Set acceleration rate for axis 1
BASE(2)
UNITS = 2000 'Set unit conversion factor for axis 2
SPEED = 125 'Set speed for axis 2
ACCEL = 10000 'Set acceleration rate for axis 2
```
- Example 2**  
In the example below, axes 0, 1 and 2 will move to the specified positions at the speed and acceleration set for axis 0. BASE(0) sets the base axis to axis 0, which determines the three axes used by MOVE and the speed and acceleration rate.
- ```
BASE(0)
MOVE(100,-23.1,1250)
```
- Example 3**
On the command line the base group order can be shown by typing BASE.
- ```
>> BASE(0,2,1)
>> BASE
(0,2,1)
```
- Example 4**  
Use the PROC modifier to show the base group order of a certain task.
- ```
>> RUN "PROGRAM",3
>> BASE PROC(3)
(0,2,1)
```
- Example 5**
Printing BASE will return the current selected base axis.
- ```
>> BASE(2)
>> PRINT BASE
2.0000
```

## 6-3-31 BASICERROR

- Type:** System Command
- Description:** The BASICERROR command can be used to run a routine when a run-time error occurs in a program. BASICERROR can only be used as part of an ON ... GOSUB or ON ... GOTO command. This command is required to be executed once in the BASIC program. If several commands are used only the one executed last is effective.
- See also:** ERROR\_LINE, ON, RUN\_ERROR
- Example:** If an error occurs in a BASIC command in the following example, then the error routine will be executed.
- ```
ON BASICERROR GOTO error_routine
....
no_error = 1
STOP
error_routine:
IF no_error = 0 THEN
```

```

        PRINT "The error ";RUN_ERROR[0];
        PRINT " occurred in line ";ERROR_LINE[0]
    ENDIF
    STOP

```

The IF statement is present to prevent the program going into error routine when it is stopped normally.

6-3-32 CAM

Type: Motion Control Command

Syntax: `CAM (start_point, end_point, table_multiplier, distance)`

Description: The CAM command is used to generate movement of an axis following a position profile which is stored in the Table variable array. The Table values are absolute positions relative to the starting point and are specified in encoder edges. The Table array is specified with the TABLE command.

The movement can be defined with any number of points from 2 to 8.000. The MC Unit moves continuously between the values in the Table to allow a number of points to define a smooth profile. Two or more CAM commands can be executed simultaneously using the same or overlapping values in the Table array. The Table profile is traversed once.

CAM requires that the start element in the Table array has value zero. The *distance* argument together with the SPEED and ACCEL parameters determine the speed moving through the Table array. Note that in order to follow the CAM profile exactly the ACCEL parameter of the axis must be at least 1000 times larger than the SPEED parameter.

CAM works on the default basis axis (set with BASE) unless AXIS is used to specify a temporary base axis.

Arguments:

start_point

The address of the first element in the Table array to be used.

Being able to specify the start point allows the Table array to hold more than one profile and/or other information.

end_point

The address of the end element in the Table array.

table_multiplier

The Table multiplier value used to scale the values stored in the Table. As the Table values are specified in encoder edges, use this argument to set the values for instance to the unit conversion factor (set by UNITS parameter).

distance

A factor given in user units that controls the speed of movement through the Table. The time taken to execute CAM depends on the current axis speed and this distance. For example, assume the system is being programmed in mm and the speed is set to 10 mm/s and the acceleration sufficiently high. If a distance of 100 mm is specified, CAM will take 10 seconds to execute.

The SPEED parameter in the base axis allows modification of the speed of movement when using the CAM move.

See also: ACCEL, AXIS, CAMBOX, SPEED, TABLE

Example: Assume that a motion is required to follow the following position equation:

$$t(x) = x^2 + 10000(1 - \cos(x))$$

Here, x is in degrees. This example is for a Table that provides a simple oscillation superimposed with a constant speed. To load the Table and cycle it continuously the following code would be used.

```

        GOSUB camtable
    loop:

```

```
CAM(1, 19, 1, 200)
GOTO loop
```

Note The subroutine *camtable* would load the data below into the Table array.

Table position	Degree	Value
1	0	0
2	20	1103
3	40	3340
4	60	6500
5	80	10263
6	100	14236
7	120	18000
8	140	21160
9	160	23396
10	180	24500
11	200	24396
12	220	23160
13	240	21000
14	260	18236
15	280	15263
16	300	12500
17	320	10340
18	340	9103
19	360	9000

6-3-33 CAMBOX

Type: Motion Control Command

Syntax: CAMBOX (*start_point*, *end_point*, *table_multiplier*, *link_distance*, *link_axis* [, *link_option* [, *link_position*]])

Description: The CAMBOX command is used to generate movement of an axis following a position profile in the Table variable array. The motion is linked to the measured motion of another axis to form a continuously variable software gearbox. The Table values are absolute position relative to the starting point and are specified in encoder edges.

The Table array is specified with the TABLE command. The movement can be defined with any number of points from 2 to 8.000. Being able to specify the start point allows the Table array to be used to hold more than one profile and/or other information. The MC Unit moves continuously between the values in the Table to allow a number of points to define a smooth profile. Two or more CAMBOX commands can be executed simultaneously using the same or overlapping values in the Table array.

The CAMBOX command requires the start element of the Table to have value zero. Note also that CAMBOX command allows traversing the Table backwards as well as forwards depending on the Master axis direction.

The link_option argument can be used to specify different options to start the command and to specify a continuous CAM. For example, if the link_option is set to 4 then the CAMBOX operates like a "physical" CAM.

CAMBOX works on the default basis axis (set with BASE) unless AXIS is used to specify a temporary base axis.

Arguments: *start_point*

The address of the first element in the Table array to be used.

end_point

The address of the end element in the Table array.

table_multiplier

The Table multiplier value used to scale the values stored in the Table. As the Table values are specified in encoder edges, use this argument to set the values for instance to the unit conversion factor (set by UNITS parameter).

link_distance

The distance in user units the link axis must move to complete the specified output movement. The link distance must be specified as a positive distance.

link_axis

The axis to link to.

link_option

- 1 Link starts when registration event occurs on link axis.
- 2 Link starts at an absolute position on link axis (see *link_position*).
- 4 CAMBOX repeats automatically and bi-directionally. This option is canceled by setting bit 1 of REP_OPTION parameter (i.e. REP_OPTION = REP_OPTION OR 2).
- 5 Combination of options 1 and 4.
- 6 Combination of options 2 and 4.

link_position

The absolute position where CAMBOX will start when *link_option* is set to 2.

Precautions:

While CAMBOX is being executed, the ENDMOVE parameter will be set to the end of the previous move. The REMAIN axis parameter will hold the remainder of the distance on the link axis.

See also:

AXIS, CAM, REP_OPTION, TABLE

6-3-34 CANCEL**Type:**

Motion Control Command

Syntax:

CANCEL [(1)]

Alternative:

CA [(1)]

Description:

The CANCEL command cancels the current move on an axis. Speed-profiled moves (FORWARD, REVERSE, MOVE, MOVEABS and MOVECIRC) will be decelerated at the deceleration rate as set by the DECEL parameter and then stopped. Other moves will be immediately stopped.

CANCEL command cancels the contents of the current move buffer (MTYPE). The command CANCEL(1) command cancels the contents of the next move buffer (NTYPE) without affecting the current move in the MTYPE buffer.

CANCEL works on the default basis axis (set with BASE) unless AXIS is used to specify a temporary base axis.

Precautions:

- CANCEL cancels only the presently executing move. If further moves are buffered they will then be loaded.
- During the deceleration of the current move additional CANCELs will be ignored.
- CANCEL(1) cancels only the presently buffered move. Any moves stored in the task buffers indicated by the PMOVE variable can be loaded into the buffer as soon as the buffered move is cancelled.

See also:

AXIS, MTYPE, NTYPE, PMOVE, RAPIDSTOP

Examples:

Example 1
FORWARD
WA (10000)
CANCEL

Example 2
MOVE (1000)
MOVEABS (3000)
CANCEL 'Cancel the move to 3000 and move to 4000 instead.
MOVEABS (4000)

Note that the command MOVEMODIFY is a better solution for modifying end-points of moves in this case.

6-3-35 CHECKSUM

Type: System Parameter

Description: The CHECKSUM parameter contains the checksum for the programs in RAM. At start-up, the checksum is recalculated and compared with the previously held value. If the checksum is incorrect the program will not run.

Note This parameter is read-only.

6-3-36 CLEAR

Type: System Command

Syntax: CLEAR

Description: The CLEAR command resets all global VR variables to zero and when used in program will also reset the local variables on the current task to zero.

See also: RESET, VR

6-3-37 CLEAR_BIT

Type: System Command

Syntax: CLEAR_BIT (*bit_number*, *vr_number*)

Description: The CLEAR_BIT command resets the specified bit in the specified VR variable to zero. Other bits in the variable will keep their values.

Arguments: ***bit_number***
The number of the bit to be reset. Range: [0, 23].
vr_number
The number of the VR variable for which the bit will be reset. Range: [0, 250]

See also: READ_BIT, SET_BIT, VR

6-3-38 CLOSE_WIN

Type: Axis Parameter

Alternative: CW

Description: The CLOSE_WIN axis parameter defines the end of the window inside or outside which a registration mark is expected. The value is in user units.

See also: AXIS, OPEN_WIN, REGIST, UNITS

6-3-39 CLUTCH_RATE

Type: Axis Parameter

Description: The CLUTCH_RATE axis parameter defines the change in connection ratio when using the CONNECT command. The rate is defined as amount of ratio per second.

The default value is set to a high value (1000000) in order to ensure compatibility with previous MC Units (MC402-E).

Note The operation using CLUTCH_RATE is not deterministic in position. If required, use the MOVELINK command instead to avoid unnecessary phase difference between master and slave.

See also: AXIS, CONNECT, MOVELINK

Example: CLUTCH_RATE = 4

This setting will imply that when giving CONNECT(4,1), it will take one second to reach the full connection.

6-3-40 COMMSERROR

Type: System Parameter

Description: The COMMSERROR parameter contains the serial communication errors that have occurred since the last time that it was initialized.

The bits in COMMSERROR are defined as follows:

Bit	Description
0	Overrun error port 0
1	Parity error port 0
2	Framing error port 0
3	Break interrupt port 0
4	Overrun error port 1
5	Parity error port 1
6	Framing error port 1
7	Break interrupt port 1
8	Overrun error port 2
9	Parity error port 2
10	Framing error port 2
11	Break interrupt port 2

This parameter is read-only.

6-3-41 COMPILE

Type: Program Command

Syntax: COMPILE

Description: The COMPILE command forces the compilation the current program to intermediate code. Program are compiled automatically by the system software prior to program execution or when another program is selected.

6-3-42 CONNECT

Type: Motion Control Command

Syntax: CONNECT (*ratio*, *driving_axis*)

Alternative: CO (*ratio*, *driving_axis*)

Description: The CONNECT command connects the demand position of the base axis to the measured movements of the axis specified by *driving_axis* to achieve an electronic gearbox.

The ratio can be changed at any time by executing another CONNECT command on the same axis. To change the driving axis the CONNECT command needs to be cancelled first. CONNECT with different driving axis will be ignored. The CONNECT command can be cancelled with a CANCEL or RAPIDSTOP command. The CLUTCH_RATE axis parameter can be used to set a specified connection change rate.

CONNECT works on the default basis axis (set with BASE) unless AXIS is used to specify a temporary base axis.

Arguments: *ratio*
The connection ratio of the gearbox. The ratio is specified as the encoder edge ratio (not units). It holds the number of edges the base axis is required to move per edge increment of the driving axis. The ratio value can be either positive or negative and has sixteen bit fractional resolution.

driving_axis

The Master axis which will drive the base axis.

See also: AXIS, CANCEL, CLUTCH_RATE, CONNECT, RAPIDSTOP

Example: In a press feed, a roller is required to rotate at a speed one quarter of the measured rate from an encoder mounted on the incoming conveyor. The roller is wired to axis 0. An input channel monitors the encoder pulses from the conveyor and forms axis 1. The following code can be used.

```
BASE (1)
SERVO = OFF      'This axis is used to monitor the conveyor
BASE (0)
SERVO = ON
CONNECT (0.25,1)
```

6-3-43 CONTROL

Type: System Parameter

Description: The CONTROL parameter contains the type of MC Unit in the system. For both the MCW151-E and MCW151-DRT-E it will returns value 260.

Note This parameter is read-only.

6-3-44 COPY

Type: Program Command

Syntax: COPY "*program_name*" "*new_program_name*"

Description: The COPY command copies an existing program in memory to a new program with the specified name. The program names can also be specified without quotes.

Precautions: This command is implemented for an offline (VT100) terminal. Within Motion Perfect users can select the command from the Program menu.

Arguments: *program_name*
Name of the program to be copied.

new_program_name
Name to use for the new program.

See also: DEL, NEW, RENAME

Example: >> COPY "prog" "newprog"

6-3-45 COS

Type: Mathematical Function

Syntax: COS (*expression*)

Description: The COS function returns the cosine of the *expression*. Input values are in radians and may have any value. The result value will be in the range from -1 to 1.

Arguments: *expression*
Any valid BASIC expression.

Example: >> PRINT COS (0)
 1.0000

6-3-46 CREEP

Type: Axis Parameter

Description: The CREEP axis parameter contains the creep speed on the axis. The creep speed is used for the slow part of an origin search sequence. CREEP is allowed to have any positive value (including zero).
The creep speed is entered in units/s using the unit conversion factor UNITS. For example, if the unit conversion factor is set to the number of encoder edges/inch, the speed is set in inches/s.

See also: AXIS, DATUM, UNITS

Example: BASE (2)
 CREEP = 10
 SPEED = 500
 DATUM (4)
 CREEP AXIS (1) = 10
 SPEED AXIS (1) = 500
 DATUM (4) AXIS (1)

6-3-47 D_GAIN

Type: Axis Parameter

Description: The D_GAIN axis parameter contains the derivative gain for the axis. The derivative output contribution is calculated by multiplying the change in following error with D_GAIN. The default value is zero.
Adding derivative gain to a system is likely to produce a smoother response and allow the use of a higher proportional gain than could otherwise be used. High values may cause oscillation.
See section 1-4-1 *Servo System Principles* for more details.

See also: AXIS, I_GAIN, OV_GAIN, P_GAIN, VFF_GAIN

Precautions: In order to avoid any instability the servo gains should be changed only when the SERVO is OFF.

6-3-48 DATUM

Type: Motion Control Command

Syntax: DATUM (*sequence*)

Description: The DATUM command performs one of 6 origin search sequences to position an axis to an absolute position and also can be used to reset the following errors. The origin search mechanism of the Servo Driver is used for axis 0. Axis 1 uses the mechanism in the MC Unit.
DATUM uses both the creep speed and the demand speed for the origin searches. For axis 0 the Servo Driver function is used. The creep speed in the sequences is set using the CREEP axis parameter and the demand speed is set using the SPEED axis parameter. The datum switch input number, which is used for sequences 3 to 7, is selected by the DATUM_IN parameter.
DATUM works on the default basis axis (set with BASE) unless AXIS is used to specify a temporary base axis.

Arguments:	<p>sequence</p> <p>0 The DATUM(0) command will clear the motion error. The currently measured position is set as the demand position and the AXISSTATUS status will be cleared. Note that the status can not be cleared if the cause of the problem is still present.</p> <p>1 The axis moves at creep speed forward until the Z marker is encountered. The demand position is then reset to zero and the measured position is corrected to maintain the following error.</p> <p>2 The axis moves at creep speed reverse until the Z marker is encountered. The demand position is then reset to zero and the measured position is corrected to maintain the following error.</p> <p>3 The axis moves at the demand speed forward until the datum switch is reached. The axis then moves reverse at creep speed until the datum switch is reset. The demand position is then reset to zero and the measured position corrected so as to maintain the following error.</p> <p>4 The axis moves at the demand speed reverse until the datum switch is reached. The axis then moves forward at creep speed until the datum switch is reset. The demand position is then reset to zero and the measured position corrected so as to maintain the following error.</p> <p>5 The axis moves at demand speed forward until the datum switch is reached. The axis then reverses at creep speed until the Z marker is encountered. The demand position is then reset to zero and the measured position corrected so as to maintain the following error.</p> <p>6 The axis moves at demand speed reverse until the datum switch is reached. The axis then moves forward at creep speed until the Z marker is encountered. The demand position is then reset to zero and the measured position corrected so as to maintain the following error.</p>
Precautions:	The origin input set with the DATUM_IN parameter is active low, i.e., the origin switch is set when the input is OFF. The feedhold, reverse jog, forward jog, forward and reverse limit inputs are also active low. Active low inputs are used to enable fail-safe wiring.
See also:	ACCEL, AXIS, AXISSTATUS, CREEP, DATUM_IN, DECEL, MOTION_ERROR, SPEED

6-3-49 DATUM_IN

Type:	Axis Parameter
Alternative:	DAT_IN
Description:	The DATUM_IN axis parameter contains the input number to be used as the datum switch input for the DATUM command. The valid input range is given by 0 to 7. If DATUM_IN is set to -1, then no input is used as the datum switch input.
Precautions:	The origin input is active low, i.e., the origin switch is set when the input is OFF. The feedhold, reverse jog, forward jog, forward and reverse limit inputs are also active low. Active low inputs are used to enable fail-safe wiring.
See also:	AXIS, DATUM
Example:	DATUM_IN AXIS(0) = 5

6-3-50 DECEL

Type:	Axis Parameter
Description:	The DECEL axis parameter contains the axis deceleration rate. The rate is set in units/s ² . The parameter can have any positive value including zero.
See also:	ACCEL, AXIS, UNITS
Example:	<pre>DECEL = 100 'Set deceleration rate PRINT " Deceleration rate is ";DECEL;" mm/s/s"</pre>

6-3-51 DEFPOS

Type:	Motion Control Command
Syntax:	DEFPOS (<i>pos_1</i> [, <i>pos_2</i> [, <i>pos_3</i>]])
Alternative:	DP (<i>pos_1</i> [, <i>pos_2</i> [, <i>pos_3</i>]])
Description:	<p>The DEFPOS command defines the current demand position (DPOS) as a new absolute position. The measured position (MPOS) will be changed accordingly in order to keep the following error. DEFPOS is typically used after an origin search sequence (see DATUM command), as this sets the current position to zero. DEFPOS can be used at any time.</p> <p>As an alternative also the OFFPOS axis parameter can be used. This parameter can be used to perform a relative adjustment of the current position. DEFPOS works on the default basis axis (set with BASE) unless AXIS is used to specify a temporary base axis.</p>
Precaution:	<p>The changes to the axis position made using DEFPOS or OFFPOS are made on the next servo update. This can potentially cause problems when a move is initiated in the same servo period as the DEFPOS or OFFPOS.</p> <p>The following example shows how the OFFPOS parameter can be used to avoid this problem. DEFPOS commands are internally converted into OFFPOS position offsets, which provides an easy way to avoid the problem by programming as follows:</p> <pre>DEFPOS (100) WAIT UNTIL OFFPOS = 0 MOVEABS (0)</pre>
Arguments:	<p><i>pos_i</i> The absolute position for (base+i) axis in user units. Refer to the BASE command for the grouping of the axes.</p>
See also:	AXIS, DATUM, DPOS, OFFPOS, MPOS, UNITS
Example:	<p>The last line defines the current position to (-1000,-3500) in user units. The current position would have been reset to (0,0) by the two DATUM commands.</p> <pre>BASE (2) DATUM (5) BASE (1) DATUM (4) WAIT IDLE DEFPOS (-1000, -3500)</pre>

6-3-52 DEL

Type:	Program Command
Syntax:	DEL [<i>"program_name"</i>]
Alternative:	RM [<i>"program_name"</i>]

- Description:** The DEL command deletes a program from memory. DEL without a program name can be used to delete the currently selected program (using SELECT). The program name can also be specified without quotes. DEL ALL will delete all programs.
DEL can also be used to delete the Table as follows:
DEL "TABLE"
The name "TABLE" must be in quotes.
- Precautions:** This command is implemented for an offline (VT100) terminal. Within Motion Perfect users can select the command from the Program menu.
- Arguments:** *program_name*
Name of the program to be deleted.
- See also:** COPY, NEW, RENAME, SELECT, TABLE
- Example:** >> DEL oldprog

6-3-53 DEMAND_EDGES

- Type:** Axis Parameter
- Description:** The DEMAND_EDGES axis parameter contains the current value of the DPOS axis parameter in encoder edge units.
- See also:** AXIS, DPOS
- Note** This parameter is read-only.

6-3-54 DIR

- Type:** Program Command
- Syntax:** DIR
- Alternative:** LS
- Description:** The DIR command displays a list of the programs held in memory, their memory size and their RUNTYPE. Furthermore the controller's available memory size, power up mode and current selected program is displayed.
- See also:** FREE, POWER_UP, PROCESS, RUNTYPE, SELECT

6-3-55 DPOS

- Type:** Axis Parameter
- Description:** The DPOS axis parameter contains the demand position in user units, which is generated by the move commands in servo control. When the controller is in open loop (SERVO=OFF), the measured position (MPOS) will be copied to the DPOS in order to maintain a zero following error.
The range of the demand position is controlled with the REP_DIST and REP_OPTION axis parameters. The value can be adjusted without doing a move by using the DEFPOS command or OFFPOS axis parameter. DPOS is reset to zero at start-up.
- Note** This parameter is read-only.
- See also:** AXIS, DEFPOS, DEMAND_EDGES, FE, MPOS, REP_DIST, REP_OPTION, OFFPOS, UNITS
- Example:** >> PRINT DPOS AXIS(0)
34.0000
The above line will return the demand position in user units.

6-3-56 DRV_CLEAR

Type: Servo Driver Command

Syntax: DRV_CLEAR

Description: The DRV_CLEAR command clears the alarm status of the Servo Driver. This command is not capable of clearing all the possible alarm states. Some alarms can only be cancelled by turning OFF the power supply (both the MC Unit as the Servo Driver), and then turning it ON again.

Please refer to 8-2 *Error Handling* for further details on Servo Driver alarms.

 **Caution** Be sure that no Parameter Unit or Personal Computer Software is connected to the Servo Driver when executing this command. Otherwise the program task will be paused until the connection of the other device to the Servo Driver is removed.

See also: DRV_STATUS

6-3-57 DRV_READ

Type: Servo Driver Function

Syntax: DRV_READ (*parameter* [, *selection*])

Description: The DRV_READ function reads the specified parameter of the Servo Driver. DRV_READ is able to read Pn-type and Un-type parameters and also can return Servomotor specifics which normally can be accessed using Fn011.

The Servo Driver Pn parameters are divided into two groups:

- Selection parameters, which contain hexadecimal value. One example is for instance the Pn50A (input signal selection 1)
- Value parameters, which contain integer values. One example is for instance the Pn205 (absolute encoder multi-turn limit setting)

Please note that executing a DRV_READ will temporarily disable the Servo Driver Front Panel display.

 **Caution** Be sure that no Parameter Unit or Personal Computer Software is connected to the Servo Driver when executing this command. Otherwise the program task will be paused until the connection of the other device to the Servo Driver is removed.

Arguments: *parameter*

The number of the parameter to be read. Note that the parameter numbers are hexadecimal. For selection = 2, the following data can be read:

- | | |
|---|--------------------------------|
| 0 | Motor type (Fn011-F) |
| 1 | Motor capacity (Fn011-P) |
| 2 | Encoder type (Fn011-E) |
| 3 | Driver specification (Fn011-Y) |

The format of the data can be found in the Servo Driver manual.

selection

The selection of the parameter type of the Servo Driver to be read.

- | | |
|---|---|
| 0 | Pn parameter |
| 1 | Un parameter |
| 2 | Fn011 function information (Servomotor specification) |

If the selection argument is omitted, the Pn parameter will be read.

See also: DRV_WRITE, HEX (PRINT), hexadecimal input (\$)

- Examples:**
- Example 1**
Reading the “Input signal selection 1” parameter, which contains a hexadecimal selection value.

```
>> VR(0)=DRV_READ($50A)
>> PRINT HEX(VR(0))
2881
```

Reading the “Speed loop gain” parameter, which contains an integer value.

```
>> PRINT DRV_READ($100)
80
```
- Example 2**
Monitoring cumulative load ratio (Un009) parameter.

```
>> PRINT DRV_READ($009,1)
```
- Example 3**
Reading the capacity of the connected Servomotor from Fn011-P.

```
>> PRINT DRV_READ(1,2)
3.0000
```

Apparently this is a 30 W Servomotor.

6-3-58 DRV_RESET

- Type:** Servo Driver Command
- Syntax:** DRV_RESET
- Alternatives:** EX, INITIALISE
- Description:** The DRV_RESET command will software reset both the Servo Driver as the MC Unit. Execution of DRV_RESET will have the following actions:
- The Servo Driver parameter changes are initiated.
 - Programs will read again from Flash memory and run depending on the RUNTYPE settings. Be sure to write program data to Flash memory before executing the command
 - All data of Table and VR variables is erased and possibly re-read from Flash memory.
 - All axis parameters are set to default.
- During the DRV_RESET communication between the MC Unit and other devices is temporarily not possible. If a connection with Motion Perfect was present, this will disconnect.

 **Caution** Be sure that no Parameter Unit or Personal Computer Software is connected to the Servo Driver when executing this command. Otherwise the program task will be paused until the connection of the other device to the Servo Driver is removed.

6-3-59 DRV_STATUS

- Type:** Servo Driver Parameter
- Description:** The DRV_STATUS parameter contains the current servo alarm code of the Servo Driver. The alarm codes are given as hexadecimal values. No alarm will return value 99 Hex. Please refer to *8-2 Error Handling* for further details on Servo Driver alarms.
- Note** This parameter is read-only.
- See also:** DRV_CLEAR, HEX (PRINT)
- Example:** The Servo Driver of this system has an overcurrent alarm:

```
>> PRINT HEX(DRV_STATUS)
10
```

6-3-60 DRV_WRITE**Type:** Servo Driver Command**Syntax:** DRV_WRITE (*parameter, value*)**Description:** The DRV_WRITE command writes a specific value to the specified Pn-type parameter of the Servo Driver. For some parameters the system needs to be powered OFF, and turned ON again. Also the DRV_RESET command can be used.

The Servo Driver Pn parameters are divided into two groups:

- Selection parameters, which contain hexadecimal value. One example is for instance the Pn50A (input signal selection 1)
- Value parameters, which contain integer values. One example is for instance the Pn205 (absolute encoder multi-turn limit setting)

Please note that executing a DRV_WRITE will temporarily disable the Servo Driver Front Panel display.

 **Caution** Be sure that no Parameter Unit or Personal Computer Software is connected to the Servo Driver when executing this command. Otherwise the program task will be paused until the connection of the other device to the Servo Driver is removed.

Arguments: *parameter*

The number of the Pn-parameter to be written. Note that the parameter numbers are hexadecimal.

value

The value to write to the parameter.

See also: DRV_READ, DRV_RESET, hexadecimal input (\$)**Examples:** Writing the "Input signal selection 2" parameter, which contains a hexadecimal selection value.

```
>> DRV_WRITE ($50B, $8883)
```

Reading the "Speed loop integration constant" parameter, which contains an integer value.

```
>> DRV_WRITE ($101, 4000)
```

6-3-61 EDIT**Type:** Program Command**Syntax:** EDIT [*line_number*]**Alternative:** ED [*line_number*]**Description:** The EDIT command starts the built in screen editor allowing a program in the MC Unit memory to be modified using a VT100 Terminal. The currently selected program will be edited.

The editor commands are as follows:

Quit Editor [CTRL] K and D

Delete Line [CTRL] Y

Precautions: This command is implemented for an offline (VT100) terminal. Within Motion Perfect users can select the command from the Program menu.**Arguments:** *line_number*

The number of the line at which to start editing.

See also: SELECT

6-3-62 ENCODER

Type: Axis Parameter

Description: The ENCODER axis parameter contains a raw copy of the encoder.
The MPOS axis parameter contains the measured position calculated from the ENCODER value automatically, allowing for overflows and offsets.

Note This parameter is read-only.

See also: AXIS, MPOS

6-3-63 ENDMOVE

Type: Axis Parameter

Description: The ENDMOVE axis parameter holds the position of the end of the current move in user units. If the SERVO axis parameter is ON, the ENDMOVE parameter can be written to produce a step change in the demand position (DPOS).

Note As the measured position is not changed initially, the following error limit (FE_LIMIT) should be considered. If the change of demanded position is too big, the limit will be exceeded.

See also: AXIS, DPOS, FE_LIMIT, UNITS

6-3-64 EPROM

Type: Program Command

Syntax: EPROM

Description: The EPROM command stores the BASIC programs in the MC Unit in the Flash memory. At each start-up the program data from the Flash memory will be copied to the RAM.

Note Motion Perfect offers this command as a button on the control panel. Also pop-up screens will prompt to write the program data into Flash memory.

See also: FLASHVR, RUNTYPE

6-3-65 ERROR_AXIS

Type: System Parameter

Description: The ERROR_AXIS axis parameter contains the number of the axis which has caused the motion error.

A motion error occurs when the AXISSTATUS state for one of the axes matches the ERRORMASK setting. In this case the enable switch (WDOG) will be turned OFF, the MOTION_ERROR parameter will have value 1 and the ERROR_AXIS parameter will contain the number of the first axis to have the error. Refer to *8-2 Error Handling* for more detailed information on error handling.

Note This parameter is read-only.

See also: AXISSTATUS, ERRORMASK, MOTION_ERROR, WDOG

6-3-66 ERROR_LINE

Type: Task Parameter

Description: The ERROR_LINE parameter contains the number of the line which caused the last BASIC run-time error in the program task. This value is only valid when the BASICERROR parameter is TRUE.

Each task has its own ERROR_LINE parameter. Use the PROC modifier to access the parameter for a certain task. Without PROC the current task will be assumed. Refer to *8-2 Error Handling* for more detailed information on error handling.

Note This parameter is read-only.

See also: BASICERROR, PROC, RUN_ERROR

Example:

```
>> PRINT ERROR_LINE PROC (4)
23.0000
```

6-3-67 ERRORMASK

Type: Axis Parameter

Description: The ERRORMASK axis parameter contains a mask value that is ANDed bit by bit with the AXISSTATUS axis parameter on every servo cycle to determine if a motion error has occurred.

When a motion error occurs the enable switch (WDOG) will be turned OFF, the MOTION_ERROR parameter will have value 1 and the ERROR_AXIS parameter will contain the number of the first axis to have the error.

Check the AXISVALUES parameter for the status bit allocations. The default setting of ERRORMASK is 268. Refer to *8-2 Error Handling* for more detailed information on error handling.

 **Caution** It is up to the user to define in which cases a motion error is generated. For safe operation it is strongly recommended to generate a motion error when the following error has exceeded its limit for the servo axis 0 in all cases. This is done by setting bit 8 of ERRORMASK.

See also: AXIS, AXISSTATUS, ERROR_AXIS, MOTION_ERROR, WDOG

6-3-68 EXP

Type: Mathematical Function

Syntax: EXP (*expression*)

Description: The EXP function returns the exponential value of the *expression*.

Arguments: ***expression***
Any valid BASIC expression.

Example:

```
>> print exp(1.0)
2.7183
```

6-3-69 FALSE

Type: Constant

Description: The FALSE constant returns the numerical value 0.

Note A constant is read-only.

Example:

```
test:
  res = IN(0) OR IN(2)
  IF res = FALSE THEN
    PRINT "Inputs are off"
  ENDF
```

6-3-70 FAST_JOG

Type: Axis Parameter

Description: The FAST_JOG axis parameter contains the input number to be used as the fast jog input. The number can be from 0 to 7. As default the parameter is set to -1, no input is selected.

The fast jog input controls the jog speed between two speeds. If the fast jog input is set, the speed as given by the SPEED axis parameter will be used for jogging. If the input is not set, the speed given by the JOGSPEED axis parameter will be used.

Note This input is active low.

See also: AXIS, FWD_JOG, JOGSPEED, REV_JOG, SPEED

6-3-71 FB_SET

Type: DeviceNet Parameter

Description: The FB_SET DeviceNet parameter sets the Remote I/O Messaging data to be transferred for input word 2. The following settings can be made:

FB_SET	Allocation
0	VR(0)
1	MC Unit I/O mapping
2	Servo Driver I/O mapping

See 4-2-1 Remote I/O Communications for detailed information on bit allocation.

See also: FB_STATUS

6-3-72 FB_STATUS

Type: DeviceNet Parameter

Description: The FB_STATUS DeviceNet parameter returns the status of the communications of the MC Unit with the DeviceNet master. The following values can be returned:

FB_STATUS	Allocation
0	<ul style="list-style-type: none"> • A master has not established the remote I/O connection and does not perform polled data exchange with the MC Unit. • The MC Unit is in a bus-off state. • There is no network power available.
1	<ul style="list-style-type: none"> • A master has established the remote I/O connection and performs polled data exchange with the MC Unit. • The MC Unit is not in a bus-off state. • There is network power available.

See also: FB_SET

6-3-73 FE

Type: Axis Parameter

Description: The FE axis parameter contains the position error in user units. This is calculated by the demand position (DPOS axis parameter) minus the measured position (MPOS axis parameter). The value of the following error can be checked by using the axis parameters FE_LIMIT and FE_RANGE.

Note This parameter is read-only.

See also: AXIS, DPOS, FE_LIMIT, FE_RANGE, MPOS, UNITS

6-3-74 FE_LIMIT

Type: Axis Parameter

Alternative: FELIMIT

Description: The FE_LIMIT axis parameter contains the limit for the maximum allowed following error in user units. When exceeded, bit 8 of the AXISSTATUS parameter of the axis will be set. If the ERRORMASK parameter has been properly set, a motion error will be generated.

This limit is used to guard against fault conditions, such as mechanical lock-up, loss of encoder feedback, etc.

See also: AXIS, AXISSTATUS, ERRORMASK, FE, FE_RANGE, UNITS

6-3-75 FE_RANGE

Type: Axis Parameter

Alternative: FERANGE

Description: The FE_RANGE axis parameter contains the limit for the following error warning range in user units. When the following error exceeds this value on a servo axis, bit 1 in the AXISSTATUS axis parameter will be turned ON.

This range is used as a first indication for fault conditions in the application (compare FE_LIMIT).

See also: AXIS, AXISSTATUS, ERRORMASK, FE, FE_LIMIT, UNITS

6-3-76 FHOLD_IN

Type: Axis Parameter

Alternative: FH_IN

Description: The FHOLD_IN axis parameter contains the input number to be used as the feedhold input. The number can be from 0 to 7. As default the parameter is set to -1, no input is selected.

If an input number is set and the feedhold input turns set, the speed of the move on the axis is changed to the value set in the FH_SPEED axis parameter. The current move is NOT cancelled. Furthermore, bit 7 of the AXISSTATUS parameter is set. When the input turns reset again, any move in progress when the input was set will return to the programmed speed.

Precautions: This feature only works on speed controlled moves. Moves which are not speed controlled (CAMBOX, CONNECT and MOVELINK) are not affected.

Note This input is active low.

See also: AXIS, AXISSTATUS, FHSPEED

6-3-77 FHSPEED

Type: Axis Parameter

Description: The FHSPEED axis parameter contains the feedhold speed. This parameter can be set to a value in user units/s at which speed the axis will move when the feed-hold input turns ON. The current move is not cancelled. FHSPEED can have any positive value including zero. The default value is zero.

Precautions: This feature only works on speed controlled moves. Moves which are not speed controlled (CAMBOX, CONNECT and MOVELINK) are not affected.

See also: AXIS, FHOLD_IN, UNITS

6-3-78 FLASHVR

Type: System Command

Syntax: FLASHVR (*address*)

Description: The FLASHVR command is used to store VR or Table variable data into the Flash memory. After the data has been stored, at each power up the VR and Table data will be restored to the values held in Flash memory. Storing the data in Flash memory for this Unit is required as data in RAM is not contained when power is down. The command will write either a single VR variable or the entire Table array.

Although the Table array is updated correctly with the Flash memory data at start-up, the Table pointer (TSIZE parameter) is zero. To able to access the Table data, a write operation needs to be performed to the Table variable with address one higher than the highest variable used.

- Note**
1. When the entire Table array is restored from Flash memory at start-up, the Table has not yet been initialised. To initialise the Table for the range used in the application, write a value to the Table variable with address one higher than used. From that moment the Table variables can be accessed.
 2. Each FLASHVR command generates a write to a block of the Flash memory. Although this memory allows numerous writes and erases, it has a limited life cycle. Programmers should be aware of this fact and use the command as limited as possible.

Arguments: **address**
The address of the VR variable. Range: [0, 250]. To write the Table data into the following options are used

FLASHVR(-1)	Write entire Table array
FLASHVR(-2)	Cancel update of Table data at start-up

See also: EPROM

6-3-79 FOR TO STEP NEXT

Type: Structural Command

Syntax: FOR *variable* = *start* TO *end* [STEP *increment*]
 <commands>
NEXT *variable*

Description: The FOR ... NEXT loop allows the program segment between the FOR and the NEXT statement to be repeated a number of times.

On entering this loop, the *variable* is initialized to the value of *start* and the block of commands is then executed. Upon reaching the NEXT command, the *variable* is increased by the *increment* specified after STEP. The STEP value can be positive or negative, if omitted the value is assumed to be 1.

While *variable* is less than or equal to *end*, the block of commands is repeatedly executed until *variable* is greater than *end*, at which time program execution will continue after NEXT.

Precautions: FOR ... NEXT statements can be nested up to 8 levels deep in a BASIC program.

Arguments: **variable**
Any valid BASIC expression.
start
Any valid BASIC expression.
end
Any valid BASIC expression.
increment
Any valid BASIC expression.

See also: REPEAT, WHILE

Examples:**Example 1**

The following loop turns ON outputs 8 to 13.

```
FOR opnum = 8 TO 13
  OP (opnum, ON)
NEXT opnum
```

Example 2

The STEP increment can be positive or negative.

```
loop:
  FOR dist = 5 TO -5 STEP -0.25
    MOVEABS (dist)
    GOSUB pick_up
  NEXT dist
```

Example 3

FOR...NEXT statements can be nested (up to 8 levels deep) provided the inner FOR and NEXT commands are both within the outer FOR...NEXT loop:

```
loop1:
  FOR i1 = 1 TO 8
loop2:
  FOR i2 = 1 TO 6
    MOVEABS (i1*100, i2*100)
    GOSUB 1000
  NEXT i2
NEXT i1
```

6-3-80 FORWARD

Type: Motion Control Command

Syntax: FORWARD

Alternative: FO

Description: The FORWARD command moves an axis continuously forward at the speed set in the SPEED axis parameter. The acceleration rate is defined by the ACCEL axis parameter.

FORWARD works on the default basis axis (set with BASE) unless AXIS is used to specify a temporary base axis.

Precautions: The forward motion can be stopped by executing the CANCEL or RAPID-STOP command, or by reaching the forward limit.

See also: AXIS, CANCEL, RAPIDSTOP, REVERSE, UNITS

Example:

```
start:
  FORWARD
  WAIT UNTIL IN(0) = ON 'Wait for stop signal
  CANCEL
```

6-3-81 FRAC

Type: Mathematical Function

Syntax: FRAC (*expression*)

Description: The FRAC function returns the fractional part of the *expression*.

Arguments: ***expression***
Any valid BASIC expression.

Example:

```
>> PRINT FRAC (1.234)
0.2340
```

6-3-82 FREE

Type: System Function

Syntax: FREE

Description: The FREE function returns the remaining amount of memory available for user programs and Table array elements.

Precautions: Each line takes a minimum of 4 characters (bytes) in memory. This is for the length of this line, the length of the previous line, number of spaces at the beginning of the line and a single command token. Additional commands need one byte per token; most other data is held as ASCII.
The MC Unit compiles programs before they are executed, this means that twice the memory is required to be able to execute a program.

Example:
>> PRINT FREE
47104.0000

6-3-83 FS_LIMIT

Type: Axis Parameter

Alternative: FSLIMIT

Description: The FS_LIMIT axis parameter contains the absolute position of the forward software limit in user units.

A software limit for forward movement can be set from the program to control the working range of the machine. When the limit is reached, the MC Unit will decelerate to zero, and then cancel the move. Bit 9 of the AXISSTATUS axis parameter will be turned ON while the axis position is greater than FS_LIMIT.

See also: AXIS, AXISSTATUS, RS_LIMIT, UNITS

6-3-84 FWD_IN

Type: Axis Parameter

Description: The FWD_IN axis parameter contains the input number to be used as a forward limit input. The number can be set from 0 to 7 and 18. Range 0 to 7 is used to select one of the MC Unit inputs. Defining value 18 will select the Servo Driver's POT (Forward drive prohibited, CN1 pin 42) input. As default the parameter is set to -1, no input is selected.

If an input number is set and the limit is reached, any forward motion on that axis will be stopped. Bit 4 of the AXISSTATUS will also be set.

Note This input is active low.

See also: AXIS, AXISSTATUS, REV_IN

6-3-85 FWD_JOG

Type: Axis Parameter

Description: The FWD_JOG axis parameter contains the input number to be used as a jog forward input. The input can be set from 0 to 7. As default the parameter is set to -1, no input is selected.

Note This input is active low.

See also: AXIS, FAST_JOG, JOGSPEED, REV_JOG

6-3-86 GET

Type: I/O Command

Syntax: GET [#n,] *variable*

Description: The GET command assigns the ASCII code of a received character to a variable. If the serial port buffer is empty, program execution will be paused until a character has been received. Channels 5 to 7 are logical channels that are

superimposed on the RS-232C programming port 0 when using Motion Perfect.

- Arguments:** *n*
The specified input device. When this argument is omitted, the port as specified by INDEVICE will be used.
- 0 RS-232C programming port 0
 - 1 RS-232C serial port 1
 - 2 RS-422A/485 serial port 2
 - 5 Motion Perfect port 0 user channel 5
 - 6 Motion Perfect port 0 user channel 6
 - 7 Motion Perfect port 0 user channel 7
- variable**
The name of the variable to receive the ASCII code.
- Precautions:** Channel 0 is reserved for the connection to Motion Perfect and/or the command line interface. Please be aware that this channel may give problems for this function.
- See also:** INDEVICE, INPUT, KEY, LINPUT
- Example:** The following line can be used to store the ASCII character received on the Motion Perfect port channel 5 in k.
GET#5, k

6-3-87 GOSUB RETURN

- Type:** Structural Command
- Syntax:** GOSUB *label* ... RETURN
- Description:** The GOSUB structure enables a subroutine jump. GOSUB stores the position of the line after the GOSUB command and then jumps to the specified *label*. Upon reaching the RETURN statement, program execution is returned to the stored position. Labels can be character strings of any length, but only the first 15 characters are significant.
- Precautions:** Subroutines on each task can be nested up to 8 levels deep.
- Arguments:** *label*
A valid label that occurs in the program. An invalid label will give a compilation error before execution.
- See also:** GOTO
- Example:**
- ```
main:
 GOSUB routine
 GOTO main
routine:
 PRINT "Measured position=";MPOS;CHR(13);
 RETURN
```

### 6-3-88 GOTO

- Type:** Structural Command
- Syntax:** GOTO *label*
- Description:** The GOTO structure enables a jump of program execution. GOTO jumps program execution to the line of the program containing the *label*. Labels can be character strings of any length, but only the first 15 characters are significant.

|                   |                                                                                                                            |
|-------------------|----------------------------------------------------------------------------------------------------------------------------|
| <b>Arguments:</b> | <b>label</b><br>A valid label that occurs in the program. An invalid label will give a compilation error before execution. |
| <b>See also:</b>  | GOSUB                                                                                                                      |
| <b>Example:</b>   | <pre>loop:   PRINT "Measured position = ";MPOS;CHR(13);   GOTO loop</pre>                                                  |

### 6-3-89 HALT

|                     |                                                                                                                                                                                                   |
|---------------------|---------------------------------------------------------------------------------------------------------------------------------------------------------------------------------------------------|
| <b>Type:</b>        | System Command                                                                                                                                                                                    |
| <b>Syntax:</b>      | HALT                                                                                                                                                                                              |
| <b>Description:</b> | The HALT command stops execution of all program tasks currently running. The command can be used both on command line as in programs. The STOP command can be used to stop a single program task. |
| <b>See also:</b>    | PROCESS, STOP                                                                                                                                                                                     |

### 6-3-90 HLM\_COMMAND

|                           |                                                                                                                                                                                                                                                                                                                                                                                                                                                                                                                                                                                                                                                                                                                                                                                                                                                                                                                                                                                                                                                                                                                                                                              |                           |                                                                                                                                                                                          |                          |                                                                                                                                                                                                    |                           |                                                                                                                                                                 |                          |                                                                                                                          |                          |                                                                                                     |
|---------------------------|------------------------------------------------------------------------------------------------------------------------------------------------------------------------------------------------------------------------------------------------------------------------------------------------------------------------------------------------------------------------------------------------------------------------------------------------------------------------------------------------------------------------------------------------------------------------------------------------------------------------------------------------------------------------------------------------------------------------------------------------------------------------------------------------------------------------------------------------------------------------------------------------------------------------------------------------------------------------------------------------------------------------------------------------------------------------------------------------------------------------------------------------------------------------------|---------------------------|------------------------------------------------------------------------------------------------------------------------------------------------------------------------------------------|--------------------------|----------------------------------------------------------------------------------------------------------------------------------------------------------------------------------------------------|---------------------------|-----------------------------------------------------------------------------------------------------------------------------------------------------------------|--------------------------|--------------------------------------------------------------------------------------------------------------------------|--------------------------|-----------------------------------------------------------------------------------------------------|
| <b>Type:</b>              | Host Link Command                                                                                                                                                                                                                                                                                                                                                                                                                                                                                                                                                                                                                                                                                                                                                                                                                                                                                                                                                                                                                                                                                                                                                            |                           |                                                                                                                                                                                          |                          |                                                                                                                                                                                                    |                           |                                                                                                                                                                 |                          |                                                                                                                          |                          |                                                                                                     |
| <b>Syntax:</b>            | HLM_COMMAND ( <i>command</i> , <i>port</i> [ , <i>node</i> [ , <i>mc_area/mode</i> [ , <i>mc_offset</i> ]]])                                                                                                                                                                                                                                                                                                                                                                                                                                                                                                                                                                                                                                                                                                                                                                                                                                                                                                                                                                                                                                                                 |                           |                                                                                                                                                                                          |                          |                                                                                                                                                                                                    |                           |                                                                                                                                                                 |                          |                                                                                                                          |                          |                                                                                                     |
| <b>Description:</b>       | <p>The HLM_COMMAND command performs a specific Host Link command operation to one or to all Host Link Slaves on the selected port. Program execution will be paused until the response string has been received or the timeout time has elapsed. The timeout time is specified by using the HLM_TIMEOUT parameter. The status of the transfer can be monitored with the HLM_STATUS parameter.</p>                                                                                                                                                                                                                                                                                                                                                                                                                                                                                                                                                                                                                                                                                                                                                                            |                           |                                                                                                                                                                                          |                          |                                                                                                                                                                                                    |                           |                                                                                                                                                                 |                          |                                                                                                                          |                          |                                                                                                     |
| <b>Note</b>               | <ol style="list-style-type: none"> <li>1. When using the HLM_READ, be sure to set-up the Host Link Master protocol by using the SETCOM command.</li> <li>2. The Host Link Master commands are required to be executed from one program task only to avoid any multi-task timing problems.</li> </ol>                                                                                                                                                                                                                                                                                                                                                                                                                                                                                                                                                                                                                                                                                                                                                                                                                                                                         |                           |                                                                                                                                                                                          |                          |                                                                                                                                                                                                    |                           |                                                                                                                                                                 |                          |                                                                                                                          |                          |                                                                                                     |
| <b>Arguments:</b>         | <p><b>command</b><br/>The selection of the Host Link operation to perform:</p> <table> <tr> <td>HLM_MREAD<br/>(or value 0)</td> <td>This performs the Host Link PC MODEL READ (MM) command to read the CPU Unit model code. The result is written to the MC Unit variable specified by <i>mc_area</i> and <i>mc_offset</i>.</td> </tr> <tr> <td>HLM_TEST<br/>(or value 1)</td> <td>This performs the Host Link TEST (TS) command to check correct communication by sending string "MCW151 TEST STRING" and checking the echoed string. Check the HLM_STATUS parameter for the result.</td> </tr> <tr> <td>HLM_ABORT<br/>(or value 2)</td> <td>This performs the Host Link ABORT (XZ) command to abort the Host Link command that is currently being processed. The ABORT command does not receive a response.</td> </tr> <tr> <td>HLM_INIT<br/>(or value 3)</td> <td>This performs the Host Link INITIALIZE (**) command to initialize the transmission control procedure of all Slave Units.</td> </tr> <tr> <td>HLM_STWR<br/>(or value 4)</td> <td>This performs the Host Link STATUS WRITE (SC) command to change the operating mode of the CPU Unit.</td> </tr> </table> | HLM_MREAD<br>(or value 0) | This performs the Host Link PC MODEL READ (MM) command to read the CPU Unit model code. The result is written to the MC Unit variable specified by <i>mc_area</i> and <i>mc_offset</i> . | HLM_TEST<br>(or value 1) | This performs the Host Link TEST (TS) command to check correct communication by sending string "MCW151 TEST STRING" and checking the echoed string. Check the HLM_STATUS parameter for the result. | HLM_ABORT<br>(or value 2) | This performs the Host Link ABORT (XZ) command to abort the Host Link command that is currently being processed. The ABORT command does not receive a response. | HLM_INIT<br>(or value 3) | This performs the Host Link INITIALIZE (**) command to initialize the transmission control procedure of all Slave Units. | HLM_STWR<br>(or value 4) | This performs the Host Link STATUS WRITE (SC) command to change the operating mode of the CPU Unit. |
| HLM_MREAD<br>(or value 0) | This performs the Host Link PC MODEL READ (MM) command to read the CPU Unit model code. The result is written to the MC Unit variable specified by <i>mc_area</i> and <i>mc_offset</i> .                                                                                                                                                                                                                                                                                                                                                                                                                                                                                                                                                                                                                                                                                                                                                                                                                                                                                                                                                                                     |                           |                                                                                                                                                                                          |                          |                                                                                                                                                                                                    |                           |                                                                                                                                                                 |                          |                                                                                                                          |                          |                                                                                                     |
| HLM_TEST<br>(or value 1)  | This performs the Host Link TEST (TS) command to check correct communication by sending string "MCW151 TEST STRING" and checking the echoed string. Check the HLM_STATUS parameter for the result.                                                                                                                                                                                                                                                                                                                                                                                                                                                                                                                                                                                                                                                                                                                                                                                                                                                                                                                                                                           |                           |                                                                                                                                                                                          |                          |                                                                                                                                                                                                    |                           |                                                                                                                                                                 |                          |                                                                                                                          |                          |                                                                                                     |
| HLM_ABORT<br>(or value 2) | This performs the Host Link ABORT (XZ) command to abort the Host Link command that is currently being processed. The ABORT command does not receive a response.                                                                                                                                                                                                                                                                                                                                                                                                                                                                                                                                                                                                                                                                                                                                                                                                                                                                                                                                                                                                              |                           |                                                                                                                                                                                          |                          |                                                                                                                                                                                                    |                           |                                                                                                                                                                 |                          |                                                                                                                          |                          |                                                                                                     |
| HLM_INIT<br>(or value 3)  | This performs the Host Link INITIALIZE (**) command to initialize the transmission control procedure of all Slave Units.                                                                                                                                                                                                                                                                                                                                                                                                                                                                                                                                                                                                                                                                                                                                                                                                                                                                                                                                                                                                                                                     |                           |                                                                                                                                                                                          |                          |                                                                                                                                                                                                    |                           |                                                                                                                                                                 |                          |                                                                                                                          |                          |                                                                                                     |
| HLM_STWR<br>(or value 4)  | This performs the Host Link STATUS WRITE (SC) command to change the operating mode of the CPU Unit.                                                                                                                                                                                                                                                                                                                                                                                                                                                                                                                                                                                                                                                                                                                                                                                                                                                                                                                                                                                                                                                                          |                           |                                                                                                                                                                                          |                          |                                                                                                                                                                                                    |                           |                                                                                                                                                                 |                          |                                                                                                                          |                          |                                                                                                     |

**port**

The specified serial port.

- 1 RS-232C serial port 1
- 2 RS-422A serial port 2

**node (for HLM\_MREAD, HLM\_TEST, HLM\_ABORT and HLM\_STWR)**

The Slave node number to send the Host Link command to. Range: [0, 31].

**mode (for HLM\_STWR)**

The specified CPU Unit operating mode.

- 0 PROGRAM mode
- 2 MONITOR mode
- 3 RUN mode

**mc\_area (for HLM\_MREAD)**

The MC Unit's memory selection to read the send data from.

| MC_area                  | Data area                  |
|--------------------------|----------------------------|
| MC_TABLE<br>(or value 8) | Table variable array       |
| MC_VR<br>(or value 9)    | Global (VR) variable array |

**mc\_offset (for HLM\_MREAD)**

The address of the specified MC Unit memory area to read from. Range for VR variables: [0, 250]. Range for Table variables: [0, 7999].

**See also:**

HLM\_READ, HLM\_STATUS, HLM\_TIMEOUT, HLM\_WRITE, SETCOM

**Examples:**

**Example 1:**

The following command will read the CPU Unit model code of the Host Link Slave with node address 12 connected to the RS-232C port. The result is written to VR(233).

```
HLM_COMMAND (HLM_MREAD, 1, 12, MC_VR, 233)
```

If the connected Slave is a C200HX PC, the VR(233) will contain value 12 (hex) after successful execution.

**Example 2:**

The following command will check the Host Link communication with the Host Link Slave (node 23) connected to the RS-422A port.

```
HLM_COMMAND (HLM_TEST, 2, 23)
PRINT HLM_STATUS PORT (2)
```

If the HLM\_STATUS parameter contains value zero, the communication is functional.

**Example 3:**

The following two commands will perform the Host Link INITIALIZE and ABORT operations on the RS-422A port 2. The Slave has node number 4.

```
HLM_COMMAND (HLM_INIT, 2)
HLM_COMMAND (HLM_ABORT, 2, 4)
```

**Example 4:**

When data has to be written to a PC using Host Link, the CPU Unit can not be in RUN mode. The HLM\_COMMAND command can be used to set it to MONITOR mode. The Slave has node address 0 and is connected to the RS-232C port.

```
HLM_COMMAND (HLM_STWR, 2, 0, 2)
```



### 6-3-91 HLM\_READ

**Type:** Host Link Command

**Syntax:** HLM\_READ (*port, node, pc\_area, pc\_offset, length, mc\_area, mc\_offset*)

**Description:** The HLM\_READ command reads data from a Host Link Slave by sending a Host Link command string containing the specified node of the Slave to the serial port. The received response data will be written to either VR or Table variables. Each word of data will be transferred to one variable. The maximum data length is 30 words (single frame transfer).

Program execution will be paused until the response string has been received or the timeout time has elapsed. The timeout time is specified by using the HLM\_TIMEOUT parameter. The status of the transfer can be monitored with the HLM\_STATUS parameter.

- Note**
1. When using the HLM\_READ, be sure to set-up the Host Link Master protocol by using the SETCOM command.
  2. The Host Link Master commands are required to be executed from one program task only to avoid any multi-task timing problems.

**Arguments:** *port*

The specified serial port.

- 1 RS-232C serial port 1
- 2 RS-422A serial port 2

**node**

The Slave node number to send the Host Link command to. Range: [0, 31].

**pc\_area**

The PC memory selection for the Host Link command.

| pc_area                | Data area   | Host Link command |
|------------------------|-------------|-------------------|
| PLC_DM<br>(or value 0) | DM area     | RD                |
| PLC_IR<br>(or value 1) | CIO/IR area | RR                |
| PLC_LR<br>(or value 2) | LR area     | RL                |
| PLC_HR<br>(or value 3) | HR area     | RH                |
| PLC_AR<br>(or value 4) | AR area     | RJ                |
| PLC_EM<br>(or value 6) | EM area     | RE                |

**pc\_offset**

The address of the specified PC memory area to read from. Range: [0, 9999].

**length**

The number of words of data to be transferred. Range: [1, 30].

**mc\_area**

The MC Unit's memory selection to write the received data to.

| MC_area                  | Data area                  |
|--------------------------|----------------------------|
| MC_TABLE<br>(or value 8) | Table variable array       |
| MC_VR<br>(or value 9)    | Global (VR) variable array |

**mc\_offset**

The address of the specified MC Unit memory area to write to. Range for VR variables: [0, 250]. Range for Table variables: [0, 7999].

**See also:** HLM\_COMMAND, HLM\_STATUS, HLM\_TIMEOUT, HLM\_WRITE, SETCOM

**Example:** The following example shows how to read 20 words from the PC DM area addresses 120-139 to MC Unit's Table addresses 4000-4019. The PC has Slave node address 17 and is connected to the RS-422A port.

```
HLM_READ (2, 17, PLC_DM, 120, 20, MC_TABLE, 4000)
```

**6-3-92 HLM\_STATUS**

**Type:** Host Link Parameter

**Syntax:** HLM\_STATUS PORT (*n*)

**Description:** The HLM\_STATUS parameter contains the status of the last Host Link Master command sent to the specified port. The parameter will indicate the status for the HLM\_READ, HLM\_WRITE and HLM\_COMMAND commands. The status bits are defined in the following table.

| Bit   | Name                   | Description                                                                                                                                                                                                                       |
|-------|------------------------|-----------------------------------------------------------------------------------------------------------------------------------------------------------------------------------------------------------------------------------|
| 0 - 7 | End code               | The end code can be either the end code which is defined by the Host Link Slave (problem in sent command string) or an end code defined because of a problem found by the Host Link Master (problem in received response string). |
| 8     | Timeout error          | A timeout error will occur if no response has been received within the timeout time. This indicates communication has been lost.                                                                                                  |
| 9     | Command not recognized | This status indicates that the Slave did not recognize the command and has returned a IC response.                                                                                                                                |

The HLM\_STATUS will have value 0 when no problems did occur. In case of a non-zero value, any appropriate action such as a re-try or emergency stop needs to be programmed in the user BASIC program.

Each port has an HLM\_STATUS parameter. The PORT modifier is required to specify the port.

**Arguments:** *n*

The specified serial port.

- 1 RS-232C serial port 1
- 2 RS-422A serial port 2

**See also:** HLM\_COMMAND, HLM\_READ, HLM\_TIMEOUT, HLM\_WRITE

**Examples:** **Example 1:**

```
>> HLM_WRITE (1, 28, PLC_EM, 50, 25, MC_VR, 200)
>> PRINT HEX (HLM_STATUS PORT (1))
1
```

Apparently the CPU Unit is in RUN mode and does not accept the write operation.

**Example 2:**

```
>> HLM_COMMAND (HLM_TEST, 2, 0)
>> PRINT HLM_STATUS PORT (2)
256.0000
```

A timeout error has occurred.

**6-3-93 HLM\_TIMEOUT**

**Type:** Host Link Parameter

**Description:** The HLM\_TIMEOUT parameter specifies the fixed timeout time for the Host Link Master protocol for both serial ports. A timeout error will occur when the time needed to both send the command and receive the response from the Slave is longer than the time specified with this parameter.

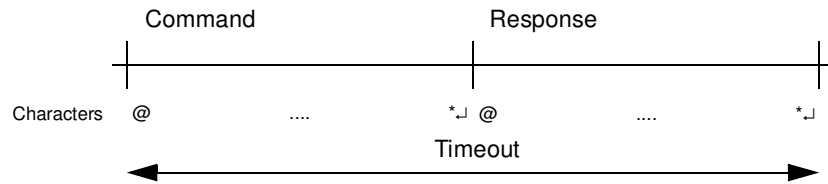

The parameter applies for the HLM\_READ, HLM\_WRITE and HLM\_COMMAND commands. The HLM\_TIMEOUT parameter is specified in servo periods.

**See also:** HLM\_COMMAND, HLM\_READ, HLM\_STATUS, HLM\_WRITE, SERVO\_PERIOD

**Example:** Consider the servo period of the MC Unit is set to 500 ms (SERVO\_PERIOD=500).

```
>> HLM_TIMEOUT=2000
```

For both serial ports the Host Link Master timeout time has been set to 1 s.

### 6-3-94 HLM\_WRITE

**Type:** Host Link Command

**Syntax:** HLM\_WRITE (*port, node, pc\_area, pc\_offset, length, mc\_area, mc\_offset*)

**Description:** The HLM\_WRITE command writes data from the MC Unit to a Host Link Slave by sending a Host Link command string containing the specified node of the Slave to the serial port. The received response data will be written from either VR or Table variables. Each variable will define on word of data which will be transferred. The maximum data length is 29 words (single frame transfer).

Program execution will be paused until the response string has been received or the timeout time has elapsed. The timeout time is specified by using the HLM\_TIMEOUT parameter. The status of the transfer can be monitored with the HLM\_STATUS parameter.

- Note**
1. When using the HLM\_READ, be sure to set-up the Host Link Master protocol by using the SETCOM command.
  2. The Host Link Master commands are required to be executed from one program task only to avoid any multi-task timing problems.

**Arguments:** *port*  
The specified serial port.

- 1 RS-232C serial port 1
- 2 RS-422A serial port 2

**node**  
The Slave node number to send the Host Link command to. Range: [0, 31].

**pc\_area**

The PC memory selection for the Host Link command.

| pc_area                | Data area   | Host Link command |
|------------------------|-------------|-------------------|
| PLC_DM<br>(or value 0) | DM area     | RD                |
| PLC_IR<br>(or value 1) | CIO/IR area | RR                |
| PLC_LR<br>(or value 2) | LR area     | RL                |
| PLC_HR<br>(or value 3) | HR area     | RH                |
| PLC_AR<br>(or value 4) | AR area     | RJ                |
| PLC_EM<br>(or value 6) | EM area     | RE                |

**pc\_offset**

The address of the specified PC memory area to write to. Range: [0, 9999].

**length**

The number of words of data to be transferred. Range: [1, 29].

**mc\_area**

The MC Unit's memory selection to read the send data from.

| MC_area                  | Data area                  |
|--------------------------|----------------------------|
| MC_TABLE<br>(or value 8) | Table variable array       |
| MC_VR<br>(or value 9)    | Global (VR) variable array |

**mc\_offset**

The address of the specified MC Unit memory area to read from. Range for VR variables: [0, 250]. Range for Table variables: [0, 7999].

**See also:** HLM\_COMMAND, HLM\_READ, HLM\_STATUS, HLM\_TIMEOUT, SETCOM

**Example:** The following example shows how to write 25 words from MC Unit's VR addresses 200-224 to the PC EM area addresses 50-74. The PC has Slave node address 28 and is connected to the RS-232C port.

```
HLM_WRITE (1, 28, PLC_EM, 50, 25, MC_VR, 200)
```

**6-3-95 HLS\_MODEL**

**Type:** Host Link Parameter

**Description:** The HLS\_MODEL parameter defines the MC Unit model code for the Host Link Slave protocol. When a Host Link Master gives a PC MODEL READ (MM) command, the MC Unit will return the code as defined by this parameter.

The MCW151 has been assigned the model code value FA Hex, which is the default of this parameter. If this model code gives compatibility problems for the Master, another model code can be assigned. The valid range for this parameter is [00, FF] Hex.

**See also:** HLS\_NODE

**6-3-96 HLS\_NODE**

**Type:** Host Link Parameter

**Description:** The HLS\_NODE parameter defines the Slave unit number for the Host Link Slave protocol. The MC Unit will only respond to Host Link Master command strings with the unit number as specified in this parameter. The valid range for this parameter is [0, 31]. The default value is 0.

**See also:** HLS\_MODEL

### 6-3-97 I\_GAIN

**Type:** Axis Parameter

**Description:** The I\_GAIN parameter contains the integral gain for the axis. The integral output contribution is calculated by multiplying the sums of the following errors with the value of the I\_GAIN parameter. The default value is zero.

Adding integral gain to a servo system reduces positioning error when at rest or moving steadily. It can produce or increase overshooting and oscillation and is therefore only suitable for systems working on constant speed and with slow accelerations.

See section 1-4-1 *Servo System Principles* for more details.

**Precautions:** In order to avoid any instability the servo gains should be changed only when the SERVO is OFF.

**See also:** D\_GAIN, OV\_GAIN, P\_GAIN, VFF\_GAIN

### 6-3-98 IF THEN ELSE ENDIF

**Type:** Structural Command

**Syntax:**

```
IF condition THEN
 <commands>
[ELSE
 <commands>]
ENDIF
IF condition THEN <commands>
```

**Description:** The IF..THEN..ELSE..ENDIF structure controls the flow of the program based on the results of the *condition*. If the *condition* is TRUE the commands following THEN up to ELSE (or ENDIF if not included) will be executed. If the condition is FALSE the commands following ELSE will be executed or the program will resume at the line after ENDIF in case no ELSE is included. The ENDIF is used to mark the end of the conditional block.

**Precautions:** IF..THEN [ELSE] ENDIF sequences can be nested without limit. For a multi-line IF..THEN construction, there must not be any statement after THEN. A single-line construction must not use ENDIF.

**Arguments:**

***condition***  
Any logical expression.

***commands***  
Any valid BASIC commands.

**Examples:**

**Example 1**

```
IF MPOS > (0.22 * VR(0)) THEN GOTO exceeds_length
```

**Example 2**

```
IF IN(0) = ON THEN
 count = count + 1
 PRINT "COUNTS = ";count
 fail = 0
ELSE
 fail = fail + 1
ENDIF
```

**6-3-99 IN**

- Type:** I/O Function
- Syntax:** IN (*input\_number* [ ,*final\_input\_number* ])  
IN
- Description:** The IN function returns the value of digital inputs.
- IN(*input\_number*, *final\_input\_number*) will return the binary sum of the group of inputs. The two arguments must be less than 24 apart.
  - IN(*input\_number*) with the value for *input\_number* less than 32 will return the value of the particular channel.
  - IN (without arguments) will return the binary sum of the first 24 inputs (as IN(0,23)).
- Refer to 3-3-2 *Digital I/O* for a description of the various types of output and inputs.
- Arguments:**
- input\_number*.**  
The number of the input for which to return a value. Value: An integer between 0 and 31.
- final\_input\_number*.**  
The number of the last input for which to return a value. Value: An integer between 0 and 31.
- See also:** OP
- Examples:**
- Example 1**  
The following lines can be used to move to the position set on a thumbwheel multiplied by a factor. The thumbwheel is connected to inputs 4, 5, 6 and 7, and gives output in BCD.
- ```
moveLoop:
  MOVEABS (IN (4, 7) *1.5467)
  WAIT IDLE
  GOTO moveLoop
```
- The MOVEABS command is constructed as follows:
Step 1: IN(4,7) will get a number between 0 and 15.
Step 2: The number is multiplied by 1.5467 to get required distance.
Step 3: An absolute move is made to this position.
- Example 2**
In this example a single input is tested:
- ```
test:
 WAIT UNTIL IN(4)=ON `Conveyor is in position when ON
 GOSUB place
```

**6-3-100 INDEVICE**

- Type:** I/O Parameter
- Description:** The INDEVICE parameter defines the default input device. This device will be selected for the input commands when the #n option is omitted. The INDEVICE parameter is task specific. The following values are supported.
- |   |                                      |
|---|--------------------------------------|
| 0 | RS-232C programming port 0 (default) |
| 1 | RS-232C serial port 1                |
| 2 | RS-422A/485 serial port 2            |
| 5 | Motion Perfect port 0 user channel 5 |
| 6 | Motion Perfect port 0 user channel 6 |
| 7 | Motion Perfect port 0 user channel 7 |

**See also:** GET, INPUT, LINPUT, KEY

## 6-3-101 INPUT

**Type:** I/O Command

**Syntax:** INPUT [ #*n* ], *variable* { , *variable* }

**Description:** The INPUT command will assign numerical input string values to the specified variables. Multiple input string values can be requested on one line, separated by commas, or on multiple lines separated by carriage return. The program execution will be paused until the string is terminated with a carriage return <CR> after the last variable has been assigned.

If the string is invalid, the user will be prompted with an error message and the task will be repeated. The maximum amount of inputs on one line has no limit other than the line length.

Channels 5 to 7 are logical channels that are superimposed on the RS-232C programming port 0 when using Motion Perfect.

**Arguments:** *n*

The specified input device. When this argument is omitted, the port as specified by INDEVICE will be used.

- 0 RS-232C programming port 0
- 1 RS-232C serial port 1
- 2 RS-422A/485 serial port 2
- 5 Motion Perfect port 0 user channel 5
- 6 Motion Perfect port 0 user channel 6
- 7 Motion Perfect port 0 user channel 7

***variable***

The variable to write to.

**Precautions:** Channel 0 is reserved for the connection to Motion Perfect and/or the command line interface. Please be aware that this channel may give problems for this function.

**See also:** GET, LINPUT

**Example:** Consider the following program to receive data from the terminal.

```
INPUT#5, num
PRINT#5, "BATCH COUNT=";num[0]
A possible response on the terminal could be:
123<CR>
BATCH COUNT=123
```

## 6-3-102 INT

**Type:** Mathematical Function

**Syntax:** INT (*expression*)

**Description:** The INT function returns the integer part of the *expression*.

**Note** To round a positive number to the nearest integer value take the INT function of the value added by 0.5. Similarly, to round for a negative value subtract 0.5 to the value before applying INT.

**Arguments:** ***expression***  
Any valid BASIC expression.

**Example:**

```
>> PRINT INT(1.79)
1.0000
```

### 6-3-103 JOGSPEED

**Type:** Axis Parameter

**Description:** The JOGSPEED parameter sets the jog speed in user units for an axis. A jog will be performed when a jog input for an axis has been declared and that input is low. A forward jog input and a reverse jog input are available for each axis, respectively set by FWD\_JOG and REV\_JOG. The speed of the jog can be controlled with the FAST\_JOG input.

**See also:** AXIS, FAST\_JOG, FWD\_JOG, REV\_JOG, UNITS

### 6-3-104 KEY

**Type:** I/O Parameter

**Syntax:** KEY [ #*n* ]

**Description:** The KEY parameter returns TRUE or FALSE depending on if a character has been received at the serial port buffer or not. A TRUE result will reset when the character is read with the GET command.

Channels 5 to 7 are logical channels that are superimposed on the RS-232C programming port 0 when using Motion Perfect.

**Argument:** *n*

The specified input device. When this argument is omitted, the port as specified by INDEVICE will be used.

- 0 RS-232C programming port 0
- 1 RS-232C serial port 1
- 2 RS-422A/485 serial port 2
- 5 Motion Perfect port 0 user channel 5
- 6 Motion Perfect port 0 user channel 6
- 7 Motion Perfect port 0 user channel 7

**Precautions:** Channel 0 is reserved for the connection to Motion Perfect and/or the command line interface. Please be aware that this channel may give problems for this function.

**See also:** GET

**Example:** WAIT UNTIL KEY#1  
GET#1, k

Beware that for using KEY#1 in an equation may require parentheses in the statement, in this case: WAIT UNTIL (KEY#1)=TRUE.

### 6-3-105 LAST\_AXIS

**Type:** System Parameter

**Description:** The LAST\_AXIS parameter contains the number of the last axis processed by the system.

Most systems do not use all the available axes. It would therefore be a waste of time to task the idle moves on all axes that are not in use. To avoid this to some extent, the MC Unit will task moves on the axes from 0 to LAST\_AXIS, where LAST\_AXIS is the number of the highest axis for which an AXIS or BASE command has been processed, whichever of the two is larger.

**Note** This parameter is read-only.

**See also:** AXIS, BASE



**6-3-106 LINK\_AXIS**

**Type:** System Parameter

**Description:** The LINK\_AXIS parameter contains the axis number of the link axis during any linked move. Linked moves are defined where the demanded position is a function of another axis (CAMBOX, CONNECT and MOVELINK).

**Note** This parameter is read-only.

**See also:** AXIS, CAMBOX, CONNECT, MOVELINK

**6-3-107 LINPUT**

**Type:** I/O Command

**Syntax:** LINPUT [#*n*, ] *vr\_variable*

**Description:** The LINPUT command assigns the ASCII code of the characters to an array of variables starting with the specified VR variable. Program execution will be paused until the string is terminated with a carriage return <CR>, which is also stored. The string is not echoed by the controller.

Channels 5 to 7 are logical channels that are superimposed on the RS-232C programming port 0 when using Motion Perfect.

**Arguments:**

***n***

The specified input device. When this argument is omitted, the port as specified by INDEVICE will be used.

- 0 RS-232C programming port 0
- 1 RS-232C serial port 1
- 2 RS-422A/485 serial port 2
- 5 Motion Perfect port 0 user channel 5
- 6 Motion Perfect port 0 user channel 6
- 7 Motion Perfect port 0 user channel 7

***vr\_variable***

The first VR-variable to write to.

**Precautions:** Channel 0 is reserved for the connection to Motion Perfect and/or the command line interface. Please be aware that this channel may give problems for this command.

**See also:** GET, INPUT, VR

**Example:** Consider the following line in a program.

```
LINPUT#5, VR(0)
Entering START<CR> will give
VR(0)=83 S
VR(1)=84 T
VR(2)=65 A
VR(3)=82 R
VR(4)=84 T
VR(5)=13 <CR>
```

**6-3-108 LIST**

**Type:** Program Command

**Syntax:** LIST [ "*program\_name*" ]

**Alternative:** TYPE [ "*program\_name*" ]

|                     |                                                                                                                                                                                                                                            |
|---------------------|--------------------------------------------------------------------------------------------------------------------------------------------------------------------------------------------------------------------------------------------|
| <b>Description:</b> | The LIST command prints the current selected program or the program specified by <i>program_name</i> . The program name can also be specified without quotes. If the program name is omitted, the current selected program will be listed. |
| <b>Precautions:</b> | This command is implemented for an offline (VT100) terminal. Within Motion Perfect users can use the Program Editor.                                                                                                                       |
| <b>Arguments:</b>   | <b><i>program_name</i></b><br>The program to be printed.                                                                                                                                                                                   |
| <b>See also:</b>    | SELECT                                                                                                                                                                                                                                     |

### 6-3-109 LN

|                     |                                                                                                                                |
|---------------------|--------------------------------------------------------------------------------------------------------------------------------|
| <b>Type:</b>        | Mathematical Function                                                                                                          |
| <b>Syntax:</b>      | LN ( <i>expression</i> )                                                                                                       |
| <b>Description:</b> | The LN function returns the natural logarithm of the <i>expression</i> . The input expression value must be greater than zero. |
| <b>Arguments:</b>   | <b><i>expression</i></b><br>Any valid BASIC expression.                                                                        |
| <b>Example:</b>     | >> PRINT LN(10)<br>2.3026                                                                                                      |

### 6-3-110 LOCK

|                     |                                                                                                                                                                                                                                                                                                                                            |
|---------------------|--------------------------------------------------------------------------------------------------------------------------------------------------------------------------------------------------------------------------------------------------------------------------------------------------------------------------------------------|
| <b>Type:</b>        | System Command                                                                                                                                                                                                                                                                                                                             |
| <b>Syntax:</b>      | LOCK ( <i>code</i> )<br>UNLOCK ( <i>code</i> )                                                                                                                                                                                                                                                                                             |
| <b>Description:</b> | The LOCK command prevents the program from being viewed, modified or deleted by personnel unaware of the security code. The UNLOCK command allows the locked state to be unlocked. The code number can be any integer and is held in encoded form. LOCK is always an immediate command and can be issued only when the system is UNLOCKED. |

 **WARNING** The security code must be remembered; it will be required to unlock the system. Without the security code the system can not be recovered.

|                   |                                                                                                                 |
|-------------------|-----------------------------------------------------------------------------------------------------------------|
| <b>Arguments:</b> | <b><i>code</i></b><br>Any valid integer with maximum 7 digits.                                                  |
| <b>Example:</b>   | >> LOCK(561234)<br>The programs cannot be modified or seen.<br>>> UNLOCK(561234)<br>The system is now unlocked. |

### 6-3-111 MARK

|                     |                                                                                                                                                                                                                                                                              |
|---------------------|------------------------------------------------------------------------------------------------------------------------------------------------------------------------------------------------------------------------------------------------------------------------------|
| <b>Type:</b>        | Axis Parameter                                                                                                                                                                                                                                                               |
| <b>Description:</b> | The MARK parameter contains value TRUE when a (primary) registration event has occurred to indicate that the value in the REG_POS axis parameter is valid. MARK is set to FALSE when the REGIST command has been executed and is set to TRUE when the register event occurs. |
| <b>Note</b>         | This parameter is read-only.                                                                                                                                                                                                                                                 |
| <b>See also:</b>    | AXIS, REG_POS, REGIST                                                                                                                                                                                                                                                        |

**6-3-112 MARKB**

**Type:** Axis Parameter

**Description:** The MARKB parameter contains value TRUE when a secondary registration event has occurred to indicate that the value in the REG\_POSB axis parameter is valid. MARKB is set to FALSE when the REGIST command has been executed and is set to TRUE when the register event occurs.

**Note** This parameter is read-only.

**See also:** AXIS, REG\_POSB, REGIST

**6-3-113 MERGE**

**Type:** Axis Parameter

**Description:** The MERGE parameter is a software switch that can be used to enable or disable the merging of consecutive moves. With MERGE is ON and the next move already in the next move buffer (NTYPE), the axis will not ramp down to zero speed but will load up the following move enabling a seamless merge. The default setting of MERGE is OFF.

It is up to the programmer to ensure that merging is sensible. For example, merging a forward move with a reverse move will cause an attempted instantaneous change of direction.

MERGE will only function if the following are all true.

1. Only the speed profiled moves MOVE, MOVEABS, MOVECIRC and MOVEMODIFY can be merged with each other.
2. There is a move in the next move buffer (NTYPE).
3. The axis group does not change for multi-axis moves.

When merging multi-axis moves, only the base axis MERGE axis parameter needs to be set.

**Precautions:** If the moves are short, a high deceleration rate must be set to avoid the MC Unit decelerating in anticipation of the end of the buffered move.

**See also:** AXIS

**Example:**

```
MERGE = OFF `Decelerate at the end of each move
MERGE = ON `Moves will be merged if possible
```

**6-3-114 MOD**

**Type:** Mathematical Function

**Syntax:** *expression\_1* MOD *expression\_2*

**Description:** The MOD function returns the *expression\_2* modulus of *expression\_1*. This function will take the integer part of any non-integer input.

**Arguments:**

***expression\_1***  
Any valid BASIC expression.

***expression\_2***  
Any valid BASIC expression.

**Example:**

```
>> PRINT 122 MOD 13
5.0000
```

**6-3-115 MOTION\_ERROR**

**Type:** System Parameter

**Description:** The MOTION\_ERROR parameter contains an error flag for axis motion errors. The parameter will have value 1 when a motion error has occurred.

A motion error occurs when the AXISSTATUS state for one of the axes matches the ERRORMASK setting. In this case the enable switch (WDOG) will be turned OFF, the MOTION\_ERROR parameter will have value 1 and the ERROR\_AXIS parameter will contain the number of the first axis to have the error.

A motion error can be cleared executing a DATUM(0) command.

**Note** This parameter is read-only.

**See also:** AXISSTATUS, DATUM, ERROR\_AXIS, ERRORMASK, WDOG

## 6-3-116 MOVE

**Type:** Motion Control Command

**Syntax:** MOVE (*dist\_1* [ , *dist\_2* [ , *dist\_3* ]])

**Alternative:** MO (*dist\_1* [ , *dist\_2* [ , *dist\_3* ]])

**Description:** The MOVE command moves with one or more axes at the demand speed and acceleration and deceleration to a position specified as increment from the current position. In multi-axis moves the movement is interpolated and the speed, acceleration and deceleration are taken from the base axis.

The specified distances are scaled using the unit conversion factor in the UNITS axis parameter. If, for example, an axis has 4,000 encoder edges/mm, then the number of units for that axis would be set to 4000, and MOVE(12.5) would move 12.5 mm.

MOVE works on the default basis axis group (set with BASE) unless AXIS is used to specify a temporary base axis. Argument *dist\_1* is applied to the base axis, *dist\_2* is applied to the next axis, etc. By changing the axis between individual MOVE commands, uninterpolated, unsynchronised multi-axis motion can be achieved. Incremental moves can be merged for profiled continuous path movements by turning ON the MERGE axis parameter.

Considering a 2-axis movement, the individual speeds are calculated using the equations below. Given command MOVE( $x_1, x_2$ ) and the profiled speed  $v_p$  as calculated from the SPEED, ACCEL and DECEL parameters from the base axis and the total multi-axes distance  $L$ .

$$L = \sqrt{x_1^2 + x_2^2}.$$

The individual speed  $v_i$  for axis  $i$  at any time of the movement is calculated as

$$v_i = \frac{x_i \cdot v_p}{L}.$$

**Arguments:** *dist\_i*

The distance to move for every axis  $i$  in user units starting with the base axis.

**See also:** AXIS, MOVEABS, UNITS

**Examples:** **Example 1**

A system is working with a unit conversion factor of 1 and has a 1000-line encoder. It is, therefore, necessary to use the following command to move 10 turns on the motor. (A 1000 line encoder gives 4000 edges/turn).

```
MOVE (40000)
```

**Example 2**

In this example, axes 0, 1 and 2 are moved independently (without interpolation). Each axis will move at its programmed speed and other axis parameters.

```
MOVE (10) AXIS (0)
```

```
MOVE (10) AXIS (1)
MOVE (10) AXIS (2)
```

**Example 3**

An X-Y plotter can write text at any position within its working envelope. Individual characters are defined as a sequence of moves relative to a start point so that the same commands can be used no matter what the plot position. The command subroutine for the letter “m” might be as follows:

```
m:
MOVE (0, 12) 'move A -> B
MOVE (3, -6) 'move B -> C
MOVE (3, 6) 'move C -> D
MOVE (0, -12) 'move D -> E
```

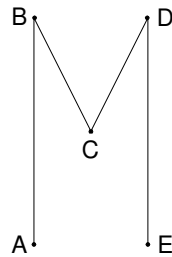

**6-3-117 MOVEABS**

**Type:** Motion Control Command

**Syntax:** MOVEABS (*pos\_1* [ , *pos\_2* [ , *pos\_3* ] ])

**Alternative:** MA (*pos\_1* [ , *pos\_2* [ , *pos\_3* ] ])

**Description:** The MOVEABS command moves one or more axes at the demand speed, acceleration and deceleration to a position specified as absolute position, i.e., in reference to the origin. In multi-axis moves the movement is interpolated and the speed, acceleration and deceleration are taken from the base axis.

The specified distances are scaled using the unit conversion factor in the UNITS axis parameter. If, for example, an axis has 4,000 encoder edges/mm, then the number of units for that axis would be set to 4000, and MOVEABS(12.5) would move to a position 12.5 mm from the origin.

MOVEABS works on the default basis axis group (set with BASE) unless AXIS is used to specify a temporary base axis. Argument *pos\_1* is applied to the base axis, *pos\_2* is applied to the next axis, etc. By changing the axis between individual MOVE commands, uninterpolated, unsynchronised multi-axis motion can be achieved. Absolute moves can be merged for profiled continuous path movements by turning ON the MERGE axis parameter.

Considering a 2-axis movement, the individual speeds are calculated using the equations below. Given command MOVE(*ax*<sub>1</sub>, *ax*<sub>2</sub>), the current position (*ay*<sub>1</sub>, *ay*<sub>2</sub>) and the profiled speed *v<sub>p</sub>* as calculated from the SPEED, ACCEL and DECCEL parameters from the base axis and the total multi-axes distance

$$L = \sqrt{x_1^2 + x_2^2} \quad \text{where } x_i = ax_i - ay_i.$$

The individual speed *v<sub>i</sub>* for axis *i* at any time of the movement is calculated as

$$v_i = \frac{x_i \cdot v_p}{L}.$$

**Arguments:** *pos\_i*

The position to move every axis *i* to in user units starting with the base axis.

**See also:** AXIS, MOVE, UNITS

**Examples:** **Example 1**

An X-Y plotter has a pen carousel whose position is fixed relative to the plotter origin. To change pen, an absolute move to the carousel position will find the target irrespective of the plot position when the command is executed.

```
MOVEABS (20, 350)
```

**Example 2**

A pallet consists of a 6 by 8 grid in which gas canisters are inserted 85mm apart by a packaging machine. The canisters are picked up from a fixed point. The first position in the pallet is defined as position (0,0) using the DEFPOS command. The part of the program to position the canisters in the pallet is as follows:

```
xloop:
FOR x = 0 TO 5
yloop:
 FOR y = 0 TO 7
 MOVEABS (-340,-516.5) 'Move to pick up point
 GOSUB pick 'Go to pick up subroutine
 PRINT "MOVE TO POSITION: ";x*6+y+1
 MOVEABS (x*85,y*85)
 GOSUB place 'Go to place down subroutine
 NEXT y
NEXT x
```

## 6-3-118 MOVECIRC

**Type:** Motion Control Command

**Syntax:** MOVECIRC (*end\_1,end\_2,centre\_1,centre\_2,direction*)

**Alternative:** MC (*end\_1,end\_2,centre\_1,centre\_2,direction*)

**Description:** The MOVECIRC command interpolates 2 orthogonal axes in a circular arc. The path of the movement is determined by the 5 arguments, which are incremental from the current position.

The arguments *end\_1* and *centre\_1* apply to the base axis and *end\_2* and *centre\_2* apply to the following axis. All arguments are given in user units of each axis. The speed of movement along the circular arc is set by the SPEED, ACCEL and DECEL parameters of the base axis.

MOVECIRC works on the default basis axis group (set with BASE) unless AXIS is used to specify a temporary base axis.

**Precautions:** The MOVECIRC computes the radius and the total angle of rotation from the centre, and end-point. If the endpoint does not lie on the calculated path, the move simply ends at the computed end and not the specified end point. It is the responsibility of the programmer to ensure that the two points correspond to correct points on a circle.

For MOVECIRC to be correctly executed, the two axes moving in the circular arc must have the same number of encoder pulses per linear axis distance. If they do not, it is possible to adjust the encoder scales in many cases by adjusting with PP\_STEP axis parameters for the axis.

**Arguments:** ***end\_1***  
The end position for the base axis.

***end\_2***  
The end position for the next axis.

***centre\_1***  
The position around which the base axis is to move.

**centre\_2**

The position around which the next axis is to move.

**direction**

A software switch that determines whether the arc is interpolated in a clockwise or counterclockwise direction. Value: 0 or 1

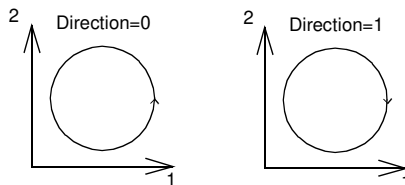

If the two axes involved in the movement form a right-hand axis, set *direction* to 0 to produce positive motion about the third (possibly imaginary) orthogonal axis.

If the two axes involved in the movement form a left-hand axis, set *direction* to 0 to produce negative motion about the third (possibly imaginary) orthogonal axis.

| Direction | Right-hand axis | Left-hand axis |
|-----------|-----------------|----------------|
| 1         | Negative        | Positive       |
| 0         | Positive        | Negative       |

**See also:** AXIS, PP\_STEP, UNITS

**Example:** The command sequence to plot the letter 0 might be as follows:

```

MOVE (0, 6) ' Move A -> B
MOVECIRC (3, 3, 3, 0, 1) ' Move B -> C
MOVE (2, 0) ' Move C -> D
MOVECIRC (3, -3, 0, -3, 1) ' Move D -> E
MOVE (0, -6) ' Move E -> F
MOVECIRC (-3, -3, -3, 0, 1) ' Move F -> G
MOVE (-2, 0) ' Move G -> H
MOVECIRC (-3, 3, 0, 3, 1) ' Move H -> A

```

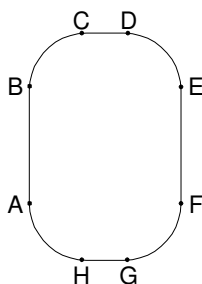

**6-3-119 MOVELINK**

**Type:** Motion Control Command

**Syntax:** MOVELINK (*distance*, *link\_distance*, *link\_acceleration*, *link\_deceleration*, *link\_axis* [, *link\_option* [, *link\_position* ]])

**Alternative:** ML (*distance*, *link\_distance*, *link\_acceleration*, *link\_deceleration*, *link\_axis* [, *link\_option* [, *link\_position* ]])

**Description:** The MOVELINK command creates a linear move on the base axis linked via a software gearbox to the measured position of a link axis. The link axis can move in either direction to drive the output motion.

The parameters indicate what *distance* the base axis will move for a certain distance of the link axis (*link\_distance*). The link axis distance is divided into three phases which apply to the movement of the base axis. These parts are

the acceleration part, the constant speed part and the deceleration part. The link acceleration and deceleration distances are specified by the *link\_acceleration* and *link\_deceleration* parameters. The constant speed link distance is derived from the total link distance and these two parameters.

The three phases can be divided into separate MOVELINK commands or can be added up together into one. Consider the following two rules when setting up the MOVELINK command.

#### Rule 1

In an acceleration and deceleration phase with matching speed, the *link\_distance* must be twice the *distance*.

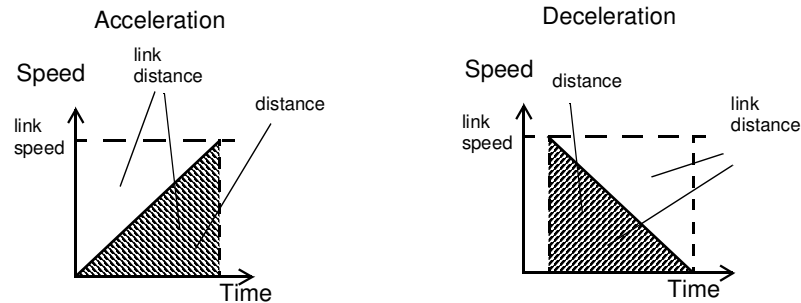

#### Rule 2

In a constant speed phase with matching speeds, the two axes travel the same distance so the *distance* to move must equal the *link\_distance*.

MOVELINK works on the default basis axis group (set with BASE) unless AXIS is used to specify a temporary base axis. The axis set for *link\_axis* drives the base axis.

**Note** If the sum of *link\_acceleration* and *link\_deceleration* is greater than *link\_distance*, they are both reduced in proportion in order to equal the sum to *link\_distance*.

#### Arguments:

##### ***distance***

The incremental distance in user units to move the base axis, as a result of the measured *link\_distance* movement on the link axis.

##### ***link\_distance***

The positive incremental distance in user units that is required to be measured on the link axis to result in the *distance* motion on the base axis.

##### ***link\_acceleration***

The positive incremental distance in user units on the link axis over which the base axis will accelerate.

##### ***link\_deceleration***

The positive incremental distance in user units on the link axis over which the base axis will decelerate.

##### ***link\_axis***

The axis to link to.



**link\_option**

- 1 Link starts when registration event occurs on link axis.
- 2 Link starts at an absolute position on link axis (see *link\_position*).
- 4 MOVELINK repeats automatically and bi-directionally. This option is canceled by setting bit 1 of REP\_OPTION parameter (i.e. REP\_OPTION = REP\_OPTION OR 2).
- 5 Combination of options 1 and 4.
- 6 Combination of options 2 and 4.

**link\_position**

The absolute position where MOVELINK will start when *link\_option* is set to 2

**See also:** AXIS, REP\_OPTION, UNITS

**Example:** A flying shear cuts a roll of paper every 160 m while moving at the speed of the paper. The shear is able to travel up to 1.2 m of which 1 m is used in this example. The paper distance is measured by an encoder, the unit conversion factor being set to give units of metres on both axes. Axis 1 is the link axis.

```

MOVELINK(0,150,0,0,1) `wait distance
MOVELINK(0.4,0.8,0.8,0,1) `accelerate
MOVELINK(0.6,1.0,0,0.8,1) `match speed then decelerate
WAIT UNTIL NTYPE=0 `wait till last move started
OP(8,ON) `activate cutter
MOVELINK(-1,8.2,0.5,0.5,1) `move back

```

In this program, the MC Unit waits for the roll to feed out 150 m in the first line. After this distance, the shear accelerates to match the speed of the paper, coasts at the same speed, then decelerates to a stop within a 1 m stroke. This movement is specified using two separate MOVELINK commands. The program then waits for the next move buffer to be clear NTYPE=0. This indicates that the acceleration phase is complete. The distances on the link axis (*link\_distance*) in the MOVELINK commands are 150, 0.8, 1.0, and 8.2, which add up to 160 m.

To ensure that the speeds and positions of the cutter and paper match during the cut task, the arguments of the MOVELINK command must be correct. Therefore it is easiest to first consider the acceleration, constant speed and deceleration phases separately. As mentioned before the acceleration and deceleration phases require the *link\_distance* to be twice the *distance*. Both phases can therefore be specified as:

```

MOVELINK(0.4,0.8,0.8,0,1) `This move is all accel
MOVELINK(0.4,0.8,0,0.8,1) `This move is all decel

```

In a constant speed phase with matching speeds, the two axes travel the same distance so the distance to move must equal the link distance. The constant speed phase could, therefore, be specified as follows:

```

MOVELINK(0.2,0.2,0,0,1) `This is all constant speed

```

The MOVELINK command allows the three sections to be added by summing the *distance*, *link\_distance*, *link\_acceleration* and *link\_deceleration* for each phase, producing the following command.

```

MOVELINK(1,1.8,0.8,0.8,1)

```

In the program above, the acceleration phase is programmed separately. This is done to be able to perform some action at the end of the acceleration phase.

```

MOVELINK (0.4, 0.8, 0.8, 0, 1)
MOVELINK (0.6, 1.0, 0, 0.8, 1)

```

### 6-3-120 MOVEMODIFY

- Type:** Motion Control Command
- Syntax:** MOVEMODIFY (*position*)
- Alternative:** MM (*position*)
- Description:** The MOVEMODIFY command changes the absolute end position of the current single-axis linear move (MOVE or MOVEABS). If there is no current move or the current move is not a linear move, then MOVEMODIFY is treated as a MOVEABS command. The ENDMOVE parameter will contain the position of the end of the current move in user units.  
MOVEMODIFY works on the default basis axis (set with BASE) unless AXIS is used to specify a temporary base axis.
- Arguments:** *position*  
The absolute position to be set as the new end of move.
- See also:** AXIS, MOVE, MOVEABS, UNITS

### 6-3-121 MPOS

- Type:** Axis Parameter
- Description:** The MPOS parameter is the measured position of the axis in user units as derived from the encoder. This parameter can be set using the DEFPOS command. The OFFPOS axis parameter can also be used to shift the origin point. MPOS is reset to zero at start-up.  
The range of the measured position is controlled with the REP\_DIST and REP\_OPTION axis parameters.
- Note** This parameter is read-only.
- See also:** AXIS, DEFPOS, DPOS, ENCODER, FE, OFFPOS, REP\_DIST, REP\_OPTION, UNITS
- Example:**

```

WAIT UNTIL MPOS >= 1250
SPEED = 2.5

```

### 6-3-122 MSPEED

- Type:** Axis Parameter
- Description:** The MSPEED parameter contains the measured speed in units/s. It is calculated by taking the change in the measured position in user units in the last servo period and divide it by the servo period (in seconds). The servo period is set with the SERVO\_PERIOD parameter.  
MSPEED represents a snapshot of the speed and significant fluctuations, which can occur, particularly at low speeds. It can be worthwhile to average several readings if a stable value is required at low speeds.
- Note** This parameter is read-only.
- See also:** AXIS, SERVO\_PERIOD, VP\_SPEED, UNITS

### 6-3-123 MTYPE

- Type:** Axis Parameter
- Description:** The MTYPE parameter contains the type of move currently being executed. The possible values are given below.
- | Move No. | Move Type |
|----------|-----------|
|----------|-----------|

|    |                |
|----|----------------|
| 0  | IDLE (no move) |
| 1  | MOVE           |
| 2  | MOVEABS        |
| 4  | MOVECIRC       |
| 5  | MOVEMODIFY     |
| 10 | FORWARD        |
| 11 | REVERSE        |
| 12 | DATUM          |
| 13 | CAM            |
| 14 | JOG_FORWARD    |
| 15 | JOG_REVERSE    |
| 20 | CAMBOX         |
| 21 | CONNECT        |
| 22 | MOVELINK       |

MTYPE can be used to determine whether a move has finished or if a transition from one move type to another has taken place.

A non-idle move type does not necessarily mean that the axis is actually moving. It can be at zero speed part way along a move or interpolating with another axis without moving itself.

**Note** This parameter is read-only.

**See also:** AXIS, NTYPE

### 6-3-124 NEW

**Type:** Program Command

**Syntax:** NEW [ "*program\_name*" ]

**Description:** The NEW command deletes all program lines of the program from memory. NEW without a program name can be used to delete the currently selected program (using SELECT). The program name can also be specified without quotes. NEW ALL will delete all programs.

The command can also be used to delete the Table.

NEW "TABLE"

The name "TABLE" must be in quotes.

**Precautions:** This command is implemented for an offline (VT100) terminal. Within Motion Perfect users can select the command from the Program menu.

**See also:** COPY, DEL, RENAME, SELECT, TABLE

### 6-3-125 NIO

**Type:** System Parameter

**Description:** The NIO parameter contains the total number of inputs and outputs of the system.

### 6-3-126 NOT

**Type:** Logical Operator

**Syntax:** NOT *expression*

**Description:** The NOT operator performs the logical NOT function on all bits of the integer part of the expression.

The logical NOT function is defined as follows:

| Bit | Result |
|-----|--------|
| 0   | 1      |
| 1   | 0      |

**Arguments:** *expression*  
Any valid BASIC expression.

**Example:**  

```
>> PRINT 7 AND NOT 1
6.0000
```

### 6-3-127 NTYPE

**Type:** Axis Parameter

**Description:** The NTYPE parameter contains the type of the move in the next move buffer. Once the current move has finished, the move present in the NTYPE buffer will be executed. The values are the same as those for the MTYPE axis parameter.  
NTYPE is cleared by the CANCEL(1) command.

**Note** This parameter is read-only.

**See also:** AXIS, MTYPE

### 6-3-128 OFF

**Type:** Constant

**Description:** The OFF constant returns the numerical value 0.

**Note** A constant is read-only.

**Example:**  

```
OP (lever,OFF)
The above line sets the output named lever to OFF.
```

### 6-3-129 OFFPOS

**Type:** Axis Parameter

**Description:** The OFFPOS parameter contains an offset that will be applied to the demand position (DPOS) without affecting the move in any other way. The measured position will be changed accordingly in order to keep the following error. OFFPOS effectively adjusts the zero position of the axis. The value set in OFFPOS will be reset to zero by the system as the offset is loaded.

**Precautions:** The offset is applied on the next servo period. Other commands may be executed prior to the next servo period. Be sure that these commands do not assume the position shift has occurred. This can be done by using the WAIT UNTIL statement (see example).

**See also:** AXIS, DEFPOS, DPOS, MPOSUNITS

**Example:** The following lines define the current demand position as zero.  

```
OFFPOS = -DPOS
WAIT UNTIL OFFPOS = 0 'Wait until applied
This example is equivalent to DEFPOS(0).
```

### 6-3-130 ON

**Type:** Constant

**Description:** The ON constant returns the numerical value 1.

**Note** A constant is read-only.

**Example:**  

```
OP (lever,ON)
The above line sets the output named lever to ON.
```

**6-3-131 ON**

|                     |                                                                                                                                                                                                                                                                                                                                                              |
|---------------------|--------------------------------------------------------------------------------------------------------------------------------------------------------------------------------------------------------------------------------------------------------------------------------------------------------------------------------------------------------------|
| <b>Type:</b>        | Structural Command                                                                                                                                                                                                                                                                                                                                           |
| <b>Syntax:</b>      | ON <i>expression</i> GOSUB <i>label</i> { , <i>label</i> }<br>ON <i>expression</i> GOTO <i>label</i> { , <i>label</i> }                                                                                                                                                                                                                                      |
| <b>Description:</b> | The ON..GOSUB and ON..GOTO structures enable a conditional jump. The integer <i>expression</i> is used to select a <i>label</i> from the list. If the expression has value 1 the first <i>label</i> is used, for value 2 then the second <i>label</i> is used, and so on. Depending on the GOSUB or GOTO command the subroutine or normal jump is performed. |
| <b>Precautions:</b> | If the expression is not valid, no jump is performed.                                                                                                                                                                                                                                                                                                        |
| <b>Arguments:</b>   | <b><i>expression</i></b><br>Any valid BASIC expression.<br><b><i>label</i></b><br>Any valid label in the program.                                                                                                                                                                                                                                            |
| <b>See also:</b>    | GOSUB, GOTO                                                                                                                                                                                                                                                                                                                                                  |
| <b>Example:</b>     | REPEAT<br>GET#5, char<br>UNTIL 1<=char and char<=3<br>ON char GOSUB mover, stopper, change                                                                                                                                                                                                                                                                   |

**6-3-132 OP**

|                     |                                                                                                                                                                                                                                                                                                                                                                                                                                                                                                                                                                                                                                                                                                                                                                                                                                           |
|---------------------|-------------------------------------------------------------------------------------------------------------------------------------------------------------------------------------------------------------------------------------------------------------------------------------------------------------------------------------------------------------------------------------------------------------------------------------------------------------------------------------------------------------------------------------------------------------------------------------------------------------------------------------------------------------------------------------------------------------------------------------------------------------------------------------------------------------------------------------------|
| <b>Type:</b>        | I/O Function/Command                                                                                                                                                                                                                                                                                                                                                                                                                                                                                                                                                                                                                                                                                                                                                                                                                      |
| <b>Syntax:</b>      | OP ( <i>output_number</i> , <i>value</i> )<br>OP ( <i>binary_pattern</i> )<br>OP                                                                                                                                                                                                                                                                                                                                                                                                                                                                                                                                                                                                                                                                                                                                                          |
| <b>Description:</b> | The OP command sets one or more outputs or returns the state of the first 24 outputs. OP has three different forms depending on the number of arguments. <ul style="list-style-type: none"> <li>• Command OP(<i>output_number</i>,<i>value</i>) sets a single output channel. The range of <i>output_number</i> is between 8 and 17 and <i>value</i> is the value to be output, either 0 or 1.</li> <li>• Command OP(<i>binary_pattern</i>) sets the binary pattern to the 24 outputs according to the value set by <i>binary_pattern</i>.</li> <li>• Function OP (without arguments) returns the status of the first 24 outputs. This allows multiple outputs to be set without corrupting others which are not to be changed.</li> </ul> Refer to 3-3-2 <i>Digital I/O</i> for a description of the various types of output and inputs. |
| <b>Precautions:</b> | The first 8 outputs (0 to 7) do not physically exist on the MC Unit. They can not be written to and will always return 0.                                                                                                                                                                                                                                                                                                                                                                                                                                                                                                                                                                                                                                                                                                                 |
| <b>Arguments:</b>   | <b><i>output_number</i></b><br>The number of the output to be set.<br><b><i>value</i></b><br>The value to be output, either OFF or ON. All non-zero values are considered as ON.<br><b><i>binary_pattern</i></b><br>The integer equivalent of the binary pattern is to be output.                                                                                                                                                                                                                                                                                                                                                                                                                                                                                                                                                         |
| <b>See also:</b>    | IN                                                                                                                                                                                                                                                                                                                                                                                                                                                                                                                                                                                                                                                                                                                                                                                                                                        |
| <b>Examples:</b>    | <b>Example 1</b><br>The following two lines are equivalent.                                                                                                                                                                                                                                                                                                                                                                                                                                                                                                                                                                                                                                                                                                                                                                               |



The parentheses are evaluated first, but only the integer part of the result, 18, is used for the operation. Therefore, this expression is equivalent to the following:

```
result = 10 OR 18
```

The OR is a bit operator and so the binary action taking place is:

|    |       |
|----|-------|
|    | 01010 |
| OR | 10010 |
|    | 11010 |

Therefore, *result* will contain the value 26.

#### Example 2

```
IF KEY OR VR(0) = 2 THEN GOTO label
```

### 6-3-135 OUTDEVICE

- Type:** I/O Parameter
- Description:** The OUTDEVICE parameter defines the default output device. This device will be selected for the PRINT command when the #n option is omitted. The OUTDEVICE parameter is task specific. The following values are supported.
- 0 RS-232C programming port 0 (default)
  - 1 RS-232C serial port 1
  - 2 RS-422A/485 serial port 2
  - 5 Motion Perfect port 0 user channel 5
  - 6 Motion Perfect port 0 user channel 6
  - 7 Motion Perfect port 0 user channel 7

**See also:** PRINT

### 6-3-136 OUTLIMIT

- Type:** Axis Parameter
- Description:** The OUTLIMIT parameter contains the speed reference limit that restricts the speed reference from the MC Unit to the Servo Driver for both servo loop (SERVO=ON) and open loop (SERVO=OFF).  
The default value of OUTLIMIT for axis 0 is 15000. This sets the speed reference range to [-15000, 14999], which is the actual input reference range of the Servo Driver.

**See also:** AXIS, S\_RATE, S\_REF, S\_REF\_OUT, SERVO

### 6-3-137 OV\_GAIN

- Type:** Axis Parameter
- Description:** The OV\_GAIN parameter contains the output velocity gain. The output velocity output contribution is calculated by multiplying the change in measured position with the OV\_GAIN parameter value. The default value is 0.  
Adding output velocity gain to a system is mechanically equivalent to adding damping. It is likely to produce a smoother response and allow the use of a higher proportional gain than could otherwise be used, but at the expense of higher following errors. High values may cause oscillation and produce high following errors.  
See section 1-4-1 *Servo System Principles* for more details.
- Precautions:** In order to avoid any instability the servo gains should be changed only when the SERVO is OFF.

**See also:** AXIS, D\_GAIN, I\_GAIN, P\_GAIN, VFF\_GAIN

### 6-3-138 P\_GAIN

**Type:** Axis Parameter

**Description:** The P\_GAIN parameter contains the proportional gain. The proportional output contribution is calculated by multiplying the following error with the P\_GAIN parameter value. The default value for axis 0 is 0.1.  
The proportional gain sets the 'stiffness' of the servo response. Values that are too high will cause oscillation. Values that are too low will cause large following errors.  
See section 1-4-1 *Servo System Principles* for more details.

**Precautions:** In order to avoid any instability the servo gains should be changed only when the SERVO is OFF.

**See also:** AXIS, D\_GAIN, I\_GAIN, OV\_GAIN, VFF\_GAIN

### 6-3-139 PI

**Type:** Constant

**Description:** The PI constant returns the numerical value 3.1416.

**Note** A constant is read-only.

**Example:**  

```
circum = 100
PRINT "Radius = ";circum/(2*PI)
```

### 6-3-140 PMOVE

**Type:** Task Parameter

**Description:** The PMOVE parameter contains the status of the task buffers. The parameter will return TRUE if the task buffers are occupied, and FALSE if they are empty.

When the task executes a movement command, the task loads the movement information into the task move buffers. The buffers can hold one movement instruction for any group of axes. PMOVE will be set to TRUE when loading of the buffers has been completed. When the next servo interrupt occurs, the motion generator will load the movement into the next move (NTYPE) buffers of the required axes if they are available. When this second transfer has been completed, PMOVE will be cleared to zero until another move is executed in the task.

Each task has its own PMOVE parameter. Use the PROC modifier to access the parameter for a certain task. Without PROC the current task will be assumed.

**Note** This parameter is read-only.

**See also:** NTYPE, PROC

### 6-3-141 PP\_STEP

**Type:** Axis Parameter

**Description:** The PP\_STEP parameter contains an integer value that scales the incoming raw encoder count. The incoming raw encoder count will be multiplied by PP\_STEP before being applied. Scaling can be used to match encoders to high-resolution motors for position verification or for moving along circular arcs on machines where the number of encoder edges/distance is not the same on the axes.

The valid range is [-1023, -1] and [1, 1023]. Default is value 1.



**Precautions:** Changing the PP\_STEP value will influence the position control loop. Modify the control gains accordingly.

**See also:** AXIS, MOVECIRC, UNITS

**Example:** A motor has 20,000 steps/rev. The MC Unit will thus internally process 40,000 counts/rev. A 2,500-pulse encoder is to be connected. This will generate 10,000 edge counts/rev. A multiplication factor of 4 is therefore required to convert the 10,000 counts/rev to match the 40,000 counts/rev of the motor. The following line would be used for axis 0.

```
PP_STEP AXIS(0) = 4
```

## 6-3-142 PRINT

**Type:** I/O Command

**Syntax:** PRINT [ #n, ] expression { , expression }  
? [ #n, ] expression { , expression }

**Description:** The PRINT command outputs a series of characters to the serial ports. PRINT can output parameters, fixed ASCII strings, and single ASCII characters. By using PRINT#n, any port can be selected to output the information to. Multiple items to be printed can be put on the same line separated by a comma “,” or a semi-colon “;”. A comma separator in the print command places a tab between the printed items. The semi-colon separator prints the next item without any spaces between printed items.

The width of the field in which a number is printed can be set with the use of [w,x] after the number to be printed. The width of the column is given by w and the number of decimal places is given by x. Using only one parameter [x] takes the default width and specifies the number of decimal places to be printed. The numbers are right aligned in the field with any unused leading characters being filled with spaces. If the number is too long, then the field will be filled with asterisks to signify that there was not sufficient space to display the number. The maximum field width allowable is 127 characters.

### CHR(x)

The CHR(x) command is used to send individual ASCII characters using their ASCII codes. The semi-colon on the end of the print line suppresses the carriage return normally sent at the end of a print line. ASCII(13) generates CR without a linefeed so the line above would be printed on top of itself if it were the only print statement in a program. PRINT CHR(x); is equivalent to PUT(x) in some forms of BASIC.

### HEX(x)

The HEX command is used to print the hexadecimal value of the output. Negative values will result in the 2's complement hexadecimal value (24-bit). The valid range is [-8388608, 16777215].

### \ (back slash)

The back slash (\) command can be used to print a single ASCII character. For example,

```
>> PRINT "\a", "\\ ", "\%"
a \ %
```

**Arguments:** *n*

The specified output device. When this argument is omitted, the port as specified by OUTDEVICE will be used.

- 0 RS-232C programming port 0
- 1 RS-232C serial port 1
- 2 RS-422A/485 serial port 2

- 5 Motion Perfect port 0 user channel 5
- 6 Motion Perfect port 0 user channel 6
- 7 Motion Perfect port 0 user channel 7

**expression**

The expression to be printed.

**See also:** OUTDEVICE, hexadecimal input (\$)

**Examples:** **Example 1**

```
PRINT "CAPITALS and lower case CAN BE PRINTED"
```

**Example 2**

Consider VR(1) = 6 and variab = 1.5, the print output will be as follows:

```
PRINT 123.45,VR(1)-variab
123.4500 4.5000
```

**Example 3**

In this example, the semi-colon separator is used. This does not tab into the next column, allowing the programmer more freedom in where the print items are placed.

```
length:
PRINT "DISTANCE = ";mpos
DISTANCE = 123.0000
```

**Example 4**

```
PRINT VR(1) [4,1];variab [6,2]
6.0 1.50
```

**Example 5**

```
params:
PRINT "DISTANCE = ";mpos [0]; " SPEED = ";v [2];
DISTANCE = 123 SPEED = 12.34
```

**Example 6**

```
PRINT "ITEM ";total" OF ";limit;CHR(13);
```

**Example 7**

```
>> PRINT HEX(15),HEX(-2)
F FFFFA
```

**6-3-143 PROC**

**Type:** Task Command

**Syntax:** PROC (*task\_number*)

**Description:** The PROC modifier allows a process parameter from a particular process to be read or written. If omitted, the current task will be assumed.

**Argument:** *task\_number*

The number of the task to access.

**Example:** WAIT UNTIL PMOVE PROC(3)=0

**6-3-144 PROC\_LINE**

**Type:** Task Parameter

**Description:** The PROC\_LINE parameter returns the current line number of the specified program task. The parameter is used with the PROC modifier.

**Note** This parameter is read-only.

**See also:** PROC\_STATUS, PROCNUMBER, PROC

**6-3-145 PROC\_STATUS**

|                     |                                                                                                                                                                  |
|---------------------|------------------------------------------------------------------------------------------------------------------------------------------------------------------|
| <b>Type:</b>        | Task Parameter                                                                                                                                                   |
| <b>Description:</b> | The PROC_STATUS parameter returns the status of the process or task specified. The parameter is used with the PROC modifier and can return the following values. |
|                     | 0 Process stopped                                                                                                                                                |
|                     | 1 Process running                                                                                                                                                |
|                     | 2 Process stepping                                                                                                                                               |
|                     | 3 Process paused                                                                                                                                                 |
| <b>See also:</b>    | PROC_LINE, PROCNUMBER, PROC                                                                                                                                      |
| <b>Example:</b>     | WAIT UNTIL PROC_STATUS PROC(3)=0                                                                                                                                 |

**6-3-146 PROCESS**

|                     |                                                                                          |
|---------------------|------------------------------------------------------------------------------------------|
| <b>Type:</b>        | Program Command                                                                          |
| <b>Syntax:</b>      | PROCESS                                                                                  |
| <b>Description:</b> | The PROCESS command returns the status list of all running tasks with their task number. |
| <b>See also:</b>    | HALT, RUN, STOP                                                                          |

**6-3-147 PROCNUMBER**

|                     |                                                                                                                                                                                                             |
|---------------------|-------------------------------------------------------------------------------------------------------------------------------------------------------------------------------------------------------------|
| <b>Type:</b>        | Task Parameter                                                                                                                                                                                              |
| <b>Description:</b> | The PROCNUMBER parameter contains the number of the task in which the currently selected program is running. PROCNUMBER is often required when multiple copies of a program are running on different tasks. |
| <b>Note</b>         | This parameter is read-only.                                                                                                                                                                                |
| <b>See also:</b>    | PROC_LINE, PROC_STATUS, PROC                                                                                                                                                                                |
| <b>Example:</b>     | MOVE(length) AXIS(PROCNUMBER)                                                                                                                                                                               |

**6-3-148 PSWITCH**

|                     |                                                                                                                                                                                                                                                                                                                                                                                                                                                                                                                                                                                                                                          |
|---------------------|------------------------------------------------------------------------------------------------------------------------------------------------------------------------------------------------------------------------------------------------------------------------------------------------------------------------------------------------------------------------------------------------------------------------------------------------------------------------------------------------------------------------------------------------------------------------------------------------------------------------------------------|
| <b>Type:</b>        | I/O Command                                                                                                                                                                                                                                                                                                                                                                                                                                                                                                                                                                                                                              |
| <b>Syntax:</b>      | PSWITCH ( <i>switch</i> , <i>enable</i> [ , <i>axis</i> , <i>output_number</i> , <i>output_state</i> , <i>set_position</i> , <i>reset_position</i> ])                                                                                                                                                                                                                                                                                                                                                                                                                                                                                    |
| <b>Description:</b> | The PSWITCH command turns ON an output when a predefined position is reached, and turns OFF the output when a second position is reached. The positions are specified as the measured absolute positions.<br>There are 16 position switches each of which can be assigned to any axis. Each switch is assigned its own ON and OFF positions and output number. The command can be used with 2 or all 7 arguments. With only 2 arguments a given switch can be disabled.<br>PSWITCHs are calculated on each servo cycle and the output result applied to the hardware. The response time is therefore 1 servo cycle period approximately. |
| <b>Precautions:</b> | An output may remain ON if it was ON when the PSWITCH was turned OFF. The OP command can be used to turn OFF an output as follows:<br>PSWITCH(2,OFF)<br>OP(14,OFF)        'Turn OFF pswitch controlling OP 14                                                                                                                                                                                                                                                                                                                                                                                                                            |

**Arguments:**

- switch***  
The switch number. Range: [0,15].
- enable***  
The switch enable. Range: [ON, OFF].
- axis***  
The number of the axis providing the position input.
- output\_number***  
The physical output to set. Range: [8,31].
- output\_state***  
The state to output. Range: [ON, OFF].
- set\_position***  
The absolute position in user units at which output is set.
- reset\_position***  
The absolute position in user units at which output is reset.

**See also:** OP, UNITS

**Example:** A rotating shaft has a cam operated switch which has to be changed for different size work pieces. There is also a proximity switch on the shaft to indicate the TDC of the machine. With a mechanical cam, the change from job to job is time consuming. This can be eased by using PSWITCH as a software cam switch. The proximity switch is wired to input 7 and the output is output 11. The shaft is controlled by axis 0. The motor has a 900ppr encoder. The output must be on from 80 units.

PSWITCH uses the unit conversion factor to allow the positions to be set in convenient units. First the unit conversion factor must be calculated and set. Each pulse on an encoder gives four edges for the MC Unit to count. There are thus 3,600 edges/rev or 10 edges/degree. If we set the unit conversion factor to 10, we can work in degrees.

Next we have to determine a value for all the PSWITCH arguments.

|               |                                                                                                |
|---------------|------------------------------------------------------------------------------------------------|
| <i>sw</i>     | The switch number can be any switch that is not in use. In this example, we will use number 0. |
| <i>en</i>     | The switch must be enabled to work; set the enable to 1.                                       |
| <i>axis</i>   | The shaft is controlled by axis 0.                                                             |
| <i>opno</i>   | The output being controlled is output 11.                                                      |
| <i>opst</i>   | The output must be on so set to 1.                                                             |
| <i>setpos</i> | The output is to produced at 80 units.                                                         |
| <i>rspos</i>  | The output is to be on for a period of 120 units.                                              |

This can all be put together in the following lines of BASIC code:

```
switch:
 UNITS AXIS(0) = 10 'Set unit conversion factor
 REPDIST = 360
 REP_OPTION = ON
 PSWITCH(0, ON, 0, 11, ON, 80, 200)
```

This program uses the repeat distance set to 360 degrees and the repeat option ON so that the axis position will be maintained between 0 and 360 degrees.

## 6-3-149 RAPIDSTOP

**Type:** Motion Control Command

**Syntax:** RAPIDSTOP

**Alternative:** RS

- Description:** The RAPIDSTOP command cancels the current move on all axes from the current move buffer (MTYPE). Moves for speed profiled move commands (MOVE, MOVEABS, MOVEMODIFY, FORWARD, REVERSE and MOVECIRC) will decelerate to a stop with the deceleration rate as set by the DECEL parameter. Moves for other commands will be immediately stopped.
- Precautions:**
- RAPIDSTOP cancels only the presently executing moves. If further moves are buffered in the next move buffers (NTYPE) or the task buffers they will then be loaded.
  - During the deceleration of the current moves additional RAPIDSTOPs will be ignored.
- See also:** CANCEL, MTYPE, NTYPE

### 6-3-150 READ\_BIT

- Type:** System Command
- Syntax:** READ\_BIT (*bit\_number*, *vr\_number*)
- Description:** The READ\_BIT command returns the value of the specified bit in the specified VR variable, either 0 or 1.
- Arguments:**
- bit\_number***  
The number of the bit to be read. Range: [0,23].
- vr\_number***  
The number of the VR variable for which the bit is read. Range: [0,250].
- See also:** CLEAR\_BIT, SET\_BIT, VR

### 6-3-151 REG\_POS

- Type:** Axis Parameter
- Alternative:** RPOS
- Description:** The REG\_POS parameter stores the position in user units at which the (primary) registration event occurred.
- Note** This parameter is read-only.
- See also:** AXIS, MARK, REGIST, UNITS

### 6-3-152 REG\_POSB

- Type:** Axis Parameter
- Description:** The REG\_POSB parameter stores the position in user units at which the secondary registration event occurred.
- Note** This parameter is read-only.
- See also:** AXIS, MARKB, REGIST, UNITS

### 6-3-153 REGIST

- Type:** Axis Command
- Syntax:** REGIST (*mode*)
- Description:** The REGIST command performs the print registration operation. The command captures an axis position when a registration input or the Z-marker on the encoder is detected. The capture is carried out by hardware, so software delays do not affect the accuracy of the position captured.
- The operation of the print registration is axis specific. REGIST works on the default basis axis (set with BASE) unless AXIS is used to specify a temporary base axis.

**Axis 0**

For axis 0 the print registration mechanism of the Servo Driver is used. The registration is either triggered by the Servomotor encoder Z-marker or the digital input on the Servo Driver (CN1-46). The Servo Driver parameter Pn511.3 will set the input to register on falling or rising edge. For details please refer to 3-3-2 Digital I/O.

When the registration event has occurred, MARK axis parameter will be set to TRUE and the position will be stored in the REG\_POS axis parameter.

**Axis 1**

For axis 1 the print registration mechanism of the MC Unit provides two registers, which allows two simultaneous events to be captured. The registration event can either be input I0 / R0, input I1 / R1 or the encoder input Z-marker phase.

When a primary registration event has occurred, MARK axis parameter will be set to TRUE and the position will be stored in the REG\_POS axis parameter. For the secondary registration event, the MARKB axis parameter will be set and the position will be stored in the REG\_POSB axis parameter.

**Inclusive windowing**

Inclusive windowing allows the print registration event only to occur within the specified window. When inclusive windowing is applied, signals will be ignored if the axis measured position is not greater than the OPEN\_WIN parameter and less than the CLOSE\_WIN parameter. Add 256 to the *mode* argument value to apply inclusive windowing.

**Exclusive windowing**

Exclusive windowing allows the print registration event only to occur outside the specified window. When exclusive windowing is applied, signals will be ignored if the axis measured position is not less than the OPEN\_WIN parameter or greater than the CLOSE\_WIN parameter. Add 768 to the *mode* argument value to apply exclusive windowing.

**Precautions:**

REGIST must be executed once for each position capture.

**Arguments:**

***mode***

Specifies the type of capture to make depending on the axis

| axis | mode | Description                                            |
|------|------|--------------------------------------------------------|
| 0    | 1    | Captures absolute position on Z-marker to REG_POS.     |
|      | 2    | Captures absolute position on input CN1-46 to REG_POS. |

| axis | mode | Description                                                                                                    |
|------|------|----------------------------------------------------------------------------------------------------------------|
| 1    | 1    | Captures absolute position on rising edge of Z-marker to REG_POS.                                              |
|      | 2    | Captures absolute position on falling edge of Z-marker to REG_POS.                                             |
|      | 3    | Captures absolute position on rising edge of input R0 to REG_POS.                                              |
|      | 4    | Captures absolute position on falling edge of input R0 to REG_POS.                                             |
|      | 5    | -                                                                                                              |
|      | 6    | Captures absolute position on rising edge of input R0 to REG_POS and on rising edge of Z-marker to REG_POSB.   |
|      | 7    | Captures absolute position on rising edge of input R0 to REG_POS and on falling edge of Z-marker to REG_POSB.  |
|      | 8    | Captures absolute position on falling edge of input R0 to REG_POS and on rising edge of Z-marker to REG_POSB.  |
|      | 9    | Captures absolute position on falling edge of input R0 to REG_POS and on falling edge of Z-marker to REG_POSB. |
|      | 10   | Captures absolute position on rising edge of input R0 to REG_POS and on rising edge of input R1 to REG_POSB.   |
|      | 11   | Captures absolute position on rising edge of input R0 to REG_POS and on falling edge of input R1 to REG_POSB.  |
|      | 12   | Captures absolute position on falling edge of input R0 to REG_POS and on rising edge of input R1 to REG_POSB.  |
|      | 13   | Captures absolute position on falling edge of input R0 to REG_POS and on falling edge of input R1 to REG_POSB. |

**See also:** AXIS, CLOSE\_WIN, MARK, MARKB, OPEN\_WIN, REG\_POS, REG\_POSB

**Examples:****Example 1**

```

BASE(0)
catch:
 REGIST(2)
 WAIT UNTIL MARK
 PRINT "Registration input at: ";REG_POS

```

**Example 2**

A paper cutting machine uses a CAM profile to quickly draw paper through servo-driven rollers and then stop it while it is cut. The paper is printed with a registration mark. This mark is detected and the length of the next sheet is adjusted by scaling the CAM profile with the third argument (*table\_multiplier*) of the CAM command:

```

 `Set window open and close
 length = 200
 OPEN_WIN = 10
 CLOSE_WIN = length-10

 GOSUB Initial

loop:
 TICKS = 0 `Set servo cycle counter to 0
 IF MARK THEN
 offset = REG_POS
 `Next line makes offset -ve if at end of sheet
 IF ABS(offset-length) < offset THEN
 offset=offset - length
 ENDIF
 PRINT "Mark seen at:"offset[5.1]
 ELSE
 offset = 0
 PRINT "Mark not seen"
 ENDIF

```

```
`Reset registration prior to each move
DEFPOS(0)
REGIST(2+768)
```

```
'Allow mark at first 10 mm or last 10 mm of sheet
CAM(0,50,(length+offset*0.5)*cf,1000)
WAIT UNTIL TICKS > 500
GOTO loop
```

The variable *cf* is a constant which would be calculated depending on the machine draw length per encoder edge.

## 6-3-154 REMAIN

**Type:** Axis Parameter

**Description:** The REMAIN parameter contains the distance remaining to the end of the current move. It can be checked to see how much of the move has been completed. REMAIN is defined in user units.

**Note** This parameter is read-only.

**See also:** AXIS, UNITS

**Example:** To change the speed to a slower value 5mm from the end of a move.

```
start:
 SPEED = 10
 MOVE(45)
 WAIT UNTIL REMAIN < 5
 SPEED = 1
 WAIT IDLE
```

## 6-3-155 RENAME

**Type:** Program Command

**Syntax:** RENAME "*old\_program\_name*" "*new\_program\_name*"

**Description:** The RENAME command changes the name of a program in the MC Unit directory. The program names can also be specified without quotes.

**Precautions:** This command is implemented for an offline (VT100) terminal. Within Motion Perfect users can select the command from the Program menu.

**Arguments:** ***old\_program\_name***  
The current name of the program.

***new\_program\_name***  
The new name of the program.

**See also:** COPY, DEL, NEW

**Example:** RENAME "car" "voiture"

## 6-3-156 REP\_DIST

**Type:** Axis Parameter

**Description:** The REP\_DIST parameter contains the repeat distance, which is the allowable range of movement for an axis before the demand position (DPOS) and measured position (MPOS) are corrected. REP\_DIST is defined in user units. The exact range is controlled by REP\_OPTION. The REP\_DIST can have any non-zero positive value.

When the measured position has reached its limit, the MC unit will adjust the absolute positions without affecting the move in progress or the servo algo-



rithm. Not that the demand position can be outside the range because the measured position is used to trigger the adjustment.

For every occurrence (DEFPOS, OFFPOS, MOVEABS, MOVEMODIFY) which defines a position outside the range, the end position will be redefined within the range.

The default value for axis 0, 1 and 2 are respectively 2147483648, 5000000 and 5000000.

**See also:** AXIS, DPOS, MPOS, REP\_OPTION, UNITS

### 6-3-157 REP\_OPTION

**Type:** Axis Parameter

**Description:** The REP\_OPTION parameter controls the application of the REP\_DIST axis parameter and the repeat option of the CAMBOX and MOVELINK motion control commands. The default value is 0.

| Bit | Description                                                                                                                                                                                                                                                                                                                                                                     |
|-----|---------------------------------------------------------------------------------------------------------------------------------------------------------------------------------------------------------------------------------------------------------------------------------------------------------------------------------------------------------------------------------|
| 0   | The repeated distance range is controlled by bit 0 of the REP_OPTION parameter. <ul style="list-style-type: none"> <li>• If REP_OPTION bit 0 is OFF, the range of the demanded and measured positions will be between -REP_DIST and REP_DIST.</li> <li>• If REP_OPTION bit 0 is ON, the range of the demanded and measured positions will be between 0 and REP_DIST.</li> </ul> |
| 1   | The automatic repeat option of the CAMBOX and MOVELINK commands are controlled by bit 1 of the REP_OPTION parameter. The bit is set ON to request the system software to end the automatic repeat option. When the system software has set the option OFF it automatically clears bit 1 of REP_OPTION.                                                                          |

**See also:** AXIS, CAMBOX, MOVELINK, REP\_DIST

### 6-3-158 REPEAT UNTIL

**Type:** Structural Command

**Syntax:** REPEAT  
           <commands>  
 UNTIL *condition*

**Description:** The REPEAT ... UNTIL structure allows the program segment between the REPEAT and the UNTIL statement to be repeated a number of times until the *condition* becomes TRUE.

**Precautions:** REPEAT ... UNTIL construct can be nested indefinitely.

**Arguments:** **commands**  
 Any valid set of BASIC commands  
**condition**  
 Any valid BASIC logical expression

**See also:** FOR, WHILE

**Example:** A conveyor is to index 100mm at a speed of 1000mm/s, wait for 0.5s and then repeat the cycle until an external counter signals to stop by turning ON input 4.

```
cycle:
 SPEED = 1000
 REPEAT
 MOVE (100)
```

```

WAIT IDLE
WA (500)
UNTIL IN(4) = ON

```

### 6-3-159 RESET

- Type:** System Command
- Syntax:** RESET
- Description:** The RESET command sets the value of all local variables of the current BASIC task to zero.
- See also:** CLEAR

### 6-3-160 REV\_IN

- Type:** Axis Parameter
- Description:** The REV\_IN parameter contains the input number to be used as a reverse limit input. The number can be set from 0 to 7 and 19. Range 0 to 7 is used to select one of the MC Unit inputs. Defining value 19 will select the Servo Driver's NOT (Reverse drive prohibited, CN1 pin 43) input. As default the parameter is set to -1, no input is selected.
- If an input number is set and the limit is reached, any reverse motion on that axis will be stopped. Bit 5 of the AXISSTATUS axis parameter will also be set.

**Note** This input is active low.

- See also:** AXIS, AXISSTATUS, FWD\_IN

### 6-3-161 REV\_JOG

- Type:** Axis Parameter
- Description:** The REV\_JOG parameter contains the input number to be used as a jog reverse input. The input can be from 0 to 7. As default the parameter is set to -1, no input is selected.

**Note** This input is active low.

- See also:** AXIS, FAST\_JOG, FWD\_JOG, JOGSPEED

### 6-3-162 REVERSE

- Type:** Motion Control Command
- Syntax:** REVERSE
- Alternative:** RE
- Description:** The REVERSE command moves an axis continuously in reverse at the speed set in the SPEED parameter. The acceleration rate is defined by the ACCEL axis parameter.
- REVERSE works on the default basis axis (set with BASE) unless AXIS is used to specify a temporary base axis.
- Precautions:** The reverse motion can be stopped by executing the CANCEL or RAPID-STOP command, or by reaching the reverse limit, inhibit, or origin return limit.
- See also:** AXIS, CANCEL, FORWARD, RAPIDSTOP

- Example:**
- ```

back:
  REVERSE
  WAIT UNTIL IN(0) = ON 'Wait for stop signal
  CANCEL

```

6-3-163 RS_LIMIT

- Type:** Axis Parameter
- Alternative:** RSLIMIT
- Description:** The RS_LIMIT parameter contains the absolute position of the reverse software limit in user units.
A software limit for reverse movement can be set from the program to control the working range of the machine. When the limit is reached, the MC Unit will decelerate to zero, and then cancel the move. Bit 10 of the AXISSTATUS axis parameter will be turned ON while the axis position is smaller than / below RS_LIMIT.
- See also:** AXIS, FS_LIMIT, UNITS

6-3-164 RUN

- Type:** Program Command
- Syntax:** RUN ["*program_name*" [, *task_number*]]
- Description:** The RUN command executes the program in the MC Unit as specified with *program_name*. RUN with the program name specification will run the current selected program. The program name can also be specified without quotes. The task number specifies the task number on which the program will be run. If the task number is omitted, the program will run on the highest available task. RUN can be included in a program to run another program.
- Precautions:** Execution continues until one of the following occurs:
- There are no more lines to execute.
 - HALT is typed at the command line to stop all programs.
 - STOP is typed at the command line to stop a single program.
 - A run-time error is encountered.
- Arguments:** ***program_name***
Any valid program name.
task_number
Any valid task number. Range: [1,3].
- See also:** HALT, STOP
- Examples:** **Example 1**
The following example executes the currently selected program.
>> SELECT "PROGRAM"
PROGRAM selected
>> RUN
- Example 2**
The following example executes the program named "sausage".
RUN "sausage"
- Example 3**
The following example executes the program named "sausage" on task 3.
RUN "sausage", 3

6-3-165 RUN_ERROR

- Type:** Task Parameter
- Description:** The RUN_ERROR parameter contains the number of the last BASIC run-time error that occurred on the specified task.

Each task has its own RUN_ERROR parameter. Use the PROC modifier to access the parameter for a certain task. Without PROC the current task will be assumed.

Note This parameter is read-only.

See also: BASICERROR, ERROR_LINE, PROC

Example:

```
>> PRINT RUN_ERROR PROC (5)
9.0000
```

6-3-166 RUNTYPE

Type: Program Command

Syntax: RUNTYPE "*program_name*", *auto_run* [, *task_number*]

Description: The RUNTYPE command determines whether the program, specified by *program_name*, is run automatically at start-up or not and which task it is to run on. The task number is optional, if omitted the program will run at the highest available task.

The current RUNTYPE status of each programs is displayed when a DIR command is executed. If one program has compilation errors no programs will be started at power up. To set the RUNTYPE using Motion Perfect, select "Set Power-up mode" from the Program Menu.

Note The execution of the EPROM command is required to store the new RUNTYPE settings into Flash memory. Otherwise the new settings will be lost when the power is switched off.

Arguments: ***program_name***
The name of the program whose RUNTYPE is being set.

autorun

0 Running manually on command.

1 Automatically execute on power up. All non-zero values are considered as 1.

task_number

The number of the step on which to execute the program. Range: [1, 3].

See also: AUTORUN, EPROM, EX

Example:

```
>> RUNTYPE progname,1,3
```

The above line sets the program "progname" to run automatically at start-up on task 3.

```
>> RUNTYPE progname,0
```

The above line sets the program "progname" to manual running.

6-3-167 S_RATE

Type: Axis Parameter

Description: The S_RATE parameter contains the speed reference rate for the attached Servomotor. This parameter is defined as the speed value in rounds per minute which the Servomotor will move per reference unit.

$$\text{Rotational Speed [RPM]} = \text{Speed Reference}[1] \cdot \text{S_RATE}$$

This parameter will apply to the following parameters: S_REF, S_REF_OUT, OUTLIMIT, AIN2 (Servo Driver rotation speed data).

Note This parameter is read-only.

See also: AIN2, AXIS, S_REF, S_REF_OUT, OUTLIMIT

Example: The following the statement will print the current speed reference in RPM which is applied to the Servo Driver.

```
>> PRINT S_REF_OUT*S_RATE
```

6-3-168 S_REF

Type: Axis Parameter

Alternative: DAC

Description: The S_REF parameter contains the speed reference value which is applied directly to the Servo Driver when the axis is in open loop (SERVO=OFF). The range of the S_REF parameter is defined by [-15000, 14999], but can be limited by using the OUTLIMIT parameter.

The actual speed reference is depending on the Servomotor. To determine the speed reference in rounds per minute (RPM), multiply the S_REF parameter value with the S_RATE parameter value.

The value currently being applied to the drive can be read using the S_REF_OUT axis parameter.

See also: AXIS, S_RATE, S_REF_OUT, OUTLIMIT, SERVO

Example: The following lines can be used to force a square wave of positive and negative movement with a period of approximately 500ms on axis 0.

```
WDOG = ON
SERVO = OFF
square:
S_REF AXIS(0) = 2000
WA(250)
S_REF AXIS(0) = -2000
WA(250)
GOTO square
```

6-3-169 S_REF_OUT

Type: Axis Parameter

Alternative: DAC_OUT

Description: The S_REF_OUT parameter contains the speed reference value being applied to the Servo Driver for both open and closed loop.

In closed loop (SERVO=ON), the motion control algorithm will output a speed reference signal determined by the control gain settings and the following error. The position of the Servomotor is determined using the motion control commands. In open loop (SERVO=OFF), the speed reference signal is determined by the S_REF axis parameter.

The actual speed reference is depending on the Servomotor. To determine the speed reference in rounds per minute (RPM), multiply the S_REF parameter value with the S_RATE parameter value.

Note This parameter is read-only.

See also: AXIS, OUTLIMIT, S_REF, S_REF_OUT, SERVO

Example:

```
>> PRINT S_REF_OUT AXIS(0)
288.0000
```

6-3-170 SCOPE

Type: Motion Perfect Command

Syntax: SCOPE (control, period, table_start, table_stop, P0 [, P1 [, P2 [, P3]]])

Description: The SCOPE command programs the system to automatically store up to 4 parameters every sample period. The storing of data will start as soon as the TRIGGER command has been executed.

The sample period can be any multiple of the servo period. The parameters are stored in the Table array and can then be read back to a computer and displayed on the Motion Perfect Oscilloscope or written to a file for further analysis using the "Create Table file" option on the File Menu.

The current Table position for the first parameter which is written by SCOPE can be read from the SCOPE_POS parameter.

- Note**
1. Motion Perfect uses the SCOPE command when running the Oscilloscope function.
 2. To minimize calculation time for writing the real-time data, the SCOPE command is writing raw data to the Table array. For example
 - a) The parameters are written in encoder edges (per second) and therefore not compensated for the UNITS conversion factor.
 - b) The MSPEED parameter is written as the change in encoder edges per servo period.
 3. Applications like the CAM command, CAMBOX command and the SCOPE command all use the same Table as the data area.

Arguments: **control**
Set ON or OFF to control SCOPE execution. If turned ON the SCOPE is ready to run as soon as the TRIGGER command is executed.

period

The number of servo periods between data samples.

table_start

The address of the first element in the Table array to start storing data.

table_stop

The address of the last element in the Table array to be used.

P0

First parameter to store.

P1

Optional second parameter to store.

P2

Optional third parameter to store.

P3

Optional fourth parameter to store.

See also: SCOPE_POS, TABLE, TRIGGER

Examples: **Example 1**

```
SCOPE (ON, 10, 0, 1000, MPOS AXIS (1), DPOS AXIS (1))
```

This example programs the SCOPE function to store the MPOS parameter for axis 1 and the DPOS parameter for axis 1 every 10 servo cycles. The MPOS parameter will be stored in table locations 0 to 499; the DPOS parameters, in table locations 500 to 999. The SCOPE function will wrap and start storing at the beginning again unless stopped. Sampling will not start until the TRIGGER command is executed.

Example 2

```
SCOPE (OFF)
```

This above line turns the scope function off.

6-3-171 SCOPE_POS

Type: Motion Perfect Parameter

Description: The SCOPE_POS parameter contains the current Table position at which the SCOPE command is currently storing its first parameter.

Note This parameter is read-only.

See also: SCOPE

6-3-172 SELECT

Type: Program Command

Syntax: SELECT "program_name"

Description: The SELECT command specifies the current program for editing, running, listing, etc. SELECT makes a new program if the name entered does not exist. The program name can also be specified without quotes.

When a program is selected, the commands COMPILE, DEL, EDIT, LIST, NEW, RUN, STEPLINE, STOP and TROFF will apply to the currently selected program unless a program is specified in the command line. When another program is selected, the previously selected program will be compiled. The selected program cannot be changed when a program is running.

Precautions: This command is implemented for an offline (VT100) terminal. Motion Perfect automatically selects programs when you click on their entry in the list in the control panel.

See also: COMPILE, DEL, EDIT, LIST, NEW, RUN, STEPLINE, STOP, TROFF

Example:
 >> SELECT "PROGRAM"
 PROGRAM selected
 >> RUN

6-3-173 SERVO

Type: Axis Parameter

Description: The SERVO parameter determines whether the base axis runs under servo control (SERVO=ON) or open loop (SERVO=OFF). In closed loop, the motion control algorithm will output a speed reference signal determined by the control gain settings and the following error. The position of the Servomotor is determined using the motion control commands.

In open loop, the speed reference signal is completely determined by the S_REF axis parameter.

See also: AXIS, FE_LIMIT, S_REF, S_REF_OUT, WDOG

Example:
 SERVO AXIS(0) = ON 'Axis 0 is under servo control
 SERVO AXIS(1) = OFF 'Axis 1 is run open loop

6-3-174 SERVO_PERIOD

Type: System Parameter

Description: The SERVO_PERIOD parameter sets the servo cycle period of the MC Unit. The timing of the execution of the program tasks and the refreshing of the control data and I/O of the Unit are all depending on this setting. The parameter is defined in microseconds. The MC Unit can be set in either 0.5 ms or 1.0 ms servo cycle.

Value	Description
500	0.5 ms
1000	1.0 ms

 **Caution** When the parameter has been set, a power down or software reset (using DRV_RESET) must be performed for the complete system. Not doing so may result in undefined behaviour.

See also: DRV_RESET

6-3-175 SET_BIT

Type: System Command

Syntax: SET_BIT (*bit_number*, *vr_number*)

Description: The SET_BIT command sets the specified bit in the specified VR variable to one. Other bits in the variable will keep their values.

Arguments: ***bit_number***

The number of the bit to be set. Range: [0,23].

vr_number

The number of the VR variable for which the bit is set. Range: [0,250].

See also: CLEAR_BIT, READ_BIT, VR

6-3-176 SETCOM

Type: I/O Command

Syntax: SETCOM (*baud_rate*, *data_bits*, *stop_bits*, *parity*, *port_number*, *mode*)

Description: The SETCOM command sets the serial communications for the serial ports. The command will enable the Host Link protocols or define the general-purpose communication.

The serial ports have 9,600 baud, 7 data bits, 2 stop bits, even parity and XON/XOFF enabled for general-purpose communication by default. These default settings are recovered at start-up.

Arguments: ***baud_rate***

1200, 2400, 4800, 9600, 19200, 38400

data_bits

7, 8

stop_bits

1, 2

parity

0 None

1 Odd

2 Even

port_number

0 RS-232C programming port 0

1 RS-232C serial port 1

2 RS-422A/485 serial port 2

mode

Select one of the following modes for serial ports 1 and 2:

0 General-purpose communication (no XON/XOFF mechanism)

5 Host Link Slave protocol

6 Host Link Master protocol

6-3-177 SGN

Type: Mathematical Function

Syntax: SGN (*expression*)

Description: The SGN function returns the sign of a number. It returns value 1 for positive values (including zero) and value -1 for negative values.

Arguments: *expression*
Any valid BASIC expression.

Example:

```
>> PRINT SGN(-1.2)
-1.0000
```

6-3-178 SIN

Type: Mathematical Function

Syntax: `SIN(expression)`

Description: The SIN function returns the sine of the *expression*. Input values are in radians and may have any value. The result value will be in the range from -1 to 1.

Arguments: *expression*
Any valid BASIC expression.

Example:

```
>> PRINT SIN(PI/2)
1.0000
```

6-3-179 SPEED

Type: Axis Parameter

Description: The SPEED parameter contains the demand speed in units/s. It can have any positive value (including zero). The demand speed is the maximum speed for the speed profiled motion commands.

See also: ACCEL, AXIS, DATUM, DECEL, FORWARD, MOVE, MOVEABS, MOVECIRC, MOVEMODIFY, REVERSE, UNITS

Example:

```
SPEED = 1000
PRINT "Set speed = ";SPEED
```

6-3-180 SQR

Type: Mathematical Function

Syntax: `SQR(expression)`

Description: The SQR function returns the square root of the *expression*. The *expression* must have positive (including zero) value.

Arguments: *expression*
Any valid BASIC expression.

Example:

```
>> PRINT SQR(4)
2.0000
```

6-3-181 SRAMP

Type: Axis Parameter

Description: The SRAMP parameter contains the S-curve factor. The S-curve factor controls the amount of rounding applied to the trapezoidal profiles. A value of 0 sets no rounding. A value of 10 sets maximum rounding. The default value of the parameter is 0.

SRAMP is applied to the FORWARD, MOVE, MOVEABS, MOVECIRC and REVERSE commands. Note that using S-curves increases the time required for the movement to complete.

Precautions: The S-curve factor must not be changed while a move is in progress.

See also: AXIS

6-3-182 STEPLINE

Type: Program Command

Syntax:	STEPLINE [" <i>program_name</i> " [, <i>task_number</i>]]
Description:	The STEPLINE command executes one line (i.e., "steps") in the program specified by <i>program_name</i> . The program name can also be specified without quotes. If STEPLINE is executed without program name on the command line the current selected program will be stepped. If STEPLINE is executed without program name in a program this program will be stepped. If the program is specified then all occurrences of this program will be stepped. A new task will be started when there is no copy of the program running. If the task is specified as well then only the copy of the program running on the specified task will be stepped. If there is no copy of the program running on the specified task then one will be started on it.
Arguments:	<i>program_name</i> The name of the program to be stepped. <i>task_number</i> The number of the task with the program to be stepped. Range: [1,3].
See also:	RUN, SELECT, STOP, TROFF, TRON
Examples:	Example 1 >> STEPLINE "conveyor" Example 2 >> STEPLINE "maths", 2

6-3-183 STOP

Type:	Program Command
Syntax:	STOP [" <i>program_name</i> " [, <i>task_number</i>]]
Description:	The STOP command will halt execution of the program specified with <i>program_name</i> . If the program name is omitted, then the currently selected program will be halted. The program name can also be specified without quotes. In case of multiple executions of a single program on different tasks the <i>task_number</i> can be used to specify the specific task to be stopped.
Arguments:	<i>program_name</i> The name of the program to be stopped. <i>task_number</i> The number of the task with the program to be stepped. Range: [1,3].
See also:	HALT, RUN, SELECT
Examples:	Example 1 >> STOP progname Example 2 The lines from <i>label</i> on will not be executed in this example. <pre> STOP label: PRINT var RETURN </pre>

6-3-184 SWITCH_STATUS

Type:	System Parameter
Description:	The SWITCH_STATUS parameter contains the status of the 10 external DIP-switches on the MC Unit. For the MCW151-DRT-E these are also used for the DeviceNet settings.

If the status of the switches are changed during operation, the parameter status will be automatically updated.

Note This parameter is read-only.

6-3-185 T_RATE

Type: Axis Parameter

Description: The T_RATE parameter contains the torque reference rate for the attached Servomotor. This parameter is defined as the torque value in percentage of the rated torque which is applied to the Servomotor per reference unit (T_RATE parameter).

$$\text{Applied Torque [\% of rated torque]} = T_REF[1] \cdot T_RATE$$

This parameter will apply to the following parameters: T_REF, AIN1 (Servo Driver torque command data), AIN3 (Servo Driver torque monitor data).

Note This parameter is read-only.

See also: AIN1, AIN3, AXIS, T_REF

Example: The following the statement will print the torque monitor value from the Servo Driver in percentage of the rated torque which is applied to the Servomotor.

```
>> PRINT AIN3*T_RATE
```

6-3-186 T_REF

Type: Axis Parameter

Alternative: DAC

Description: The T_REF parameter contains the torque reference value which will be applied to the Servomotor. The range of the T_REF parameter is defined by [-15000, 15000].

The actual torque reference is depending on the Servomotor. To determine the torque reference in percentage of the rated torque, multiply the T_REF parameter value with the T_RATE parameter value.

See also: AXIS, T_REF

Example: T_REF AXIS(0)=1000

6-3-187 TABLE

Type: System Command

Syntax: TABLE (*address*, *value* {, *value*})

TABLE (*address*)

Description: The TABLE command loads data to and reads data from the Table array. The Table has a maximum length of 8.000 elements. The table values are floating-point numbers with fractions. The table can also be used to hold information, as an alternative to variables. The TABLE command has two forms.

- TABLE(*address*, *value*{, *value*}) writes a sequence of values to the Table array. The location of the element is specified by *address*. The sequence can have a maximum length of 20 elements.
- TABLE(*address*) returns the table value at that entry.

A value in the table can be read only if a value of that number or higher has been previously written to the table. For example, printing TABLE(1001) will produce an error message if the highest table location previously written to the table is location 1000. The total Table size is indicated by the TSIZE

parameter. Note that this value is one more than the highest defined element address.

The table can be deleted with by using DEL "TABLE" or NEW "TABLE" on the command line.

- Precautions:**
1. Applications like the CAM command, CAMBOX command and the SCOPE command in Motion Perfect all use the same Table as the data area. Do not use the same data area range for different purposes.
 2. The Table and VR data can be accessed from all different running tasks. To avoid problems of two program tasks writing unexpectedly to one global variable, write the programs in such a way that only one program writes to the global variable at a time.
 3. The Table and VR data in RAM will be lost when the power is switched OFF. If valid data needs to be recovered during start-up, write the data into Flash memory using the FLASHVR command.

Arguments: *address*

The first location in the Table to read or write. Range: [0,7999]

value

The value to write at the given location and at subsequent locations.

See also: CAM, CAMBOX, DEL, FLASHVR, NEW, SCOPE, TSIZE, VR

Examples: **Example 1**

```
TABLE (100, 0, 120, 250, 370, 470, 530, 550)
```

The above line loads the following internal table:

Table Entry	Value
100	0
101	120
102	250
103	370
104	470
105	530
106	550

Example 2

The following line will print the value at location 1000.

```
>> PRINT TABLE (1000)
```

6-3-188 TAN

Type: Mathematical Function

Syntax: TAN (*expression*)

Description: The TAN function returns the tangent of the *expression*. The *expression* is assumed to be in radians.

Arguments: *expression*
Any valid BASIC expression.

Example:
>> print TAN(PI/4)
1.0000

6-3-189 TICKS

Type: Task Parameter

Description: The TICKS parameter contains the current count of the task clock pulses. TICKS is a 32-bit counter that is decremented on each servo cycle. TICKS can be written and read. It can be used to measure cycles times, add time delays, etc.

Each task has its own TICKS parameter. Use the PROC modifier to access the parameter for a certain task. Without PROC the current task will be assumed.

Example:

```

delay:
    TICKS = 3000
    OP (9,ON)
test:
    IF TICKS< = 0 THEN
        OP (9,OFF)
    ELSE
        GOTO test
    ENDIF

```

6-3-190 TRIGGER

Type: Motion Perfect Command

Syntax: TRIGGER

Description: The TRIGGER command starts a previously set up SCOPE command.

Note Motion Perfect uses TRIGGER automatically for its oscilloscope function.

See also: SCOPE

6-3-191 TROFF

Type: Program Command

Syntax: TROFF ["*program_name*"]

Description: The TROFF command suspends a trace at the current line and resumes normal program execution for the program specified with *program_name*. The program name can also be specified without quotes. If the program name is omitted, the selected program will be assumed.

Arguments: *program_name*
The name of the program for which to suspend tracing.

See also: SELECT, TRON

Example: >> TROFF "lines"

6-3-192 TRON

Type: Program Command

Syntax: TRON

Description: The TRON command creates a breakpoint in a program that will suspend program execution at the line following the TRON command. The program can then for example be executed one line at a time using the STEPLINE command.

- Program execution can be resumed without using the STEPLINE command by executing the TROFF command.
- The trace mode can be stopped by issuing a STOP or HALT command.
- Motion Perfect highlights lines containing TRON in the Edit and Debug Windows.

See also: TROFF

Example:

```

TRON
MOVE (0, 10)
MOVE (10, 0)
TRON
MOVE (0, -10)

```

```
MOVE (-10, 0)
```

6-3-193 TRUE

Type: Constant

Description: The TRUE constant returns the numerical value -1.

Note A constant is read-only.

Example:

```
test:
  t = IN(0) AND IN(2)
  IF t = TRUE THEN
    PRINT "Inputs are ON"
  ENDIF
```

6-3-194 TSIZE

Type: System Parameter

Description: The TSIZE parameter returns the size of the Table array, which is one more than the currently highest defined table element. TSIZE is reset to zero when the Table array is deleted using DEL "TABLE" or NEW "TABLE" on the command line.

Note This parameter is read-only.

See also: DEL, NEW, TABLE

Example: The following example assumes that no location higher than 1000 has been written to the Table array.

```
>> TABLE(1000, 3400)
>> PRINT TSIZE
1001.0000
```

6-3-195 UNITS

Type: Axis Parameter

Description: The UNITS parameter contains the unit conversion factor. The unit conversion factor enables the user to define a more convenient user unit like m, mm or motor revolutions by specifying the amount of encoder edges to include a user unit.

Axis parameters like speed, acceleration, deceleration and the motion control commands are specified in these user units.

Precautions: The UNITS parameter can be any non-zero value, but it is recommended to design systems with an integer number of encoder pulses per user unit. Changing UNITS will affect all axis parameters which are dependent on UNITS in order to keep the same dynamics for the system.

See also: AXIS, PP_STEP

Example: A leadscrew arrangement has a 5mm pitch and a 1,000-pulse/rev encoder. The units must be set to allow moves to be specified in mm. The 1,000 pulses/rev will generate $1,000 \times 4 = 4,000$ edges/rev. One rev is equal to 5mm. Therefore, there are $4,000/5 = 800$ edges/mm. UNITS is thus set as following.

```
>> UNITS = 1000*4/5
```

6-3-196 VERSION

Type: System Parameter

Description: The VERSION parameter returns the current firmware version number of the current system installed in the MC Unit.

Note This parameter is read-only.

Example:
 >> PRINT VERSION
 1.6100

6-3-197 VFF_GAIN

Type: Axis Parameter

Description: The VFF_GAIN parameter contains the speed feed forward gain. The speed feed forward output contribution is calculated by multiplying the change in demand position with the VFF_GAIN parameter value. The default value is zero.

Adding speed feed forward gain to a system decreases the following error during a move by increasing the output proportionally with the speed.

See section 1-4-1 *Servo System Principles* for more details.

Precautions: In order to avoid any instability the servo gains should be changed only when the SERVO is OFF.

See also: AXIS, D_GAIN, I_GAIN, OV_GAIN, P_GAIN

6-3-198 VP_SPEED

Type: Axis Parameter

Description: The VP_SPEED parameter contains the speed profile speed in user units/s. The speed profile speed is an internal speed which is accelerated and decelerated as the movement is profiled.

Note This parameter is read-only.

See also: AXIS, MSPEED, UNITS

Example:
 'Wait until at command speed
 MOVE(100)
 WAIT UNTIL SPEED = VP_SPEED

6-3-199 VR

Type: System Command

Syntax: VR (*address*)

Description: The VR command reads or writes the value of a global (VR) variable. These VR variables hold real numbers and can be easily used as an element or as an array of elements. The MC Unit has in total 251 VR variables.

The VR variables can be used for several purposes in BASIC programming. The VR variables are globally shared between tasks and can be used for communications between tasks.

Precautions:

1. The Table and VR data can be accessed from all different running tasks. To avoid problems of two program tasks writing unexpectedly to one global variable, write the programs in such a way that only one program writes to the global variable at a time.
2. The Table and VR data in RAM will be lost when the power is switched OFF. If valid data needs to be recovered during start-up, write the data into Flash memory using the FLASHVR command.

Arguments: **address**
 The address of the VR variable. Range: [0,250].

See also: CLEAR_BIT, READ_BIT, SET_BIT, TABLE

Examples: **Example 1**

In the following example, the value 1.2555 is placed into VR variable 15. The local variable *val* is used to name the global variable locally:

```
val = 15
VR(val) = 1.2555
```

Example 2

A transfer gantry has 10 put down positions in a row. Each position may at any time be full or empty. VR(101) to VR(110) are used to hold an array of ten 1's and 0's to signal that the positions are full (1) or empty (0). The gantry puts the load down in the first free position. Part of the program to achieve this would be as follows:

```
movep:
  MOVEABS(115)    `Move to first put down position
  FOR VR(0) = 101 TO 110
    IF (VR(VR(0)) = 0) THEN GOSUB load
    MOVE(200)     `200 is spacing between positions
  NEXT VR(0)
  PRINT "All positions are full"
  WAIT UNTIL IN(3) = ON
  GOTO movep
```

```
load:                `Put load in position and mark array
  OP(15,OFF)
  VR(VR(0)) = 1
  RETURN
```

The variables are backed up by a battery so the program here could be designed to store the state of the machine when the power is OFF. It would of course be necessary to provide a means of resetting completely following manual intervention.

Example 3

```
loop:                `Assign VR(65) to VR(0) multiplied by
                    `axis 1 measured position
  VR(65) = VR(0)*MPOS AXIS(1)
  PRINT VR(65)
  GOTO loop
```

6-3-200 WA

Type: System Command

Syntax: WA (*time*)

Description: The WA command pauses program execution for the number of milliseconds specified for time. The command can only be used in a program.

Arguments: *time*

The number of milliseconds to hold program execution.

Example: The following lines would turn ON output 7 two seconds after turning OFF output 1.

```
OP(1,OFF)
WA(2000)
OP(7,ON)
```

6-3-201 WAIT IDLE

Type: System Command

Syntax: WAIT IDLE

Description: The WAIT IDLE command suspends program execution until the base axis has finished executing its current move and any buffered move. The command can only be used in a program.

- WAIT IDLE works on the default basis axis (set with BASE) unless AXIS is used to specify a temporary base axis.
- Precautions:** The execution of WAIT IDLE does not necessarily mean that the axis will be stationary in a servo motor system.
- See also:** AXIS, WAIT LOADED
- Example:**
- ```
MOVE (100)
WAIT IDLE
PRINT "Move Done"
```

### 6-3-202 WAIT LOADED

- Type:** System Command
- Syntax:** WAIT LOADED
- Description:** The WAIT LOADED command suspends program execution until the base axis has no moves buffered ahead other than the currently executing move. The command can only be used in a program. This is useful for activating events at the beginning of a move, or at the end when multiple moves are buffered together. WAIT LOADED works on the default basis axis (set with BASE) unless AXIS is used to specify a temporary base axis.
- See also:** AXIS, WAIT IDLE
- Example:**
- ```
`Switch output 8 ON at start of start of MOVE(500)
`and OFF at end
MOVE (800)
MOVE (500)
WAIT LOADED
OP (8, ON)
MOVE (400)
WAIT LOADED
OP (8, OFF)
```

6-3-203 WAIT UNTIL

- Type:** System Command
- Syntax:** WAIT UNTIL *condition*
- Description:** The WAIT UNTIL command repeatedly evaluates the *condition* until it is TRUE. After this program execution will continue. The command can only be used in a program.
- Arguments:** ***condition***
Any valid BASIC logical expression.
- Examples:**
- Example 1**
In this example, the program waits until the measured position on axis 0 exceeds 150, and then starts a movement on axis 1
- ```
WAIT UNTIL MPOS AXIS (0)>150
MOVE (100) AXIS (1)
```
- Example 2**  
The expressions evaluated can be as complex as you like provided they follow BASIC syntax, for example:
- ```
WAIT UNTIL DPOS AXIS (2)< = 0 OR IN (1) = ON
```
- The above line would wait until the demand position of axis 2 is less than or equal to 0 or input 1 is ON.

6-3-204 WDOG

- Type:** System Parameter
- Description:** The WDOG parameter contains the software switch which enables the Servo Driver using the RUN (Servo ON) input signal. The enabled Servo Driver will control the Servomotor depending on the speed and torque reference values. WDOG can be turned ON and OFF under program control, on command line and the Motion Perfect control button.
- The Servo Driver will automatically be disabled when a MOTION_ERROR occurs. A motion error occurs when the AXISSTATUS state for one of the axes matches the ERRORMASK setting. In this case the software switch (WDOG) will be turned OFF, the MOTION_ERROR parameter will have value 1 and the ERROR_AXIS parameter will contain the number of the first axis to have the error.
- Precautions:** The WDOG parameter can be executed automatically by Motion Perfect when the Drives Enable Button is clicked on the control panel.
- See also:** AXISSTATUS, ERROR_AXIS, ERRORMASK, MOTION_ERROR, SERVO

6-3-205 WHILE WEND

- Type:** Structural Command
- Syntax:** `WHILE condition`
`<commands>`
`WEND`
- Description:** The WHILE ... WEND structure allows the program segment between the WHILE and the WEND statement to be repeated a number of times until the *condition* becomes FALSE. In that case program execution will continue after WEND.
- Precautions:** WHILE ... WEND loops can be nested without limit.
- Arguments:** *condition*
Any valid logical BASIC expression.
- See also:** FOR, REPEAT
- Example:**
- ```
WHILE IN(12) = OFF
 MOVE (200)
 WAIT IDLE
 OP (10, OFF)
 MOVE (-200)
 WAIT IDLE
 OP (10, ON)
WEND
```

**6-3-206 XOR**

- Type:** Logical Operator
- Syntax:** `expression_1 XOR expression_2`
- Description:** The XOR operator performs the logical XOR function between corresponding bits of the integer parts of two valid BASIC expressions.
- The logical XOR function between two bits is defined as follows:

| Bit 1 | Bit 2 | Result |
|-------|-------|--------|
| 0     | 0     | 0      |
| 0     | 1     | 1      |

| Bit 1 | Bit 2 | Result |
|-------|-------|--------|
| 1     | 0     | 1      |
| 1     | 1     | 0      |

**Arguments:** *expression\_1*  
Any valid BASIC expression.  
*expression\_2*  
Any valid BASIC expression.

**Example:** a = 10 XOR (2.1\*9)  
The parentheses are evaluated first, but only the integer part of the result, 18, is used for the operation. Therefore, this expression is equivalent to the following:

VR(0)=10 XOR 18

The XOR is a bit operator and so the binary action taking place is as follows:

|     |       |
|-----|-------|
|     | 01010 |
| XOR | 10010 |
|     | 11000 |

The result is, therefore, 24.

# SECTION 7

## Motion Perfect Software Package

This section describes the operation of the Motion Perfect programming software package. Motion Perfect provides the user a tool to program, monitor and debug motion based applications for the MC Unit.

|       |                                                 |     |
|-------|-------------------------------------------------|-----|
| 7-1   | Features and Requirements . . . . .             | 198 |
| 7-2   | Connecting to the MC Unit . . . . .             | 198 |
| 7-3   | Motion Perfect Projects . . . . .               | 199 |
| 7-3-1 | Project Manager . . . . .                       | 199 |
| 7-3-2 | Creating a Project for the First Time . . . . . | 201 |
| 7-4   | Desktop Appearance . . . . .                    | 201 |
| 7-4-1 | Control Panel . . . . .                         | 202 |
| 7-4-2 | Editing and Running Simple Programs . . . . .   | 203 |
| 7-5   | Motion Perfect Tools . . . . .                  | 204 |
| 7-5-1 | Terminal . . . . .                              | 204 |
| 7-5-2 | Editor . . . . .                                | 205 |
| 7-5-3 | Axis Parameters . . . . .                       | 208 |
| 7-5-4 | Controller Configuration . . . . .              | 209 |
| 7-5-5 | VR and Table Editors . . . . .                  | 209 |
| 7-5-6 | I/O Status Window . . . . .                     | 210 |
| 7-5-7 | Full Controller Directory . . . . .             | 211 |
| 7-5-8 | Jog Screen . . . . .                            | 211 |
| 7-5-9 | Oscilloscope . . . . .                          | 212 |
| 7-6   | Suggestions and Precautions . . . . .           | 217 |

## 7-1 Features and Requirements

Motion Perfect provides the following features.

- Using the Project Manager to maintain a consistent copy of application programs on the computer.
- Creating, copying, renaming, deleting, editing, running and debugging programs on the MC Unit.
- Using the Control Panel, Full Controller Directory, Axis Parameters Window, and I/O status to monitor the MC Unit and to control its status.
- Using the Program Debugger, Axis Parameters Window, Software Oscilloscope Window and Jog Axes Window to adjust the servo system.

It is possible to open several windows on the Motion Perfect desktop and run them simultaneously. A user could be stepping through a program displayed in an Editor Window, while checking the program's output and entering input characters via a separate terminal Window, and while also monitoring and updating the axis parameters and I/O status.

### Requirements

The MC Unit requires Motion Perfect version 2.0 or later. Please note that previous versions of the package will not work with this MC Unit.

The following are required to run Motion Perfect version 2.0.

1. IBM Personal Computer or 100% compatible.
2. Microsoft Windows 95, 98, 2000 or NT 4.0.
3. 66 MHz 486 based processor (133 MHz Pentium recommended).
4. 16 MB RAM (32 MB recommended).
5. 10 MB of hard disk space.
6. Enhanced serial communications port (UART 16550).
7. 800 x 600 pixel display or higher resolution with at least 256 colors.
8. Mouse or tracker ball.

## 7-2 Connecting to the MC Unit

Motion Perfect can be connected to the MC Unit once the MC Unit is powered-up and running in order to use all features. After installation Motion Perfect can be started by using the Start Button.

**Note** The computer should be connected to the MC Unit using a RS-232C Serial Cable (by OMRON) between a COM port on the computer and the MC Units RS-232C Programming Port. Refer to *2-3-2 Serial Port Connections* for details.

When started, Motion Perfect will display its introductory splash screen whilst looking for any controllers connected to the computer.



The status of the connection to the controller is displayed on the screen. The statements indicate at which COM port Motion Perfect is currently checking for a Motion Controller and which settings are used. The screen will confirm if Motion Perfect has found a controller or will indicate that no controller is found.

Motion Perfect will be disconnected when no suitable controllers have been found. The offline terminal will be shown. Refer to *SECTION 8 Troubleshooting*.

## 7-3 Motion Perfect Projects

Motion Perfect facilitates the works with MC Unit applications by using projects, which are a valuable aid in efficient application design and development. Projects are stored on the computer and each project contains the MC Unit programs, parameters and data required for one motion application. Managing each application as one project enables effective version control and provides a mechanism for verifying the application programs on the MC Unit.

### 7-3-1 Project Manager

The project manager is a background process that automatically maintains consistency between the programs on the MC Unit and the project on the computer. When you edit a program in the Motion Perfect editor, it changes both copies of the program. This avoids the slow process of uploading and downloading programs and ensures that there is always a backup of changes you make. As programs are created, copied or erased on the MC Unit using the Motion Perfect tools, the project is updated so that the files and programs are always consistent.

#### Project Backups

A backup copy of the project is stored on the computer after on-line operation has been successfully started. The backup copy can be loaded if the MC Unit version of the programs become corrupted for any reason by selecting **Revert to backup** from the File Menu.

The backup file will be overwritten each time a project is opened. If you open a new project during a development session, the new projects backup copy will overwrite the previous backup.

**Consistency Check**

When Motion Perfect starts, it always performs a consistency check between any programs on the MC Unit and the current project files on the computer. It will only enable its tool site when it has successfully verified that the programs in the controller matches the project on the computer. The CRC values of the programs are compared to perform the check. The Check Project Window shows the status of the check. When both projects are consistent, the statement “Project check OK” is shown in the message field.

If both projects differ, the window will display the options for the user to determine how to resolve this inconsistency. The Check Project Window is shown here:

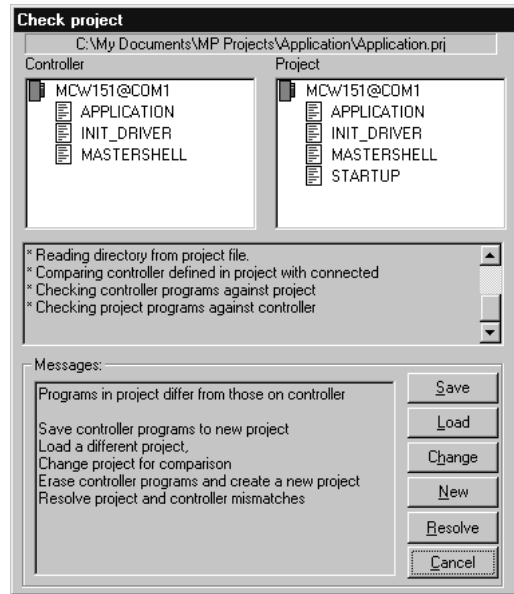

The window enables the user to select the required option to resolve the discrepancy. The options available include:

| Function | Purpose                                                                                                                                                                                                                                                   |
|----------|-----------------------------------------------------------------------------------------------------------------------------------------------------------------------------------------------------------------------------------------------------------|
| Save     | Save controller programs to new project. Create a new project on the computer and save the programs to this project.                                                                                                                                      |
| Load     | Load a different project. Select a new project on the computer and load this project into the controller.                                                                                                                                                 |
| Change   | Change project for comparison. Select a different project on the computer with which to perform the programs consistency check.                                                                                                                           |
| New      | Erase controller programs and create a new project. Create a new empty project on the computer and delete all programs on the controller.                                                                                                                 |
| Resolve  | Resolve project and controller mismatches. Continue to check the project, enabling the user to resolve each individual program inconsistency by either saving the project version into the controller or loading the controller version into the project. |
| Cancel   | Run Motion Perfect without connection to the controller.                                                                                                                                                                                                  |

You can force Motion Perfect to verify that the two copies are identical at any time by selecting **Check project** from the File Menu.

### 7-3-2 Creating a Project for the First Time

If this is the first time the MC Unit has been used with Motion Perfect and you do not have any programs on the MC Unit, click the New Button in the Check Project Options Window and then click the Yes Button when asked.

#### New Project Window

The New Project Window will open enabling you to enter the required name of the new project and specify the directory on your computer in which to store the project.

1,2,3...

1. Type a suitable project name in the Project Name text box, and then use the Disk Directory box to move to the directory in which to store the project.
2. If you wish to create a new directory on your computer, then move to the parent directory and click on the Create Directory button. Type the name of the new directory in the New Directory Window.
3. After selecting the required directory and entering the new project name, click the Create Button.
4. If the project path and name already exist, a window will appear asking whether to overwrite the existing project. If you confirm, the previous project will be overwritten and lost.
5. When a new project has been created, the Check Project Window will be displayed, with empty MC Unit Program and Project Program List Boxes and a 'Project check OK' message. Click the Ok Button to continue.

You have now created a new project on your computer, the Motion Perfect desktop will open, and all its facilities will be available.

## 7-4 Desktop Appearance

Once Motion Perfect has verified that the contents of the controller and the project on the computer are consistent, the Motion Perfect Desktop will appear. The desktop work area of Motion Perfect is where you will open up the windows to use when editing programs and using the Motion Perfect tools. The general look of the desktop is displayed below.

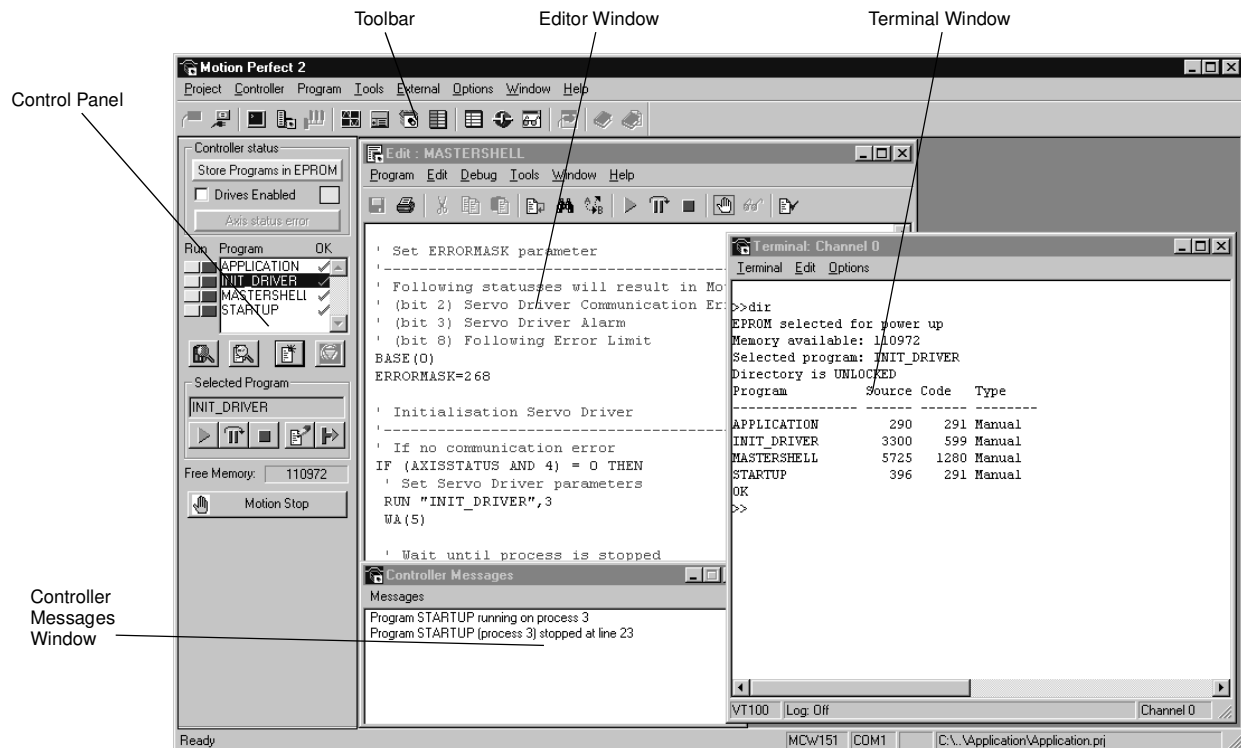



## 7-4-1 Control Panel

Motion Perfect is equipped with a Control Panel that is used to control program execution and the MC Unit while editing and debugging the programs. The Control Panel will appear after the initial opening window on the left of the main Motion Perfect Window:



### Controller Status

The **Store Programs in EPROM button** writes the programs from RAM into Flash memory. The programs from Flash memory will be updated to RAM during start-up.

The **Drives enabled button** toggles the state of the enable (watchdog) relay on the controller, which controls the drivers. See 6-3-204 *WDOG* for details.

The **Axis status error button** monitors the Motion errors of the MC Unit. This button is normally greyed out, unless a motion error occurs on the controller. When an error does occur, you can use this button to clear the error condition. This is equivalent to using the *DATUM(0)* command. See 6-3-48 *DATUM* for details.

### Program List Box

The Program List Box in the middle of the Control Panel will show a list of the programs in the project. There are two buttons next to each program name to control the execution of this program.

The **Run/Stop button (red)** shows that the program is stopped and can be clicked to start program execution.

When a program is being executed, the program name in the Program List Box will appear in italics, the MC Unit task number on which the program is running will appear alongside the program name, and the color of the Run/Stop button will change into green.

To stop the program click the Run/Stop button again to stop the program. A program cannot be edited while it is being executed.

The **Step button (yellow)** can be used to step through the program. The Run/Stop Button will turn yellow and one line of the program will be executed each time the Run/Stop button is clicked. When the Step button is clicked again, the program will be run normally.

When a program is being stepped, a green bar will appear in the Editor Window, highlighting the line of the program about to be executed.

Programs are compiled before execution. If there are any compilation errors in the program, a window will appear briefly describing the error and giving the number of the line containing the error. You can correct the error and repeat the process.

### Shortcut Buttons

Underneath the Program List Box you can find four shortcut buttons which are used for (from left to right):

- Controller configuration
- Full controller directory
- Create new program
- Halt all programs

### Selected Program Box

The Select Program box displays the current selected program and the available buttons, which can be performed on the selected program. These five available functions are (from left to right):

- Run
- Step
- Stop
- Edit
- Set power up mode

Refer to 5-5-3 *Program Execution* and 6-3-166 *RUNTYPE* for details on setting the power up mode.

### Free Memory

The Free Memory field indicates the remaining free memory available on the controller.

### Motion Stop

The **Motion Stop button** stops all programs and cancels all moves in case of emergency.

## 7-4-2 Editing and Running Simple Programs

This section provides a couple of typical examples of a simple programming session using Motion Perfect. The following procedure assumes that the MC Unit is already on-line with Motion Perfect and a new project has been created.

### Example 1

1,2,3...

1. Create a new program in the new project by selecting **New** from the Program Menu or by clicking on the Control Panel's shortcut button "Create New Program".
2. Name your program 'OP1' and click the **OK Button**.
3. Using the editor, enter a simple program to flash output 8. Type the program in lower case. When you press the Return Key, Motion Perfect will update the program on the computer and in the MC Unit, and will replace the BASIC keywords with their tokenised versions in upper case.

```
loop:
 OP (8, ON)
 WA (1000)
 OP (8, OFF)
 WA (1000)
 GOTO loop
```

The program can now be run, stepped and stopped without closing the Editor Window. The Program Menu can be used, but it is easier to use the Control Panel as described in the previous section. The Editor Window has similar buttons itself to do the same.

**Note** The command line will also remain available for immediate commands if the Terminal Window is open.

**Compilation**

The system will compile and link the program before running it. If the compiler detects errors in the program, it will not run, but will print the line number at which the error occurred. The line can be located by looking at the current line number displayed in the bottom right of the Editor Window's status bar or by selecting **Goto** from the Edit Menu.

**Example 2****1,2,3...**

A similar second program can be made based on the first program. This can be done quickly by copying the OP1 program and then editing it.

1. Select **Copy program** from the Program Menu and copy the OP1 program, calling the new program 'OP2'.
2. Select the OP2 program and press the **Edit Button** to open it.
3. Change the OP2 program to control a different OP with a different period. Refer to for *SECTION 6 BASIC Motion Control Programming Language* details on programming.
4. Executed the programs together.

The Run and Step Buttons on the Control Panel will control only the currently selected program Use the Run/Stop and Step Button or the menus to control other programs at the same time.

## 7-5 Motion Perfect Tools

This section describes the main Motion Perfect tools.

1. Terminal
2. Editor
3. Axis Parameters
4. Controller Configuration
5. VR and Table Editors
6. I/O Status
7. Full Controller Directory
8. Jog Axes
9. Oscilloscope

### 7-5-1 Terminal

The Terminal Window provides a direct connection to the MC Unit. Most commands, functions and parameter read/writes can be issued directly on the command line.

Most of the functions that must be performed during the installation, programming and final setup of a system with a MC Unit have been automated by the options available in the Motion Perfect Menus. A Terminal Window is shown in the following display.

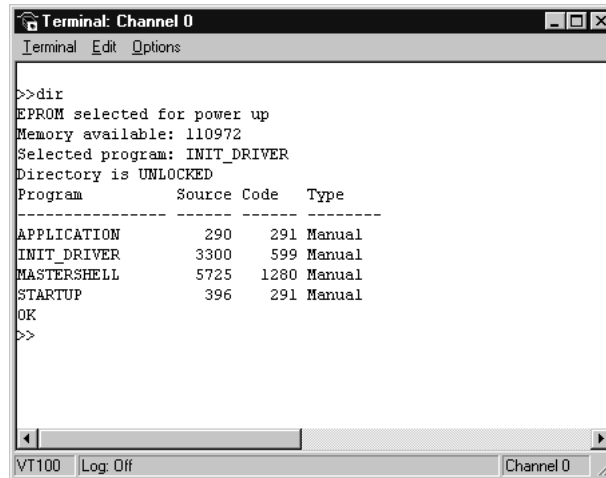

```

Terminal: Channel 0
Terminal Edit Options

>>dir
EPROM selected for power up
Memory available: 110972
Selected program: INIT_DRIVER
Directory is UNLOCKED
Program Source Code Type

APPLICATION 290 291 Manual
INIT_DRIVER 3300 599 Manual
MASTERSHELL 5725 1280 Manual
STARTUP 396 291 Manual
OK
>>

```

Up to four Terminal Windows can be opened simultaneously over the single serial port. Channel 0 must be used to issue commands. Channels 5, 6 and 7 can be used to provide I/O windows to programs running on the MC Unit.

### Channel Number

The Channel Number Combo Box can be used to select one of the valid async communications channels.

### VT100 Emulation

The MC Unit expects to talk to a terminal that accepts the DEC VT100 terminal protocol. This setting can be used for the Terminal Window to emulate a VT100 terminal.

### ASCII Emulation

This mode will echo the ASCII description for the non-printing characters received. Also, CR and LF will cause the corresponding action.

## 7-5-2 Editor

This section describes the Editor used to edit BASIC programs for the MC Unit. The Editor is a fully featured Windows-based tool. An Editor Window will be opened when a new program is created or an existing program is selected for editing.

When the cursor is moved off the current line, any changes made to this line are sent to the MC Unit, which performs syntax checking, tokenises the line (all recognized BASIC keywords are converted to upper case), and returns the tokenised result to the window. When an Editor Window is closed, the project file is updated with the modified program.

**Note** It is not possible to open a new Editor Window while any program is running on the MC Unit.

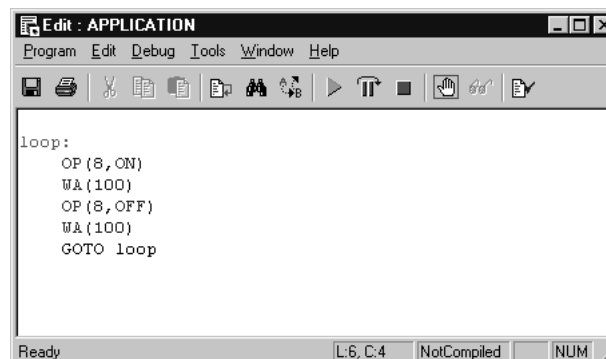

```

Edit : APPLICATION
Program Edit Debug Tools Window Help

loop:
 OP (8, ON)
 WA (100)
 OP (8, OFF)
 WA (100)
 GOTO loop

```

## Creating and Opening Programs

There are several ways that programs can be opened or created.

### Opening Programs

Existing programs can be edited by opening an Editor Window using one of the following methods.

- Select **Edit** from the Program Menu and then selecting the required program.
- Click the Edit Button on the Control Panel to open an Editor Window for the selected program.
- Double-click a program in the Program List Box on the Control Panel.

### Creating Programs

New programs can be created using one of the following methods.

- Select **New** from the Program Menu. The default name can be changed before opening the Editor Window. Click into the Program Name Text Box, enter the new name and then press the Edit Button.
- Click the Create New program button on the Control Panel.

When opening an Editor Window, Motion Perfect performs a CRC check between the program on the MC Unit and the program in the project. If the CRCs are different, the user will be advised to perform a project check to obtain further information on the differences.

## Basic Editing Operations

The basic editing operations that can be used in an Editor Window are outlined below. The operation can be accessed by selecting the corresponding button on the top of the Editor Window or can be selected from one of the menu's of the window. The operations correspond to the buttons displayed in the picture below (from left to right).



### Saving Program

This enables the user to force the program to be saved on the computer hard-disk. Motion Perfect saves the file automatically when the Editor Window is closed or the program is compiled.

### Printing Program

This will print the code of the program.

### Cut, Copy and Paste

Windows-style cut, copy paste operation can be performed using the mouse and/or the keyboard. Use the following procedure to cut or copy text.

Select the text, and cut or copy it to the clipboard.

Move the cursor to the insert point, and paste the text on the clipboard.

### Listing and Jumping to Labels

A list of all labels in the program in the current Editor Window will be displayed. To jump to a specific label, click the desired label in the display to enter it in the text box at the bottom of the window and press the OK button. The cursor will move to the specified label in the program. Alternatively, a specific line number can be selected by entering the value of the line number text box at the bottom of the window, and the pressing the OK button.

### Finding Text

The program in the current Editor Window can be searched for a specific text string. One can specify the search to be case sensitive and the search direction. The user can continue the program while the Find Window is displayed, by simply clicking back to the Editor Window. The Find Window will remain on the display until the Cancel Button is clicked.

**Replacing Text**

Text found in an Editor Window can be replaced with a specified text string. Enter both strings in the appropriate fields. The following buttons are available in the Find and Replace Window:

| Button     | Function                                                                                                                                                            |
|------------|---------------------------------------------------------------------------------------------------------------------------------------------------------------------|
| FindNext   | A simple search will be made for the specified string.                                                                                                              |
| Replace    | A specified search string will be replaced with a replace string.                                                                                                   |
| ReplaceAll | All occurrences of the search string will be replaced from the current cursor position to the beginning or end of the program, depending upon the search direction. |

**Run, Step and Stop**

These operations are used to run the program, run a single line in the program and stop the program. These operations can also be found on the control panel (same buttons).

**Add breakpoint**

In the Editor Window breakpoints can be added to enable easy debugging. Debugging is explained in the Debugging part of this section below.

**Compiling**

This operation forces the program to be compiled.

**Debugging**

The Motion Perfect debugger allows you to run a program directly from the Editor Window in a special trace mode, executing one line at a time (known as stepping) whilst viewing the line in the window. It is also possible to set breakpoints in the program, and run it at normal speed until it reached the breakpoint.

Any open Editor Windows will automatically enter the 'Debug Mode - Read Only' when programs are running on the Motion Controller. Hence, breakpoints are set in the Editor Window, and the code viewed in the same window in debug mode when the program is running.

**Stepping Through a Program**

The next line in a program can be executed by doing one of the following:

- Use the Step button (yellow) alongside the required program name in the Program List box on the Control Panel.
- If the required program is currently selected, see Selected Program box of the Control Panel, then push the Step button of this box.
- Push the Step button of the Editor Window toolbar.
- Selecting Start Stepping... from the Program menu. If one program is executing on several tasks, then the task number can also be specified.

The next program line to be executed will be highlighted in the Editor Window with a green background. The operation can be repeated to step multiple lines.

**Breakpoints**

Breakpoints are special place markers in the code which allow us to identify a particular section (or sections) of the program when debugging the code. At the point on which the breakpoint is inserted, the program will pause and return control to Motion Perfect. This is enabling to check the current state of the controller or single step through the code of the program. Breakpoints are indicated in the program using the TRON command.

Breakpoints can be set by moving the cursor to the required line, and then either

- Typing command TRON on this line.
- Pushing the Add Breakpoint button on the Editor Window toolbar.
- Selecting **Toggle Breakpoint** from the Program Menu.
- Pressing Ctrl-B from the keyboard.

A TRON command will be inserted at the current line in the program, indicated by highlighting. The breakpoint can be removed to selecting the same

operation again or to just by removing the line manually. All breakpoints can be removed from a program by selecting **Clear All Breakpoints** from the Debug Menu.

### 7-5-3 Axis Parameters

The Axis Parameters Window allows the user to set and read the axis parameter settings. This window works like a Windows-based spread sheet. The Axis Parameter Window is shown below.

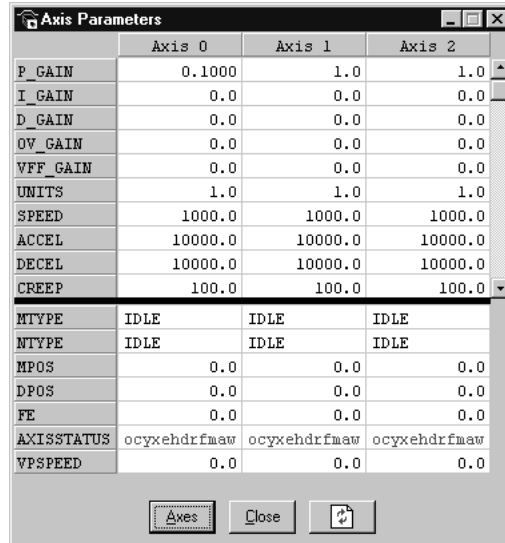

The Axis Parameters Window is made up of a table of cells separated into two banks, bank 1 at the top and bank 2 at the bottom.

- Bank 1 contains the values of parameters that can be changed by the user. The values can be changed by clicking on it and entering the new value.
- Bank 2 is read-only and contains the values which are set by the system software of the MC Unit as it processes the BASIC commands and monitors the status. These values are updated continuously at a specified rate.

The following operations are possible on the Axis Parameters Window.

- The user is able to change the size of the window. The black dividing bar can be repositioned to change the space occupied by the two banks.
- When the user changes the UNITS parameter for an axis, all the parameters given in user units for that axis will be adjusted by the new factor. These new values will be loaded automatically in the screen.
- The AXISSTATUS parameter field displays the axis status bits. The characters indicating each bit will turn red and capital if the bit is ON and green if the bit is OFF. The 'ocyxehdrfmaw' characters correspond to

|   |                                  |
|---|----------------------------------|
| w | Following Error Warning          |
| a | Servo Driver Communication Error |
| m | Servo Driver Alarm               |
| f | Forward Limit                    |
| r | Reverse Limit                    |
| d | Datuming                         |
| h | Feed Hold Input                  |
| e | Following Error Limit            |
| x | Forward Software Limit           |
| y | Reverse Software Limit           |

|   |                       |
|---|-----------------------|
| c | Cancelling Move       |
| o | Encoder Out Overspeed |

- The Axes Button at the bottom of the window can be pressed to access a Window to select the axes that are displayed. By default, the axes set for the last modified start-up program from the File Menu, Jog Axes Window or Axes Parameters Window will be displayed.
- The parameters in the bank 1 section are only read when the screen is first displayed or the parameter is edited by the user. It is possible that if a parameter is changed in the controller then the value displayed may be incorrect. The refresh button will force Motion Perfect to read the whole selection again.

### 7-5-4 Controller Configuration

The Controller Configuration Window shows the hardware and software configuration of the MC Unit. The MC Unit configuration can be checked by selecting Controller Configuration from the Controller Menu or the appropriate button of the Control Panel.

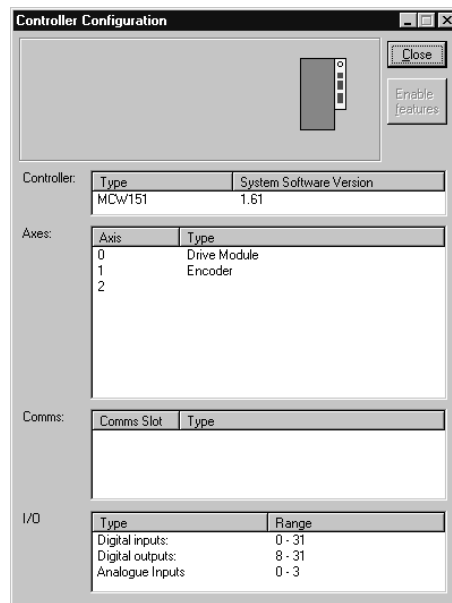

### 7-5-5 VR and Table Editors

The VR and Table Editor tools provide a spreadsheet style interface to view and modify a range of values in memory. To modify a value, click on the existing value with the mouse and type in the new value and press return. The



change will be immediate and can be made whilst programs are running. Push the refresh button to reload the values.

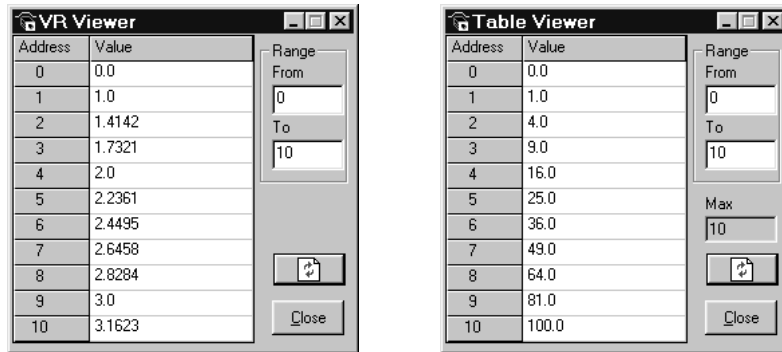

**Range**

Both in the VR and Table Editor you can select the range of the view by giving the begin and end element. The range of the Table Editor is limited to the highest element, which is specified by the TSIZE system parameter. Both editor show up to a maximum of 100 elements. Use the scroll bar to scroll through the data.

**Refresh Button**

The editors do not update the shown values automatically. Push the Refresh Button to update the values of the elements or when you have changed the range of elements.

**7-5-6 I/O Status Window**

The I/O Status Window allows the user to view the status of all the I/O points and toggle the status of the output points. The I/O Status Window is shown in the centre of the screen below. Refer to 5-3 Motion Execution for a description of the different types of I/O.

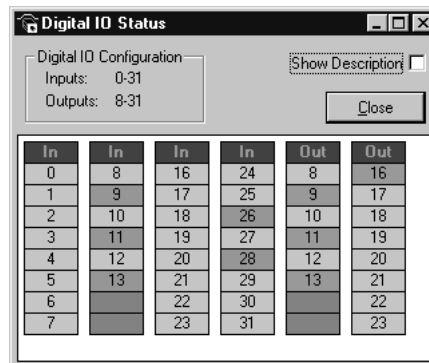

**Digital Inputs**

This shows the total range of input channels on the current Motion Controller.

**Digital Outputs**

This shows the total range of output channels on the current Motion Controller.

**IN**

These banks show the status of the inputs of the Motion Controller. Each bank contains 8 indicators which show the status of the inputs.

**OUT**

These banks show the status of the outputs of the Motion Controller. Each bank contains 8 indicators which show the status of the outputs. These output points can be put ON or OFF by clicking on the indicators.

Refer to 3-3-2 Digital I/O for details on the MC Unit input and output mappings. The in- and outputs can be accessed by using controller commands IN and OP. Refer to 6-3-99 IN and 6-3-132 OP.

### 7-5-7 Full Controller Directory

The Full Controller Directory Window dynamically shows details of all programs on the MC Unit, and details of all running tasks or processes. The window can be opened by selecting **Full Directory** from the Program Menu or the appropriate button on the Control Panel.

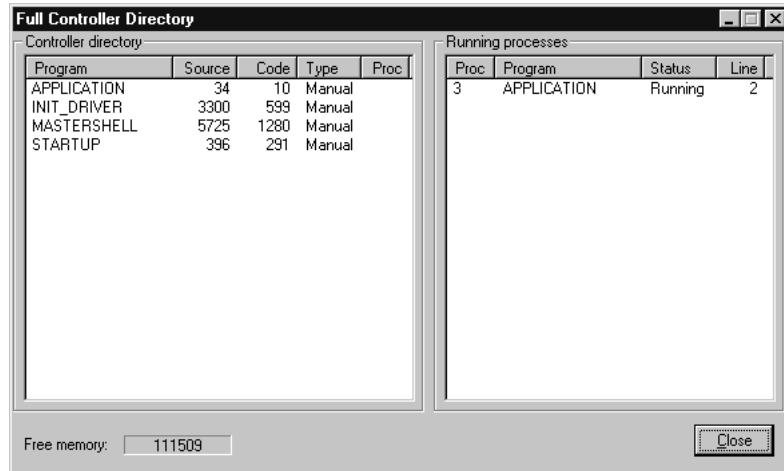

### 7-5-8 Jog Screen

The Jog Screen can be used to set-up and operate the jogging operation of the motion controller with the bi-directional virtual I/O. The screen sets the axis parameters corresponding to jogging (FWD\_JOG, REV\_JOG and JOGSPEED) and controls the virtual inputs which are set to jogging. This tool will not use the Fast Jog feature of the controller and therefore the FAST\_JOG parameter is assumed to be -1.

**Note** The jogging inputs which are connected are considered to be active low (normally closed). This implies that jogging is enabled when the input is low and is disabled when the input is high.

The Jog Screen is shown below.

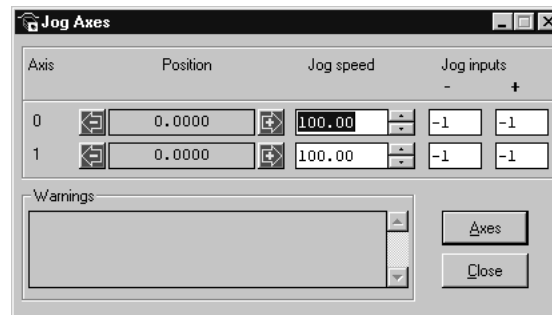

#### Jog Inputs

There are separate inputs for forward and reverse jogging of each axis. When a jog input is set to a valid input number, the corresponding output will be turned ON and then the corresponding FWD\_JOG or REV\_JOG axis parameter will be set.

#### Jog Speed Settings

This is the speed at which the jog will be performed, which is given by the JOGSPEED parameter. The value of the speed is limited to the range from 0 to the demand speed given by the SPEED parameter for this axis. This value can be changed by writing directly to this field or by using the jog speed control (up/down) buttons.

**Jog Buttons**

The screen provides Forward and Reverse Jog Buttons for each axis. When the button is pushed the jogging is activated and the corresponding virtual input will be OFF. Prior to the activation the value of the Jog Speed field will be written to the JOGSPEED parameter. When released this input is ON and the jogging will be stopped.

**Warnings Area**

The Warnings Area shows the status of the last jog request.

When a Jog Button is pressed, a warning will be given for any of the following:

- The axis is a SERVO axis and the servo is OFF
- The jog speed is 0.
- The acceleration or deceleration rate for this axis is 0
- The forward or reverse jog input is out of range
- There is already a move other than a jog being performed on this axis

**7-5-9 Oscilloscope**

The software oscilloscope can be used to trace axis and motion parameters, which is a helpful tool for program development and system setup. The oscilloscope provides four channels, each capable of recording at up to 1,000 samples/s, with manual cycling or program-linked triggering.

The MC Unit records the data at the selected frequency, and then uploads the information to the scope to be displayed. If a larger time base value is used, the data is retrieved in sections, and the trace is seen to be plotted in sections across the display.

**Note**

1. Motion Perfect uses the SCOPE command when running the Oscilloscope function.
2. To minimize calculation time for writing the real-time data, the SCOPE command is writing raw data to the Table array. For example
  - a) The parameters are written in encoder edges (per second) and therefore not compensated for the UNITS conversion factor.
  - b) The MSPEED parameter is written as the change in encoder edges per servo period.
3. Applications like the CAM command, CAMBOX command and the SCOPE command all use the same Table as the data area.

Exactly when the MC Unit starts to record the required data depends upon whether it is in Manual or Program Trigger Mode.

- In Program Trigger Mode, it starts recording data when it encounters a TRIGGER command in a program running on the MC Unit.
- In Manual Mode, it starts recording data immediately.

The Trigger Button can be used to start the scope as soon as the required settings have been made. The scope controls are divided into the two parts: the general controls and the channel specific controls.

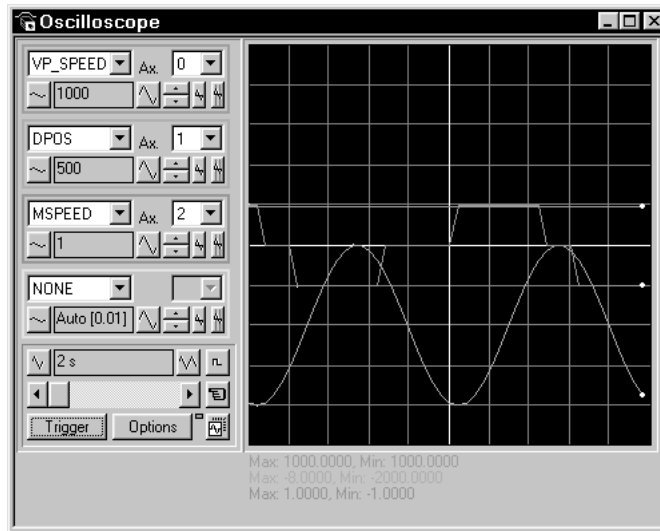

**General Controls**

The oscilloscope general control appear at the bottom left of the oscilloscope window. From here you can control the time base, triggering modes, Table range used and others.



The general controls are explained here:

|                              |                                                                                                                                                                                                                                                                                                                                                                                                                                                                                                                                                                                                                                                                                                                                                                                                                                                                                                                                                                                         |
|------------------------------|-----------------------------------------------------------------------------------------------------------------------------------------------------------------------------------------------------------------------------------------------------------------------------------------------------------------------------------------------------------------------------------------------------------------------------------------------------------------------------------------------------------------------------------------------------------------------------------------------------------------------------------------------------------------------------------------------------------------------------------------------------------------------------------------------------------------------------------------------------------------------------------------------------------------------------------------------------------------------------------------|
| <p>Time base</p>             | <p>The required time base is selected using the up/down scale buttons either side of the current time base scale text box (left hand side button decreases the scale, and the right hand side button increases the scale value.) The value selected is the time per grid division on the display.</p> <p>If the time base is greater than a predefined value, then the data is retrieved from the controller in sections (as opposed to retrieving a complete trace of data at one time.) These sections of data are plotted on the display as they are received, and the last point plotted is seen as a white spot.</p> <p>After the scope has finished running and a trace has been displayed, the time base scale can be changed to view the trace with respect to different horizontal time scales. If the time base scale is reduced, a section of the trace can be viewed in greater detail, with access provided to the complete trace by moving the horizontal scroll bar.</p> |
| <p>Horizontal Scroll Bar</p> | <p>Once the scope has finished running and displayed the trace of the recorded data, only part of the trace will be displayed if the time base is changed to a faster value. The remainder can be viewed by moving the thumb box on the horizontal scroll bar.</p> <p>Additionally, If the scope is configured to record both motion parameters and plot table data, then the number of points plotted across the display can be determined by the motion parameter. If there are additional table points not visible, these can be brought into view by scrolling the table trace using the horizontal scroll bar. The motion parameter trace will not move.</p>                                                                                                                                                                                                                                                                                                                       |

|                                          |                                                                                                                                                                                                                                                                                                                                                                                                                                                                                                                                                                                                                                                                                                                                                                                                                                                                                             |
|------------------------------------------|---------------------------------------------------------------------------------------------------------------------------------------------------------------------------------------------------------------------------------------------------------------------------------------------------------------------------------------------------------------------------------------------------------------------------------------------------------------------------------------------------------------------------------------------------------------------------------------------------------------------------------------------------------------------------------------------------------------------------------------------------------------------------------------------------------------------------------------------------------------------------------------------|
| <p>One-shot/ Continuous Trigger Mode</p> | <p>The One-shot/Continuous Trigger Mode Button toggles between these two modes:<br/> <b>One Shot Trigger Mode (Button raised)</b><br/>                 In One-shot Mode, the scope runs until it has been triggered and one set of data recorded by the MC Unit, retrieved and displayed.<br/> <b>Continuous Trigger Mode (Button pressed)</b><br/>                 In Continuous Mode the scope continues running, retrieving data from the MC Unit each time it is re-triggered and new data is recorded. The scope continues to run until the Trigger Button is pressed for a second time to stop the scope.</p>                                                                                                                                                                                                                                                                         |
| <p>Manual/Program Trigger Mode</p>       | <p>The Manual/Program Trigger Mode Button toggles between these two modes.<br/> <b>Manual Mode (Button raised, pointing hand)</b><br/>                 In Manual Mode, the MC Unit is triggered and starts to record data immediately after the Trigger Button is pressed.<br/> <b>Program Mode (Button pressed, program listing)</b><br/>                 In Program Trigger Mode, the scope starts running when the Trigger Button is pressed. The MC Unit will start recording data when a TRIGGER command is executed in a program running on the MC Unit.<br/>                 After the TRIGGER command is executed by the program and the MC Unit has recorded the required data, the required data is retrieved by the scope and displayed. The scope stops running if in One-shot Trigger Mode, or it waits for the next trigger on the MC Unit if in Continuous Trigger Mode.</p> |
| <p>Trigger Button</p>                    | <p>When the Trigger Button is pressed, the scope will be started. If the scope is Manual Mode then the MC Unit immediately starts recording data. If it is in Program Trigger Mode then the MC Unit waits until it encounters a TRIGGER command in a running program.<br/>                 After the Trigger Button has been pressed, the text on the Button changes to 'Halt' while the scope is running. If the scope is in the One-shot Mode, then after the data has been recorded and plotted on the display, the Trigger Button text will return to 'Trigger', indicating that the operation has been completed.<br/>                 The scope can be halted at any time when it is running by pressing the trigger button (the 'Halt' text is displayed).</p>                                                                                                                       |
| <p>Reset Scope Configuration</p>         | <p>The current scope configuration and all settings will be saved when the scope window is closed, and retrieved when the scope window is next opened. This removes the need to set each individual control again every time the scope window is opened.<br/>                 The Reset Scope Configuration Button can be pressed to reset the scope configuration, clearing all controls to their default values.</p>                                                                                                                                                                                                                                                                                                                                                                                                                                                                      |
| <p>Status Indicator</p>                  | <p>The Status Indicator is located between the Options Button and the Reset Scope Configuration Button. This indicator changes color according to the current status of the scope as follows:<br/>                 Red Scope stopped.<br/>                 Black Waiting for MC Unit to complete recording data.<br/>                 Yellow Retrieving data from the MC Unit.</p>                                                                                                                                                                                                                                                                                                                                                                                                                                                                                                          |

**Channel-specific Controls**

Each scope channel has the following channel-specific controls organized in each of four channel control blocks surrounded by a colored border. The color of the border is the same as the color for the channel trace on the display.



Each channel has the following:

|                               |                                                                                                                                                                                                                                                                                                                                                                                                                                                                                                                                                                                                                                                                                                                                                                                                                                                                                                                                                                                                    |
|-------------------------------|----------------------------------------------------------------------------------------------------------------------------------------------------------------------------------------------------------------------------------------------------------------------------------------------------------------------------------------------------------------------------------------------------------------------------------------------------------------------------------------------------------------------------------------------------------------------------------------------------------------------------------------------------------------------------------------------------------------------------------------------------------------------------------------------------------------------------------------------------------------------------------------------------------------------------------------------------------------------------------------------------|
| Parameter Box                 | <p>The parameters which the scope can record and display are selected using a pull-down list box in the upper left corner of each channel control block.</p> <p>Depending upon the parameter chosen, the next label will switch between axis or channel.</p> <p>It is also possible to plot the points held in the MC Unit Table array directly by selecting the Table parameter, followed by the number of a channel whose first/last points have been configured using the Advanced Options Window, which is described later in this section. If the scope channel is not required then 'NONE' should be selected in the parameter list box.</p>                                                                                                                                                                                                                                                                                                                                                 |
| Axis/Channel List Box         | <p>The Axis/Channel List Box allows the user to select the required axis for a motion parameter, or channel for a digital input/output. The list box label will switch according to the setting in the Parameter List Box.</p>                                                                                                                                                                                                                                                                                                                                                                                                                                                                                                                                                                                                                                                                                                                                                                     |
| Vertical Scale                | <p>The scope vertical scale in units per grid division on the display can be set to either Automatic or Manual Mode.</p> <p>In Automatic Mode, the scope calculates the most appropriate scale when it has finished running and prior to displaying the trace. If the scope is running with continuous triggering, it will initially be unable to select a suitable vertical scale. When this happens, the scope must be halted and re-started, or used in the manual scaling mode.</p> <p>In Manual Mode, the user selects the scale per grid division. The vertical scale is changed by pressing the Up/Down Scale Buttons at the sides of the Current Scale Text Box. The button on the left decreases the scale value, and the button on the right increases the scale value.</p> <p>To return to the Automatic Mode, continue pressing the left button (decreasing the scale value) until the word 'AUTO' appears in the current scale text box.</p>                                          |
| Channel Trace Vertical Offset | <p>The Vertical Offset Buttons are used to move a trace vertically on the display. This control is useful when two or more traces are identical, in which case they will overlay each other and only the uppermost trace will be seen on the display.</p> <p>The offset value will remain in effect for a channel until the Vertical Offset Reset Button is pressed or the scroll bar is used to return the trace to its original position.</p>                                                                                                                                                                                                                                                                                                                                                                                                                                                                                                                                                    |
| Vertical Offset Reset         | <p>The vertical offset value applied using the vertical offset scroll bars can be cleared when the Vertical Offset Reset Button is pressed.</p>                                                                                                                                                                                                                                                                                                                                                                                                                                                                                                                                                                                                                                                                                                                                                                                                                                                    |
| Cursor Button                 | <p>After the scope has finished running and has displayed a trace, the cursor bars can be enabled. These are displayed as two vertical bars of the same color as the channel trace, and initially located at the maximum and minimum trace points. The values these represent are shown below the scope display, and the text is of the same color as the channel the values represent.</p> <p>The bars can be moved by positioning the mouse cursor over the required bar, holding down the left mouse button, and dragging the bar to the required position. The maximum or minimum value shown below the display is updated as the bar is dragged along with the value of the trace at the current bar position.</p> <p>The cursor bars are enabled/disabled by pressing the Cursor Button, which toggles alternately displaying and removing the cursor bars.</p> <p>When the cursor bars are disabled, the maximum and minimum points are indicated by a single white pixel on the trace.</p> |

**Advanced Oscilloscope Configuration Options**

When the Options Button of the General Options is pressed, the Advanced Oscilloscope Configuration Window will be displayed.

|                                           |                                                                                                                                                                                                                                                                                                                                                                                                                                                                                                                                                                                                                                                                                                                                                                                                                                                                                  |
|-------------------------------------------|----------------------------------------------------------------------------------------------------------------------------------------------------------------------------------------------------------------------------------------------------------------------------------------------------------------------------------------------------------------------------------------------------------------------------------------------------------------------------------------------------------------------------------------------------------------------------------------------------------------------------------------------------------------------------------------------------------------------------------------------------------------------------------------------------------------------------------------------------------------------------------|
| <p>Oscilloscope: Samples per Division</p> | <p>The scope defaults to recording five points per horizontal time base grid division. This value can be adjusted using the adjacent scroll bar.</p> <p>To achieve the fastest scope sample rate it is necessary to reduce the number of samples per grid division to 1 and increase the time base scale to its fastest value of 1 ms per grid division.</p> <p>The trace might not be plotted completely to the right side of the display, depending upon the time base scale and number of samples per grid division.</p>                                                                                                                                                                                                                                                                                                                                                      |
| <p>Oscilloscope: Table Range</p>          | <p>The MC Unit records the required parameter data values in the MC Unit's Table array prior to uploading these values to the scope. By default, the lowest scope Table value used is zero. If this conflicts with programs running on the MC Unit that require this section of the Table, then the lower scope table value can be set.</p> <p>The lower scope table value is adjusted by clicking into the text box and entering the new value. The upper scope table value will be automatically updated and cannot be changed by the user.</p> <p>The upper scope table value depends on the number of channels in use and the number of samples per grid division.</p> <p>If an attempt is made to enter a lower table value which causes the upper table value to exceed the maximum permitted value on the MC Unit, then the original value will be used by the scope.</p> |

It is possible to plot MC Unit Table ranges directly with the Oscilloscope. Select Table in the parameter box of the Axis Specific Controls to display the Table elements.

|                                         |                                                                                                                                                       |
|-----------------------------------------|-------------------------------------------------------------------------------------------------------------------------------------------------------|
| <p>Table Graph: Points per division</p> | <p>The scope defaults to recording fifty points per horizontal time base grid division. This value can be adjusted using the adjacent scroll bar.</p> |
| <p>Table Graph: Table Range</p>         | <p>The Table Limit Text Boxes are used to enter the Table ranges for the four possible channels of the Oscilloscope.</p>                              |

**Parameter Checks**

There is a maximum Table size on the MC Unit, and it is not possible to enter Table channel values beyond this value. It is also not possible to enter a lower scope table value or increase the samples per grid division to a value which causes the upper scope Table value to exceed the MC Unit maximum Table value.

If the number of samples per grid division is increased, and subsequently the time base scale is set to a faster value, causing an unobtainable resolution, the scope will automatically reset the number of samples per grid division.

**Displaying MC Unit Table Points**

If the scope is configured for both Table and motion parameters, then the number of points plotted across the display is determined by the time base and samples per division. If the number of points to be plotted for the table parameter is greater than the number of points for the motion parameter, the additional table points will not be displayed, but can be viewed by scrolling the table trace using the horizontal scroll bar. The motion parameter trace will not move.

**Uploading Data from the MC Unit to the Scope**

If the overall time base is greater than a predefined value, then the data is retrieved from the MC Unit in blocks, and the display can be seen to be updated in sections. The last point plotted in the current section will be displayed as a white spot.

If the scope is configured both to record motion parameters and to plot Table data, then the Table data is returned in one complete block, and the motion

parameters are read either continuously or in block, depending upon the time base.

Even if the scope is in Continuous Trigger Mode, the Table data is not re-read; only the motion parameters are continuously read from the MC Unit.

#### Enabling/Disabling Scope Controls

While the scope is running, all the scope controls except the Trigger Button will be disabled. To change the time base or vertical scale, the scope must be stopped and restarted.

#### Display Accuracy

The MC Unit records the parameter values at the required sample rate in the Table, and then passes the information to the scope. The trace displayed is therefore accurate with respect to the selected time base. There is, however, a delay between when the data is recorded by the MC Unit and when it is displayed on the scope due to the time taken to upload the data via the serial link.

## 7-6 Suggestions and Precautions

#### Programming and Program Control

When using Motion Perfect, please consider the following items:

- Motion Perfect provides complete programming functions, such as edit, delete, rename, create, select and copy functions. When available, these should be used instead of the equivalent BASIC system commands in the Terminal Window. Motion Perfect cannot detect changes made by these BASIC system commands and a project check will be required to resolve inconsistencies.
- Use **Reset the Controller** on the MC Unit Menu to perform a software reset of both the MC Unit and the Servo Driver (as DRV\_RESET command).
- You do not need to close an Editor Window to run a program. It saves time not to. It is better to open an edit session for each program you want to see before running any programs. If there are programs already running, then it will not be possible to open an edit session.
- Do not turn the power ON and OFF or remove the serial connection when using Motion Perfect. If you do so, a communications error message will appear, and Motion Perfect will go off-line.
- You can force Motion Perfect to compare the computer project with the MC Unit programs at any time by selecting **Check project** from the File Menu.

#### Running Motion Perfect Off-line

Motion Perfect can be run in an off-line mode if it is unable to find a MC Unit and open a valid project. This may occur if it does not find any MC Units connected to the computer or if the project consistency check fails and the check is canceled.

In the offline mode, all project-related functions will be disabled. The user will only have access to

- Terminal Window (VT100 emulation).
- System software load.
- Communications setup.

A Terminal Window can be opened and an attempt can be made to establish communications with the MC Unit. If the MC Units line mode >> prompt is returned when the Enter Key is pressed, then the MC Unit can be communicated with using the BASIC system commands (see the BASIC on-line help for further information). The commands given in *6-2-4 Program Commands and Functions* can be used to manipulate programs using a terminal.

#### Project Backups

If the MC Unit stops responding during a development session and the same project is reconnected, then it is likely the consistency check will be passed.



In the case that the programs are not consistent, the Check Project Options Window will be displayed. Please be aware that if the current project is re-opened, the backup copy of the project will be overwritten. It is therefore necessary to determine which copy of the programs to use before re-connecting Motion Perfect.

To investigate the inconsistency further, a Terminal Window can be opened off-line and the programs on the MC Unit can be listed. Any computer-based editor or word processor can be used to examine the computer backup project file copy of the programs. In this way, the location of the uncorrupted or latest version of the programs can be identified. The correct program can be imported to the project by using the Load Program File option of the Project Menu.

The computer project copy of a program is updated during a Motion Perfect development session whenever an edit session for the program is closed.

### Retrieving Backup

If you want to abandon changes made during a development session and reload the backup copy made at the start of the session, then select **Revert to Backup** from the Project Menu.

### Downloading Firmware

The MC Unit has Flash memory for storage of both user programs and the system software. From Motion Perfect it is possible to upgrade the software to a newer version using a system file.

Select the 'Load System Software' option from the controller menu and a warning dialog will be presented to ensure the current project has been saved the user wishes to continue. Press OK and select the file which needs to be loaded.

 **Caution** Do not download any firmware to the MC Unit that has not been distributed by OMRON or that has not been authorized and approved by OMRON for downloading into the MCW151 series. Failure to do so may result in permanent or temporary malfunction of the Unit or unexpected behaviour.

Downloading will take several minutes, depending on the speed of the personal computer. When the download is complete, a checksum is performed to ensure that the download process was successful, and a confirmation screen will be presented to store the software into Flash memory. The controller will take a few moments to store the software.

 **WARNING** During the process of storing the software into Flash memory the power must NEVER be interrupted. If power is interrupted the MC Unit may disfunction and has to be returned to OMRON for repair.

If the storing has been completed the unit is back to normal operation. At this point you can check the controller configuration to confirm the new software version.

# SECTION 8

## Troubleshooting

This section describes error processing and troubleshooting procedures needed to keep the system operating properly.

|       |                                       |     |
|-------|---------------------------------------|-----|
| 8-1   | Error Indicators .....                | 220 |
| 8-2   | Error Handling .....                  | 221 |
| 8-2-1 | MC Unit Error Handling.....           | 221 |
| 8-2-2 | Servo Driver Alarms.....              | 225 |
| 8-3   | Problems and Countermeasures .....    | 227 |
| 8-3-1 | General Problem Solving .....         | 227 |
| 8-3-2 | DeviceNet Slave Problem Solving ..... | 230 |

# 8-1 Error Indicators

## MC Unit Indicators

The following errors are displayed at the LED indicators at the top of the MC Unit's front panel.

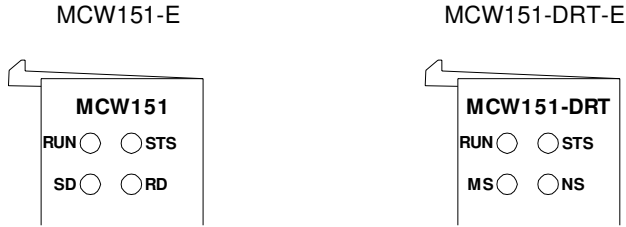

### ■ General Indicators

| RUN      | STS      | Error                                                            | Remedy                                                                    |
|----------|----------|------------------------------------------------------------------|---------------------------------------------------------------------------|
| ON       | ---      | (Normal)                                                         | ---                                                                       |
| OFF      | OFF      | The MC Unit is defective.                                        | Replace the MC Unit.                                                      |
| ---      | Flashing | A motion error has occurred. The Servo Driver has been disabled. | Check what caused the error, correct the problem and restart application. |
| Flashing | Flashing | An error occurred in the communication with the Servo Driver.    | Check what caused the error, correct the problem and cycle the power.     |

### ■ DeviceNet Indicators (MCW151-DRT-E only)

The following table lists probable causes and remedies for errors that occur in the Slave Unit.

| Display/Indicator status |                  | Network status                                                  | Probable cause and remedy                                                                                                                                                                                                                             |
|--------------------------|------------------|-----------------------------------------------------------------|-------------------------------------------------------------------------------------------------------------------------------------------------------------------------------------------------------------------------------------------------------|
| MS                       | NS               |                                                                 |                                                                                                                                                                                                                                                       |
| ON (green)               | ON (green)       | Remote I/O or message communication in progress (normal status) | Remote I/O communications and/or message communications are active on the Network.                                                                                                                                                                    |
| ON (green)               | OFF              | Checking for node address duplication                           | Checking whether the Unit's node address has been set on another node.                                                                                                                                                                                |
| ON (green)               | Flashing (green) | Waiting for connection                                          | The Unit is waiting for a connection from the Master Unit.                                                                                                                                                                                            |
| ON (red)                 | OFF              | Watchdog timer error                                            | A watchdog timer error occurred in the Unit. Replace the Unit.                                                                                                                                                                                        |
| Flashing (red)           | OFF              | Incorrect switch settings                                       | A mistake has been made in the switch settings. Check the settings and restart the Slave.                                                                                                                                                             |
| ON (green)               | ON (red)         | Node address duplication                                        | The Slave Unit's node address has been set on another node. Change settings to eliminate the duplication and restart the Slave.                                                                                                                       |
| ON (green)               | ON (red)         | Bus Off error detected                                          | The communications controller detected a Bus Off status and communications have been stopped.<br>Check the following and restart the Slave: Master/Slave baud rates, for loose or broken cables, for noise, cable lengths, and Terminating Resistors. |
| ON (green)               | Flashing (red)   | Communications timeout                                          | The connection with the Master Unit timed out.<br>Check the following and restart the Slave: Master/Slave baud rates, for loose or broken cables, for noise, cable lengths, and Terminating Resistors.                                                |

**Servo Driver Indicators**

The Servo Driver provides a Display Area and two LED indicators.

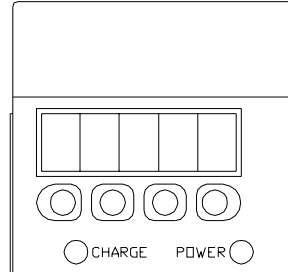

■ **Servo Driver Display Area**

The Servo Driver Display Area displays among others status, alarm signals, parameters in five digits 7-segment LED. A summary of the symbol display contents is given in the following table.

| Symbol display | Contents                                                         |
|----------------|------------------------------------------------------------------|
| bb             | Base block (no power to Servomotor, Servo Driver is not enabled) |
| run            | Operating (power to Servomotor, Servo Driver is enabled)         |
| Pot            | Forward rotation prohibited (POT (Forward limit switch) is OFF)  |
| Not            | Reverse rotation prohibited (NOT (Reverse limit switch) is OFF)  |
| A.□□           | Alarm display                                                    |

■ **Servo Driver Indicators**

| Symbol | Name                   | Color | Function                                        |
|--------|------------------------|-------|-------------------------------------------------|
| POWER  | Power supply indicator | Green | Lit when control power supply is normal.        |
| CHARGE | Charge indicator       | Red   | Lit when main-circuit power supply is charging. |

## 8-2 Error Handling

### 8-2-1 MC Unit Error Handling

**Motion Error**

The MC Unit is continuously checking for error conditions during operation, parallel to all running processes. If a motion error occurs, the Servo Driver will be disabled by using the RUN (Servo ON) signal to the Servo Driver.

A motion error will occur when the AXISSTATUS state for one of the axes matches the ERRORMASK parameter setting (defined by the user) of that axis. The Servo ON signal (WDOG) will be turned OFF, the MOTION\_ERROR parameter will be set to 1 and the ERROR\_AXIS parameter will contain the number of the first axis to have the error condition. The motion error can be cleared by using the DATUM(0) command or performing a system reset by using the DRV\_RESET command.

The relevant parameters and commands are given here.

| Parameter  | Description                                                                                                           |
|------------|-----------------------------------------------------------------------------------------------------------------------|
| WDOG       | The WDOG system parameter is the software switch used to control the Driver Servo ON input, which enables the driver. |
| AXISSTATUS | The AXISSTATUS axis parameter contains the current status bits of an axis.                                            |

| Parameter    | Description                                                                                                                                                                                                                                                            |
|--------------|------------------------------------------------------------------------------------------------------------------------------------------------------------------------------------------------------------------------------------------------------------------------|
| ERRORMASK    | The ERRORMASK axis parameter enables to user to determine which condition will generate a motion error for each axis.<br>If the result of a bitwise AND operation of the ERRORMASK and AXISSTATUS parameter value for one axis is non-zero, a motion error will occur. |
| MOTION_ERROR | The MOTION_ERROR system parameter will be ON when a motion error has occurred.                                                                                                                                                                                         |
| ERROR_AXIS   | The ERROR_AXIS system parameter contains the axis number for which the detected motion error has occurred.                                                                                                                                                             |
| DATUM        | The DATUM(0) will clear the motion error. The AXISSTATUS status will be cleared.                                                                                                                                                                                       |
| DRV_RESET    | DRV_RESET will software reset both the Servo Driver as the MC Unit.                                                                                                                                                                                                    |

■ **Axis Status Definition**

The axis status for each axis is defined using the AXISSTATUS axis parameter. The AXISSTATUS axis parameter definition for the three axes is shown in the following table. The default value of ERRORMASK for all axes is 268. Note that the ERRORMASK parameter can be set separately for each axis.

| Bit | Description                      | Value | Character (as used in Motion Perfect) | Axis 0 (Servo Driver) | Axis 1 (Encoder in/out, virtual) | Axis 2 (Virtual) |
|-----|----------------------------------|-------|---------------------------------------|-----------------------|----------------------------------|------------------|
| 0   | -                                | 1     | -                                     | -                     | -                                | -                |
| 1   | Following Error Warning          | 2     | w                                     | x                     | -                                | -                |
| 2   | Servo Driver Communication Error | 4     | a                                     | x                     | -                                | -                |
| 3   | Servo Driver Alarm               | 8     | m                                     | x                     | -                                | -                |
| 4   | Forward Limit                    | 16    | f                                     | x                     | x                                | x                |
| 5   | Reverse Limit                    | 32    | r                                     | x                     | x                                | x                |
| 6   | Datuming                         | 64    | d                                     | x                     | x                                | x                |
| 7   | Feed Hold Input                  | 128   | h                                     | x                     | x                                | x                |
| 8   | Following Error Limit            | 256   | e                                     | x                     | -                                | -                |
| 9   | Forward Software Limit           | 512   | x                                     | x                     | x                                | x                |
| 10  | Reverse Software Limit           | 1024  | y                                     | x                     | x                                | x                |
| 11  | Cancelling Move                  | 2048  | c                                     | x                     | x                                | x                |
| 12  | Encoder Out Overspeed            | 4096  | o                                     | -                     | x                                | -                |

■ **Servo Driver Alarm**

If the Servo Driver detects an error, it will generate an alarm. The MC Unit provides the following utilities to detect the Servo Driver alarm:

- The Servo Driver Alarm bit (no. 3) of the AXISSTATUS axis parameter for axis 0 will be set. Also input no. 24 will be set.
- The DRV\_STATUS system parameter will contain the Servo Driver alarm code (in hex). During normal operation DRV\_STATUS will have value 99 Hex.

Refer to the Servo Driver manual for appropriate alarm countermeasures. Cancel the alarm using one of the following methods.

- Perform the DRV\_CLEAR command in the MC Unit. Please note that this is only able to cancel some of the alarm states.
- Turn OFF the power supply (both the Servo Driver and MC Unit), and turn it ON again.

If the alarm is canceled while the Servo ON signal (WDOG) is still ON, the Servo Driver will start as soon as the alarm is cleared, which is dangerous. Be sure to turn OFF the WDOG system parameter before cancelling the alarm.

■ **Servo Driver Warning**

If the Servo Driver detects a warning (e.g., overload warning or regenerative overload warning), MC Unit Warning input no. 25 will be set and the code is defined in the DRV\_STATUS parameter. The Servo Driver will not be disabled and operation will continue.

■ **Servo Driver Communication Error**

When during start-up or operation the MC Unit detects an error in the communication interface to the Servo Driver, the AXISSTATUS bit 2 is set and a motion error is generated (if ERRORMASK bit 2 is set).

When the interface to the Servo Driver is lost, the following data and operations are invalid and therefore should not be used:

- Servo Driver analog monitor signals (AIN0, AIN1, AIN2 and AIN3)
- Servo Driver digital inputs (inputs 16 to 31)
- Commands DRV\_READ and DRV\_WRITE (will give BASIC error)
- Commands DRV\_RESET and DRV\_CLEAR

Although the MC Unit will attempt to re-establish the communication after detecting the error during operation, it is strongly advisable to put the system in a fail-safe halt.

When the communication is re-established, the user has the possibility to execute the DRV\_RESET or DRV\_CLEAR command to clear the error. However, if the communication is still down, this will hang the program task.

**Run-time BASIC Errors**

Run-time BASIC errors will stop the program or will go into the error routine as defined by BASICERROR. The following parameters are relevant when checking a run-time error.

| Parameter  | Description                                                                                                     |
|------------|-----------------------------------------------------------------------------------------------------------------|
| BASICERROR | The BASICERROR command traps the error and allows the control of the program to go to an error handling routine |
| ERROR_LINE | The ERROR_LINE parameter which shows which line in the program has encountered the error.                       |
| RUN_ERROR  | The RUN_ERROR shows the identity number of the actual error.                                                    |

The table below shows a list of the different types of BASIC run-time errors which are detected.

| Error No. | Message Displayed               | Error No. | Message Displayed                     |
|-----------|---------------------------------|-----------|---------------------------------------|
| 1         | Command not recognized          | 42        | UNTIL without previous REPEAT         |
| 2         | Invalid transfer type           | 43        | Variable expected                     |
| 3         | Error programming Flash         | 44        | TO expected after FOR                 |
| 4         | Operand expected                | 45        | Too many nested FOR/NEXT              |
| 5         | Assignment expected             | 46        | NEXT without FOR                      |
| 6         | QUOTES expected                 | 47        | UNTIL/IDLE expected after WAIT        |
| 7         | Stack overflow                  | 48        | GOTO/GOSUB expected                   |
| 8         | Too many named variables        | 49        | Too many nested GOSUB                 |
| 9         | Divide by zero                  | 50        | RETURN without GOSUB                  |
| 10        | Extra characters at end of line | 51        | LABEL must be at start of line        |
| 11        | ] expected in PRINT             | 52        | Cannot nest one line IF commands      |
| 12        | Cannot modify a special program | 53        | Label not found                       |
| 13        | THEN expected in IF/ELSEIF      | 54        | LINE NUMBER cannot have decimal point |

| <b>Error No.</b> | <b>Message Displayed</b>              | <b>Error No.</b> | <b>Message Displayed</b>                          |
|------------------|---------------------------------------|------------------|---------------------------------------------------|
| 14               | Error erasing Flash                   | 58               | Program already exists                            |
| 15               | Start of expression expected          | 59               | Process already selected                          |
| 16               | ) expected                            | 60               | Duplicate axes not permitted                      |
| 17               | , expected                            | 61               | PLC type is invalid                               |
| 18               | Command line broken by ESC            | 62               | Evaluation error                                  |
| 19               | Parameter out of range                | 63               | Reserved keyword not available on this controller |
| 20               | No process available                  | 64               | VARIABLE not found                                |
| 21               | Value is read only                    | 65               | Table index range error                           |
| 22               | Modifier not allowed                  | 66               | Table is full                                     |
| 24               | Command is command line only          | 67               | Invalid line number                               |
| 25               | Command runtime only                  | 68               | String exceeds permitted length                   |
| 26               | LABEL expected                        | 70               | Value is incorrect                                |
| 27               | Program not found                     | 71               | Invalid I/O channel                               |
| 28               | Duplicate label                       | 72               | Value cannot be set.                              |
| 29               | Program is locked                     | 73               | Directory not locked                              |
| 30               | Program(s) running                    | 74               | Directory already locked                          |
| 31               | Program stopped                       | 75               | Program not running on this process               |
| 32               | Cannot select program                 | 76               | Program not running                               |
| 33               | No program selected                   | 77               | Program not paused on this process                |
| 34               | No more programs available            | 78               | Program not paused                                |
| 35               | Out of memory                         | 79               | Command not allowed when running Motion Perfect   |
| 36               | No code available to run              | 80               | Directory structure invalid                       |
| 37               | Command out of context                | 81               | Directory is locked                               |
| 38               | Too many nested structures            | 82               | Cannot edit program                               |
| 39               | Structure nesting error               | 83               | Too many nested OPERANDS                          |
| 40               | ELSE/ELSEIF/ENDIF without previous IF | 84               | Cannot reset when drive servo on                  |
| 41               | WEND without previous WHILE           | 86               | Drive interface requires re-power up              |
| 56               | Invalid use of \$                     | 89               | Network timeout                                   |
| 57               | VR(x) expected                        | 92               | Invalid program name                              |

**Host Link Master**

For the Host Link master protocol, any error with communication can be read from the status represented by the HLM\_STATUS parameter. In the process of sending a Host Link command and receiving a response several problems may occur:

1. The slave detects an error within the command and will send a corresponding end code indication.
2. The slave cannot decode the command header code and sends a IC response.
3. The master detects an error within the response. The corresponding end code will be defined in the status.

4. The timeout time has elapsed for the master.

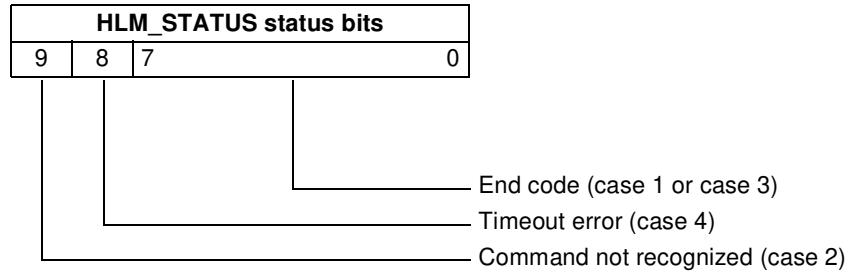

If no error did occur the HLM\_STATUS will have value 0. In case of a non-zero value, any appropriate action such as a re-try or emergency stop needs to be programmed in the user BASIC program.

### 8-2-2 Servo Driver Alarms

The Servo Driver Front Panel Display Area will display if an alarm is generated in the Servo Driver. The display will display an A.□□ number on screen.

#### Alarm Table

The Servo Driver alarms related to the option boards such as the MCW151 are given in the following table. Refer to the *OMNUC W-series user's manual (I531)* for specific details on other alarms and how to resolve them.

| Display | Error                    | Description                                        |
|---------|--------------------------|----------------------------------------------------|
| A.□□    | See Servo Driver manual. | -                                                  |
| A.E0    | MC Unit Initiation Error | No MC unit has been mounted.                       |
| A.E1    | MC Unit Timeout Error    | No response from the MC Unit.                      |
| A.E2    | WDC Error of MC Unit     | There is an error in the MC Unit watchdog counter. |
| A.E7    | MC Unit Detection Error  | No MC Unit has been mounted.                       |

#### Alarm Description

##### ■ A.E0

A.E0: No MC Unit

#### Display and Outputs

| Alarm Outputs      |      |      |            |
|--------------------|------|------|------------|
| Alarm Code Outputs |      |      | ALM Output |
| ALO1               | ALO2 | ALO3 |            |
| OFF                | ON   | ON   | OFF        |

**Note** OFF: Output transistor is OFF (alarm state). ON: Output transistor is ON.

#### Status and Remedy for Alarm

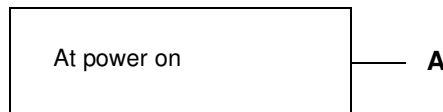

| Cause |                           | Remedy              |
|-------|---------------------------|---------------------|
| A     | The MC Unit is defective. | Replace the MC Unit |

##### ■ A.E1

A.E1: MC Unit Timeout



**Display and Outputs**

| Alarm Outputs      |      |      |            |
|--------------------|------|------|------------|
| Alarm Code Outputs |      |      | ALM Output |
| ALO1               | ALO2 | ALO3 |            |
| OFF                | ON   | ON   | OFF        |

**Note** OFF: Output transistor is OFF (alarm state). ON: Output transistor is ON.

**Status and Remedy for Alarm**



| Cause |                           | Remedy              |
|-------|---------------------------|---------------------|
| A     | The MC Unit is defective. | Replace the MC Unit |

■ **A.E2**

A.E2: WDC Error of MC Unit

**Display and Outputs**

| Alarm Outputs      |      |      |            |
|--------------------|------|------|------------|
| Alarm Code Outputs |      |      | ALM Output |
| ALO1               | ALO2 | ALO3 |            |
| OFF                | ON   | ON   | OFF        |

**Note** OFF: Output transistor is OFF (alarm state). ON: Output transistor is ON.

**Status and Remedy for Alarm**

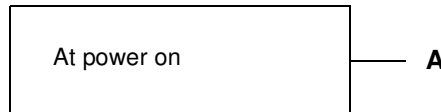

| Cause |                           | Remedy              |
|-------|---------------------------|---------------------|
| A     | The MC Unit is defective. | Replace the MC Unit |

■ **A.E7**

A.E7: MC Unit Detection Error when Servo Driver is turned ON.

A.E7 occurs when Servo Driver is used after disconnection of MC Unit without clearing the unit detection.

**Display and Outputs**

| Alarm Outputs      |      |      |            |
|--------------------|------|------|------------|
| Alarm Code Outputs |      |      | ALM Output |
| ALO1               | ALO2 | ALO3 |            |
| OFF                | ON   | ON   | OFF        |

**Note** OFF: Output transistor is OFF (alarm state). ON: Output transistor is ON.

Status and Remedy for Alarm

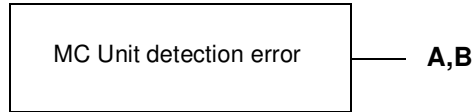

| Cause |                                      | Remedy                                                                       |
|-------|--------------------------------------|------------------------------------------------------------------------------|
| A     | The MC Unit is not mounted properly. | Check that MC Unit mounted correctly.                                        |
| B     | The MC Unit is not mounted.          | Execute Fn014 (option unit detection result clear) and then cycle the power. |

## 8-3 Problems and Countermeasures

### 8-3-1 General Problem Solving

The following table shows possible problems which may occur and the possible solution.

| No. | Problem                                                               | Probable causes                                                                               | Items to check                                                                  | Remedy                                                                                                                                                            |
|-----|-----------------------------------------------------------------------|-----------------------------------------------------------------------------------------------|---------------------------------------------------------------------------------|-------------------------------------------------------------------------------------------------------------------------------------------------------------------|
| 1   | None of the MC Unit's indicators are lit when the power is turned ON. | Power supply lines are wired incorrectly.                                                     | Check the power supply wiring.                                                  | Correct the power supply wiring.                                                                                                                                  |
| 2   |                                                                       | The power supply voltage is low.                                                              | Check the power supply voltage.                                                 | Check the power supply capacity and correct the power supply.                                                                                                     |
| 3   |                                                                       | The power supply is defective.                                                                | Check the power supply.                                                         | Replace the power supply.                                                                                                                                         |
| 4   | None of the Servo Driver's indicators are lit.                        | Power supply lines are wired incorrectly.                                                     | Check the power supply wiring.                                                  | Correct the power supply wiring.                                                                                                                                  |
| 5   |                                                                       | The power supply voltage is low.                                                              | Check the power supply voltage.                                                 | Check the power supply capacity and correct the power supply.                                                                                                     |
| 6   |                                                                       | The power supply is defective.                                                                | Check the power supply.                                                         | Replace the power supply.                                                                                                                                         |
| 7   | Motion Perfect cannot connect to the MC Unit.                         | Serial communications cable is not connected properly.                                        | Check the cable connection and wiring.                                          | Correct the cable wiring. Replace cable if necessary.                                                                                                             |
| 8   |                                                                       | Motion Perfect serial communications settings are different from the MC Unit settings.        | Check Motion Perfect settings.                                                  | Correct the settings or set the settings to default and reset the MC Unit. Default settings of the Unit is 9600 baud, 7 data bits, even parity and two stop bits. |
| 9   |                                                                       | A program is running which is printing to the port and interfering Motion Perfect's protocol. | Check the MC Unit by using a VT100 Terminal.                                    | Stop the program (verify if it is safe to do so) by giving command HALT or STOP.                                                                                  |
| 10  |                                                                       | The MC Unit is defective                                                                      | ---                                                                             | Replace the MC Unit.                                                                                                                                              |
| 11  | Driver cannot be enabled.                                             | The MC Unit is not operating.                                                                 | Is the RUN indicator lit?                                                       | Check No. 1                                                                                                                                                       |
| 12  |                                                                       | The MC Unit is indicating a motion error has occurred.                                        | Check the cause of the problem with the AXISSTATUS parameter.                   |                                                                                                                                                                   |
| 13  |                                                                       | The communication between the MC Unit and Servo Driver is malfunctioning.                     | Check both the MC Unit and Servo Driver if they indicate a communication error. | If there is an error, try to find the cause and cycle power of system.                                                                                            |
| 14  |                                                                       | A Servo Driver alarm has been generated.                                                      | Check the contents of the Servo Driver alarm.                                   | If there is an alarm, follow the instructions.                                                                                                                    |
| 15  |                                                                       | The MC Unit is defective.                                                                     | ---                                                                             | Replace the MC Unit.                                                                                                                                              |

| No. | Problem                   | Probable causes                                                                                             | Items to check                                                                                                                                                   | Remedy                                                                                                                           |
|-----|---------------------------|-------------------------------------------------------------------------------------------------------------|------------------------------------------------------------------------------------------------------------------------------------------------------------------|----------------------------------------------------------------------------------------------------------------------------------|
| 16  | Motor is not turning.     | The Servo Driver is not enabled.                                                                            | Check the MC Unit to see whether the Driver is enabled and the servo loop is active (WDOG and SERVO parameters).<br>Check whether the Servo Driver is operating. | Correct the MC Unit settings.<br>Correct the Servo Driver operation.                                                             |
| 17  |                           | The communication between the MC Unit and Servo Driver is malfunctioning.                                   | Check both the MC Unit and Servo Driver if they indicate a communication error.                                                                                  | If there is an error, try to find the cause and cycle power of system.                                                           |
| 18  |                           | The FWD or REV limit switch are set for the Servo Driver or MC Unit.                                        | Check the limit switch inputs.                                                                                                                                   | Turn OFF the Servo Driver run prohibit input.<br>Make the setting so that the Servo Driver run prohibit inputs will not be used. |
| 19  |                           | The Servo Driver is not in the correct (speed control) mode (and is not receiving MC Unit speed reference). | Check the Servo Driver settings.                                                                                                                                 | Correct the Servo Driver settings.                                                                                               |
| 20  |                           | The mechanical axis is locked.                                                                              | Check whether there is a mechanical limit or lock in effect.                                                                                                     | Manually release the mechanical lock.                                                                                            |
| 21  |                           | The MC Unit is defective.                                                                                   | ---                                                                                                                                                              | Replace the MC Unit.                                                                                                             |
| 22  | Rotation is reversed.     | The Servo Driver is set for reverse rotation.                                                               | Check whether the Servo Driver is set for reverse rotation by jogging.                                                                                           | Correct the setting for the direction of Servo Driver rotation.                                                                  |
| 23  |                           | The PP_STEP parameter setting is set for reverse rotation.                                                  | Check whether the parameter is set for reverse rotation (is negative).                                                                                           | Correct the parameter value.                                                                                                     |
| 24  | There are unusual noises. | The machinery is vibrating.                                                                                 | Check for foreign objects in the machinery's moving parts, and inspect for damage, deformation, and looseness.                                                   | Make any necessary repairs.                                                                                                      |
| 25  |                           | The speed loop gain is insufficient. (The gain is too high.)                                                | ---                                                                                                                                                              | Perform autotuning.<br>Manually adjust (decrease) the gain.                                                                      |
| 26  |                           | The wrong Servomotor is selected (so it cannot be adjusted).                                                | Check the torque and inertia ratings and select another Servomotor.                                                                                              | Change to a suitable Servomotor.                                                                                                 |
| 27  |                           | There is eccentricity in the couplings connecting the Servomotor axis and the mechanical system.            | ---                                                                                                                                                              | Adjust the mounting of the Servomotor and machinery.                                                                             |

| No. | Problem                                                                    | Probable causes                                                                                                                                                                           | Items to check                                                                                                                                                                                                                                            | Remedy                                                                                                                                                   |
|-----|----------------------------------------------------------------------------|-------------------------------------------------------------------------------------------------------------------------------------------------------------------------------------------|-----------------------------------------------------------------------------------------------------------------------------------------------------------------------------------------------------------------------------------------------------------|----------------------------------------------------------------------------------------------------------------------------------------------------------|
| 28  | Motor rotation is unstable.                                                | The parameters are set incorrectly.                                                                                                                                                       | Check the MC Unit parameters with Motion Perfect.                                                                                                                                                                                                         | Set the parameters correctly and modify the initialisation program accordingly.                                                                          |
| 29  |                                                                            | The Servo Motor power lines and encoder lines are wired incorrectly.                                                                                                                      | Check the Servo Motor power lines and encoder lines.                                                                                                                                                                                                      | Correct the wiring.                                                                                                                                      |
| 30  |                                                                            | There is eccentricity in the couplings connecting the Servomotor axis and the mechanical system. There may be loose screws or load torque fluctuation due to the meshing of pulley gears. | Check the machinery. Try turning the motor with no load (i.e., with the machinery removed from the coupling).                                                                                                                                             | Adjust the machinery.                                                                                                                                    |
| 31  |                                                                            | The gain adjustment is insufficient.                                                                                                                                                      | ---                                                                                                                                                                                                                                                       | Execute Servomotor autotuning.<br>Manually adjust the Servomotor gain.<br>Adjust the servo control parameters with Motion Perfect.                       |
| 32  |                                                                            | The wrong Servomotor is selected (so it cannot be adjusted).                                                                                                                              | Check the torque and inertia ratings and select another Servomotor.                                                                                                                                                                                       | Change to a suitable Servomotor.                                                                                                                         |
| 33  |                                                                            | The Servomotor bearings are damaged.                                                                                                                                                      | Turn OFF the Servo Driver power. If the Servomotor has a brake, turn ON the brake power supply and release the brake, and then manually turn the motor's output axis with the motor's power line disconnected (because the dynamic brake may be applied). | Replace the Servomotor.                                                                                                                                  |
| 34  | The Servomotor windings are disconnected.                                  | With a tester, check resistance between the Servomotor's U, V and W power lines. There should be a proper balance between the line resistances.                                           | Replace the Servomotor.                                                                                                                                                                                                                                   |                                                                                                                                                          |
| 35  | Vibration is occurring at the same frequency as the application frequency. | Inductive noise is being generated.                                                                                                                                                       | Check whether the Servo Driver control signals are too long.<br>Check whether the control signal lines and power lines are bundled together.                                                                                                              | Shorten the control signals.<br>Separate the control signal lines and the power lines.<br>Use a low-impedance power supply for the control signal lines. |
| 36  |                                                                            | The control signals are not properly grounded.                                                                                                                                            | Check whether the control signal shield is properly grounded at the Servo Driver.<br>Check whether the control signal lines are in contact with ground.                                                                                                   | Correct the wiring.                                                                                                                                      |
| 37  |                                                                            | Twisted-pair or shielded cable is not being used between the MC Unit and other devices.                                                                                                   | Check whether twisted-pair cables are used for the encoder signals and speed references, and whether the cables are shielded.                                                                                                                             | Use twisted-pair and shielded cable as in the wiring examples.                                                                                           |

| No. | Problem                                     | Probable causes                                                                      | Items to check                                                                                                                                 | Remedy                                                                           |
|-----|---------------------------------------------|--------------------------------------------------------------------------------------|------------------------------------------------------------------------------------------------------------------------------------------------|----------------------------------------------------------------------------------|
| 38  | The motor axis is vibrating unsteadily.     | The gain adjustment is insufficient. (The gain is too low.)                          | ---                                                                                                                                            | Perform autotuning.<br>Manually adjust (increase) the gain.                      |
| 39  |                                             | The gain cannot be adjusted because the mechanical rigidity is too weak.             | This particularly tends to occur in systems with vertical axes, scalar robots, palletisers, and so on, which place a torsion load on the axes. | Increase the mechanical rigidity.<br>Re-adjust the gain.                         |
| 40  |                                             | The mechanical structure is producing stick slip (high viscosity statical friction). | ---                                                                                                                                            | Perform autotuning.<br>Manually adjust the gain.                                 |
| 41  |                                             | The wrong Servomotor is selected (so it cannot be adjusted).                         | Check the torque and inertia ratings and select another Servomotor.                                                                            | Change to a suitable Servomotor.                                                 |
| 42  |                                             | The Servomotor or Servo Driver is defective.                                         | ---                                                                                                                                            | Replace the Servomotor or the Servo Driver.                                      |
| 43  | There is slippage in positioning.           | The slippage is not constant. Malfunction due to noise.                              | Is shielded cable being used?                                                                                                                  | Use shielded cable.                                                              |
| 44  |                                             | The shield is not properly grounded at the Servo Driver.                             | Check the ground wiring.                                                                                                                       | Correct the wiring.                                                              |
| 45  |                                             | The MC Unit's output power supply is not separated from other power supplies.        | Check whether the MC Unit's output power supply is separated from other power supplies.                                                        | Separate the MC output supply from other power supplies.                         |
| 46  |                                             |                                                                                      |                                                                                                                                                | Install a noise filter at the primary side of the MC Unit's output power supply. |
| 47  |                                             |                                                                                      |                                                                                                                                                | Ground the MC Unit's output power supply                                         |
| 48  |                                             | Twisted-pair cable is not being used for the encoder in- or outputs.                 | Check whether twisted-pair cable is being used for the encoder wires. (The connected voltage is 0 V or 5/24 VDC.)                              | Use twisted-pair cable for pulse outputs.                                        |
|     |                                             | The encoder and other control wires are not separated from other power lines.        | Check whether the cable is separated from other power lines.                                                                                   | Separate the cable from other power lines.                                       |
| 53  |                                             | There is malfunctioning due to noise from a welding machine, inverter, etc.          | Check whether there is a device such as a welding machine or inverter nearby.                                                                  | Separate the Unit from the noise source.                                         |
| 54  | There is slippage in the mechanical system. | Check for slippage by marking the mechanical connections.                            | Tighten the connections.                                                                                                                       |                                                                                  |

### 8-3-2 DeviceNet Slave Problem Solving

**Red Indicator (ON or Flashing)**

Use the following table to troubleshoot in a Slave that has a red indicator that is ON or flashing.

| Error                               | Probable cause                                                                                                                                                                                                                                                                                                                |
|-------------------------------------|-------------------------------------------------------------------------------------------------------------------------------------------------------------------------------------------------------------------------------------------------------------------------------------------------------------------------------|
| The MS indicator is a constant red. | The Slave Unit is faulty. Replace the Unit.                                                                                                                                                                                                                                                                                   |
| The MS indicator is flashing red.   | <ul style="list-style-type: none"> <li>Check that the Slave's baud rate setting is correct. The setting must be 125 kbps, 250 kbps, or 500 kbps. Restart the Unit after changing the baud rate.</li> <li>Replace the Unit if the MS indicator continues to flash red even though the baud rate setting is correct.</li> </ul> |

| Error                                                                                                                                                    | Probable cause                                                                                                                                                                                                                                                                                                                                                                                                                                                                                                                                                                                                                                                                                                                                                                                                                                                                                                                                                                                                                                                                                                                                                                                |
|----------------------------------------------------------------------------------------------------------------------------------------------------------|-----------------------------------------------------------------------------------------------------------------------------------------------------------------------------------------------------------------------------------------------------------------------------------------------------------------------------------------------------------------------------------------------------------------------------------------------------------------------------------------------------------------------------------------------------------------------------------------------------------------------------------------------------------------------------------------------------------------------------------------------------------------------------------------------------------------------------------------------------------------------------------------------------------------------------------------------------------------------------------------------------------------------------------------------------------------------------------------------------------------------------------------------------------------------------------------------|
| After the MS indicator turns green, the NS indicator does not flash green - it turns red immediately.                                                    | Restart the faulty Slave Unit after checking the following points. <ul style="list-style-type: none"> <li>• Make sure that the Master and Slaves baud rate settings all match. If they do not match, set all of the baud rates to the same value.</li> <li>• Check for a node address duplication. If necessary change the node address settings so that each node has a unique number.</li> <li>• See the troubleshooting steps below under the error heading: "The NS indicator lights green but turns red after a short time."</li> <li>• Check whether all of the Slaves' settings are correct.</li> <li>• If a particular Slave's NS indicator is always red, replace that Slave.</li> </ul>                                                                                                                                                                                                                                                                                                                                                                                                                                                                                             |
| The NS indicator lights green but turns red after a short time<br><b>or</b><br>The NS indicator lights green but starts flashing red after a short time. | <ul style="list-style-type: none"> <li>• Restart the faulty Slave Unit after checking the following points.</li> <li>• Make sure that there are 121-Ω Terminating Resistors connected at both ends of the trunk line. Connect 121-Ω Terminating Resistors if the wrong resistance is being used.</li> <li>• Check whether all of the Slaves' settings are correct.</li> <li>• Check whether the communications cables are connected properly.</li> <li>• Check whether the power supply is set correctly.</li> <li>• Check all the nodes for broken wires in the communications and power supply cables attached to the connectors.</li> <li>• Check whether power is correctly supplied to the network.</li> <li>• If there is nearby equipment that generates electrical noise, take steps to shield the Master, Slaves, and communications cables from the noise.</li> <li>• If an error has occurred with an OMRON Master Unit, refer to the Master Unit's <i>Operation Manual</i>. If an error has occurred in a Master supplied by another maker, refer to the relevant operation manual.</li> <li>• If a particular Slave's NS indicator is always red, replace that Slave.</li> </ul> |

**Trouble Adding a Slave to the Network**

Use the following table to troubleshoot problems in adding a Slave to the network.

| Error                         | Probable cause                                                                                                                                                                                                                                                                                                                                                                                                                                                                                                                                                                                                                                                                                                                                                                                                                                 |
|-------------------------------|------------------------------------------------------------------------------------------------------------------------------------------------------------------------------------------------------------------------------------------------------------------------------------------------------------------------------------------------------------------------------------------------------------------------------------------------------------------------------------------------------------------------------------------------------------------------------------------------------------------------------------------------------------------------------------------------------------------------------------------------------------------------------------------------------------------------------------------------|
| The NS indicator remains OFF. | <ul style="list-style-type: none"> <li>• Check if the baud rate of the Master Unit coincides with that of the Slave Unit. If the baud rate are different, correct the baud rate of the Slave Unit.</li> <li>• Check that the Slave's connector is connected correctly.</li> <li>• Check whether the communications power supply is supplying 24 VDC.</li> <li>• Make sure that the Master is operating properly. When using an OMRON Master, refer to the Master Unit's <i>Operation Manual</i>. When using another company's Master Unit, refer to that Master's user's manual.</li> <li>• Check whether the communications cables are connected properly.</li> <li>• Check whether the power supply is set correctly.</li> <li>• Check for broken wires in the communications and power supply cables attached to the connectors.</li> </ul> |

| Error                                                                                                                             | Probable cause                                                                                                                                                                                                                                                                                                                                                                                                                                                                                                                                                                                                                                                                                                                                                                                                                                                                                                                                                                                                                                                                                                                                                                                                                                                                                                                                                                                                                                                                                                                                                                                                                                                                                              |
|-----------------------------------------------------------------------------------------------------------------------------------|-------------------------------------------------------------------------------------------------------------------------------------------------------------------------------------------------------------------------------------------------------------------------------------------------------------------------------------------------------------------------------------------------------------------------------------------------------------------------------------------------------------------------------------------------------------------------------------------------------------------------------------------------------------------------------------------------------------------------------------------------------------------------------------------------------------------------------------------------------------------------------------------------------------------------------------------------------------------------------------------------------------------------------------------------------------------------------------------------------------------------------------------------------------------------------------------------------------------------------------------------------------------------------------------------------------------------------------------------------------------------------------------------------------------------------------------------------------------------------------------------------------------------------------------------------------------------------------------------------------------------------------------------------------------------------------------------------------|
| <p>The NS indicator continues to flash green</p>                                                                                  | <ul style="list-style-type: none"> <li>• Make sure that the Master is operating properly.<br/>When using an OMRON Master, refer to the Master Unit's <i>Operation Manual</i>. When using another company's Master Unit, refer to that Master's user's manual.</li> <li>• Check whether the Slave is registered in the Master's scan list.<br/>If an OMRON Master Unit is being used, a new Slave cannot be added to the network if the Master is operating with the scan list enabled. First perform the clear scan list operation, check that the Slave has joined the network, and then perform the create scan list operation.<br/>If another company's Master Unit is being used, refer to that Master's operation manual for details on adding a new Slave to its scan list.</li> </ul>                                                                                                                                                                                                                                                                                                                                                                                                                                                                                                                                                                                                                                                                                                                                                                                                                                                                                                                |
| <p>The NS Indicator alternates between being green and flashing green, or alternates between flashing red and flashing green.</p> | <ul style="list-style-type: none"> <li>• When using an OMRON Master, check the following items and perform the necessary error processing steps.                             <ul style="list-style-type: none"> <li>-&gt; Register the scan list again.<br/>(After performing the clear scan list operation, check that the Slave has joined the network and perform the create scan list operation.)</li> <li>-&gt; Make sure that the Slave's allocated I/O area does not overlap with that of another Slave. If there is an overlap, change the Slave's node address to eliminate it.</li> <li>-&gt; Make sure the the allocated I/O area does not exceed the allowed range. If the I/O area exceeds this range, change the Slave's node address to correct the problem.</li> </ul> </li> <li>• When using another company's Master Unit, check that the I/O size registered in the Master's scan list matches the actual I/O size of the Slave. The I/O size is recorded in the following attributes of the connection object:                             <ul style="list-style-type: none"> <li>Interface 2 (Polled I/O Connection)                                     <ul style="list-style-type: none"> <li>Produced Connection size (Input size)</li> <li>Consumed Connection size (Output size)</li> </ul> </li> <li>and:                                     <ul style="list-style-type: none"> <li>Interface 3 (Bit strobed I/O Connection)                                             <ul style="list-style-type: none"> <li>Produced Connection size (Input size)</li> </ul> </li> </ul> </li> </ul> <p>Refer to the Master's manual for details on registering the values.</p> </li> </ul> |

# SECTION 9

## Maintenance and Inspection

This section explains the maintenance and inspection procedures that must be followed to keep the MC Unit operating in optimum condition. It also includes proper procedures when replacing an MC Unit.

|     |                               |     |
|-----|-------------------------------|-----|
| 9-1 | Routine Inspections . . . . . | 234 |
| 9-2 | Replacing a MC Unit . . . . . | 235 |



## 9-1 Routine Inspections

In order for your MC Unit to continue operating at optimum condition, periodic inspections are necessary. The main components of the Unit are semiconductors and have a long service life, but depending on the operating environment, there may be more or less deterioration of these and other parts. A standard inspection schedule is once every six months to one year. More frequent inspections may be advisable depending on the operating environment. Maintain the inspection schedule once it has been set.

### Inspection Points

Check to be sure that the power supply, ambient temperature, humidity, and other specifications are within the specifications. Be sure that there are no loose screws and that all battery and cable connections are secure. Clean any dust or dirt that has accumulated.

| Item                    | Inspection points                                                                                                                         | Criteria                                                                                           | Remarks                                                                                                                     |
|-------------------------|-------------------------------------------------------------------------------------------------------------------------------------------|----------------------------------------------------------------------------------------------------|-----------------------------------------------------------------------------------------------------------------------------|
| I/O Power Supply        | Measure the voltage variations at the I/O power supply terminal block. Do they meet the standards?                                        | 24 VDC: 20.4 to 26.4 VDC                                                                           | With a voltage tester, check between the terminals and make sure that the power supply falls within the acceptable range.   |
| Installation and wiring | Is the MC Unit securely mounted?                                                                                                          | There must be looseness.                                                                           | With a Phillips screwdriver, tighten all mounting screws.                                                                   |
|                         | Are the cable connectors properly inserted and locked?                                                                                    |                                                                                                    | Carefully insert and lock all cable connectors.                                                                             |
|                         | Are there any loose screws in the external wiring?                                                                                        |                                                                                                    | With a Phillips screwdriver, tighten all screws in the external wiring.                                                     |
|                         | Are any crimp terminals for external wiring too close together?                                                                           | There must be sufficient distance between them.                                                    | Do a visual check and separate the terminals as required.                                                                   |
|                         | Are any external cables disconnected?                                                                                                     | There must be no external abnormalities.                                                           | Do a visual check and connect or replace cables as required.                                                                |
| Environment conditions  | Is the ambient temperature within the acceptable range? (When used in a panel, the ambient temperature inside the panel must be checked.) | 0 to 55°C                                                                                          | With a thermometer, check the ambient temperature inside the panel and make sure that it falls within the acceptable range. |
|                         | Is the ambient humidity within the acceptable range? (When used in a panel, the ambient temperature inside the panel must be checked.)    | 10% to 90% RH (with no condensation)                                                               | With a hydroscope, check the ambient humidity inside the panel and make sure that it falls within the acceptable range.     |
|                         | Is the Unit exposed to direct sunlight?                                                                                                   | It must not be exposed to direct sunlight.                                                         | Shield the Unit from direct sunlight.                                                                                       |
|                         | Is there any accumulation of dust (especially iron dust) or salts?                                                                        | There must be none of these present.                                                               | Remove any accumulation of dust or salts and protect against them.                                                          |
|                         | Is the Unit exposed to any spray of water, oil, or chemicals?                                                                             | It must not be exposed to any of these.                                                            | Protect the Unit from water, oil, and chemicals.                                                                            |
|                         | Is the location subject to corrosive or flammable gases?                                                                                  | The Unit must not be exposed to these.                                                             | Check for smells or use a gas sensor.                                                                                       |
|                         | Is the location subject to shock or vibration?                                                                                            | The amount of shock or vibration must be within the acceptable ranges given in the specifications. | Install a cushion or other device to reduce shock and vibration.                                                            |
|                         | Is the location near any source of noise?                                                                                                 | There must be no noise.                                                                            | Remove the Unit from the noise source or apply countermeasures.                                                             |

| Item                    | Inspection points                                               | Criteria                                        | Remarks                                                                 |
|-------------------------|-----------------------------------------------------------------|-------------------------------------------------|-------------------------------------------------------------------------|
| Installation and wiring | Is the MC Unit securely mounted?                                | There must be looseness.                        | With a Phillips screwdriver, tighten all mounting screws.               |
|                         | Are the cable connectors properly inserted and locked?          |                                                 | Carefully insert and lock all cable connectors.                         |
|                         | Are there any loose screws in the external wiring?              |                                                 | With a Phillips screwdriver, tighten all screws in the external wiring. |
|                         | Are any crimp terminals for external wiring too close together? | There must be sufficient distance between them. | Do a visual check and separate the terminals as required.               |
|                         | Are any external cables disconnected?                           | There must be no external abnormalities.        | Do a visual check and connect or replace cables as required.            |

**Required Tools**

The following tools, materials, and equipment are required when performing an inspection.

- Phillips screwdriver
- Voltage tester or digital voltage meter
- Industrial alcohol and a clean cotton cloth
- Synchroscope
- Oscilloscope
- Thermometer
- Hydrometer

## 9-2 Replacing a MC Unit

The application and communication network are affected when (part of) a Unit is faulty, so a faulty Unit must be repaired or replaced quickly. We recommend having a spare Unit available to restore operation as quickly as possible.

**Precautions**

Observe the following precautions when replacing a faulty Unit.

- After replacement make sure that there are no errors with the new Unit.
- When returning a faulty Unit for repair, make a detailed record of the problem and return the Unit to your nearest OMRON office or sales representative.
- If there is a faulty contact, put some industrial alcohol on a clean cotton cloth and wipe the surface.

Use the following procedure when it is necessary to replace an MC Unit.

**1,2,3...**

1. Make a note of the switch settings of the MC Unit to be replaced.
2. Use Motion Perfect to check the project of the Unit and to make a local copy saved on the Personal Computer.
3. Turn OFF the system power supply.
4. Replace the MC Unit, and reconnect the wiring as before.
5. Set the switch settings for the MC Unit.
6. Turn ON the system power supply.
7. Clear all the programs in the MC Unit.
8. Download all of the programs to the MC Unit, save the programs in flash memory and set the correct program to run at power up.



## Appendix A

### Servo Driver Parameter List

The following Servo Driver parameter settings are required for operation with the MC Unit. Refer to the *OMNUC W-series user's manual (I531)* for details.

| Parameter No. | Parameter Name                                     | Required Setting | Explanation                                    | Remark                               |
|---------------|----------------------------------------------------|------------------|------------------------------------------------|--------------------------------------|
| Pn000.1       | Control Mode Selection                             | 0                | Speed Control                                  |                                      |
|               |                                                    | 9                | Torque / Speed Control                         |                                      |
| Pn002.0       | Torque command input (during speed control)        | 0                | Not used                                       |                                      |
|               |                                                    | 1                | Use TREF as analog torque limit input          |                                      |
| Pn002.1       | Speed command input (during torque control)        | 0                | Not used                                       |                                      |
|               |                                                    | 1                | Use (S)REF as analog speed limit input         |                                      |
| Pn003.0       | Monitor 1                                          | 2                | Torque Reference Monitor                       |                                      |
| Pn003.1       | Monitor 2                                          | 0                | Motor Speed Monitor                            |                                      |
| Pn50A.0       | Input Signal Allocation Mode                       | 1                | User-defined                                   |                                      |
| Pn50A.1       | RUN Signal Input Allocation                        | 8                | Always disabled                                | Switch is controlled by the MC Unit. |
| Pn50A.2       | MING Signal Input Allocation                       | 8                | Always disabled                                | Switch is controlled by the MC Unit. |
| Pn50A.3       | POT Signal Input Allocation                        | 2                | Assigned to CN1, pin 42 (valid for low input)  |                                      |
|               |                                                    | 8                | Always disabled                                |                                      |
| Pn50B.0       | NOT Signal Input Allocation                        | 3                | Assigned to CN1, pin 43 (valid for low input)  |                                      |
|               |                                                    | 8                | Always disabled                                |                                      |
| Pn50B.1       | RESET Signal Input Allocation                      | 8                | Always disabled                                | Switch is controlled by the MC Unit. |
| Pn50C.3       | TVSEL Signal Input Allocation                      | 8                | Always disabled                                | Switch is controlled by the MC Unit. |
| Pn511.0       | -                                                  | 8                | Always disabled                                |                                      |
| Pn511.1       | -                                                  | 8                | Always disabled                                |                                      |
| Pn511.2       | -                                                  | 8                | Always disabled                                |                                      |
| Pn511.3       | /EXT3 (Print Registration) Signal Input Allocation | 6                | Assigned to CN1, pin 46 (valid for low input)  | Print registration on rising edge.   |
|               |                                                    | F                | Assigned to CN1, pin 46 (valid for high input) | Print registration on falling edge.  |



## Appendix B

### Device Protocol (MCW151-DRT-E only)

|                           |                                        |                                               |                     |
|---------------------------|----------------------------------------|-----------------------------------------------|---------------------|
| General data              | Compatible DeviceNet specifications    | Volume I-Release 1.3<br>Volume II-Release 1.3 | ---                 |
|                           | Vendor name                            | OMRON Corporation                             | Vendor ID = 47      |
|                           | Device profile name                    | Slave: Generic                                | Profile number = 00 |
|                           | Product catalog number                 | I203                                          | ---                 |
|                           | Product revision                       | 3.2                                           | ---                 |
| Physical conformance data | Network current consumption            | 30 mA max. at 24 VDC                          | ---                 |
|                           | Physical layer insulation              | Yes                                           | ---                 |
|                           | Supported LEDs                         | Module Network                                | ---                 |
|                           | MAC ID setting                         | DIP switch                                    | ---                 |
|                           | Default MAC ID                         | 0                                             | ---                 |
|                           | Baud rate setting                      | DIP switch                                    | ---                 |
|                           | Supported baud rates                   | 125 kbps, 250 kbps and 500 kbps               | ---                 |
| Communications data       | Predefined Master/Slave connection set | Group 2 only server                           | ---                 |
|                           | Dynamic connection support (UCMM)      | No                                            | ---                 |
|                           | Explicit message fragmentation support | Yes                                           | ---                 |

## Object Mounting

### Identity Object (0x01)

|              |           |               |
|--------------|-----------|---------------|
| Object class | Attribute | Not supported |
|              | Service   | Not supported |

| Item            |           | ID content                | Get (read) | Set (write) | Value                |
|-----------------|-----------|---------------------------|------------|-------------|----------------------|
| Object instance | Attribute | 1 Vendor                  | Yes        | No          | 47                   |
|                 |           | 2 Product Type            | Yes        | No          | 0                    |
|                 |           | 3 Product Code            | Yes        | No          | 900                  |
|                 |           | 4 Revision                | Yes        | No          | 3.2                  |
|                 |           | 5 Status (bits supported) | Yes        | No          | bit 0 only           |
|                 |           | 6 Serial number           | Yes        | No          | Unique for each Unit |
|                 |           | 7 Product name            | Yes        | No          | R88A-MCW151-DRT-E    |
|                 |           | 8 State                   | Yes        | No          | ---                  |

| Item            |         | DeviceNet service       | Parameter option |
|-----------------|---------|-------------------------|------------------|
| Object instance | Service | 05 Reset                | No               |
|                 |         | 0E Get_Attribute_Single |                  |

**Message Router Object (0x02)**

|                               |           |               |
|-------------------------------|-----------|---------------|
| Object class                  | Attribute | Not supported |
|                               | Service   | Not supported |
| Object instance               | Attribute | Not supported |
|                               | Service   | Not supported |
| Vendor specification addition |           | No            |

**DeviceNet Object (0x03)**

|              |           |               |
|--------------|-----------|---------------|
| Object class | Attribute | Not supported |
|              | Service   | Not supported |

| Item            | ID content | Get (read)                 | Set (write) | Value |     |
|-----------------|------------|----------------------------|-------------|-------|-----|
| Object instance | Attribute  | 1 MAC ID                   | Yes         | No    | --- |
|                 |            | 2 Baud rate                | Yes         | No    | --- |
|                 |            | 3 BOI                      | Yes         | No    | --- |
|                 |            | 4 Bus Off counter          | Yes         | No    | --- |
|                 |            | 5 Allocation information   | Yes         | No    | --- |
|                 |            | 6 MAC ID switch changed    | No          | No    | --- |
|                 |            | 7 Baud rate switch changed | No          | No    | --- |
|                 |            | 8 MAC ID switch value      | No          | No    | --- |
|                 |            | 9 Baud rate switch value   | No          | No    | --- |

| Item            | DeviceNet service | Parameter option                        |    |
|-----------------|-------------------|-----------------------------------------|----|
| Object instance | Service           | 0E Get_Attribute_Single                 | No |
|                 |                   | 4B Allocate_Master/Slave_Connection_Set | No |
|                 |                   | 4C Release_Master/Slave_Connection_Set  |    |

**Assembly Object (0x04)**

|              |           |               |
|--------------|-----------|---------------|
| Object class | Attribute | Not supported |
|              | Service   | Not supported |

| Item                | ID content  | Get (read) | Set (write) | Value |     |
|---------------------|-------------|------------|-------------|-------|-----|
| Object instance 100 | Attribute 3 | Data       | Yes         | No    | --- |

| Item            | DeviceNet service | Parameter option        |    |
|-----------------|-------------------|-------------------------|----|
| Object instance | Service           | 0E Get_Attribute_Single | No |

| Item                | ID content  | Get (read) | Set (write) | Value |     |
|---------------------|-------------|------------|-------------|-------|-----|
| Object instance 101 | Attribute 3 | Data       | Yes         | Yes   | --- |

| Item            | DeviceNet service | Parameter option        |    |
|-----------------|-------------------|-------------------------|----|
| Object instance | Service           | 0E Get_Attribute_Single | No |
|                 |                   | 10 Set_Attribute_Single | No |

**Connection Object (0x05)**

|              |                                   |               |
|--------------|-----------------------------------|---------------|
| Object class | Attribute                         | Not supported |
|              | Service                           | Not supported |
|              | Max. number of active connections | 1             |

| Item              |           | Section            | Information      | Max. number of instances |
|-------------------|-----------|--------------------|------------------|--------------------------|
| Object instance 1 | Attribute | Instance type      | Explicit Message | 1                        |
|                   |           | Production trigger | Cyclic           | ---                      |
|                   |           | Transport type     | Server           |                          |
|                   |           | Transport class    | 3                |                          |

| Item                       |           | ID content                         | Get (read)         | Set (write) | Value              |
|----------------------------|-----------|------------------------------------|--------------------|-------------|--------------------|
| Object instance 1          | Attribute | 1 State                            | Yes                | No          | ---                |
|                            |           | 2 Instance type                    | Yes                | No          | 0000 (hexadecimal) |
|                            |           | 3 Transport class trigger          | Yes                | No          | 83 (hexadecimal)   |
|                            |           | 4 Produced connection ID           | Yes                | No          | ---                |
|                            |           | 5 Consumed connection ID           | Yes                | No          | ---                |
|                            |           | 6 Initial comm. characteristics    | Yes                | No          | 21 (hexadecimal)   |
|                            |           | 7 Produced connection size         | Yes                | No          | 00FE (hexadecimal) |
|                            |           | 8 Consumed connection size         | Yes                | No          | 00FE (hexadecimal) |
|                            |           | 9 Expected packet rate             | Yes                | Yes         | ---                |
|                            |           | 12 Watchdog time-out action        | Yes                | No          | 01 (hexadecimal)   |
|                            |           | 13 Produced connection path length | Yes                | No          | 0000 (hexadecimal) |
|                            |           | 14 Produced connection path        | Yes                | No          | ---                |
|                            |           | 15 Consumed connection path length | Yes                | No          | 0000 (hexadecimal) |
|                            |           | 16 Consumed connection path        | Yes                | No          | ---                |
| 17 Production inhibit time | Yes       | No                                 | 0000 (hexadecimal) |             |                    |

| Item              |         | DeviceNet service       | Parameter option |
|-------------------|---------|-------------------------|------------------|
| Object instance 1 | Service | 05 Reset                | No               |
|                   |         | 0E Get_Attribute_Single | No               |
|                   |         | 10 Set_Attribute_Single | No               |

| Item              |           | Section            | Information | Max. number of instances |
|-------------------|-----------|--------------------|-------------|--------------------------|
| Object instance 2 | Attribute | Instance type      | Polled I/O  | 1                        |
|                   |           | Production trigger | Cyclic      | ---                      |
|                   |           | Transport type     | Server      |                          |
|                   |           | Transport class    | 2           |                          |



| Item                       |           | ID content                         | Get (read)         | Set (write) | Value              |
|----------------------------|-----------|------------------------------------|--------------------|-------------|--------------------|
| Object instance 2          | Attribute | 1 State                            | Yes                | No          | ---                |
|                            |           | 2 Instance type                    | Yes                | No          | 0100 (hexadecimal) |
|                            |           | 3 Transport class trigger          | Yes                | No          | 82 (hexadecimal)   |
|                            |           | 4 Produced connection ID           | Yes                | No          | ---                |
|                            |           | 5 Consumed connection ID           | Yes                | No          | ---                |
|                            |           | 6 Initial comm. characteristics    | Yes                | No          | 01 (hexadecimal)   |
|                            |           | 7 Produced connection size         | Yes                | No          | See note           |
|                            |           | 8 Consumed connection size         | Yes                | No          | See note           |
|                            |           | 9 Expected packet rate             | Yes                | Yes         | ---                |
|                            |           | 12 Watchdog time-out action        | Yes                | No          | 0000 (hexadecimal) |
|                            |           | 13 Produced connection path length | Yes                | No          | 0000 (hexadecimal) |
|                            |           | 14 Produced connection path        | Yes                | No          | No                 |
|                            |           | 15 Consumed connection path length | Yes                | No          | 0000 (hexadecimal) |
|                            |           | 16 Consumed connection path        | Yes                | No          | No                 |
| 17 Production inhibit time | Yes       | No                                 | 0000 (hexadecimal) |             |                    |

| Item              |         | DeviceNet service       | Parameter option |
|-------------------|---------|-------------------------|------------------|
| Object instance 2 | Service | 05 Reset                | No               |
|                   |         | 0E Get_Attribute_Single | No               |
|                   |         | 10 Set_Attribute_Single | No               |

**Note** The number of bytes for the consumed and the produced size depends on the I/O Slave Messaging mode of the MC Unit. The mode set by pin 7 of the DeviceNet switch settings.

| Pin 7 | I/O Slave Messaging Mode | Connection size                                                                                                                                   |
|-------|--------------------------|---------------------------------------------------------------------------------------------------------------------------------------------------|
| OFF   | Mode I                   | Produced connection size: Read area bytes (default 0004 (hexadecimal))<br>Consumed connection size: Write area bytes (default 0004 (hexadecimal)) |
| ON    | Mode II                  | Produced connection size: Read area bytes (default 0008 (hexadecimal))<br>Consumed connection size: Write area bytes (default 0008 (hexadecimal)) |

### MCW151 Object (0x8A)

|              |           |               |
|--------------|-----------|---------------|
| Object class | Attribute | Not supported |
|              | Service   | Not supported |

| Item              |           | ID content | Get (read) | Set (write) | Value                        |
|-------------------|-----------|------------|------------|-------------|------------------------------|
| Object instance 1 | Attribute |            | Yes        | Yes         | Need to perform services on. |

| Item              |         | DeviceNet service        | Parameter option |
|-------------------|---------|--------------------------|------------------|
| Object instance 1 | Service | 05 Reset                 | No               |
|                   |         | 32 Table_Memory_Read_3W  |                  |
|                   |         | 33 VR_Memory_Read_3W     |                  |
|                   |         | 34 VR_Memory_Read_1W     |                  |
|                   |         | 35 Table_Memory_Write_3W |                  |
|                   |         | 36 VR_Memory_Write_3W    |                  |
|                   |         | 37 VR_Memory_Write_1W    |                  |



# Appendix C

## Programming Examples

### Master Shell Program

Good programming practice requires to have a master shell program. A master shell program can be used for most applications and will perform the following tasks:

- Set-up the MC Unit and the Servo Driver
- Control the application program tasks
- Continuously monitoring the status of the system.

Please find below an example of such a master shell program. Be sure to modify it to the specific application and to check proper operation for all possible conditions before relying on its safety operation. This program should be set to run at power-up at low priority (task 1).

```
'#####
' Master shell program
' Tasks: 1. Set-up MC Unit and Servo Driver
' 2. Control application program tasks
' 3. Continuous error checking
' Inputs: IN(6) start_machine (active high)
' Start application
' IN(7) e_stop (active low)
' Emergency stop
' (IN(5)) resetting (active high)
' Reset motion error
' Main variables used:
' Program status VR(111)
' 0 Initialising system
' 1 Motion & programs stopped
' 2 Normal running
' 3 Error or emergency stop

' Execution: Run program on priority 1 (lowest priority)

'#####

' Initialisation of variables
'-----
GOSUB init_vars

' Initialisation of serial ports
'-----
GOSUB init_serial

' Initialisation axis parameters
'-----
RUN "STARTUP",3
WA(5)

' Wait until process is stopped
WAIT UNTIL PROC_STATUS PROC(3) = 0

' Set ERRORMASK parameter
'-----
' Following statuses will result in Motion Error:
' (bit 2) Servo Driver Communication Error
' (bit 3) Servo Driver Alarm
' (bit 8) Following Error Limit
BASE(0)
ERRORMASK = 268

' Initialisation Servo Driver
'-----
' If no communication error
IF (AXISSTATUS AND 4) = 0 THEN
' Set Servo Driver parameters
RUN "INIT_DRIVER",3
WA(5)
```

```

' Wait until process is stopped
WAIT UNTIL PROC_STATUS PROC(3) = 0

' Possible reset of system
IF VR(force_reset) = TRUE THEN
 WA(100)
 DRV_RESET
 WA(100)
ENDIF
ELSE
 GOTO m_error
ENDIF

start:
'Stops all movements and programs
'-----
GOSUB stop_all

' Program status: Motion & programs stopped
VR(programstatus) = 1
WA(10)

'Necessary condition to start operation
'-----
WAIT UNTIL IN(start_machine)=1

'Start the application program(s)
RUN "application",3
'...
WA(10)

' Program status: Normal running
VR(programstatus) = 2

BASE(0)

'Main loop
'-----
loop:

' Check for motion error or Servo Driver OFF
IF MOTION_ERROR THEN
 '...
 GOTO m_error
ENDIF

' Check for emergency stop
IF IN(e_stop) = 0 THEN
 '...
 GOTO e_stop
ENDIF

GOTO loop

'-----
'SUBROUTINE AREA
'-----

'Variable initialisation
'-----
init_vars:
'Init local variables
programstatus = 111
alarm_mcw151 = 112
alarm_servodriver = 113
force_reset = 114
'...

'Init local variables
' Program status = Initialising system
VR(programstatus) = 0
VR(alarm_mcw151) = 0
VR(alarm_servodriver) = 0
VR(force_reset) = 0

```

```

'...
'Init I/O naming
resetting = 5
start_machine = 6
e_stop = 7
pos_torque = 16
startup_flag = 18
servo_alarm_bit = 24
rdy = 28
'...
RETURN

'Serial ports initialisation
'-----
init_serial:
' Port 1
'-----
baud_rate = 9600
data_bits = 7
stop_bits = 2
parity = 2 ' Even parity
option = 6 ' Host Link Master
SETCOM(baud_rate,data_bits,stop_bits,parity,1,option)

' Port 2 (MCW151-E only)
'-----
baud_rate = 9600
data_bits = 7
stop_bits = 2
parity = 2 ' Even parity
option = 5 ' Host Link Slave
SETCOM(baud_rate,data_bits,stop_bits,parity,2,option)

' Host Link Slave settings
'-----
HLS_NODE = 3
HLS_MODEL = $FE

' Host Link Master settings
'-----
HLM_TIMEOUT = 1000

RETURN

'Motion stop and initialisation
'-----
stop_all:
'We store in those variable the cause of the error, if any, for diagnostics
BASE(0)
VR(alarm_mcw151)=AXISSTATUS
VR(alarm_servodriver)=DRV_STATUS

'Stops all programs
STOP "application"
'...

'Stops all possible moves
RAPIDSTOP
WA(200)
FOR i = 0 TO 2
 BASE(i)
 CANCEL(1)
 CANCEL
 WA(1)
 CANCEL(1)
 WAIT IDLE
 SERVO = OFF
NEXT i
BASE(0)

'Disable the axis
WDOG = OFF

'Reset the possible following error
DATUM(0)

```

```

RETURN
'Motion error routine
'-----
m_error:
' Program status: Error or emergency stop
VR(programstatus) = 3

' Stop all movements
GOSUB stop_all

' If Servo Driver comm. error then
IF AXISSTATUS AND 4 > 0 THEN
' Stop all programs (including master shell)
 HALT
ENDIF

' A reset input can be defined to continue operation
' WAIT UNTIL IN(resetting)=ON

' If Servo Driver Alarm then
' IF AXISSTATUS AND 8 > 0 THEN
' Clear alarm
' DRV_CLEAR
' ENDF

' GOTO start
STOP

'Emergency stop
'-----
e_stop:
' Program status: Error or emergency stop
VR(programstatus) = 3

' Stop all movements
GOSUB stop_all

WAIT UNTIL IN(e_stop) = 1
GOTO start

```

## Servo Driver Parameter Setting program

The following program can be used to set the correct Servo Driver settings. Modify the parameters to those required for the application.

```

'#####
' Servo Driver parameter setting program
' Tasks: Set-up Servo Driver parameters
' Inputs: None
' Outputs: VR(114) Force reset
' value = FALSE => power toggle or drv_reset not required
' value = TRUE => power toggle or drv_reset required
'#####

force_reset = 114
VR(force_reset)=FALSE

' Initialisation parameters I (re-start / reset required):

' Pn000 Function selection basic switch
' Pn000.1 = 0 : Speed Control (selected)
' Pn000.1 = 9 : Torque / Speed control
IF DRV_READ($000) <> $0000 THEN
 DRV_WRITE($000,$0000)
 VR(force_reset) = TRUE
ENDIF

' Pn002 Function selection application switch 2
' Pn002.0 = 0 : Torque Limit during speed control not used (selected)
' Pn002.0 = 1 : Torque Limit
' Pn002.1 = 0 : Speed Limit during torque control not used (selected)
' Pn002.1 = 1 : Speed Limit
IF DRV_READ($002)<>$0000 THEN

```

```

DRV_WRITE($002,$0000)
VR(force_reset) = TRUE
ENDIF

' Pn003 Function selection application switch 3
' Pn003.0 = 2 : Analog monitor1 Torque command
' Pn003.1 = 0 : Analog monitor1 Servomotor rotation speed
IF DRV_READ($003) <> $0002 THEN
 DRV_WRITE($003,$0002)
 VR(force_reset) = TRUE
ENDIF

' Pn50A Input signal selection 1
' Pn50A.0 = 1 : Input Signal Allocation mode user-defined
' Pn50A.1 = 8 : RUN Signal Input always disabled
' Pn50A.2 = 8 : MING Signal Input always disabled
' Pn50A.3 = 2 : POT Signal Input allocated to CN1-42
IF DRV_READ($50A) <> $2881 THEN
 DRV_WRITE($50A,$2881)
 VR(force_reset) = TRUE
ENDIF

' Pn50B Input signal selection 2
' Pn50B.0 = 3 : NOT Signal Input allocated to CN1-43
' Pn50B.1 = 8 : RESET Signal Input always disabled
' Pn50B.2 = 8 : PCL Signal Input always disabled
' Pn50B.3 = 2 : NCL Signal Input always disabled
IF DRV_READ($50B) <> $8883 THEN
 DRV_WRITE($50B,$8883)
 VR(force_reset) = TRUE
ENDIF

' Pn50C Input signal selection 3
' Pn50C.0 = 8 : RDIR Signal Input always disabled
' Pn50C.1 = 8 : SPD1 Signal Input always disabled
' Pn50C.2 = 8 : SPD2 Signal Input always disabled
' Pn50C.3 = 8 : TVSEL Signal Input always disabled
IF DRV_READ($50C) <> $8888 THEN
 DRV_WRITE($50C,$8888)
 VR(force_reset) = TRUE
ENDIF

' Pn511 Registration Input signal selection
' Pn511.0 = 8 : Always disabled
' Pn511.1 = 8 : Always disabled
' Pn511.2 = 8 : Always disabled
' Pn511.3 = 6 : EXT3 (Print Registration) Input allocated
' ----- : to CN1-46 (rising edge) (selected)
' Pn511.3 = F : EXT3 (Print Registration) Input allocated
' ----- : to CN1-46 (falling edge)
IF DRV_READ($511) <> $8888 THEN
 DRV_WRITE($511,$8888)
 VR(force_reset) = TRUE
ENDIF

' Initialisation parameters II (no re-start / reset required):

' Pn100 Speed loop gain
IF DRV_READ($100) <> 80 THEN
 DRV_WRITE($100,80)
ENDIF

' Pn101 Speed loop integration constant
IF DRV_READ($101) <> 2000 THEN
 DRV_WRITE($101,2000)
ENDIF

' Pn103 Inertia ratio
IF DRV_READ($103) <> 300 THEN
 DRV_WRITE($103,300)
ENDIF

```



## General Examples

### Example 1: Turning an Output ON and OFF Every 100ms

The following code controls output 10 to go on and off every 100 ms.

```
loop:
 OP(10, ON)
 WA(100)
 OP(10, OFF)
 WA(100)
 GOTO loop
```

### Example 2: Flashing MC Unit Outputs

The following code will sequentially step through all available outputs on the MC Unit and flash them for 0.5 seconds each

```
start:
 FOR a = 8 TO 13
 OP(a, ON)
 WA(500)
 OP(a, OFF)
 NEXT a
 GOTO start
```

### Example 3: Positioning a Rotary Table

A rotary table must stop at one of 8 equally spaced positions according to the value of a thumbwheel input (inputs 4 to 7). The table will not move until a start button is pressed (input 10).

```
start:
 WAIT UNTIL IN(10) = ON
 WAIT UNTIL IN(10) = OFF
 GOSUB get_tws

 MOVEABS(45 * tw_value)
 WAIT IDLE
 GOTO start

get_tws:
 tw_value = IN(4,7)
 RETURN
```

### Example 4: Positioning with Product Detection

A ballscrew is required to move forward at a creep speed until it reaches a product, at which point a microswitch (IN(2)) is turned ON. The ballscrew is stopped immediately, the position at which the product was sensed is indicated and the ballscrew is returned at a rapid speed back to the start position.

```
start:
 IF (IN(1) = ON) THEN WAIT UNTIL IN(8) = OFF
 WAIT UNTIL IN(1) = ON
 SPEED = 10
 FORWARD
 WAIT UNTIL IN(2) = ON

 prod_pos = MPOS
 CANCEL
 WAIT IDLE

 PRINT "Product Position : "; prod_pos
 SPEED = 100
 MOVEABS(0)
 WAIT IDLE
 GOTO start
```

**Example 5: Synchronising Cutter Movement**

A flying shear cutter is required to synchronise with a continuously moving web and to cut a roll of paper every 5 m:

- The cutter (axis 0) can move a total of 600 mm. We use a maximum 500 mm of this travel.
- The blade is operated by a solenoid which is switched by digital output 8.
- The blade must be operated mid-way through the cutter motion.
- The cutter must synchronise to cut, and return to its start position all within not more than 80% of the repeat cycle.

To ensure that speeds and positions of the cutter and paper match during the cut process, the arguments of the MOVELINK command must be correct. It is normally easiest to consider the acceleration, constant speed and deceleration phases separately and then combine them as required.

```
start:
 UNITS AXIS(0) = 5000 'Meters
 UNITS AXIS(1) = 5000

loop:
 BASE(0)
 MOVELINK(0, 4, 0, 0, 1) 'Wait distance
 MOVELINK(0.1, 0.2, 0.2, 0, 1) 'Accelerate
 MOVELINK(0.3, 0.3, 0, 0, 1) 'Match speed
 MOVELINK(0.1, 0.2, 0, 0.2, 1) 'Decelerate

 MOVELINK(-0.5, 5, 3, 3, 1) 'Move back
 GOTO loop
```

The middle MOVELINK commands can be done in one move using the following line.

```
MOVELINK(0.5, 0.7, 0.2, 0.2, 1)
```

**Example 6: Generating Smooth High-speed Profiles**

It is often desirable to generate a smooth profiled move for the maximum operational speed in high-speed machines. An optimal profile for this is a sine squared:

$$y = mx - n(\sin(x))$$

In this example we work in radians. The axis no. 1 is the master axis.

```
start:
 GOSUB filltable
 BASE(0)

loop:
 CAMBOX(0, 36, 1, 100, 1)
 WAIT IDLE
 WA(1000)
 GOTO loop

filltable:
 num_p = 37
 scale = 2000
 FOR p=0 TO num_p
 TABLE(p, ((-SIN(PI*2*p/num_p)/(PI*2))+p/num_p)*scale)
 NEXT p
 RETURN
```

**Example 7: Coordinating Two Moving Objects**

Two conveyors run in parallel, conveyor A (axis 0) carries a product that must be transferred into boxes evenly spaced on conveyor B (external encoder on axis 1). The transfer operation requires the products to be aligned at the end of the conveyor.

A registration process checks the position of the product on the conveyor and calculates the amount that conveyor A must be advanced or retarded in order to align with conveyor B. Input 1 indicates that the registration process has been completed and the correction amount loaded serially into VR(1).

```

setup:
 BASE (0)
 CONNECT (1,1)
 ADDAX (2)
 BASE (2)

loop:
 IF IN(1) = ON THEN WAIT UNTIL IN(1) = OFF
 WAIT UNTIL IN(1) = ON
 correction = VR(1)
 MOVE (correction)
 WAIT IDLE
 GOSUB do_transfer
 GOTO loop

do_transfer:
 OP (15,ON)
 WA (500)
 OP (15,OFF)
 RETURN

```

### **Example 8: Coordinating Motion with Mark Detection**

A cyclic cut-to-length operation requires a rolled product to be cut in relation to a printed mark. The product is nominally 150 mm long and the printed registration mark appears 30 mm from the end of the product. The product must be stationary when cut, but the draw motion should be one continuous move. A high-speed optical sensor is connected to the registration input of the feed axis.

```

loop:
 REGIST (3)
 DEFPOS (0)
 MOVE (150)
 WAIT UNTIL MARK
 MOVEMODIFY (REG_POS+30)
 WAIT IDLE
 GOSUB cut_operation
 GOTO loop

cut_operation:
 'Omitted from this example.
 RETURN

```

### **Example 9: Host Link Master Program**

The following program shows a possible implementation of the Host Link protocol. The user program should contain a mechanism of error checking and possibly retries.

```

' Configure serial port 2:
SETCOM(9600,7,2,2,2,6)

' Set timeout time to 500 servo cycles
HLM_TIMEOUT=500

' Define attempt counter
attempt=1

loop:
 ' Read data (2 words) from the PC CIO/IR area (address 2)

```

```
' to VR memory (address 0). The PC has Host Link slave node 13.
HLM_READ(2,13,PLC_IR,2,2,MC_VR,0)
GOSUB check_status

PRINT VR(0)[0],VR(1)[0]
STOP
```

```
check_status:
 VR(250)=HLM_STATUS PORT(2)

 IF VR(250)=0 THEN
 PRINT "Succeeded"
 RETURN
 ELSE
 PRINT "Failure (";attempt[0];"): ";

 IF READ_BIT(9,250) THEN
 PRINT "Command not recognized by slave"
 ELSE
 IF READ_BIT(8,250) THEN
 PRINT "Timeout error"
 ELSE
 PRINT "Received end code: ",HEX(VR(250))
 ENDIF
 ENDIF

 IF attempt=3 THEN
 PRINT "Read failed after 3 attempts"
 STOP
 ENDIF
 attempt=attempt+1
 GOTO loop
 ENDIF
```



# Index

## A

- absolute encoder, 54
- absolute moves, 8
- acceleration rate, 8
- adding axes, 13
- ASCII emulation, 205
- axis
  - adding, 13
  - configuration, 44
  - demand position, 15
  - encoder input, 45
  - encoder output, 45
  - measured position, 15
  - repeat distance, 177
  - servo, 44
  - status, 121
  - types, 44
  - virtual, 45
- axis types, 44

## B

### BASIC

- commands, 86
- data structures, 87
- functions, 86
- group structure, 102
- I/O access, 50
- labels, 88
- parameters, 86
- statements, 86
- variables, 87

BASIC commands, functions and parameters listed alphabetically, 111

- ABS, 114
- ACCEL, 8, 115
- ACOS, 115
- add operator, 111
- ADD\_DAC, 45, 115
- ADDAX, 13, 117
- ADDAX\_AXIS, 116
- AIN, 117
- AND, 118
- ASIN, 119
- ATAN, 119
- ATAN2, 119
- ATYPE, 44, 119
- AUTORUN, 120
- AXIS, 86, 120
- AXISSTATUS, 121, 208, 221
- BASE, 86, 121
- BASICERROR, 122, 223
- CAM, 11, 123

- CAMBOX, 12, 124
- CANCEL, 13, 125
- CHECKSUM, 126
- CHR, 170
- CLEAR, 87, 126
- CLEAR\_BIT, 126
- CLOSE\_WIN, 126
- CLUTCH\_RATE, 126
- comment field, 114
- COMMSERROR, 127
- COMPILE, 127
- CONNECT, 12, 127
- CONTROL, 128
- COPY, 128
- COS, 128
- CREEP, 129
- D\_GAIN, 16, 47, 129
- DAC, 182
- DATUM, 13, 129
- DATUM\_IN, 50, 130
- DECEL, 8, 131
- DEFPOS, 7, 131
- DEL, 131
- DEMAND\_EDGES, 132
- DIR, 132
- divide operator, 112
- DPOS, 15, 132
- DRV\_CLEAR, 133
- DRV\_READ, 133
- DRV\_RESET, 134
- DRV\_STATUS, 134
- DRV\_WRITE, 135
- EDIT, 135
- ENCODER, 136
- ENDMOVE, 136
- EPROM, 91, 136
- equal operator, 113
- ERROR\_AXIS, 136, 221
- ERROR\_LINE, 136, 223
- ERRORMASK, 137, 221
- EXP, 137
- FALSE, 137
- FAST\_JOG, 50, 137
- FB\_SET, 71, 138
- FB\_STATUS, 138
- FE, 15, 138
- FE\_LIMIT, 39, 138
- FE\_RANGE, 139
- FHOLD\_IN, 50, 139
- FHSPEED, 139
- FLASHVR, 139
- FOR, 140
- FORWARD, 10, 141
- FRAC, 141
- FREE, 141
- FS\_LIMIT, 142
- FWD\_IN, 40, 50, 142

FWD\_JOG, 50, 142  
GET, 142  
GOSUB, 88, 143  
GOTO, 88, 143  
greater than operator, 113  
greater than or equal operator, 113  
HALT, 144  
HEX, 170  
hexadecimal input, 114  
HLM\_COMMAND, 144  
HLM\_READ, 146  
HLM\_STATUS, 147  
HLM\_TIMEOUT, 147  
HLM\_WRITE, 148  
HLS\_MODEL, 149  
HLS\_NODE, 149  
I\_GAIN, 16, 47, 150  
IF, 150  
IN, 151  
INDEVICE, 151  
INPUT, 152  
INT, 152  
JOGSPEED, 153  
KEY, 153  
LAST\_AXIS, 153  
less than operator, 112  
less than or equal operator, 112  
LINK\_AXIS, 154  
LINPUT, 154  
LIST, 154  
LN, 155  
LOCK, 155  
MARK, 155  
MARKB, 156  
MERGE, 156  
MOD, 156  
MOTION\_ERROR, 156, 221  
MOVE, 8, 10, 157  
MOVEABS, 8, 10, 158  
MOVECIRC, 11, 159  
MOVELINK, 12, 160  
MOVEMODIFY, 163  
MPOS, 15, 163  
MSPEED, 163  
MTYPE, 89, 163  
multiply operator, 111  
NEW, 164  
NIO, 164  
NOT, 164  
not equal operator, 113  
NTYPE, 89, 165  
OFF, 165  
OFFPOS, 165  
ON, 165–166  
OP, 166  
OPEN\_WIN, 167  
OR, 167  
OUTDEVICE, 168  
OUTLIMIT, 168  
OV\_GAIN, 16, 47, 168  
P\_GAIN, 16, 47, 169  
PI, 169  
PMOVE, 90, 169  
power operator, 111  
PP\_STEP, 169  
PRINT, 170  
PROC, 87, 171  
PROC\_LINE, 171  
PROC\_STATUS, 172  
PROCESS, 172  
PROCNUMBER, 172  
PSWITCH, 172  
RAPIDSTOP, 13, 173  
READ\_BIT, 174  
REG\_POS, 174  
REG\_POSB, 174  
REGIST, 14, 174  
REMAIN, 177  
RENAME, 177  
REP\_DIST, 177  
REP\_OPTION, 178  
REPEAT, 178  
RESET, 87, 179  
RETURN, 143  
REV\_IN, 40, 50, 179  
REV\_JOG, 50, 179  
REVERSE, 10, 179  
RS\_LIMIT, 180  
RUN, 180  
RUN\_ERROR, 180, 223  
RUNTYPE, 93, 181  
S\_RATE, 181  
S\_REF, 47, 182  
S\_REF\_OUT, 182  
SCOPE, 182  
SCOPE\_POS, 183  
SELECT, 184  
SERVO, 47, 184  
SERVO\_PERIOD, 184  
SET\_BIT, 185  
SETCOM, 185  
SGN, 185  
SIN, 186  
SPEED, 8, 186  
SQR, 186  
SRAMP, 186  
statement separator, 114  
STEPLINE, 186  
STOP, 187  
subtract operator, 112  
SWITCH\_STATUS, 187  
T\_RATE, 188  
T\_REF, 188  
TABLE, 87, 188

TAN, 189  
TICKS, 189  
TRIGGER, 190  
TROFF, 190  
TRON, 190  
TRUE, 191  
TSIZE, 191  
UNITS, 7–8, 191  
UNLOCK, 155  
VERSION, 191  
VFF\_GAIN, 16, 47, 192  
VP\_SPEED, 192  
VR, 87, 192  
WA, 193  
WAIT IDLE, 193  
WAIT LOADED, 194  
WAIT UNTIL, 194  
WDOG, 47, 195, 221  
WHILE, 195  
XOR, 195

BASIC programs  
  compile description, 91  
  debugging, 190, 207  
  editing, 205  
  error processing, 94  
  managing, 91  
  multitasking, 86  
  priority, 92  
  run at start-up, 92  
  stepping, 186  
  storing, 91  
  tasks, 92  
  trace function, 190  
  trace function (TRON/TROFF), 190

BASIC statement groups  
  axis parameters, 107  
  constants, 107  
  DeviceNet commands and parameters, 110  
  Host Link commands and parameters, 110  
  I/O commands and functions, 103  
  loop and conditional structure commands, 104  
  mathematical and logical functions, 106  
  motion control commands, 103  
  Motion Perfect statements, 107  
  program commands and functions, 104  
  Servo Driver commands and parameters, 110  
  system commands and parameters, 105  
  task commands and parameters, 109

buffer  
  actual move, 89  
  next move, 89  
  task, 89

## C

CAM control, 11  
cancelling moves, 13  
circular interpolation, 11  
clearing following error, 129  
command line interface, 90, 204  
comparison between firmware versions, 21  
components, 24  
connection examples  
  encoder I/O, 38  
  serial ports, 33  
continuous moves, 10  
continuous path control, 10  
control  
  speed, 47  
  torque, 49  
control system, 14  
coordinate system  
  description, 7  
  scaling, 169  
CP control. See continuous path control

## D

data format, 72  
datuming. See origin search  
debugging. See BASIC programs, debugging  
deceleration rate, 8  
demand position, 15  
demand speed, 8  
derivative gain, 16  
DeviceNet  
  communication, 68  
  explicit messages, 72  
  remote I/O communications, 68  
DeviceNet connector, 36  
DeviceNet specifications, 21  
dimensions, 29

## E

EG control. See electronic gearing  
electronic gearbox, 12  
electronic gearing, 11  
encoder  
  absolute, 54  
  input axis, 45



- output axis, 45
- encoder signals
  - definition, 17
  - input, 17
  - output, 18
- error processing, 94
- errors
  - BASIC error code list, 223
  - BASIC run-time errors, 223
  - Host Link Master, 224
  - indicators, 220
  - motion error, 221
  - Servo Driver communication error, 223
- explicit messages
  - error response, 74
  - FINS command, 73
  - one-word format, 72
  - programming example, 81
  - RESET, 80
  - TABLE DATA READ (THREE-WORD FORMAT), 75
  - TABLE DATA WRITE (THREE-WORD FORMAT), 77
  - three-word format, 73
  - VR DATA READ (ONE-WORD FORMAT), 76
  - VR DATA READ (THREE-WORD FORMAT), 76
  - VR DATA WRITE (ONE-WORD FORMAT), 79
  - VR DATA WRITE (THREE-WORD FORMAT), 78

## **F**

- features, 2
- feedhold
  - input, 139
  - speed, 139
- floating point
  - comparison, 89
  - definition, 88
- following error
  - limit, 138
  - limit setting, 39
  - range, 139
- functional specifications, 19

## **G-I**

- gain
  - derivative, 16
  - integral, 16
  - output speed, 16
  - proportional, 16
  - speed feedforward, 16
- general specifications, 19
- general-purpose protocol
  - commands, 67

- programming example, 67
- global variables, 87
- Host Link Master
  - commands, 60
  - end codes, 62
  - precautions, 63
  - programming examples, 64, 252
  - set-up, 62
  - status, 63
  - timeout, 63
- Host Link Slave
  - commands, 65
  - end codes, 66
  - programming example, 67
  - set-up, 66
- I/O
  - mapping, 50
  - print registration
- I/O connector, 30
- I/O specifications, 36
- indicators, 24
- installation
  - conditions, 28
  - method, 28
- integer, definition, 88
- integral gain, 16
- interpolation
  - circular, 11
  - linear, 10

## **J-L**

- jogging
  - forward input, 142
  - Motion Perfect jog screen, 211
  - reverse input, 179
  - speed, 153
- labels, definition, 87
- LED indicators, 24
- limit switches
  - description, 39
  - forward input, 142
  - reverse input, 179
  - Servo Driver, 51
- linear interpolation, 10
- linked CAM control, 12
- linked move, 12
- local variables, 87

## M

- master shell program, 245
- mathematical specifications, 88
- measured position, 15
- monitoring data
  - Servo Driver analog input, 52
  - Servo Driver torque command, 53
  - Servo Driver torque monitor, 54
  - Servomotor rotation speed, 53
- motion control
  - algorithm, 15
  - concepts, 7–14
  - types, 2
- motion generator, 89
- Motion Perfect
  - axis parameters window, 208
  - connecting to MC Unit, 198
  - control panel, 202
  - controller configuration window, 209
  - debugging, 207
  - desktop, 201
  - features, 198
  - firmware download, 218
  - full controller directory window, 211
  - I/O status window, 210
  - jog screen, 211
  - oscilloscope, 212
  - program editor, 205
  - project backup, 217
  - requirements, 198
  - retrieving backup, 218
  - simple examples, 203
  - Table editor, 209
  - terminal window, 204
  - tools, 204
  - VR editor, 209
- Motion Perfect projects
  - backup, 199
  - consistency check, 200
  - description, 199
  - manager, 199
- motor runaway, 39
- move loading, 90
- moves
  - absolute, 8
  - calculations, 9
  - cancelling, 13
  - continuous, 10
  - defining, 9
  - execution, 89
  - merging, 156
  - relative, 8
- multitasking, 86

## N-O

- number format, 88
- one-word format, 72
- origin search, 13
- output speed gain, 16

## P

- point-to-point control, 8
- positioning
  - continuous path, 10
  - electronic gearing, 11
  - point-to-point, 8
- power connector, 31
- precautions
  - general, xii
  - Motion Perfect, 217
  - safety, xii
  - servo system, 39
  - using parameter unit, 45
  - wiring, 40
- precedence, 89
- print registration
  - delay times, 36
  - description
- programming example
  - Host Link Master, 252
- programming examples
  - controlling I/O, 250
  - coordinating two moving objects, 251
  - coordinating with mark detection, 252
  - high-speed profiles, 251
  - master shell program, 245
  - product detection, 250
  - rotary table, 250
  - Servo Driver parameter setting program, 248
  - synchronising cutter, 251
- proportional gain, 16
- protocol
  - general-purpose, 67
  - Host Link Master, 60
  - Host Link Slave, 65
- PTP control. See point-to-point control

## Q-R

- registration. See print registration
- relative moves, 8
- remote I/O communications, 68

## S

- S-curve factor, 186
- semi-closed loop system, 14
- sequencing, 90
- serial communication protocols, 60
- serial port connectors, 31
- servo axis, 44
- Servo Driver
  - alarm, 225
  - enable switch, 195
  - limit switches, 51
  - parameter access, 57
  - required settings, 46
  - software reset, 57
- servo period, 46, 92
- servo system, 14
  - precautions, 39
- software limit
  - forward, 142
  - reverse, 180
- software reset, 217
- specifications
  - DeviceNet, 21
  - functional, 19
  - general, 19
  - I/O, 36
  - mathematical, 88
  - RS-232C interface, 31
  - RS-422A/485 interface, 32
- speed control, 47
- speed feedforward gain, 16
- statements
  - axis, 86
  - description, 86
  - system, 87
  - task, 87
- system configuration
  - basic, 5
  - DeviceNet, 6

## T-U

- table variables, 87
- task
  - buffer, 89
  - clock pulses, 189
  - priority, 92
- terminal window, 90, 204
- three-word format, 73
- torque control, 49

- troubleshooting BASIC programs, 207
- unit conversion factor, 7–8
- unit settings, 24

## V-Z

- variables
  - global, 87, 192
  - local, 87
  - table, 87, 188
- virtual axis, 45
- VR variables. See variables, global
- VT100 Emulation, 205
- wiring
  - DeviceNet connector, 36
  - I/O connector, 30
  - power connector, 31
  - precautions, 40
  - serial port connectors, 31

## Revision History

A manual revision code appears as a suffix to the catalog number on the front cover of the manual.

Cat. No. I203-E2-02



Revision code

The following table outlines the changes made to the manual during each revision. Page numbers refer to the previous version.

| Revision code | Date       | Revised content                                                                                                                                                                                                                                                                                                |
|---------------|------------|----------------------------------------------------------------------------------------------------------------------------------------------------------------------------------------------------------------------------------------------------------------------------------------------------------------|
| 1             | June 2002  | Original production                                                                                                                                                                                                                                                                                            |
| 2             | March 2003 | Revisions and additions as follows: <ul style="list-style-type: none"><li>• Added comparison section for firmware update (FW 1.61, FW 1.62).</li><li>• Added description for dual feedback control command ADD_DAC and related functionality.</li><li>• Updated DeviceNet data according to FW 1.62.</li></ul> |