

Smart Laser Sensor

ZX-L *Unique Plug & Play Measurement Concept for Precise Measurement*

A multitude of "smart" functions packed in a small amplifier. Full line-up of heads for different detection methods and micron detection performance



ZX-L

Features

The world's smallest and lightest laser sensor.

It is the world's lightest. A body size similar to a photoelectric sensor permits space conservation and solves installation space problems.

Naturally, we have also achieved a high-speed response on the same level as a photoelectric sensor.

* High-speed sampling: 0.15 ms (response speed: 0.3 ms)

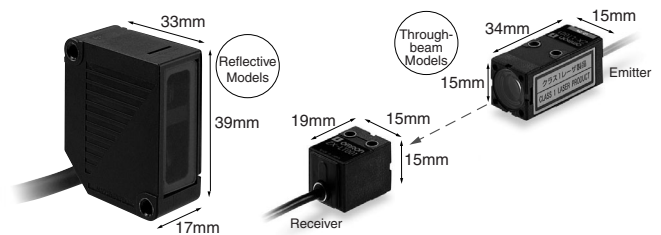

Platform architecture as an optimum solution

Platform architecture allows users to configure a variety range of sensor-heads to one amplifier.

Plug & Play provides easy sensorhead replacement and easy maintenance.

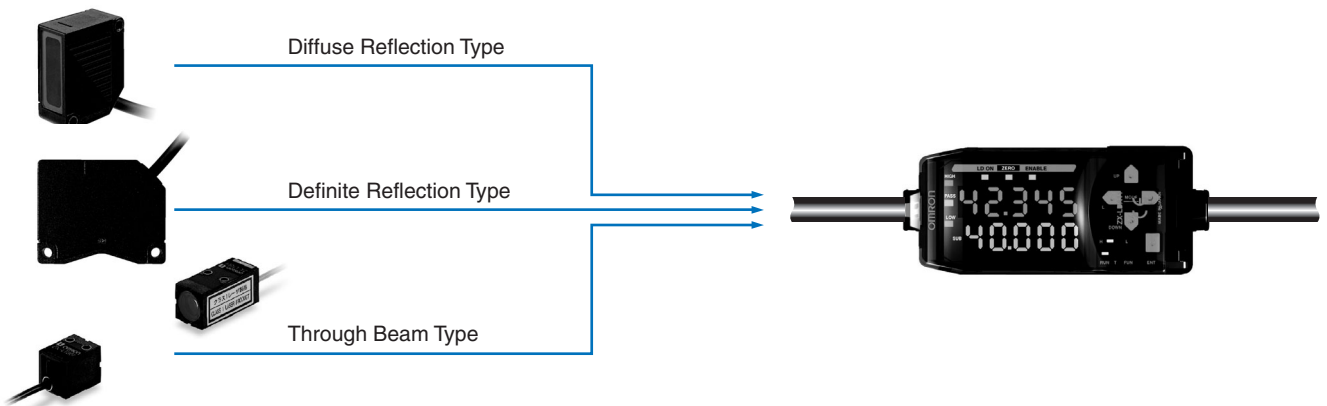

Our line-up includes 8 reflective-type models and 3 Through-beam-type models.

Reflective Models Class 2 visible-light laser

Minute work is detected by a spot beam, and regular work is detected by a line beam. Smart adaptation to meet the needs of the application. Furthermore, the system seamlessly covers a measurement range of 28 mm to 500 mm.

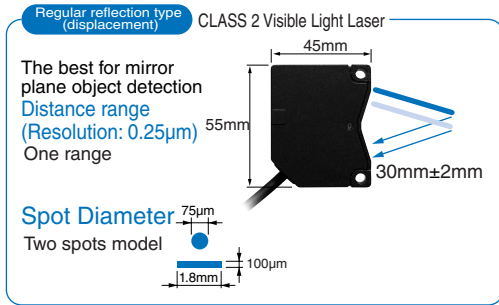
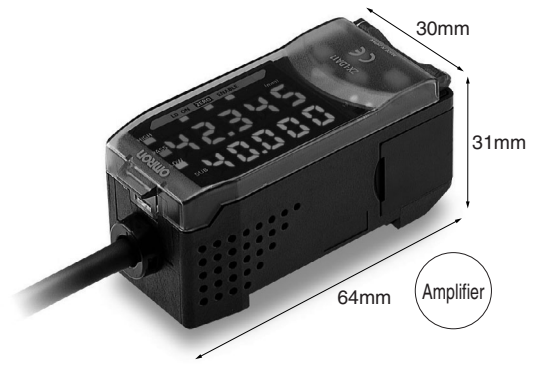
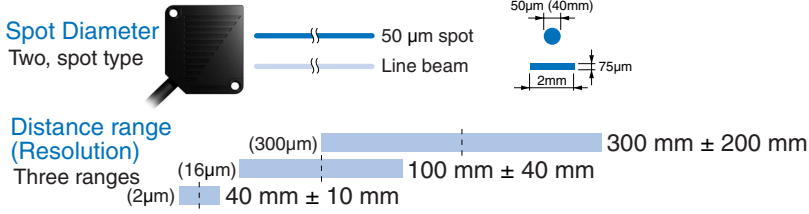

Through-beam Models Class 1 visible-light laser

High-precision positioning is accomplished with a 1 mm dia. spot beam, and area detection is accomplished with a 5 mm width / 10 mm width screen beam.

Measurement width and distance range (Resolution: 4mm)

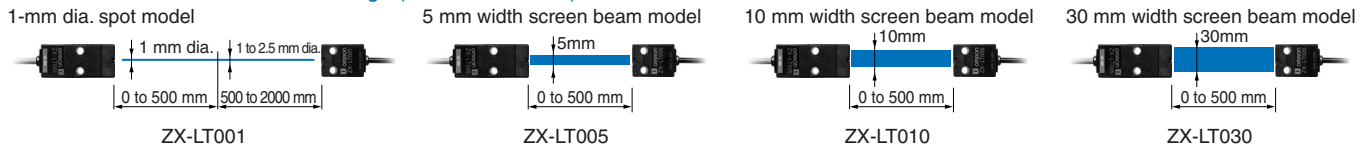

Many useful functions are provided.

Calculation settings that eliminate the need for a digital panel meter Patent pending

A calculation unit can be inserted between two amplifiers to display the calculation results of two sensor units on one of the amplifiers. Settings are accomplished by simply entering the necessary parameters in one of the amplifiers.



Includes a sensor life monitor.

The laser diode (LD) life is detected automatically and the operator alerted.

When LD deterioration is detected, the sub-display alerts you. This gives you time to take action before the LD dies.



Top priority is given to easy operation.

Sophisticated functions and high performance, with ease of use. This is a key feature of the ZX-L-Series. The interface comes from our E3X-DA-N* Digital Fiber Amplifier. Feel how simple it is to operate.

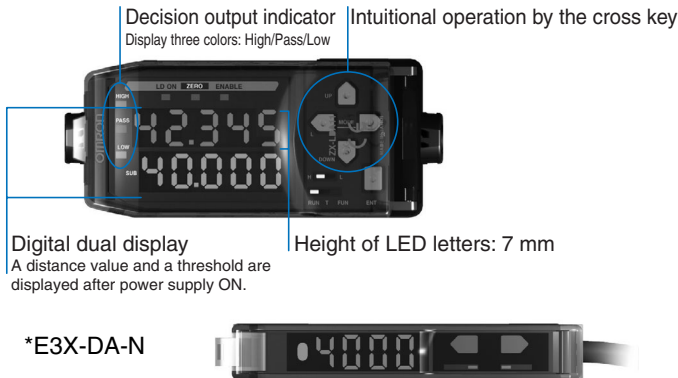

Obtain the resolution with ease Patent pending

Simply perform detection of the work you wish to test, and you can check the resolution. The resolution is displayed so you can check how much fluctuation there is to the threshold setting and decide whether detection is possible with certitude.

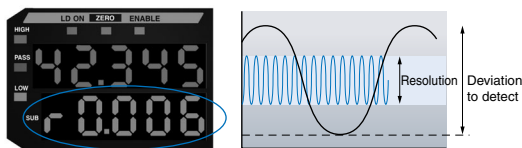

Reflective Models

Light intensity mode for high-performance laser photoelectric detection

Light intensity detection is possible using the minute spot of the laser beam. The sensor can be used not only as a displacement meter, but also as a high-precision laser photoelectric sensor for detection of minute work with a background object and color difference. Select displacement mode or light intensity mode as appropriate for the application to establish the optimum function settings.

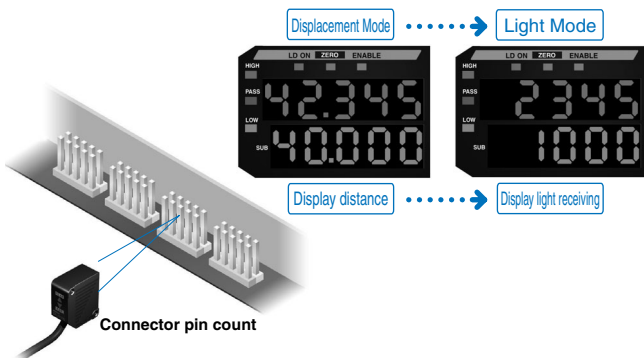

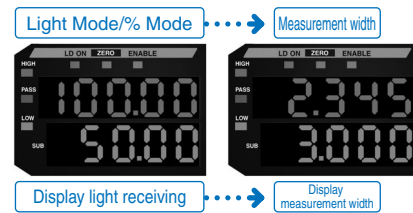

Through-beam Models



Multiple teaching functions.

Positioning / 2-point / auto-matching

Includes three types of teaching functions on the same level as a photoelectric sensor.

-  **Positioning teaching**
Ideal for high-precision positioning applications.
-  **Two-point teaching**
Ideal for detection of minute level differences between two points.
-  **Automatic teaching**
Ideal for applications where teaching is performed without stopping the work.

Install in any direction.

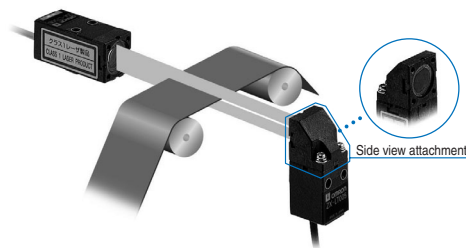

A side viewer attachment (optional) can be installed to enable various installations



Wide variety of easy-to-use functions.

Scaling, display reverse, display off mode, ECO mode, change number of display digits, measurement processing (various timer functions and hold functions), threshold value settings, input/output settings, mutual interference (when using a computing unit), function lock, initial reset, zero reset, differential function, sensitivity selection, monitor focus, etc.

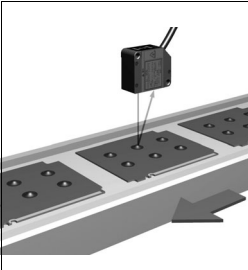
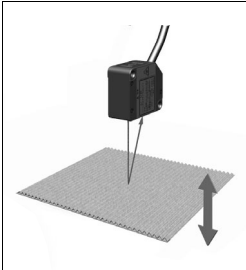
Application

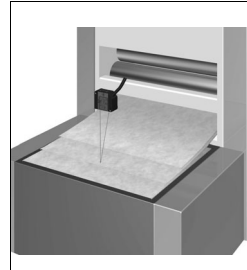
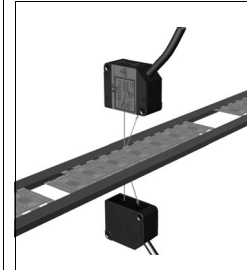
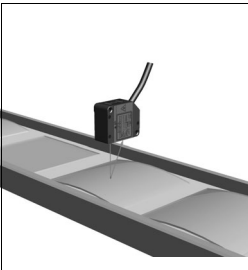
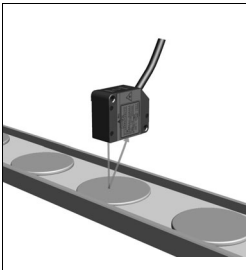
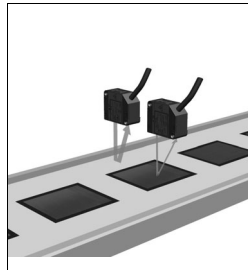
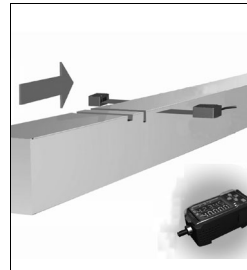
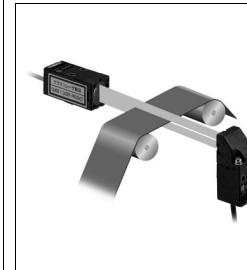
<p>NORMAL Height measurement of a minute object</p> 	<p>POSITION Face positioning</p> 	<p>P-P Face swing/eccentricity</p> 	<p>EDGE Sheet count</p> 	<p>THICK Thickness of object with flutter</p> 
<p>PEAK Detection of warping / level difference</p> 	<p>SELF Continuous measurement</p> 	<p>A-B Detection of presence of thin object</p> 	<p>APERTURE Gap detection</p> 	<p>OUTSIDE Shape detection</p> 

Features

Connect to a computer for full use of sensor performance.

Use the computer monitor screen for enhanced panel display. Easy processing of detection results such as waveform monitor and data logging results, which used to make system configuration more easy.



Waveform monitoring function

Easy monitoring of waveforms, which was previously only possible with an oscilloscope. Plenty of easy-to-use functions, such as drag and drop threshold value setting.

Waveform monitoring

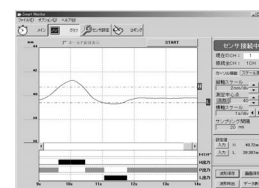

Quality control as you desire.

Data logging

Log detection data and manage a status history for effective and efficient quality control and implementation of countermeasures for problems.



Settings are supported by a list display

Settings that are complicated if the amplifier panel must be used can be easily accomplished by referring to the Function menu. The settings can also be easily imported to and exported from a text editor.

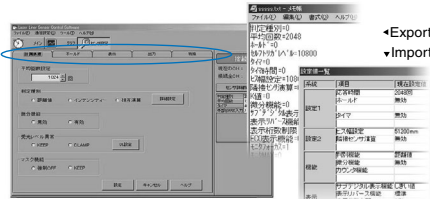

Summary of PC software specifications

Digital numerical value monitoring

- Tolerance direct threshold value setting
- Various teaching settings

Waveform monitoring

- Waveform collection
- Waveform observation/editing
- Waveform saving/reading

Data logging

- Various collection condition settings
- Supports Microsoft Excel

Configuration function

- Amplifier unit function settings (observation scaling, input scaling, etc.)
- Saving/reading of amplifier setting conditions

**Microsoft Excel is either registered trademarks or trademarks of Microsoft Corporation in the United States and/or other countries.

Ordering Information

Sensors

Sensor head (reflection type)

Optical method	Beam shape	Sensing distance	Resolution *	Model
Diffuse-reflective	Spot beam	40 ± 10 mm	2 m	ZX-LD40
		100 ± 40 mm	16 m	ZX-LD100
		300 ± 200 mm	300 m	ZX-LD300
	Line beam	40 ± 10 mm	2 m	ZX-LD40L
		100 ± 40 mm	16 m	ZX-LD100L
		300 ± 200 mm	300 m	ZX-LD300L
Regular reflection type	Spot beam	30 ± 2 mm	0.25 m	ZX-LD30V
	Line beam			ZX-LD30VL

* At average count of 4,096 times

Sensor head (transmissive type)

Optical method	Measurement width	Sensing distance	Resolution *	Model
Through-beam	1 mm dia.	0 to 2,000 mm	4 μm	ZX-LT001
	5 mm	0 to 500 mm		ZX-LT005
	10 mm			ZX-LT010
	30 mm		12 μm	ZX-LT030

* At average count of 64 times

Amplifier Units

Shape	Power supply	Output specifications	Model
	DC	NPN output	ZX-LDA11-N
		PNP output	ZX-LDA41-N

Note: Compatible with sensor head connection.

Accessories (Order Separately)

Computing unit

Shape	Model
	ZX-CAL2^{*1}

*1: Calculation Units are required to connect two or more sensors



Side view attachment

Shape	Suitable sensor head	Model
	ZX-LT001 ZX-LT005	ZX-XF12
	ZX-LT010	ZX-XF22

Extension cable for robot application

Cable length	Model	Quantity
1m	ZX-XC1R	1 pc.
4m	ZX-XC4R	
8m	ZX-XC8R	
9m	ZX-XC9R	

"Smart monitor" communication interface and Setup Tool for Personal Computer and PLC

Shape	Name	Model
	ZX-L-series Communication Interface Unit	ZX-SF11
	ZX-series Communication Interface Unit + ZX-L-series Sensor Setup and Logging Software + CD-ROM	ZX-SFW11E V3
	ZX-L-series Sensor Setup and Logging Software	ZX-SW11E V3

Two-sided connector cable (for extension)

Cable length	Model	Quantity
1 m	ZX-XC1A	1 pc.
4 m	ZX-XC4A	
8 m	ZX-XC8A	
9 m *	ZX-XC9A	

* Only for reflective types.

Rating/Performance

Sensor head (reflection type)

Item Model	ZX-LD40	ZX-LD100	ZX-LD300	ZX-LD30V	ZX-LD40L	ZX-LD100L	ZX-LD300L	ZX-LD30VL
Optical method	Diffuse reflection			Regular reflection	Diffuse reflection			Regular reflection
Light source (wave length)	Visible-light semiconductor laser (wavelength 650 nm, 1 mW or less, Class 2)							
Measurement center distance	40 mm	100 mm	300 mm	30 mm	40 mm	100 mm	300 mm	30 mm
Measurement range	±10 mm	±40 mm	±200 mm	±2 mm	±10 mm	±40 mm	±200 mm	±2 mm
Beam shape	Spot			Line				
Beam diameter *1	50 mm dia.	100 mm dia.	300 mm dia.	75 mm dia.	75 m x 2mm	150 m x 2 mm	450 m x 2 mm	100 m x 1.8 mm
Resolution*2	2 m	16 m	300 m	0.25 m	2 m	16 m	300 m	0.25 m
Linearity*3	±0.2% F.S. (entire range)	±0.2% F.S. (80 to 121 mm)	±2% F.S. (200 to 401 mm)	±0.2% F.S. (entire range)	±0.2% F.S. (32 to 49 mm)	±0.2% F.S. (80 to 121 mm)	±2% F.S. (200 to 401 mm)	±0.2% F.S. (entire range)
Temperature drift*4	±0.03% F.S./°C (±0.1% F.S./°C for ZX-LD300/ZX-LD300L)							
Ambient illuminance	Incandescent lamp: 3,000 lux max.							
Ambient temperature	Operating: 0°C to 50°C, Storage: -15°C to 60°C (with no icing or condensation)							
Ambient humidity	Operating/Storage: 35% to 85% RH (with no condensation)							
Insulation resistance	20 M at 500 VDC							
Dielectric strength	1,000 VAC at 50/60 Hz for 1 minute							
Vibration resistance	10 to 150 Hz, 0.7 mm double amplitude for 80 minutes each in X, Y, and Z directions							
Shock resistance	300 m/s ² , 6 directions, 3 times each (up-down, left-right, forward-backward)							
Protective structure	IEC 60529 IP50			IEC Standard IP40	IEC 60529 IP50			IEC Standard IP40
Connection method	Junction connector (standard length: 500 mm)							
Weight (Packed state)	Approx. 150 g			Approx. 250 g	Approx. 150 g			Approx. 250 g
Material	Case: PBT (polybutylene terephthalate), Cover: Aluminum, Lens: Glass			Case, Cover: Aluminum, Lens: Glass	Case: PBT (polybutylene terephthalate), Cover: Aluminum, Lens: Glass			Case, Cover: Aluminum, Lens: Glass
Accessories	Operation manual, laser warning labels (English characters)							

*1. Beam diameter: This is the value of the measurement center distance (actual value), and is defined at 1/e² (13.5%) of the central light intensity. If there is stray light outside, the defined area and the area around the object has a higher reflectance than the object.

*2. Resolution: Indicates the amount of fluctuation (±3%) in the linear output when connected to the ZX-LDA. (The measured value when the average count of the ZX-LDA is set to 4,096 and our standard object (white ceramic) is used for the central distance.) This indicates the repeatability precision when the work is in a static state, and does indicate the distance precision. The resolution performance may not be satisfactory in a strong electromagnetic field.

*3. Linearity: This indicates the error with respect to the ideal straight line of the displacement output when measuring our standard object.

*4. Temperature characteristic: The value when the distance between the sensor and the object (our standard object) is fixed using an aluminum jig. (Measured at the measurement center distance.)

Note: When an object has a high reflectance, detection errors are possible outside the measurement range.

Sensor head (transmissive type)

Item Model	ZX-LT001		ZX-LT005	ZX-LT010	ZX-LT030
Optical method	Through-beam				
Light source (wave length)	Visible-light semiconductor laser (wavelength 650 nm, 1 mW or less, Class 1)				
Measurement width	1 mm dia.	1 to 2.5 mm dia.	5 mm	10 mm	30 mm
Sensing distance	0 to 500 mm	500 to 2,000 mm	0 to 500 mm		
Min. sensing object	8 mm dia. Opaque object	8 to 50 mm Opaque object	Opaque: 0.05 mm dia.	Opaque: 0.1 mm dia.	Opaque: 0.3 mm dia.
Resolution ^{*1}	4 μm ^{*2}	---	4 μm ^{*3}		12 μm
Temperature drift	0.2%F.S./°C				0.3%F.S./°C
Ambient illuminance	Incandescent lamp: 3,000 lux max.				Incandescent lamp: 10,000 lux max.
Ambient temperature	Operating: 0°C to 50°C, Storage: -25°C to 70°C (with no icing or condensation)				
Protective structure	IEC 60529 IP40				IP 40
Cable length	Can be extended to 10 m with the special extension cable.				
Material	Case: polyetherimide, case cover: polycarbonate, front cover: glass				Zinc-die-cast
Clamping torque	0.3 N ² m max.				
Accessories	Optical axis adjustment seal, sensor head - amplifier unit connector cable, operation manual				Mounting bracket

^{*1}. The amount of fluctuation (±3 δ) of the linear output when connected to an amplifier unit, converted to a detection span.
^{*2}. When the average count is 64.5 μm when the count is 32. The value when the smallest detection object shades the vicinity of the center of the 1 mm dia. detection span.
^{*3}. When the average count is 64.5 μm when the count is 32.

Amplifier Units

Item Model	ZX-LDA11	ZX-LDA41
Measurement period	150 s	
Possible average count settings ^{*1}	1/2/4/8/16/32/64/128/256/512/1,024/2,048/4,096 times	
Temperature drift	When reflective head is connected: 0.01% F.S./°C, when transmissive head is connected: 0.1% F.S./°C	
Linear output ^{*2}	4 to 20 mA/F.S., maximum load resistance of 300 Ω ±4 V (±5 V, 1 to 5 V ^{*3}), output impedance of 100 Ω	
Decision output (HIGH/PASS/LOW: 3 outputs) ^{*1}	NPN open collector output, 30 VDC 50 mA max., residual voltage 1.2 V or less	PNP open collector output, 30 V DC 50 mA max., residual voltage 2 V or less
Laser OFF input / zero reset input / timing input / reset	When ON: supply voltage 1.5 V or less, when OFF: open circuit (maximum leakage current 0.1 mA or less)	When ON: supply voltage 1.5 V or less, when OFF: open circuit (maximum leakage current 0.1 mA or less)
Functions	Measurement value display, setting value and incident level and resolution display, scaling, display reverse, display off mode, ECO mode, change number of display digits, sample hold, peak hold, bottom hold, peak to peak hold, self peak hold, self-bottom hold, intensity mode, zero reset, initial reset, on-delay timer, off-delay timer, one-shot timer, differential, sensitivity selection, keeping clamp change, threshold value settings, positioning teaching, two-point teaching, automatic teaching, hiss width variable, timing input, reset input, monitor focus, (A-B) operation, (A+B) operation ^{*4} , mutual interference ^{*4} , laser degradation detection zero reset memory, function lock	
Indicator lamp	Operation indicator lamp: high (orange), pass (green), low (yellow), 7-segment digital main display (red), 7-segment digital sub-display (yellow), laser ON (green), zero reset (green), enable display (green)	
Power supply voltage	12 to 24 VDC ±10%, ripple (p-p) : 10% max.	
Current consumption	200 mA or less (when sensor is connected)	
Ambient temperature	Operating: 0°C to 50°C, Storage: -15°C to 60°C (with no icing or condensation)	
Ambient humidity	Operating/Storage: 35% to 85% RH (with no condensation)	
Insulation resistance	20 M Ω at 500 VDC	
Dielectric strength	1,000 VAC at 50/60 Hz for 1 minute	
Vibration resistance	10 to 150 Hz, 0.7 mm double amplitude for 80 minutes each in X, Y, and Z directions	
Shock resistance	300 m/s ² , 6 directions, 3 times each (up-down, left-right, forward-backward)	
Protective structure	---	
Connection method	Pre-wired models (standard length: 2 m)	
Weight (Packed state)	Approx. 350 g	
Material	Case: PBT (polybutylene terephthalate), Cover: Polycarbonate	
Accessories	Instruction manual	

^{*1}. The response speed of linear output (when the sensitivity is fixed) is calculated as (measurement period) x (average count setting + 1).
The response speed of decision output (when the sensitivity is fixed) is calculated as (measurement period) x (average count setting + 1).
^{*2}. Current/voltage can be switched using the switch on the bottom of the amplifier unit.
^{*3}. Can be set with the monitor focus function.
^{*4}. Computing unit is required.

Characteristic data (typical)

Angle characteristics (reflective type)

The angle characteristics are a plot of the inclination of the measured object vs. errors occurring in linear output at the measurement center distance.

ZX-LD40

Angular properties of vertical inclination

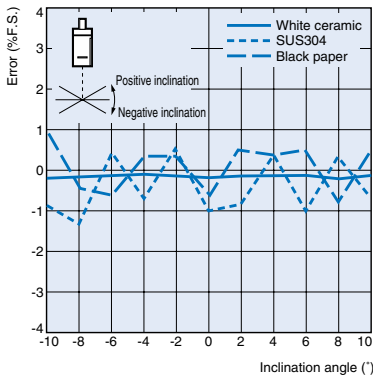

ZX-LD100

Angular properties of vertical inclination

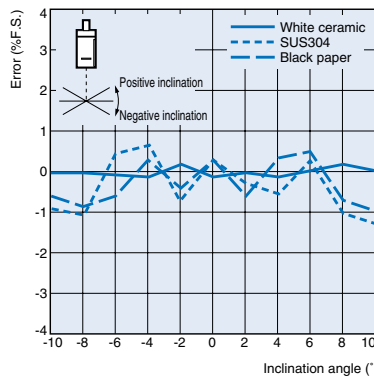

ZX-LD300

Angular properties of vertical inclination

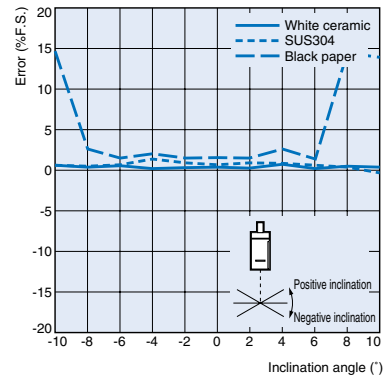

Angle characteristics with respect to horizontal inclination

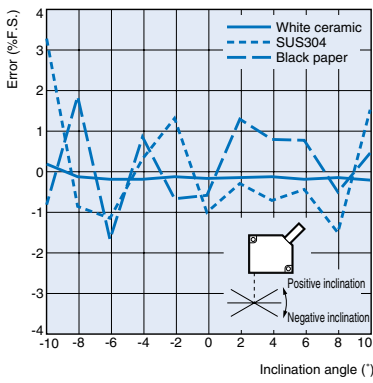

Angle characteristics with respect to horizontal inclination

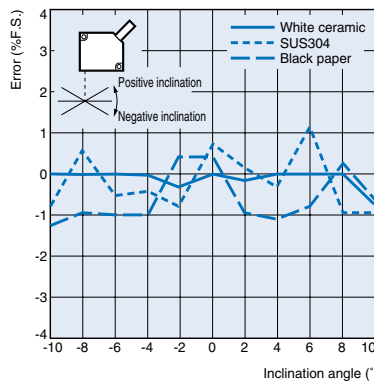

Angle characteristics with respect to horizontal inclination

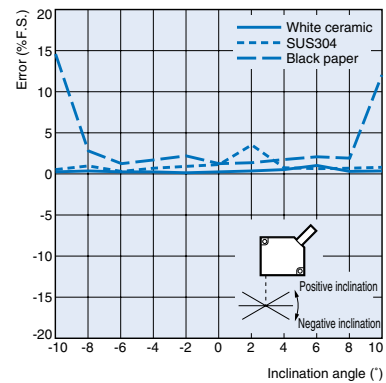

ZX-LD40L

Angular properties of vertical inclination

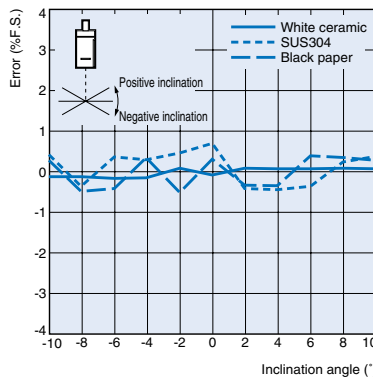

ZX-LD100L

Angular properties of vertical inclination

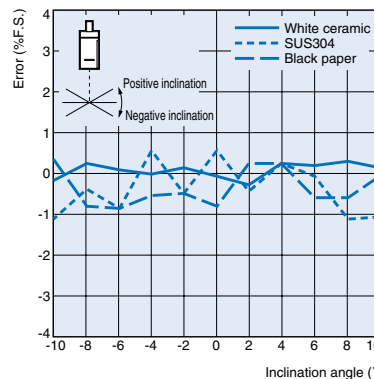

ZX-LD300L

Angular properties of vertical inclination

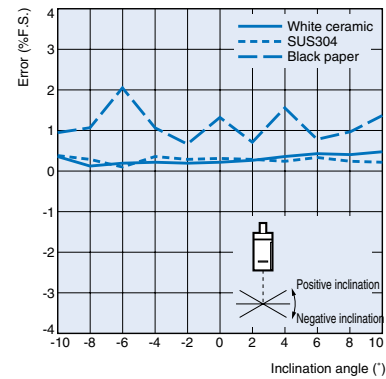

Angle characteristics with respect to horizontal inclination

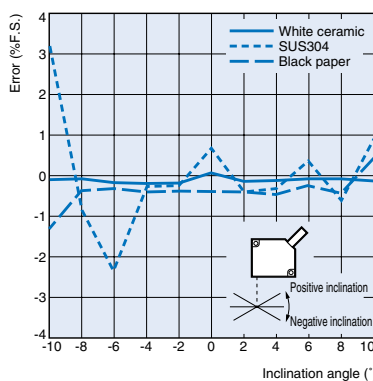

Angle characteristics with respect to horizontal inclination

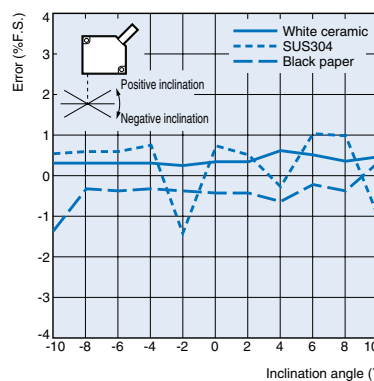

Angle characteristics with respect to horizontal inclination

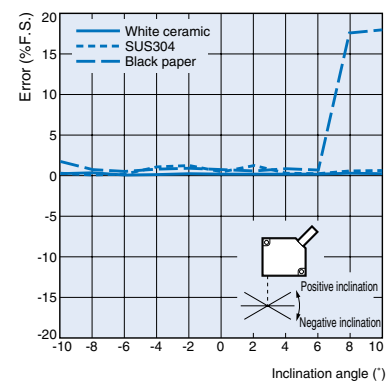

ZX-LD30V
Angular properties of vertical inclination

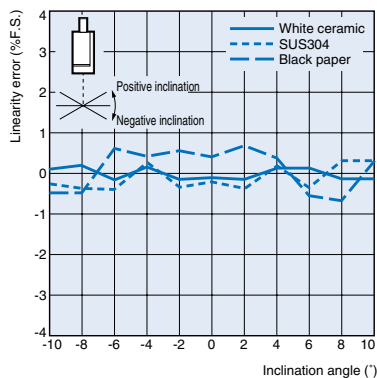

ZX-LD30VL
Angular properties of vertical inclination

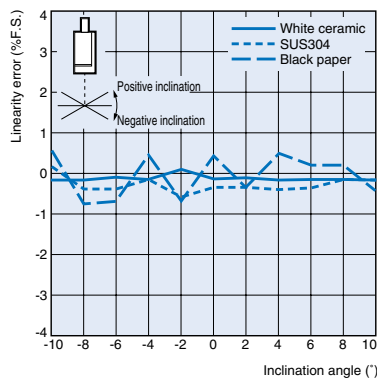

Angle characteristics with respect to horizontal inclination

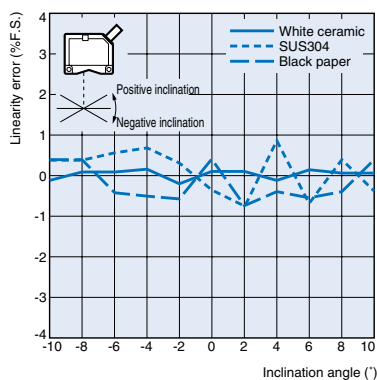

Angle characteristics with respect to horizontal inclination

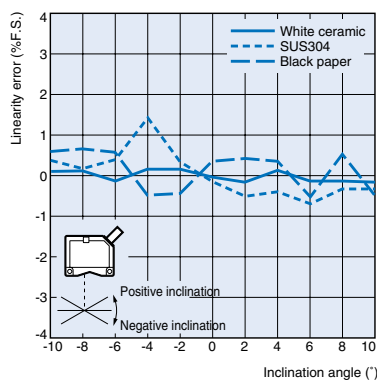

ZX-L

Linearity characteristics depending on material (reflective type)

ZX-LD40

Inclination angle 0°

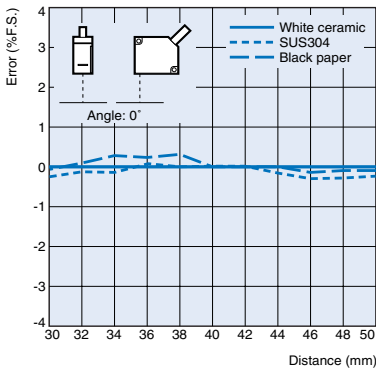

In case of a horizontal inclination

Inclination angle -10°

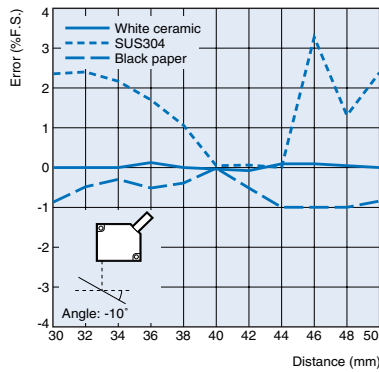

Inclination angle +10°

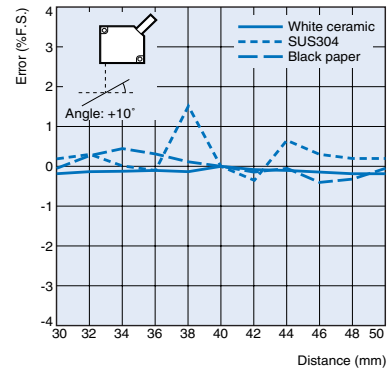

ZX-LD100

Inclination angle 0°

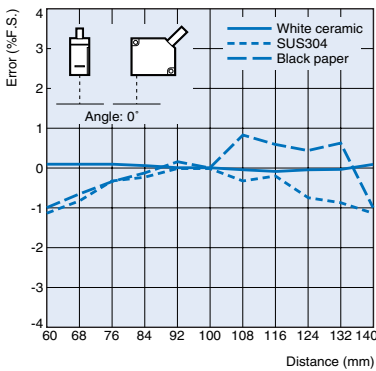

In case of a horizontal inclination

Inclination angle -10°

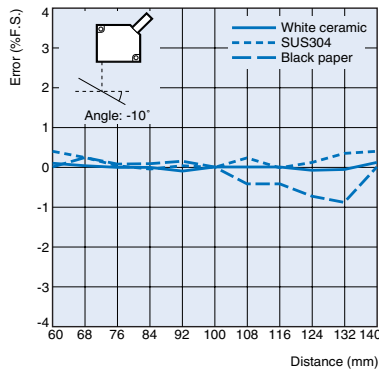

Inclination angle +10°

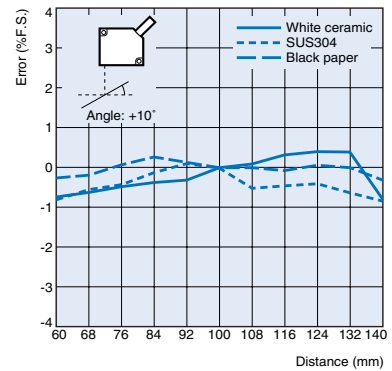

ZX-LD300

Inclination angle 0°

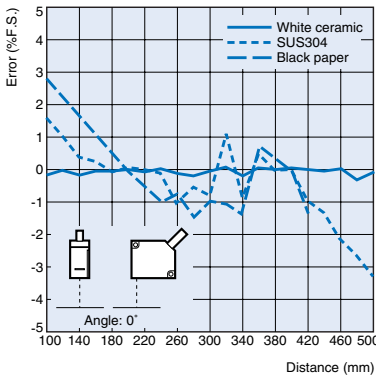

In case of a horizontal inclination

Inclination angle -10°

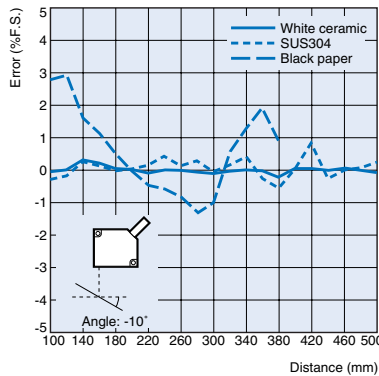

Inclination angle +10°

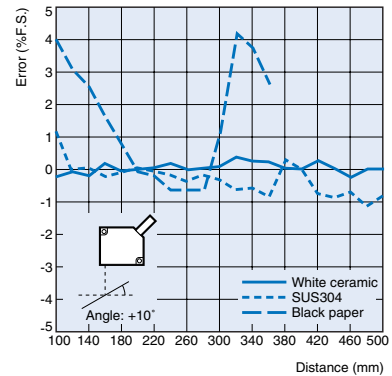

ZX-LD40L

Inclination angle 0°

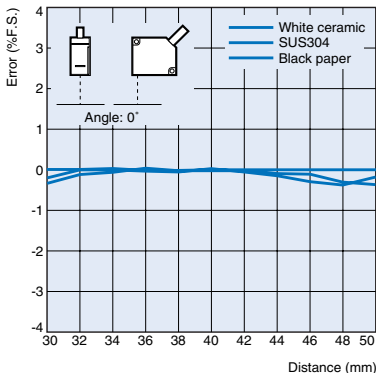

In case of a horizontal inclination

Inclination angle -10°

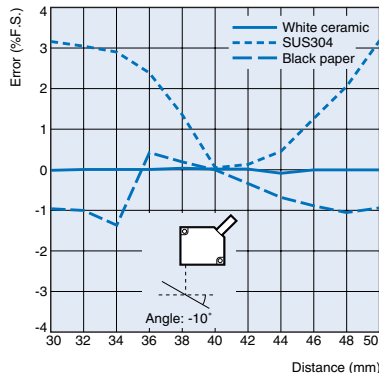

Inclination angle +10°

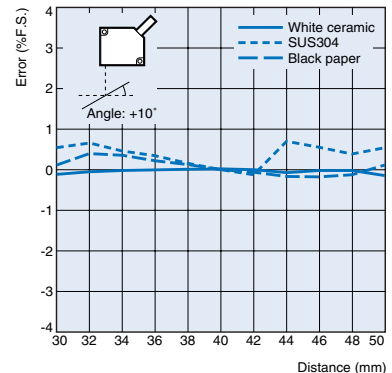

ZX-LD100L

Inclination angle 0°

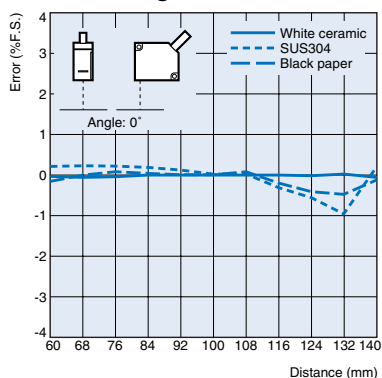

In case of a of a horizontal inclination

Inclination angle -10°

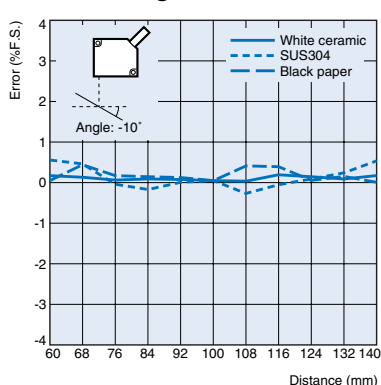

Inclination angle +10°

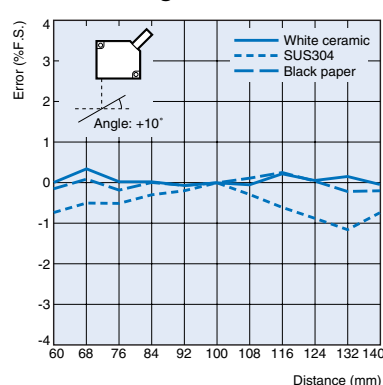

ZX-LD300L

Inclination angle 0°

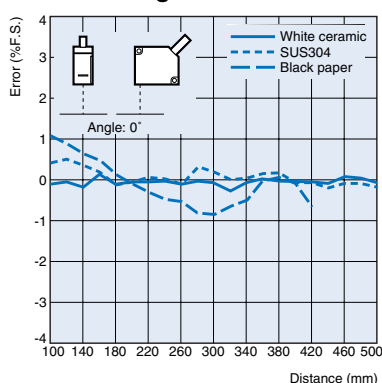

In case of a of a horizontal inclination

Inclination angle -10°

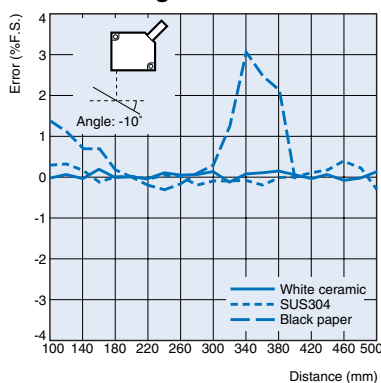

Inclination angle +10°

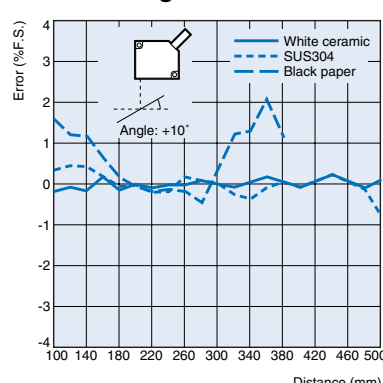

ZX-LD30V

Inclination angle 0°

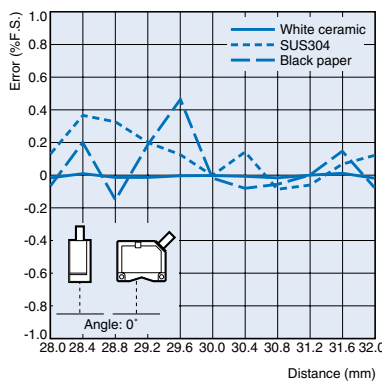

In case of a of a horizontal inclination

Inclination angle -10°

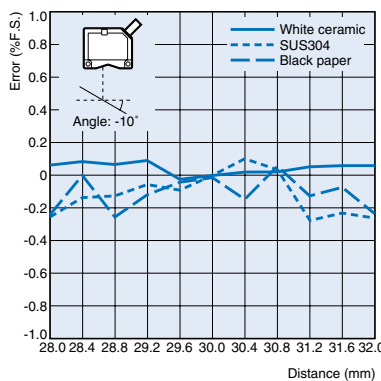

Inclination angle +10°

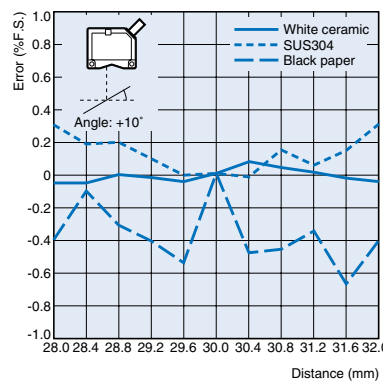

ZX-LD30VL

Inclination angle 0°

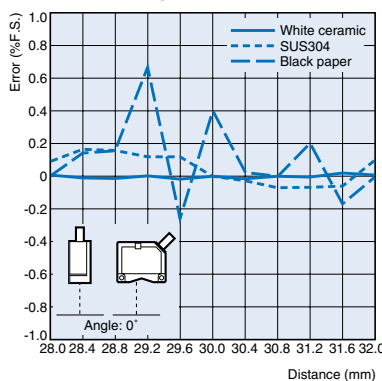

In case of of a horizontal inclination

Inclination angle -10°

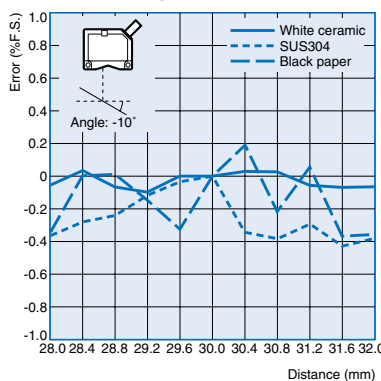

Inclination angle +10°

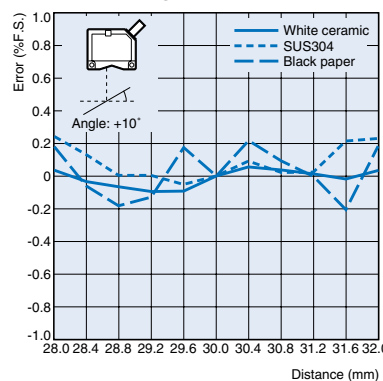

Spot diameter (reflective type)

Spot beam type

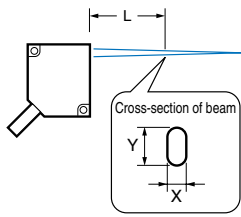

ZX-LD40

L	30 mm	40 mm	50 mm
X (m)	240 m	40.0 m	250 m
Y (m)	350 m	30.0 m	370 m

ZX-LD100

L	60 mm	100 mm	140 mm
X (m)	390 m	100 m	430 m
Y (m)	620 m	65.0 m	650 m

ZX-LD300

L	100 mm	300 mm	500 mm
X (m)	1,050 m	180 m	1,100 m
Y (m)	450 m	300 m	850 m

Line beam type

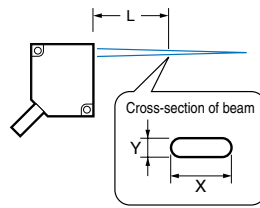

ZX-LD40L

L	30 mm	40 mm	50 mm
X (m)	2,000 m	2,000 m	2,000 m
Y (m)	240 m	50.0 m	250 m

ZX-LD100L

L	60 mm	100 mm	140 mm
X (m)	2,000 m	2,000 m	2,000 m
Y (m)	410 m	100 m	430 m

ZX-LD300L

L	100 mm	300 mm	500 mm
X (m)	2,000 m	2,000 m	2,500 m
Y (m)	750 m	300 m	650 m

Spot beam type

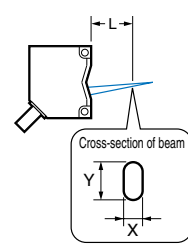

ZX-LD30V

L	28 mm	30 mm	32 mm
X (m)	60.0 m	30.0 m	120 m
Y (m)	50.0 m	40.0 m	90.0 m

Line beam type

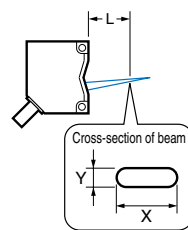

ZX-LD30VL

L	28 mm	30 mm	32 mm
X (m)	1,800 m	1,800 m	1,800 m
Y (m)	90.0 m	60.0 m	110 m

Detection object characteristics (transmissive type)

ZX-LT001

(Using a 0.02 mm dia. pin gauge)

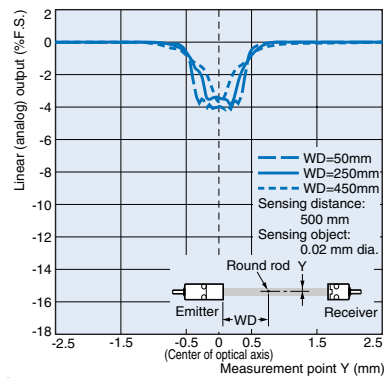

ZX-LT001

(Using a 0.05 mm dia. pin gauge)

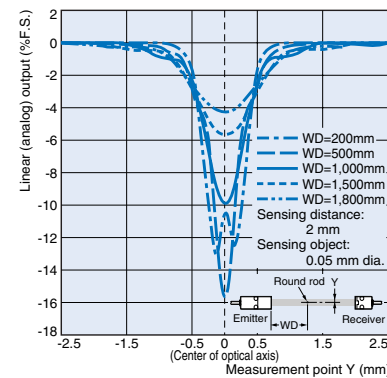

ZX-LT001

(Using a 0.05 mm dia. pin gauge)

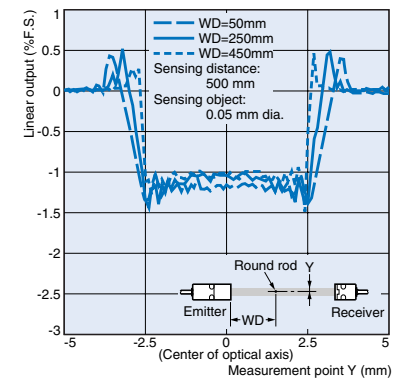

Linearity properties

ZX-LT005

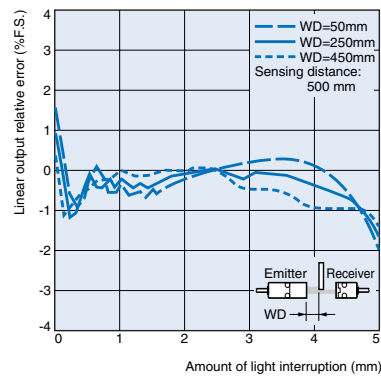
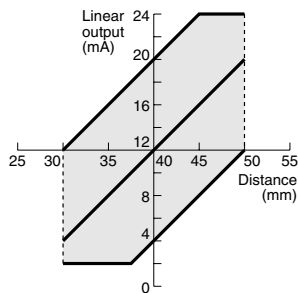

Diagram showing correlation between linear output and detection distance

Current or voltage can be selected with the amplifier unit switch.

ZX-LD40/LD40L

(Current output)



(Voltage output)

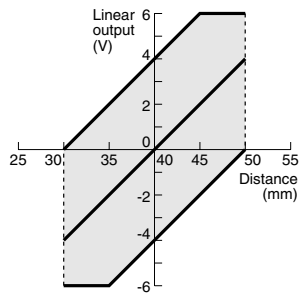

ZX-LD100/LD100L

(Current output)

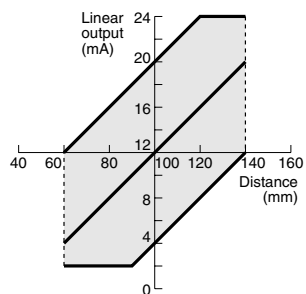

(Voltage output)

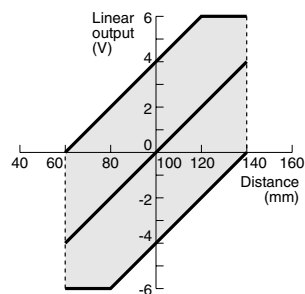

ZX-LD300/LD300L

(Current output)

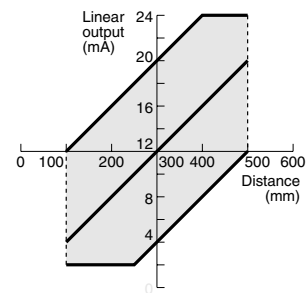

(Voltage output)

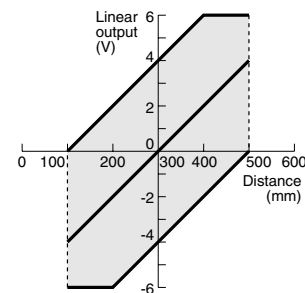

ZX-LD30V/LD30VL

(Current output)

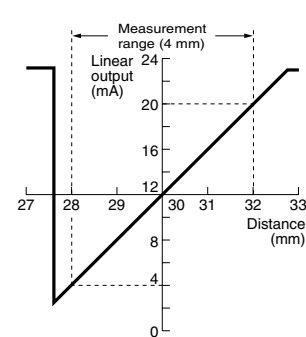

(Voltage output)

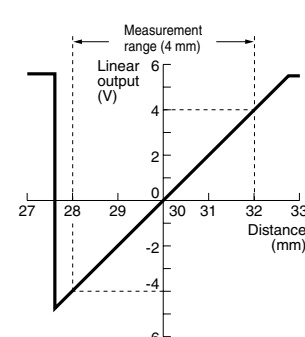

ZX-L

Input/output stage circuit schematic

NPN type: ZX-LDA11

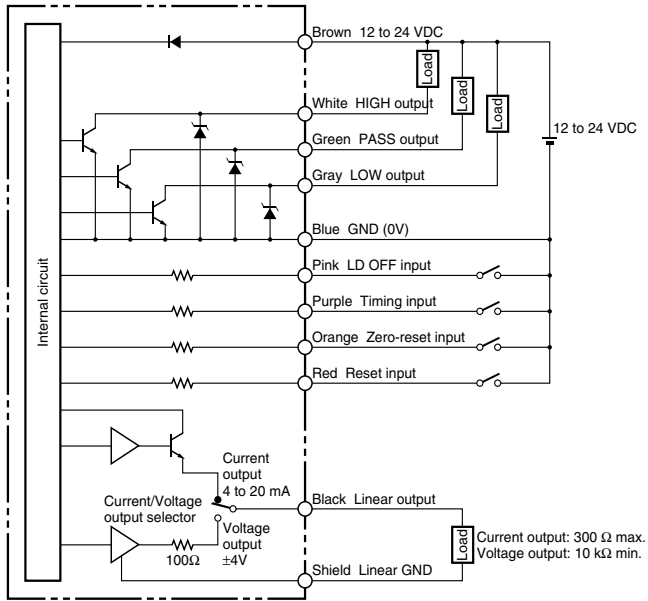

PNP type: ZX-LDA41

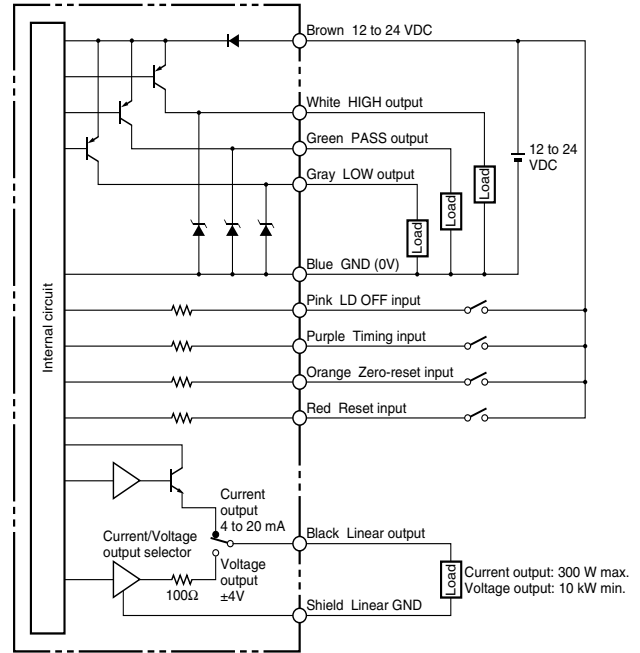

Connection

Amplifier Units

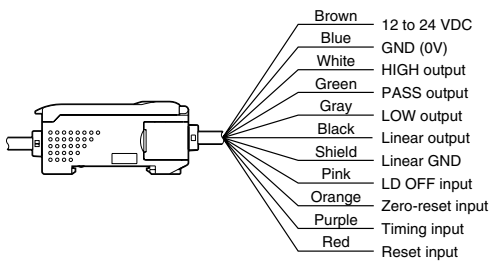

- Note: 1. In particular, when high resolution is necessary, provide a stable power source separate from other power systems.
 2. Damage may result if not wired correctly. (In particular, do not allow the linear output to contact other wires.)
 3. Green (0 V) is for the power supply. The outer covering of the shield wire (linear GND) is used for linear output along with the black wire (linear output). Even if you will not be using the linear output, connect the linear GND to GND (0 V).

Nomenclature:

Sensor head (reflection type)

- ZX-LD40
- ZX-LD100
- ZX-LD300
- ZX-LD40L
- ZX-LD100L
- ZX-LD300L
- ZX-LD30V
- ZX-LD30VL

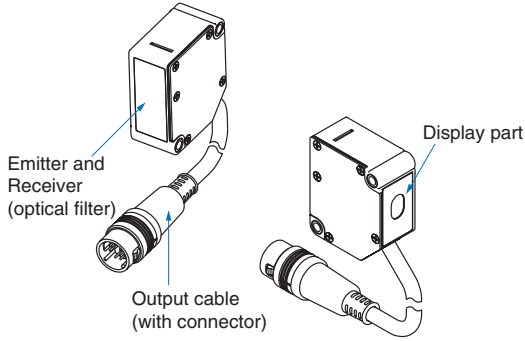

Sensor head (transmissive type)

- ZX-LT001
- ZX-LT005
- ZX-LT010

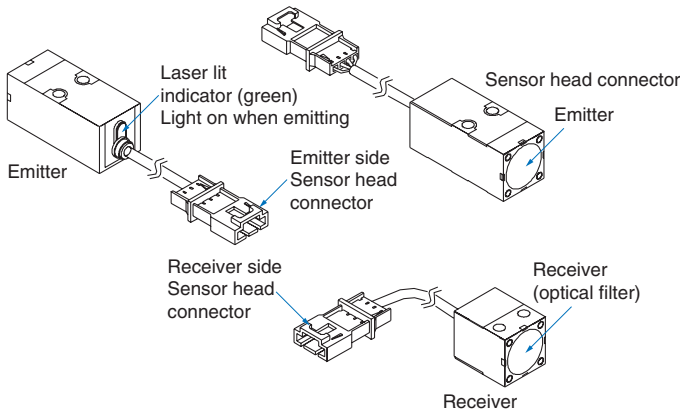

Communication interface

- ZX-SF 11

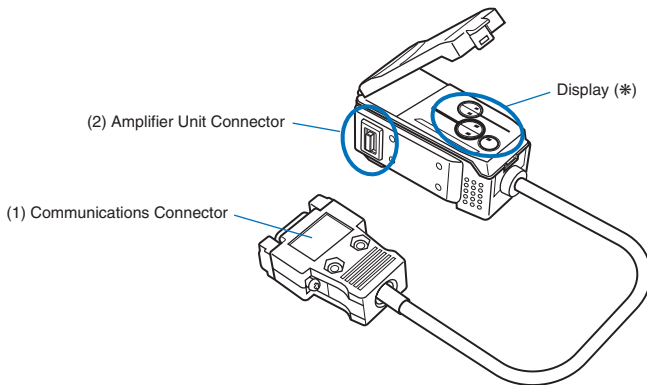

Amplifier Units

- ZX-LDA11
- ZX-LDA41

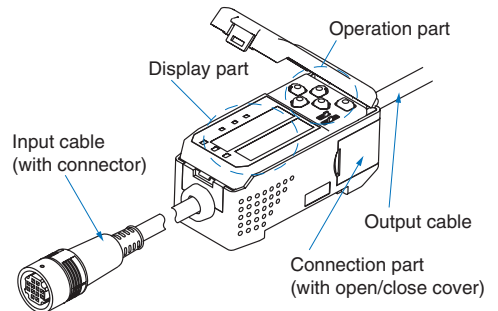

Computing unit

- ZX-CAL-2

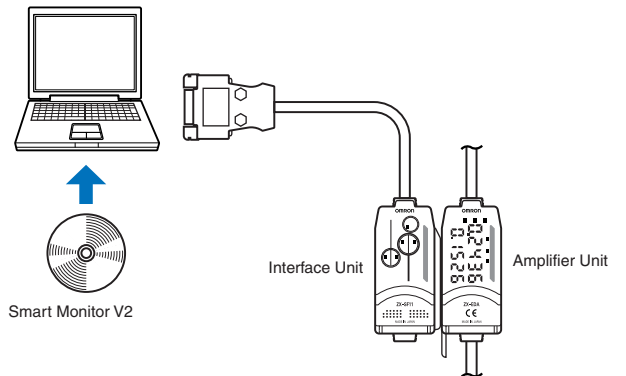
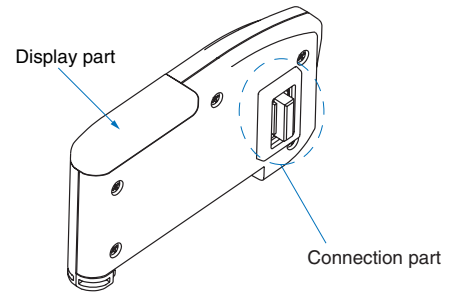

ZX-L

Precautions



Warning

Laser safety

Safety measures are required for laser devices both in Japan and abroad. Brief explanations of three cases are given below, including use in Japan and assembling in Japan and then exporting to other countries.



Europe

The ZX-L-Series Sensor Heads are Class 1 and Class 2 Laser Products according to EN 60825-1 (IEC825-1).
(The outline is given in the following table.)

Summary of user precautions

Requirements subclause	Classification						
	Class 1	Class 1M	Class 2	Class 2M	Class 3R	Class 3B	Class 4
Laser safety iffucer 10.1	Not required but recommended for applications that involve direct viewing of the laser beam				Not required for visible emission Required for non-visible emission	Required	
Remote interlock 10.2	Not required					Connect to room or door circuits	
Key control 10.3	Not required					Remove key when not in use	
Beam attenuator	Not required					When in use prevents inadvertent exposure	
Emission indicator device	Not required				Indicates laser is energized for nonvisible wavelengths	Indicates laser is energized	
Warning signs 10.5	Not required					Follow precautions on warning signs	
Beam path 10.6	Not required	Class 1M *1 as for Class 3B	Not required	Class 2M *2 as for Class 3B	Terminate beam at end of useful length		
Specular reflection 10.7	No requirements	Class 1M *1 as for Class 3B	No requirements	Class 2M *2 as for Class 3B	Prevent unintentional reflections		
Eye protection 10.8	No requirements					Required if engineering and administrative procedures not practicable and MPE exceeded	
Protective clothing 10.9	No requirements					Sometimes required	Specific requirements
Training 10.10	No requirements	Class 1M *1 as for Class 3R	No requirements	Class 2M *2 as for Class 3R	Required for all operator and maintenance personnel		

*1. Class 1M laser products that failed condition 1 of table 10. Not required for Class 1M laser products that failed condition 2 of table 10.

*2. Class 2M laser products that failed condition of table 10. Not required for Class 2M laser products that failed condition 2 of table 10.

Note: This table is intended to provide a convenient summary of precautions. See text of this standard for complete precautions.

ZX-LD□□□/ZX-LD30V□

Classification of reflective-type sensor heads

Class 2

Classification of reflective-type sensor head of ZX-LT□□□

Class 1

Laser-related labeling

The warning label at right is attached to the side of the sensor head.

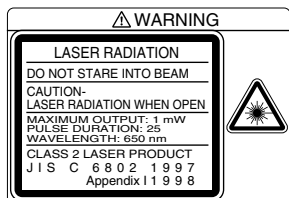

Handling Instructions

The ZX-LD□□□/ZX-LD30V□ emits visible laser light. Do not look directly at the light. Terminate the light path of the laser beam before use. If a reflective mirror surface is in the light path, ensure that the reflected light path is enclosed in the beam. In cases where the light path must be open, ensure that it is kept away from eye-height.

(U.S.A.)

Exports of products equipped with this device to the U.S.A. are governed by the laser standards of the Food and Drug Administration of the U.S.A.

The ZX-L-Series Laser Series is classified as Class I and Class II device according to FDA (21 CFR1040.10).

Please inquire for detailed information on exporting to the U.S.A..

(Countries other than the U.S.A.)

- ZX-LD□□/ZX-LD30V@ reflective-type (displacement) sensor head: In countries other than Japan and the U.S.A., replace the warning label with the provided English label.
- For the ZX-LT□□□ transmissive-type (displacement) sensor head, the warning label already includes English, thus replacement is not necessary.
- With respect to exports to Europe, a different standard exists, Europe EN60825.

Correct Use

Design

Object

Some object materials and forms may not permit measurement, or may reduce the accuracy of measurement (transparent materials or materials with an extremely low reflectance; steeply inclined objects, etc.).

Power Supply and Wiring

- Do not connect or disconnect the connector while powered. Damage may result.
- Allow the system to warm up for about 10 minutes after turning on the power.
- Upon completed wiring, verify that the power source is wired correctly, that there are no incorrect connections that will cause load shorts, and that the load current is appropriate before turning on the power. Incorrect wiring may result in damage.
- When extending the cable, ensure that the overall length does not exceed 10 m from both the sensor head and the amplifier unit. If you need to extend the cable from the sensor head, use the optional extension cable (ZX-XC□A). For wiring from the amplifier unit, use the same type of shielded cable.
- If the power line is subject to surges, connect a surge protector.
- If you are using a computing unit, connect the linear GND terminals of the amplifier units.

Compatibility

The sensor head and amplifier unit are compatible. A sensor head purchased later can also be used.

Mutual Interference

This sensor head allows the amplifier units to be used in conjunction by connecting a computing unit (ZX-CAL) between the amplifier units.

Cleaning

Do not use thinner, benzene, acetone, or kerosene, or similar chemicals.

Dimensions (Unit: mm)

Sensors

Sensor head (diffuse reflection type)

- ZX-LD40
- ZX-LD100
- ZX-LD300
- ZX-LD40L
- ZX-LD100L
- ZX-LD300L

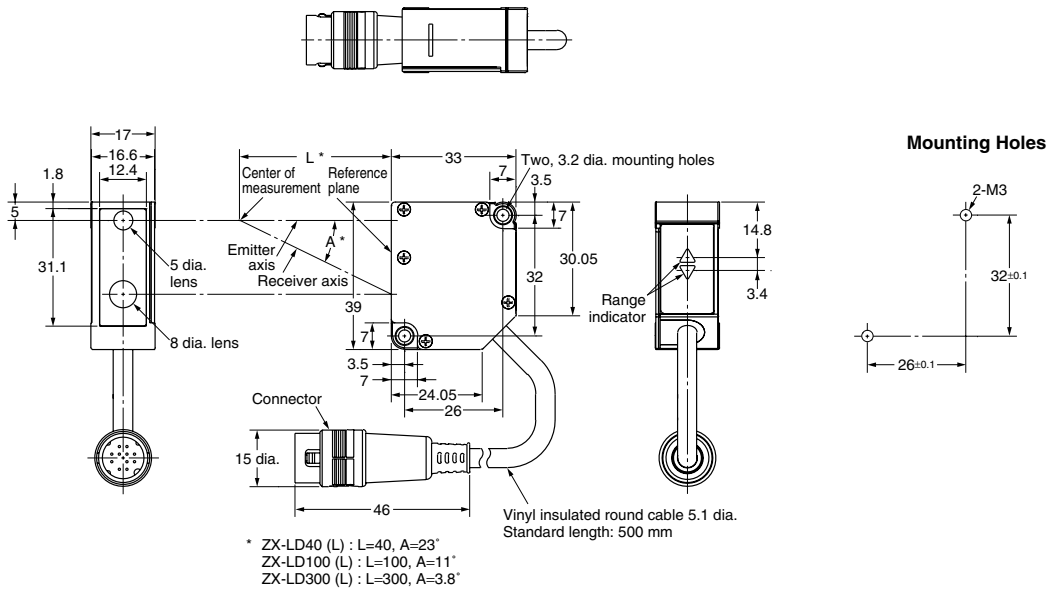

Sensor head (regular reflection type)

- ZX-LD30V
- ZX-LD30VL

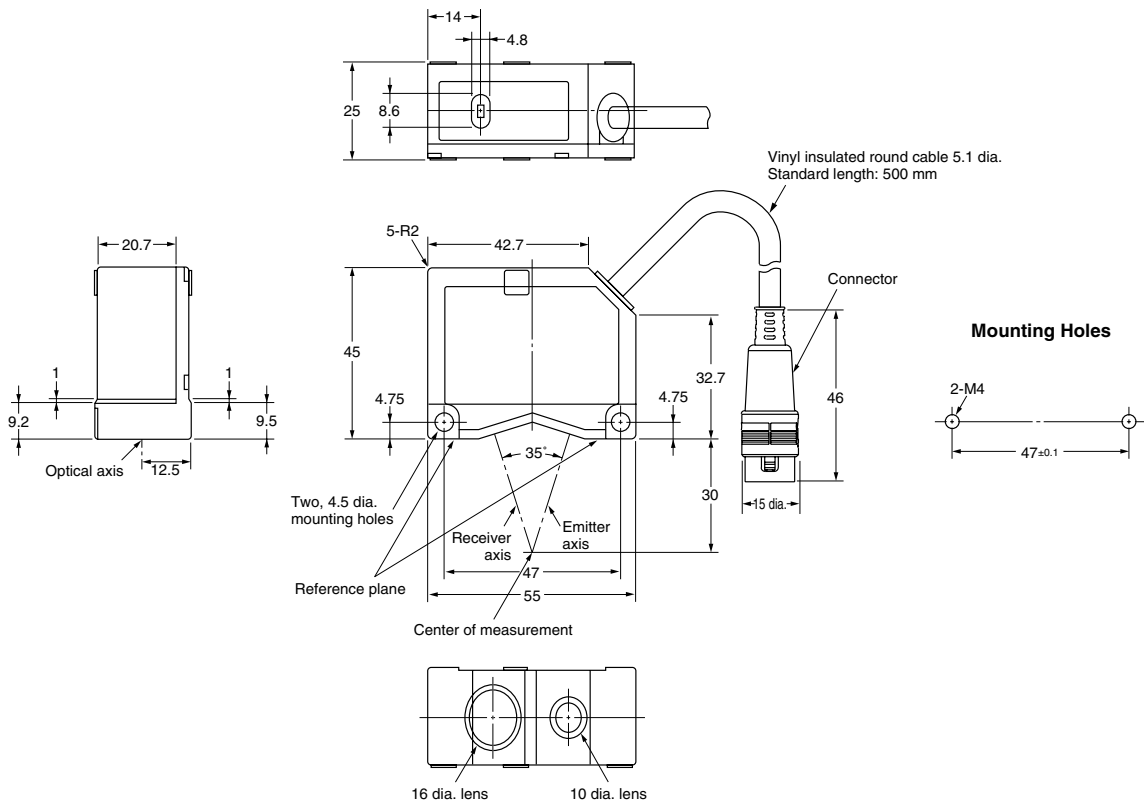

Sensor head (transmissive type)

ZX-LT001
ZX-LT005

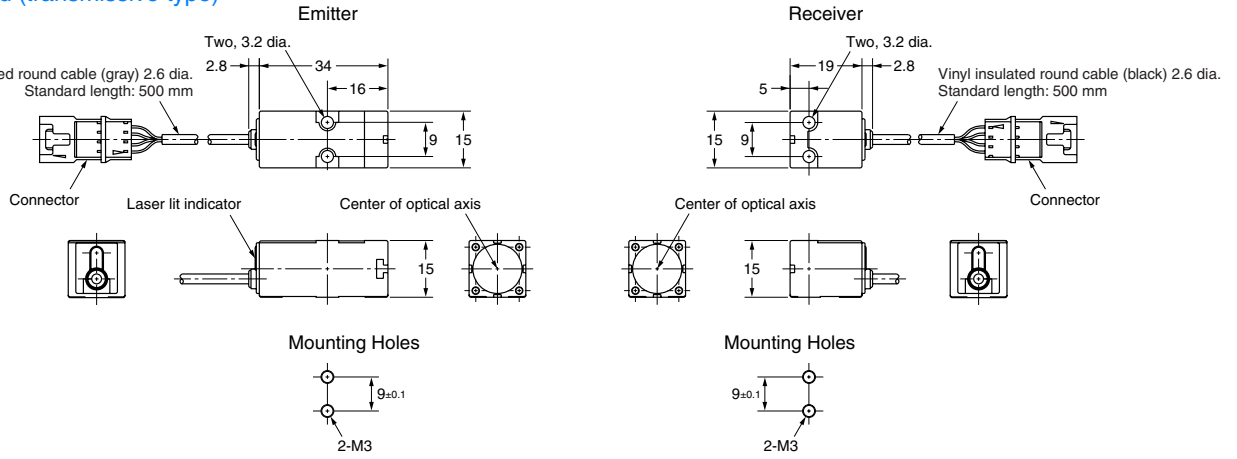

Sensor head (transmissive type)

ZX-LT010

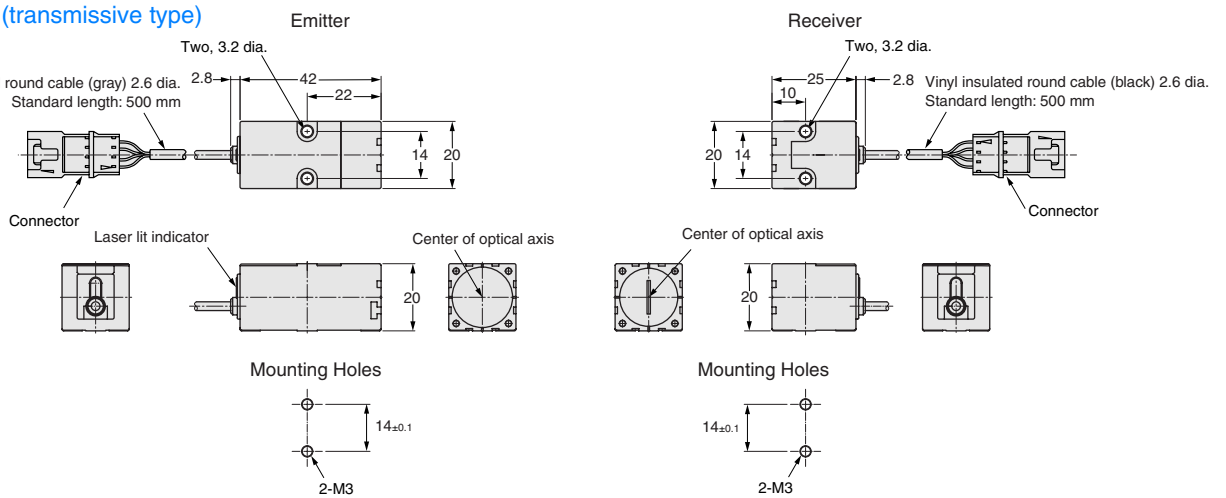

Amplifier Units

ZX-LDA11
ZX-LDA41

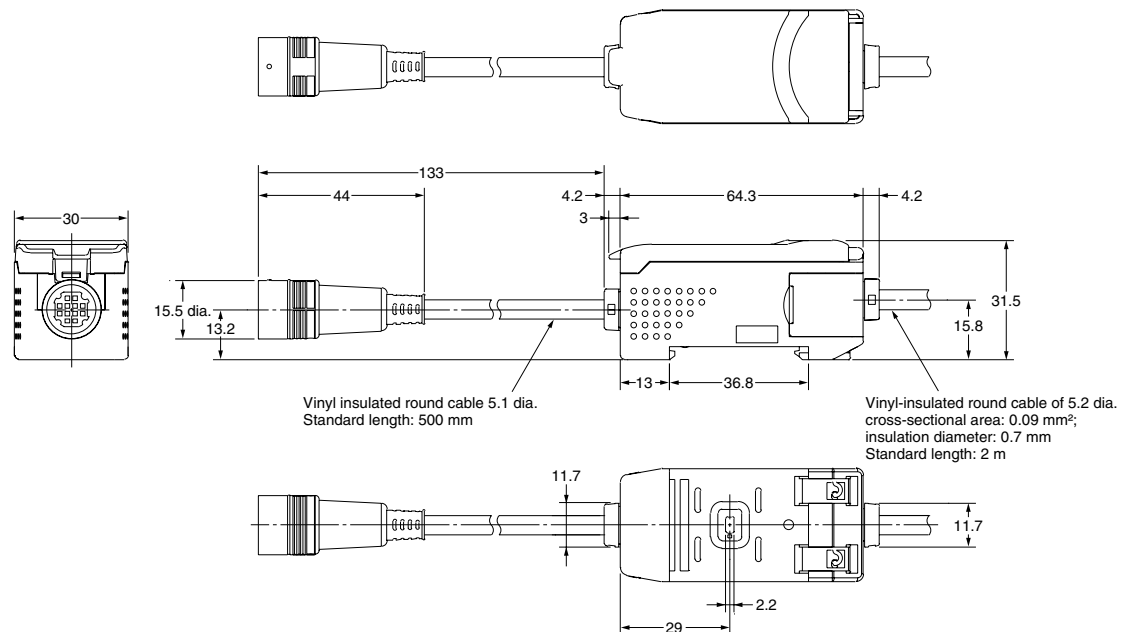

Sensor heads

ZX-LT030

Emitter

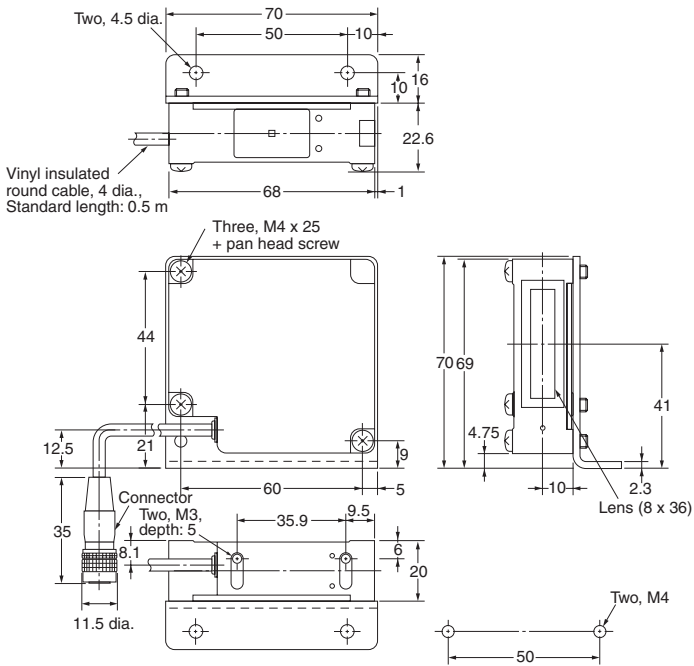

Receiver

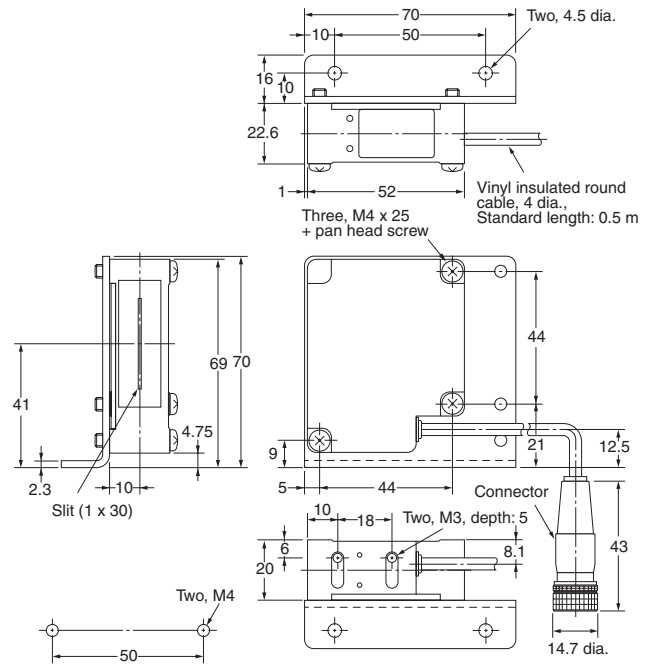

■ Sensor Head - Amplifier Connection Cable

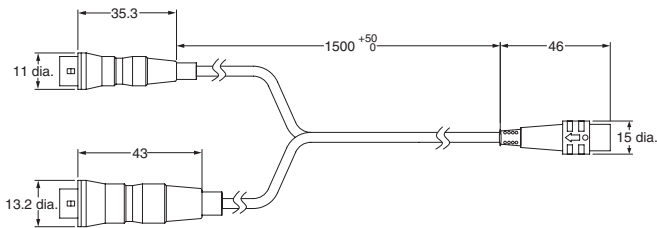

Accessories (Order Separately)

Computing unit
ZX-CAL2

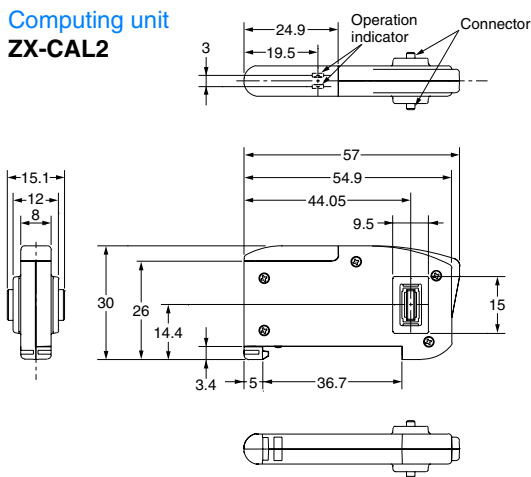

Side view attachment
ZX-XF12

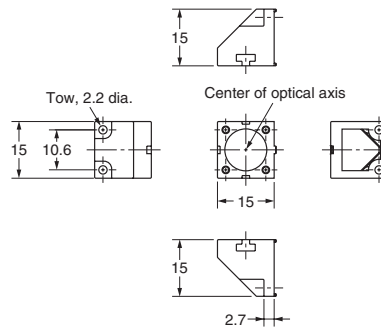

Side view attachment
ZX-XF22

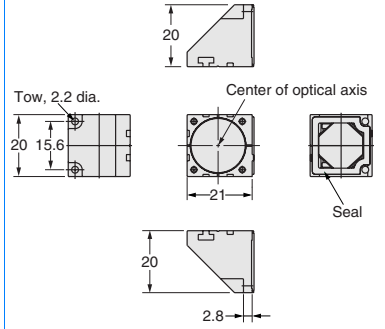

Communication interface unit for ZX
ZX-SF11

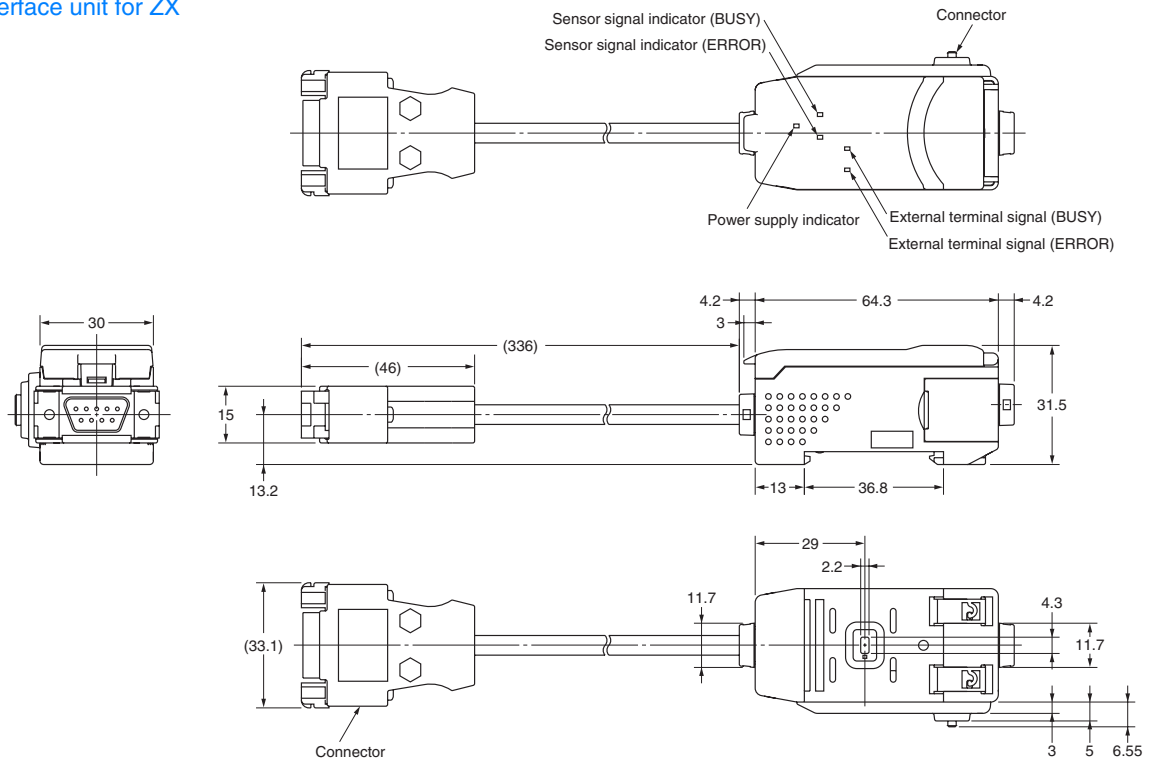

Two-sided connector cable
(for extension)

- ZX-XC1A (1 m)**
- ZX-XC4A (4 m)**
- ZX-XC8A (8 m)**
- ZX-XC9A (9 m)**

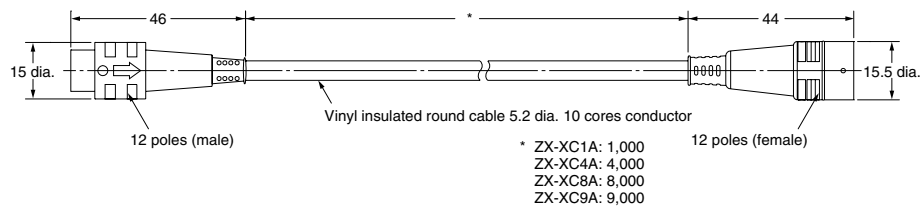

ALL DIMENSIONS SHOWN ARE IN MILLIMETERS.

To convert millimeters into inches, multiply by 0.03937. To convert grams into ounces, multiply by 0.03527.