

Smart Sensor
ZFX

Vision Sensor with built-in touch screen

SHORT MANUAL

OMRON

ZFX
Vision Sensor
with built-in touch screen

Short Manual

Ver. 1.0, January 2008

TABLE OF CONTENTS

SECTION 1

Preparation	5
1-1 System Overview	5
1-2 Connecting the Devices	6
1-3 Installing the Controller	8
1-4 Installing the Intelligent Cameras	10
1-5 Installing the C-mount Cameras	12
1-6 Installing the External Lightings (Only For ZFX-SC50/SC90)	14
1-7 Installing the External Lightings (Only For C-mount Camera (ZFX-S/SC))	15

SECTION 2

Main Operation	17
2-1 Operation Mode	17
2-2 Adjusting the brightness of image	18
2-3 Measurement Setting Example (Pattern Search)	20
2-4 Position Correction	22
2-5 Getting the clear image	24
2-6 Changing the Display Information (ADJ/RUN Mode)	30
2-7 Re-measuring the saved image (ADJ Mode)	31

SECTION 3

Run-Mode Measurement Process	33
---	-----------

SECTION 4

Item Overview	41
4-1 ITEM Overview (Pattern Search)	41
4-2 ITEM Overview (Sensitive Search)	43
4-3 ITEM Overview (Flexible Search)	44
4-4 ITEM Overview (Graphic Search)	45
4-5 ITEM overview (Area)	46
4-6 ITEM Overview (Labeling)	47
4-7 ITEM Overview (Position)	49
4-8 ITEM Overview (Width)	51
4-9 ITEM Overview (Count)	52
4-10 ITEM Overview (Angle)	53
4-11 ITEM Overview (Bright)	54
4-12 ITEM Overview (HUE)	55
4-13 ITEM Overview (Defect)	56
4-14 ITEM Overview (Grouping)	58

SECTION 5

Appendices. 59

5-1 What is decided by AUTO setting. 59

5-2 BANK and BANK-Group 60

Revision History 62

SECTION 1 Preparation

1-1 System Overview

Basically, the ZFX-C is configured by the Controller and the camera.

Other external devices can be selected to be used in combination with the ZFX-C according to the user's specific requirements.

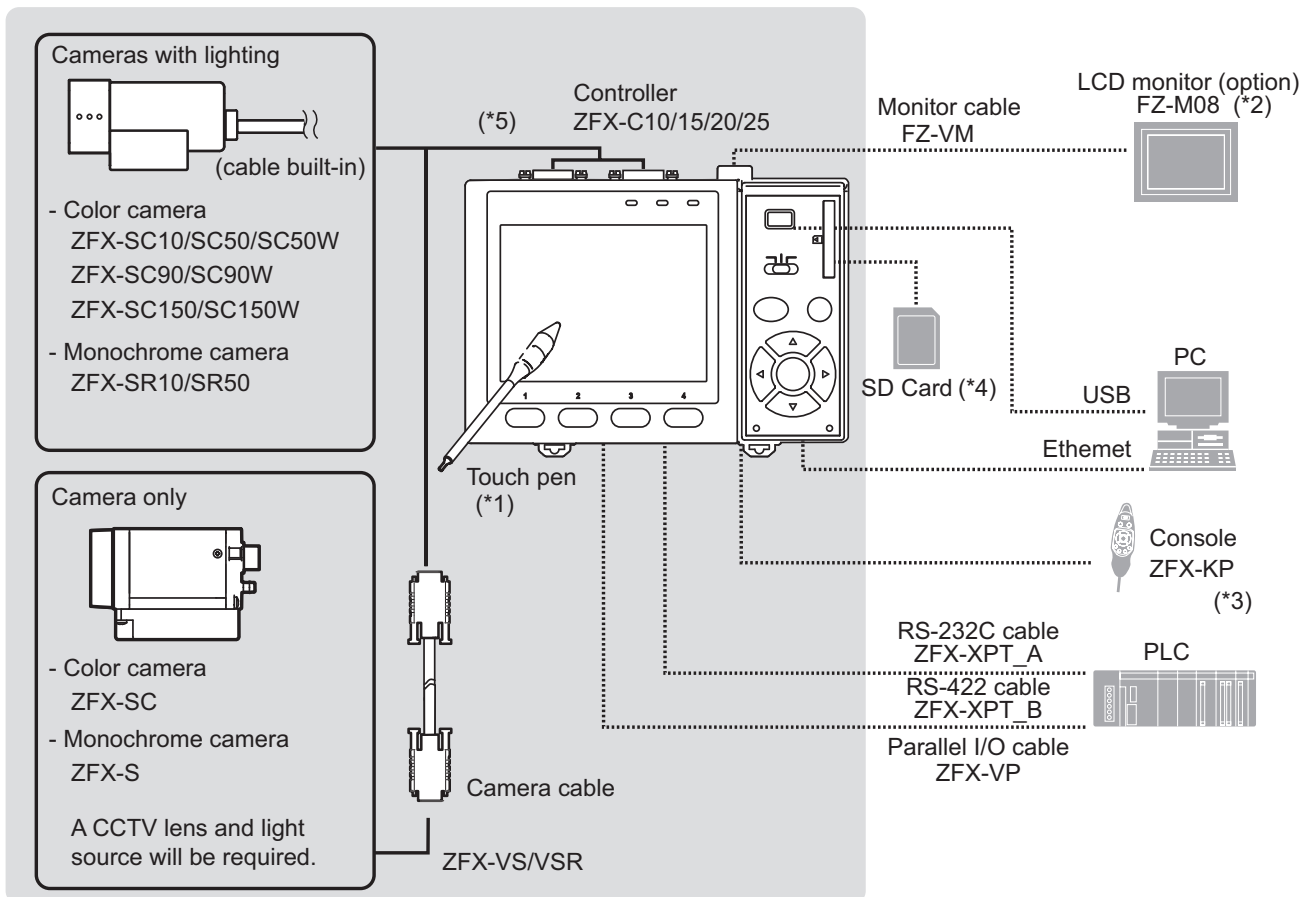

*1. The Touch Pen (ZFX-TP) is supplied with the Controller.

*2. The same image as in the Controller's LCD monitor can be displayed in the LCD monitor (option).

*3. The console can be used instead of the Controller's keys and menu buttons.

*4. Conforms to the SD Card "Physical layer specifications 1.01."
File format: FAT16

*5. ZFX-C20/25b can be connected with 2 cameras.

1-2 Connecting the Devices

1-2-1 Connecting the Controller to the Power Supply

Use a power supply that meets the following specifications.

Item	Specification
Power supply voltage	Approx. 24 VDC (21.6 to 26.4 VDC)
Output current	1.5 A min.
Recommended power supply	S8VS-06024 (24 VDC, 2.5 A)
Recommended electric wire size	0.14 to 1.5 mm ² (max. 1 m)

Important

Use a DC power supply with countermeasures against high voltages (safe extra low-voltage circuits on the secondary side). If the system must meet UL standards, use a UL class II power supply.

- Loosen the two screws on the top of the Power connector (male) using a flat-blade screwdriver.
- Insert the DC power terminal (wire) into the Power connector (male) and tighten the two screws on the top of the Power connector to fasten the power terminal with the screwdriver. Tightening torque: 0.22 to 0.25 Nm.
- Plug the Power connector (male) into the Controller's Power connector (female).
- Tighten the two screws on the left and right of the Power connector (male) with the screwdriver to fasten it. Tightening torque: 0.22 to 0.25 Nm.

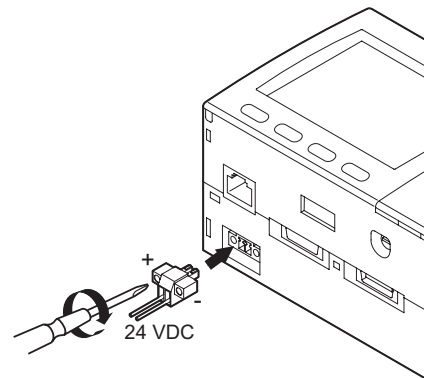

1-2-2 Attaching Ferrite Cores

Attach ferrite cores (supplied) to both ends of the camera's cable and the Controller's power cable, respectively.

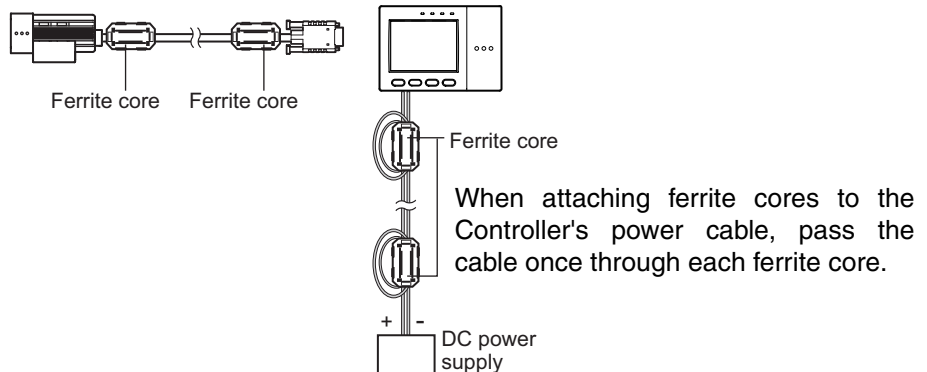

1-2-3 Connecting the Camera to the Controller

1. Insert the camera's connector into the Controller's Camera connector.
2. Tighten the two fastening screws of the Controller's Camera connector.
Tightening torque: 0.15 Nm.

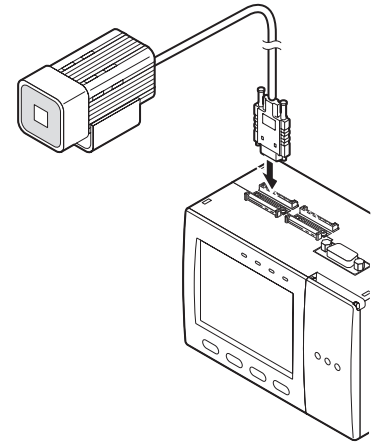

Important Do not touch the terminals inside the connector.

Important Fasten the connector while making sure that it is not subjected to vibration or shock.

Important Do not mount the Controller in such a way that a load is steadily applied on the connector, for example, with tension applied to the cables.

Disconnection procedure

Loosen the fastening screws (two locations) to unlock the camera's cable, and then pull the camera's cable connector straight out.

Important Be sure to hold the connector of the camera to disconnect it. Failure to do so may damage the camera's cable.

Important Do not touch the terminals inside the connector.

1-3 Installing the Controller

1-3-1 Installation Precautions

To improve heat radiation, install the Controller only in the orientation show below.

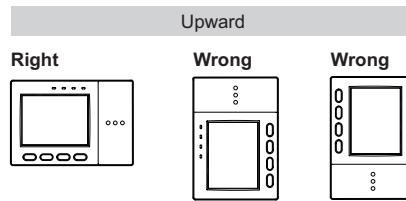

Important Install the Controller so that the distance between the Controller and other devices is at least the dimensions shown in the figure below to improve the ventilation.

When installing Controller only:

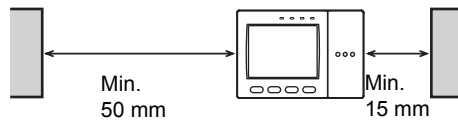

When installing the Controller With the Exhaust Unit attached:

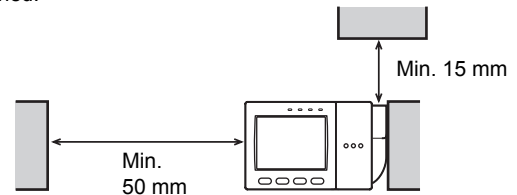

Important Keep the ambient temperature less than 50 °C. If the ambient temperature is higher than 50 °C, install a fan forced cooling system or an air conditioner to keep the temperature lower than 50 °C.

Important Avoid mounting on a panel, in which high-voltage emitting devices are installed to prevent ZFX-C operation from being affected by noise.

Important Allow at least 10 m between the Controller and power lines to keep noise at a low level in the operating environment.

1-3-2 Installing on the DIN Track

1. Hook the Controller's upper hook onto the DIN track.
2. Push the Controller down onto the DIN track until its lower hook is snapped into place.

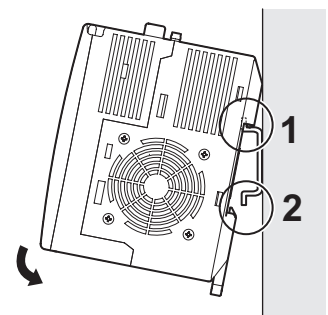

Important Attach the End Plate (sold separately) to both sides of the Controller on the DIN track.

Important Attach the Exhaust Unit (supplied) to the Controller when installing other devices adjacently on the same DIN track as the Controller.

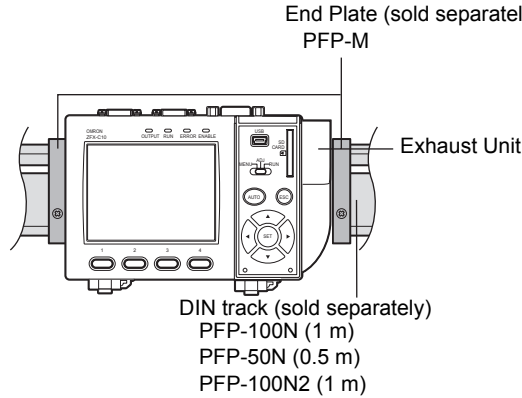

Removing procedure

1. Pull the Controller's lower hook downwards.
2. Lift up the Controller from its bottom to remove it from the DIN track.

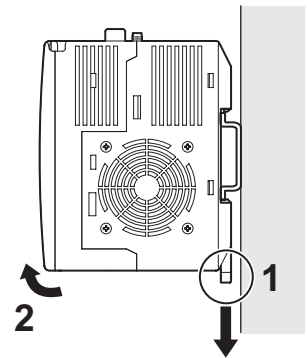

1-3-3 Mounting on the Panel

1. Install the long Panel Mount Adapters on the four holes on the Controller.
2. Install the short Panel Mount Adapters on the two holes on the long Panel Mount Adapter.
3. Install the Controller with Mount Adapters attached onto the panel from the front.

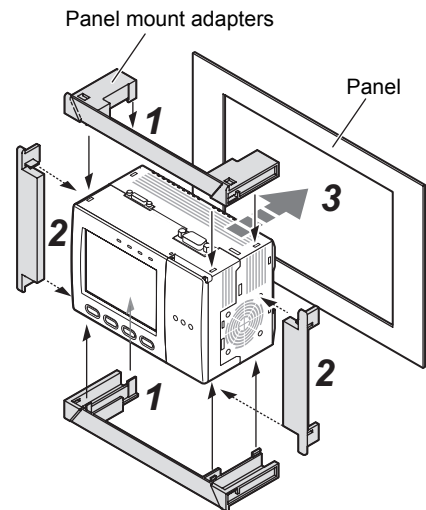

4. Hook the hooks of the mounting bracket onto the two holes (two each at top and bottom) of the longer Mount Adapters and tighten the screws.
Tightening torque: 1.2 N•m.
5. Make sure that the Controller is firmly fixed on the panel.

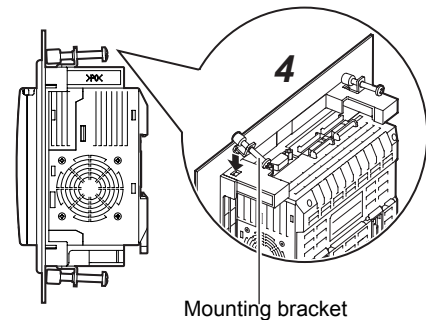

1-4 Installing the Intelligent Cameras

1-4-1 Optical chart

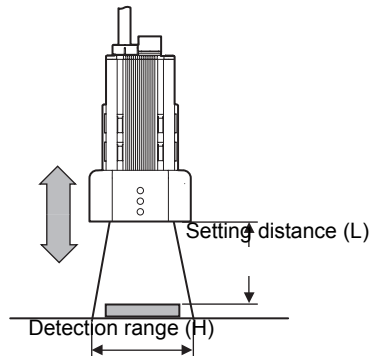

► ZFX-SC10/SR10

Setting distance L (mm)

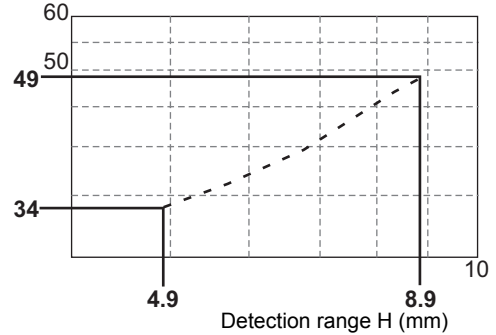

► ZFX-SR50

Setting distance L (mm)

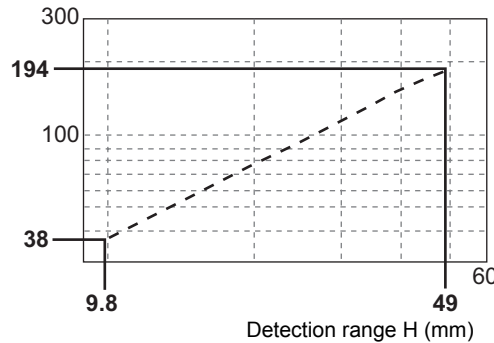

► ZFX-SC50/SC50W

Setting distance L (mm)

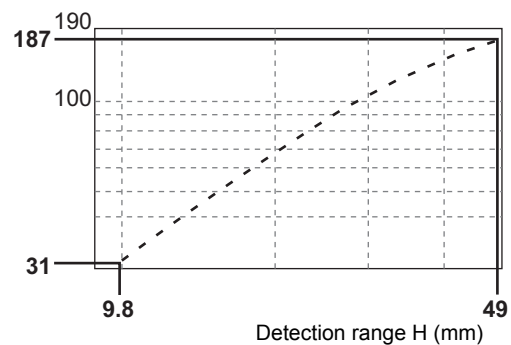

► ZFX-SC90/SC90W

Setting distance L (mm)

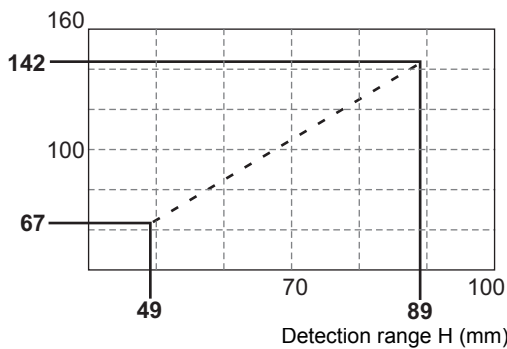

► ZFX-SC150/SC150W

Setting distance L (mm)

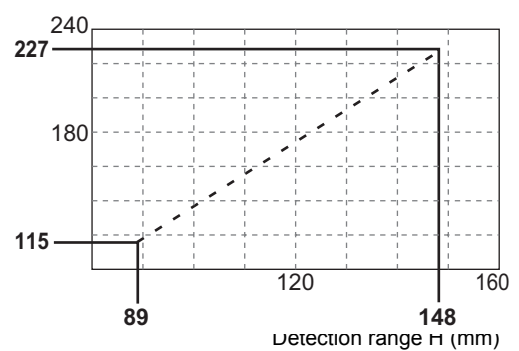

- Note**
- The lens has a fixed focal point. The actual detection range and focal point vary from lens to lens, so adjust the distance to the measurement target after replacing the lens or camera.
 - The camera mounting distance listed in the following tables is an approximate value. Mount the Camera so that the distance to the measurement target can be adjusted easily.
 - If the object size and detection range are incompatible, use a combination of a camera (without lighting), standard CCTV lens and light source.

1-4-2 Installing the mounting fixture

The mounting fixture can be installed on all of the four mounting surfaces.

1. Align the two hooks on one side of the mounting fixture with the two grooves on the camera body.
2. Push the other hook down until it is snapped into place.
Make sure that the mounting fixture is firmly fixed on the camera.
3. Fasten the mounting fixture at the mounting location with screws.
Tightening torque
M4: 1.2 Nm
1/4"-20 UNC: 2.6 Nm

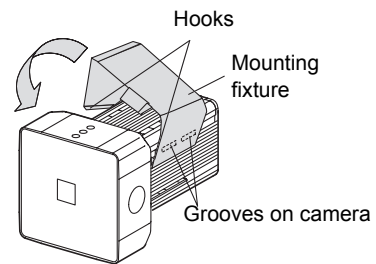

Removal procedure

1. Insert a screwdriver into the gap (one of the two gaps) between the mounting fixture and the camera case, and remove the mounting fixture.

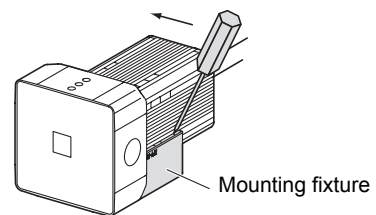

1-4-3 Adjusting the camera focus

1. Adjust the distance between the camera and the measurement target and fasten the camera. Refer to the optical chart and set the camera in a position so that the area to be checked is within the detection area (LCD monitor).
 "Optical chart" p. 10.
2. Turn the focus adjustment control to the left and right to adjust the focus.

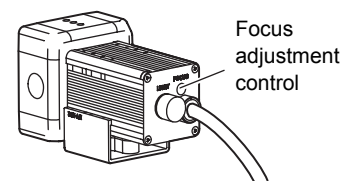
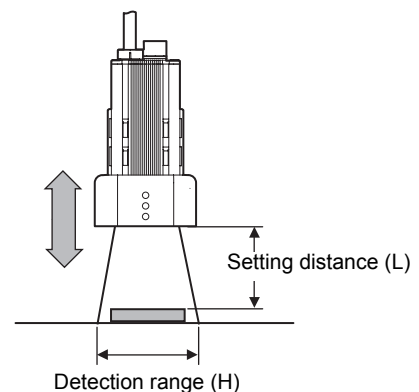

Note First turn the focus adjustment control slightly to the left and right, to make sure that the Focus adjustment control is not at the upper or lower limit positions. Do not exert unnecessary force to turn the control at the upper or lower limit positions as this might damage the control.
(For ZFX-SC90_/SC150_, the control stops turning at the nearest position. It turns free at the farthest position.)

1-5 Installing the C-mount Cameras

1-5-1 Optical chart

The values in the following chart are approximations, and the Camera must be adjusted after it is mounted.

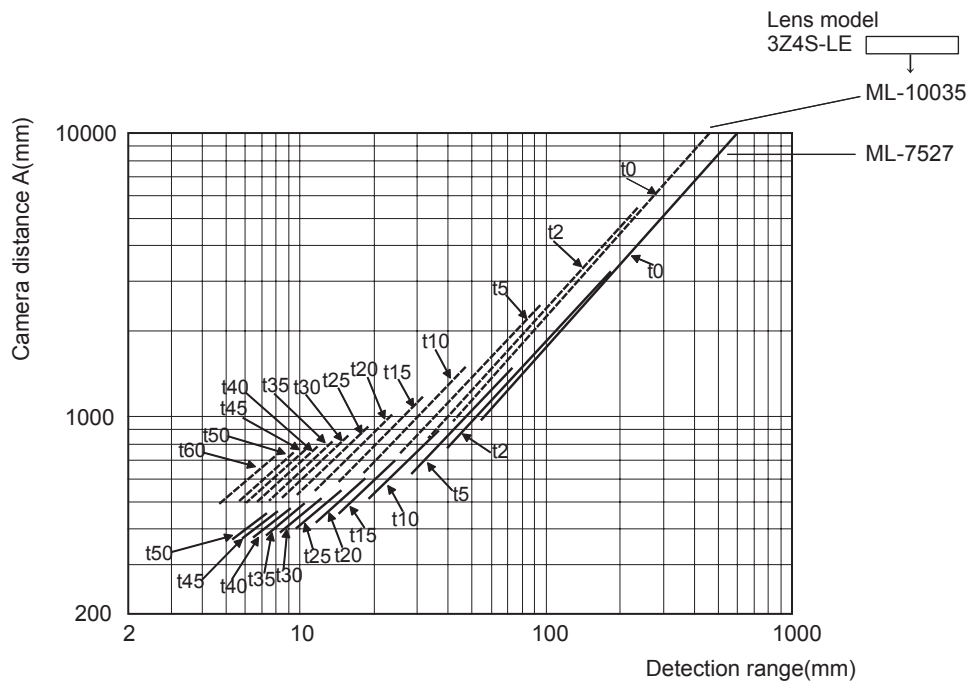
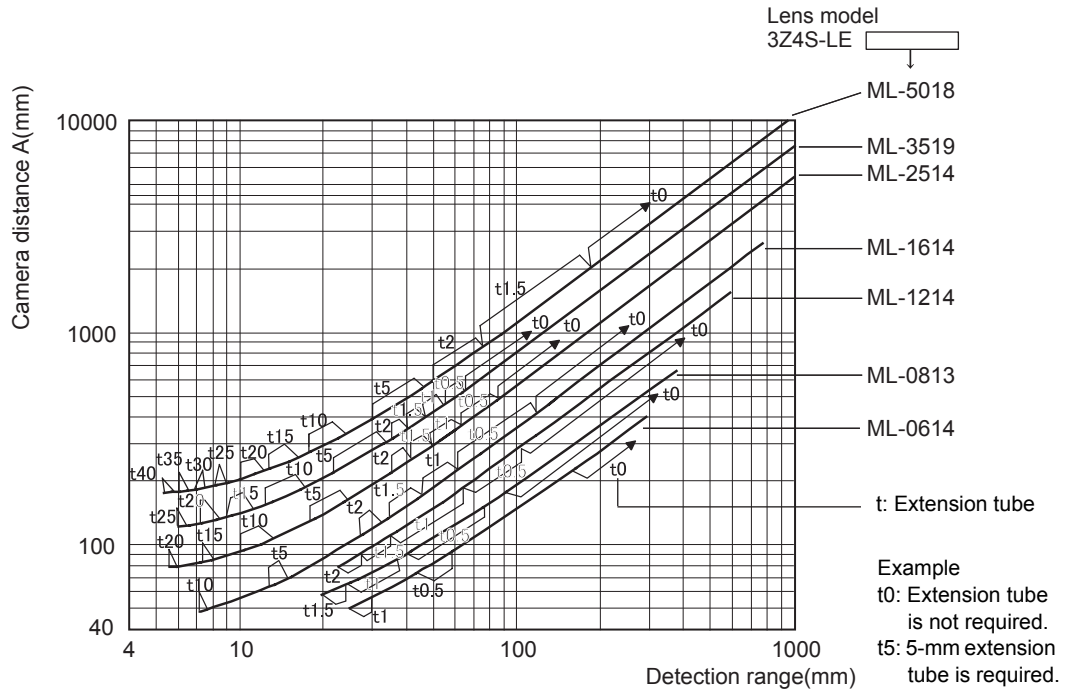

The X axis of the optical chart shows detection range L (mm), and the Y axis shows the camera distance A (mm). The curves on the optical chart show the relationship between the detection range and camera distance for each CCTV lens. The values are significantly different for each lens, so double-check the model of the lens before using the graph. The "t" values indicate the lengths of the Extension Tubes. The value "t0" shows the case where an Extension Tube

is not required and the value “t5.0” shows the case where a 5-mm Extension Tube is used.

Example

When a 3Z4S-LE ML-5018 CCTV Lens is being used and a detection range of 40 mm is required at the measurement target, a camera distance of 500 mm and 5-mm Extension Tube are required.

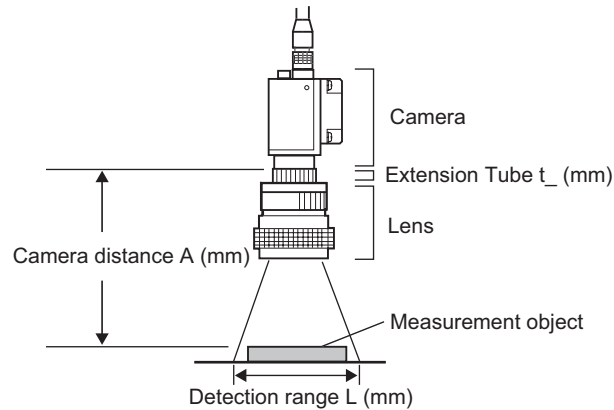

1-5-2 Installing the Camera Mounting Base

The camera mounting base mounted on the bottom of the camera can be installed on all of the four mounting surfaces. To change the mounting surface, remove the three mounting screws (M2 x 6) from the camera.

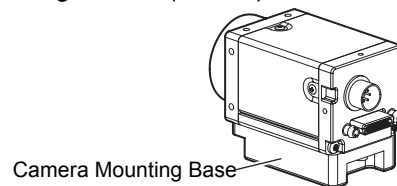

- Tightening torque when fastening the camera mounting base at the mounting location
M4: 1.2 Nm
1/4"-20 UNC: 2.6 Nm

1-6 Installing the External Lightings (Only For ZFX-SC50/SC90)

1-6-1 Connecting the Optional Lighting to the Camera

The optional lighting can be mounted to the rear connector of the camera (ZFX-SC50_/SC90_) with a single motion. Since the power is supplied from the camera side, no power supply is required for the optional lighting.

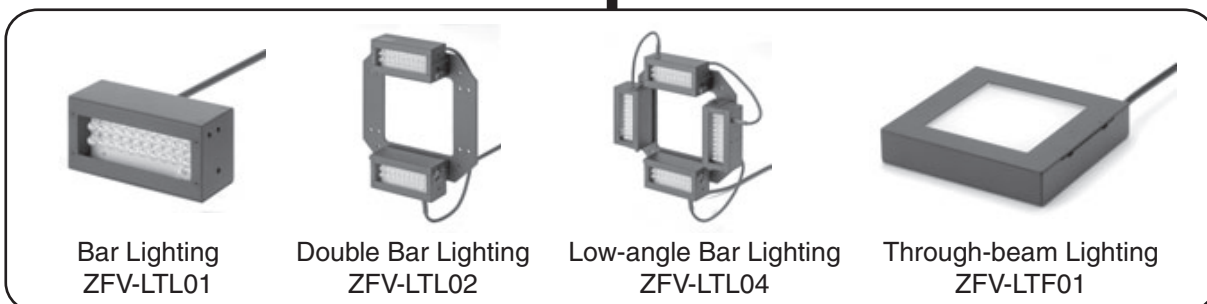
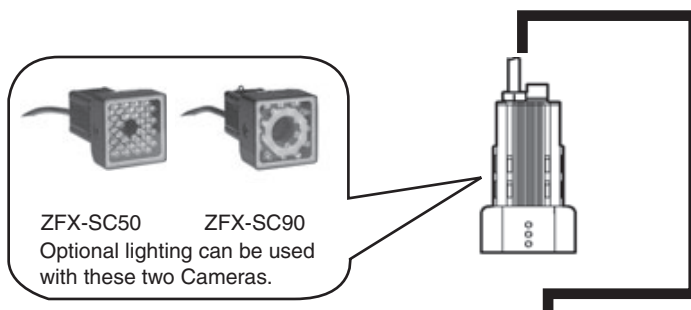
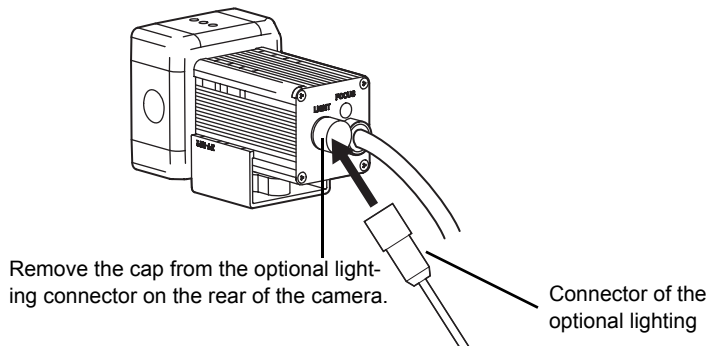

1-7 Installing the External Lightings (Only For C-mount Camera (ZFX-S/SC))

1-7-1 Connecting the Optional Lighting to the camera

The optional lighting can be connected to the Strobe Controller. And the Strobe Controller can be connected to the camera (ZFX-S/SC). No power supply is required for the optional lighting.

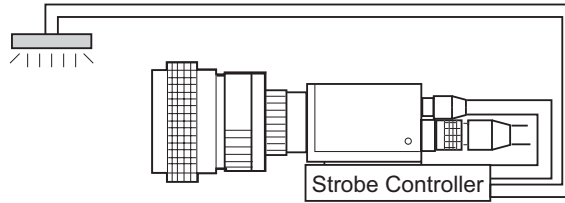

Strobe Controller

3Z4S-LT MLEK-C100E1TSX



External Lighting

3Z4S-LT Series

The lighting that current consumption is 1.0A or less can be connected

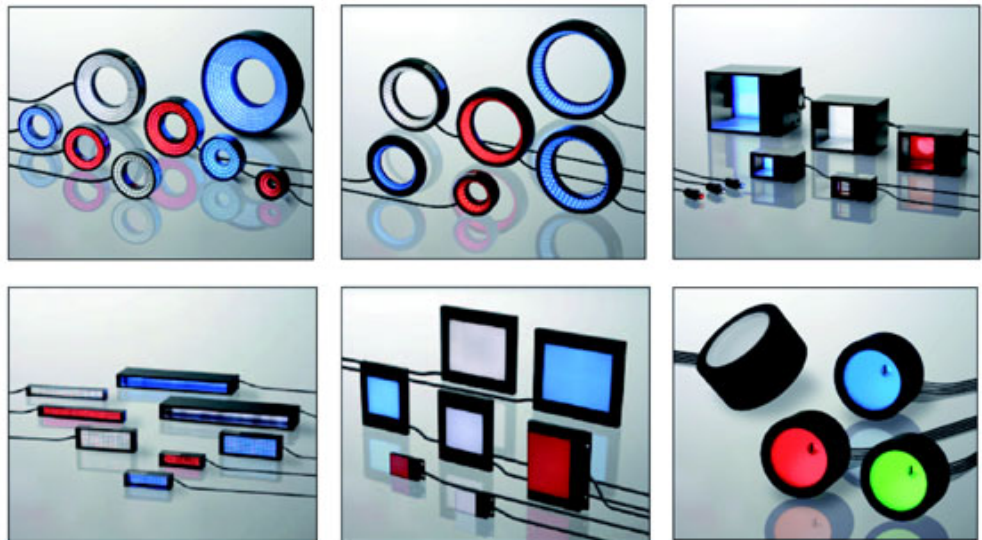

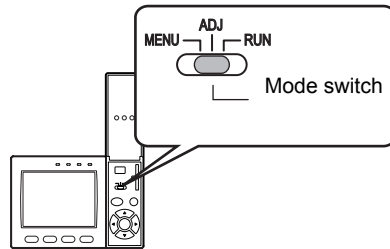

SECTION 2 Main Operation

2-1 Operation Mode

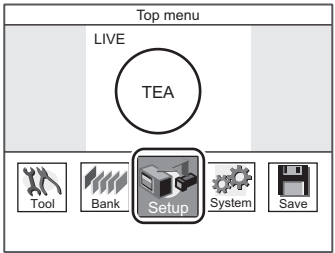

The ZFX-C has the following three modes. Switch to the desired mode before you start operation. To switch the operation mode, use the mode switch.

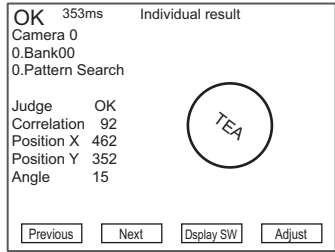
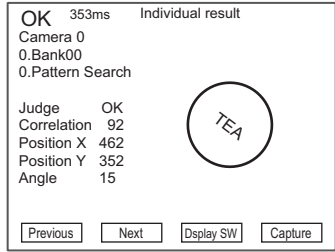
Mode	Description
<p>MENU mode</p> 	<p>This mode is for setting the measurement conditions. The easy-to-follow icon-based display allows operations to be performed intuitively.</p> <p style="text-align: center;">Top Screen</p> 
<p>ADJ mode</p> 	<p>This mode is for checking the measurement status and adjusting conditions. Measurement results are only displayed on the monitor and are not output.</p> <p>Important Trigger input isn't acceptable</p> <p style="text-align: center;">Top Screen</p> 
<p>RUN mode</p>	<p>This mode is used for performing actual measurement. Measurement results are displayed on the monitor and output.</p> <p>Important Measurement trigger by menu operation is to push [SET]-key & [UP]-key</p> <p style="text-align: center;">Top Screen</p> 

2-2 Adjusting the brightness of image

2-2-1 Lighting Intensity (Only the intelligent Cameras)

MENU mode - [Setup] - [Cameras] - [Light Control]

Light Control

How blocks are displayed

Top surface (surface printed with model No.)

View from this side

1. Push "Auto"

The thumbnails of images automatically captured under different illumination patterns are displayed

2. Select the image

3. Push "Apply"

The lighting condition of the selected image is displayed

4. Fine-adjust these conditions as required.

Amount of emitted light

Important

If the workpiece is glossy, install the camera at an angle to prevent mirror reflection light from being picked up by the camera.

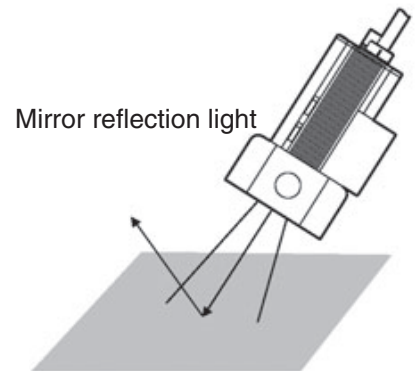

2-2-2 Shutter Speed

Set the shutter speed to match the speed of movement of the measurement target and the lighting environment.

MENU mode - [Setup] - [Cameras] - [Shutter Speed]

Setting value	Description
1/170 to 1/20000 s	Fixes the shutter speed to the desired value. Only available candidate shutter speeds are displayed. The candidates differ with the camera that is connected and setup conditions.

Note Guidelines for setting shutter speed
Shutter speed characteristics are as follows. Select the appropriate shutter speed to suit your inspection requirements.

Shutter Speed	Speed of Movement of Measurement Target
1/170 s	Slow
•	•
1/20000 s	Fast

2-2-3 Gain Setting

The sensor's gain (sensitivity) can be adjusted if bright images cannot be obtained just by the Shutter Speed and Light Control settings.

MENU mode - [Setup] - [Cameras] - [Gain]

Setting value	Description
x 1.0, x 1.5, x 2.0	Sets the gain factor. x 1.0: The gain factor is not changed. (default value) x 1.5: The gain factor is set to 1.5X. x 2.0: The gain factor is set to 2.0X.

Note Guidelines for setting gain
Increasing the gains results in a brighter image, however, the noise component contained in the image also becomes more conspicuous. Select the appropriate gain factor to suit your inspection requirements.

Gain	Image	Image Quality
x 1.0	Dark	Good (little noise)
•	↑ ↓	↑ ↓
x 2.0	Bright	Coarse (conspicuous noise)

2-3 Measurement Setting Example (Pattern Search)

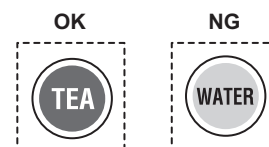
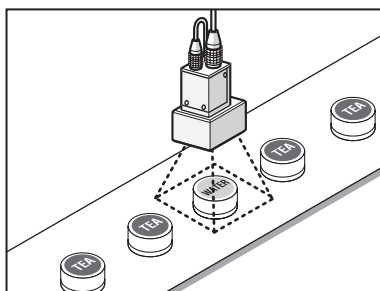

Select the item (Pattern Search)

1. Switch to the MENU mode.

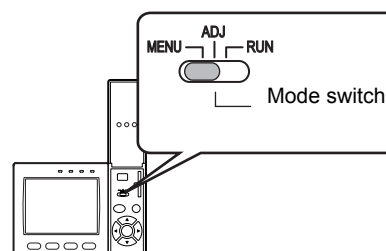

2. Select the [Setup] icon.

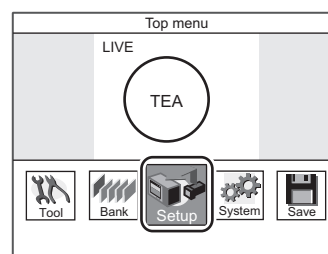

3. Select the measurement item icon.
(Pattern Search)

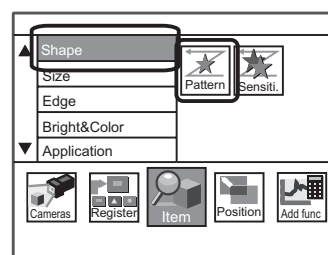

Register the image of non-defective product as a model image (standard for measurement)

4. Select the [Register model]

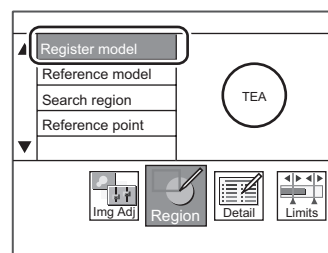

5. Select the shape of model region

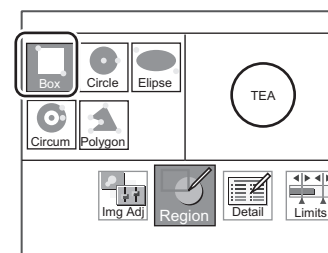

6. Enclose the model region
 - First, move the region
 - Next, select [Size] and change the region
 - Finally, select the [Apply]

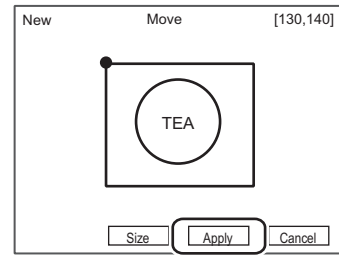

Set the parameter automatically

7. Select [AUTO] (key or icon on screen)
The best color filter is selected and model is registered.

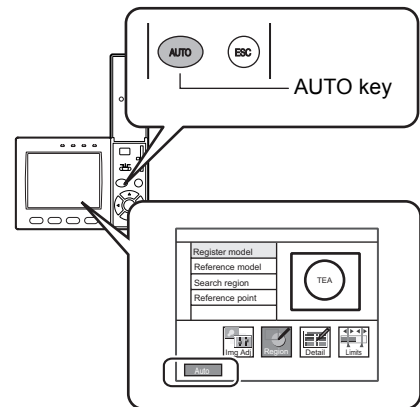

Check the measurement status by measuring some samples

8. Switch to ADJ-mode

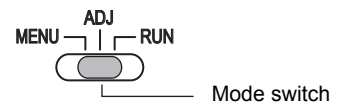

Key point

- If sample object is moved, is the measurement stable ?
- Is there the definite difference of correlation between OK sample and NG sample ?

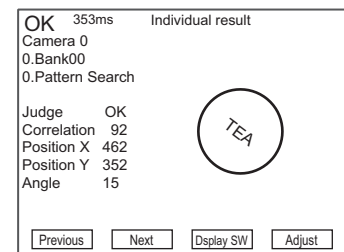

Change the limits (thresholds) of correlation, if needed.

9. Select the [Adjust]
10. Select the [Limits]
11. Change the limits.

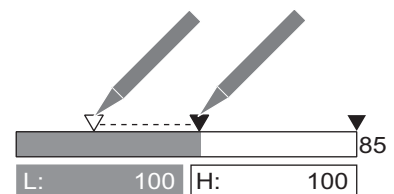
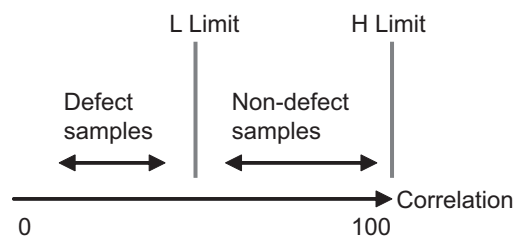
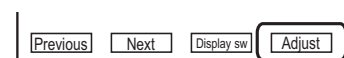

2-4 Position Correction

This function is used when the position or orientation of measurement target is no fixed. If you use this function, the amount of the shift from the reference position is calculated, and the position of the measurement region is corrected before measurement is performed.

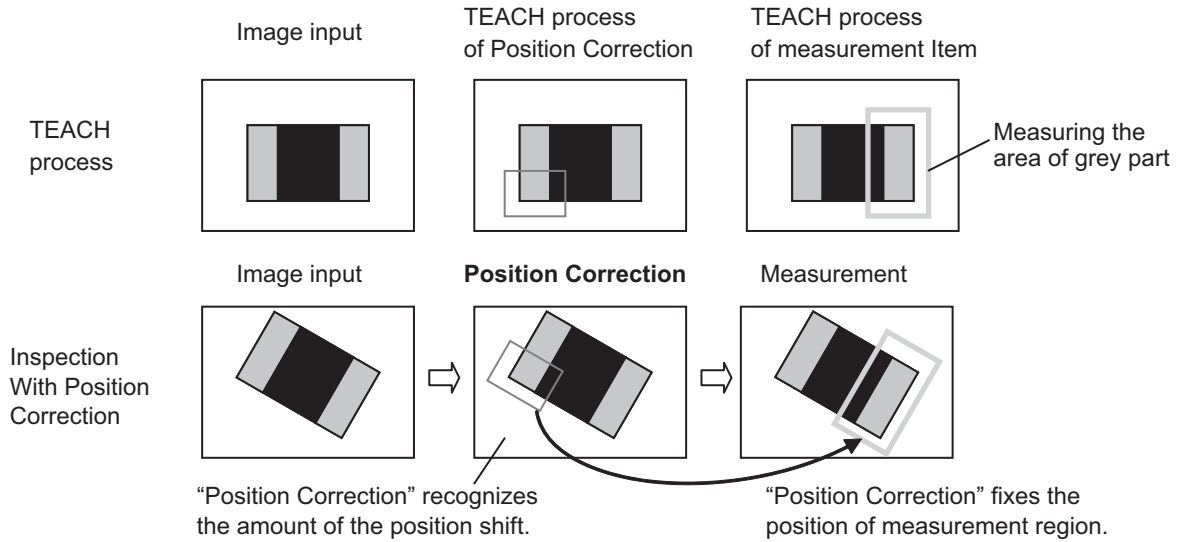

Important

Use a saved image, when setting the position correction.

If you use an image different from the one that was initially used for position correction, position correction might not be set correctly. Moreover, set the measurement items again, if you use a different image.

Recommended procedural

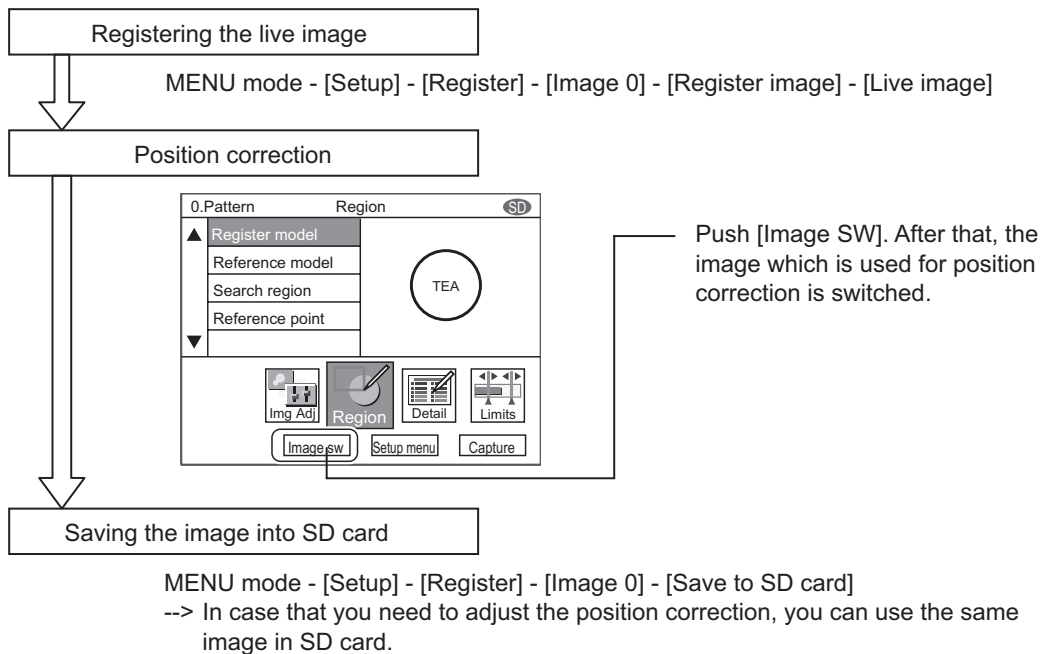

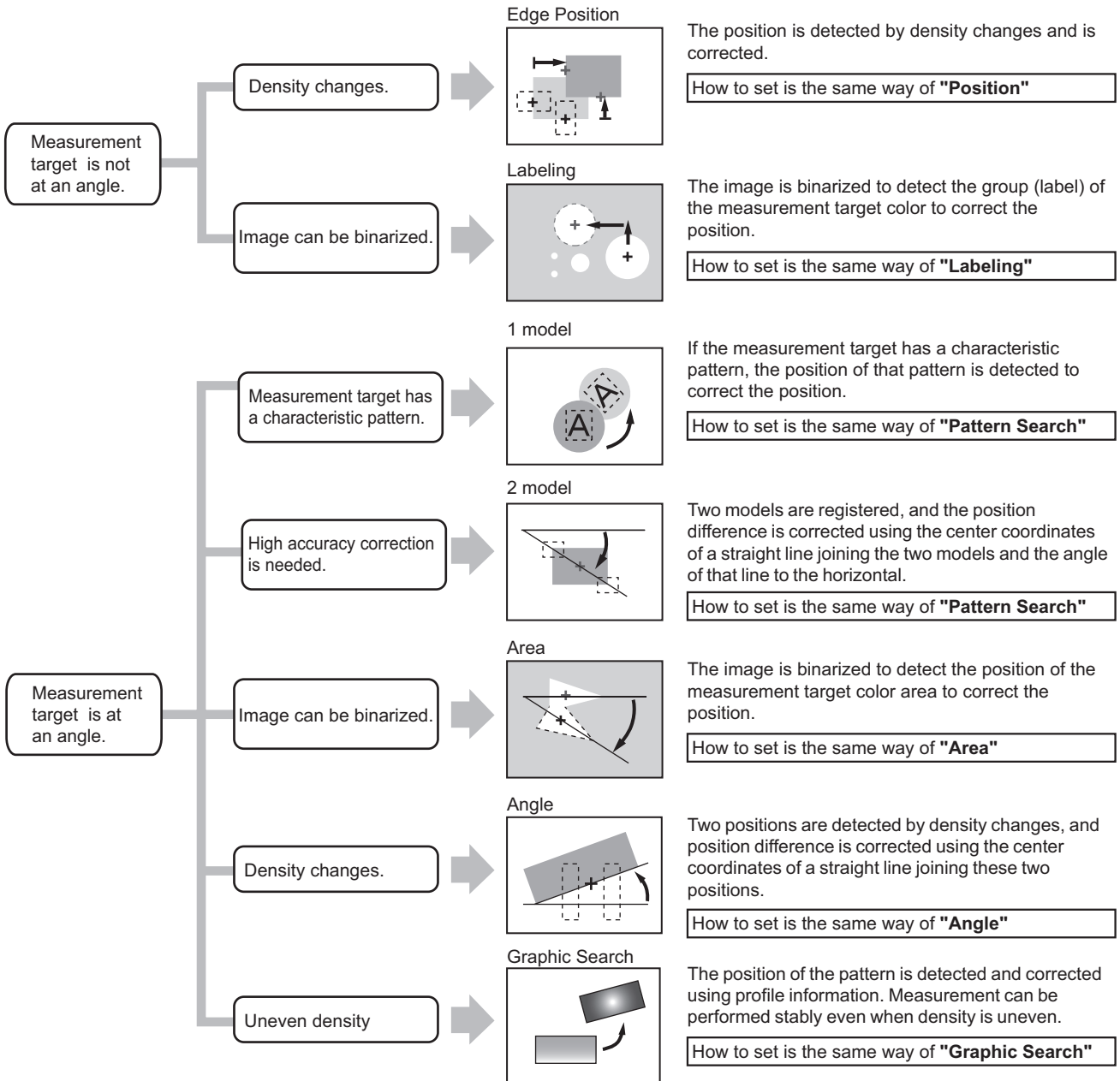

2-5 Getting the clear image

2-5-1 Color Filter

What is the color filter?

This function improves the contrast of images.

Normally "AUTO" function can select the best color filter. But if needed, you can select the best filter in typical color or any custom color. This function can be set only when a color camera is connected to the controller.

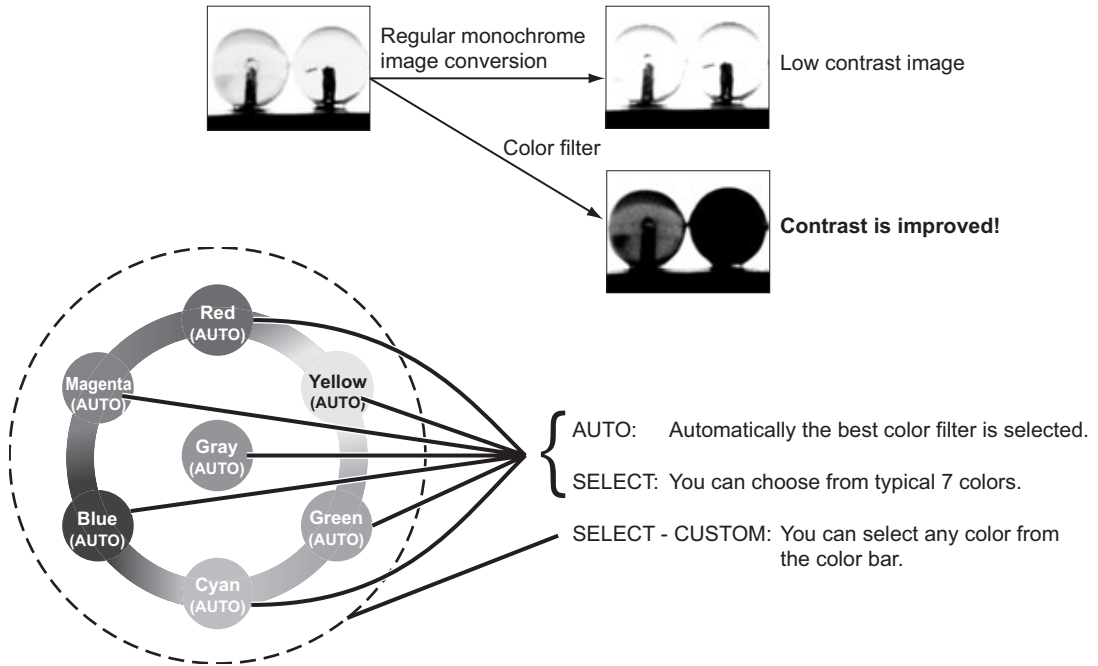

Color filter is available in the below items.

- (Shape) Pattern Search
- (Shape) Sensitive Search
- (Shape) Flexible Search (only C20/25)
- (Shape) Graphic Search (only C20/25)
- (Edge) Position
- (Edge) Width
- (Edge) Count
- (Edge) Angle
- (Bright&Color) Bright
- (Application) Defect
- (Application) Grouping (only C20/25)

AUTO

The color filter is automatically set. The color filter for enhancing the contrast between the color having the largest area and the color having the second largest area in the region (*1) is selected.

(*1) Model region : (Pattern Search / Sensitive Search / Graphic Search / Flexible Search / Grouping) Measurement region : (Area / Labeling / Position / Width / Count / Bright / Hue / Defect)

Select [AUTO] (key or icon on screen)

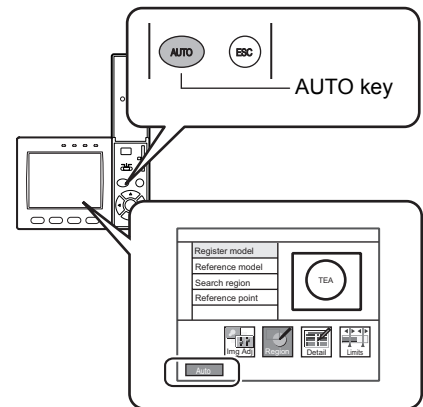

SELECT

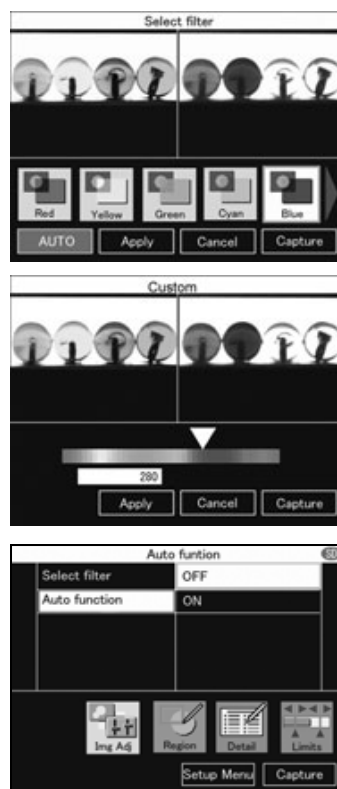

- MENU mode
- [Setup] icon
 - [Item] icon
 - [Img Adj] icon
 - [Select Camera] menu (only C20/25)
 - [Color Filter] menu
 - [Select filter] menu

- Select the color.
- 1, Red
 - 2, Blue
 - 3, Green
 - 4, Yellow
 - 5, Cyan
 - 6, Magenta
 - 7, Gray
 - 8, Custom

You can select any color from the color bar.

Key point

To hold the color filter, change [Auto function] to [OFF]. If [ON], color filter would be changed when the AUTO setting is next executed.

2-5-2 Color Pickup

What is the color pickup?

This function is needed for image binarization (digitalization). After processing the color pickup, camera image is converted into the binary image.

Up to 4 target colors can be specified for one measurement item.

This function can be set only when a color camera is connected to the controller. When a monochrome camera is connected, binary level can be set.

Color Pickup is available in the below items.

- (Size) Area
- (Size) Labeling (only C20/25)
- (Edge) Position *
- (Edge) Width *
- (Edge) Count *
- (Edge) Angle *

* You can select the color pickup in [Detail] –[Color mode]

Hint of color pickup

Color has three parameters. You can adjust three parameters.

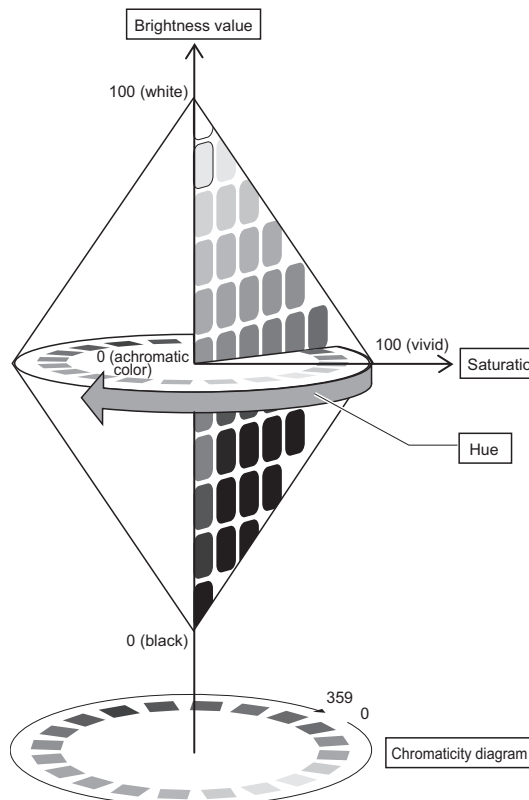

Parameter	Description
Hue	The name of a color, such as red, yellow or blue. Hue is expressed by a chromaticity diagram.
Saturation	The degree to which color is mixed with white. When a color has little saturation, it becomes an achromatic color. The higher saturation becomes, the purer the color becomes in proportion to hue.
Brightness value	The ratio of light intensity in a color.

Automatically Picking up Colors

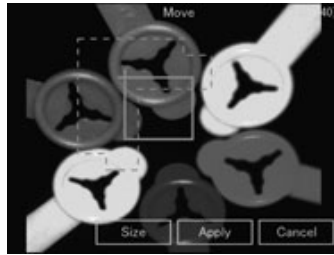

- MENU mode
- [Setup] icon
 - [Item] icon
 - [Img Adj] icon
 - [Select Camera] menu (only C20/25)
 - [Color Filter] menu
 - [Region] menu

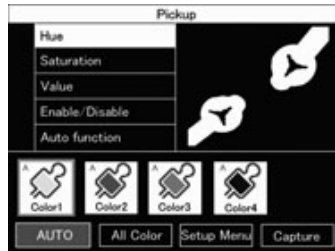

1. Draw the region and Click [Apply]

Important

This region isn't the measurement region. This region is drawn around the part that the desired colors are in.

2. Select [Pickup]
3. Select [Auto]
Candidates for up to 4 colors are selected.
4. Check if the desired colors are picked up. Select the icon of a candidate color. Only an image of the corresponding color is displayed.
5. If you don't use some colors as the color of measurement target, select [Disable]. [Enable/Disable]-[Disable]

Fine-Adjusting Colors

6. Select [Hue/Saturation/Value]

If the appropriate color is not obtained by [AUTO], fine-adjust three parameters (hue, saturation and brightness). The image can be adjusted while comparing the original image and the picked up color image.

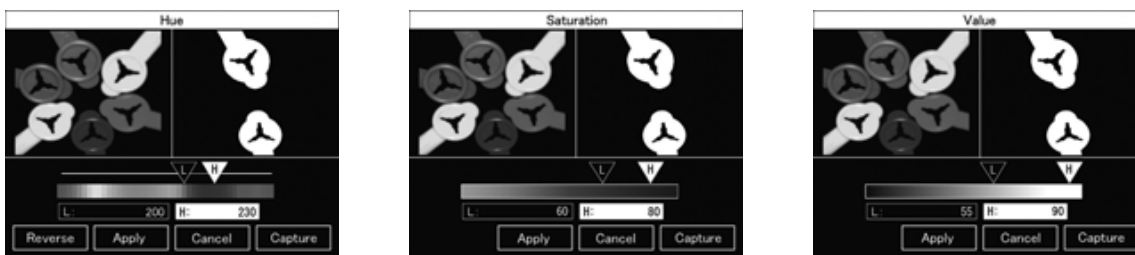

Key point

To hold the picked up color, change [Auto function] to [OFF]. If [ON], picked up color would be changed when the AUTO setting is next executed.

2-5-3 Pre-processing

What is the Pre-processing?

This function changes the camera image into the image which is easier to measure.

Important You can set the different pre-processing for each position correction and measurement item.

MENU mode - [Setup] - [Item] - [Img Adj] - [Select camera] - [Filtering]

Filtering	Target Image	Description of Filtering
OFF (default value)	-	-
Smooth	Measurement targets containing slightly unevenness	Creates a cloudy effect to soften the unevenness.
Erosion	Black measurement targets containing white noise	Reduces the white component to eliminate the noise.
Dilation	White measurement targets containing black noise	Spreads the white component to eliminate the black noise.
Median	Measurement targets containing slightly unevenness	Softens the unevenness while keeping the image contour intact.
Sharpen	Measurement targets containing fuzzy areas (fluctuating lighting, etc.)	Enhances the border lines between light and dark areas in the image.
V Edge	Images that are difficult to pick up due to poor contrast	Picks up the vertical border lines (contrast) in the image.
H Edge	Images that are difficult to pick up due to poor contrast	Picks up the horizontal border lines (contrast) in the image.
All Edge	Images that are difficult to pick up due to poor contrast	Picks up all border lines (contrast) in the image.

Note Filter Strength

The filter strength can be selected when applying the filtering options to images. Each selection of the [5x5 filter]/[3x3 filter] in the filtering setup screen toggles the filter strength.

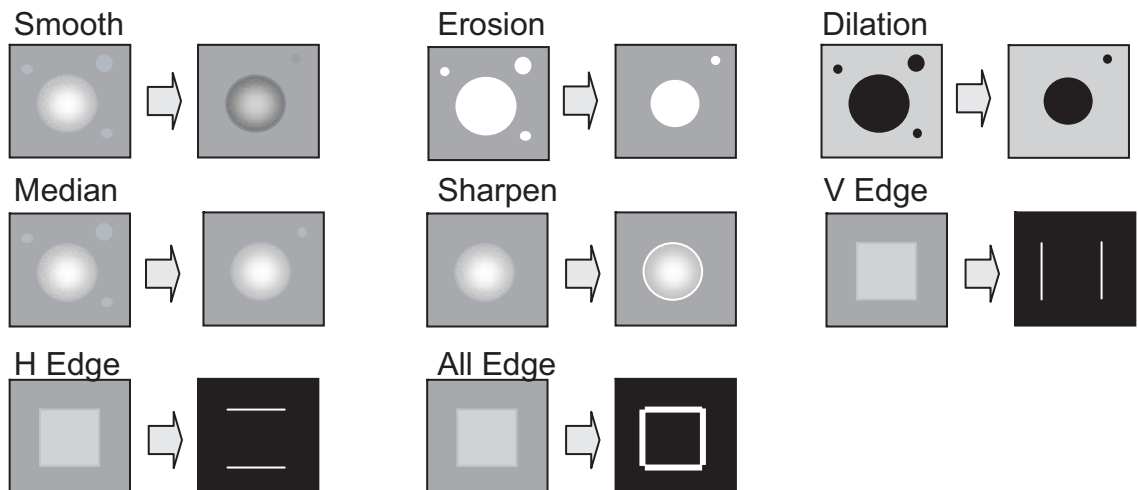

2-5-4 Background Suppression (BGS Level)

What is the Background Suppression?

This function removes unwanted background from the image. You can set the lower limit and the higher limit. And the density within two limits are convert into "0 to 255" tones.

Important

You can set the different pre-processing for each position correction and measurement item.

MENU mode - [Setup] - [Item] - [Img Adj] - [Select camera] - [BGS level]

Example: Set the lower limit value to 100 and upper limit value to 220.

Image before background is removed Image with background removed

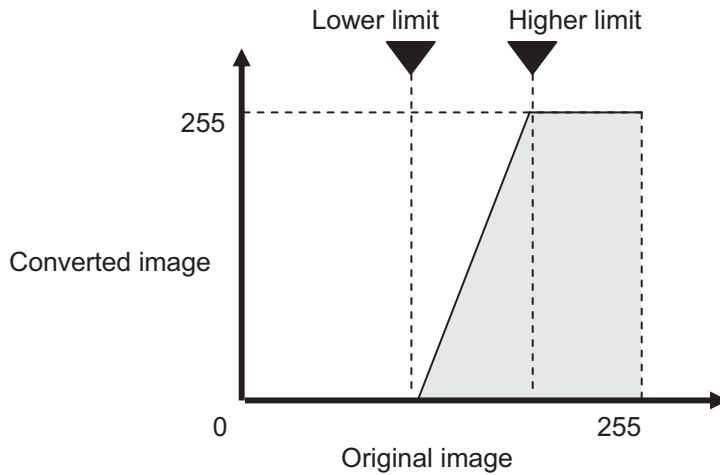
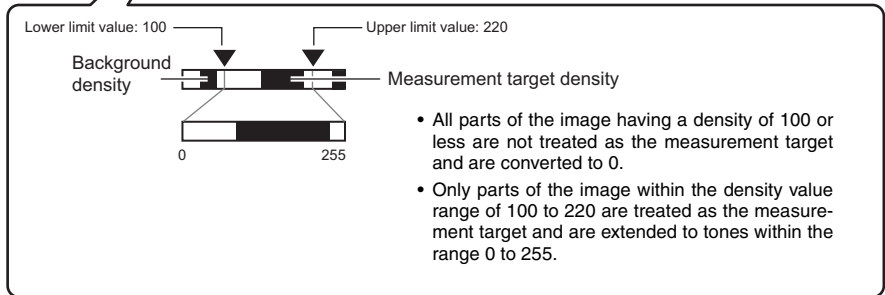
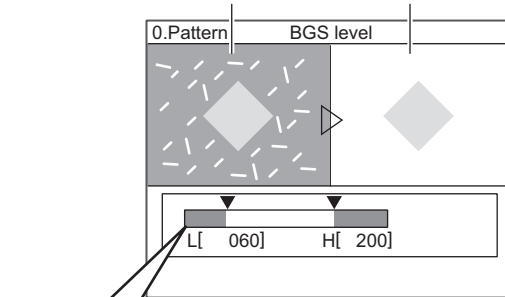

2-6 Changing the Display Information (ADJ/RUN Mode)

Measurement results and another information are displayed on LCDscreen. In ADJ mode, saved images can be displayed. The currently saved measurement data can also be checked using the logging monitor and statistical data (only C20/25). To switch the screen display, either select [Display SW] or press the F3 key.

Individual results

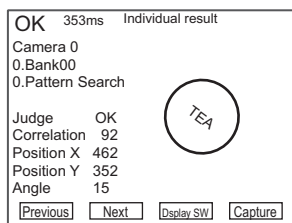

Results are displayed individually for each measurement item.

All results/Region

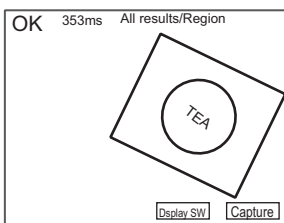

The entire measurement region is displayed.

All results/Judge

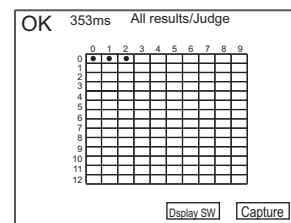

All measurement results are displayed as a list.

Horizontal axis: Smallest digit of item No.
Vertical axis: Upper two digits of item No.
Green circle: OK
Red circle: NG

Position correction

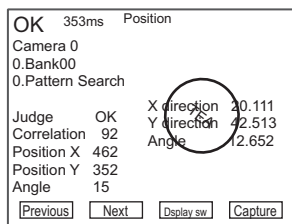

The position correction result is displayed.

Variables list

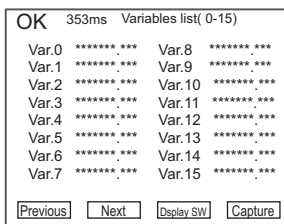

The data results are displayed as a list.

Data list

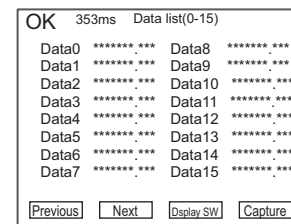

The variable results are displayed as a list.

Judgement list

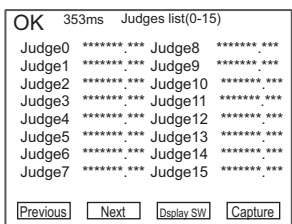

The judgement results are displayed as a list.

Stored image

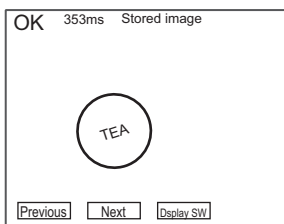

Saved images are displayed.

Only ADJ-Mode

Logging monitor

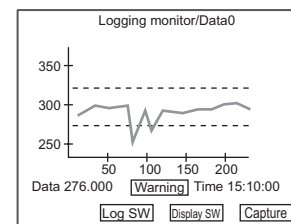

Conditions can be adjusted while viewing the measurement results saved to the logging monitor.

Only ZFX-C20/25

Statistical data

Statistical data/Data0			
Maximum	462	Count	100
Minimum	370	NG Count	5
Average	423	NG Rate	5%
Deviation	210	Alarm Cou	20

At the bottom are buttons for Log SW, Display SW, and Capture.

The statistical data saved to the logging monitor is displayed.

Only ZFX-C20/25

In the Individual results display or Position correction display, you can hide or reduce the size of images that are displayed simultaneously with measurement information. Each press of the ↑ UP key/↓ DOWN key switches the image display as follows:

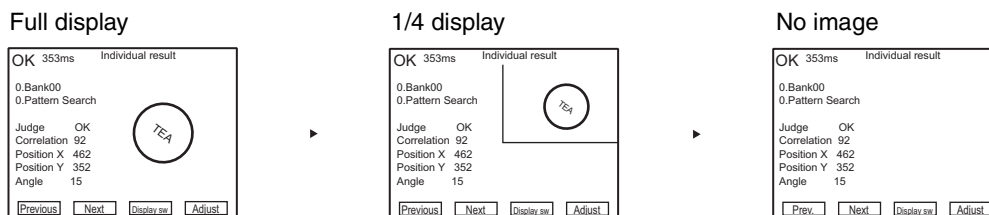

The 1/4 display is available only for the individual results display and position correction display.

Important Only ADJ-Mode:

In the Stored image display, the image display is switched between 1/4 display and full display.

2-7 Re-measuring the saved image (ADJ Mode)

Re-measurement can be performed using a measurement image saved in internal memory. Images are saved to internal memory in the RUN mode. If the ←L key/→R key is pressed in the Individual results display or All results/Region display, the screen switches to the saved image and re-measurement is executed.

SECTION 3

Run-Mode Measurement Process

There are two measurement-mode. In TRIG measurement-mode, TRIG is the first event and one measurement is done. In continuous measurement-mode, continuous measurement command is the first event and measurements are done repeatedly until stop command.

TRIG Measurement-Mode

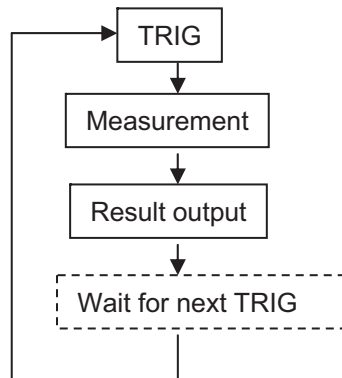

Continuous Measurement-Mode

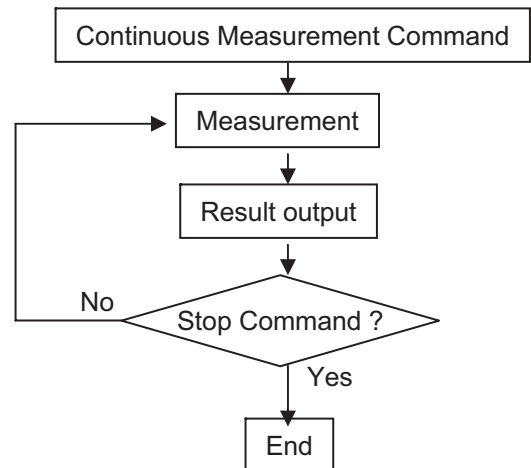

TRIG

How to input

1. Serial Command via RS-232C/422, USB, Ethernet
It's needed to send the command from external device (e.g. PC, PLC)
Please see the detail in "Serial Communication Command Reference"
2. Parallel (TRIG Signal)
One measurement is done if TRIG signal is turn ON.

Continuous Measurement Command and Stop Command

How to input

1. Serial Command via RS-232C/422, USB, Ethernet
It's needed to send the command from external device (e.g. PC, PLC)
Please see the detail in "Serial Communication Command Reference"
2. Parallel Communication
 - Continuous Measurement Command
It's needed to send the command from external device (e.g. PLC)
Please see the detail in "User's manual"
During continuous measurement, it's needed to keep the state of input command.
 - Stop Command (Stop condition)
If the status of continuous measurement command breaks, continuous measurement is ended.

Measurement Results

There are three kind of results.

- Overall Judgement
- Individual Judgement (You can define up to 32 judgements)
- Individual data (You can define up to 32 data)

How to define “Individual Judgement”

MENU mode -[Setup] -[Add func] -[Calculation] -[Judge]

Up to 32 (0 to 31) Individual Judgement can be defined. Each one is expressed by the following parameters/functions and each one has the upper/lower thresholds. If result of expression is in between both threshold, judgement is OK.

Parameters and functions

Parameter of each item	Parameter of measurement item and position correction item. Ex) Judgement of Pattern Search Ex) Gravity position of Area
List of function	Please see the details in the Users-Manual. 16 functions are available. Ex) MAX: Max value of four arguments Ex) DIST: Distance between two points (gravity and center of model) Ex) OR: Logical sum of two arguments
List of operators	+, -, x, /
Constant number	Ex)
Individual Data	You can use the Individual data which are already defined.
Individual Judgement	You can use the Individual Judgement which are already defined.
Variables	You can define the original “Variables”(up to 32). These variables can be expressed as same as “Individual judgement”.

How to define “Individual Data”

MENU mode -[Setup] -[Add func] -[Calculation] -[Data]

Up to 32 (0 to 31) Individual Data can be defined. Each one is expressed by the parameters/functions which are same ones as individual judgement (please see the upper chart). Result value of expression can be output.

Overall Judgement

How to get Overall Judgement Output (OR Output)

1. Parallel OR Signal
OR signal's (ON/OFF) indicates the total judgement (OK or NG).

Setting about Overall Judgement

Setting Reflection of Individual Results	<u>MENU mode - [Setup] - [Add func] - [OR setting]</u> You can select which items results are reflected in the overall judgement that is output to the OR signal of the parallel interface.	
	Measurement Item	ON (default) / OFF
	Position correction	
	Calc./variable (Individual Data)	
	Calc./judge (Individual Judge)	
	Calc./alarm (Logging Monitor Alarm)	ON / OFF (default)
Able / Disable	<u>MENU mode - [System] - [Output] - [Total jg. output] - [Parallel]</u> If selecting OFF, OR signal is disable. ON (default) / OFF	
Output Polarity (OR, DO[0:15])	<u>MENU mode - [System] - [Comm] - [Parallel] - [Polarity]</u> ON condition of OR and Individual Judgement NG=ON: Signals turn ON when judgement is NG. (default) OK=ON: Signals turn ON when judgement is OK.	
OR output mode	<u>MENU mode - [System] - [Comm] - [OR output]</u> One-shot: OR signals turns ON for specified time only when ON condition is satisfied. Level: ON/OFF status is held until it next changes after OR signal has been output. (default)	
OR Output time	<u>MENU mode - [System] - [Comm] - [OR output]</u> Output time of OR signal as a one-shot signal Range: 0 to 255 ms (default: 0 ms)	

Individual Judgement

How to get Individual Judgement Output

1. Parallel 'DO 0 to 31' Signals
DO[0:15] signals' (ON/OFF) indicates the Individual judgements (OK or NG).

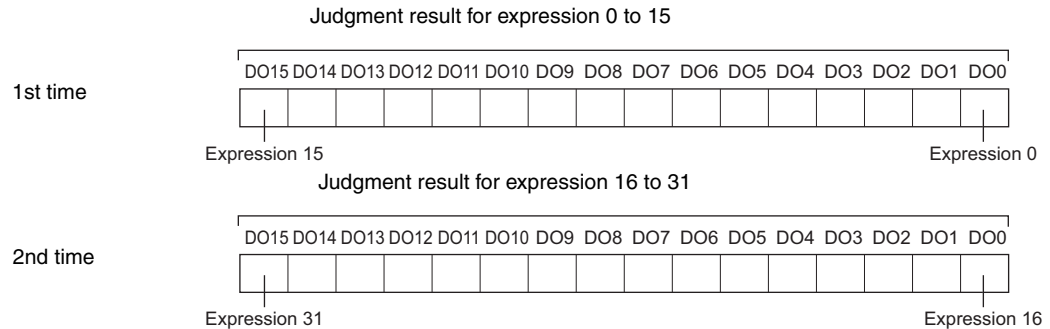

Setting about Individual Judgement

Able/Disable	MENU mode - [System] - [Output] - [Judgement output] - [Parallel] If selecting ON, judgements are output. ON (default) / OFF
MENU mode - [System] - [Comm] - [Parallel]	
Output Polarity (OR, DO[0:15])	ON condition of OR and Individual Judgement NG=ON: Signals turn ON when judgement is NG. (default) OK=ON: Signals turn ON when judgement is OK.
Output cycle	Output cycle time. Set the time that is "Gate ON delay + Gate ON time" or more and that is shorter than the measurement cycle. Range: 2.0 to 10000.0 ms (default: 10.0 ms)
Gate ON delay	Delay time from output of measurement result to DO[0:15] until GATE signal turns on. Range: 1.0 to 10000.0 ms (default: 1.0 ms)
Gate ON time	Range: 1.0 to 10000.0 ms (default: 5.0 ms)
Handshaking	Set the output method. OFF: Measurement results are output asynchronously with external device. (default) ON: Measurement results are output synchronously with external device.
Timeout	In case of "Handshaking = ON", a timeout error occurs when there is no response from external device within timeout period. Range: 1.0 to 60.0 s (default: 10 s)

Individual Data

How to get Individual Data Output

1. Parallel 'DO 0 to 31'Signals
Only integer value is output. (Data is rounded to the nearest integer.) Data is output in 2's complement format in 16-bits at a time. When two or more data are defined, 16-bits values are output sequentially.

When measurement value is "+1234"

DO15	DO14	DO13	DO12	DO11	DO10	DO9	DO8	DO7	DO6	DO5	DO4	DO3	DO2	DO1	DO0
0	0	0	0	0	1	0	0	1	1	0	1	0	0	1	0

2. Serial Communication via RS-232C/422, USB, Ethernet
It doesn't need to send the command from external device (e.g. PC, PLC). If you set "Data output = ON" (See below description about setting), Individual data are automatically output after measurement is finished.
3. To SD-Card
If you set "Data output = ON" (See below description about setting), Individual data are automatically output after measurement is finished.

Setting about Individual Data

MENU mode - [System] - [Output] - [Data output]

Setup Item	Description
RS-232C/422	Selects ON to output data on the RS-232C/422 interface. (default value: OFF)
Parallel	Selects ON to output data via the parallel port. (default value: OFF)
SD card	Selects ON to output data to the SD card. (default value: OFF)
USB	Selects ON to output data via the USB port. (default value: OFF)
Ethernet	Selects [ON] to output data on an Ethernet connection. (default value: OFF)

Setting about Individual Data (Parallel)

MENU mode - [System] - [Comm] - [Parallel]	
Output Polarity (OR, DO[0:15])	This is same setting as Individual Judgement. (See the previous page)
Output cycle	
Gate ON delay	
Gate ON time	
Handshaking	
Timeout	

Setting about Individual Data (Serial / SD-Card) [Binary Format]

MENU mode - [System] - [Output] - [Date format (Serial)/(SD Card)]

Setup Item	Description
Output form	Selects binary.
Display at time	Prefixes the output data with time information. Range: OFF (default value), ON
File name	Sets the name of the output file. (only when SD card is selected)

Output format

The value by 1000 times is output continuously as 4 bytes per single data item. Minus number are output as 2' s complement.

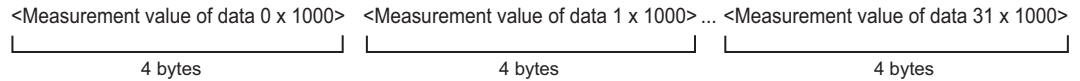

Example: When data 0 is "256.324" and data 1 is "-1.000"

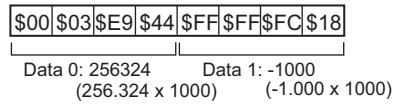

When "Display at time" is ON, the time information is prefixed.

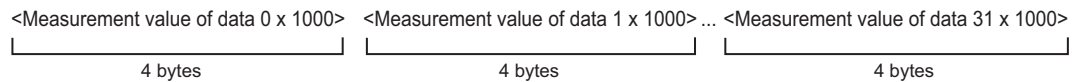

Example: When data 0 is "256.324" and data 1 is "-1.000"

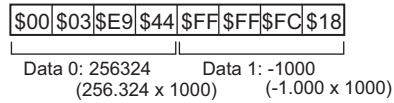

Parallel Interface Timing Chart

Ex.) TRIG Measurement, Handshaking: OFF

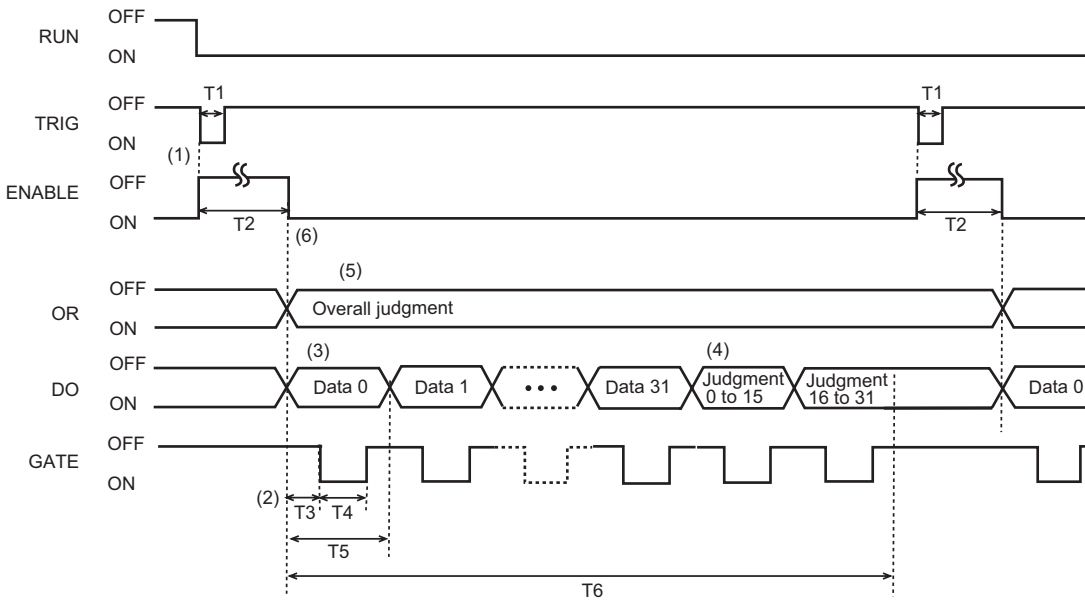

T1: Trigger input time	Set to ON for at least 0.5 ms.
T2: Measurement time	This time is "image input" + "measurement". This time can be changed to only "image input" or "image input" + "measurement" + "display".
T3: Gate ON delay	This is the time to wait until stable output data can be obtained. This time can be changed.
T4: Gate ON time	This is the time required for the external device to capture output data from the Controller. This time can be changed.
T5: Output cycle	This is the interval in which the DO signal state changes. This time can be changed.
T6: Total output time	This time is equivalent to "output cycle (T5) x number of output data items". Input the trigger at an interval longer than this time. When the total output time is longer than T2, non-output data accumulates in the Controller as the next measurement is executed before measurement results are output. When the Controller becomes filled up with this non-output data, data can no longer accumulate in the Controller. When this happens, output of non-output data continues, and the next measurement is no longer possible until queued data has finished accumulating.

Explanation of operation

1. When the measurement trigger (TRIG signal) is input from the external device, measurement is executed once synchronized with the rising edge of the TRIG signal (OFF -> ON).
2. The GATE signal is used to control the timing at which the external device captures measurement results. Set the Gate ON delay (T3) and Gate ON time (T4) so that $T3+T4 < T5$.
3. When parallel output is set to "ON" as the data output destination, data is output for the number of times in the expression set at "Calculation (data)" (maximum 32 times). When parallel output is OFF, data is not output.
4. When parallel output is set to "ON" as the judgment output destination, judgment is output for the number of times in the expression set at "Calculation (judgment)" (maximum twice). When parallel output is OFF, judgment is not output.
5. The overall judgment is output. Overall judgment is NG if there is even one NG for the preset measurement items and judgment results in the expression. In the case of level output, the ON/OFF status of the OR signal does not change until the next output as shown in this example.
6. When the timing for turning the ENABLE signal ON is set to "end of image input", a delay occurs until output is started after the ENABLE signal turns ON as measurement is also executed after the ENABLE signal turns ON. Do not input the next trigger until measurement is completed.

SECTION 4 Item Overview

4-1 ITEM Overview (Pattern Search)

An image pattern is registered in beforehand as a model, and the parts that most resembles an already registered model is searched. The correlation, the position of most resembled parts, and their angle can be outputted.

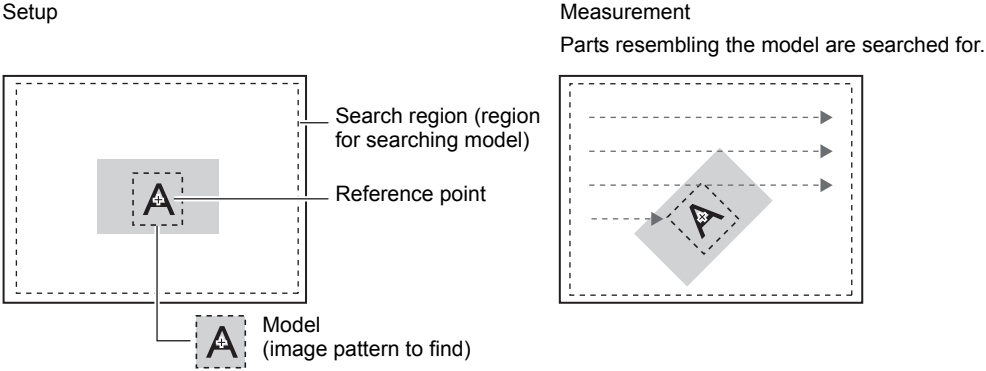

Search Process and Search Mode

- 1. Roughly Search**
The resembled parts in the whole image are searched roughly.
- 2. Detailed Search (Standard Search)**
After roughly search, this search would be done around the roughly searched position. Detail correlation and position are measured.
- 3. High-precision Search**
After detailed search, this search would be done around the detail searched position. More detail correlation and subpixel position are measured.

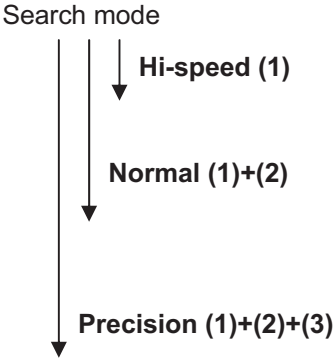

Another setting

Search mode	See above						
	Hi-speed	The search is performed at high speed.					
	Normal (default)	The search is performed at normal speed and normal accuracy.					
	Precision	The position is calculated at high precision in sub-pixel (smaller than pixel).					
Rotation Range	Rotation range: 0 to 180 (default value: 0)						
Skipping Angle	Skipping angle: 1, 2, 3, 5, 10, 15, 20, 30 (default value: 10) It is possible to find the most resembled image to rotate. In case that Rotation Range is set to more than 0, many angled models are registered automatically. And search process is done for each model. E.g. Rotation Range: 15, Skipping Angle: 5						
	-15	-10	-5	0	+5	+10	+15

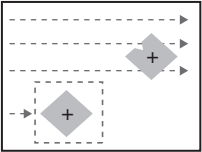
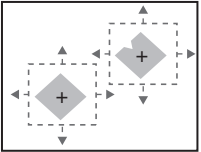
Interpolation	<p>ON/OFF (default)</p> <p>The angle is calculated as a numerical value down to three digits past the decimal point based on the value obtained in skipping angle units. Note, however, that the processing time increases. This function is enabled only when the search mode is the normal mode or the precision mode.</p>
<p>Verification</p> <p>Candidate level</p>	<p>ON/OFF (default)</p> <p>0 to 100 (default value: 60)</p> <p>In case that Verification is ON.</p> <p>A rough search is done inside the search region to find the candidate point.</p> <div style="display: flex; align-items: center;">  ➔ <div style="text-align: center;"> <p>Verification ON</p>  </div> <div style="margin-left: 20px;"> <p>A detail search is done at images near all candidate point.</p> </div> </div>

4-2 ITEM Overview (Sensitive Search)

Sensitive search is a useful function to detect even minute differences, which are difficult to determine using pattern searches. The degree of matching is checked in detail by automatically subdividing registered models.

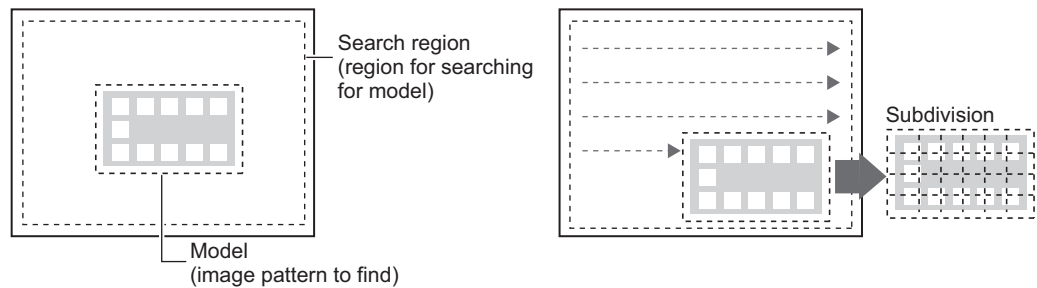

Search Process

1. **Pattern Search**

A pattern search is performed with registered models without subdivision. The location with the greatest correlation is extracted for the measurement mode (high-speed, standard, and high-precision).

2. **Sensitive Search original**

Subdivided models are matched against the location obtained in step 1, and the value of the part with the worst correlation is output.

Another setting

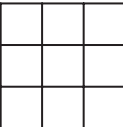
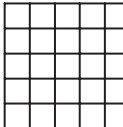
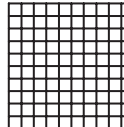
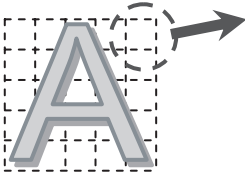
Search mode	Hi-speed / Normal / Precision (default) This is same setting as pattern search. (See the “Pattern Search”)
Sensitivity	Low / Middle (default) / High accuracy: Low < Middle < High measurement speed: Low > Middle > High <div style="display: flex; justify-content: space-around; align-items: flex-start;"> <div style="text-align: center;"> <p>Low</p>  </div> <div style="text-align: center;"> <p>Middle</p>  </div> <div style="text-align: center;"> <p>High</p>  </div> <div style="margin-left: 20px;"> <p>Low: Up to 9 models Middle: Up to 25 models High: Up to 100 models</p> </div> </div>
Rotation Range	Rotation range: 0 to 180 (default value: 0)
Skipping angle	Skipping angle: 1, 2, 3, 5, 10, 15, 20, 30 (default value: 10) This is same setting as pattern search. (See the “Pattern Search”)
Interpolation	ON / OFF (default) This is same setting as pattern search. (See the “Pattern Search”)
Verification Candidate level	ON / OFF (default) 0 to 100 (default value: 60) This is same setting as pattern search. (See the “Pattern Search”)
Solid Color Check	 <p>It's impossible to calculate the correlation values for unpatterned locations. Therefore, the extent that pattern is lacking is output based on the average deviation, if solid color check is ON. Value: 0 to 100 The closer to 100, the more uniform.</p>

4-3 ITEM Overview (Flexible Search)

Use this item when passed products have differences. By registering up to 36 patterns as models in beforehand, it can be prevented to reject the acceptable product. All correlations are calculated between the input image and every model, and then the highest correlation and position of measurement object are output.

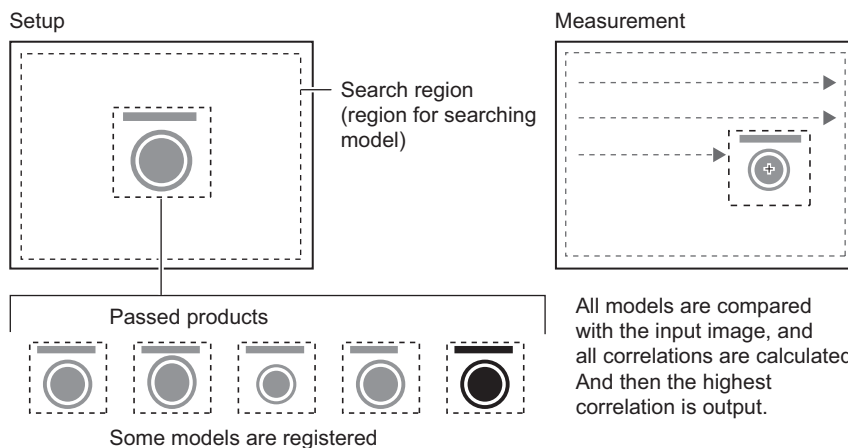

Another setting

Search mode	Hi-speed / Normal (default) / Precision
Verification	ON / OFF (default)
Candidate level	0 to 100 (default value: 60) This is same setting as pattern search. (See the "Pattern Search")

EDIT

This item cannot do the rotation search. Please set same amount of "Pattern Search"s as models which you'd like to register, If work object has a rotated status.

4-4 ITEM Overview (Graphic Search)

Use this item when it's difficult to search for a model from partially clipped images or low contrast images. In a pattern search, measurement is based on the contrast information. However, measurement is based on profile information in this item.

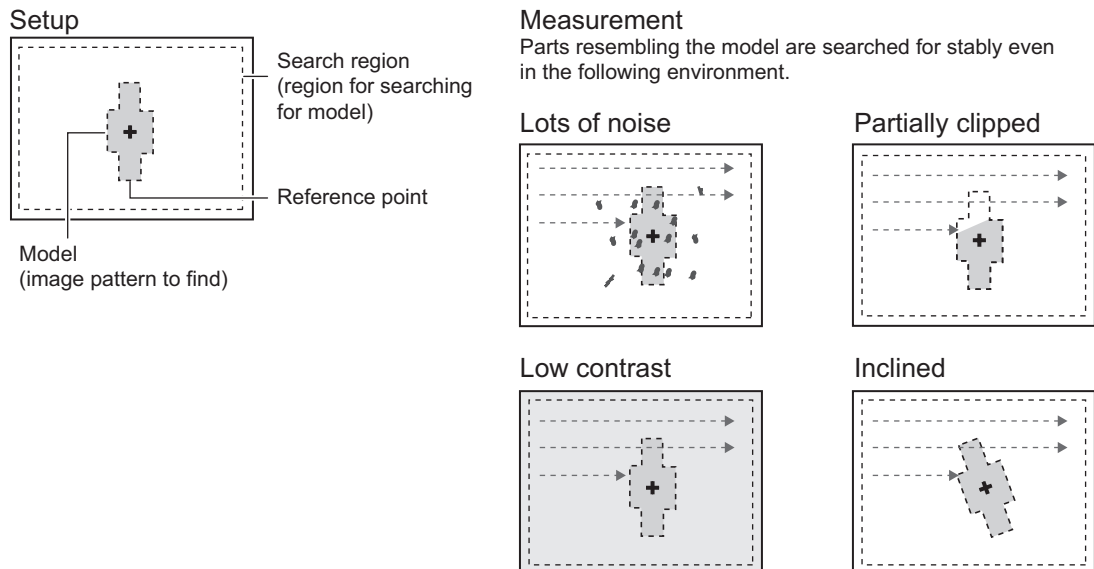

Model registration procedure

if the shape of object is like a box, Ellipse or line.

1. Select [Box], [Ellipse] or [Line].
2. Trace the profile of object. And select [Apply].
-->The profile is traced.

Model registration procedure

if the shape of object is not simple.

1. Select [Auto] and enclose the area in which the profile is to be traced.
2. Select [Auto] displayed on the lower left on the screen.
-->The profile is traced.
3. If the profile is partially clipped, trace by [Free], [Box], [Ellipse] or [Line].
4. Delete any noise with the [Erase] tool if noise has been traced.

Another setting

Search mode	Hi-speed / Normal (default) / Precision This is same setting as pattern search. (See the "Pattern Search")
Rotation Range	Rotation range: 0 to 180 (default value: 0)
Skipping angle	Skipping angle: 1, 2, 3, 5, 10, 15, 20, 30 (default value: 10) This is same setting as pattern search. (See the "Pattern Search")
Interpolation	ON / OFF (default) This is same setting as pattern search. (See the "Pattern Search")
Candidate level	0 to 100 (default value: 60) This is same setting as pattern search. (See the "Pattern Search")

4-5 ITEM overview (Area)

The area, gravity and angle of the desired color can be measured. Therefore, the size, the position and the inclination of the measurement target can be inspected.

When color camera is connected to the controller, up to four colors can be specified as the measurement colors.

When monochrome camera is connected, black-and-white image is binarized. White pixels are targeted in measurement.

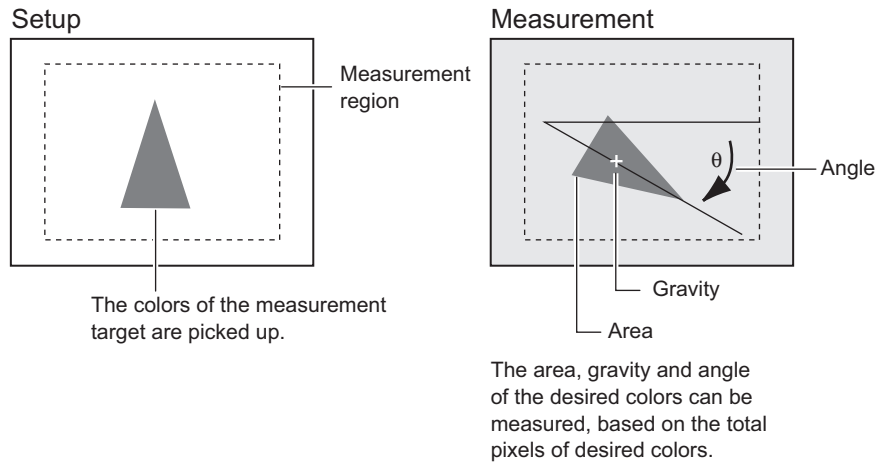

Another setting

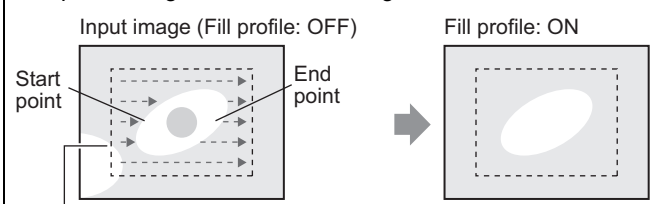
Measure axis angle	ON / OFF (default) Set whether or not to measure the angle. (When selecting [ON], the processing time increases.)
Fill profile	ON / OFF (default) This is efficient, when passed products doesn't have the uniformity inside but has a same outer shape. Passed products  When measuring the outer shape of the measurement target, set this to [ON]. If this is set to [ON], all of the area between the start point and the end point inside the measurement region are measured as the measurement target color. Start point: untargeted color --> targeted color End point: targeted color --> untargeted colors  Pixels that are measurement target color are not recognized as the start point as pixels that are colors outside of measurement target are next scanned.

Notice:

The color pickup isn't done by clicking [AUTO] in the measurement Item. Please select the pick up color in the color pickup screen.

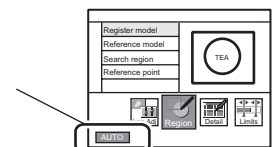

4-6 ITEM Overview (Labeling)

A group of colors which is measured is counted as a “label”. Label Nos. can be assigned to every label after being arranged in order of size and position. The total number of labels and the size/position of any label can be output.

When color camera is connected to the controller, up to four colors can be specified as the measurement colors.

When monochrome camera is connected, black-and-white image is binarized. White pixels are targeted in measurement.

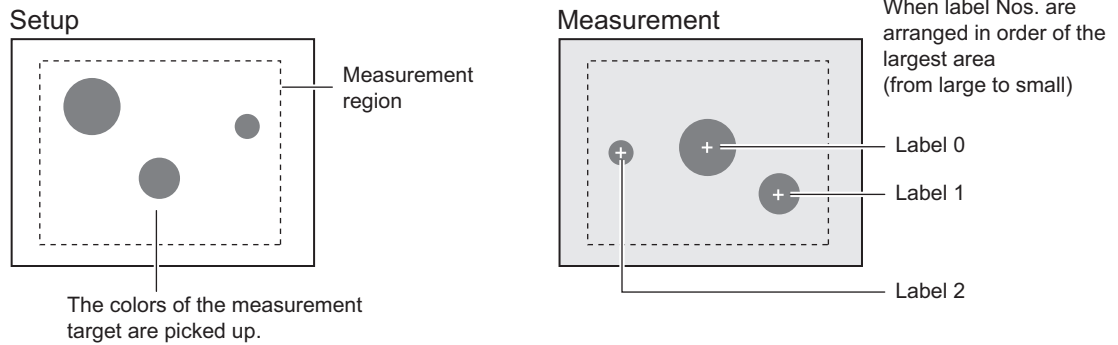

Another setting

Labeling mode	Normal (default) / Precision When “Normal” is selected, the image is measured at high speed after compressed to 1/2 size in both the horizontal and vertical axes.	
Sort mode	Area descending order	From large area to small area
	Area ascending order	From small area to large area
	X gravity descending order	From large X position to small X position
	X gravity ascending order	From small X position to large X position
	Y gravity descending order	From large Y position to small Y position
	Y gravity ascending order	From small Y position to large Y position
Label No.	0 to 2499 (default value : 0) Sets the label No. whose data (area/position) is to be output.	
Measure axis angle	ON / OFF (default) Set whether or not to measure the angle. (When selecting [ON], the processing time increases.)	
Measure perimeter	ON / OFF (default) Set whether or not to measure the following parameters. (When selecting [ON], the processing time increases.) - Perimeter - Length X - Length Y	
Measure roundness	ON / OFF (default) Set whether or not to measure the roundness. (When selecting [ON], the processing time increases.) Roundness = $4\pi \times \text{area} / (\text{perimeter} \times \text{perimeter})$	
Filling up holes	ON / OFF (default) Select how to process the parts of untargeted color which are enclosed by the target color, such as a doughnut. When [ON] is set, that parts are recognized as the target color. (When selecting [ON], the processing time increases.)	
	<p>Input image</p> <p>→</p> <p>Filling up holes: ON</p> <p>Measurement target</p>	

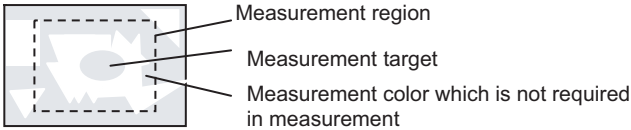
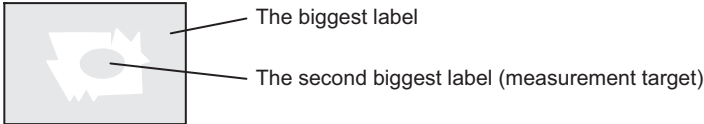
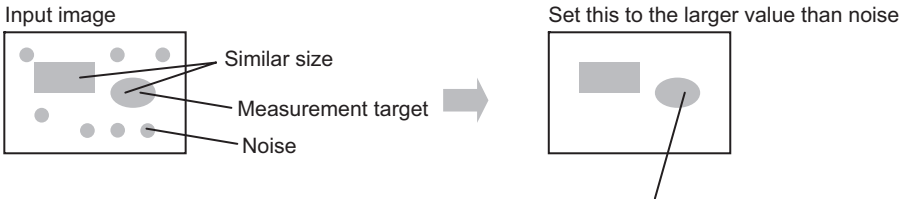
<p>Outside trimming</p>	<p>ON / OFF (default)</p> <p>This is efficient, when around the measurement region there are the measurement colors that are not required in measurement. e.g.</p>  <p>When [ON] is set, the entire region outside of measurement region is measured as the color to be measured. (When selecting [ON], the processing time increases.)</p> <p>Outside trimming: ON</p>  <p>Sort mode: Area descending order</p> <p><u>When "Label No." is set to "1", it is easy to get the position and area of measurement target.</u></p>
<p>Area judgement</p>	<p>0 to 9999999.999 (default value: 0)</p> <p>Set the minimum area to be counted as a label. Set a larger value than size of noise when noise is counted as a label. e.g.</p>  <p>Sort mode: X gravity descending order</p> <p><u>When "Label No." is set to "0", it is easy to get the position and area of measurement target.</u></p>

Notice:

The color pickup isn't done by clicking [AUTO] in the measurement Item. Please select the pick up color in the color pickup screen.

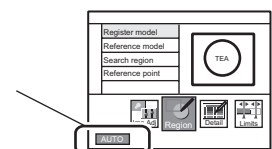

4-7 ITEM Overview (Position)

This item detects the edge, based on the change of brightness. Use this item to measure the coordinates of the edge of a measurement target.

Setup

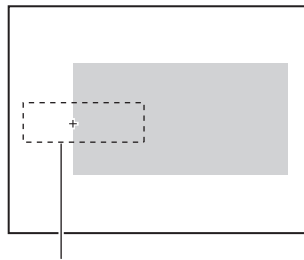

Measurement region
Change of brightness: light --> dark

Measurement

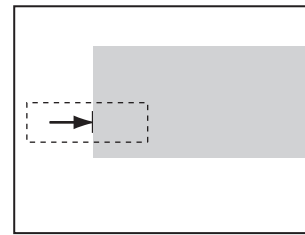

The edge is searched in the measurement region according to the preset direction and change of brightness

Edge search direction

The edge is searched from the start point towards the end point of the measurement region.

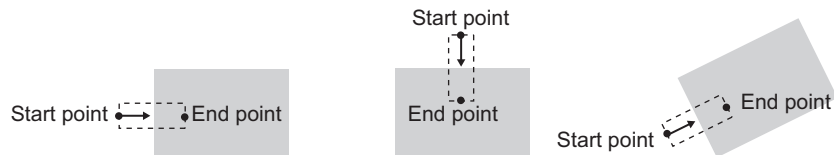

Another setting

Measurement mode	Average (default) / Peak / bottom Set the definition of the edge position.	
Color mode	Select the method of image adjustment.	
	Filter mode	Color filter is used for image adjustment.
	Pickup mode	Color pickup is used for image adjustment.
Split size	size1 to 99 (default value: 1) Set the calculation width when measuring the peak/bottom/average position. (The measurement region is divided into smaller areas to measure the peak/bottom/average position)	
Color	Light-->Dark (default) / Dark-->Light Select the direction of the destiny change.	

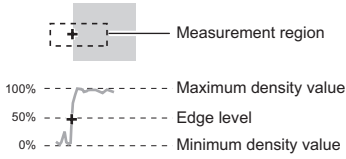
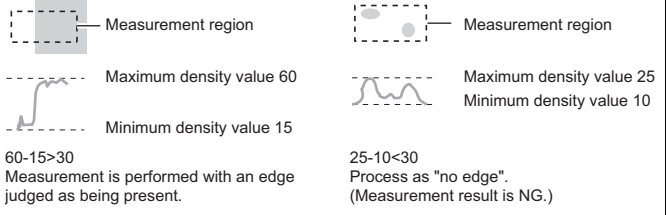
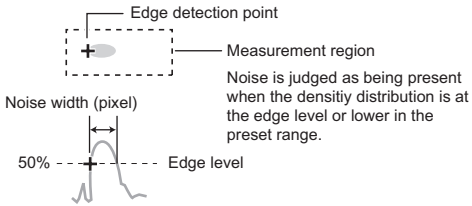
<p>Edge level</p>	<p>0 to 100 (%) (default value: 50)</p> <p>Set the level of density change to be judged as an edge.</p> <p>Edge is detected as follows:</p> <ol style="list-style-type: none"> 1. The density distribution of the whole measurement region is calculated. 2. The maximum value is set to 100%. Minimum value is set to 0%. 3. Place where the density is equal to edge level is detected as an edge. 
<p>Noise level</p>	<p>0 to 255 (default value: 20)</p> <p>Set the level to be judged as noise.</p> <p>Normally this value may be default value of 20. However, set a higher value when noise is detected as an edge.</p> <p>e.g.</p> <p>(Max density - min density) < noise level --> Judged as "no edge"</p> <p>(Max density - min density) > noise level --> Judged as "edge"</p> 
<p>Noise width</p>	<p>0 to 255 (default value: 0)</p> <p>Set the level to be judged as noise.</p> <p>Normally this value may be default value of 0. However, set a higher value when noise is detected as an edge.</p>  <p>Noise is judged as being present when the density distribution is at the edge level or lower in the preset range.</p>

4-8 ITEM Overview (Width)

This item detects two edges, based on the change of brightness. Use this item to measure the distance between two edges of a measurement target.

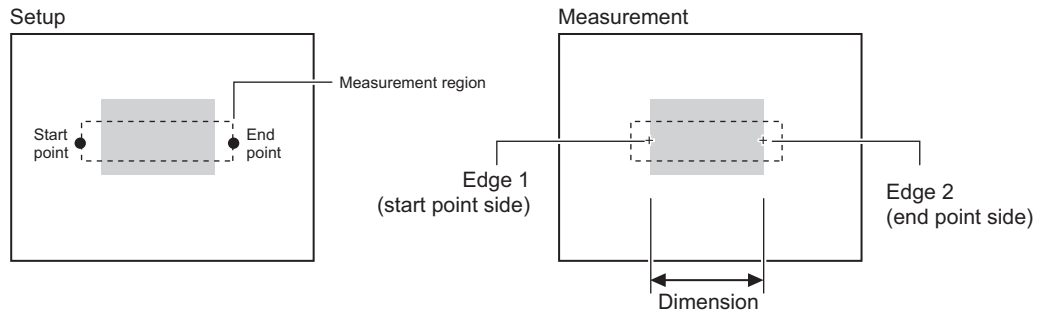

Edge 1 is searched from start point towards the end point.
Edge 2 is searched from end point towards the start point.

Another setting

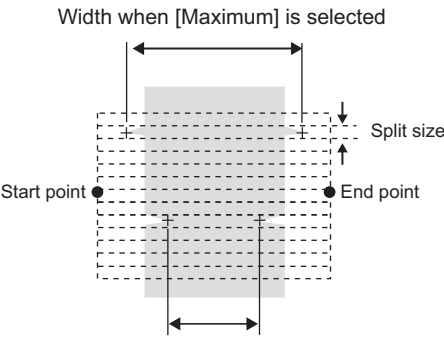
Measurement mode	Average (default) / Maximum / minimum Set the definition of the distance. Width when [Maximum] is selected  Width when [Minimum] is selected
Color mode	Filter mode (default) / Pickup mode This is same setting as position. (See the "Position")
Split size	1 to 99 (default value: 1) This is same setting as position. (See the "Position")
Color 1, 2	Light --> Dark (default) / Dark --> Light This is same setting as position. (See the "Position")
Edge level 1, 2	0 to 100 (%) (default value: 50) This is same setting as position. (See the "Position")
Noise level 1, 2	0 to 255 (default value: 20) This is same setting as position. (See the "Position")
Noise width 1, 2	0 to 255 (default value: 0) This is same setting as position. (See the "Position")

4-9 ITEM Overview (Count)

This item detects two edges, based on the change of brightness. Use this item to measure the number, width and pitch of edges of a measurement target.

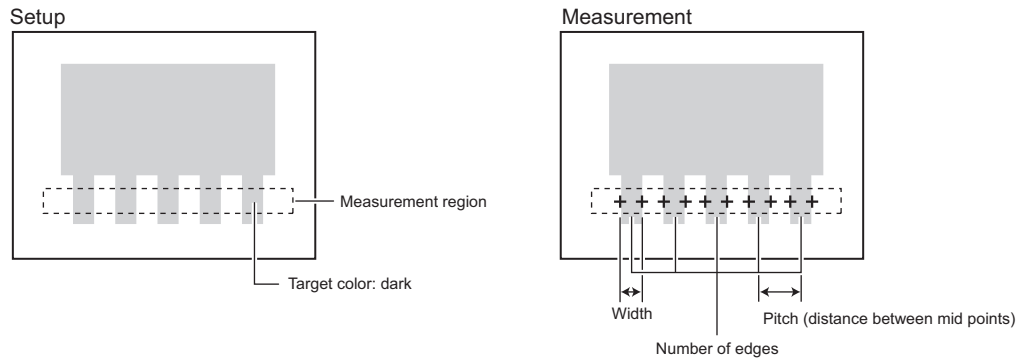

Another setting

Measurement mode	Normal (default)	Select "Normal" in case that pin width and pitch are two pixels or more.
	Fine	Select "Precision" for stably measuring the narrower width and pitch than "Normal".
Color mode	Filter mode (default) / Pickup mode This is same setting as position. (See the "Position")	
Target color	Light (default) / Dark Select the target color.	
Edge level 1, 2	0 to 100 (%) (default value: 50) The edges are detected by derivative distribution in this item. Edge is detected as follows; 1. The amount of change in direction light --> dark and dark --> light is calculated. 2. The maximum value is set to 100%. Minimum value is set to 0%. 3. Places where the amount of change exceeds the edge level are detected as edges.	
Noise level 1, 2	0 to 255 (default value: 20) This is same setting as position. (See the "Position")	
Noise width 1, 2	0 to 255 (default value : 0) This is same setting as position. (See the "Position")	

4-10 ITEM Overview (Angle)

This item uses two “Position” items. Specifically this Item finds the two edges in two measurement regions and outputs the angle between two edge points.

Setup

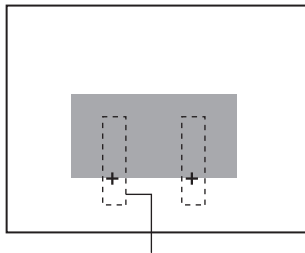

Measurement region
Change of brightness: light --> dark

Measurement

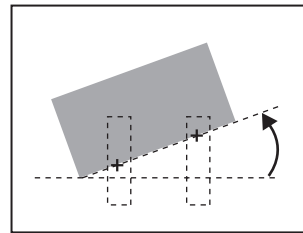

The edges are searched in the two measurement regions according the preset direction and change of brightness. The inclination of the straight line made by two points is calculated.

Angle

Angle is calculated according to the positional relationship between the 2 edge positions.

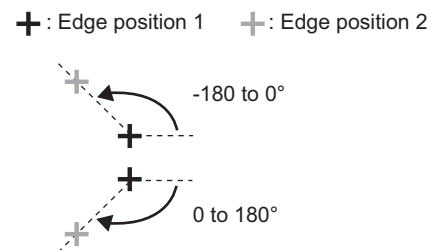

Another setting

Color mode	Filter mode (default) / Pickup mode This is same setting as position. (See the “Position”)
Measurement mode 1, 2	Average (default) / Peak / bottom This is same setting as position. (See the “Position”)
Split size 1, 2	1 to 99 (default value : 1) This is same setting as position. (See the “Position”)
Color 1, 2	Light --> Dark (default) / Dark --> Light This is same setting as position. (See the “Position”)
Edge level 1, 2	0 to 100 (%) (default value: 50) This is same setting as position. (See the “Position”)
Noise level 1, 2	0 to 255 (default value: 20) This is same setting as position. (See the “Position”)
Noise width 1, 2	0 to 255 (default value: 0) This is same setting as position. (See the “Position”)

4-11 ITEM Overview (Bright)

Use this item to measure the brightness of measurement targets. The density average and density deviation (brightness fluctuations) are output.

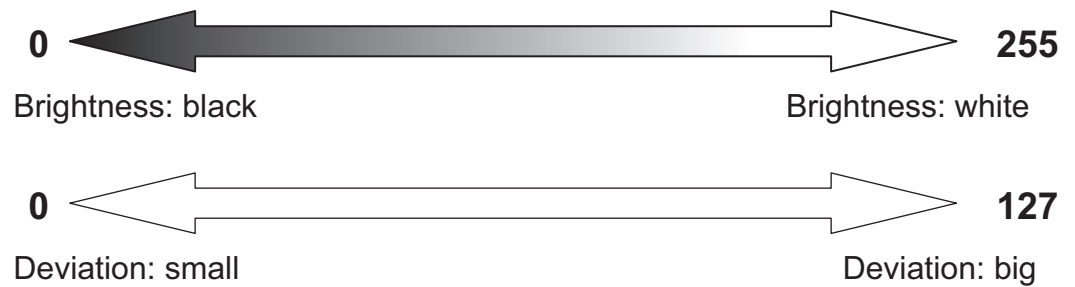
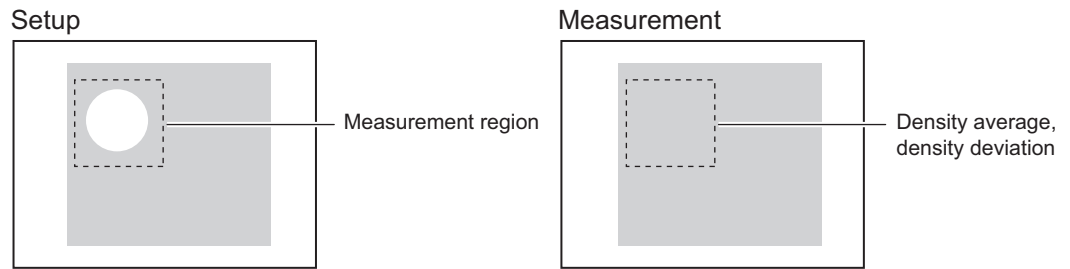

e.g.1



Deviation of both objects are 0.
The difference can be detected by brightness

e.g.2



White & Black

Just middle between white and black

Brightness of both objects are 127.5.
The difference can be detected by Deviation.

4-12 ITEM Overview (HUE)

Use this item to measure the color of measurement targets. The color has three parameters (hue, saturation, Value). Averages of three parameters and deviations (fluctuations) of three parameters are output. This item cannot be used when connecting a monochrome camera.

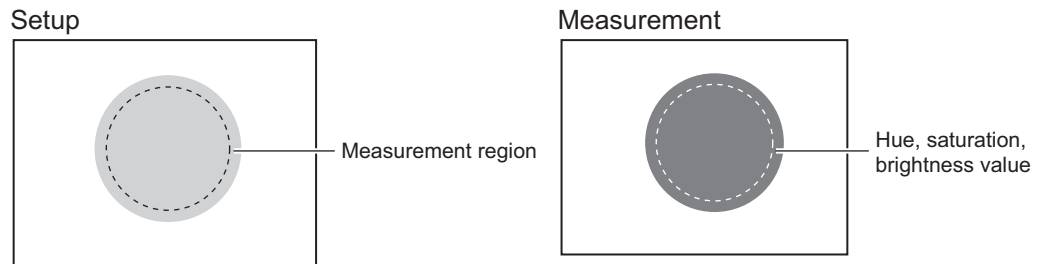

e.g.1

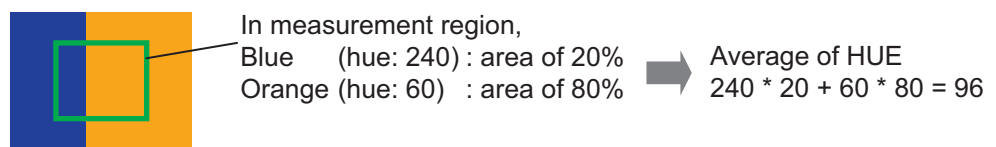

e.g. 2

	Passed object	Dirt	Color heterogeneity	Brightness heterogeneity
Average of hue	113	115	102	102
Average of saturation	44	45	44	40
Average of value	42	37	53	47
Deviation of hue	6	12	25	10
Deviation of saturation	3	4	10	5
Deviation of value	2	7	3	13

Measurement of deviation is stable without external noise. Therefore, it is possible to set the threshold if the difference between passed products and non-passed products is small.

Another setting

Deviation	ON (default) / OFF Select whether or not the deviation of hue, saturation and value are output.
-----------	--

4-13 ITEM Overview (Defect)

Use this item to detect dirt, scratching, chipping, burrs and other defects on the plain measurement target. The defect value and position of the defect which has highest defect value are output. And the number of defects are also output.

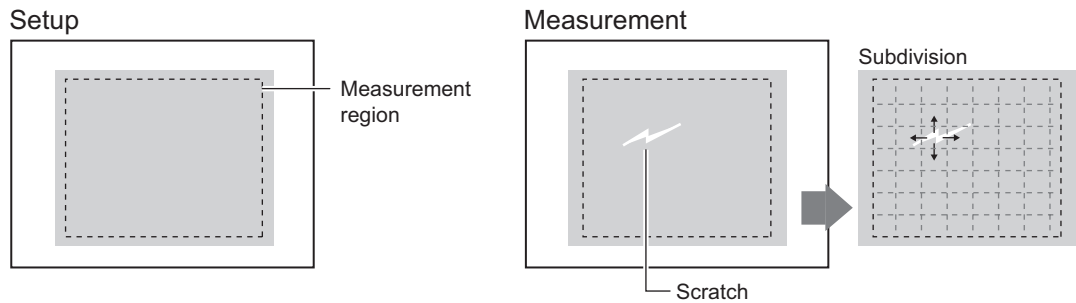

The measurement region is automatically subdivided into small sections to detect for changes in their respective brightness (density).

Number of defects

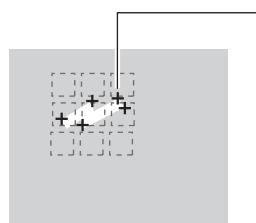

The extent of the defects is calculated in subdivided regions, and regions at or exceeding the defect threshold are output as the number of defects.

Even if you see only one defect on the screen, the number of defects is often more than one.

Measurement region

Line

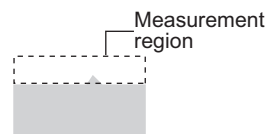

This is mainly for detecting the chipping and burrs. One straight line can be drawn.

Circum/Arc

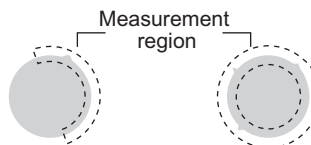

This is mainly for detecting the chipping and burrs on round shape object. One circumference or arc can be drawn.

Area

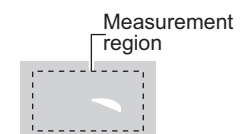

This is mainly for detecting the scratches and dirt. A combination of up to five shapes (rectangles, ellipse, circles, polygons) can be drawn.

Another setting

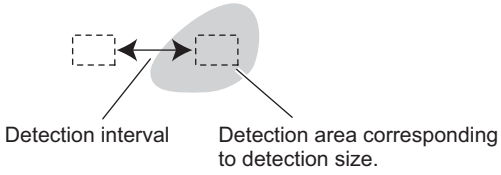
Detection size	<p>4 to 64 (default value: 8) 4 to 64 (default value: 8)</p> <p>Small detection areas corresponding to the detection size are created and the distance between each area is defined by the detection interval. The average density of each detection area is calculated, and then is compared with the surrounding average density.</p> <div style="text-align: center;">  </div>
Noise level	<p>0 to 255 (default value: 60)</p> <p>Set the level to be judged as noise. A defects whose defect value is lower than the noise level is removed as a noise.</p> <p>Set a higher value when noise is detected as a defect, or set a lower value when the defect cannot be detected.</p>

Note Guidelines for setting detection size and detection interval

• Detection size

Determine the detection size roughly according to the size of the defect to be detected.

Setting a smaller detection size results in stronger detection sensitivity, while setting a larger detection size results in weaker detection sensitivity.

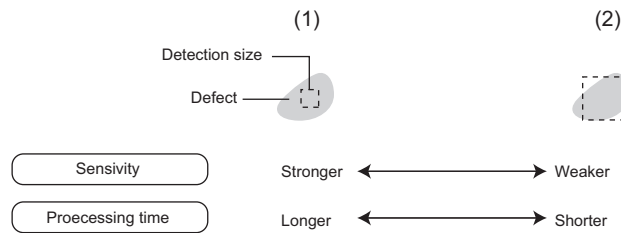

When a larger detection size is set, the difference with elements that are not defects decreases as the density of elements other than defects also is included in the calculation at (2). In other words, the more background that is included in the detection area, the weaker the detection sensitivity becomes.

• Detection interval

Determine the detection interval roughly according to the size of the defect and the detection size.

The larger the detection interval that is set, the shorter the processing time becomes.

When the detection area is greater than the defect, set a smaller detection interval.



When the defect is greater than the detection area, set a slightly larger detection interval.

When a small detection interval is set, elements overlapping the edge of the defect also are included in the comparison, and so the defect value decreases, which results in less stable detection of the defect.

4-14 ITEM Overview (Grouping)

Use this item to sort the products, for example on the line where many types of products are conveyed. Image patterns to be used as the reference (model) for sorting products can be registered. (Up to 64 indexes can be registered, and up to 4 models in each index can be registered.) After measurement, the followings can be output.

- The index No. that resembles the input image the most
- Correlation indicating how much input image resembles
- Position of the measurement object

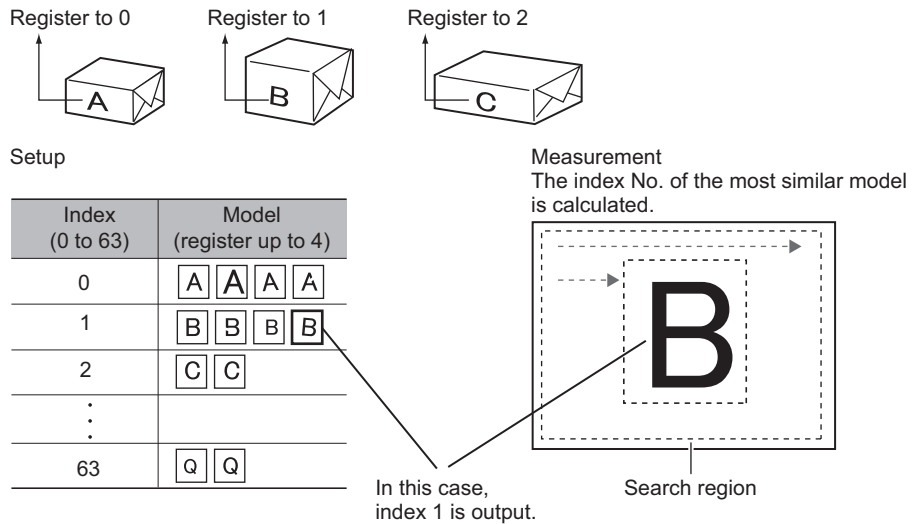

Another setting

Search mode	Hi-speed / Normal (default) / Precision This is same setting as pattern search. (See the "Pattern Search")
Verification	ON / OFF (default)
Candidate level	0 to 100 (default value: 60) This is same setting as pattern search. (See the "Pattern Search")

Edit

This item cannot do the rotation search.

5-1 What is decided by AUTO setting

AUTO setting in measurement Items

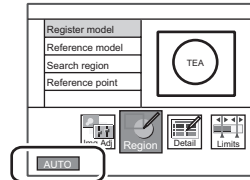

After drawing the region (*1), click the [AUTO].

The following settings are done.

(*1)

Model region: (Pattern Search / Sensitive Search / Graphic Search / Flexible Search / Grouping)

Measurement region: (Area / Labeling / Position / Width / Count / Angle / Bright / Hue / Defect)

Setting	Available Item	Description
Color filter	Pattern Search Sensitive Search Graphic Search Flexible Search Position Width Count Angle Bright Defect Grouping	The image (*2) is analyzed. And then, the best filter is selected.
Model Image	Pattern Search Sensitive Search Flexible Search	After the color filter is automatically selected, the image is registered as the model. If the model region is changed after AUTO setting, the model is updated but the color filter isn't updated.
Threshold	Area Labeling Position Width Count Angle Bright HUE	The threshold values are automatically set.
Edge search color	Position Width Count Angle	The edge search color (direction of the destiny change) in detail setting is automatically set.
Reference value	All items	The measurement value of the current displayed image is registered as the reference value. If the region (*2) is changed, the reference value is updated.

(*2)

Model region: (Pattern Search / Sensitive Search / Graphic Search / Flexible Search / Grouping)

Measurement region: (Area / Labeling / Position / Width / Count/ Angle / Bright / Hue / Defect)

5-2 BANK and BANK-Group

The basic knowledge of BANK and BANK-Group

What is BANK?

BANK has the following setting data.

- **Camera**
[Shutter Speed / Light Control (In case of using intelligent camera / Calibration / etc)]
- **Measurement Item**
[C1*: up to 32 items, C2*: up to 128 items]
- **Position Correction**
- **Additional Function**
[Calculation / Logging Monitor (only ZFX-C2*) / OR setting]

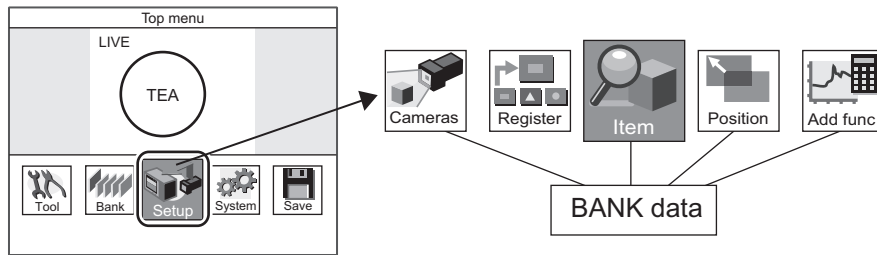

What is BANK-Group?

BANK-Group can have up to 32 BANKs.

- ZFX-C controller can have one BANK-Group, if not using SD-card.
- ZFX-C controller can have up to 32 BANK-Groups, if using SD-card.

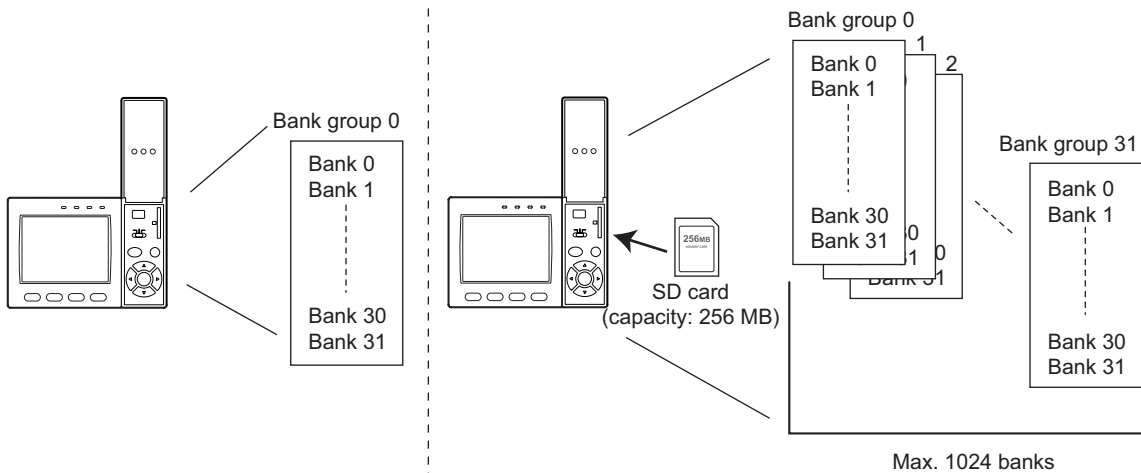

Bank group 0: Data is saved on internal flash memory.
Bank groups 1 to 31: Data is saved on SD card.

Which BANK/BANK-Group should be set, just after start-up?

They can be set in the following menu.

MENU mode - [System] - [Startup]

Setup Item	Description
Startup Bank Group	Sets the bank group No. to be displayed when the Controller is started up. (default value: 0) When bank groups 1 to 31 are selected, start up the Controller with the SD card containing the corresponding bank data attached.
Startup Bank	Sets the bank No. to be displayed when the Controller is started up. Range: 0 to 31 (default value: 0)

How to switch BANK/BANK-Group

1. Manu Operation
 - BANK Menu-mode - [Bank] - [Bank] - [Switch]
 - BANK-Group Menu-mode - [Bank] - [Bank Group] - [Switch]
2. Serial Command via RS-232C/422, USB, Ethernet (*1)
3. Parallel Command
 - It's needed to send the command from external device (e.g. PLC)
 - Please see the detail in "User's manual"

How to upload BANK/BANK-Group

1. Upload BANK 0-31 (BANK-Group 0-31) to ZFX from SD card
 - a) Manu Operation
 - BANK Menu-mode - [Tool] - [Backup] - [Bank data] - [Load]
 - BANK-Group Menu-mode - [Tool] - [Backup] - [Bank Group data] - [Load]
 - b) Serial Command via RS-232C/422, USB, Ethernet (*1)
2. Upload BANK 0-31 (BANK-Group 0-31) to ZFX from External device (e.g. PC, PLC)
 - a) Serial Command via RS-232C/422, USB, Ethernet (*1)

How to back up BANK/BANK-Group

1. Back up BANK 0-31 (BANK-Group 0-31) to SD card from ZFX
 - a) Manu Operation
 - BANK Menu-mode - [Tool] - [Backup] - [Bank data] - [Save]
 - BANK-Group Menu-mode - [Tool] - [Backup] - [Bank Group data] - [Save]
 - b) Serial Command via RS-232C/422, USB, Ethernet (*1)
2. Back up BANK 0-31 (BANK-Group 0-31) to External device (e.g. PC, PLC) from ZFX
 - a) Serial Command via RS-232C/422, USB, Ethernet (*1)

Note (*1) It's needed to send the command from external device (e.g. PC, PLC)
Please see the detail in "Serial Communication Command Reference"

Revision History

A manual revision code appears as a suffix to the catalog number on the front cover of the manual.

Cat. No. Z01E-EN-01

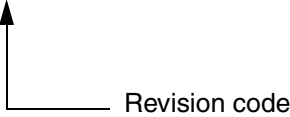

The following table outlines the changes made to the manual during each revision. Page numbers refer to the previous version.

Revision code	Date	Revised content
01	January 2008	Original production