

Digital Indicators K3HB Series (Pulse Input Series)

The K3HB Series has been made complete with the addition of Digital Signal Input Models.

- Easy recognition of judgment results using two-color display that can be switched between red and green.
- Equipped with a position meter for monitoring operating status trends.
- External event inputs allows using various measurement and discrimination applications.
- Series expanded to include DeviceNet models.
- Short body with depth of only 95 mm (see note) (from behind the front panel).
- UL certification (Certification Mark License).
- CE Marking conformance by third party assessment body.
- Water-resistant enclosure conforms to NEMA 4X (equivalent to IP66).

Note: Depth of 97 mm for DeviceNet models.

 Refer to *Common Precautions* on page 30.



Features

Red-Green Display Allows Easy Recognition of Judgment Results

The measurement value display can be set to switch between red and green in accordance with the status of comparative outputs. This means that the status can be easily seen at a distance.

Position Meter Enables Easy Monitoring of Operating Status Trends

The present value with respect to the measurement or display range (full scale) can be viewed on a bar display. The operating status can be grasped intuitively, allowing easy judgment of levels and threshold values.

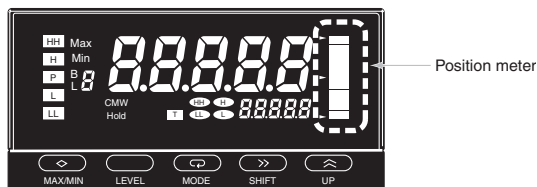

Note: This function is different from the single-LED display of the K3HB-C.

Short Body with Depth of Only 95 mm (from Behind the Front Panel)

A short body of only 95 mm (see note) contributes to the development of slimmer and smaller control panels and installations.

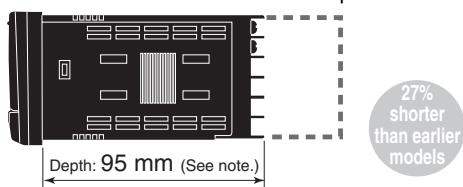

(The depth is 100 mm when mounted to the terminal cover.)

Note: Depth of DeviceNet models is 97 mm.

50 kHz High-speed Pulse Measurement (K3HB-R)

Supports high-speed pulse measurement (up to 50 kHz) of rotary encoders or any ON/OFF pulse signal, which enables rotational measurement of objects rotating at high speeds.



Note: No-voltage contacts of up to 30 Hz are supported.

Measurement of Wide Range of Pulse Interval Times (K3HB-P)

Measures and displays the results of the pulse interval between two points. The pulse interval measurement range is broad, from 10 ms to 3,200 s.

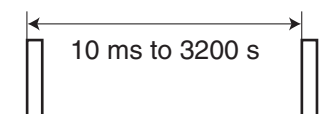

High-speed Up/Down Counting Pulse Measurement (K3HB-C)

Perfect for high-speed measurement of rotary encoders or any ON/OFF pulse signals. Cumulative pulse input is 50 kHz, quadrature pulse inputs are 25 kHz, and up/down pulse inputs are 30 kHz.

Note: No-voltage contacts of up to 30 Hz are supported.

Features

Many I/O Variations for Discrimination, Control, and Information Applications

Digital Indicators are used in a wide variety of applications, from an electronic measurement value display or equipment/device operating status display to a host communications interface in monitoring and control systems. OMRON provides a complete lineup for a variety of input and control output applications to meet all your application requirements.

Relay Outputs



H and L: SPDT

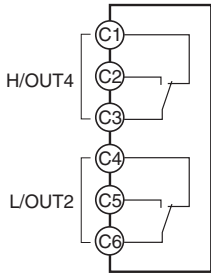

HH, H, L, and LL: SPST-NO

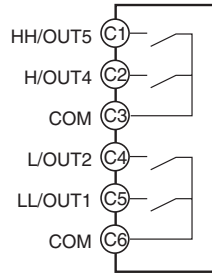

PASS: SPDT

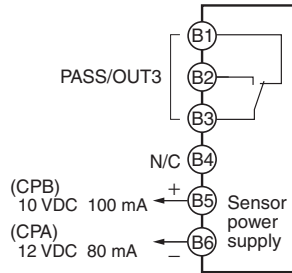

Transistor Outputs



NPN or PNP

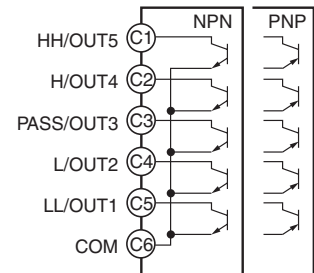

Communications Output

RS-232 or RS-485

RS-232C or RS-485

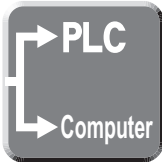

Linear Output

Voltage Output or Current Output

0 to 20 mA DC/
4 to 20 mA DC
or
0 to 5 VDC/
1 to 5 VDC/
0 to 10 VDC



DeviceNet



BCD Output

NPN Open Collector



Select a Comparative Output Pattern to Suit the Discrimination or Control Application

- The output pattern for comparative outputs can be selected. In addition to high/low comparison with set values, output based on level changes is also possible. (Use the type of output pattern appropriate for the application.)

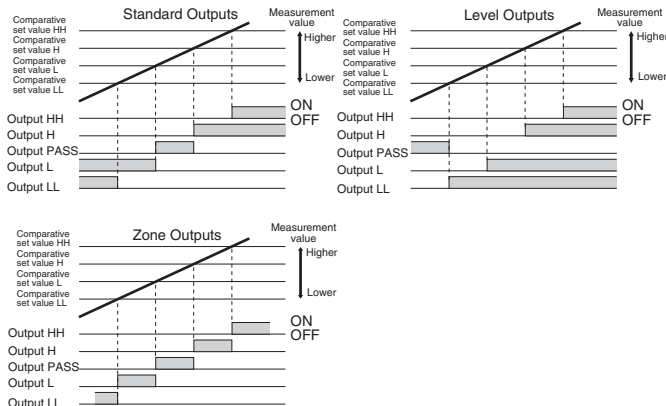

Note: The HH, H, L or LL outputs must be set in that order for the zone outputs to output correctly. (This is because the comparative set values and outputs for standard and level outputs are in a 1-to-1 relationship, whereas the meaning of zone outputs depends on the settings of all the comparative set values.)

Lineup Includes DeviceNet Models Enabling High-speed Data Communications with PLCs without Special Programming

- DeviceNet compliance enables high-speed data transmission by allocating setting and monitoring parameters in the I/O memory of the PLC. This capability greatly reduces labor spent in developing communications programs.

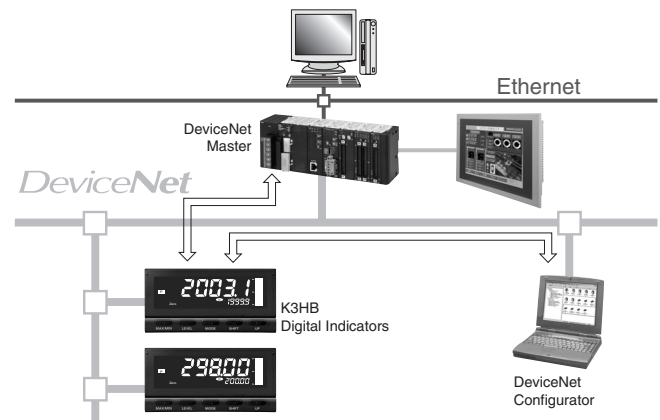

Note: The applications provided in this catalog are intended as reference only. Do not attempt to use any of them in real systems without first confirming machine and device functions and safety. For applications that require safety, ensure that there is sufficient leeway in ratings and performances, install fail-safe measures, and take any other safety measures required by the application. In addition, contact your nearest OMRON representative and confirm specifications.

K3HB-series Product Lineup

■ K3HB-R Rotary Pulse Indicator (Page 4)

Performs High-speed Rotation Measurement and Passing Time Measurement Displaying Bread Baking Time

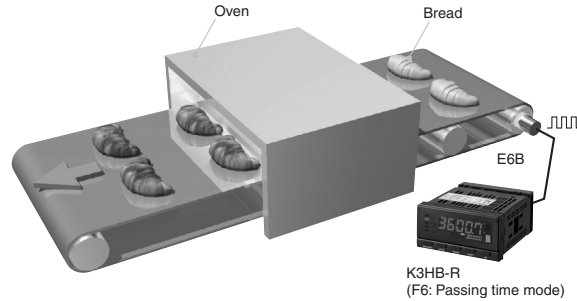

Rotary Pulse Input Model: K3HB-R

K3HB-RNB: NPN input/voltage pulse input
K3HB-RPB: PNP input

- Input types: rpm/circumferential speed, absolute ratio, error ratio, error, concentration, and passing time
- Measurement range: 0.5 mHz to 50 kHz

■ K3HB-P Time Interval Indicator (Page 10)

Measuring Passing Speed between Two Points and Providing Time Judgments Measuring Shot Speed

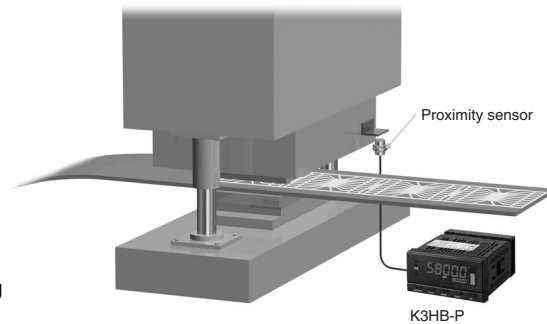

Pulse Input Model: K3HB-P

K3HB-PNB: NPN input/voltage pulse input
K3HB-PPB: PNP input

- Inputs: Passing speed, cycle, time difference, time band, measuring length, interval
- Measurement ranges: Functions F1, F3, and F4: 10 ms to 3200 s
Function F2: 20 ms to 3200 s
Functions F5 and F6: 0 to 4 gigacounts

■ K3HB-C Up/Down Counting Pulse Indicator (Page 15)

Measuring and Monitoring High-speed Up/Down Pulses Counting Workpieces

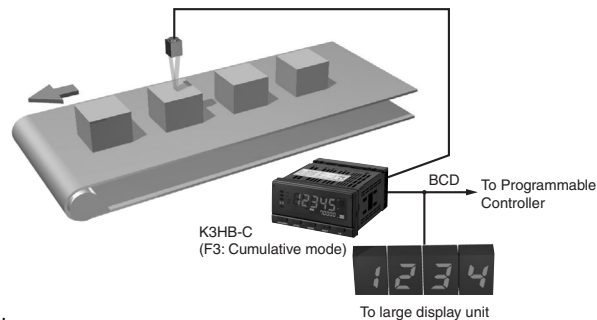

Up/down Counting Pulse Input Model: K3HB-C

K3HB-CNB: NPN input/voltage pulse input

- Inputs: Individual inputs (up/down), quadrature inputs (up/down), cumulative input
- Response frequency: Individual inputs: 30 kHz, quadrature inputs: 25 kHz, cumulative input: 50 kHz

Note: No-voltage contacts of up to 30 Hz are supported.

- Measurement ranges: Functions F1 and F2: ±2 gigacounts
Function F3: 0 to 4 gigacounts

Rotary Pulse Indicator K3HB-R

Digital Rotary Pulse Meter Capable of 50 kHz Measurements

- Measures High-speed Pulses at 50 kHz.
Provides high-speed pulse measurements up to 50 kHz of rotary encoder or ON/OFF pulse signals and can perform rotating measurement of high-speed rotating objects.

Note: No-voltage contacts of up to 30 Hz are supported.

- Six Measurement Operations Including Rotation (rpm)/ Circumferential Speed, Ratio, and Cumulative
One Rotary Pulse Meter has 6 rotary pulse measurement functions to support a variety of pulse measurement applications. Select the best function for your application from the following: rotation (rpm)/ circumferential speed, absolute ratio, error ratio, error, flow rate ratio, and passing time.



 Refer to *Common Precautions* on page 30.

Model Number Structure

Model Number Legend

Base Units and Optional Boards can be ordered individually or as sets.

Base Units

K3HB-R
1 5

1. Input Sensor Codes

NB: NPN input/voltage pulse input
PB: PNP input

5. Supply Voltage

100-240 VAC: 100 to 240 VAC
24 VAC/VDC: 24 VAC/VDC

Optional Board

Sensor Power Supply/Output Boards

K33-
2

Relay/Transistor Output Boards

K34-
3

Event Input Boards

K35-
4

Base Units with Optional Boards

K3HB-R -
1 2 3 4 5

2. Sensor Power Supply/Output Type Codes

- None: None
CPA: Relay output (PASS: SPDT) + Sensor power supply (12 VDC±10%, 80 mA) (See note 1.)
L1A: Linear current output (DC0(4)-20 mA) + Sensor power supply (12 VDC±10%, 80 mA) (See note 2.)
L2A: Linear voltage output (DC0(1)-5 V, 0 to 10 V) + Sensor power supply (12 VDC±10%, 80 mA) (See note 2.)
A: Sensor power supply (12 VDC ±10%, 80 mA)
FLK1A: Communications (RS-232C) + Sensor power supply (12 VDC±10%, 80 mA) (See note 2.)
FLK3A: Communications (RS-485) + Sensor power supply (12 VDC±10%, 80 mA) (See note 2.)

3. Relay/Transistor Output Type Codes

- None: None
C1: Relay contact (H/L: SPDT each)
C2: Relay contact (HH/H/LL/L: SPST-NO each)
T1: Transistor (NPN open collector: HH/H/PASS/L/LL)
T2: Transistor (PNP open collector: HH/H/PASS/L/LL)
BCD: BCD output + transistor output (NPN open collector: HH/H/PASS/L/LL)
DRT: DeviceNet (See note 2.)

4. Event input Type Codes

- None: None
1: 5 points (M3 terminal blocks) NPN open collector
2: 8 points (10-pin MIL connector) NPN open collector
3: 5 points (M3 terminal blocks) PNP open collector
4: 8 points (10-pin MIL connector) PNP open collector

Note: 1. CPA can be combined with relay outputs only.

2. Only one of the following can be used by each Digital Indicator:
RS-232C/RS-485 communications, BCD communications, or DeviceNet communications.

Accessories (Sold Separately)

K32-DICN: Special Cable (for event inputs with 8-pin connector)
K32-BCD: Special BCD Output Cable

Specifications

■ Ratings

Supply voltage		100 to 240 VAC, 24 VAC/VDC, DeviceNet power supply: 24 VDC
Allowable power supply voltage range		85% to 110% of the rated power supply voltage, DeviceNet power supply: 11 to 25 VDC
Power consumption (See note 1.)		100 to 240 VAC: 18 VA max. (max. load) 24 VAC/DC: 11 VA/7 W max. (max. load)
Current consumption		DeviceNet power supply: 50 mA max. (24 VDC)
Input		No-voltage contact, voltage pulse, open collector
External power supply		12 VDC ±10%, 80 mA (models with external power supply only)
Event inputs (See note 2.)	Startup compensation timer input	NPN open collector or no-voltage contact signal ON residual voltage: 2 V max.
	Hold input	ON current at 0 Ω: 4 mA max.
	Reset input	Max. applied voltage: 30 VDC max.
	Bank input	OFF leakage current: 0.1 mA max.
Output ratings (depends on the model)	Relay output	250 VAC, 30 VDC, 5 A (resistive load) Mechanical life expectancy: 5,000,000 operations, Electrical life expectancy: 100,000 operations
	Transistor output	Maximum load voltage: 24 VDC, Maximum load current: 50 mA, Leakage current: 100 μA max.
	Linear output	Linear output 0 to 20 mA DC, 4 to 20 mA: Load: 500 Ω max, Resolution: Approx. 10,000, Output error: ±0.5% FS Linear output 0 to 5 VDC, 1 to 5 VDC, 0 to 10 VDC: Load: 5 kΩ max, Resolution: Approx. 10,000, Output error: ±0.5% FS (1 V or less: ±0.15 V; not output for 0 V or less)
Display method		Negative LCD (backlit LED) display 7-segment digital display (Character height: PV: 14.2 mm (green/red); SV: 4.9 mm (green))
Main functions		Scaling function, measurement operation selection, averaging, previous average value comparison, output hysteresis, output OFF delay, output test, teaching, display value selection, display color selection, key protection, bank selection, display refresh period, maximum/minimum hold, reset
Ambient operating temperature		-10 to 55°C (with no icing or condensation)
Ambient operating humidity		25% to 85%
Storage temperature		-25 to 65°C (with no icing or condensation)
Altitude		2,000 m max.
Accessories		Watertight packing, 2 fixtures, terminal cover, unit stickers, instruction manual. DeviceNet models also include a DeviceNet connector (Hirose HR31-5.08P-5SC(01)) and crimp terminals (Hirose HR31-SC-121) (See note 3.)

- Note:**
- DC power supply models require a control power supply capacity of approximately 1 A per Unit when power is turned ON. Particular attention is required when using two or more DC power supply models. The OMRON S8VS-series DC Power Supply Unit is recommended.
 - PNP input types are also available.
 - For K3HB-series DeviceNet models, use only the DeviceNet Connector included with the product. The crimp terminals provided are for Thin Cables.

■ Characteristics

Display range	-19,999 to 99,999	
Measurement accuracy (at 23±5°C)	Functions F1, F6: ±0.006% rgd ±1 digit (for voltage pulse/open collector sensors) Functions F2 to F5: ±0.02% rgd ±1 digit (for voltage pulse/open collector sensors)	
Measurement range	Functions F1 to F6: 0.5 mHz to 50 kHz (for voltage pulse/open collector sensors)	
Input signals	No-voltage contact (30-Hz max. with ON/OFF pulse width of 15 ms min.) Voltage pulse (50-KHz max. with ON/OFF pulse width of 9 µs min.; ON voltage: 4.5 to 30 V; OFF voltage: -30 to 2 V; input impedance: 10 kΩ) Open collector (50-KHz max. with ON/OFF pulse width of 9 µs min.)	
Connectable sensors	ON residual voltage: 3 V max. OFF leakage current: 1.5 mA max. Load current: Must have a switching capacity of 20 mA or higher. Must be able to properly switch load currents of 5 mA or less.	
Comparative output response time (transistor output)	Functions F1 to F6: 100 ms max. (time until the comparative output is made when there is a forced sudden change in the input signal from 15% to 95% or 95% to 15%.)	
Linear output response time	Functions F1 to F6: 110 ms max. (time until the final analog output value is reached when there is a forced sudden change in the input signal from 15% to 95% or 95% to 15%.)	
Insulation resistance	20 MΩ min. (at 500 VDC)	
Dielectric strength	2,300 VAC for 1 min between external terminals and case	
Noise immunity	100 to 240 VAC models: ±1,500 V at power supply terminals in normal or common mode (waveform with 1-ns rising edge and pulse width of 1 µs/100 ns) 24 VAC/VDC models: ±1,500 V at power supply terminals in normal or common mode (waveform with 1-ns rising edge and pulse width of 1 µs/100 ns)	
Vibration resistance	Frequency: 10 to 55 Hz; Acceleration: 50 m/s ² , 10 sweeps of 5 min each in X, Y, and Z directions	
Shock resistance	150 m/s ² (100 m/s ² for relay outputs) 3 times each in 3 axes, 6 directions	
Weight	Approx. 300 g (Base Unit only)	
Degree of protection	Front panel	Conforms to NEMA 4X for indoor use (equivalent to IP66)
	Rear case	IP20
	Terminals	IP00 + finger protection (VDE0106/100)
Memory protection	EEPROM (non-volatile memory) Number of rewrites: 100,000	
Applicable standards	UL61010C-1, CSA C22.2 No. 1010.1 (evaluated by UL) EN61010-1 (IEC61010-1): Pollution degree 2/Overvoltage category II EN61326: 1997, A1: 1998, A2: 2001	
EMC	EMI: EN61326+A1 industrial applications Electromagnetic radiation interference CISPR 11 Group 1, Class A: CISPRL16-1/-2 Terminal interference voltage CISPR 11 Group 1, Class A: CISPRL16-1/-2 EMS: EN61326+A1 industrial applications Electrostatic Discharge Immunity EN61000-4-2: 4 kV (contact), 8 kV (in air) Radiated Electromagnetic Field Immunity EN61000-4-3: 10 V/m 1 kHz sine wave amplitude modulation (80 MHz to 1 GHz, 1.4 to 2 GHz) Electrical Fast Transient/Burst Immunity EN61000-4-4: 2 kV (power line), 1 kV (I/O signal line) Surge Immunity EN61000-4-5: 1 kV with line (power line), 2 kV with ground (power line) Conducted Disturbance Immunity EN61000-4-6: 3 V (0.15 to 80 MHz) Power Frequency Magnetic Immunity EN61000-4-8: 30 A/m (50 Hz) continuous time Voltage Dips and Interruptions Immunity EN61000-4-11: 0.5 cycle, 0°/180°, 100% (rated voltage)	

Operation

■ Functions (Operating Modes)

F1 to F6

Functions F1 to F6 provide rpm/circumferential speed and other calculation displays by measuring continuous pulses (frequencies).

Example

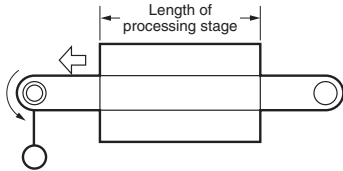

F1: Displays rotation (rpm) or circumferential speed for one input.

F2 to F5: Displays the calculation result for two rotation (rpm) speeds.

F6: Displays the passing time calculated from the circumferential speed and the length of the processing stage for one input.

The basic principle used by the Digital Indicator to calculate the rotation speed (rpm) display is to count the ON/OFF time (T) for input sensor or other device inputs using the internal system clock, and then automatically calculate the frequency. This frequency (f) is multiplied by 60 and displayed as the rotation (rpm) speed.

Input sensor or other input pulse ON/OFF time (T) =  Frequency (f) = $\frac{1}{T}$

Function name	Function No.
Rpm/circumferential speed	F1
Absolute ratio	F2
Error ratio	F3
Rotational difference	F4
Flow rate ratio	F5
Passing time	F6

- Rotation speed (rpm) = $f \times 60$
- Circumferential speed = Roll circumference \times Rotation speed (rpm)
- Passing time = $\frac{\text{Length of processing stage}}{\text{Circumferential speed}}$

These calculations are automatically made internally and displayed whenever any input pulse is received.

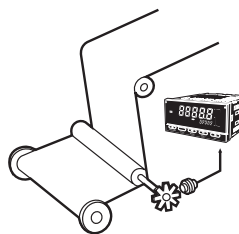
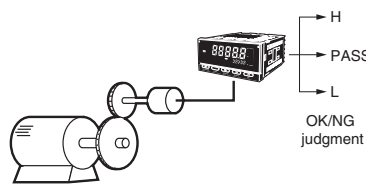
Function	Operation	Operation image (application)																											
F1 Rpm/circumferential speed/ Instantaneous flowrate	Measures frequency for input A and displays the rotation (rpm) or circumferential speed proportional to the input frequency.	<div style="display: flex; justify-content: space-around;"> <div style="text-align: center;"> <p>Measuring roller winding speed</p>  </div> <div style="text-align: center;"> <p>Measuring motor speed (for product testing)</p>  </div> </div>																											
	<table border="1"> <thead> <tr> <th>Calculation</th> <th>Display unit</th> <th>Prescale value (α)</th> </tr> </thead> <tbody> <tr> <td rowspan="2">Rotation speed</td> <td>rpm</td> <td>1/N</td> </tr> <tr> <td>rps</td> <td>1/60 N</td> </tr> <tr> <td rowspan="2">Frequency (of input pulse)</td> <td>Hz</td> <td>1/60</td> </tr> <tr> <td>kHz</td> <td>1/60000</td> </tr> <tr> <td rowspan="5">Circumferential speed</td> <td>mm/s</td> <td>$1000 \pi d / 60 N$</td> </tr> <tr> <td>cm/s</td> <td>$100 \pi d / 60 N$</td> </tr> <tr> <td>m/s</td> <td>$\pi d / 60 N$</td> </tr> <tr> <td>m/min</td> <td>$\pi d / N$</td> </tr> <tr> <td>km/h</td> <td>$0.06 \pi d / N$</td> </tr> <tr> <td rowspan="2">Instantaneous flowrate</td> <td>l/min</td> <td rowspan="2">Check the output specifications of the input device and calculate the prescale value from the following equation: Display value $D = f a \times 60 \times \alpha$</td> </tr> <tr> <td>l/h</td> </tr> </tbody> </table>		Calculation	Display unit	Prescale value (α)	Rotation speed	rpm	1/N	rps	1/60 N	Frequency (of input pulse)	Hz	1/60	kHz	1/60000	Circumferential speed	mm/s	$1000 \pi d / 60 N$	cm/s	$100 \pi d / 60 N$	m/s	$\pi d / 60 N$	m/min	$\pi d / N$	km/h	$0.06 \pi d / N$	Instantaneous flowrate	l/min	Check the output specifications of the input device and calculate the prescale value from the following equation: Display value $D = f a \times 60 \times \alpha$
	Calculation	Display unit	Prescale value (α)																										
	Rotation speed	rpm	1/N																										
		rps	1/60 N																										
	Frequency (of input pulse)	Hz	1/60																										
		kHz	1/60000																										
	Circumferential speed	mm/s	$1000 \pi d / 60 N$																										
		cm/s	$100 \pi d / 60 N$																										
		m/s	$\pi d / 60 N$																										
m/min		$\pi d / N$																											
km/h		$0.06 \pi d / N$																											
Instantaneous flowrate	l/min	Check the output specifications of the input device and calculate the prescale value from the following equation: Display value $D = f a \times 60 \times \alpha$																											
	l/h																												
<p>N = Pulses per rotation πd = Circumferential length per rotation</p>																													

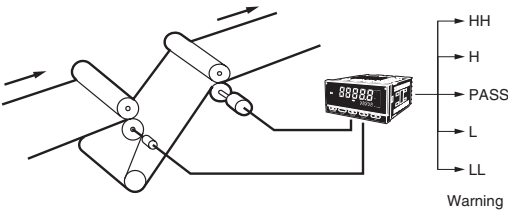
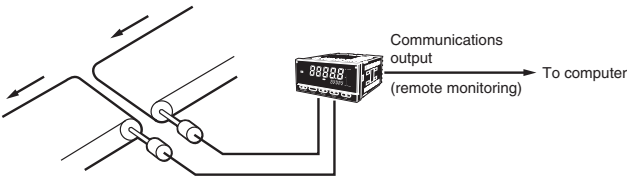
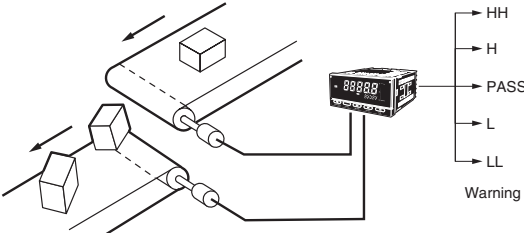
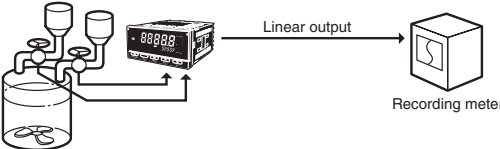
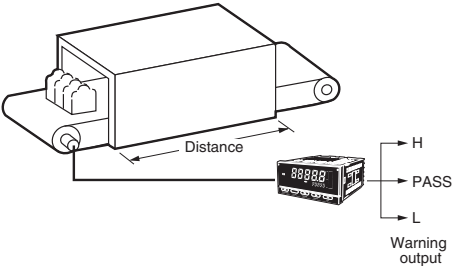
Function	Operation	Operation image (application)						
F2 Absolute ratio	Multiplies input B divided by input A ($\frac{B}{A}$) by 100 and displays the ratio as a percentage (%). Display unit: %	Measuring the speed ratio between two rollers 						
F3 Error ratio	Multiplies the error between input A and input B ($\frac{B}{A} - 1$) by 100 and displays the ratio as a percentage (%). Display unit: %	Measuring the line speed error ratio between two conveyors 						
F4 Rotational difference	Displays the difference between input A and input B (B - A) as the rotation (rpm) speed error or circumferential speed error. (Display unit: rpm, rps, rph, Hz, kHz, mm/s, m/s m/min, km/h l/min, l/h, etc.)	Measuring the rotation (rpm)/circumferential speed error (absolute error) between two conveyors 						
F5 Flow rate ratio	Displays the flow rate ratio of B from inputs A and B ($\frac{B}{A+B}$) as a ratio (%). Display unit: %	Monitoring liquid mixture flow rate ratio 						
F6 Passing time	Passing time (s) = $1/f_a \times \alpha$ f_a : Input frequency (Hz) Set the prescale value for the desired display unit using the following table for reference. <table border="1" data-bbox="223 1489 726 1564"> <thead> <tr> <th>Calculation</th> <th>Display unit</th> <th>Prescale value (α)</th> </tr> </thead> <tbody> <tr> <td>Passing time</td> <td>s</td> <td>$L/(\pi d/N)$</td> </tr> </tbody> </table> N = Pulses per rotation πd = Circumferential length per rotation (m) L = Length of process (m)	Calculation	Display unit	Prescale value (α)	Passing time	s	$L/(\pi d/N)$	Displaying the passing time for a conveyor line 
Calculation	Display unit	Prescale value (α)						
Passing time	s	$L/(\pi d/N)$						

■ What Is Prescaling?

To make calculations using the input pulse to display rotation (rpm) or circumferential speed, the number of pulses per rotation or the length of the circumference must be multiplied by a certain coefficient. This coefficient is called the prescale value.

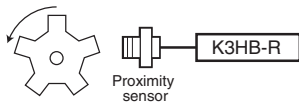

$$\text{Rotation speed (rpm)} = f \times 60 \times a$$

f: Input pulse frequency (No. of pulses per second)

a: Prescale value

If there are 5 pulses per rotation, then

$$a = 1/5 (= 0.2 = 2 \times 10^{-1})$$

and an accurate rotation speed (rpm) can be calculated.

The actual setting is X = 2.0000 (mantissa) and Y = 10⁻¹ (exponent).

■ What Is the Auto-zero Function?

(Set this function before using the Digital Indicator.)

If a function $F \bar{1}$ to $F \bar{5}$ is set, the frequency can be force-set to zero if there is no input pulse for a set period. This period is called the auto-zero time. Set the auto-zero time to slightly longer than the longest input pulse interval. (The display will not easily return to zero if the auto-zero time is too long or left at the default setting.)

Time Unit Settings

Setting	Meaning
$\bar{5} \bar{R} \bar{L}$	Prescale value menu setting
$\bar{n} \bar{L} \bar{n}$	Minute display
$\bar{H} \bar{n} \bar{n} \bar{.} \bar{S} \bar{S}$	h.mm.ss display
$\bar{n} \bar{n} \bar{.} \bar{S} \bar{S} \bar{.} \bar{d}$	mm.ss.d display (d = tenths of a second)

Note: Time unit can be set only when passing time (F6) is selected.

Input Type Setting

	NO: Voltage pulse high	NC: Voltage pulse low
No-contact or voltage pulse input	$\bar{0} \bar{0}$	$\bar{0} \bar{1}$
Contact	$\bar{1} \bar{0}$	$\bar{1} \bar{1}$

Note: Set to $\bar{1} \bar{0}$ or $\bar{1} \bar{1}$ when there is a large variation in the display. The largest measurement range is 30 Hz.

Timer Interval Indicator K3HB-P

Digital Time Interval Meter for Measuring Passing Speed, Time, or Cycle between Two Points.

- Measures Wide Range of Pulse Interval Times
Measures, calculates, and displays pulse intervals between two points. Wide range for pulse interval measurements, from 10 ms to 3,200 s, max.
- Six Measurement Operations, Including Passing Speed, Time, and Cycle Measurement between Two Points
One Digital Time Interval Meter has six measurement functions, to support a variety of pulse interval measurement applications. Select the best function for your application from the following: Passing speed, cycle, time difference, time band, measuring length, and interval.



Refer to *Common Precautions* on page 30.

Model Number Structure

Model Number Legend

Base Units and Optional Boards can be ordered individually or as sets.

Base Units

K3HB-P
1 5

- Input Sensor Codes**
NB: NPN input/voltage pulse input
PB: PNP input
- Supply Voltage**
100-240 VAC: 100 to 240 VAC
24 VAC/VDC: 24 VAC/VDC

Optional Board

Sensor Power Supply/Output Boards

K33-
2

Relay/Transistor Output Boards

K34-
3

Event Input Boards

K35-
4

Base Units with Optional Boards

K3HB-P-
1 2 3 4 5

- Sensor Power Supply/Output Type Codes**
None: None
CPA: Relay output (PASS: SPDT) + Sensor power supply (12 VDC±10%, 80 mA) (See note 1.)
L1A: Linear current output (DC0(4)-20 mA) + Sensor power supply (12 VDC±10%, 80 mA) (See note 2.)
L2A: Linear voltage output (DC0(1)-5 V, 0 to 10 V) + Sensor power supply (12 VDC±10%, 80 mA) (See note 2.)
A: Sensor power supply (12 VDC ±10%, 80 mA)
FLK1A: Communications (RS-232C) + Sensor power supply (12 VDC±10%, 80 mA) (See note 2.)
FLK3A: Communications (RS-485) + Sensor power supply (12 VDC±10%, 80 mA) (See note 2.)
- Relay/Transistor Output Type Codes**
None: None
C1: Relay contact (H/L: SPDT each)
C2: Relay contact (HH/H/LL/L: SPST-NO each)
T1: Transistor (NPN open collector: HH/H/PASS/L/LL)
T2: Transistor (PNP open collector: HH/H/PASS/L/LL)
BCD: BCD output + transistor output (NPN open collector: HH/H/PASS/L/LL)
DRT: DeviceNet (See note 2.)
- Event input Type Codes**
None: None
1: 5 points (M3 terminal blocks) NPN open collector
2: 8 points (10-pin MIL connector) NPN open collector
3: 5 points (M3 terminal blocks) PNP open collector
4: 8 points (10-pin MIL connector) PNP open collector

Note: 1. CPA can be combined with relay outputs only.
2. Only one of the following can be used by each Digital Indicator:
RS-232C/RS-485 communications, a linear output, or DeviceNet communications.

Accessories (Sold Separately)

- K32-DICN: Special Cable (for event inputs with 8-pin connector)
- K32-BCD: Special BCD Output Cable

Specifications

■ Ratings

Supply voltage		100 to 240 VAC, 24 VAC/VDC, DeviceNet power supply: 24 VDC
Allowable power supply voltage range		85% to 110% of the rated power supply voltage, DeviceNet power supply: 11 to 25 VDC
Power consumption (See note 1.)		100 to 240 VAC: 18 VA max. (max. load) 24 VAC/DC: 11 VA/7 W max. (max. load)
Current consumption		DeviceNet power supply: 50 mA max. (24 VDC)
Input		No-voltage, voltage pulse, open collector
External power supply		12 VDC 10%, 80 mA (for models with external power supplies only)
Event inputs (See note 2.)	Hold input	NPN open collector or no-voltage contact signal
	Reset input	ON residual voltage: 2 V max. ON current at 0 Ω: 4 mA max.
	Bank input	Max. applied voltage: 30 VDC max. OFF leakage current: 0.1 mA max.
Output ratings (depends on the model)	Relay output	250 VAC, 30 VDC, 5 A (resistive load) Mechanical life expectancy: 5,000,000 operations, Electrical life expectancy: 100,000 operations
	Transistor output	Maximum load voltage: 24 VDC, Maximum load current: 50 mA, Leakage current: 100 μA max.
	Linear output	Linear output 0 to 20 mA DC, 4 to 20 mA: Load: 500 Ω max, Resolution: Approx. 10,000, Output error: ±0.5% FS Linear output 0 to 5 VDC, 1 to 5 VDC, 0 to 10 VDC: Load: 5 kΩ max, Resolution: Approx. 10,000, Output error: ±0.5% FS (1 V or less: ±0.15 V; not output for 0 V or less)
Display method		Negative LCD (backlit LED) display 7-segment digital display (Character height: PV: 14.2 mm (green/red); SV: 4.9 mm (green))
Main functions		Scaling function, measurement operation selection, output hysteresis, output OFF delay, output test, teaching, display value selection, display color selection, key protection, bank selection, display refresh period, maximum/minimum hold, reset
Ambient operating temperature		-10 to 55°C (with no icing or condensation)
Ambient operating humidity		25% to 85%
Storage temperature		-25 to 65°C (with no icing or condensation)
Altitude		2,000 m max.
Accessories		Watertight packing, 2 fixtures, terminal cover, unit stickers, instruction manual. DeviceNet models also include a DeviceNet connector (Hirose HR31-5.08P-5SC(01)) and crimp terminals (Hirose HR31-SC-121) (See note 3.)

- Note:** 1. DC power supply models require a control power supply capacity of approximately 1 A per Unit when power is turned ON. Particular attention is required when using two or more DC power supply models. The OMRON S8VS-series DC Power Supply Unit is recommended.
2. PNP input types are also available.
3. For K3HB-series DeviceNet models, use only the DeviceNet Connector included with the product. The crimp terminals provided are for Thin Cables.

■ Characteristics

Display range		-19,999 to 99,999																									
Measurement accuracy (at 23±5°C)		±0.08% rgd ±1 digit (for voltage pulse/open collector sensors)																									
Measurement range		Functions F1, F3, and F4: 10 ms to 3,200 s Function F2: 20 ms to 3,200 s Functions F5 and F6: 0 to 4 gigacounts																									
Input signals		<ul style="list-style-type: none"> No-voltage contact (30 Hz max. with ON/OFF pulse width of 15 ms min.) <table border="1" style="width: 100%; border-collapse: collapse;"> <thead> <tr> <th>Mode</th> <th>Input frequency range</th> <th>ON/OFF pulse width</th> <th>ON voltage</th> <th>OFF voltage</th> <th>Input impedance</th> </tr> </thead> <tbody> <tr> <td>F1 to F4</td> <td>0 to 50 kHz</td> <td>9 μs min.</td> <td rowspan="2">4.5 to 30 V</td> <td rowspan="2">-30 to 2 V</td> <td rowspan="2">10 kΩ</td> </tr> <tr> <td>F5, F6</td> <td>0 to 30 kHz</td> <td>16 μs min.</td> </tr> </tbody> </table> <p>•Voltage pulse</p> <table border="1" style="width: 100%; border-collapse: collapse;"> <thead> <tr> <th>Mode</th> <th>Input frequency range</th> <th>ON/OFF pulse width</th> </tr> </thead> <tbody> <tr> <td>F1 to F4</td> <td>0 to 50 kHz</td> <td>9 μs min.</td> </tr> <tr> <td>F5, F6</td> <td>0 to 30 kHz</td> <td>16 μs min.</td> </tr> </tbody> </table> <p>•Opencollector</p> <p>Note: The Digital Time Interval Meter will malfunction if a pulse greater than the input frequency range is input. SYSERR may appear on the display.</p>		Mode	Input frequency range	ON/OFF pulse width	ON voltage	OFF voltage	Input impedance	F1 to F4	0 to 50 kHz	9 μs min.	4.5 to 30 V	-30 to 2 V	10 kΩ	F5, F6	0 to 30 kHz	16 μs min.	Mode	Input frequency range	ON/OFF pulse width	F1 to F4	0 to 50 kHz	9 μs min.	F5, F6	0 to 30 kHz	16 μs min.
Mode	Input frequency range	ON/OFF pulse width	ON voltage	OFF voltage	Input impedance																						
F1 to F4	0 to 50 kHz	9 μs min.	4.5 to 30 V	-30 to 2 V	10 kΩ																						
F5, F6	0 to 30 kHz	16 μs min.																									
Mode	Input frequency range	ON/OFF pulse width																									
F1 to F4	0 to 50 kHz	9 μs min.																									
F5, F6	0 to 30 kHz	16 μs min.																									
Connectable sensors		ON residual voltage: 3 V max. OFF leakage current: 1.5 mA max. Load current: Must have a switching capacity of 20 mA or higher. Must be able to properly switch load currents of 5 mA or less.																									
Comparative output response time (transistor output)		2 ms max. (time until the comparative output is made when there is a forced sudden change in the input signal from 15% to 95% or 95% to 15%)																									
Linear output response time		10 ms max. (time until the final analog output value is reached when there is a forced sudden change in the input signal from 15% to 95% or 95% to 15%)																									
Insulation resistance		20 MΩ min. (at 500 VDC)																									
Dielectric strength		2,300 VAC for 1 min between external terminals and case																									
Noise immunity		100 to 240 VAC models: ±1,500 V at power supply terminals in normal or common mode (waveform with 1-ns rising edge and pulse width of 1 μs/100 ns) 24 VAC/VDC models: ±1,500 V at power supply terminals in normal or common mode (waveform with 1-ns rising edge and pulse width of 1 μs/100 ns)																									
Vibration resistance		Frequency: 10 to 55 Hz; Acceleration: 50 m/s ² , 10 sweeps of 5 min each in X, Y, and Z directions																									
Shock resistance		150 m/s ² (100 m/s ² for relay outputs) 3 times each in 3 axes, 6 directions																									
Weight		Approx. 300 g (Base Unit only)																									
Degree of protection	Front panel	Conforms to NEMA 4X for indoor use (equivalent to IP66)																									
	Rear case	IP20																									
	Terminals	IP00 + finger protection (VDE0106/100)																									
Memory protection		EEPROM (non-volatile memory) Number of rewrites: 100,000																									
Applicable standards		UL61010C-1, CSA C22.2 No. 1010.1 (evaluated by UL) EN61010-1 (IEC61010-1): Pollution degree 2/Overvoltage category II EN61326: 1997, A1: 1998, A2: 2001																									
EMC		EMI: EN61326+A1 industrial applications Electromagnetic radiation interference CISPR 11 Group 1, Class A: CISPRL16-1/-2 Terminal interference voltage CISPR 11 Group 1, Class A: CISPRL16-1/-2 EMS: EN61326+A1 industrial applications Electrostatic Discharge Immunity EN61000-4-2: 4 kV (contact), 8 kV (in air) Radiated Electromagnetic Field Immunity EN61000-4-3: 10 V/m 1 kHz sine wave amplitude modulation (80 MHz to 1 GHz, 1.4GHz to 2 GHz) Electrical Fast Transient/Burst Immunity EN61000-4-4: 2 kV (power line), 1 kV (I/O signal line) Surge Immunity EN61000-4-5: 1 kV with line (power line), 2 kV with ground (power line) Conducted Disturbance Immunity EN61000-4-6: 3 V (0.15 to 80 MHz) Power Frequency Magnetic Immunity EN61000-4-8: 30 A/m (50 Hz) continuous time Voltage Dips and Interruptions Immunity EN61000-4-11: 0.5 cycle, 0°/180°, 100% (rated voltage)																									

Operation

■ Functions (Operating Modes)

F1 to F6

These functions use the internal system clock to measure the time between pulses or the pulse ON time and then display time measurements or a variety of other calculations.

Function name	Function No.
Passing speed	F1
Cycle	F2
Time difference	F3
Time band	F4
Measuring length	F5
Interval	F6

Example: F1 Passing Speed

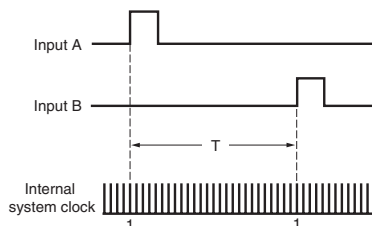

The time (T) between input A pulse and input B pulse is measured by the internal system clock. If, for example, the system clock measures 100,000 counts during time T, then

$$T = 1 \text{ system clock count (0.5 } \mu\text{s)} \times 100,000$$

$$T = 0.05 \text{ s}$$

F1 (the passing speed) is calculated internally using the formula $\frac{1}{T} \times 60$ (m/min), and the

display, in this example, would be $\frac{1}{0.05 \text{ s}} \times 60 = 1200$ (m/min).

Function	Operation	Operation image (application)
F1 Passing speed	<p>The reciprocal of the time (T) from input A ON to input B ON is multiplied by 60 and displayed.</p> <ul style="list-style-type: none"> Recovery time (TR) of 20 ms is required before starting the next measurement. <p>(Display unit: mm/s, m/s m/min, km/h, etc.)</p>	<p>Measuring workpiece passing speed between A and B</p>
F2 Cycle	<p>Measures and displays input A cycle (T).</p> <p>Measurement range: 20 ms to 3,200 s</p> <p>(Display unit: ms, s, min., min.s.1/10 s)</p>	<p>Measuring feed cycles for parts</p>
F3 Time difference	<p>Displays the time (T) from input A ON to input B ON.</p> <p>Measurement range: 10 ms to 3,200 s</p> <ul style="list-style-type: none"> Recovery time (TR) of 20 ms is required before starting the next measurement. <p>(Display unit: ms, s, min., min.s.1/10 s)</p>	<p>Measuring workpiece passing time between A and B</p> <p>Measuring the length of a workpiece step by changing prescale values.</p>

Function	Operation	Operation image (application)
F4 Time band	<p>Displays input A ON time (T).</p> <p>Measurement range: 10 ms to 3,200 s</p> <ul style="list-style-type: none"> Recovery time (TR) of 20 ms is required before starting the next measurement. <p>(Display unit: ms, s, min., min.s.1/10 s)</p>	<p>Monitoring the ON time of a printing press</p> <p>Managing the valve release time</p>
F5 Measuring length	<p>Displays the number of input A pulses while input B is ON.</p> <ul style="list-style-type: none"> Recovery time (TR) of 20 ms is required before starting the next measurement. <p>(Display unit: mm, cm, m, etc.)</p>	<p>Measuring workpiece length</p>
F6 Interval	<p>Displays the number of input A pulses from when input B turns ON until input B turns ON again. Measurement is made every other time input B turns ON.</p> <ul style="list-style-type: none"> Recovery time (TR) of 20 ms is required before starting the next measurement. <p>(Display unit: mm, cm, m, etc.)</p>	<p>Measuring slit intervals</p>

■ What Is Prescaling?

To make calculations using the input pulse to display the passing speed between two points, the distance between the two points and the display unit must be set and the internally measured time multiplied by a certain coefficient. This coefficient is called the prescale value. (For information on settings details, refer to the User's Manual.)

Time Unit Settings

Setting	Meaning
SEAL	Prescale value menu setting
~.~	Minute display
H.~.~.55	h.mm.ss display
~.~.55.d	mm.ss.d display (d = tenths of a second)

Input Type Setting

	NO: Voltage pulse high	NC: Voltage pulse low
No-contact or voltage pulse input	00	01
Contact	10	11

Note: Set to 10 or 11 when there is a large variation in the display. The largest measurement range is 30 Hz.

Up/Down Counting Pulse Indicator K3HB-C

Measure High-speed Up/down Pulses with this Up/down Pulse Meter.

- Perfect for Measuring Rotary Encoder and ON/OFF Pulse Signals at High Speed
Cumulative pulse input is 50 kHz, quadrature pulse inputs are 25 kHz, and up/down pulse inputs are 30 kHz.

Note: No-voltage contacts of up to 30 Hz are supported.

- The count value can be converted to any value.
The length equivalent for any pulse can be set to any desired value.
This is effective for feed amount and position monitor displays.

 Refer to *Common Precautions* on page 30.



Model Number Structure

Model Number Legend

Base Units and Optional Boards can be ordered individually or as sets.

Base Units

K3HB-C
1 5

1. Input Sensor Codes

NB: NPN input/voltage pulse input
PB: PNP input

5. Supply Voltage

100-240 VAC: 100 to 240 VAC
24 VAC/VDC: 24 VAC/VDC

Optional Board

Sensor Power Supply/Output Boards

K33-
2

Relay/Transistor Output Boards

K34-
3

Event Input Boards

K35-
4

Base Units with Optional Boards

K3HB-C -
1 2 3 4 5

2. Sensor Power Supply/Output Type Codes

- None: None
- CPA: Relay output (PASS: SPDT) + Sensor power supply (12 VDC±10%, 80 mA) (See note 1.)
- L1A: Linear current output (DC0(4)-20 mA) + Sensor power supply (12 VDC±10%, 80 mA) (See note 2.)
- L2A: Linear voltage output (DC0(1)-5 V, 0 to 10 V) + Sensor power supply (12 VDC±10%, 80 mA) (See note 2.)
- A: Sensor power supply (12 VDC ±10%, 80 mA)
- FLK1A: Communications (RS-232C) + Sensor power supply (12 VDC±10%, 80 mA) (See note 2.)
- FLK3A: Communications (RS-485) + Sensor power supply (12 VDC±10%, 80 mA) (See note 2.)

3. Relay/Transistor Output Type Codes

- None: None
- C1: Relay contact (H/L: SPDT each)
- C2: Relay contact (HH/H/LL/L: SPST-NO each)
- T1: Transistor (NPN open collector: HH/H/PASS/L/LL)
- T2: Transistor (PNP open collector: HH/H/PASS/L/LL)
- BCD: BCD output + transistor output (NPN open collector: HH/H/PASS/L/LL)
- DRT: DeviceNet (See note 2.)

4. Event input Type Codes

- None: None
- 1: 5 points (M3 terminal blocks) NPN open collector
- 2: 8 points (10-pin MIL connector) NPN open collector
- 3: 5 points (M3 terminal blocks) PNP open collector
- 4: 8 points (10-pin MIL connector) PNP open collector

Note: 1. CPA can be combined with relay outputs only.

2. Only one of the following can be used by each Digital Indicator:
RS-232C/RS-485 communications, a linear output, or DeviceNet communications.

Accessories (Sold Separately)

- K32-DICN: Special Cable (for event inputs with 8-pin connector)
- K32-BCD: Special BCD Output Cable

Specifications

■ Ratings

Supply voltage	100 to 240 VAC, 24 VAC/VDC, DeviceNet power supply: 24 VDC	
Allowable power supply voltage range	85% to 110% of the rated power supply voltage, DeviceNet power supply: 11 to 25 VDC	
Power consumption (See note 1.)	100 to 240 VAC: 18 VA max. (max. load) 24 VAC/DC: 11 VA/7 W max. (max. load)	
Current consumption	DeviceNet power supply: 50 mA max. (24 VDC)	
Input	No-voltage, voltage pulse, open collector	
External power supply	12 VDC \pm 10% 80 mA	
Event inputs	Hold input	NPN open collector or no-voltage contact signal
	Reset input	ON residual voltage: 2 V max. ON current at 0 Ω : 4 mA max.
	Bank input	Max. applied voltage: 30 VDC max. OFF leakage current: 0.1 mA max.
Output ratings (depends on the model)	Relay output	250 VAC, 30 VDC, 5 A (resistive load) Mechanical life expectancy: 5,000,000 operations, Electrical life expectancy: 100,000 operations
	Transistor output	Maximum load voltage: 24 VDC, Maximum load current: 50 mA, Leakage current: 100 μ A max.
	Linear output	Linear output 0 to 20 mA DC, 4 to 20 mA: Load: 500 Ω max, Resolution: Approx. 10,000, Output error: \pm 0.5% FS Linear output 0 to 5 VDC, 1 to 5 VDC, 0 to 10 VDC: Load: 5 k Ω max, Resolution: Approx. 10,000, Output error: \pm 0.5% FS (1 V or less: \pm 0.15 V; not output for 0 V or less)
Display method	Negative LCD (backlit LED) display 7-segment digital display (Character height: PV: 14.2 mm (green/red); SV: 4.9 mm (green))	
Main functions	Scaling function, measurement operation selection, output hysteresis, output OFF delay, output test, display value selection, display color selection, key protection, bank selection, display refresh period, maximum/minimum hold, re-set	
Ambient operating temperature	-10 to 55°C (with no icing or condensation)	
Ambient operating humidity	25% to 85%	
Storage temperature	-25 to 65°C (with no icing or condensation)	
Altitude	2,000 m max.	
Accessories	Watertight packing, 2 fixtures, terminal cover, unit stickers, instruction manual. DeviceNet models also include a DeviceNet connector (Hirose HR31-5.08P-5SC(01)) and crimp terminals (Hirose HR31-SC-121) (See note 3.)	

- Note:**
- DC power supply models require a control power supply capacity of approximately 1 A per Unit when power is turned ON. Particular attention is required when using two or more DC power supply models. The OMRON S8VS-series DC Power Supply Unit is recommended.
 - For K3HB-series DeviceNet models, use only the DeviceNet Connector included with the product. The crimp terminals provided are for Thin Cables.

■ Characteristics

Display range	-19,999 to 99,999																						
Measurement range	Functions F1, F2: ±2 gigacounts Functions F3 : 0 to 4 gigacounts																						
Input signals	<ul style="list-style-type: none"> No-voltage contact (30 Hz max. with ON/OFF pulse width of 15 ms min.) Voltage pulse 																						
	Mode	<table border="1"> <thead> <tr> <th>Mode</th> <th>Input frequency range</th> <th>ON/OFF pulse width</th> <th>ON voltage</th> <th>OFF voltage</th> <th>Input impedance</th> </tr> </thead> <tbody> <tr> <td>F1</td> <td>0 to 30 kHz</td> <td>16 μs min.</td> <td rowspan="2">4.5 to 30 V</td> <td rowspan="2">-30 to 2 V</td> <td rowspan="2">10 kΩ</td> </tr> <tr> <td>F2</td> <td>0 to 25 kHz</td> <td>20 μs min.</td> </tr> <tr> <td>F3</td> <td>0 to 50 kHz</td> <td>9 μs min.</td> <td></td> <td></td> <td></td> </tr> </tbody> </table>	Mode	Input frequency range	ON/OFF pulse width	ON voltage	OFF voltage	Input impedance	F1	0 to 30 kHz	16 μs min.	4.5 to 30 V	-30 to 2 V	10 kΩ	F2	0 to 25 kHz	20 μs min.	F3	0 to 50 kHz	9 μs min.			
	Mode	Input frequency range	ON/OFF pulse width	ON voltage	OFF voltage	Input impedance																	
	F1	0 to 30 kHz	16 μs min.	4.5 to 30 V	-30 to 2 V	10 kΩ																	
	F2	0 to 25 kHz	20 μs min.																				
F3	0 to 50 kHz	9 μs min.																					
Mode	<table border="1"> <thead> <tr> <th>Mode</th> <th>Input frequency range</th> <th>ON/OFF pulse width</th> </tr> </thead> <tbody> <tr> <td>F1</td> <td>0 to 30 kHz</td> <td>16 μs min.</td> </tr> <tr> <td>F2</td> <td>0 to 25 kHz</td> <td>20 μs min.</td> </tr> <tr> <td>F3</td> <td>0 to 50 kHz</td> <td>9 μs min.</td> </tr> </tbody> </table>	Mode	Input frequency range	ON/OFF pulse width	F1	0 to 30 kHz	16 μs min.	F2	0 to 25 kHz	20 μs min.	F3	0 to 50 kHz	9 μs min.	Note: The Up/Down Counting Pulse Meter will malfunction if a pulse greater than the input frequency range is input. SYSERR may appear on the display.									
Mode	Input frequency range	ON/OFF pulse width																					
F1	0 to 30 kHz	16 μs min.																					
F2	0 to 25 kHz	20 μs min.																					
F3	0 to 50 kHz	9 μs min.																					
Open collector																							
Connectable sensors	ON residual voltage: 3 V max. OFF leakage current: 1.5 mA max. Load current: Must have a switching capacity of 20 mA or higher. Must be able to properly switch load currents of 5 mA or less.																						
Max. No. of display digits	5 (-19999 to 99999)																						
Comparative output response time	1 ms max.: Transistor output; 10 ms max.: Relay contact output (time until the comparative output is made when there is a forced sudden change in the input signal from 15% to 95% or 95% to 15%)																						
Linear output response time	10 ms max. (time until the final analog output value is reached when there is a forced sudden change in the input signal from 15% to 95% or 95% to 15%)																						
Insulation resistance	20 MΩ min. (at 500 VDC)																						
Dielectric strength	2,300 VAC for 1 min between external terminals and case																						
Noise immunity	100 to 240 VAC models: ±1,500 V at power supply terminals in normal or common mode (waveform with 1-ns rising edge and pulse width of 1 μs/100 ns) 24 VAC/VDC models: ±1,500 V at power supply terminals in normal or common mode (waveform with 1-ns rising edge and pulse width of 1 μs/100 ns)																						
Vibration resistance	Frequency: 10 to 55 Hz; Acceleration: 50 m/s ² , 10 sweeps of 5 min each in X, Y, and Z directions																						
Shock resistance	150 m/s ² (100 m/s ² for relay outputs) 3 times each in 3 axes, 6 directions																						
Weight	Approx. 300 g (Base Unit only)																						
Degree of protection	Front panel	Conforms to NEMA 4X for indoor use (equivalent to IP66)																					
	Rear case	IP20																					
	Terminals	IP00 + finger protection (VDE0106/100)																					
Memory protection	EEPROM (non-volatile memory) Number of rewrites: 100,000																						
Applicable standards	UL61010C-1, CSA C22.2 No. 1010.1 (evaluated by UL) EN61010-1 (IEC61010-1): Pollution degree 2/Overvoltage category II EN61326: 1997, A1: 1998, A2: 2001																						
EMC	EMI: EN61326+A1 industrial applications Electromagnetic radiation interference CISPR 11 Group 1, Class A: CISPRL16-1/-2 Terminal interference voltage CISPR 11 Group 1, Class A: CISPRL16-1/-2 EMS: EN61326+A1 industrial applications Electrostatic Discharge Immunity EN61000-4-2: 4 kV (contact), 8 kV (in air) Radiated Electromagnetic Field Immunity EN61000-4-3: 10 V/m 1 kHz sine wave amplitude modulation (80 MHz to 1 GHz, 1.4 to 2 GHz) Electrical Fast Transient/Burst Immunity EN61000-4-4: 2 kV (power line), 1 kV (I/O signal line) Surge Immunity EN61000-4-5: 1 kV with line (power line), 2 kV with ground (power line) Conducted Disturbance Immunity EN61000-4-6: 3 V (0.15 to 80 MHz) Power Frequency Magnetic Immunity EN61000-4-8: 30 A/m (50 Hz) continuous time Voltage Dips and Interruptions Immunity EN61000-4-11: 0.5 cycle, 0°/180°, 100% (rated voltage)																						

Operation

■ Functions (Operating Modes)

F1 to F3

Function name	Function No.
Individual inputs	F1
Phase differential inputs	F2
Pulse counting input	F3

Function	Operation	Operation image (application)
F1 Individual inputs	<p>Counts input A as incremental pulses and input B as decremental pulses. The count is incremented on the rising edge of input A and decremented on the rising edge of input B. If both inputs rise at the same time, the count is not changed. The count is incremented when input B is later than input A and decremented when input B is earlier than input A.</p>	<p>Counting the number of people entering an area</p>
F2 Phase differential inputs	<p>This function is normally used when connected to an incremental rotary encoder. The count is incremented on the falling edge of input B when input A is OFF. The count is decremented on the rising edge of input B when input A is OFF.</p>	<p>Detecting position and speed on a semiconductor wafer conveyor line</p>
F3 Pulse counting input	<p>Counted on the rising edge of input A</p>	<p>Counting the number of workpieces</p>

Note: 1. Meaning of H and L in Display

Symbol	Input method	No-voltage input
H		Short-circuit
L		Open

2. Requires at least half the minimum signal width. If there is less than half, a ±1 count error may occur.

Input Type Setting

	NO: Voltage pulse high	NC: Voltage pulse low
No-contact or voltage pulse input	00	01
Contact	10	11

■ What Is Prescaling?

Prescaling converts the count value to any numeric value.

To display $\square\square\square.\square$ mm in a system that outputs 250 pulses for a 0.5-m feed,
the length per pulse = $500 \text{ mm (0.5 m)} \div 250 = 2$.

1. The prescale value for the K3HB-C is set using the mantissa $X \times$ exponent Y ,
so the prescale value = 2.0000×10^0 ,
 $X = 2.000$, and $Y = 00$.
2. Next, set the decimal point position for one digit to the right of the decimal point: $\square\square\square.\square$

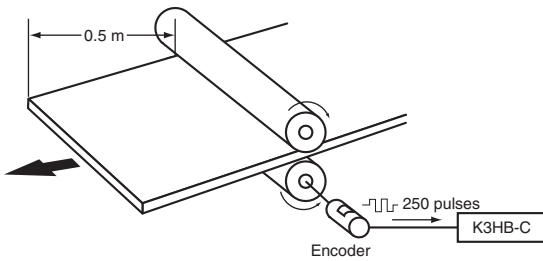

Common Specifications

■ Event Input Ratings

K3HB-R	S-TMR, HOLD, RESET, BANK1, BANK2, BANK4
K3HB-P/-C	HOLD, RESET, BANK1, BANK2, BANK4
Contact	ON: 1 kΩ max., OFF: 100 kΩ min.
No-contact	ON residual voltage: 2 V max. OFF leakage current: 0.1 mA max. Load current: 4 mA max. Maximum applied voltage: 30 VDC max.

■ Output Ratings

Contact Output

Item	Resistive loads (250 VAC, cosφ=1; 30 VDC, L/R=0 ms)	Inductive loads (250 VAC, closed circuit, cosφ=0.4; 30 VDC, L/R=7 ms)
Rated load	5 A at 250 VAC 5 A at 30 VDC	1 A at 250 VAC 1 A at 30 VDC
Rated through current	5 A	
Mechanical life expectancy	5,000,000 operations	
Electrical life expectancy	100,000 operations	

Transistor Outputs

Maximum load voltage	24 VDC
Maximum load current	50 mA
Leakage current	100 μA max.

Linear Output

Item	Outputs	0 to 20 mA	4 to 20 mA	0 to 5 V	1 to 5 V	0 to 10 V
Allowable load impedance		500 Ω max.		5 kΩ min.		
Resolution		Approx. 10,000				
Output error		±0.5% FS		±0.5% FS (±0.15 V for 1 V or less and no output for 0 V)		

Serial Communications Output

Item	Type	RS-232C, RS-485
Communications method		Half duplex
Synchronization method		Start-stop synchronization (asynchronous)
Baud rate		9600/19200/38400 bps
Transmission code		ASCII
Data length		7 bits or 8 bits
Stop bit length		2 bits or 1 bit
Error detection		Vertical parity and FCS
Parity check		Odd, even

BCD Output I/O Ratings (Input Signal Logic: Negative)

I/O signal name		Item	Rating		
Inputs	K3HB-R/P REQUEST HOLD MAX MIN RESET	K3HB-C REQUEST COMPEN- SATION RESET	Input signal	No-voltage contact input	
			Input current for no-voltage input	10 mA	
			Signal level	ON voltage: 1.5 V max. OFF voltage: 3 V min.	
Outputs	DATA POLARITY OVER DATA VALID RUN		Maximum load voltage	24 VDC	
			Maximum load current	10 mA	
			Leakage current	100 μA max.	
	K3HB-R/P HH H PASS L LL	K3HB-C OUT1 OUT2 OUT3 OUT4 OUT5		Maximum load voltage	24 VDC
				Maximum load current	50 mA
			Leakage current	100 μA max.	

Refer to the *K3HB Communications User's Manual* (Cat. No. N129) for details on serial and DeviceNet communications.

DeviceNet Communications

Communications protocol		Conforms to DeviceNet																		
Supported communications	Remote I/O communications	Master-Slave connection (polling, bit-strobe, COS, cyclic) Conforms to DeviceNet communications standards.																		
	I/O allocations	Allocate any I/O data using the Configurator. Allocate any data, such as DeviceNet-specific parameters and variable area for Digital Indicators. Input area: 2 blocks, 60 words max. Output area: 1 block, 29 words max. (The first word in the area is always allocated for the Output Execution Enabled Flags.)																		
	Message communications	Explicit message communications CompoWay/F communications commands can be executed (using explicit message communications)																		
Connection methods		Combination of multi-drop and T-branch connections (for trunk and drop lines)																		
Baud rate		DeviceNet: 500, 250, or 125 Kbps (automatic follow-up)																		
Communications media		Special 5-wire cable (2 signal lines, 2 power supply lines, 1 shield line)																		
Communications distance		<table border="1"> <thead> <tr> <th>Baud rate</th> <th>Network length (max.)</th> <th>Drop line length (max.)</th> <th>Total drop line length (max.)</th> </tr> </thead> <tbody> <tr> <td>500 Kbps</td> <td>100 m max. (100 m max.)</td> <td>6 m max.</td> <td>39 m max.</td> </tr> <tr> <td>250 Kbps</td> <td>100 m max. (250 m max.)</td> <td>6 m max.</td> <td>78 m max.</td> </tr> <tr> <td>125 Kbps</td> <td>100 m max. (500 m max.)</td> <td>6 m max.</td> <td>156 m max.</td> </tr> </tbody> </table> <p>The values in parentheses are for Thick Cable.</p>			Baud rate	Network length (max.)	Drop line length (max.)	Total drop line length (max.)	500 Kbps	100 m max. (100 m max.)	6 m max.	39 m max.	250 Kbps	100 m max. (250 m max.)	6 m max.	78 m max.	125 Kbps	100 m max. (500 m max.)	6 m max.	156 m max.
Baud rate	Network length (max.)	Drop line length (max.)	Total drop line length (max.)																	
500 Kbps	100 m max. (100 m max.)	6 m max.	39 m max.																	
250 Kbps	100 m max. (250 m max.)	6 m max.	78 m max.																	
125 Kbps	100 m max. (500 m max.)	6 m max.	156 m max.																	
Communications power supply		24-VDC DeviceNet power supply																		
Allowable voltage fluctuation range		11 to 25-VDC DeviceNet power supply																		
Current consumption		50 mA max. (24 VDC)																		
Maximum number of nodes		64 (DeviceNet Configurator is counted as one node when connected.)																		
Maximum number of slaves		63																		
Error control checks		CRC errors																		
DeviceNet power supply		Supplied from DeviceNet communications connector																		

Connections

External Connection Diagrams

Terminal Arrangements

Note: Refer to "Internal Block Diagram" on page 24 for information on isolation.

A Operating Power Supply

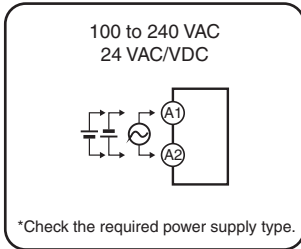

B Sensor Power Supply/Output

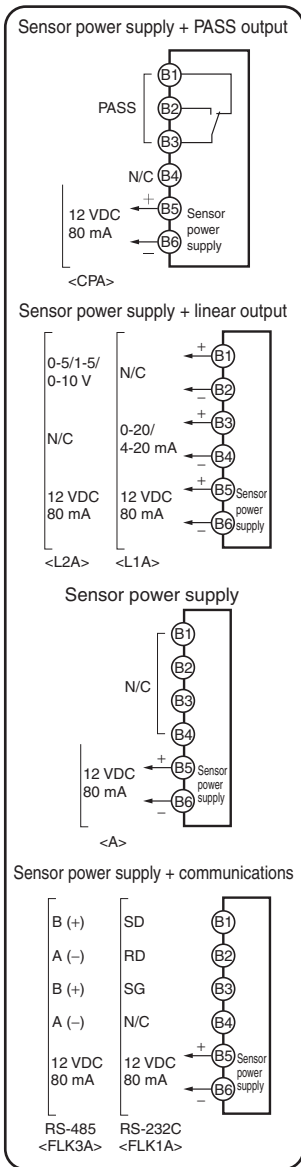

C Relays, Transistors, BCD and DeviceNet

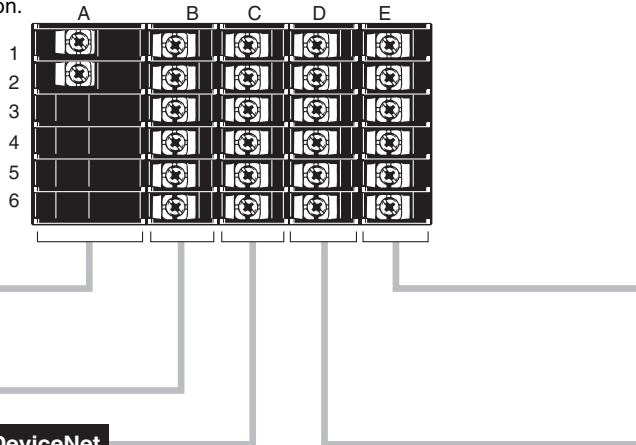
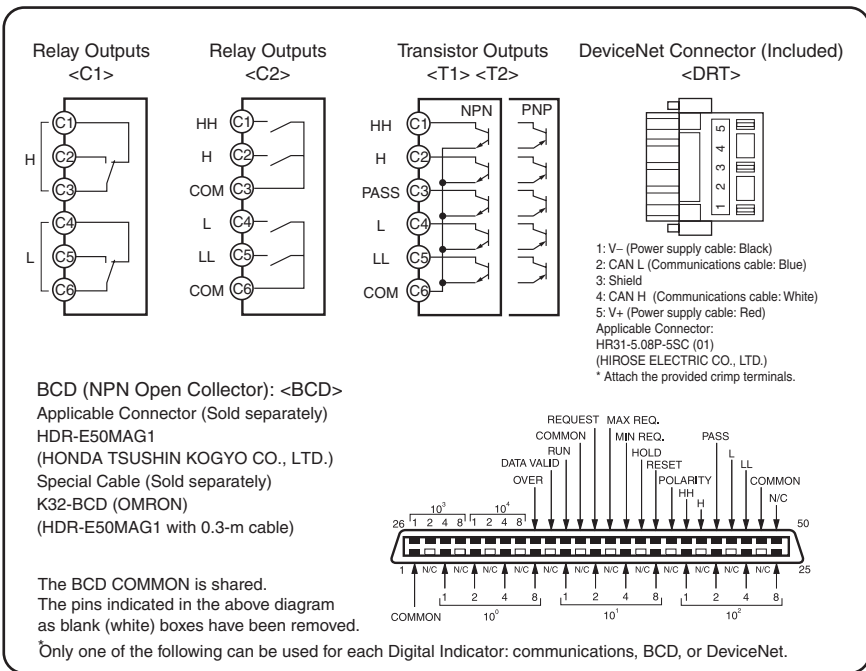

Contact Outputs

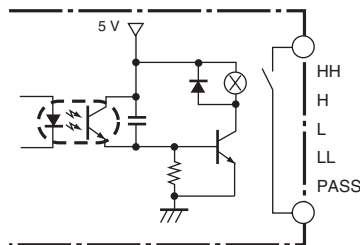

Transistor Outputs (NPN Open Collector)

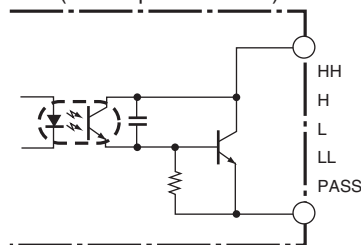

Safety Standards Conformance

- Always use a EN/IEC-compliant power supply with reinforced insulation or double insulation for the DeviceNet power supply.
- The product must be used indoors for the above applicable standards to apply.

E Pulse Inputs

- Rotary Pulse Meter: K3HB-R
- Timer Interval Meter: K3HB-P
- Up/Down Counting Pulse Meter: K3HB-C

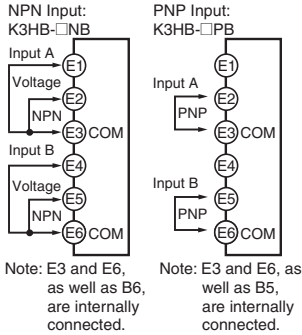

K3HB-R
K3HB-P
K3HB-C

K3HB-R
K3HB-P

NPN Input Model

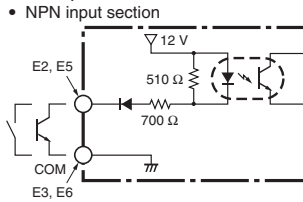

PNP Input Model

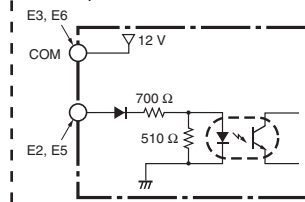

Voltage pulse input section

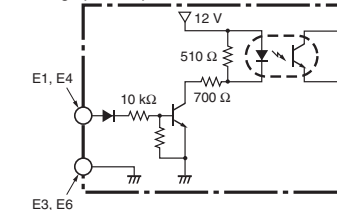

D Event Inputs

Models with Terminal Blocks <1> <3>

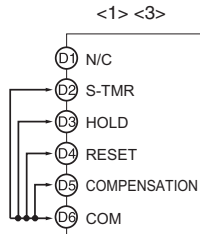

Models with Connectors <2> <4>

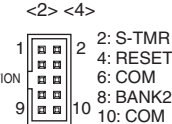

- Applicable Connector (Sold separately) XG4M-1030 (OMRON)
 - Special Cable (Sold separately) K32-DICN (OMRON) (XG4M-1030 with 3-m cable)
- The following signals depend on the model:
S-TMR: Used by the K3HB-R only.
COMPENSATION: Used by the K3HB-C only.

- Use terminal pin D6 as the common terminal.
- Use NPN open collector or no-voltage contacts for event input. PNP types are also available.

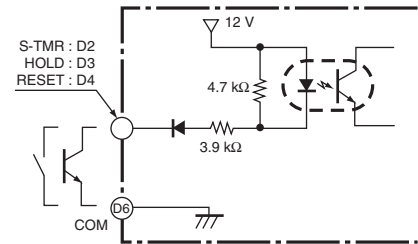

BCD Output Cable

Model	Shape	Pin arrangement
K32-BCD	<p>Cover: HDR-E50LPA5 (manufactured by Honda Tsushin Co., Ltd) Connector: HDR-E50MAG1 (manufactured by Honda Tsushin Co., Ltd)</p> <p>D-sub connector (37-pin female) Cover: 17JE-37H-1A (manufactured by DDK) Connector: Equivalent to 17JE-13370-02 (manufactured by DDK) Stand: 17L-002A (manufactured by DDK)</p>	

Note: The BCD Output Cable has a D-sub plug. Cover: 17JE-37H-1A (manufactured by DDK); Connector: equivalent to 17JE-23370-02 (D1) (manufactured by DDK)

Special Cable (for Event Inputs with 8-pin Connector)

Model	Appearance	Wiring																						
K32-DICN		<table border="1"> <thead> <tr> <th>Pin No.</th> <th>Signal name</th> </tr> </thead> <tbody> <tr><td>1</td><td>N/C</td></tr> <tr><td>2</td><td>S-TMR</td></tr> <tr><td>3</td><td>HOLD</td></tr> <tr><td>4</td><td>RESET</td></tr> <tr><td>5</td><td>N/C</td></tr> <tr><td>6</td><td>COM</td></tr> <tr><td>7</td><td>BANK4</td></tr> <tr><td>8</td><td>BANK2</td></tr> <tr><td>9</td><td>BANK1</td></tr> <tr><td>10</td><td>COM</td></tr> </tbody> </table>	Pin No.	Signal name	1	N/C	2	S-TMR	3	HOLD	4	RESET	5	N/C	6	COM	7	BANK4	8	BANK2	9	BANK1	10	COM
Pin No.	Signal name																							
1	N/C																							
2	S-TMR																							
3	HOLD																							
4	RESET																							
5	N/C																							
6	COM																							
7	BANK4																							
8	BANK2																							
9	BANK1																							
10	COM																							

Derating Curve for Sensor Power Supply (Reference Values)

For 12V

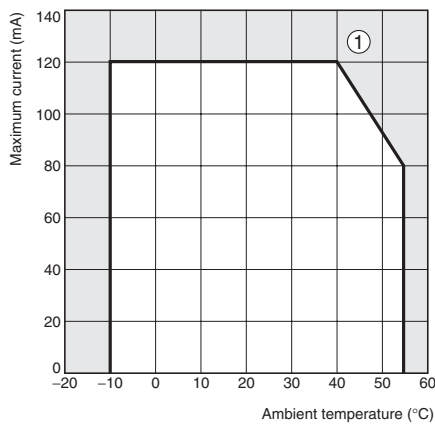

Note: 1. The above values were obtained under test conditions with the standard mounting. The derating curve will vary with the mounting conditions, so be sure to adjust accordingly.

2. Internal components may be deteriorated or damaged. Do not use the Digital Indicator outside of the derating range (i.e., do not use it in the area labeled (1), above).

Internal Block Diagram

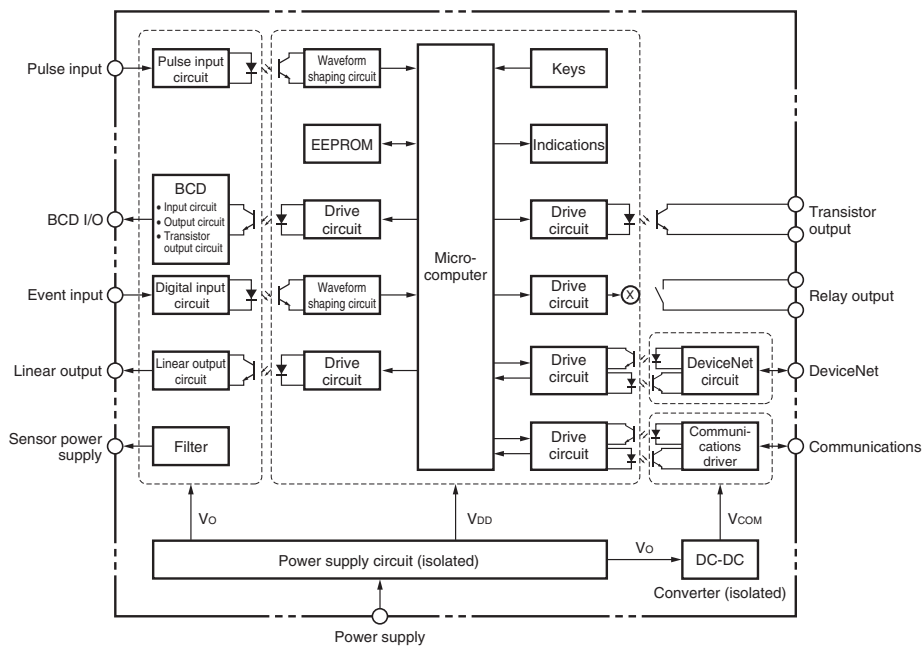

BCD Output Timing Chart

A REQUEST signal from a Programmable Controller or other external device is required to read BCD data.

Single Sampling Data Output

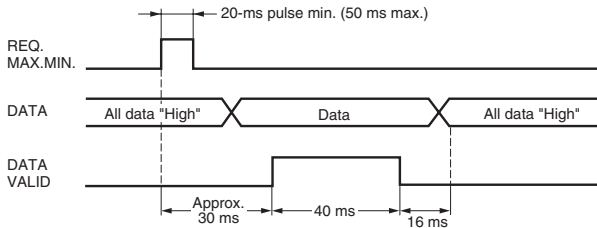

The data is set in approximately 30 ms from the rising edge of the REQUEST signal and the DATA VALID signal is output. When reading the data from a Programmable Controller, start reading the data when the DATA VALID signal turns ON. The DATA VALID signal will turn OFF 40 ms later, and the data will turn OFF 16 ms after that.

Continuous Data Output

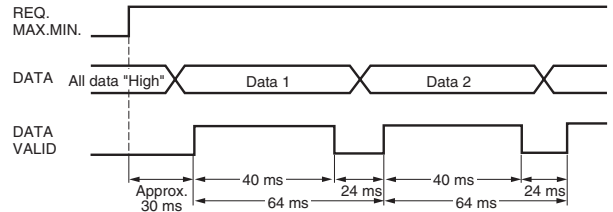

Measurement data is output every 64 ms while the REQUEST signal remains ON.

Note: If HOLD is executed when switching between data 1 and data 2, either data 1 or data 2 is output depending on the timing of the hold signal. The data will not go LOW.

- The K3HB BCD output model has an open collector output, so wired OR connection is possible

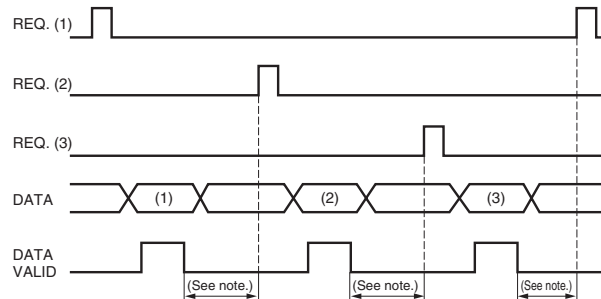
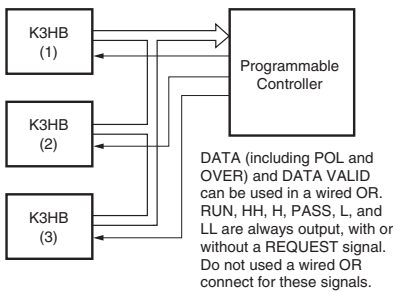

Note: Leave 20 ms min. between DATA VALID turning OFF and the REQUEST signal.

Programmable Controller Connection Example

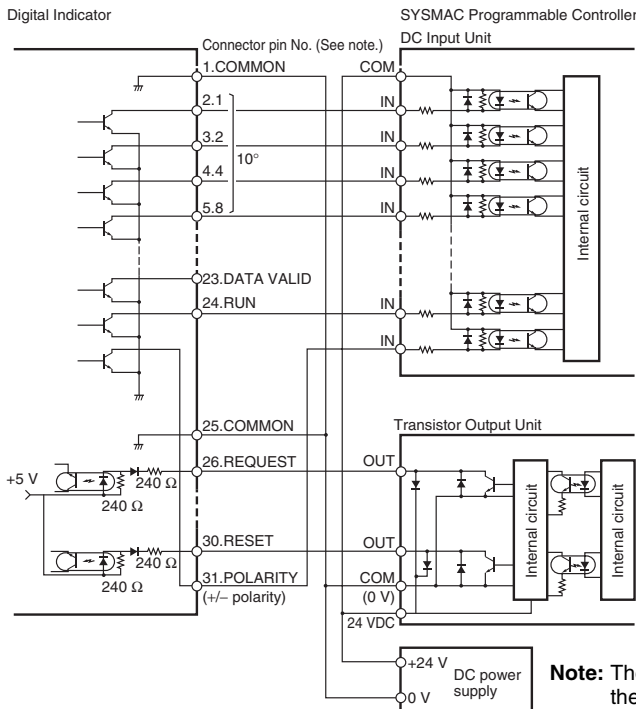

Display Unit Connection Example

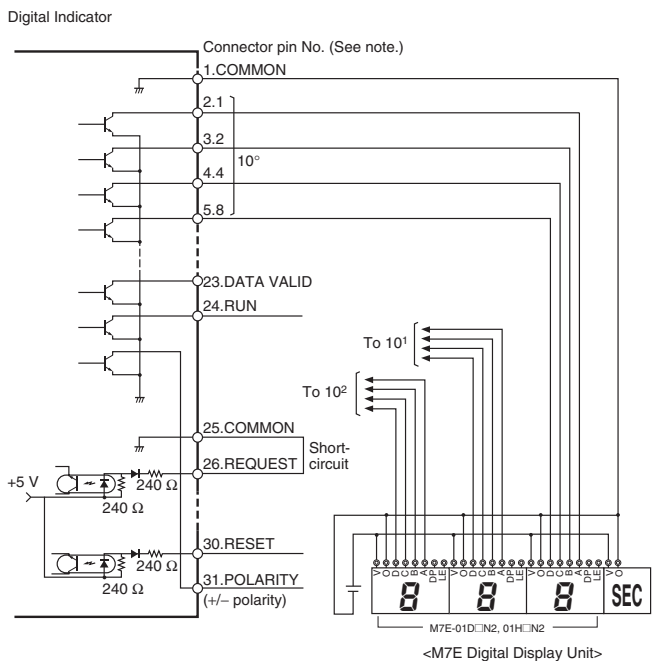

Note: The BCD output connector pin number is the D-sub connector pin number when the BCD Output Cable (sold separately) is connected. This number differs from the pin number for the Digital Indicator narrow pitch connector (manufactured by Honda Tsushin Kogyo Co., Ltd.).

Refer to the following User's Manual for application precautions and other information required when using the Digital Indicator:
 K3HB-R/P/C Digital Indicator User's Manual (Cat. No. N136)
 The manual can be downloaded from the following site in PDF format: OMRON Industrial Web <http://www.fa.omron.co.jp>

■ Component Names and Functions

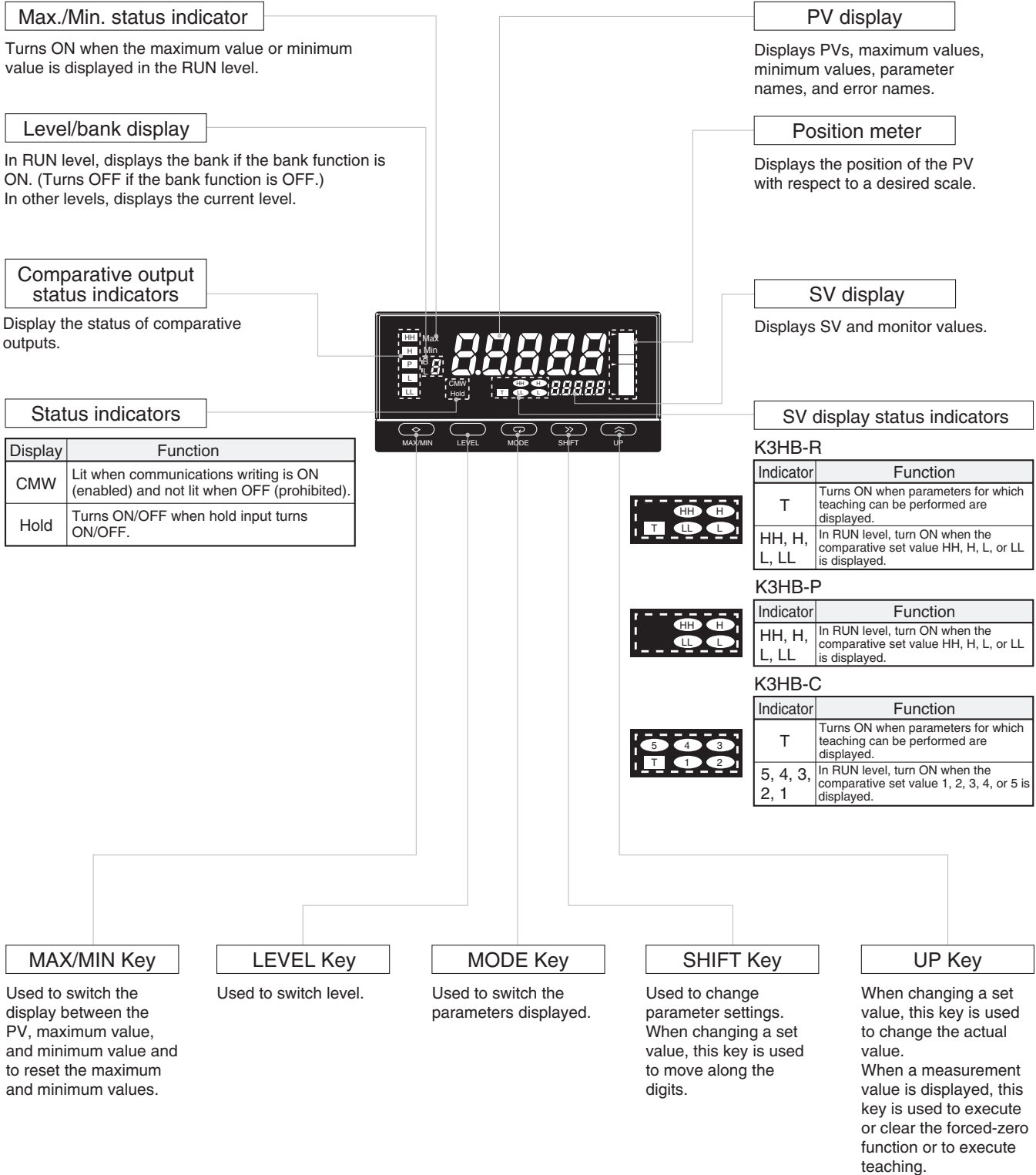

Dimensions

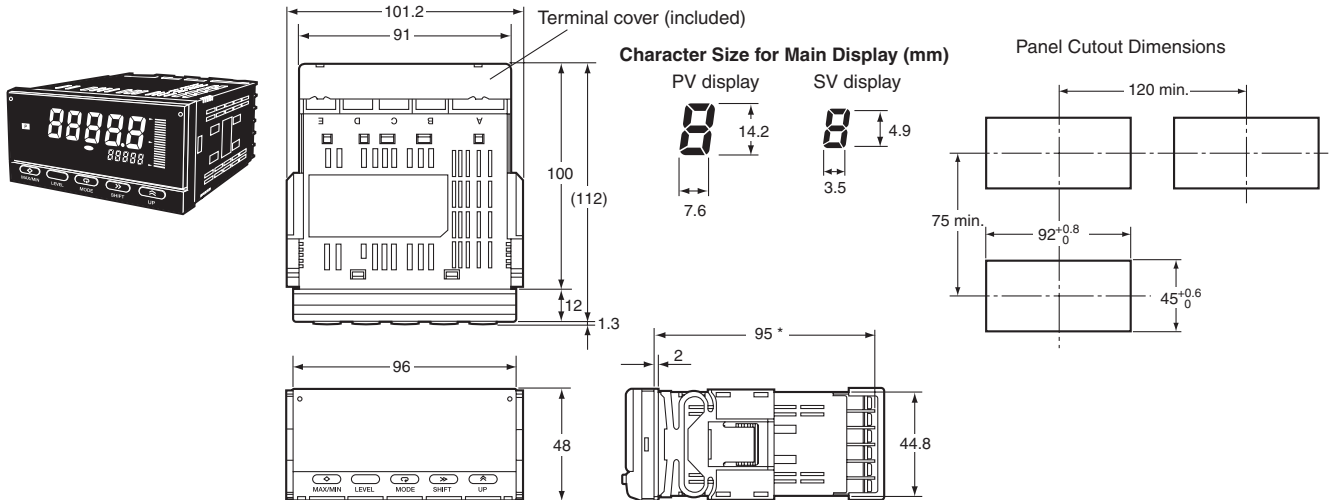

*DeviceNet models: 97 mm
Terminal: M3, Terminal Cover: Accessory

Wiring Precautions

- For terminal blocks, use the crimp terminals suitable for M3 screws.
- Tighten the terminal screws to the recommended tightening torque of approx. 0.5 N·m.
- To prevent inductive noise, separate the wiring for signal lines from that for power lines.

Wiring

- Use the crimp terminals suitable for M3 screws shown below.

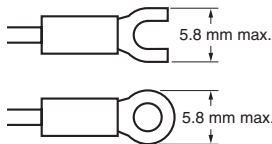

Unit Stickers (included)

- No unit stickers are attached to the Digital Indicator.
- Select the appropriate units from the unit sticker sheets provided.

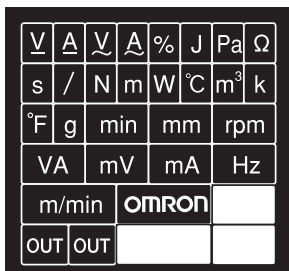

Note: For measurements for commercial purposes, be sure to use the unit required by any applicable laws or regulations.

Mounting Method

1. Insert the K3HB into the mounting cutout in the panel.
2. Insert watertight packing around the Unit to make the mounting watertight.

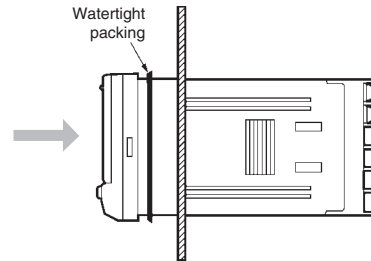

3. Insert the adaptor into the grooves on the left and right sides of the rear case and push until it reaches the panel and is fixed in place.

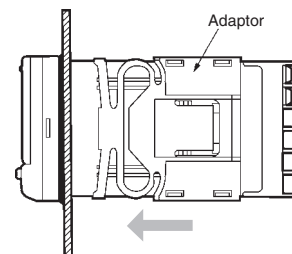

LCD Field of Vision

The K3HB is designed to have the best visibility at the angles shown in the following diagram.

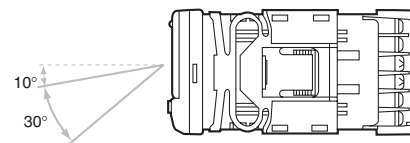

Waterproof Packing

The waterproof packing ensures a level of waterproofing that conforms to NEMA 4X. Depending on the operating environment, deterioration, contraction, or hardening may occur and replacement may be necessary. In this case, consult your OMRON representative.

Main Functions

■ Main Functions and Features

Measurement

Function **FUN** **R P C**

The K3HB-R has the following six functions for receiving and displaying input pulses.

- F1: Rotation (rpm)/circumferential speed
- F2: Absolute ratio
- F3: Error ratio
- F4: Rotational difference
- F5: Flow rate ratio
- F6: Passing time

The K3HB-P has the following six functions for receiving and displaying input pulses.

- F1: Passing speed
- F2: Cycle
- F3: Time difference
- F4: Time band
- F5: Measuring length
- F6: Interval

The K3HB-C has the following three functions for receiving and displaying input pulses.

- F1: Individual inputs
- F2: Phase differential inputs
- F3: Pulse counting input

Filters

Average Processing **AUG-t, AUG-n** **R**

Average processing of input signals with extreme changes or noise smooths out the display and makes control stable.

Input Types **IN-tA, IN-tB** **R P** **IN-tA** **C**

Specify the types of sensor connected to input A and input B.

Input Compensation

Auto-zero Times **At-zA, At-zB** **R**

The frequency is forced to zero if there is no pulse input for a set period.

Input Compensation **CO-Pn, CO-P** **C**

The display can be changed to a preset compensation value using the compensation input.

Key Operations

Teaching **TC**

The present measurement value can be used as a scaling value.

Key Protection **KPC**

Key protection restricts level or parameter changes using the keys to prevent unintentional key operations and malfunctions.

Outputs

Comparative Output Pattern **ǒǒǒ-P R P C**

Standard, zone, and level comparative output patterns can be selected for comparative outputs.

Hysteresis **HY5 R**

Prevents comparative outputs from chattering when the measurement value fluctuates slightly near the set value.

Output Refresh Stop **ǒ-5ǒP R P**

Holds the output status when a comparative result output other than PASS turns ON.

PASS Output Change **PASS R P**

Comparative results other than PASS and error signals can be output from the PASS output terminal.

Output OFF Delay **ǒFF-d R P C**

Delays turning OFF comparatives for a set period. This can be used to provide sufficient time to read the comparative output ON status when the comparative result changes at short intervals.

Shot Output **SHǒt R P C**

Turns ON the comparative output for a specific time.

Output Logic **ǒǒǒ-n R P C**

Reverses the output logic of comparative results.

Startup Compensation Timer **5-ǒǒr R**

Measurements can be stopped for a set time using an external input.

Output Test **ǒ5ǒt R P C**

Output operation can be checked without using actual input signals by using the keys to set a test measurement value.

Linear Outputs **ǒ5ǒǒǒ, ǒ5ǒǒǒ, ǒ5ǒǒǒ, ǒ5ǒǒǒ R P C**

A current or voltage proportional to the change in the measurement value can be output.

Standby Sequence **5ǒdbǒ R P**

The comparison outputs can be kept OFF until the measurement value enters the PASS range.

Display

Display Value Selection **dǒ5P R P C**

The display value can be set to the present value, the maximum value, or the minimum value.

Display Color Selection **ǒǒǒǒr R P C**

The present value display color can be set to green or red. The color of the present value can also be switched according to the comparative output.

Display Refresh Period **dǒǒFF R P C**

When the input changes rapidly, the display refresh period can be lengthened to control flickering and make the display easier to read.

Position Meter **Pǒ5-ǒ, Pǒ5-H, Pǒ5-L R P C**

The present measurement value can be displayed as a position in relation to the scaling width on a 20-gradation position meter.

Prescale **P5ǒǒ, P5ǒǒ, P5bǒ, P5bǒ R P C**

The input signal can be converted and displayed as any value.

Comparative Set Value Display **5ǒd5P R P C**

Select whether or not to display the comparative value during operation.

Display auto-return **rǒǒ R P C**

Automatically returns the display to RUN level when there are no key operations (e.g., max./min. switching, bank settings using keys).

Other

Max./Min. Hold **R P**

Holds the maximum and minimum measurement values.

Bank Selection **bǒǒ-ǒ R P C**

Switch between 8 comparative value banks using the keys on the front panel or external inputs. A set of set comparative values can be selected as a group.

Bank Copy **ǒǒPǒ R P C**

Any bank settings can be copied to all banks.

Interruption Memory **ǒǒǒǒ C**

The measured value can be recorded when the power supply is interrupted.

User Calibration **R P C**

The K3HB can be calibrated by the user.

Common Precautions

■ Precautions

WARNING

Do not touch the terminals while power is being supplied. Doing so may possibly result in electric shock. Make sure that the terminal cover is installed before using the product.



Always provide protective circuits in the network. Without protective circuits, malfunctions may possibly result in accidents that cause serious injury or significant property damage. Provide double or triple safety measures in external control circuits, such as emergency stop circuits, interlock circuits, or limit circuits, to ensure safety in the system if an abnormality occurs due to malfunction of the product or another external factor affecting the product's operation.



CAUTION

Do not allow pieces of metal, wire clippings, or fine metallic shavings or filings from installation to enter the product. Doing so may occasionally result in minor electric shock, fire, or malfunction.



Do not use the product in locations where flammable or explosive gases are present. Doing so may occasionally result in minor or moderate explosion, causing minor or moderate injury, or property damage.



Do not attempt to disassemble, repair, or modify the product. Doing so may occasionally result in minor or moderate injury due to electric shock.



Do not use the equipment for measurements within Measurement Categories II, III or IV (according to IEC61010-1). Doing so may occasionally cause unexpected operation, resulting in minor or moderate injury, or damage to the equipment. Use the equipment for measurements only within the Measurement Category for which the product is designed.



Perform correct setting of the product according to the application. Failure to do so may occasionally cause unexpected operation, resulting in minor or moderate injury, or damage to the equipment.



Ensure safety in the event of product failure by taking safety measures, such as installing a separate monitoring system. Product failure may occasionally prevent operation of comparative outputs, resulting in damage to the connected facilities and equipment.



Tighten the screws on the terminal block and the connector locking screws securely using a tightening torque within the following ranges. Loose screws may occasionally cause fire, resulting in minor or moderate injury, or damage to the equipment.



Terminal block screws: 0.43 to 0.58 N·m

Connector locking screws: 0.18 to 0.22 N·m

Make sure that the product will not be adversely affected if the DeviceNet cycle time is lengthened as a result of changing the program with online editing. Extending the cycle time may cause unexpected operation, occasionally resulting in minor or moderate injury, or damage to the equipment.



Before transferring programs to other nodes or changing I/O memory of other nodes, check the nodes to confirm safety. Changing the program or I/O memory of other nodes may occasionally cause unexpected operation, resulting in minor or moderate injury, or damage to the equipment.



Precautions for Safe Use

- Do not use the product in the following locations.
 - Locations subject to direct radiant heat from heating equipment
 - Locations where the product may come into contact with water or oil
 - Locations subject to direct sunlight
 - Locations where dust or corrosive gases (in particular, sulfuric or ammonia gas) are present
 - Locations subject to extreme temperature changes
 - Locations where icing or condensation may occur
 - Locations subject to excessive shocks or vibration
- Do not use the product in locations subject to temperatures or humidity levels outside the specified ranges or in locations prone to condensation. If the product is installed in a panel, ensure that the temperature around the product (not the temperature around the panel) does not go outside the specified range.
- Provide sufficient space around the product for heat dissipation.
- Use and store the product within the specified temperature and humidity ranges. If several products are mounted side-by-side or arranged in a vertical line, the heat dissipation will cause the internal temperature of the products to rise, shortening the service life. If necessary, cool the products using a fan or other cooling method.
- The service life of the output relays depends on the switching capacity and switching conditions. Consider the actual application conditions and use the product within the rated load and electrical service life. Using the product beyond its service life may result in contact welding or burning.
- Install the product horizontally.
- Mount to a panel between 1 and 8-mm thick.
- Use the specified size of crimp terminals (M3, width: 5.8 mm max.) for wiring. To connect bare wires, AWG22 (cross section: 0.326 mm²) to AWG14 (cross section: 2.081 mm²) to wire the power supply terminals and AWG28 (cross section: 0.081 mm²) to AWG16 (cross section: 1.309 mm²) for other terminals. (Length of exposed wire: 6 to 8 mm)
- In order to prevent inductive noise, wire the lines connected to the product separately from power lines carrying high voltages or currents. Do not wire in parallel with or in the same cable as power lines. Other measures for reducing noise include running lines along separate ducts and using shield lines.
- Ensure that the rated voltage is achieved no longer than 2 s after turning the power ON.
- Allow the product to operate without load for at least 15 minutes after the power is turned ON.
- Do not install the product near devices generating strong high-frequency waves or surges. When using a noise filter, check the voltage and current and install it as close to the product as possible.
- Do not use thinner to clean the product. Use commercially available alcohol.
- Be sure to confirm the name and polarity for each terminal before wiring the terminal block and connectors.
- Use the product within the noted supply voltage and rated load.
- Do not connect anything to unused terminals.
- Output turns OFF when the mode is changed or settings are initialized. Take this into consideration when setting up the control system.
- Install an external switch or circuit breaker that complies with applicable IEC60947-1 and IEC60947-3 requirements and label them clearly so that the operator can quickly turn OFF the power.
- Use the specified cables for the communications lines and stay within the specified DeviceNet communications distances. Refer to the User's Manual (Cat. No. N129) for details on communications distance specifications and cables.

- 20. Do not pull the DeviceNet communications cables with excessive force or bend them past their natural bending radius.
- 21. Do not connect or remove connectors while the DeviceNet power is being supplied. Doing so will cause product failure or malfunction.
- 22. Use cables with heat resistance of 70°C min.

■ Noise Countermeasures

- 1. Do not install the product near devices generating strong high-frequency waves or surges, such as high-frequency welding and sewing machines.
- 2. Mount a surge suppressor or noise filter to peripheral devices generating noise, in particular, motors, transformers, solenoids, and magnet coils.

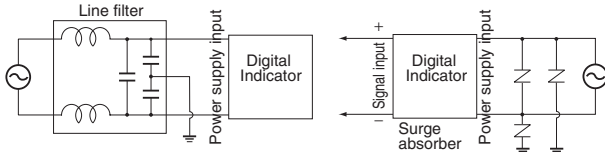

- 3. In order to prevent inductive noise, wire the lines connected to the terminal block separately from power lines carrying high voltages or currents. Do not wire in parallel with or in the same cable as power lines. Other measures for reducing noise include running lines along separate ducts and using shield lines.

Example of Countermeasures for Inductive Noise on Input Lines

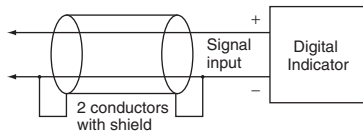

- 4. If a noise filter is used for the power supply, check the voltage and current, and install the noise filter as close to the product as possible.
- 5. Reception interference may occur if the product is used close to a radio, television, or wireless.

Warranty and Limitations of Liability

■ WARRANTY

OMRON's exclusive warranty is that the products are free from defects in materials and workmanship for a period of one year (or other period if specified) from date of sale by OMRON.

OMRON MAKES NO WARRANTY OR REPRESENTATION, EXPRESS OR IMPLIED, REGARDING NON-INFRINGEMENT, MERCHANTABILITY, OR FITNESS FOR PARTICULAR PURPOSE OF THE PRODUCTS. ANY BUYER OR USER ACKNOWLEDGES THAT THE BUYER OR USER ALONE HAS DETERMINED THAT THE PRODUCTS WILL SUITABLY MEET THE REQUIREMENTS OF THEIR INTENDED USE. OMRON DISCLAIMS ALL OTHER WARRANTIES, EXPRESS OR IMPLIED.

■ LIMITATIONS OF LIABILITY

OMRON SHALL NOT BE RESPONSIBLE FOR SPECIAL, INDIRECT, OR CONSEQUENTIAL DAMAGES, LOSS OF PROFITS, OR COMMERCIAL LOSS IN ANY WAY CONNECTED WITH THE PRODUCTS, WHETHER SUCH CLAIM IS BASED ON CONTRACT, WARRANTY, NEGLIGENCE, OR STRICT LIABILITY.

In no event shall the responsibility of OMRON for any act exceed the individual price of the product on which liability is asserted.

IN NO EVENT SHALL OMRON BE RESPONSIBLE FOR WARRANTY, REPAIR, OR OTHER CLAIMS REGARDING THE PRODUCTS UNLESS OMRON'S ANALYSIS CONFIRMS THAT THE PRODUCTS WERE PROPERLY HANDLED, STORED, INSTALLED, AND MAINTAINED AND NOT SUBJECT TO CONTAMINATION, ABUSE, MISUSE, OR INAPPROPRIATE MODIFICATION OR REPAIR.

Application Considerations

■ SUITABILITY FOR USE

OMRON shall not be responsible for conformity with any standards, codes, or regulations that apply to the combination of products in the customer's application or use of the products.

At the customer's request, OMRON will provide applicable third party certification documents identifying ratings and limitations of use that apply to the products. This information by itself is not sufficient for a complete determination of the suitability of the products in combination with the end product, machine, system, or other application or use.

The following are some examples of applications for which particular attention must be given. This is not intended to be an exhaustive list of all possible uses of the products, nor is it intended to imply that the uses listed may be suitable for the products.

- Outdoor use, uses involving potential chemical contamination or electrical interference, or conditions or uses not described in this catalog.
- Nuclear energy control systems, combustion systems, railroad systems, aviation systems, medical equipment, amusement machines, vehicles, safety equipment, and installations subject to separate industry or government regulations.
- Systems, machines, and equipment that could present a risk to life or property.

Please know and observe all prohibitions of use applicable to the products.

NEVER USE THE PRODUCTS FOR AN APPLICATION INVOLVING SERIOUS RISK TO LIFE OR PROPERTY WITHOUT ENSURING THAT THE SYSTEM AS A WHOLE HAS BEEN DESIGNED TO ADDRESS THE RISKS, AND THAT THE OMRON PRODUCTS ARE PROPERLY RATED AND INSTALLED FOR THE INTENDED USE WITHIN THE OVERALL EQUIPMENT OR SYSTEM.

ALL DIMENSIONS SHOWN ARE IN MILLIMETERS.

To convert millimeters into inches, multiply by 0.03937. To convert grams into ounces, multiply by 0.03527.

Cat. No. N135-E1-02 **In the interest of product improvement, specifications are subject to change without notice.**

OMRON Corporation

Industrial Automation Company

Industrial Devices and Components Division H.Q.

Measuring Components Department

Shiokoji Horikawa, Shimogyo-ku,

Kyoto, 600-8530 Japan

Tel: (81)75-344-7080/Fax: (81)75-344-7189

Printed in Japan

0305 (0804)