

F3S-TGR-CL2
F3S-TGR-CL4

Finger and Hand Protection Safety Light Curtain Type 2 Safety Light Curtain Type 4

Original instruction

14 mm resolution models
35 mm resolution models
70 mm resolution models



INSTALLATION AND OPERATION MANUAL

OMRON

Notice:

OMRON products are manufactured for use according to proper procedures by a qualified operator and only for the purposes described in this manual.

The following conventions are used to indicate and classify precautions in this manual. Always heed the information provided with them. Failure to heed precautions can result in injury to people or damage to property.

-  **DANGER** Indicates an imminently hazardous situation which, if not avoided, will result in death or serious injury.
-  **WARNING** Indicates a potentially hazardous situation which, if not avoided, could result in death or serious injury.
-  **Caution** Indicates a potentially hazardous situation which, if not avoided, may result in minor or moderate injury, or property damage.

OMRON Product References

All OMRON products are capitalized in this manual. The word “Unit” is also capitalized when it refers to an OMRON product, regardless of whether or not it appears in the proper name of the product.

Visual Aids

The following headings appear in the left column of the manual to help you locate different types of information.

Note Indicates information of particular interest for efficient and convenient operation of the product.

1,2,3... 1. Indicates lists of one sort or another, such as procedures, checklists, etc.

© OMRON, 2011

All rights reserved. No part of this publication may be reproduced, stored in a retrieval system, or transmitted, in any form, or by any means, mechanical, electronic, photocopying, recording, or otherwise, without the prior written permission of OMRON.

No patent liability is assumed with respect to the use of the information contained herein. Moreover, because OMRON is constantly striving to improve its high-quality products, the information contained in this manual is subject to change without notice. Every precaution has been taken in the preparation of this manual. Nevertheless, OMRON assumes no responsibility for errors or omissions. Neither is any liability assumed for damages resulting from the use of the information contained in this publication.

Read and understand this document

Please read and understand this document before using the products. Please consult your OMRON representative if you have any questions or comments.

WARRANTY

OMRON's exclusive warranty is that the products are free from defects in materials and workmanship for a period of one year (or other period if specified) from date of sale by OMRON.

OMRON MAKES NO WARRANTY OR REPRESENTATION, EXPRESS OR IMPLIED, REGARDING NON-INFRINGEMENT, MERCHANTABILITY, OR FITNESS FOR PARTICULAR PURPOSE OF THE PRODUCTS, ANY BUYER OR USER ACKNOWLEDGES THAT THE BUYER OR USER ALONE HAS DETERMINED THAT THE PRODUCTS WILL SUITABLY MEET THE REQUIREMENTS OR THEIR INTENDED USE. OMRON DISCLAIMS ALL OTHER WARRANTIES, EXPRESS OR IMPLIED.

LIMITATIONS OF LIABILITY

OMRON SHALL NOT BE RESPONSIBLE FOR SPECIAL, INDIRECT, OR CONSEQUENTIAL DAMAGES, LOSS OF PROFITS OR COMMERCIAL LOSS IN ANY WAY CONNECTED WITH THE PRODUCTS, WHETHER SUCH CLAIM IS BASED ON CONTRACT, WARRANTY, NEGLIGENCE, OR STRICT LIABILITY.

In no event shall responsibility of OMRON for any act exceed the individual price of the product on which liability asserted.

IN NO EVENT SHALL OMRON BE RESPONSIBLE FOR WARRANTY, REPAIR, OR OTHER CLAIMS REGARDING THE PRODUCTS UNLESS OMRON'S ANALYSIS CONFIRMS THAT THE PRODUCTS WERE PROPERLY HANDLED, STORED, INSTALLED, AND MAINTAINED AND NOT SUBJECT TO ABUSE, MISUSE, OR INAPPROPRIATE MODIFICATION OR REPAIR.

SUITABILITY FOR USE

OMRON shall not be responsible for conformity with any standards, codes, or regulations that apply to the combination of products in the customer's application or use of the product.

At the customer's request, OMRON will provide applicable third party certification documents identifying ratings and limitations of use that apply to the products. This information by itself is not sufficient for a complete determination of the suitability of the products in combination with the end product, machine, system, or other application or use.

The following are some examples of applications for which particular attention must be given. This is not intended to be an exhaustive list of all possible uses of the products, nor is it intended to imply that the uses listed may be suitable for the products:

Outdoor use, uses involving potential chemical contamination or electrical interference, or conditions or uses not described in this document.

Nuclear energy control systems, combustion systems, railroad systems, aviation systems, medical equipment, amusement machines, vehicles, and installations subject to separate industry or government regulations.

Systems, machines, and equipment that could present a risk to life or property.

Please know and observe all prohibitions of use applicable to the products.

NEVER USE THE PRODUCTS FOR AN APPLICATION INVOLVING SERIOUS RISK TO LIFE OR PROPERTY WITHOUT ENSURING THAT THE SYSTEM AS A WHOLE HAS BEEN DESIGNED TO ADDRESS THE RISKS, AND THAT THE OMRON PRODUCT IS PROPERLY RATED AND INSTALLED FOR THE INTENDED USE WITHIN THE OVERALL EQUIPMENT OR SYSTEM.

PERFORMANCE DATA

Performance data given in this document is provided as a guide for the user in determining suitability and does not constitute a warranty. It may represent the result of OMRON's test conditions, and the users must correlate it to actual application requirements. Actual performance is subject to the OMRON Warranty and Limitations of Liability.

CHANGE IN SPECIFICATIONS

Product specifications and accessories may be changed at any time based on improvements and other reasons.

It is our practice to change model numbers when published ratings or features are changed, or when significant construction changes are made. However, some specifications of the product may be changed without any notice. When in doubt, special model numbers may be assigned to fix or establish key specifications for your application on your request. Please consult with your OMRON representative at any time to confirm actual specifications of purchased products.

DIMENSIONS AND WEIGHTS

Dimensions and weights are nominal and are not to be used for manufacturing purposes, even when tolerances are shown.

ERRORS AND OMISSIONS

The information in this document has been carefully checked and is believed to be accurate; however, no responsibility is assumed for clerical, typographical, or proofreading errors, or omissions.

PROGRAMMABLE PRODUCTS

OMRON shall not be responsible for the user's programming of a programmable product, or any consequence thereof.

COPYRIGHT AND COPY PERMISSION

This document shall not be copied for sales or promotions without permission.

This document is protected by copyright and is intended solely for use in conjunction with the product. Please notify us before copying or reproducing this document in any manner, for any other purpose. If copying or transmitting this document to another, please copy or transmit it in its entirety.

OMRON EUROPE B.V.
Wegalaan 67-69
NL-1232 JD, Hoofddorp
The Netherlands

Tel.: +31 (0) 235681300
Fax: +31 (0) 235681388
www.industrial.omron.eu

TABLE OF CONTENTS

PRECAUTIONS	xi
1 Safety precautions	xi
2 Alert statements in this manual	xi
 SECTION 1	
Important safety warnings	1
 SECTION 2	
Product features and indicators	2
2-1 F3S-TGR-CL feature list	2
2-2 LED indicators	2
2-2-1 LED indicators on transmitter	2
2-2-2 LED indicators on receiver	2
 SECTION 3	
System Operation	3
3-1 Operating States	3
3-1-1 Machine Run	3
3-1-2 Machine Stop	3
3-1-3 Interlock	3
3-1-4 Error	3
3-2 Operating Modes	3
3-2-1 Automatic start	4
3-2-2 Start/Restart Interlock	4
3-2-3 Single break operation	4
3-2-4 Double break operation	4
3-2-5 Pre-reset operation	4
3-3 F3S-TGR-CL MIX Cascaded Series	5
3-3-1 F3S-TGR-CL MIX requirements	5
 SECTION 4	
Detection options	7
4-1 Blanking	7
4-1-1 Firmware specific features	7
4-1-2 Possible Blanking scenarios	8
4-1-3 Beam tolerance setting	8
4-1-4 Selecting Blanking with selector switches	10
4-2 Optical synchronization	10

SECTION 5		
Diagnostic and Test Features	11
5-1	LED indicators	11
5-2	External Device Monitoring (EDM)	11
5-3	External test function	12
5-4	Range selection	13
5-5	Start/Restart Input	13
5-6	Alignment support	13
SECTION 6		
Setting F3S-TGR-CL features	14
6-1	Access to the selector switches	14
6-1-1	Selector switch setting	14
6-1-2	Transmitter selector switch settings	15
6-1-3	Receiver selector switch setting	16
6-2	Selecting and programming Blanking	16
6-3	Selecting External Device Monitoring (EDM)	16
6-4	Range setting	17
6-5	Selecting Scan Codes	17
SECTION 7		
Outputs	19
7-1	Safety Outputs (OSSDs)	19
7-2	Safety Outputs (OSSDs) waveform	19
SECTION 8		
Safe Mounting Distances	21
8-1	Safety distance for safeguarding danger points	21
8-1-1	Calculation example for systems with a resolution of ≤ 40 mm	22
8-1-2	Calculation example for systems using single- or double break function	22
8-1-3	Calculation example for systems with a resolution of 40 mm to 70 mm	22
8-2	Safety distance for safeguarding danger areas	23
SECTION 9		
Installation	24
9-1	Reflective surface interference	24
9-2	Cross Talk Mitigation	25
9-3	General mounting considerations	26
9-3-1	Additional Guarding	26
9-3-2	Mechanical installation	26
9-3-3	Additional mounting rigidity	27
9-3-4	Mechanical mounting	27
9-3-5	Installation of multiple systems	28
9-3-6	Detection Zone (indication on the Front Label)	28
9-3-7	Requirements for Perimeter Guarding	28
9-3-8	Marking Minimum Object Resolution	29

SECTION 10**Connection to the Machine control circuit 30**

10-1	Input Power Requirements	30
10-2	Cables	30
10-3	Basic wiring scheme	31
10-4	Wiring to two forcibly guided relays	32
10-5	Connection to a safety relay unit	33

SECTION 11**Control functions 34**

11-1	Muting and override	34
11-1-1	Wiring	35
11-1-2	Activation and de-activation of the muting function	35
11-1-3	External muting lamp requirements	35
11-1-4	Muting input requirements	35
11-1-5	Muting modes	35
11-2	Partial Muting Configuration	40
11-2-1	Setting the partial muting function	40
11-3	Override	41
11-3-1	Override function at start-up	41
11-3-2	Override during operation cycle	42
11-4	Pre-reset function	43
11-5	Single-/Double Break function	44
11-5-1	Single break function	45
11-5-2	Double break function	46

SECTION 12**Checkout and Test procedure 48**

12-1	Checkout Procedure	48
12-2	Test Procedure	48
12-3	Using the test object	48
12-4	Regular checkout and test	49

SECTION 13	
Cleaning	50

SECTION 14	
Specification and additional information	51

14-1	Specification	51
14-2	F3S-TGR-CL standalone system Dimensional drawing	55
14-3	F3S-TGR-CL system data with 14 mm resolution	55
14-4	F3S-TGR-CL system data with 35 mm resolution	56
14-5	F3S-TGR-CL system data with 070 mm resolution	56
14-6	F3S-TGR-CL MIX system Dimensional drawing	57
14-7	F3S-TGR-CL Master system data with 14 mm resolution	58
14-8	F3S-TGR-CL Master system data with 35 mm resolution	58
14-9	F3S-TGR-CL Slave system data with 14 mm resolution	59
14-10	F3S-TGR-CL Slave system data with 35 mm resolution	59
14-11	F3S-TGR-CL Slave system data with 70 mm resolution	59
14-12	List of models standalone models	60
14-12-1	Safety Category 2, 14 mm resolution, Standalone unit	60
14-12-2	Safety Category 2, 35 mm resolution, Standalone unit	61
14-12-3	Safety Category 4, 14 mm resolution, Standalone unit	62
14-12-4	Safety Category 4, 35 mm resolution, Standalone unit	63
14-13	List of models in MIX operation	64
14-13-1	Safety Category 2, 14 mm resolution, Master unit	64
14-13-2	Safety Category 2, 35 mm resolution, Master unit	64
14-13-3	Safety Category 4, 14 mm resolution, Master unit	65
14-13-4	Safety Category 4, 35 mm resolution, Master unit	65
14-13-5	Safety Category 2, 14 mm resolution, Slave unit	66
14-13-6	Safety Category 2, 35 mm resolution, Slave unit	66
14-13-7	Safety Category 2, 70 mm resolution, Slave unit	66
14-13-8	Safety Category 4, 14 mm resolution, Slave unit	67
14-13-9	Safety Category 4, 35 mm resolution, Slave unit	67
14-13-10	Safety Category 4, 70 mm resolution, Slave unit	67
14-14	Accessories	68
14-14-1	Mechanical accessories	68
14-14-2	Mirrors	71
14-14-3	Safety Relay Units	72
14-14-4	Muting Accessories	72
14-14-5	Cables	77

SECTION 15	
Glossary	78

SECTION 16	
Diagnostics and Troubleshooting	79

16-1	Receiver Diagnostic information	79
16-1-1	Normal operation	79
16-1-2	Interlock LED indication	79
16-1-3	LED error indication	80
16-2	Transmitter Diagnostic information	81

TABLE OF CONTENTS

16-2-1	Normal operation	81
16-2-2	LED error indication	81

SECTION 17**Appendix** **82**

17-1	Checkout procedure log	82
17-2	Test procedure log	83
17-3	Wiring examples	84
17-3-1	F3S-TGR-CL and GSB-301-D in manual reset	84
17-3-2	F3S-TGR-CL and G9SB-301-D in manual reset and Muting connection	85
17-3-3	F3S-TGR-CL in combination with DST1-ID12SL1	86
17-3-4	F3S-TGR-CL with DST1-MD16-SL1	87
17-3-5	F3S-TGR-CL and G7SA-3A1B and EDM function	88

Revision history **89**

TABLE OF CONTENTS

PRECAUTIONS

1 Safety precautions

In order to use the F3S-TGR-CL system safely, the precautions listed in this manual indicated by alert symbols and descriptions must be followed. Failure to follow all precautions and alerts may result in an unsafe use or operation.

The following indications and symbols are used for the application:

-  **WARNING** This sign indicates a potentially hazardous situation which, if not avoided, will result in minor or moderate injury, or may result in serious injury or death. Additionally there may be significant property damage.

2 Alert statements in this manual

2-1 For users

-  **WARNING** The F3S-TGR-CL system must be installed, configured, and incorporated into a machine control system by a sufficiently trained and qualified person. An unqualified person may not be able to perform these operations properly, which may cause a person to go undetected, resulting in serious injury.

-  **WARNING** When changes are made to each function using the selector switches, the administrator must manage the detail of the changes and perform the changes. Accidental functional setting change may cause failure of human body detection, resulting in a serious injury.

2-2 For machines

-  **WARNING** Do not use this sensor for machines that cannot be stopped by electrical control. For example, do not use it for a pressing machine that uses a full-rotation clutch. Otherwise, the machine may not stop before a person reaches the hazardous part, resulting in serious injury.













-  **WARNING** Do not use the auxiliary output or external indicator output for safety applications. A human body may not be detected when F3S-TGR-CL system fails, resulting in serious injury.









2-3 For installations

-  **WARNING** After unpacking and before installing the F3S-TGR-CL system please check the mechanical condition of the system carefully. Do not install a mechanically damaged product. Return this to your OMRON service for inspection or repair. Failure to do so may result in serious injury.



-  **WARNING** Do not drop the products. Dropping the products may lead to internal or external damage. Please return a F3S-TGR-CL system that was dropped on the floor to your OMRON service for inspection or repair. Failure to do so may result in serious injury.

-  **WARNING** Make sure to test the operation of the F3S-TGR-CL system after installation to verify that the F3S-TGR-CL system operates as intended. Make sure to stop the machine until the test is complete. Unintended function settings may cause a person to go undetected, resulting in serious injury.

-  **WARNING** Make sure to install the F3S-TGR-CL system at a safe distance from the hazardous part of the equipment. Otherwise, the machine may not stop before a person reaches the hazardous part, resulting in serious injury.
-  **WARNING** Install a protective structure so that the hazardous part of a machine can only be reached by passing through the sensor's detection zone. Install the sensors so that part of the person is always present in the detection zone when working in a machine's hazardous areas. If a person is able to step into the hazardous area of a machine and remain behind the F3S-TGR-CL system's detection zone, configure the system with an interlock function that prevents the machine from being restarted. Failure to do so may result in serious injury.
-  **WARNING** Install the interlock switch in a location that provides a clear view of the entire hazardous area and where it cannot be activated from within the hazardous area.
-  **WARNING** The F3S-TGR-CL system cannot protect a person from a projectile exiting the hazardous zone. Install protective cover(s) or fence(s).
-  **WARNING** To prevent personnel approaching a dangerous part of the machine through a zone disabled by the blanking function, you must install a protective structure to cover the whole disabled zone. Failure to do so may cause failure of human body detection, resulting in a serious injury.
-  **WARNING** You must ensure that a test rod is detected for all detection zones except where the blanking function is used. Failure to do so may cause failure of human body detection, resulting in a serious injury.
-  **WARNING** Detection capability gets larger if blanking function is used. You must use the detection capability for blanking functions. Failure to do so may cause failure of machine stop before reaching the machine's dangerous part, resulting in a serious injury.
-  **WARNING** The muting and override functions disable the safety functions of the device. You must ensure safety using other method when these functions are operating.
-  **WARNING** Install muting sensors so that they can distinguish between the object that is being allowed to pass through the detection zone and a person. If the muting function is activated by the detection of a person, it may result in serious injury.
-  **WARNING** Muting lamps (external indicators) that indicate the state of the muting and override functions must be installed where they are clearly visible to workers from all the operating positions.
-  **WARNING** A sufficiently trained and qualified person must properly configure muting related timings for its specific application, and that person must have responsibility for settings, especially when the muting time limit is infinite.
-  **WARNING** Use two independent input devices for muting inputs.
-  **WARNING** You must install F3S-TGR-CL system muting sensor, and physical barrier, and configure time settings for muting so that an operator can not enter hazardous zone.

-  **WARNING** Install the switch that activates the override in a location that provides a clear view of the entire hazardous area and where it cannot be activated from within the hazardous area. Make sure that nobody is in the hazardous area before activating the override function.
-  **WARNING** Do not place fluorescent and/or incandescent lights within the effective aperture angle of the receiver, as it may influence the F3S-TGR-CL system under certain circumstances.
-  **WARNING** Install the sensor system so that it is not affected by any reflective surfaces. Failure to do so may hinder detection, resulting in serious injury.
-  **WARNING** When using more than 1 set of F3S-TGR-CL system, install them so that mutual interference does not occur, such as by configuring series connections or using physical barriers between adjacent sets.
-  **WARNING** Make sure that the F3S-TGR-CL system is securely mounted and its cables and connectors are properly connected.
-  **WARNING** Make sure that foreign objects such as water, oil, or dust do not enter the inside of the F3S-TGR-CL system while the cover for the selector switches is open and tighten the screws of the cover firmly after changing the settings.
-  **WARNING** Do not use the sensor system with mirrors in a retro-reflective configuration. Doing so may hinder detection. It is possible to use mirrors to "bend" the detection zone to a 90° angle.
-  **WARNING** Perform an inspection for all F3S-TGR-CL systems as described in the chapter "Checkout and test procedure". When using series connections, perform inspections for every connected F3S-TGR-CL system.

2-4 For wiring

-  **WARNING** Do not short-circuit the output line to the +24 V line. Otherwise, the output is always ON. Also, the 0 V of the power supply must be grounded so that the output does not turn ON due to grounding of the output line.
-  **WARNING** Configure the system by using the optimal number of safety outputs that satisfy the requirements of the necessary safety category.
-  **WARNING** Do not connect each line of F3S-TGR-CL system to a DC power supply of more than 24 VDC+20%. Also, do not connect to an AC power supply. Failure to do so may result in electric shock.

 **WARNING** For the F3S-TGR-CL system to comply with IEC 61496-1 and UL 508, the DC power supply unit must satisfy all of the following conditions:

- Must be within the rated power voltage (24 V DC \pm 20%)
- Must have tolerance against the total rated current of devices if it is connected to multiple devices
- Must comply with EMC directives (industrial environment)
- Double or reinforced insulation must be applied between the primary and secondary circuits
- Automatic recovery of overcurrent protection characteristics
- Output holding time must be 200 ms or longer
- Must satisfy output characteristic requirements for class 2 circuit or limited voltage current circuit defined by UL508
- Must comply with laws and regulations, regarding EMC and electrical equipment safety, of the country or region where the F3S-TGR-CL system is used (Ex: In EU, the power supply must comply with the EMC Directive and the Low Voltage Directive.)

 **WARNING** Double or reinforced insulation from hazardous voltage must be applied to all input and output lines. Failure to do so may result in electric shock.

 **WARNING** Extension of the cable must be within a specified length. If it isn't, safety function may not work properly, resulting in danger.

2-5 Other

 **WARNING** To use the F3S-TGR-CL system in PSDI mode (Re-initiation of cyclic operation by the protective equipment), you must configure an appropriate circuit between the F3S-TGR-CL system and the machine.

 **WARNING** Do not try to disassemble, repair, or modify this product. Doing so may cause the safety functions to stop working properly.

 **WARNING** Do not use the F3S-TGR-CL system in environments where flammable or explosive gases are present. Doing so may result in an explosion.

 **WARNING** Perform daily and 6-monthly inspections for the F3S-TGR-CL system. Otherwise, the system may fail to work properly, resulting in serious injury.

 **WARNING** If the F3S-TGR-CL system is used in an environment where foreign materials such as spatter may adhere to the product, use a cover to protect the F3S-TGR-CL system or inspect and clean the F3S-TGR-CL system periodically.

 **WARNING** Do not use the F3S-TGR-CL system in an atmosphere containing oil mist or corrosive gas. Failure to do so may result in damage of the product.

 **WARNING** When scrapping the F3S-TGR-CL system, please make sure to comply with the waste treatment regulations of the country where the product has been used.

2-6 Precautions for Safe Use

Make sure to observe the following precautions that are necessary for ensuring safe use of the product.

- Thoroughly read this manual and understand the installation procedures, operation check procedures, and maintenance procedures before using the product.
- Loads must satisfy both of the following conditions:
 - Not short-circuited
 - Not used with a current that is higher than the rating
- Do not drop the product
- Dispose of the product in accordance with the relevant rules and regulations of the country or area where the product is used.

2-7 Precautions for Correct Use

Observe the precautions described below to prevent operation failure, malfunctions, or undesirable effects on product performance.

2-8 Installation environment

Do not install the F3S-TGR-CL system in the following types of environments:

- Areas exposed to intense interference light, such as direct sunlight
- Areas with high humidity where condensation is likely to occur
- Areas where corrosive gases are present
- Areas exposed to vibration or shock levels higher than in the specification provisions
- Areas where the product may come into contact with water
- Areas where the product may come into contact with oil that is an adhesive solvent

Do not use radio equipment such as cellular phones, walkie-talkies, or transceivers near the F3S-TGR-CL system.

2-9 Wiring and installation

- Make sure to perform wiring while the power supply is OFF. Otherwise, the F3S-TGR-CL system may fail to operate due to the diagnosis function.
- When replacing the cable connectors with other types of connectors, use connectors that provide a proper grade of protection.
- Properly perform the wiring after confirming the signal names of all the terminals.
- Do not operate the control system until 2 seconds or more (2.2 seconds or more in case of series connection) after turning ON the power of the F3S-TGR-CL system.
- Be sure to route the F3S-TGR-CL system cable separate from high-potential power lines or through an exclusive conduit.
- When using a commercially available switching regulator power supply, make sure to ground the FG terminal (frame ground terminal).
- Install the transmitter and receiver so that their vertical direction should match.

 **WARNING** When substituting/replacing the F3S-TGR-CL system with an equivalent F3S-TGR-CL system, remember to set the dip-switches of the new F3S-TGR-CL system the same as the old one. Failure to do so may cause serious injury.

2-10 Cleaning









Do not use thinner, benzene, or acetone for cleaning, they affect the product's resin parts and paint on the case.

2-11 Object detection

The F3S-TGR-CL system cannot detect transparent and/or translucent objects.

2-12 Definition of symbols

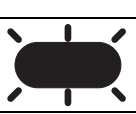
The following symbols are used to illustrate user operations in the F3S-TGR-CL system.

SYMBOL	MEANING
	Turn OFF the entire F3S-TGR-CL system by removing the power supply.
	Turn ON the entire F3S-TGR-CL system by activating power supply.
	Set the selector switches accordingly
	Press the related pushbutton/command (change from its normal status)
	Release the related pushbutton/command (return to its normal status)
	Diagnosis LED off
	Diagnosis LED on
	Diagnosis LED blinking
	Important information

SECTION 1

Important safety warnings

 **WARNING** Read and understand this section prior to installing an F3S-TGR-CL system.

A F3S-TGR-CL system is a general purpose sensing device designed to guard personnel working around moving machinery.

Whether a specific machine application and F3S-TGR-CL system installation complies with safety regulations depends on the proper application, installation, maintenance and operation of the F3S-TGR-CL system. These items are the responsibility of the purchaser, installer and employer.

The employer is responsible for the selection and training of personnel to properly install, operate and maintain the machine and its safeguarding systems. A F3S-TGR-CL system should only be installed verified and maintained by a qualified person. A qualified person is defined as "an individual who understands, is trained on, and demonstrates competence with the construction, operation or maintenance of the machinery and the hazards involved."

To use the F3S-TGR-CL system the following requirements must be met:

- The national/international rules and regulations apply to the installation, use and periodic technical inspections of the safety light curtain, in particular:
 - Machine Directive (2006/42/EC)
 - Equipment Usage Directive (89/655/EC)
 - The work safety regulations/safety rules
 - Other relevant health and safety regulations
- Observe the instructions in this manual regarding test regulations (e.g. on use, mounting, installation or integration into the existing machine control system) carefully.
- The tests must be carried out by specialist personnel or specially qualified and authorized personnel and must be recorded and documented to ensure that the tests can be reconstructed and retraced at any time.
- Check the effectiveness of the protective device after every change because a change may degrade the safety function.
- The operating instructions must be made available to the operator of the machine where the F3S-TGR-CL system is installed.
- The machine operator is to be instructed in the use of the device by specialist personnel and must be instructed to read the operating instructions.
- The guarded machine must not present a hazard from flying parts.
- The guarded machine must have a consistent stopping time and adequate control mechanisms.
- Additional guarding may be required for access to dangerous areas not covered by the F3S-TGR-CL system.

Protection of the environment

This product has been designed to minimize environmental impact. For this reason please note that disposal of irreparable/unserviceable devices has to be in compliance with your local/national rules and regulations. Please contact your local OMRON sales representative for assistance.

SECTION 2

Product features and indicators

2-1 F3S-TGR-CL feature list

The F3S-TGR-CL safety light curtain family is available in two versions. These versions are identified as the F3S-TGR-CL_A and F3S-TGR-CL_B versions. Configuration of the safety light curtains can be changed through selector switches located under an access cover.

F3S-TGR-CL series feature comparison:

Feature	F3S-TGR-CL_B	F3S-TGR-CL_A
Scan Code for Cross-Talk-Mitigation	X	X
EDM External Device Monitoring	X	X
Adjustable Mounting Brackets and T-Slots	X	X
Two PNP safety outputs	X	X
Range Selection	X	X
External test initiation	X	X
Integrated muting function		X
Floating Blanking		X
Single/double break operation		X
Pre-reset operation		X
Master/Slave cascaded systems		X

2-2 LED indicators

LED indicators are located in the connector end caps to show the status of the F3S-TGR-CL system.

2-2-1 LED indicators on transmitter

Disposition of indicator	Name of indicator	Colour
	POWER	Green
	STATUS 1	Yellow
	RANGE	Green
	Not used	Red
	STATUS 2	Yellow

2-2-2 LED indicators on receiver

Disposition of indicator	Name of indicator	Colour
	POWER	Green
	STATUS	Yellow
	GUARD	Green
	BREAK	Red
	INTERLOCK	Yellow

SECTION 3

System Operation

The F3S-TGR-CL system is a microprocessor-controlled, infrared, transmitted-beam safety light curtain. The system consists of a receiver assembly and a transmitter assembly. The receiver and transmitter assemblies are not physically interconnected.

It complies with a Type 2 or Type 4 according to EN/IEC 61496 and up to PLc or PLe according to EN ISO 13849-1 (2008), depending on the model .

A F3S-TGR-CL system is used where personnel protection is required, typical applications include packaging machines, front- or back side protection of presses and textile machinery.

3-1 Operating States

The operating condition of a F3S-TGR-CL system is described in terms of states. The following operating states exist for a F3S-TGR-CL system.

3-1-1 Machine Run

The two receiver safety outputs are in the ON state, the green GUARD indicator is lit. The protected machine is allowed to operate. Pressing and releasing the restart button has no effect.

3-1-2 Machine Stop

The two receiver safety outputs are in the OFF state the red BREAK indicator is lit. The protected machine is not allowed to operate.

3-1-3 Interlock

The two receiver safety outputs are in the OFF state, the red BREAK indicator and yellow INTERLOCK indicator are lit. The INTERLOCK state does not allow the protected machine to operate until the detection zone is clear of obstructions and the restart button is pressed and released.

3-1-4 Error

The two receiver safety outputs are in the OFF state, an error code is shown via the blinking indicators. The error state does not allow the protected machine to operate. The primary difference between ERROR and INTERLOCK is that the F3S-TGR-CL system will remain in the error state until the error is corrected, and then applying a power cycling or an external restart button press and release.

3-2 Operating Modes

System operating modes determine the start-up and operating behavior of a F3S-TGR-CL system. Operating modes definitions rely on the operating states presented above. Operating mode selection may be performed via the configuration switches on the F3S-TGR-CL transmitter and receiver.

Note If internal errors are detected by the system during power-up or operation, it will enter the Error state with its safety outputs in the OFF state.

3-2-1 Automatic start

The F3S-TGR-CL will power-up with its safety outputs OFF, and if the detection zone is not obstructed, enters the MACHINE RUN state. In this state, when an object is sensed entering the detection zone, the F3S-TGR-CL system will change from MACHINE RUN to MACHINE STOP and remain in this state until the obstruction is removed. Once the detection zone is clear, the F3S-TGR-CL system will automatically change from MACHINE STOP to MACHINE RUN.

3-2-2 Start/Restart Interlock

 **WARNING** The TEST/RESTART button must be located so that the operator can see the protected area when restarting, testing or overriding.

The F3S-TGR-CL will power-up with its safety outputs off and enter the INTERLOCK state if the detection zone is clear. To initially enter the MACHINE RUN state the operator must press and release the Restart button. Once in the MACHINE RUN state, when an object is sensed entering the detection zone, the system will change to the MACHINE STOP state. When the detection zone is cleared, the system will not automatically change to MACHINE RUN but enter the INTERLOCK state instead. The operator must always press and release the Restart button to enter MACHINE RUN. If the detection zone is not clear the Restart button will have no effect.

3-2-3 Single break operation

This operation mode can be used on small press machines where the operator is doing a loading or unloading cycle manually. The F3S-TGR-CL will power-up with its safety outputs off and enter the INTERLOCK state if the detection zone is clear. F3S-TGR-CL system will enter the MACHINE RUN state when the detection zone was entered and cleared again. It will change to INTERLOCK state automatically when one cycle of the machine is finished. The cycle can be restarted by entering and clearing the detection zone again.

3-2-4 Double break operation

This operation mode is similar to single break operation except: Operator is doing a loading and an unloading cycle manually. F3S-TGR-CL system will enter the MACHINE RUN state when the detection zone was entered and cleared again twice.

3-2-5 Pre-reset operation

The Pre-Reset function is used in installations where operators inside the dangerous zone can be hidden by parts of the installation. A second Reset pushbutton (Pre-reset) is added inside the dangerous zone. Before leaving the dangerous zone, the operator has to operate the Pre-reset pushbutton. This enables the Restart pushbutton outside the dangerous zone.

The F3S-TGR-CL will power-up with its safety outputs off and enter the INTERLOCK state if the detection zone is clear. To initially enter the MACHINE RUN state the operator must press and release the Pre-reset and Restart button. Once in the MACHINE RUN state, when an object is sensed entering the detection zone, the system will change to the MACHINE STOP state. When the detection zone is cleared, the system will not automatically change to MACHINE RUN but enter the INTERLOCK state instead. The operator must always press and release the Pre-reset and the Restart button in this sequence to enter MACHINE RUN. If the detection zone is not clear the Pre-reset or Restart button will have no effect.

3-3 F3S-TGR-CL MIX Cascaded Series

The F3S-TGR-CL series safety light curtain is available in a cascaded version, referred to as the F3S-TGR-CL MIX series. Multiple transmitters/receivers can be connected in series. This type of arrangement permits the F3S-TGR-CL MIX to guard multiple areas of a machine or can be used in a combination of vertical and horizontal guarding.

3-3-1 F3S-TGR-CL MIX requirements

The F3S-TGR-CL MIX is offered in protective heights ranging from 150 mm up to 2250 mm for safety light curtains with 14 mm, 35 mm and 70 mm resolution or body protection models.

- A F3S-TGR-CL MIX system has a maximum size limitation based on the number of beams (14 mm resolution = 336 beams, 35 mm resolution = 128 beams, 70 mm resolution = no limitation, Body protection = 16 beams). A master/slave system cannot exceed the total length of 2400 mm and if the number of beams is higher than the max. number of optics of the model an error will be indicated.
- Possible combinations are shown in the table of possible combinations on the next page.
- A F3S-TGR-CL MIX system is made of one master segment and one slave segment.
- The interconnect cable length limitation between the two segments is 900 mm.

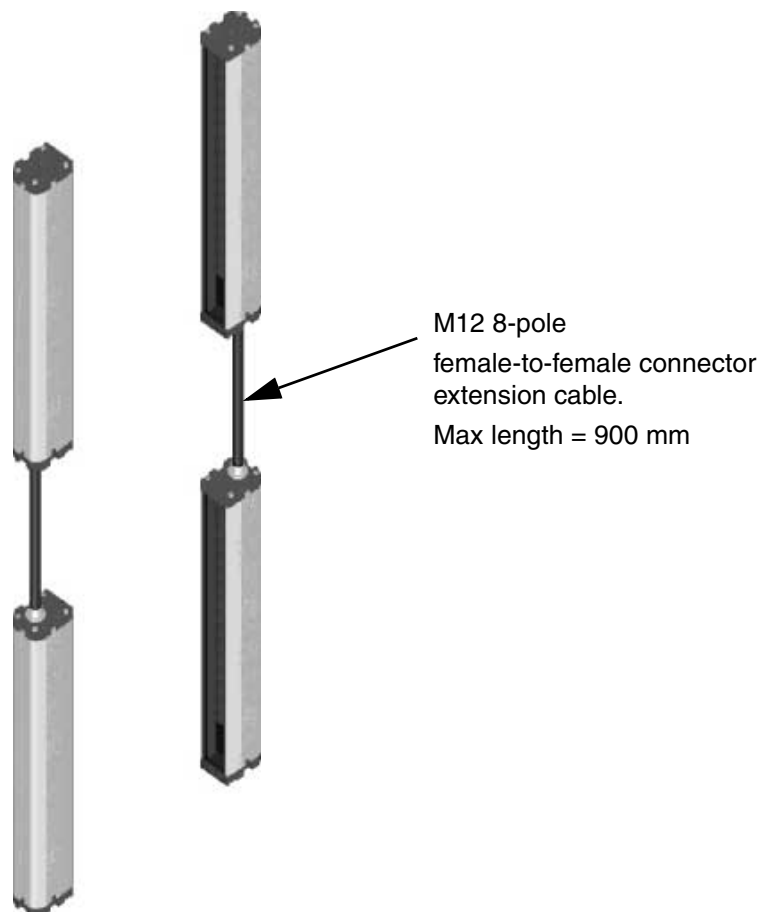

Possible combinations

Master Slave 014 or 035 types

		Slave (014 or 035)														
		300	450	600	750	900	1050	1200	1350	1500	1650	1800	1950	2100	2250	2400
Master (014 or 035)	300	X	X	X	X	X	X	X	X	X	X	X	X	X		
	450	X	X	X	X	X	X	X	X	X	X	X	X			
	600	X	X	X	X	X	X	X	X	X	X	X				
	750	X	X	X	X	X	X	X	X	X	X					
	900	X	X	X	X	X	X	X	X	X						
	1050	X	X	X	X	X	X	X	X							
	1200	X	X	X	X	X	X	X								
	1350	X	X	X	X	X	X									
	1500	X	X	X	X	X										
	1650	X	X	X	X											
	1800	X	X	X												
	1950	X	X													
	2100	X	X													
	2250															
	2400															

Slave 070 with Master 014 or 035 types

		Slave (070)							
		300	600	900	1200	1500	1800	2100	2400
Master (014 or 035)	300	X	X	X	X	X	X	X	
	450	X	X	X	X	X	X		
	600	X	X	X	X	X	X		
	750	X	X	X	X	X			
	900	X	X	X	X	X			
	1050	X	X	X	X				
	1200	X	X	X	X				
	1350	X	X	X					
	1500	X	X	X					
	1650	X	X						
	1800	X	X						
	1950	X							
	2100	X							
	2250								
	2400								

SECTION 4

Detection options

- ⚠ WARNING** Use of Blanking will make a F3S-TGR-CL system less sensitive to objects in the detection zone. Improper use of this feature can result in severe injury to personnel.
- ⚠ WARNING** Blanking may require an additional hard barrier guard.
- ⚠ WARNING** Blanking may require an increase in the safety distance. Read the following section carefully.
- ⚠ WARNING** Do not use the Blanking function together together with a Master/Slave system in vertical/horizontal guarding applications. Improper setting of the blanking zone can result in severe injury to personnel. Use two standalone units to solve this application.

4-1 Blanking

A selectable number of optical channels can be obstructed at any location in the detection zone as long as the optical synchronization is maintained. The beam opposite side to the connector end-cap is used for optical synchronization and cannot be blanked.

An object can freely float from one end of the protective field to the other without the F3S-TGR-CL system entering the MACHINE STOP state (With the exception of the synchronization beam.). The obstructed channels are not fixed at a single location but "float" through the detection zone. It is possible to have multiple blanked areas of different sizes. Setting of Blanking is done by a teach-in.

Example using additional mechanical guarding:

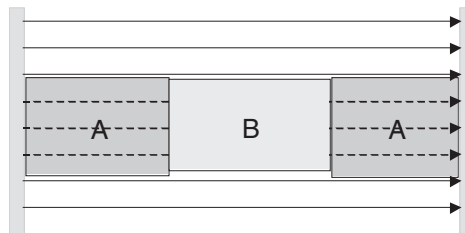

Where

A = additional mechanical guard

B = machine part that permanently blocks 3 beams, eg. a support table

4-1-1 Firmware specific features

Firmware 1.2.5

To enable blanking function using the dip switches, an object needs to be present. If blanking is enabled without an object (no beam interrupted), the blanking setting is cleared.

Firmware 1.3.6

When blanking is enabled without an object present, the default blanking zone is 1 beam with 0 beam tolerance. Blanking zone is cleared by disabling the blanking function using the dip-switches.

4-1-2 Possible Blanking scenarios

⚠ WARNING All three situations will lead to a valid Blanking condition. Please check your application carefully. Failure to do so may result in serious injury.

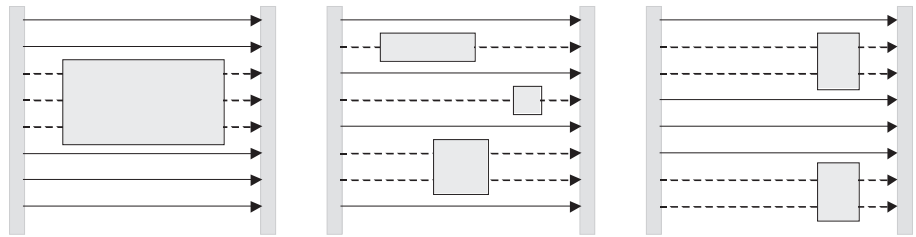

The F3S-TGR-CL system is monitoring the number of blocked beams. The position of the object(s) is not monitored.

There are two limitations for the Blanking function:

1. Maximum percentage of blanked beams out of total beams is 30%
2. Maximum number of blanked beams is 21.

The Blanking function is active as long as the beams obstructed during the teach-in remain blocked. If the number of beams obstructed is higher or lower, the F3S-TGR-CL system will change to ERROR state with the "INTERLOCK" and "BREAK" LEDs blinking. To reset this error, press and release the TEST/RESTART pushbutton when the object is in the detection zone again.

4-1-3 Beam tolerance setting

⚠ WARNING Different pattern tolerances influence the resolution of the system and require an increase in the safety distance. Read the following section carefully.

Machine parts or the objects that obscure the detection zone can move or vibrate. This causes tolerances in the beam pattern.

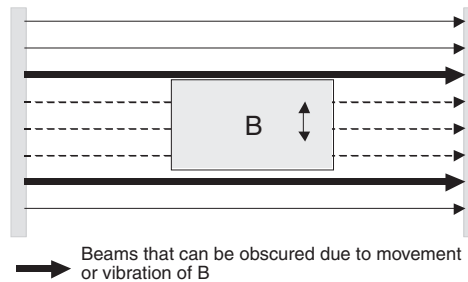

The F3S-TGR-CL system includes different beam tolerance settings via the selector switches to cover these requirements:



Object that can obscure one beam more than the blanked area



Object that can move along the sensing area

Resolution in Blanking modes:

Name	Tolerance	Resolution		
		F3S-TGR-CL-014	F3S-TGR-CL-035	F3S-TGR-CL-070
Blanking ±1	Pattern ±1 beam	28 mm	70 mm	140 mm
Blanking +1	Pattern +1 beam	21 mm	53 mm	105 mm
Blanking ±0	Pattern	14 mm	35 mm	70 mm

Note Muting and Blanking function can be used in combination in two configurations:

- Muting is active on all modules and blanking activation sequence T is used
- Muting is active on all modules and blanking activation sequence L is used

⚠ WARNING Clearly mark the resolution of the F3S-TGR-CL system after setting the blanking mode on the label of the transmitter and receiver element of the F3S-TGR-CL system and re-calculate the safety distance if necessary.

4-1-4 Selecting Blanking with selector switches

Using the selector switches an authorized user can activate the Blanking function as follows:

To set the Blanking function, place an object in the detection zone and follow this sequence:

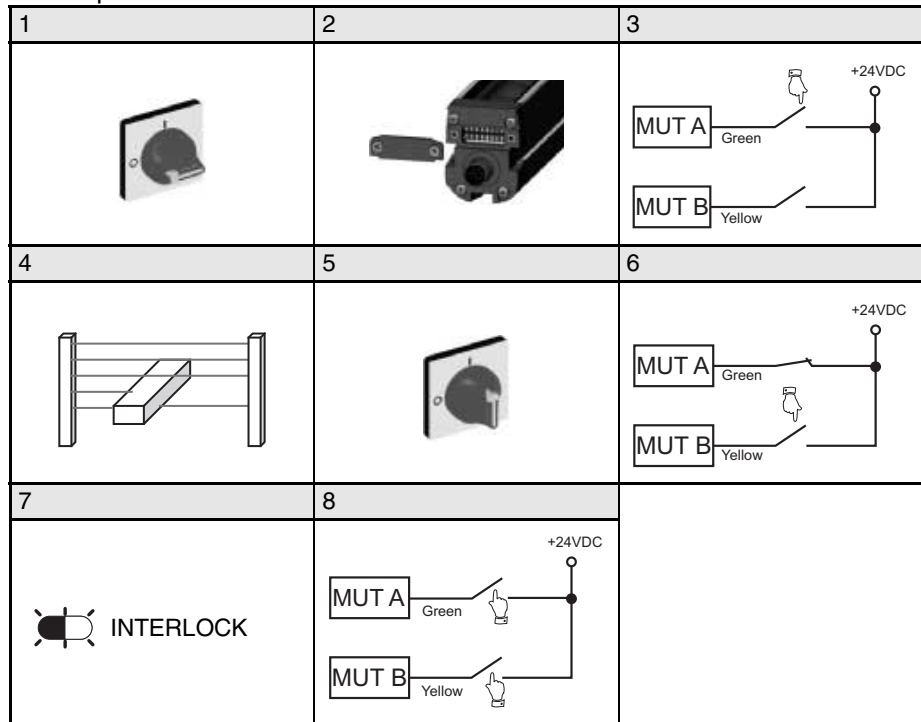

To set DIP Switch settings please refer to chapter 6-1-3 Receiver selector switch setting.

To clear a previously memorized object it is necessary a new memorization procedure.

To exclude the blanking function it is necessary to deactivate the blanking function by the user dip-switch.

Memorization sequences without object in the sensing field do not exclude the blanking function and keep alive the beam tolerance management.

Caution The blanking zone is not erased from the memory of the Safety light curtain when the blanking function is disabled. If a blanking sequence is started without an object, be aware that the default blanking setting (1 beam blanking zone and 0 beam tolerance) is enabled.

4-2 Optical synchronization

The synchronization between the F3S-TGR-CL system transmitter and receiver is optical synchronization. To establish synchronization the system needs to have the beam opposite side of the connector end cap clear. If this beam is blocked, the system will enter a MACHINE STOP state. This restriction needs to be considered in blanking operation as well.

SECTION 5

Diagnostic and Test Features

5-1 LED indicators

All F3S-TGR-CL systems have visible LED on the receiver element to show the proper alignment of the system. These LEDs are used during alignment process and they are not part of the safety critical system. A failure in one of these indicators will not cause an alarm condition and the system will continue to operate.

5-2 External Device Monitoring (EDM)

EDM is an important safety function. It monitors the F3S-TGR-CL system interface to the guarded machine, checks to ensure that the control elements are responding correctly to the light curtain and detects any inconsistency between the two external control devices. This is necessary to detect a malfunction within the interface which prevents a stop signal from reaching the machine controller. The connection for the EDM is made at the receiver. On power-up, the F3S-TGR-CL system looks for a closed to +24 VDC condition. If this is found, it will enter a state consistent with the selected operating mode. When the F3S-TGR-CL system enables its safety outputs, it monitors the external devices for a closed to open transition. This transition must occur within 300 ms or the F3S-TGR-CL system will then enter an alarm state. Additionally, if the EDM connections are incorrectly wired, the system will enter an alarm state.

The EDM function can be activated and deactivated using the selector switches on the receiver unit (both DIP Switch Nr.6).

Wiring diagram:

K1 and K2 are standard contactors, KM1 and KM2 are NC contacts (forcibly guided) of K1 and K2.

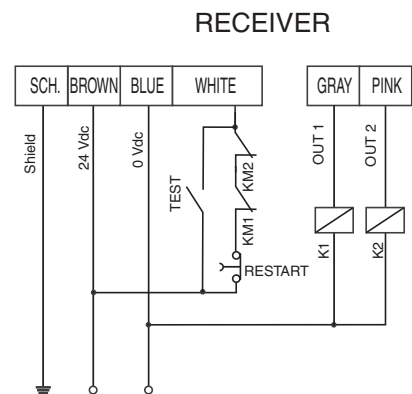

Timing diagram:

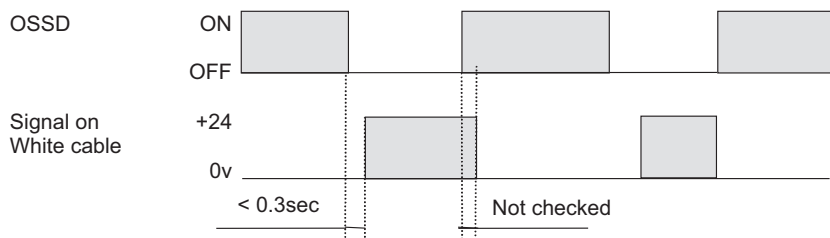

5-3 External test function

Some category 4 applications require that the machine guarding system is tested by the machine controller during a non-hazardous portion of the machine cycle to verify that the guarding system is functioning properly. In category 2 the test should be done by machine operator. F3S-TGR-CL system offers a test function on the transmitter or on the receiver element.

Transmitter:

The test function is provided by placing a normally-open switch on the test input of the transmitter. If the transmitter recognizes a +24VDC signal, a beam block state will be simulated on the transmitter and the receiver will enter the MACHINE STOP state.

Wiring diagram:

TRANSMITTER

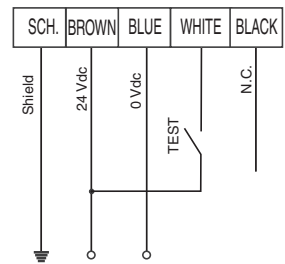

Receiver:

The test function is provided by placing a switch on the test/restart input of the receiver.

If the outputs are in OFF state, the system will run a start-up-test and if the beams are free, it will change to MACHINE RUN state.

If the outputs are in ON state and the test/restart input is activated for more than 2sec., the system will enter MACHINE STOP state and run a start-up-test (for Category 2 control systems).

Wiring diagram with EDM disabled:

RECEIVER

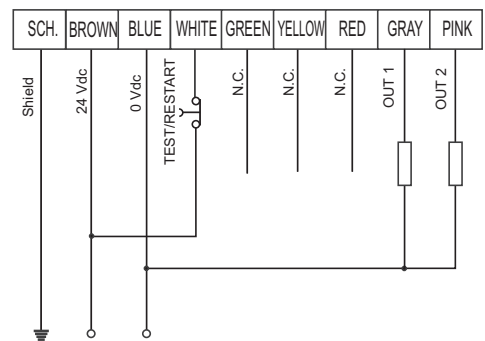

Wiring with EDM enabled:

RECEIVER

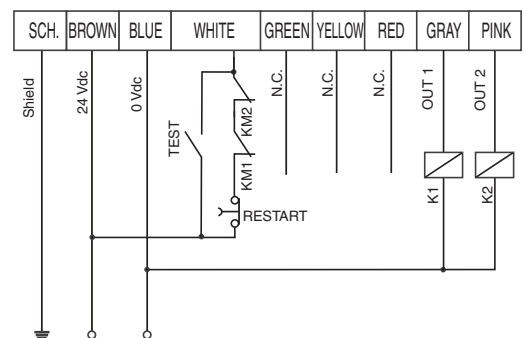

5-4 Range selection

The F3S-TGR-CL system offers operating range selection. Please refer to the detailed technical data in the list of models. This function is useful when there are many light curtains operating within a small space and the possibility of cross-talk is likely.

5-5 Start/Restart Input

The characteristic of the Start/Restart Input is shown in the following schematic:



5-6 Alignment support

Alignment of the F3S-TGR-CL system is supported by the alignment support mode.

1	2	3	4
	<div style="border: 1px solid black; padding: 2px; display: inline-block;">WHITE</div> Leave disconnected		Mechanically adjust sensors to reach the alignment if necessary.
5	6	7	8
When alignment Ok: POWER STATUS GUARD INTERLOCK		<div style="border: 1px solid black; padding: 2px; display: inline-block;">WHITE</div> Reconnect	

SECTION 6

Setting F3S-TGR-CL features

⚠ WARNING Make sure that foreign objects such as water, oil, or dust do not enter the inside of the F3S-TGR-CL system while the cover for the selector switches is open.

6-1 Access to the selector switches

The switches are located behind a cover on both the transmitter and receiver. The covers are opened by loosening two retaining screws (see illustration below).

Disconnect the power supply before changing the switch settings.



6-1-1 Selector switch setting

■ = dip-switch level position (Factory default setting)

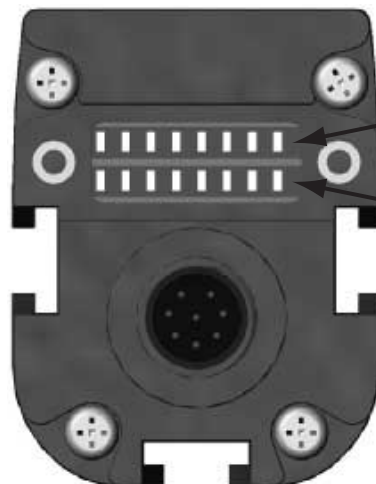

	1	2	3	4	5	6	7	8
OFF	■	■	■	■	■	■	■	■
ON								■

	1	2	3	4	5	6	7	8
OFF	■	■	■	■	■	■	■	■
ON								■

OFF is the upper position and ON is the lower position.

Note Make sure to always set switches in both banks to the same position (except switch 7 on the receiver).

6-1-2 Transmitter selector switch settings

Selector switches 5 - 8 are not used in the transmitter.

Switch Position	Setting	Function		Default
1	OFF	RANGE SETTING	–	
	ON		SHORT RANGE	X
2	OFF	RANGE SETTING	–	X
	ON		LONG RANGE	
3	OFF	CODE SETTING	NO CODING	X
	ON		CODING	
4	OFF	CODE SELECTION	CODE A	
	ON		CODE B	

Please refer to the table below for the range setting:

SW-1	SW-2	Range selected
OFF	OFF	NOT ALLOWED
OFF	ON	LONG RANGE
ON	OFF	SHORT RANGE
ON	ON	NOT ALLOWED

6-1-3 Receiver selector switch setting

Firmware 1.3.6

Switch	Status			Function
8	OFF			Manual reset Single break if SB/DB selected
	ON			Automatic reset Double break if SB/DB selected
7	OFF			Refer to CODING section for further information
	ON			
6	OFF			EDM function disabled
	ON			EDM function enabled
5 + 4 ¹	4	5	MUTING and SPECIAL FUNCTIONS	
	OFF	OFF	MUTING T + timeout + 0.2 s deactivation	
	OFF	ON	MUTING L + timeout + 0.2 s deactivation	
	ON	OFF	MUTING X + timeout + 0.2 s deactivation	
	ON	ON	SPECIAL FUNCTION WITH Switches 1, 2 and 3	
MUTING MAPS when MUTING T, L or X are selected on switches 4 and 5²				
3 + 2 + 1	1	2	3	
	OFF	OFF	OFF	Muting active over all light curtain
	OFF	OFF	ON	Muting active on module 1,2,3 and 4
	OFF	ON	OFF	Muting active on module 1,2 and 3
	OFF	ON	ON	Muting active on module 1 and 2
	ON	OFF	OFF	Muting active on module 1
	ON	OFF	ON	Muting active on module 2
	ON	ON	OFF	Muting active on module 3
ON	ON	ON	Muting active on module 4	
Special functions selection when switches 4 and 5 are both ON³				
3 + 2 + 1	1	2	3	
	OFF	OFF	OFF	Blanking ±1 beam with T muting
	OFF	OFF	ON	Blanking +1/-0 beam with T muting
	OFF	ON	OFF	Blanking ±0 beam with T muting
	OFF	ON	ON	Blanking ±1 beam with L muting
	ON	OFF	OFF	Blanking +1/-0 beam with L muting
	ON	OFF	ON	Blanking ±0 beam with L muting
	ON	ON	OFF	Pre-Reset mode
ON	ON	ON	Single/double break. Change meaning of dip 8	

1. Selector switches 4 and 5 are operational if a muting indicator is connected or both are set to the ON position.
2. Selector switches 1, 2 and 3 are operational if a muting function is set and a muting indicator is connected.
3. Selector switches 1, 2 and 3 are operational if selector switches 4 and 5 are in ON position.

Note Factory Settings:

RX: All OFF except both DIP switch 8

TX: All OFF except both DIP switch 1

6-2 Selecting and programming Blanking





Refer to *Blanking* on page 7 for details on selecting and programming Blanking function.

6-3 Selecting External Device Monitoring (EDM)

EDM is activated by setting position 6 of Switches A and B located on the receiver. Any mismatch between the settings of Switches A and B will result in an alarm condition.

6-4 Range setting

Operating range is set using switches 1 and 2 on the transmitter. Please refer to the table for valid switch position settings.

1	2	3
	 TX	1 -> ON 2 -> OFF
		1 -> OFF 2 -> ON
		4
		5
		 RANGE: → LONG RANGE  RANGE: → SHORT RANGE

⚠ WARNING Never use a long range light curtain for distances under the operating range. Failure to do so may cause serious injury.

6-5 Selecting Scan Codes



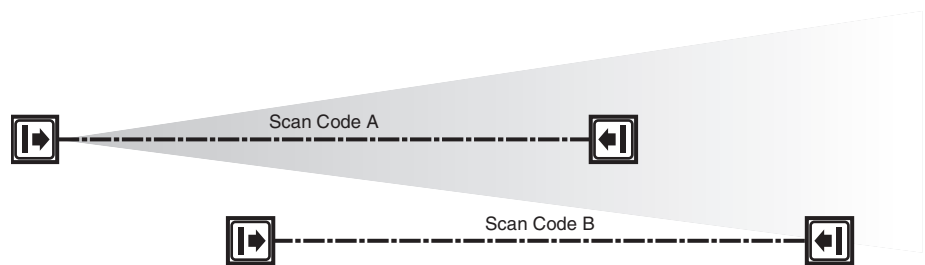

The F3S-TGR-CL receiver and transmitter offer scan code selection to minimize cross talk.

Note Both receiver and transmitter must be set to the same code.

Example:



Sequence to activate Scan Codes:

1	2	3	4	5
	 TX/RX	Connect white wire of TX to pink wire of RX SLC		 all LEDs 1 time = CODE A  all LEDs 2 times = CODE B

Wiring diagram when Scan codes are used:

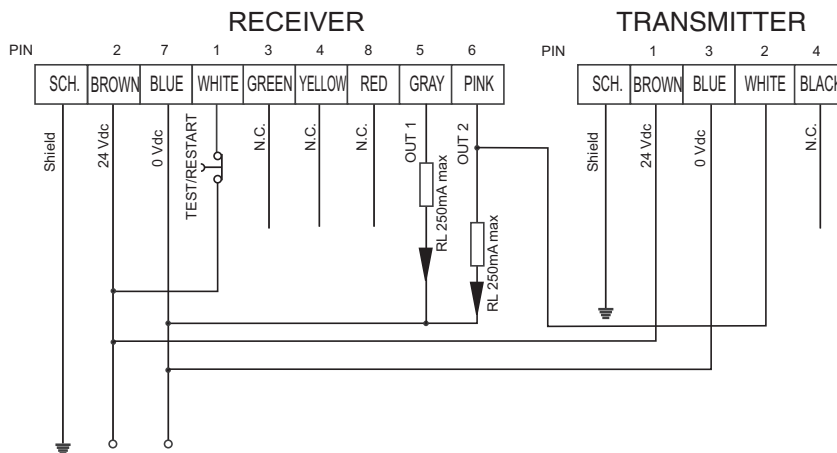

Note Please make sure that the total cable length between the two units is not longer than 100 m when coding is used .

Transmitter Scan Code setting, using switches 3 and 4:

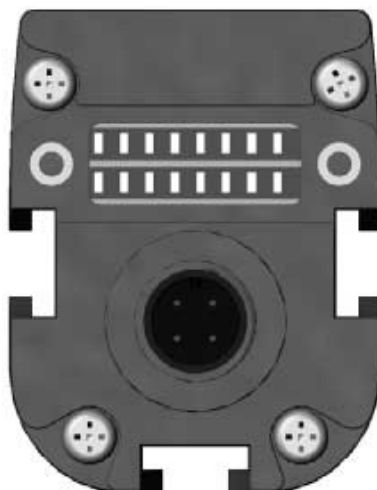

SWITCH 3	
OFF	No code (exclusion of dip 4)
ON	CODE ON

SWITCH 4	
OFF	CODE A
ON	CODE B

Note please refer to 6-1-2 Transmitter selector switch settings

Receiver Scan Code setting, using switch 7:

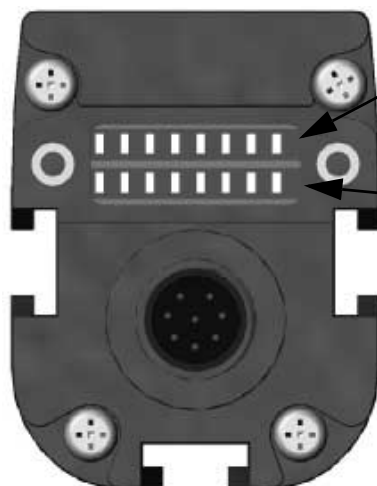

UPPER SWITCH BANK 7	
OFF	CODE A
ON	CODE B

LOWER SWITCH BANK 7	
OFF	No code (exclusion of dip 7 on upper bank)
ON	Code

SECTION 7 Outputs

7-1 Safety Outputs (OSSDs)

Note This product is designed for use on a 24 VDC, negative ground (protective earth) electrical system only. Never connect the F3S-TGR-CL system to a positive ground (protective earth) system. With a positive ground (protective earth) wiring scheme, certain simultaneous shorts of both safety outputs may not be detected and the guarded machine may not stop, resulting in severe operator injury.

The F3S-TGR-CL system receiver supplies two independent PNP type safety outputs to provide run/stop signals to the guarded machine. In the MACHINE RUN state, the safety outputs are electrically conducting and source 250mA of current at 24 VDC. In the MACHINE STOP state, the outputs are not electrically conducting.

For loads higher than 250 mA for each OSSD or AC current, please use external safety relay units or forcibly guided safety relays and enable the EDM function.

7-2 Safety Outputs (OSSDs) waveform

Normal conditions MACHINE RUN state

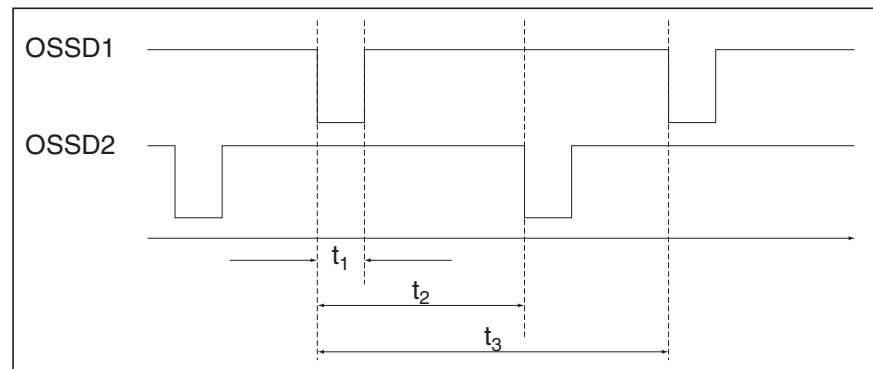

F3S-TGR-CL in MACHINE RUN state, no coding selected

t_1 : Test pulse $\leq 300 \mu\text{s}$

t_2 : Test interval $> \text{Response time} \times 0.33$

t_3 : Repetition $> \text{Response time} \times 0.66$

F3S-TGR-CL in MACHINE RUN state, coding selected

t_1 : Test pulse $\leq 300 \mu\text{s}$

t_2 : Test interval $> \text{Response time} \times 0.33$

t_3 : Repetition $> \text{Response time} \times 0.16$

F3S-TGR-CL in MACHINE STOP state, coding selected

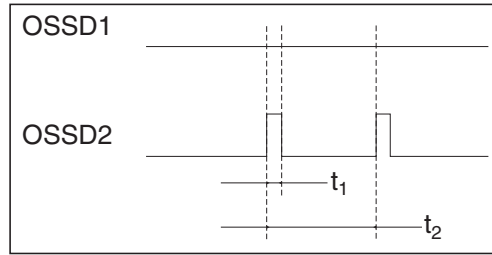

t₁ Test pulse ≤ 70 μs

t₂ Test interval ≤ 33 ms

SECTION 8 Safe Mounting Distances

⚠ WARNING Never install an F3S-TGR-CL system without regard to the safety distance. If the F3S-TGR-CL system is mounted too close to the point of operation hazard, the machine may not stop in time to prevent an operator injury.

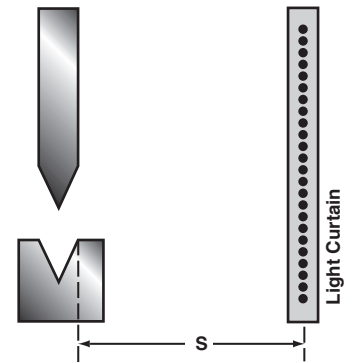

An F3S-TGR-CL system must be mounted far enough from the machine danger zone so the machine will stop before a hand or other body part reaches the hazardous area. This distance is called the safety distance. It is a calculated number based on a formula.

The safety distance "S" is the minimum safe distance between the safety light curtain and the point of operation (pinch point).

Calculation of the safety distance "S" is based on the European standard EN ISO 13855: 2010 and applies to safety light curtains that are used in industrial environments.

8-1 Safety distance for safeguarding danger points

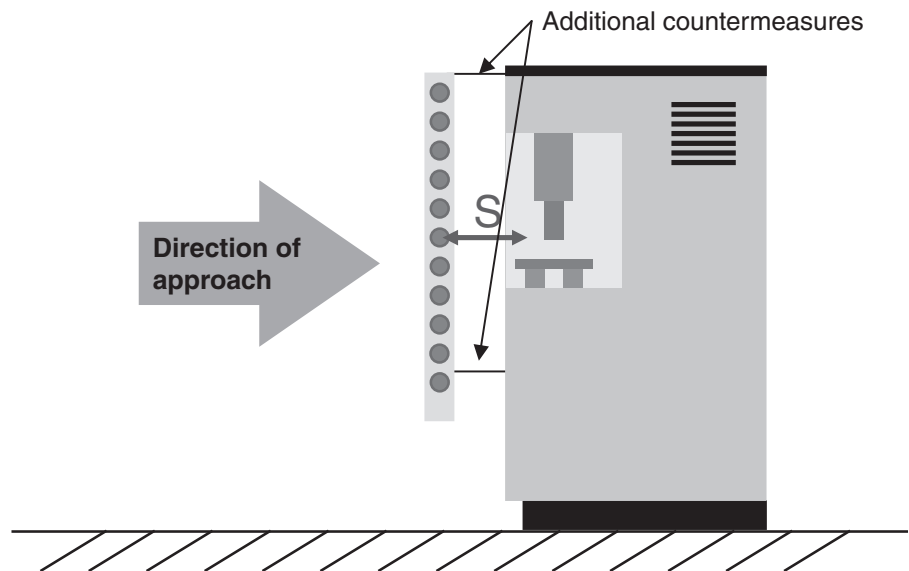

⚠ WARNING Additional countermeasures may be necessary to prevent access to the dangerous area from above, below, the sides or the rear of the machine.

8-1-1 Calculation example for systems with a resolution of ≤ 40 mm

Formula according to EN ISO 13855: 2010: $S = (K \times T) + C$

Where $S =$ minimum distance in millimeters from the danger zone to the detection point, line, plane or zone. If the result of the calculation is less than 100 mm, a distance of at least 100 mm must still be maintained.

$K =$ Approach speed in mm/s. In the close area of 500 mm, the speed is calculated at 2000 mm/s. If the distance is greater than 500 mm, K can be calculated as 1600 mm/s. In this case, however, a minimum of 500 mm applies for the safety distance.

$T =$ the overall system stopping performance in seconds

$$T = t_1 + t_2 + t_3$$

$t_1 =$ response time of the safety light curtain in seconds, given in the table in *SECTION 14*.

$t_2 =$ response time of the safety interface t_{si} , if any.

$t_3 =$ maximum stopping time of the machine t_m in seconds.

Please refer to the technical information of the safety Interface and the machine for the response time and stopping time details.

$C =$ $8 \times (d-14 \text{ mm})$, but not less than zero.

$d =$ minimum object resolution of the F3S-TGR-CL system in millimeters, therefore:

$S = (2000 \text{ mm/s} \times T) + 8 \times (d-14 \text{ mm})$

This formula applies for all minimum distances of S up to and including 500 mm. The minimum value of S shall not be less than 100 mm.

If S is found to be greater than 500 mm using the formula above, then the formula below can be used. In this case the minimum value of S shall not be less than 500 mm.

$S = (1600 \text{ mm/s} \times T) + 8 \times (d-14 \text{ mm})$

8-1-2 Calculation example for systems using single- or double break function

Resolution ≤ 30 mm:

$$S = (2000 \times T) + 8 \times (d-14),$$

where S is 150 mm minimum distance and S shall be > 150 mm

Resolution ≤ 14 mm:

$$S = (2000 \times T) + 8 \times (d-14),$$

where S is 100 mm minimum distance and S shall be > 100 mm

8-1-3 Calculation example for systems with a resolution of 40 mm to 70 mm

Where $S = K \times T + C$

$K = 1600 \text{ mm/s}$

$C = 850 \text{ mm}$

Then $S = (1600 \times T) + 850 \text{ mm}$

8-2 Safety distance for safeguarding danger areas

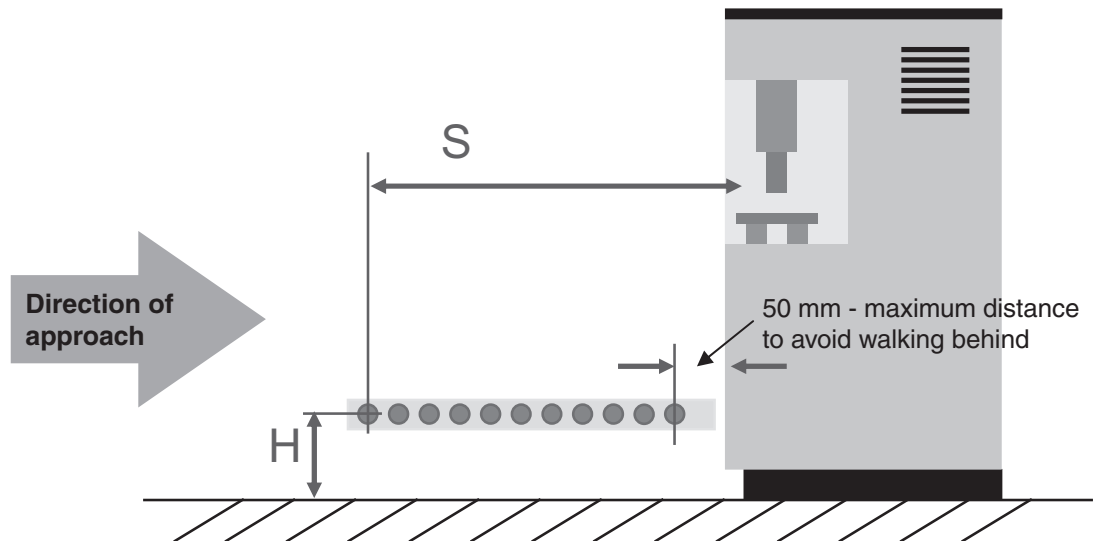

⚠ WARNING Additional countermeasures may be necessary to prevent access to the dangerous area from above, below, the sides or the rear of the machine.

The height of the protective field "H" above the reference plane and the resolution "d" of the F3S-TGR-CL system have the following relationship:

$$H_{\min} = 15 \times (d - 50) \quad \text{or} \quad d = (H_{\min} / 15) + 50$$

H = Height of the protective field above the reference plane, minimum height = 1000 mm.

It is considered that if height is equal or less than 300 mm, adults can not crawl under.

d = resolution of the F3S-TGR-CL system

$$S = (K \times T) + C$$

For K and T please refer to the previous chapter

$$C = (1200 \text{ mm/s} - 0,4 \times H) \text{ but not less than } 850 \text{ mm (arm length)}$$

H = Height of protective field above the floor

$$S = (1600 \text{ mm/s} \times T) + (1200 - 0,4 \times H)$$

Note For further information about the calculation and definition of the safety distance and direction of approach please refer to EN ISO 13855: 2010

SECTION 9 Installation

⚠ WARNING Install the sensor system so that it is not affected by reflective surfaces. Failure to do so may hinder detection, resulting in serious injury.

9-1 Reflective surface interference

A reflective surface adjacent to the detection zone can deflect the optical beam and may cause an obstruction in the zone not to be detected. The reflective surface may be part of the machine, mechanical guard or work-piece. Therefore, a minimum distance (d) must exist between the reflective object and the center line of the detection zone. The Test procedure ("*Test procedure log*" on page 83) **must** be used to test for this condition.

In this picture, the interruption is clearly detected. The reflective object is outside of the beam angle.

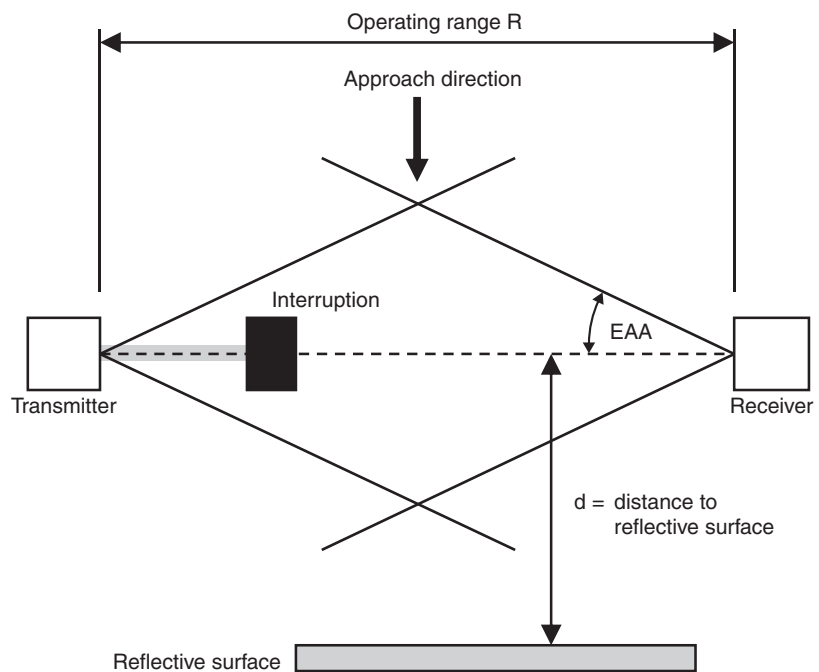

Operating range R: is the effective working distance of the F3S-TGR-CL system, from the transmitter to the receiver.

EAA: is the effective aperture angle of the Safety Sensor.
it is $\pm 2,5^\circ$ for F3S-TGR-CL4...
it is $\pm 5^\circ$ for F3S-TGR-CL2...

distance d: is the minimum distance to a reflective surface.
This distance must be bigger than:
 $d_{\min \text{ F3S-TGR-CL4}} = \tan(2,5^\circ) \times R$
 $d_{\min \text{ F3S-TGR-CL2}} = \tan(5^\circ) \times R$

Be aware that reflective surface interference may also appear above and below the sensing field.

The following graphs show the minimum distance d for an operating range R of up to 20 m:

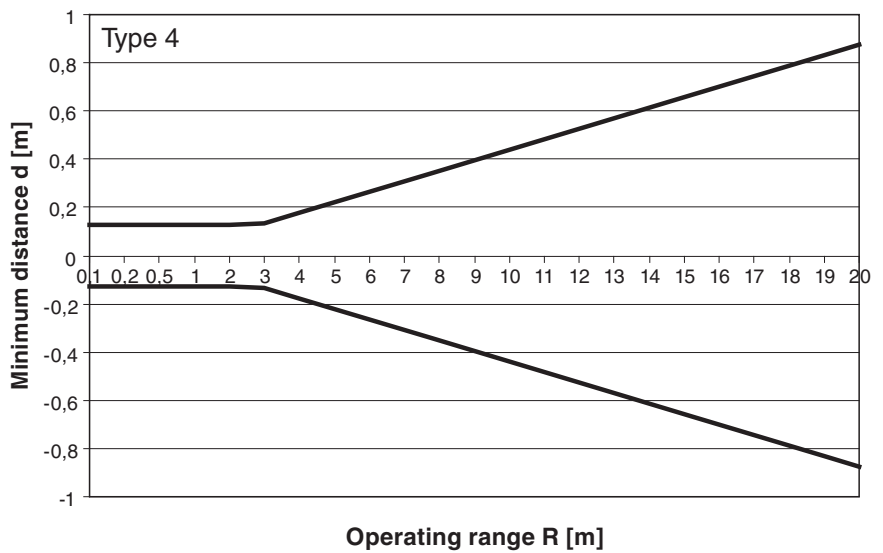
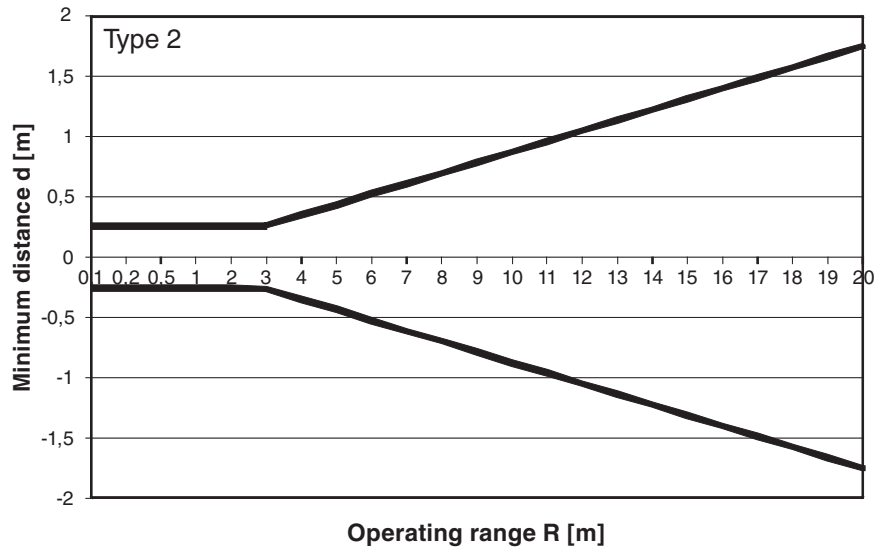

9-2 Cross Talk Mitigation

To mitigate interference from other light curtains, the F3S-TGR-CL system has two possible scan codes, A and B. The transmitter and receiver units must be set to the same scan code for the receiver to enter the MACHINE RUN state.

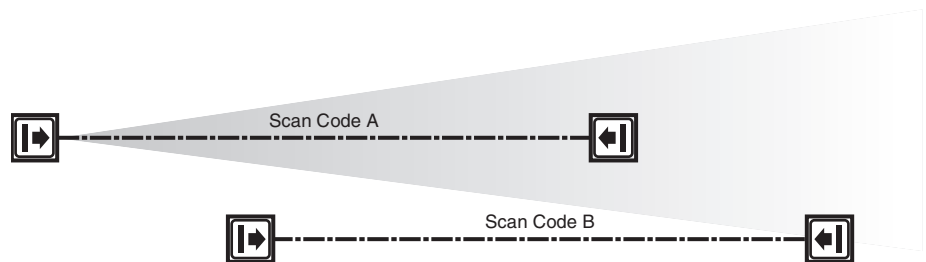

9-3 General mounting considerations

9-3-1 Additional Guarding

Areas of access to the point of hazardous operation not guarded by the F3S-TGR-CL system must be protected by suitable means such as a fixed barrier guard, an interlocked guard or a safety mat system.

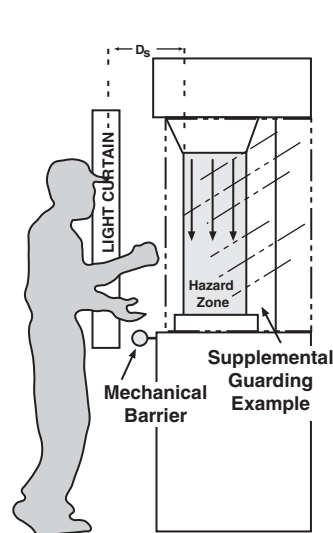

F3S-TGR-CL point of operation guarding

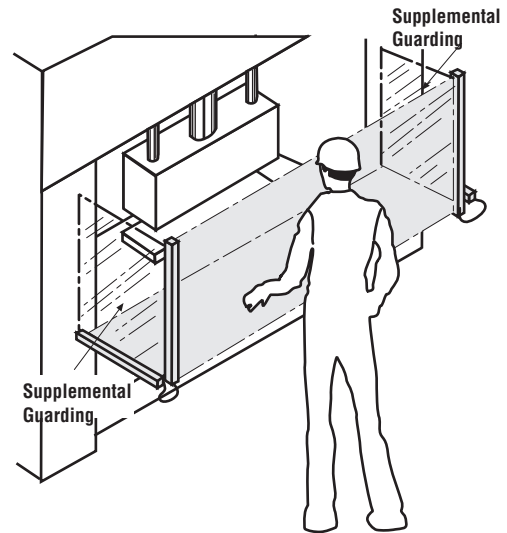

F3S-TGR-CL 2-Axis guarding

9-3-2 Mechanical installation

The F3S-TGR-CL system is mechanically installed by using the T-slots on the two sides or the back-side of the housing.

Use the movable bolts, washers, growers and nuts to fix the mounting brackets as shown in the picture

ID	Description
1	movable M6 bolt
2	fixing braket
3	M6 washer
4	M6 Grower
5	M6 nut

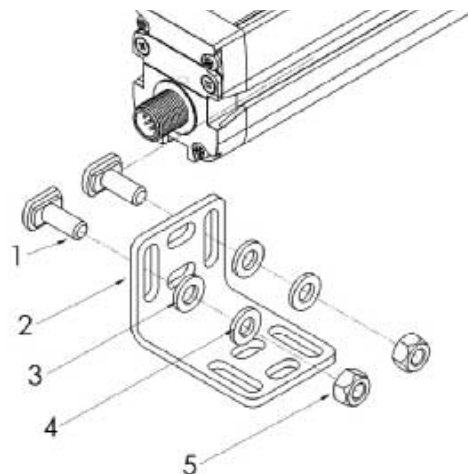

Note The number of fixing brackets shipped with the products supports the recommendation to use a fixing bracket every 400 mm.

9-3-3 Additional mounting rigidity

It is recommended that the distance between the mounting brackets is 400 mm or less for optimum performance of the F3S-TGR-CL system.

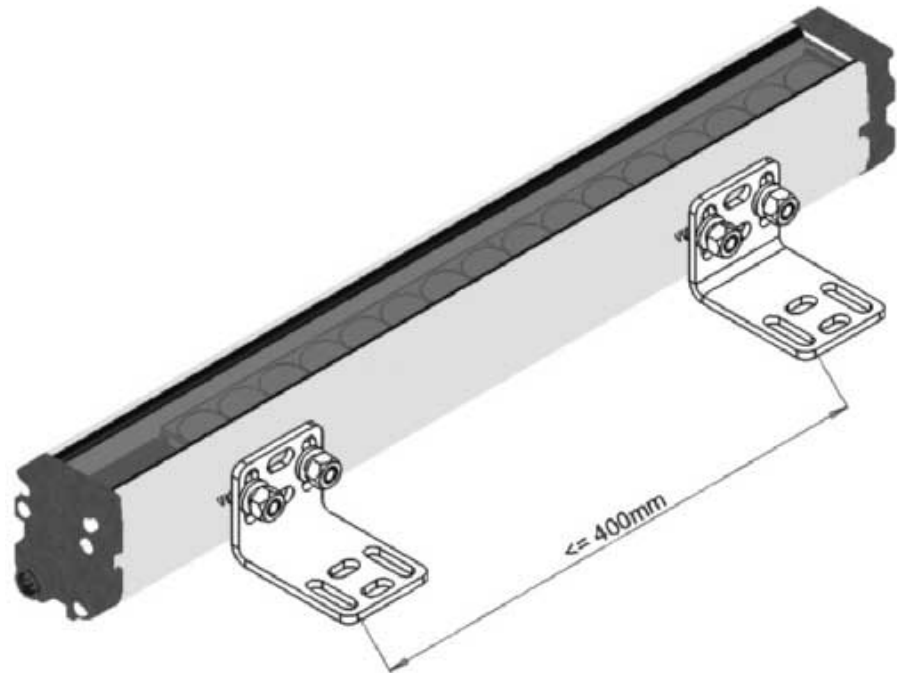

9-3-4 Mechanical mounting

Physical alignment of the transmitter and receiver is easiest when the system is in the automatic start operating mode with Blanking inactive. The units should be in the same plane and at equal height.

Transmitter and receiver unit are mounted parallel to each other and orthogonal in respect to the detection zone between transmitter and receiver. It is required that the connectors are oriented in the same direction.

Below pictures show GOOD and NOT GOOD installations:

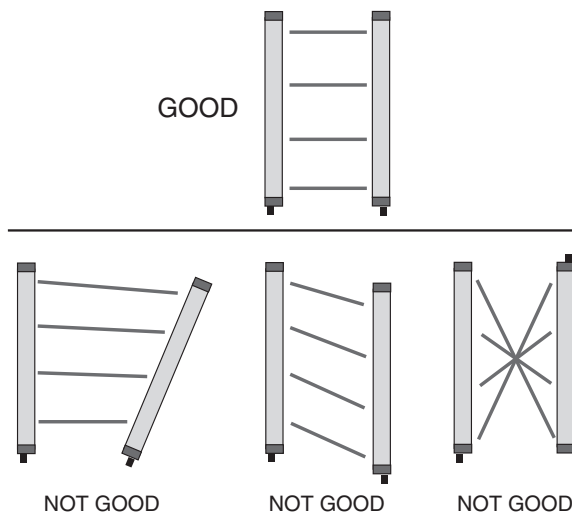

9-3-5 Installation of multiple systems

When two or more F3S-TGR-CL systems with the same scan code are mounted in close proximity and in alignment with each other, precautions should be taken to avoid one system interfering with another. This can be corrected by mounting the transmitters and receivers back-to-back or stacked.

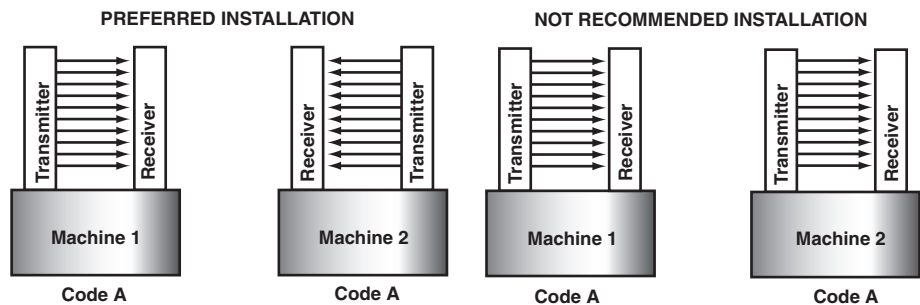

The scan code feature of the F3S-TGR-CL system allows for placement of systems in close proximity and in line with each other. The distinctive coding of the beams provide for unique operation of a system while in view of another system with a different scan code. Two unique codes are available on the F3S-TGR-CL.

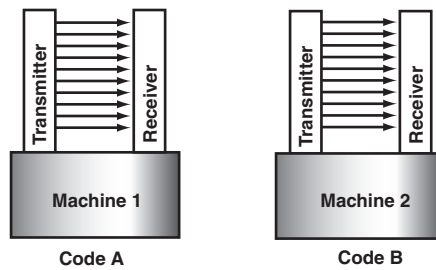

9-3-6 Detection Zone (indication on the Front Label)

The system detection zone is the area between the marking on the label on the front window and the inside edge of the endcap. The area outside these marks is not protected. Position the system so that it is only possible to access the danger point through the detection zone.

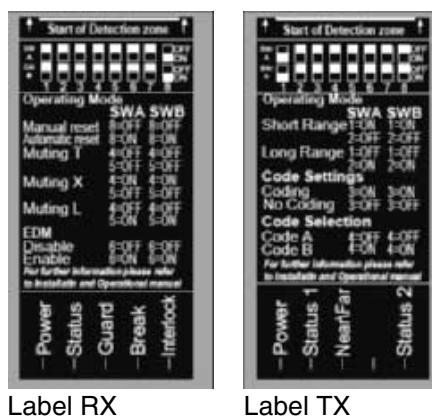



9-3-7 Requirements for Perimeter Guarding



In perimeter guarding applications the F3S-TGR-CL system detection zone is placed around the outside perimeter of a guarded machine. This placement leaves space for personnel to stand between the detection zone and the hazardous machine.

In this case, the guarded machine must only be restarted using a switch located outside and with a full view of the area of hazardous motion. Operation of the F3S-TGR-CL system in the Start/Restart Interlock operating mode is suitable for perimeter guarding.

9-3-8 Marking Minimum Object Resolution

Serial number labels on the transmitter and receiver indicate possible minimum object resolutions. During installation, use a permanent marker to obscure the object resolution not set and add information about the effective resolution. This will depend on how the beam tolerance in Blanking mode is set.

TYPE F3S-TGR-CL4-035-600				SUPPLY 24Vdc ±20%	POWER CONSUMPTION 10W	PROTECTION IP65	  
SAFETY TYPE 4	PROTECTED HEIGHT 623	RESPONSE TIME 21ms	RANGE SD 0.2 - 7 / LD 7 - 14m	RESOLUTION 35mm	SW. REL. 1.2.2		
OPERATING TEMP -10 - +55°C					EXAMPLE LABEL		

TYPE F3S-TGR-CL4-035-600				SUPPLY 24Vdc ±20%	POWER CONSUMPTION 10W	PROTECTION IP65	  
SAFETY TYPE 4	PROTECTED HEIGHT 623	RESPONSE TIME 21ms	RANGE SD 0.2 - 7 / LD 7 - 14m	RESOLUTION 70 mm	SW. REL. 1.2.2		
OPERATING TEMP -10 - +55°C					EXAMPLE LABEL		

SECTION 10

Connection to the Machine control circuit

 **WARNING** This product is designed for use on a 24 VDC, negative ground (protective earth) electrical system only. Never connect the F3S-TGR-CL system to a positive ground (protective earth) system. With a positive ground (protective earth) wiring scheme, certain simultaneous shorts of both safety outputs may not be detected and the guarded machine may not stop, resulting in severe operator injury.

 **WARNING** Never use only a single safety output to control the machine. Should this single output fail, the machine may not stop, resulting in severe operator injury. The machine must be connected using both safety outputs.

10-1 Input Power Requirements

The system operates directly from 24 VDC $\pm 20\%$. Power to the system must come from a power supply which meets the requirements of EN/IEC60204-1 and EN/IEC 61496-1.

The power supply must guarantee safe insulation from the mains voltage in accordance with IEC60742 (Protective class III, double insulation) and be able to cover a drop of supply voltage of at least 20 ms. OMRON offers suitable power supplies. Transmitters and receivers must be supplied from a shared power supply and must be fused against over current. An external fuse of 1A must be used.

10-2 Cables

The primary cables for the F3S-TGR-CL system are industry standard shielded cables with an M12 female connector. The receiver and transmitter incorporate a M12 male connector.

We recommend to use the cables shown in the list of accessories to connect the F3S-TGR-CL system to the machine control system.

Note For further information please refer to chapter *14-14-5 Cables*

10-3 Basic wiring scheme

Transmitter

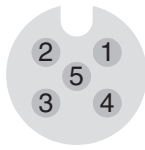

Pin No.	Signal Name	Wire Colour
1	Input Power +24V	Brown
2	Test Input	White
3	Input Power GND	Blue
4	Not used	Black
5	Not used	Green

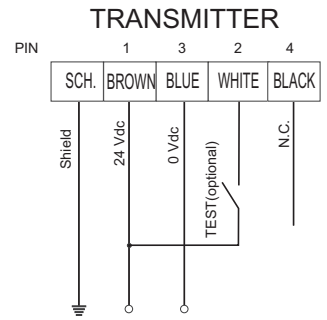

Receiver



Pin No.	Signal Name	Wire Colour
1	Test/Restart	White
2	Input Power +24V	Brown
3	Muting A	Green
4	Muting B	Yellow
5	Output signal OSSD1	Gray
6	Output signal OSSD 2	Pink
7	Input Power GND	Blue
8	Muting lamp connection LMS	Red

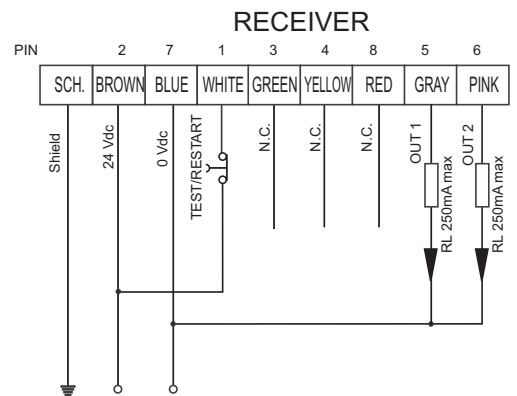

Refer to the sections *Blanking* (page 7), *Muting and override* (page 34), *Pre-reset function* (page 43) and *Single-/Double Break function* (page 44) for further information.

10-4 Wiring to two forcibly guided relays

F3S-TGR-CL is set in manual reset operation mode and with EDM function activated.

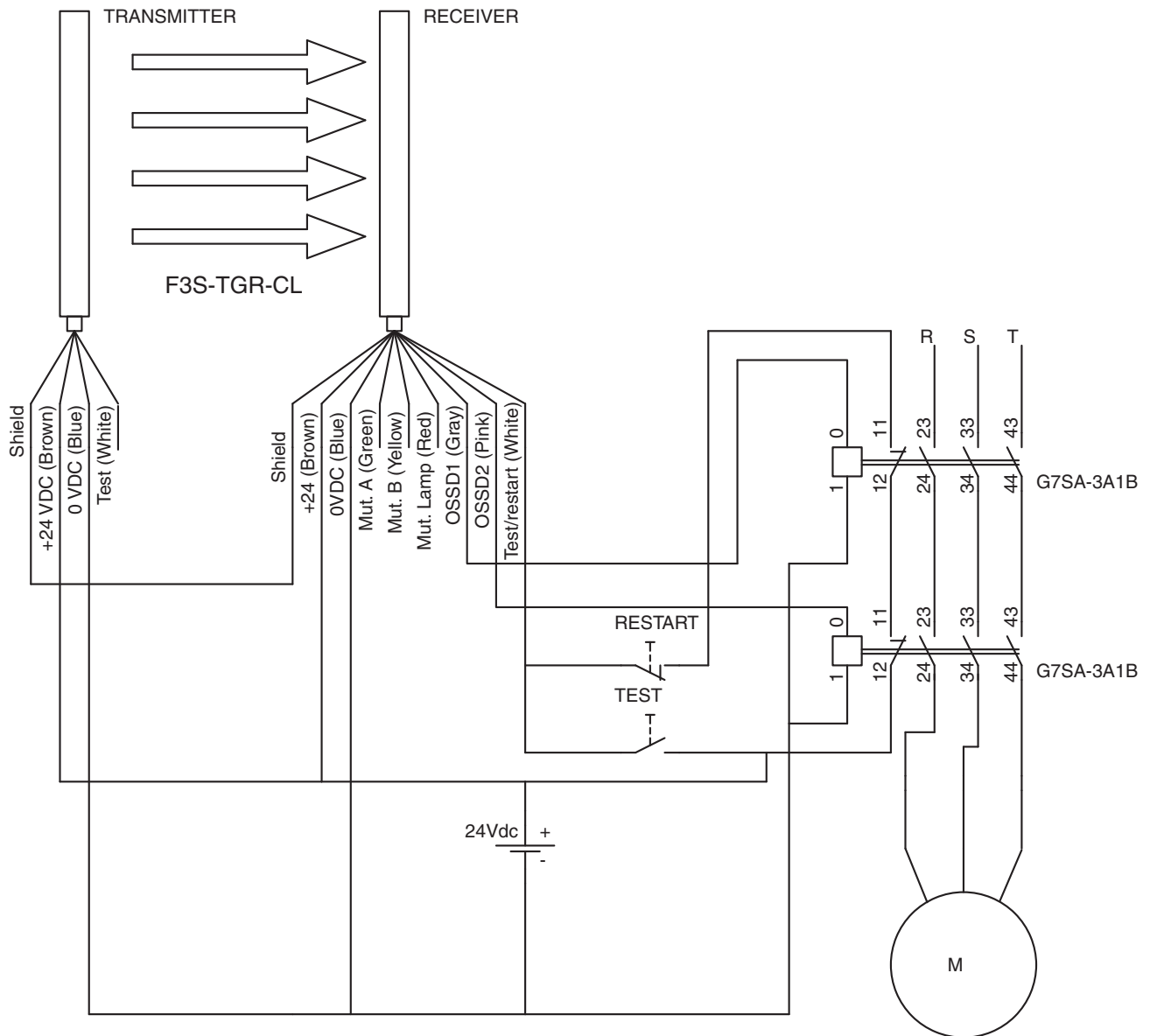

Note The achievable safety category or performance level using this circuit depends on the safety light curtain in use and the correct wiring of the safety control unit.

Note This circuit can achieve a PL=e acc. ISO 13849-1 if a F3S-TGR-CL-4_ is used.

10-5 Connection to a safety relay unit

F3S-TGR-CL is set in automatic reset mode. G9SB is in manual reset mode.

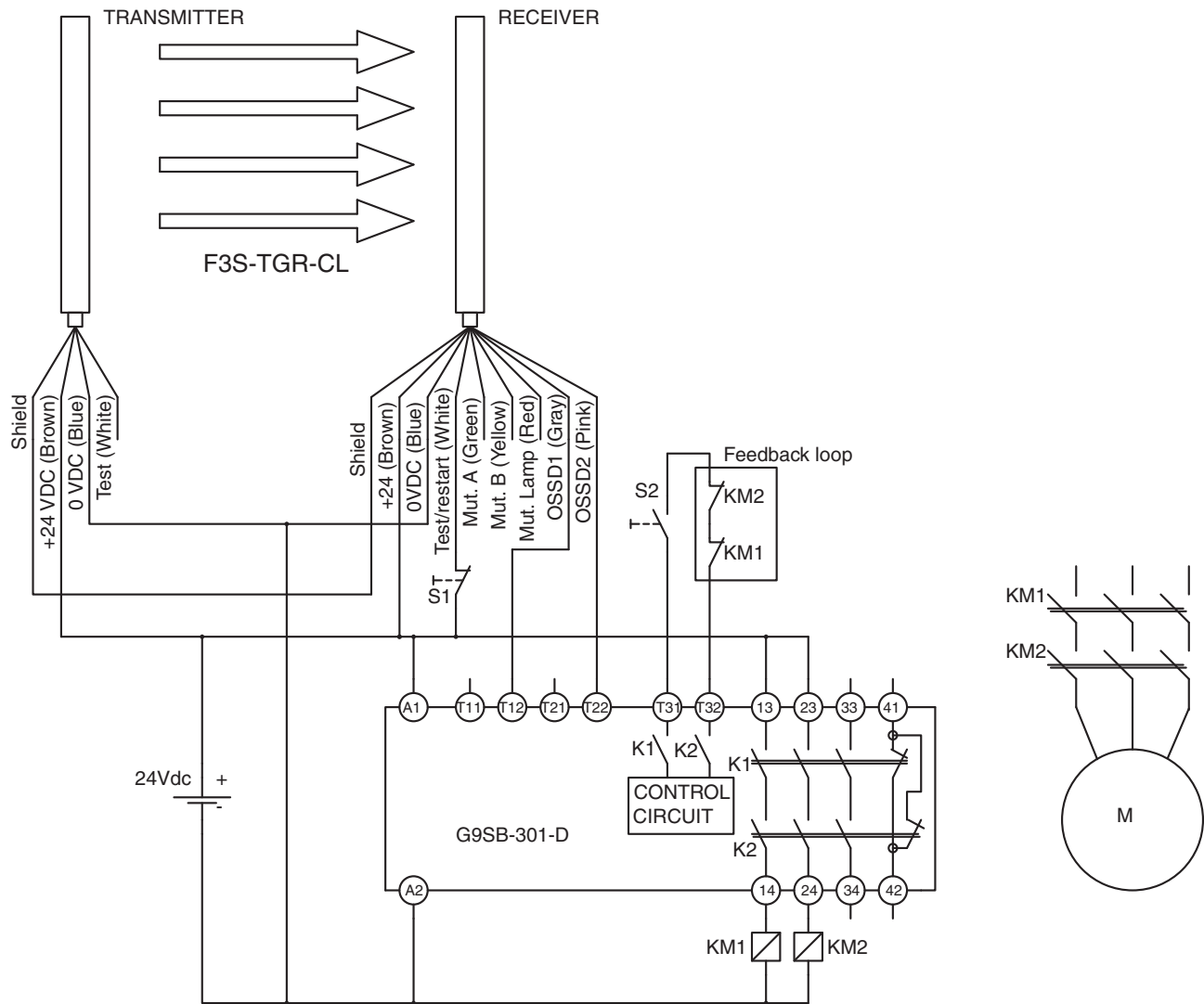

Note The achievable safety category or performance level using this circuit depends on the safety light curtain in use and the correct wiring of the safety control unit.







Note This circuit can achieve a PL=e acc. ISO 13849-1 if a F3S-TGR-CL-4_ is used.

SECTION 11

Control functions

11-1 Muting and override

This function is only available on the F3S-TGR-CL_A - models.

-  **WARNING** The muting and override functions disable the safety functions of the device. You must ensure safety using other method when these functions are operating.
-  **WARNING** Install muting sensors so that they can distinguish between the object that is being allowed to pass through the detection zone and a person. If the muting function is activated by the detection of a person, it may result in serious injury.
-  **WARNING** Muting lamps (external indicators) that indicate the state of the muting and override functions must be installed where they are clearly visible to workers from all the operating positions.
-  **WARNING** Muting related time must be properly configured for its application by a sufficiently trained and qualified person, and the person must have responsibility for settings. (Infinite muting time setting feature of firmware version 1.3.6)
-  **WARNING** Use independent 2 input devices for muting inputs.
-  **WARNING** You must install F3S-TGR-CL system muting sensor, and physical barrier, and configure time settings for muting so that an operator should not enter hazardous zone.
-  **WARNING** Install the switch that activates the override in a location that provides a clear view of the entire hazardous area and where it cannot be activated from within the hazardous area. Make sure that nobody is in the hazardous area before activating the override function.

During muting condition, the monitoring of the protective field is suppressed intentionally for a preset time. It is used in applications, where material goes into or out of a dangerous zone without stopping the machine, so the Safety Outputs (OSSDs) of the Safety Sensor System remain in the ON-State during the muting procedure.

The Muting function can be activated only if the F3S-TGR-CL system is in the MACHINE RUN state while the muting activation sequence is provided.

11-1-1 Wiring

FW 1.2.5

To control and activate the muting function, the inputs

- Muting A
- Muting B
- external Muting lamp connection (LMS)

are used.

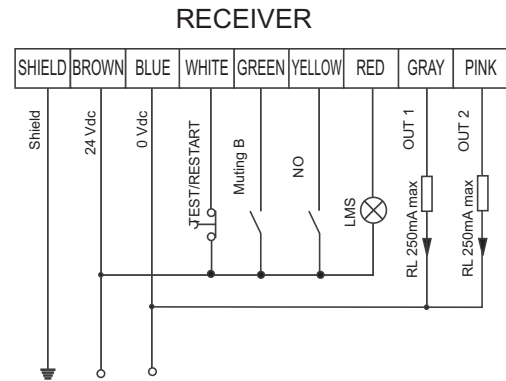

11-1-2 Activation and de-activation of the muting function

The muting function is enabled by default for all F3S-TGR-CL-A - models.

11-1-3 External muting lamp requirements

The external muting lamp for muting and muting override must be installed in a position where it can be clearly seen by the operators. A LED indicator- or standard bulb-based lamp can be used to indicate muting.

Any failure of the muting lamp or in wiring is recognized by the F3S-TGR-CL system and will result in an ERROR condition.

11-1-4 Muting input requirements

Muting A and Muting B can be provided by mechanical switches, proximity sensors or photoelectric switches with a closed contact if an object is detected.

At least one of the signals must be a hardware signal. It is not allowed to just control the muting function by software.

Please make sure that the installation of the muting sensors follows the requirements shown in the next chapters.

11-1-5 Muting modes

The F3S-TGR-CL system offers a set of three muting modes:

- T-muting activation (default)
- L-muting activation
- X-muting activation

RT in the pictures below refers to the response time of the safety sensor (ON to OFF according to the technical specification in SECTION 14 on page 51).

TM is the time difference between activating Muting sensor A and Muting sensor B.

Modification table for different muting types:

Muting type	Available values for each timing		
	A-B time	Timeout	deactivation
T	0.03 s < t < 120 s	<600 s Or Infinite	<0.2 s Or <1 s
L	0.03 s < t < 120 s	<600 s Or infinite	<0.2 s Or <1 s
X	0 s < t < 4 s With MUT B logically inverted.	<1700 s Or infinite	<0.2 s Or <1 s

11-1-5-1 T-activation mode

The T-muting activation mode is the default and standard application for muting. Four muting sensors are used in two pairs (OR function), connected to the two Muting inputs, Muting A and Muting B.

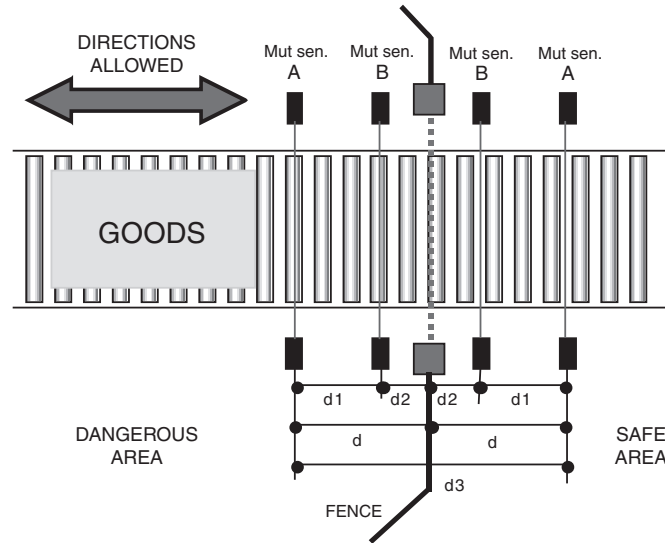

This muting activation mode allows bi-directional transport of material.

- Note**
- d1 is the distance between the muting sensors. It must be more than 250 mm and needs to be checked additionally in regards to the speed of the material transport and time limitation in the muting function.
 - d2 is the distance between the Muting sensor B and the F3S-TGR-CL system. It must be as short as possible. Timing limitations and the speed of the material transport must be considered additionally.
 - d3 is the distance between the two sensors connected to Muting A input. This distance represents the minimum length of the material to be detected.

Timing requirements and limitations:

- If Muting A is activated, Muting B must be activated within 120sec. to activate the muting function. Otherwise muting function is stopped.
- Muting A and Muting B cannot be activated at the same time. A minimum time difference equal to the response time of the sensor is mandatory.
- Maximum muting time is 600sec. After this time, muting function is stopped even if the Muting inputs are still active.

- The F3S-TGR-CL allows that Muting A or Muting B drop for a maximum time of 200ms without stopping the muting function. A time longer than 200ms is detected as a muting stop.

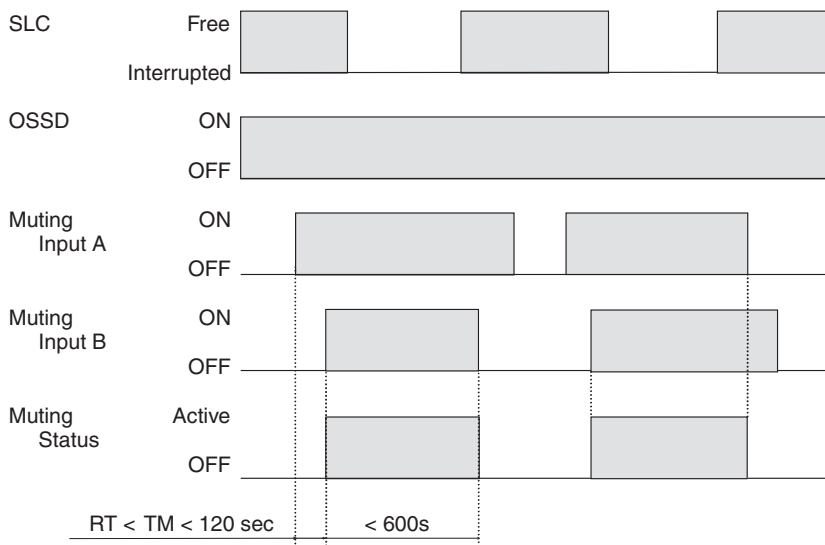

11-1-5-2 L-activation mode

The L-muting activation mode can be used in applications where material is transported only out of the dangerous area,

Two muting sensors are connected to the two Muting inputs, Muting A and Muting B.

WARNING This muting activation mode can only be used in uni-directional transport. Failure to do so may result in serious injury.

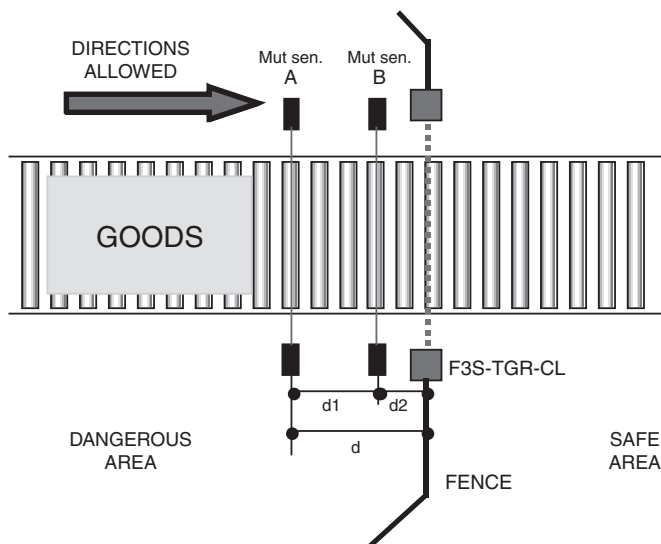

- Note**
- d1 is the distance between the muting sensors. It must be more than 250mm and needs to be checked additionally in regards to the speed of the material transport and time limitation in the muting function.
 - d2 is the distance between the Muting sensor B and the F3S-TGR-CL system. It must be as short as possible. Timing limitations and the speed of the material transport must be considered additionally.

- d is the distance between the F3S-TGR-CL system and the sensor connected to Muting A input. This distance represents the minimum length of the material to be detected.

Timing requirements and limitations:

- If Muting A is activated, Muting B must be activated within 120 sec. to activate the muting function. Otherwise muting function is stopped.
- Muting A and Muting B cannot be activated at the same time. A minimum time difference equal to the response time of the sensor is mandatory.
- If Muting A and Muting B are activated, the protective field must be obscured within 120 sec. Otherwise the muting function is stopped.
- Maximum muting time is 600 sec. After this time, muting function is stopped even if the Muting inputs are still active or the protective field is still obscured.
- The F3S-TGR-CL allows that Muting A or Muting B drop for a maximum time of 200 ms without stopping the muting function. A time longer than 200 ms is detected as a muting stop.
- The F3S-TGR-CL allows that the protective field becomes free for a maximum time of 200 ms in Muting condition. If the protective field is free for more than 200 ms, the muting function stops.

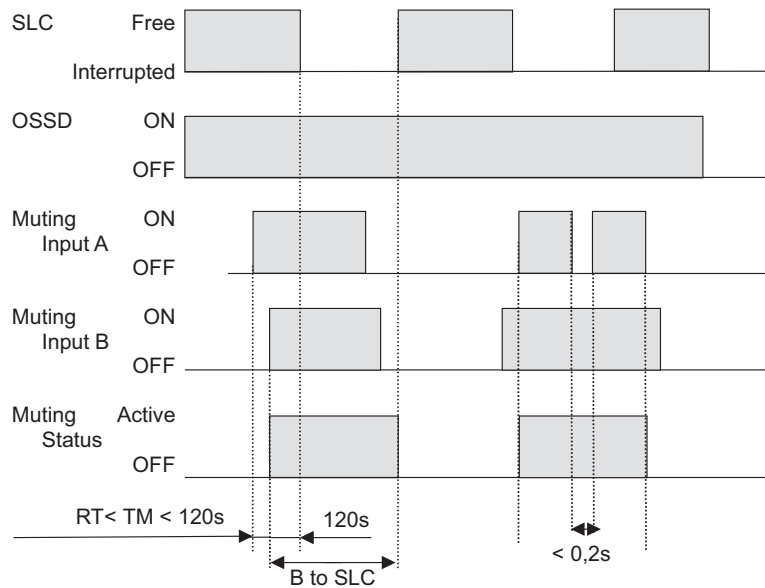

Note Activation of muting function starts after the muting B rise edge and not after the SLC interruption.

11-1-5-3 X-activation mode

The X-muting activation mode can be used in applications where material is transported in both direction. This muting mode is used in applications, where eg. pallets are used to carry stacked boxes or crates. Most stable detection of this kind of material is possible using the X-muting activation mode.

Two muting sensors are connected to the two Muting inputs, Muting A and Muting B.

FW 1.3.6

To control and activate the muting function, the inputs

- Muting A
- Muting B
- external Muting lamp connection (LMS)

are used.

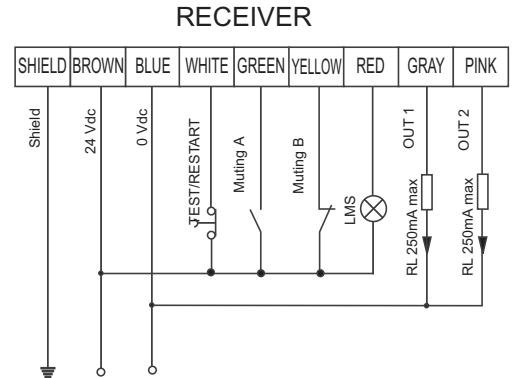

WARNING The crossing point of the two muting sensors **MUST** be inside the dangerous zone. Failure to do so may result in serious injury.

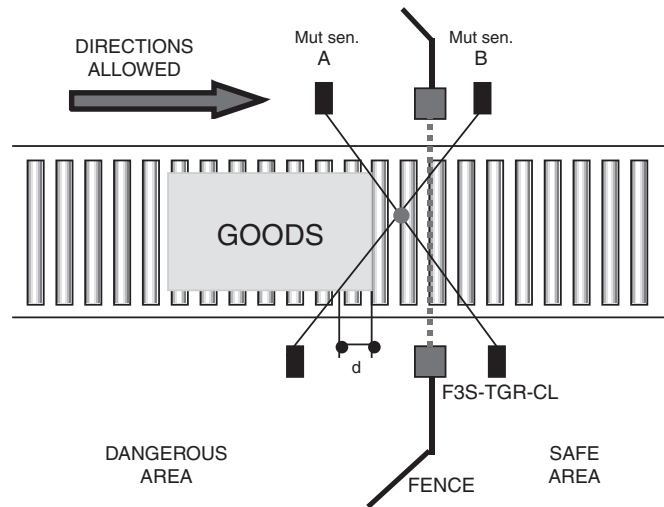

Note • d is the resulting distance between the activation points of Muting A and Muting B. It needs to be checked in regards to the speed of the material transport.

Timing requirements and limitations:

- Either Muting A or Muting B can be used to initiate the muting function.
- There is no maximum time limit after Muting A is activated.
- There is no maximum time limit after Muting B is activated.
- Muting A and Muting B cannot be activated at the same time. A minimum time difference equal to the response time of the sensor is mandatory.
- Maximum muting time is 1700 sec. After this time, muting function is stopped even if the Muting inputs are still active.

- The F3S-TGR-CL allows that Muting A or Muting B drop for a maximum time of 200 ms without stopping the muting function. A time longer than 200 ms is detected as a muting stop.

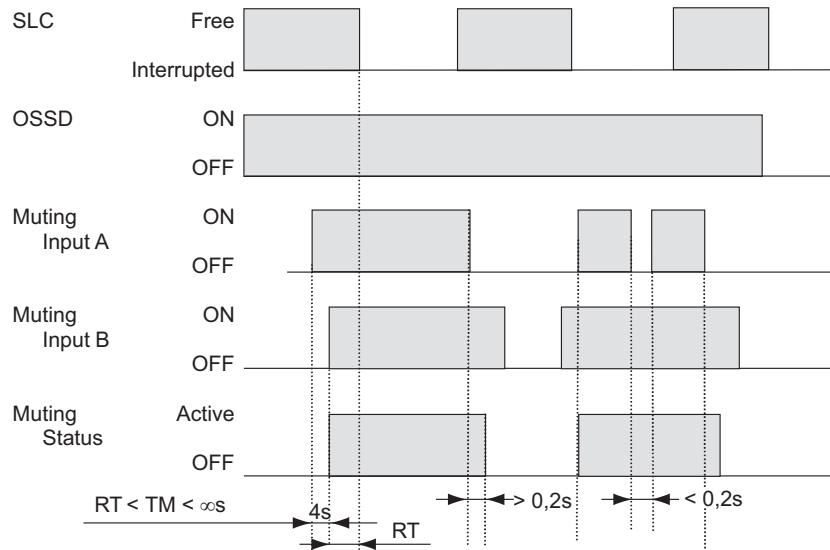

11-2 Partial Muting Configuration

This function is only available on the F3S-TGR-CL_A - models.

Some applications require a muting function that is not covering the entire protective field.

The protective field of the F3S-TGR-CL system is build of optical modules. Each module in a F3S-TGR-CL system can be addressed individually and carries a number of individual beams.

The partial muting function allows to select the modules on which muting is performed.

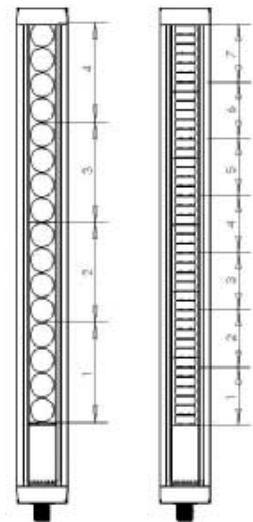

Note The module opposite side of the connector can not be used for partial muting.

11-2-1 Setting the partial muting function

Use the selector switches to set the partial muting function:

MUTING MAPS when MUTING T, L or X are selected on switches 4 and 5*1				
3 + 2 + 1	1	2	3	
	OFF	OFF	OFF	Muting active over all light curtain
	OFF	OFF	ON	Muting active on module 1,2,3 and 4
	OFF	ON	OFF	Muting active on module 1,2 and 3
	OFF	ON	ON	Muting active on module 1 and 2
	ON	OFF	OFF	Muting active on module 1
	ON	OFF	ON	Muting active on module 2
	ON	ON	OFF	Muting active on module 3
	ON	ON	ON	Muting active on module 4

*1. Selector switches 1, 2 and 3 are operational if a muting function is set and a muting indicator is connected.

- Note** • If the F3S-TGR-CL system uses more than 4 modules, the partial muting function is limited to modules 1 to 4.
- The number of modules is shown in the list of models in the technical data.

11-3 Override

This function is only available on the F3S-TGR-CL_A - models.

This function is a manual triggering of the muting function after an error in the muting procedure. An error-free state can be established by simulating a valid muting condition. This allows to clear the protective field by using the override function.

Typical applications can be found eg. in palletizing machines. If a pallet stopped in the protective field, the Safety sensor system can not be restarted without removing the pallet.

⚠ WARNING Make sure that the operator is able to check the entire protective field as long as override function is enabled. Failure to do so may result in serious injury.

- Note** • To start override, the F3S-TGR-CL must be in MACHINE STOP state.
- If the entire protective field is free for more than 2sec. the override function is immediately stopped.
- A Test request on the TEST/RESTART input will stop the override function immediately.
- Maximum timeout for override is 600sec. After this timeout, the F3S-TGR-CL system is restarting according to the interlock mode set by the selector switches.

11-3-1 Override function at start-up

Conditions:

- At least one beam of the F3S-TGR-CL system must be blocked
- F3S-TGR-CL system is in MACHINE STOP mode.

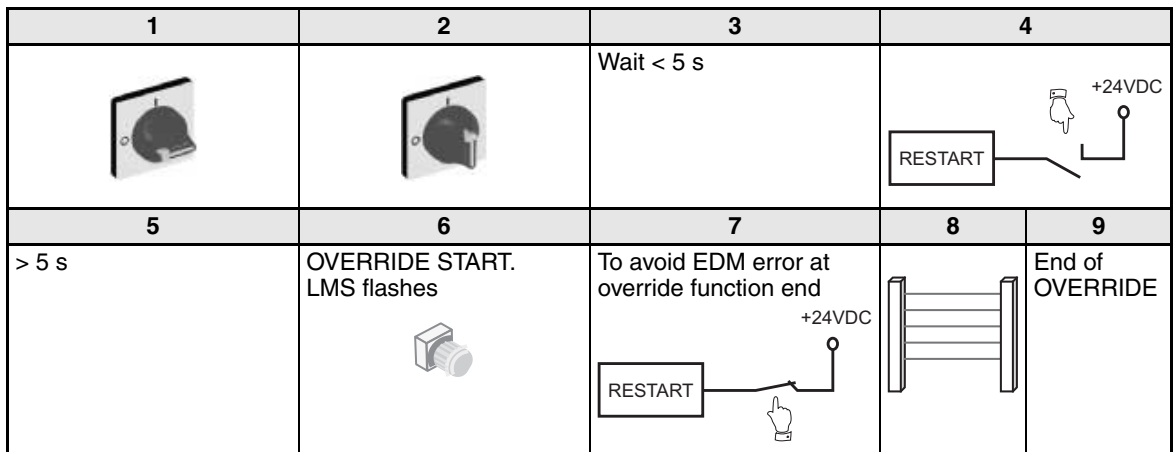

Override function is stopped immediately if the TEST/RESTART input is activated during the Override function.

11-3-2 Override during operation cycle

Conditions

- At least one beam of the F3S-TGR-CL system must be blocked
- F3S-TGR-CL system is in MACHINE STOP mode.
- One or both muting inputs are active.

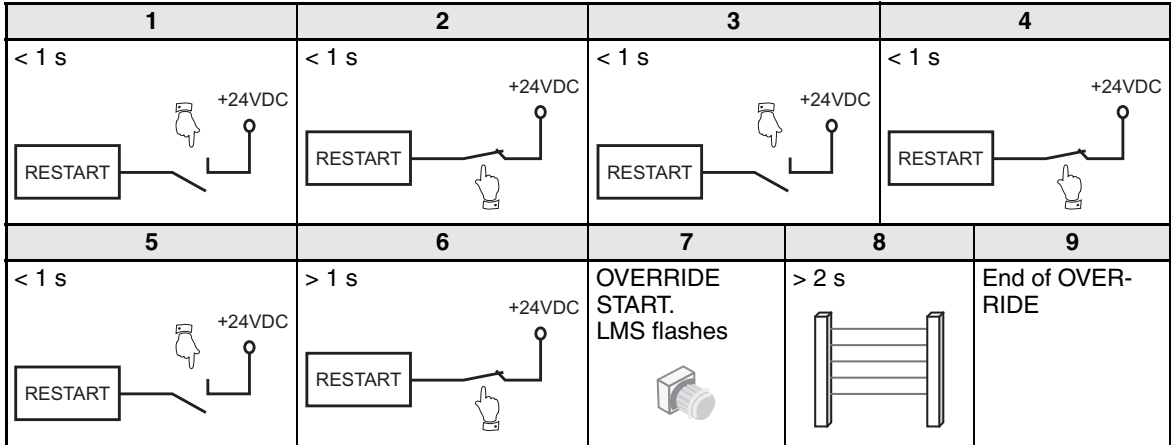

Override function is stopped immediately if the TEST/RESTART input is activated during the Override function

11-4 Pre-reset function

This function is only available on the F3S-TGR-CL_A - models.

The Pre-reset function is an addition to the manual restart function. It can be used, where the operator doing the restart is not able to see the entire dangerous zone.

⚠ WARNING The pre-reset pushbutton must be installed in the dangerous zone from where the operator is able to check that nobody else is in the dangerous zone before the manual restart function is used. Failure to do so may result in serious injury.

The time limit between pre-reset and manual reset is 8 sec.

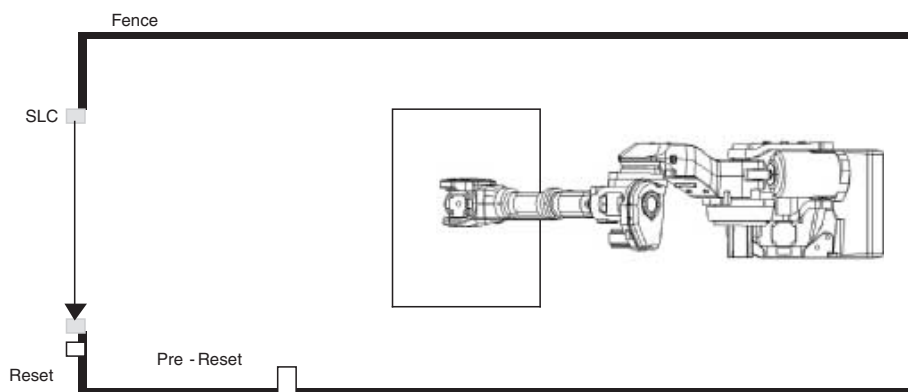

- Note**
- Pre-reset function sets the F3S-TGR-CL system to manual reset mode.
 - Blanking function can not be selected using pre-reset function.
 - Muting function can not be selected using pre-reset function.



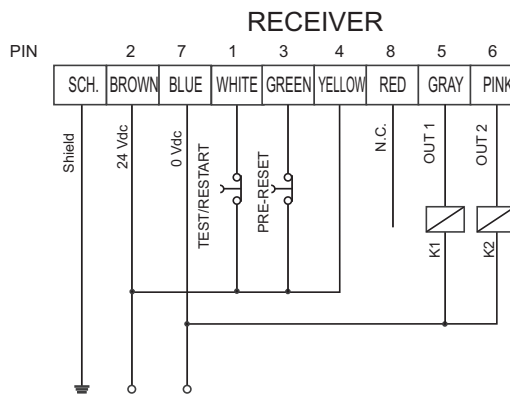

Wiring diagram:

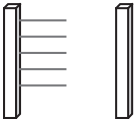
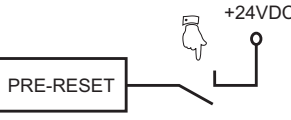

Note If both inputs Muting A (Pre-reset Input) and Muting B (yellow input) loose +24 V, the F3S-TGR-CL system changes to error condition

Conditions:

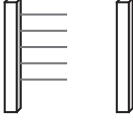
- Pre-reset function activated by using the selector switches
- A pre-reset pushbutton is connected to the Muting A input.
- The Muting B input is connected to +24 V.

1	2	3	4
 Pass through detection zone	OSSD to OFF		 STATUS (one time per second)
5	6	7	8
< 8 s to execute step 6 and 7	 Pass through detection zone		OSSD to ON

11-5 Single-/Double Break function

WARNING Make sure that single/double break function is used only if the machine is designed and equipped with additional protective equipment to prevent the risk of unintended or unexpected start.

Caution The single/double break function use a 30 s timeout function. If the cyclic operation is not done within 30 s, a restart of the single/double break cycle is necessary by activating the restart input.

WARNING Interrupting the sensing field is the only possible way to entrance in the hazardous area.

This function is only available on the F3S-TGR-CL_A - models.

This control function can be used on small press machines where the operator is doing a loading and/or unloading cycle manually.

Wiring diagram:

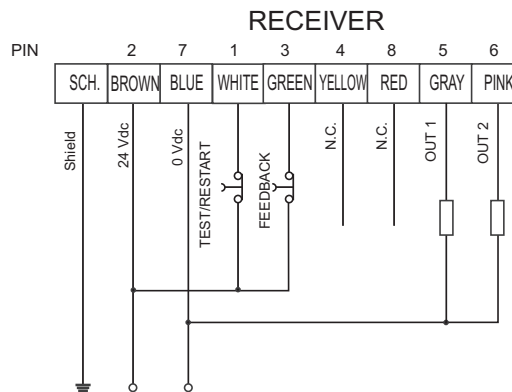

Note • The feedback input must be a NC contact, activated when the machine head is in the safe position and the operator can enter the dangerous zone.

- As long as the safety outputs are ON, an additional interruption of the protective field will result in an interlock situation.

11-5-1 Single break function

The F3S-TGR-CL will power-up with its safety outputs off and enter the INTERLOCK state if the detection zone is clear. F3S-TGR-CL system will enter the MACHINE RUN state when the detection zone was entered and cleared again. It will change to INTERLOCK state automatically when one cycle of the machine is finished. The cycle can be restarted by entering and clearing the detection zone again.

Each operating cycle monitored by the single break function works as follows:

- Protected field is interrupted and free again (load or unload manually)
- Safety outputs enter MACHINE RUN STATE and machine operates
- When machine operate feedback is not tested.
- When end of position is reached the feedback input provide a high to low transition
- Safety outputs enter MACHINE STOP state

Note A manual restart is necessary to start the single break function sequence again after power on or any other interruption of the protective field while the machine is working.

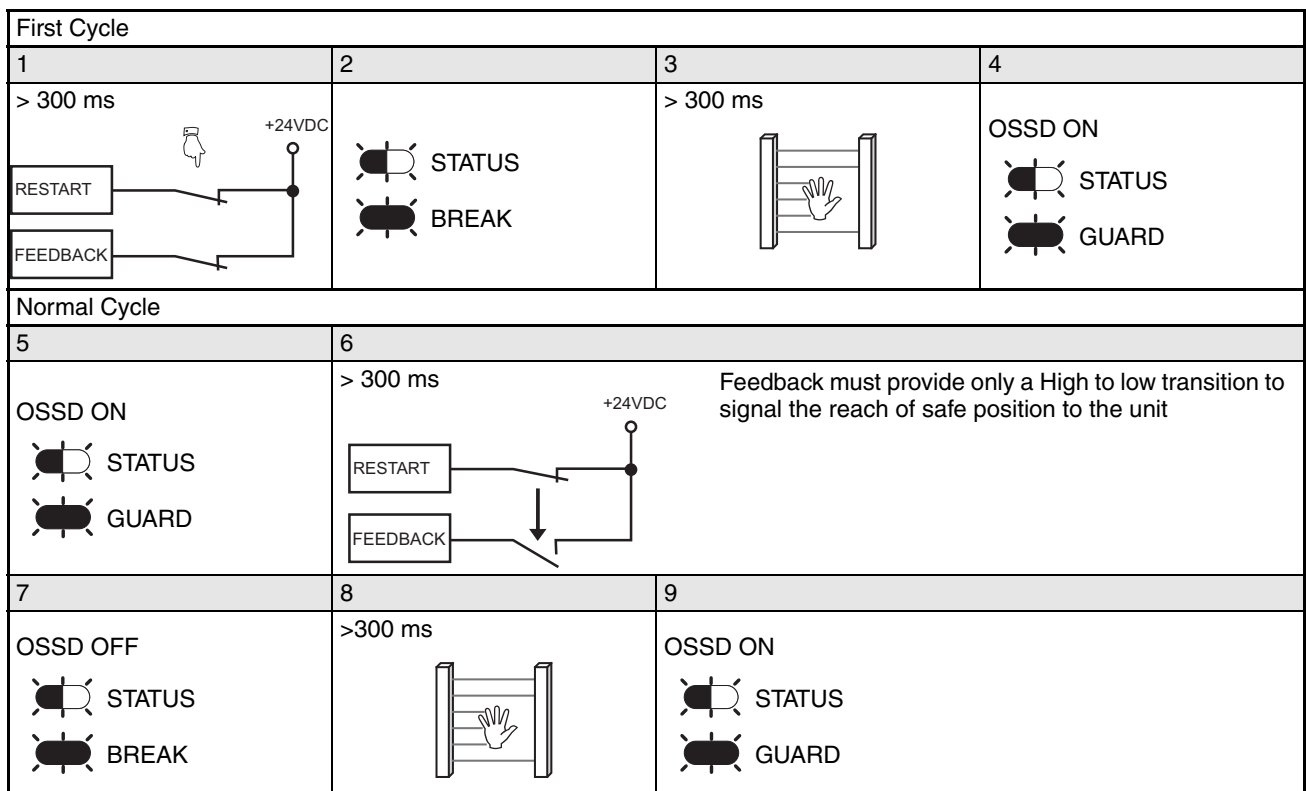

Cycles repeat from 6 to 9.

Timing

- 1 input at power on of system or after any undesired interruption for cycle. Must be longer than 300 ms
- 6 feedback transition signaling the reach of safe position of the tool.
- 3 and 8 minimum time of interruption for the protected field must be >300 ms
- 1 to 3 and 6 to 8: must be less than 30 sec.

- 5 to 6: no time limit since this depends on the operation time of the machine.
- Cycle repeats from 6 to 9.

11-5-2 Double break function





This operation mode is similar to single break operation except: Operator is doing a loading and an unloading cycle manually. F3S-TGR-CL system will enter the MACHINE RUN state when the detection zone was entered and cleared again twice.

Each operating cycle monitored by the single break function works as follows:

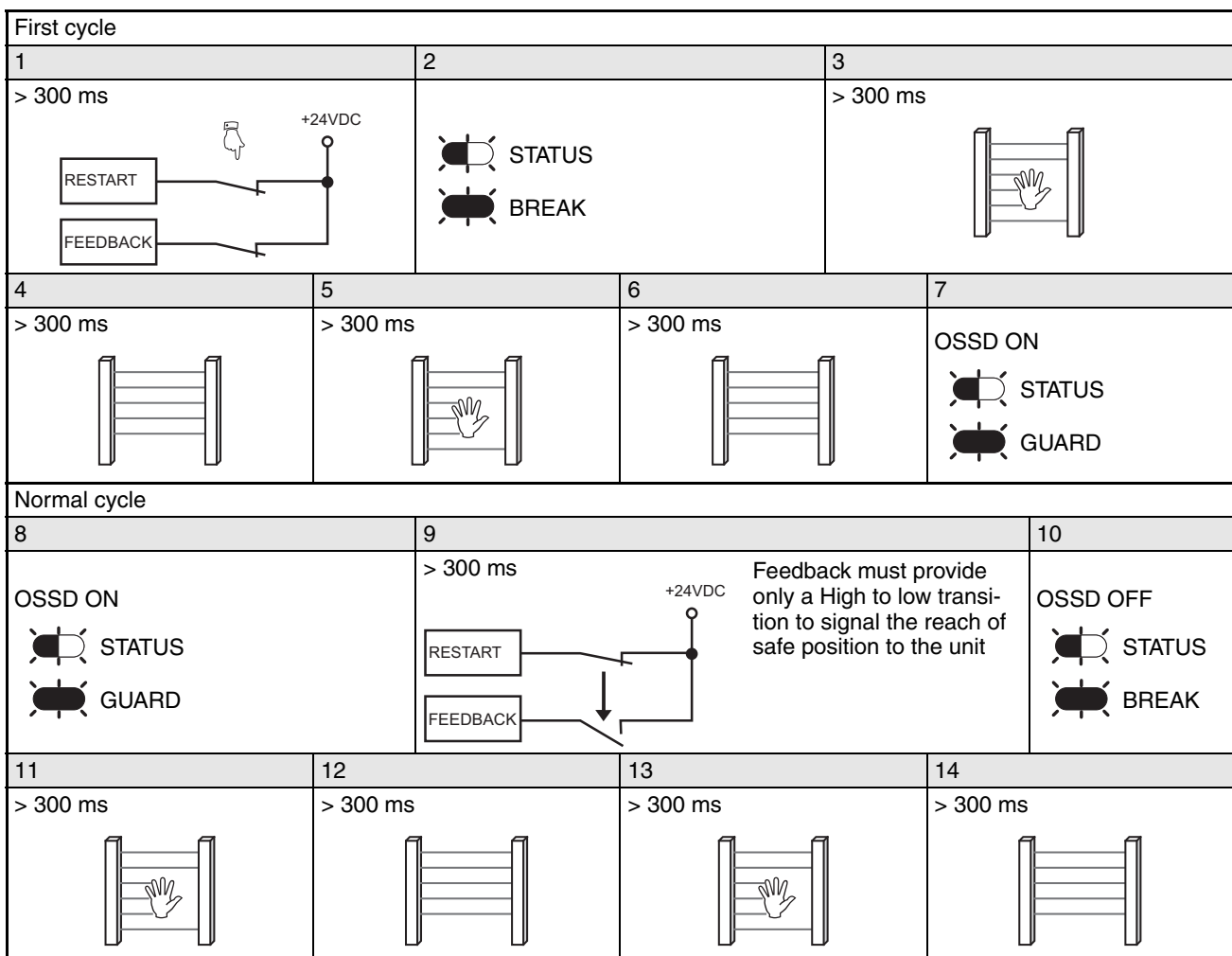
- Protected field is interrupted and free the first time(unload manually)
- Protected field is interrupted and free the second time(load manually)
- Safety outputs enter MACHINE RUN STATE and machine operates
- When machine operate feedback is not tested.
- When end of position is reached the feedback input provide a high to low transition
- Safety outputs enter MACHINE STOP state

Note A manual restart is necessary to start the double break function sequence again after power on or any other interruption of the protective field while the machine is working.

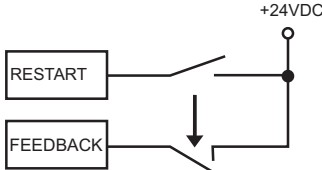

15	16	17
<p>OSSD ON</p> <p> STATUS</p> <p> GUARD</p>	<p>> 300 ms</p>  <p>Feedback must provide only a High to low transition to signal the reach of safe position to the unit</p>	<p>OSSD OFF</p> <p> STATUS</p> <p> BREAK</p>

Cycles repeat from 11 to 17.

Timing

- 1 input at power on of system or after any undesired interruption for cycle. Must be longer than 300 ms
- 6 feedback transition signaling the reach of safe position of the tool.
- 3 and 8 minimum time of interruption for the protected field must be >300 ms
- 1 to 3 and 6 to 8: must be less than 30 sec.
- 5 to 6: no time limit since this depends on the operation time of the machine.

SECTION 12

Checkout and Test procedure

12-1 Checkout Procedure

Once the F3S-TGR-CL system has been configured, mounted, aligned and properly connected to the machine control system, the initial Checkout Procedure detailed in Appendix A must be performed by qualified personnel. A copy of the checkout results should be kept with the machine records.

12-2 Test Procedure

⚠ WARNING The tests outlined in the Test Procedure in Appendix B must be performed at installation, according to the employer's regular inspection program and after any maintenance, tooling change set up, adjustment or modification to the F3S-TGR-CL system or the guarded machine. Where a guarded machine is used by multiple operators or shifts, it is suggested that the test procedure is performed at each shift or operator change. Testing ensures that the light curtain and the machine control system work properly to stop the machine. Failure to test properly could result in serious injury to personnel.

The test procedure must be performed by qualified personnel. To test the F3S-TGR-CL system with fixed blanking and floating blanking disabled, use the supplied test object. For applications where blanking is enabled, see the table in the chapter "Blanking" to determine the proper size of the test object.

12-3 Using the test object

When using the test object, guide it through the detection zone as shown:

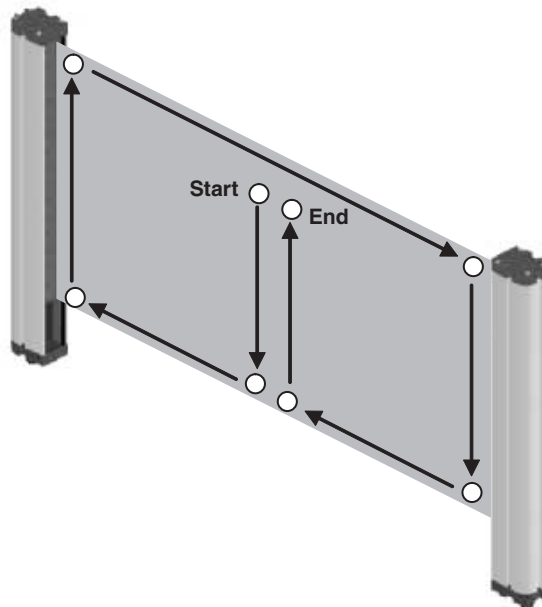

12-4 Regular checkout and test

 **WARNING** Make sure that following checkout and test routines are carried out on a regular base. Failure to test properly could result in serious injury to personnel. All tests must be performed by qualified personnel. A copy of the checkout results should be kept with the machine records.

 **WARNING** Repeat Tests 1 and 2 on a daily base. Repeat Tests 1 to 6 at least every six months. Failure to test properly could result in serious injury to personnel.

1. Guide the test object as shown in 12.3 through the entire protective field. Check that
 - a) In automatic restart mode:
The outputs of the F3S-TGR-CL system remain in the OFF state during the entire test.
 - b) In manual restart mode:
The beam blocked state is shown by the STATUS LED on the receiver (LED off).
2. Activate the TEST/RESTART input (open the NC contact). Check that the safety outputs of the F3S-TGR-CL system change from MACHINE RUN to MACHINE STOP state.
3. Check that the mounting distance of the F3S-TGR-CL system is equal to or greater than the minimum safe distance from the danger point. See the chapter *Safe Mounting Distances* on page 21 for further information.
4. Determine that all access to the danger point not protected by the F3S-TGR-CL system is guarded by other means, such as gates, fencing or other approved methods. Verify that all additional guarding devices are installed and operating properly.
5. Make sure the operator is not able to stand between the F3S-TGR-CL system detection zone and the machine danger point. Verify that the light curtain can only be reset from a position outside and within view of the hazardous machine area. Otherwise please use the Pre-reset function.
6. Inspect the electrical connections between the guarded machine's control system and the F3S-TGR-CL system. Verify that they are properly connected to the machine such that a stop signal from the F3S-TGR-CL system results in an immediate halt of the machine's cycle. See the chapter *Connection to the Machine control circuit* on page 30 for further information.

SECTION 13

Cleaning

Accumulation of oil, dirt and grease on the front window of the F3S-TGR-CL transmitter and receiver can effect the system operation. Clean the window with a mild detergent or glass cleaner. Use a clean, soft, lint-free cloth. Painted F3S-TGR-CL surfaces may be cleaned with a mild de-greasing cleaner or detergent.

SECTION 14

Specification and additional information

14-1 Specification

Performance	
Protective height	150 mm - 2,400 mm
Object Resolution	14 mm, 35 mm and 70 mm
Beam pitch (center)	7.5 mm and 18 mm
Operating Range	0.2 m - 3.0 m (14 mm resolution), default 3.0 m - 6.0 m (14 mm resolution), DIP SW option 0.2 m - 7.0 m (35 mm and 70 mm resolution), default 7.0 m - 14 m (35 mm and 70 mm resolution), DIP SW option
Effective Aperture Angle	For F3S-TGR-CL2: ±5° maximum, transmitter and receiver according to IEC61496-2 (2006) for distances > 3 m For F3S-TGR-CL4: ±2,5° maximum, transmitter and receiver according to IEC61496-2 (2006) for distances > 3 m
Response Time (RT) ON to OFF	Maximum: 103 ms (See table below for more details)
Light Source	Infrared Emitting LEDs, Wavelength 880 nm Power Dissipation: ≤3 mW Class 1 acc. EN60825-1

Mechanical	
Housing Material	Painted aluminum, Yellow, RAL 1018
Front Window Material	Acrylic Lexan
End Cap Material	ABS (standalone models) Die cast aluminum (master models)
Connector Material	Stainless steel
Sealing Gasket Material	EPDM
Mounting Bracket Material	Cold rolled Steel
Wiring connections	M12-connectors; 8-pin receiver and 4-pin transmitter
Weight	See table for more details

Environmental	
Enclosure Rating	IP65
Operating Temperature	-10°C ... +55°C
Storage Temperature	-25°C ... +70°C
Relative Humidity	95% maximum, non-condensing
Vibration (IEC 60068-2-6)	10-70 Hz, 0.35 mm, maximum on all 3 axes
Shock (IEC 60086-2-29)	30 G for 16 ms, 1000 shocks on all 3 axes

Electrical	
Power Input Transmitter	24 VDC ±20%, maximum current 70 mA
TEST Input	24 VDC ±20%, 10 mA typ.
Power Input Receiver	24 VDC ±20%, maximum current 100 mA Receiver 180 mA (in muting) + OSSD1 250 mA + OSSD2 250 mA
Input threshold Voltage	$V_{Hmin} = 17 \text{ VDC}$, $V_{Lmax} = 6 \text{ V}$
Test/Restart Input	10 mA @ 24 VDC, Normally closed input, $t_{pulse} > 2,5s$
Muting A	10 mA @ 24 VDC

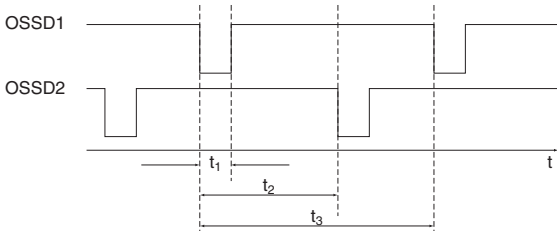
Electrical	
Muting B	10 mA @ 24 VDC
EDM - Monitor Input	10 mA @ 24 VDC
Muting Lamp LMS	50 mA min @ 24 VDC (LED and bulb based lamps) max. 6 W => 250 mA @ 24 VDC
Input pulse characteristic	$t_{\text{pulse}} < 2 \times \text{Response time of the system}$
Safety Output (OSSDs)	Two PNP safety outputs, each output sourcing 250 mA @ 24 VDC. Short circuit protection
Voltage Drop	< 2.3 V
Leakage current	< 1 mA
Capacitive Load	< 250 nF for OSSD output
Inductive Load	Please contact your Omron representative for further information.
Test pulse data	 <p>t1: Test pulse $\leq 300 \mu\text{s}$ t2: Test interval $> \text{Response time} \times 0.33$ t3: Repetition $> \text{Response time} \times 0.66$</p>
Power Supply	Must meet the requirements of EN/IEC60204-1 and EN/IEC61496-1, and must guarantee safe insulation from the mains voltage in accordance with IEC60742 and be able to cover a drop of supply voltage of at least 20 ms.
Protection class (IEC 536 or VDE 106)	III
Power-on delay	<2 s
Insulation resistance	>20M Ω
Dielectric Voltage Strength	350 VAC (1 min)
Connections	
Cable length F3S-TGR-CL Transmitter	Shielded cables: Max. 50 m, @ 0.2 mm ² Max 100 m, @ 0.4 mm ² Coding connections does not reduce the max cable length We recommend to use the connection cables shown in the accessories to connect the F3S-TGR-CL system to the machine control system.
Cable length F3S-TGR-CL Receiver	Shielded cables: Max. 50 m, @ 0.2 mm ² Max 100 m, @ 0.4 mm ² Coding connections does not reduce the max cable length We recommend to use the connection cables shown in the accessories to connect the F3S-TGR-CL system to the machine control system.
Cable length F3S-TGR-CL-MIX system	Shielded cables, M12 connector 8-pin, these cables are shipped with the sensors. Maximum length is 0.9 m between segments

Conformity	
AOPD(ESPE)	F3S-TGR-CL2: Type 2 acc. to EN/IEC 61496-1 (2008) and IEC 61496-2 (2006) F3S-TGR-CL4: Type 4 acc. to EN 61496-1/A1 (2008) and IEC 61496-2 (2006)
Safety category	F3S-TGR-CL2 system is suitable for safety control systems up to Category 2 acc. EN 13849-1 (2008) F3S-TGR-CL4 system is suitable for safety control systems up to Category 4 acc. EN ISO 13849-1 (2008)
Safety Integrity Level	F3S-TGR-CL system is suitable for up to SIL 3 per IEC 61508
Performance level (PL)	F3S-TGR-CL2 system is suitable for safety control systems up to Performance level c acc. EN ISO 13849-1 (2008) F3S-TGR-CL4 system is suitable for safety control systems up to Performance level e acc. EN ISO 13849-1 (2008)
Mean time to dangerous failure (MTTFd)	100 years
Diagnostic Coverage (DC)	High acc. EN ISO 13849-1 (2008)
Mean time to repair (MTTR)	8 hours
PFHd	$2.5 * 10^{-09}$
Proof test interval	Every 20 years

Response time of F3S-TGR-CL__-014-___ system				
Part No.	Number of		Response time	
	modules	beams	ON→OFF	OFF→ON
F3S-TGR-CL__-014-0150	7	21	18 ms	138 ms
F3S-TGR-CL__-014-0300	7	42	23 ms	135 ms
F3S-TGR-CL__-014-0450	7	63	29 ms	131 ms
F3S-TGR-CL__-014-0600	7	84	35 ms	127 ms
F3S-TGR-CL__-014-0750	7	105	40 ms	123 ms
F3S-TGR-CL__-014-0900	7	136	46 ms	119 ms
F3S-TGR-CL__-014-1050	7	147	52 ms	116 ms
F3S-TGR-CL__-014-1200	7	168	58 ms	112 ms
F3S-TGR-CL__-014-1350	7	189	63 ms	108 ms
F3S-TGR-CL__-014-1500	7	210	69 ms	104 ms
F3S-TGR-CL__-014-1650	7	231	75 ms	100 ms
F3S-TGR-CL__-014-1800	7	252	80 ms	97 ms
F3S-TGR-CL__-014-1950	7	273	86 ms	93 ms
F3S-TGR-CL__-014-2100	7	294	92 ms	93 ms
F3S-TGR-CL__-014-2250	7	315	97 ms	98 ms
F3S-TGR-CL__-014-2400	7	336	103 ms	104 ms

Response time of F3S-TGR-CL__-035-___ system				
Part No.	Number of		Response time	
	modules	beams	ON→OFF	OFF→ON
F3S-TGR-CL__-035-0150	4	8	14 ms	141 ms
F3S-TGR-CL__-035-0300	4	16	16 ms	139 ms
F3S-TGR-CL__-035-0450	4	24	19 ms	138 ms
F3S-TGR-CL__-035-0600	4	32	21 ms	136 ms
F3S-TGR-CL__-035-0750	4	40	23 ms	135 ms
F3S-TGR-CL__-035-0900	4	48	25 ms	133 ms

Response time of F3S-TGR-CL__-035-___ system				
Part No.	Number of		Response time	
	modules	beams	ON→OFF	OFF→ON
F3S-TGR-CL__-035-1050	4	56	27 ms	132 ms
F3S-TGR-CL__-035-1200	4	64	29 ms	131 ms
F3S-TGR-CL__-035-1350	8	72	32 ms	129 ms
F3S-TGR-CL__-035-1500	8	80	34 ms	128 ms
F3S-TGR-CL__-035-1650	8	88	36 ms	126 ms
F3S-TGR-CL__-035-1800	8	96	38 ms	125 ms
F3S-TGR-CL__-035-1950	8	104	40 ms	123 ms
F3S-TGR-CL__-035-2100	8	112	42 ms	122 ms
F3S-TGR-CL__-035-2250	8	120	45 ms	120 ms
F3S-TGR-CL__-035-2400	8	128	47 ms	119 ms

Response time of F3S-TGR-CL__-070-___ system				
Part No.	Number of		Response time	
	modules	beams	ON→OFF	OFF→ON
F3S-TGR-CL-__070-0300	4	8	14 ms	141 ms
F3S-TGR-CL-__070-0600	4	16	16 ms	139 ms
F3S-TGR-CL-__070-0900	4	24	19 ms	138 ms
F3S-TGR-CL-__070-1200	4	32	21 ms	136 ms
F3S-TGR-CL-__070-1500	4	40	23 ms	135 ms
F3S-TGR-CL-__070-1800	4	48	25 ms	133 ms
F3S-TGR-CL-__070-2100	4	56	27 ms	132 ms

Response time of a MIX system: The total response time is calculated by the response time of the Master plus the response time of the Slave.

14-2 F3S-TGR-CL standalone system Dimensional drawing

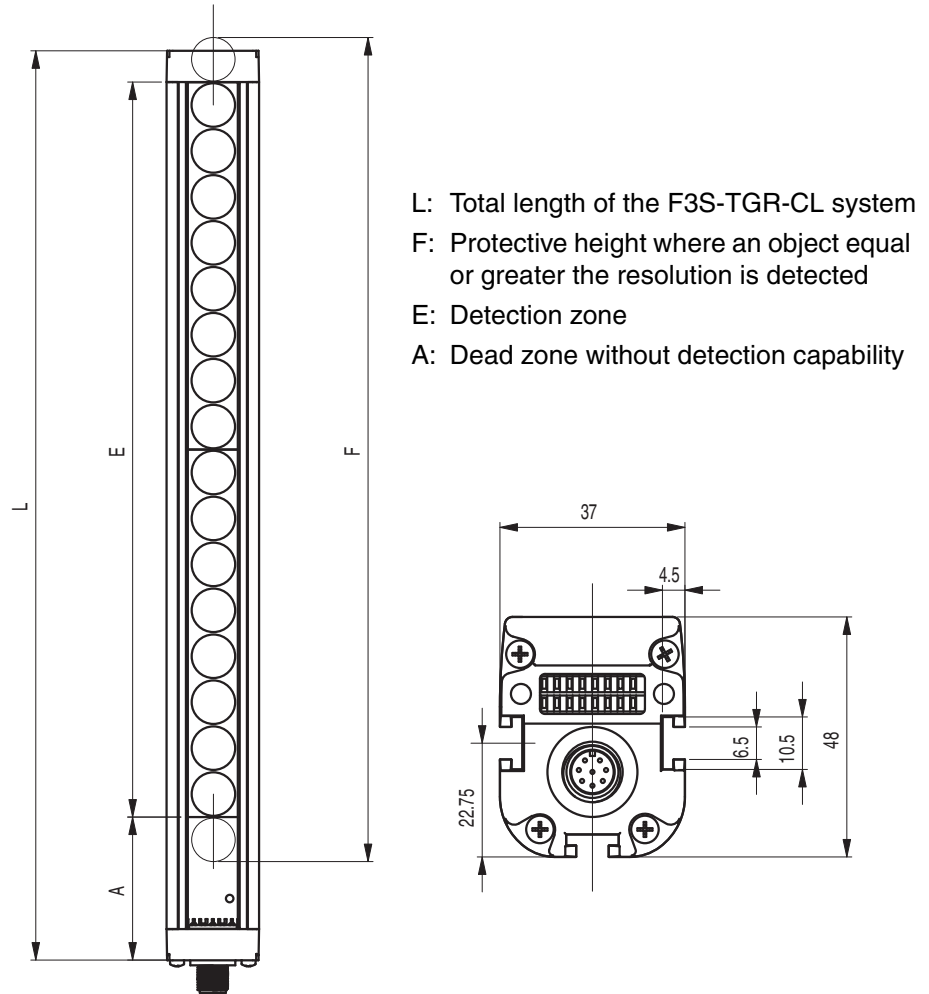

14-3 F3S-TGR-CL system data with 14 mm resolution

Model number	Weight	Dimensions		
		F	L	A
F3S-TGR-CL__-014-0150	0.83 kg	161 mm	217 mm	59 mm
F3S-TGR-CL__-014-0300	1.39 kg	308 mm	364 mm	59 mm
F3S-TGR-CL__-014-0450	1.95 kg	455 mm	511 mm	59 mm
F3S-TGR-CL__-014-0600	2.51 kg	602 mm	658 mm	59 mm
F3S-TGR-CL__-014-0750	3.07 kg	749 mm	805 mm	59 mm
F3S-TGR-CL__-014-0900	3.63 kg	896 mm	952 mm	59 mm
F3S-TGR-CL__-014-1050	4.19 kg	1043 mm	1099 mm	59 mm
F3S-TGR-CL__-014-1200	4.75 kg	1190 mm	1246 mm	59 mm
F3S-TGR-CL__-014-1350	5.31 kg	1337 mm	1393 mm	59 mm
F3S-TGR-CL__-014-1500	5.87 kg	1484 mm	1540 mm	59 mm
F3S-TGR-CL__-014-1650	6.43 kg	1631 mm	1687 mm	59 mm
F3S-TGR-CL__-014-1800	7 kg	1778 mm	1834 mm	59 mm
F3S-TGR-CL__-014-1950	7.55 kg	1925 mm	1981 mm	59 mm
F3S-TGR-CL__-014-2100	8.11 kg	2072 mm	2128 mm	59 mm
F3S-TGR-CL__-014-2250	8.67 kg	2219 mm	2275 mm	59 mm
F3S-TGR-CL__-014-2400	9.24 kg	2366 mm	2422 mm	59 mm

14-4 F3S-TGR-CL system data with 35 mm resolution

Model number	Weight	Dimensions		
		F	L	A
F3S-TGR-CL__-035-0150	0.83 kg	182 mm	217 mm	59 mm
F3S-TGR-CL__-035-0300	1.39 kg	329 mm	364 mm	59 mm
F3S-TGR-CL__-035-0450	1.95 kg	476 mm	511 mm	59 mm
F3S-TGR-CL__-035-0600	2.51 kg	623 mm	658 mm	59 mm
F3S-TGR-CL__-035-0750	3.07 kg	770 mm	805 mm	59 mm
F3S-TGR-CL__-035-0900	3.63 kg	917 mm	952 mm	59 mm
F3S-TGR-CL__-035-1050	4.19 kg	1064 mm	1099 mm	59 mm
F3S-TGR-CL__-035-1200	4.75 kg	1211 mm	1246 mm	59 mm
F3S-TGR-CL__-035-1350	5.31 kg	1358 mm	1393 mm	59 mm
F3S-TGR-CL__-035-1500	5.87 kg	1505 mm	1540 mm	59 mm
F3S-TGR-CL__-035-1650	6.43 kg	1652 mm	1687 mm	59 mm
F3S-TGR-CL__-035-1800	7 kg	1799 mm	1834 mm	59 mm
F3S-TGR-CL__-035-1950	7.55 kg	1946 mm	1981 mm	59 mm
F3S-TGR-CL__-035-2100	8.11 kg	2093 mm	2128 mm	59 mm
F3S-TGR-CL__-035-2250	8.67 kg	2240 mm	2275 mm	59 mm
F3S-TGR-CL__-035-2400	9.24 kg	2387 mm	2422 mm	59 mm

14-5 F3S-TGR-CL system data with 070 mm resolution

Modul number	Weight	Dimension		
		F	L	A
F3S-TGR-CL-_070-0300	1.39 kg	347 mm	364 mm	59 mm
F3S-TGR-CL-_070-0600	2.51 kg	641 mm	685 mm	59 mm
F3S-TGR-CL-_070-0900	3.63 kg	931 mm	952 mm	59 mm
F3S-TGR-CL-_070-1200	4.75 kg	1229 mm	1246 mm	59 mm
F3S-TGR-CL-_070-1500	5.87 kg	1523 mm	1540 mm	59 mm
F3S-TGR-CL-_070-1800	7.00 kg	1817 mm	1834 mm	59 mm
F3S-TGR-CL-_070-2100	8.11 kg	2111 mm	2128 mm	59 mm

14-6 F3S-TGR-CL MIX system Dimensional drawing

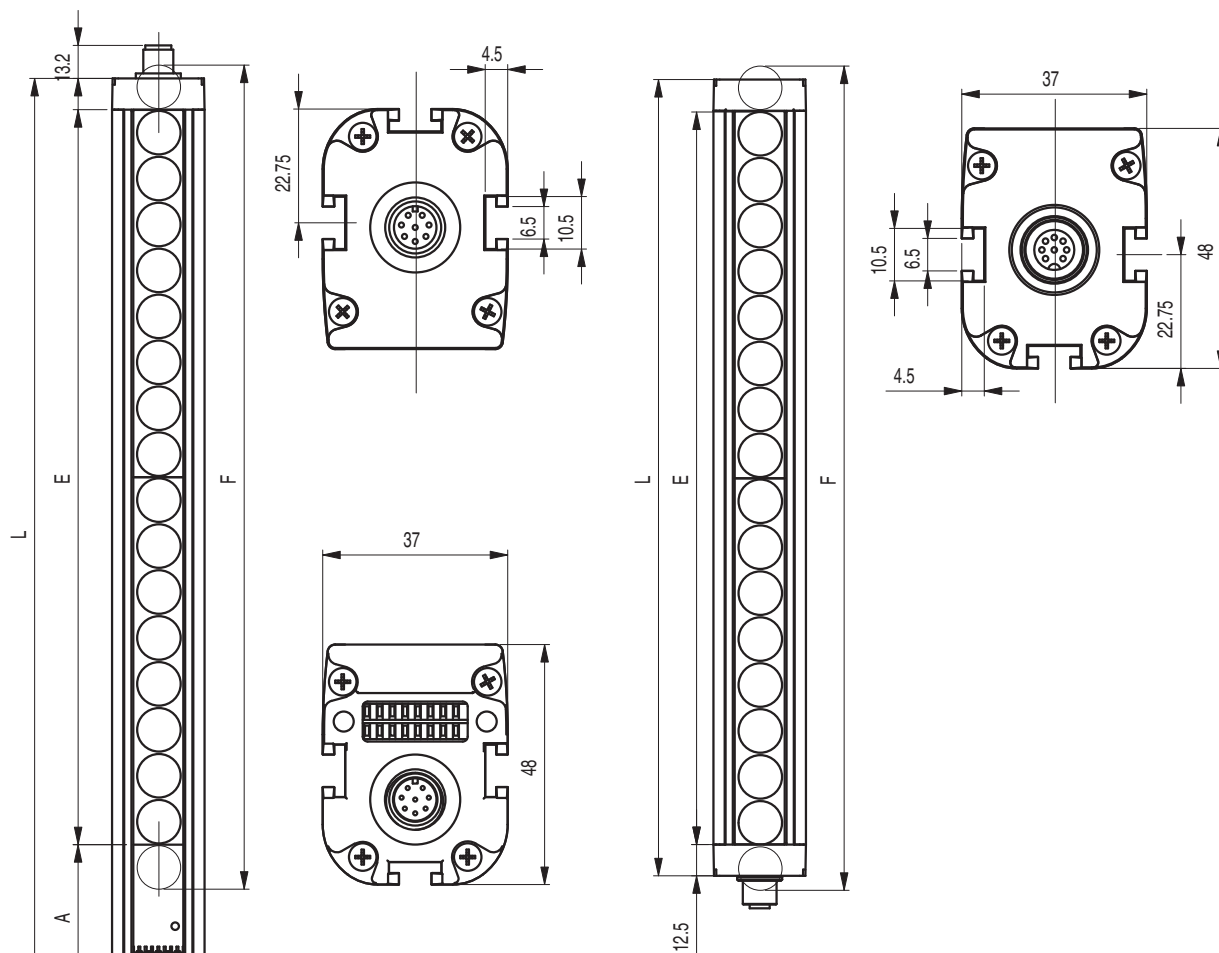

- L: Total length of the F3S-TGR-CL system
- F: Protective height where an object equal or greater the resolution is detected
- E: Detection zone
- A: Dead zone without detection capability

14-7 F3S-TGR-CL Master system data with 14 mm resolution

Model number	Weight	Dimensions		
		F	L	A
F3S-TGR-CL__-014-0150M	0.85 kg	161 mm	217 mm	59 mm
F3S-TGR-CL__-014-0300M	1.41 kg	308 mm	364 mm	59 mm
F3S-TGR-CL__-014-0450M	1.97 kg	455 mm	511 mm	59 mm
F3S-TGR-CL__-014-0600M	2.53 kg	602 mm	658 mm	59 mm
F3S-TGR-CL__-014-0750M	3.1 kg	749 mm	805 mm	59 mm
F3S-TGR-CL__-014-0900M	3.65 kg	896 mm	952 mm	59 mm
F3S-TGR-CL__-014-1050M	4.22 kg	1043 mm	1099 mm	59 mm
F3S-TGR-CL__-014-1200M	4.78 kg	1190 mm	1246 mm	59 mm
F3S-TGR-CL__-014-1350M	5.34 kg	1337 mm	1393 mm	59 mm
F3S-TGR-CL__-014-1500M	5.9 kg	1484 mm	1540 mm	59 mm
F3S-TGR-CL__-014-1650M	6.46 kg	1631 mm	1687 mm	59 mm
F3S-TGR-CL__-014-1800M	7.02 kg	1778 mm	1834 mm	59 mm
F3S-TGR-CL__-014-1950M	7.58 kg	1925 mm	1981 mm	59 mm
F3S-TGR-CL__-014-2100M	8.14 kg	2072 mm	2128 mm	59 mm
F3S-TGR-CL__-014-2250M	8.76 kg	2219 mm	2275 mm	59 mm

14-8 F3S-TGR-CL Master system data with 35 mm resolution

Model number	Weight	Dimensions		
		F	L	A
F3S-TGR-CL__-035-0150M	0.85 kg	182 mm	217 mm	59 mm
F3S-TGR-CL__-035-0300M	1.41 kg	329 mm	364 mm	59 mm
F3S-TGR-CL__-035-0450M	1.97 kg	476 mm	511 mm	59 mm
F3S-TGR-CL__-035-0600M	2.53 kg	623 mm	658 mm	59 mm
F3S-TGR-CL__-035-0750M	3.1 kg	770 mm	805 mm	59 mm
F3S-TGR-CL__-035-0900M	3.65 kg	917 mm	952 mm	59 mm
F3S-TGR-CL__-035-1050M	4.22 kg	1064 mm	1099 mm	59 mm
F3S-TGR-CL__-035-1200M	4.78 kg	1211 mm	1246 mm	59 mm
F3S-TGR-CL__-035-1350M	5.34 kg	1358 mm	1393 mm	59 mm
F3S-TGR-CL__-035-1500M	5.9 kg	1505 mm	1540 mm	59 mm
F3S-TGR-CL__-035-1650M	6.46 kg	1652 mm	1687 mm	59 mm
F3S-TGR-CL__-035-1800M	7.02 kg	1799 mm	1834 mm	59 mm
F3S-TGR-CL__-035-1950M	7.58 kg	1925 mm	1981 mm	59 mm
F3S-TGR-CL__-035-2100M	8.14 kg	2072 mm	2128 mm	59 mm
F3S-TGR-CL__-035-2250M	8.76 kg	2219 mm	2275 mm	59 mm

14-9 F3S-TGR-CL Slave system data with 14 mm resolution

Model number	Weight	Dimensions		
		F	L	A
F3S-TGR-CL__-014-0150S	0.61 kg	161 mm	172 mm	12.5 mm
F3S-TGR-CL__-014-0300S	1.17 kg	308 mm	319 mm	12.5 mm
F3S-TGR-CL__-014-0450S	1.73 kg	455 mm	466 mm	12.5 mm
F3S-TGR-CL__-014-0600S	2.29 kg	602 mm	613 mm	12.5 mm
F3S-TGR-CL__-014-0750S	2.86 kg	749 mm	760 mm	12.5 mm
F3S-TGR-CL__-014-0900S	3.41 kg	896 mm	907 mm	12.5 mm
F3S-TGR-CL__-014-1050S	3.98 kg	1043 mm	1054 mm	12.5 mm
F3S-TGR-CL__-014-1200S	4.54 kg	1190 mm	1201 mm	12.5 mm
F3S-TGR-CL__-014-1350S	5.10 kg	1337 mm	1348 mm	12.5 mm
F3S-TGR-CL__-014-1500S	5.66 kg	1484 mm	1495 mm	12.5 mm
F3S-TGR-CL__-014-1650S	6.22 kg	1631 mm	1642 mm	12.5 mm
F3S-TGR-CL__-014-1800S	6.78 kg	1778 mm	1798 mm	12.5 mm
F3S-TGR-CL__-014-1950S	7.34 kg	1925 mm	1936 mm	12.5 mm
F3S-TGR-CL__-014-2100S	7.90 kg	2072 mm	2083 mm	12.5 mm
F3S-TGR-CL__-014-2250S	8.46 kg	2219 mm	2230 mm	12.5 mm

14-10 F3S-TGR-CL Slave system data with 35 mm resolution

Model number	Weight	Dimensions		
		F	L	A
F3S-TGR-CL__-035-0150S	0.61 kg	182 mm	172 mm	12.5 mm
F3S-TGR-CL__-035-0300S	1.17 kg	329 mm	319 mm	12.5 mm
F3S-TGR-CL__-035-0450S	1.73 kg	476 mm	466 mm	12.5 mm
F3S-TGR-CL__-035-0600S	2.29 kg	623 mm	613 mm	12.5 mm
F3S-TGR-CL__-035-0750S	2.86 kg	770 mm	760 mm	12.5 mm
F3S-TGR-CL__-035-0900S	3.41 kg	917 mm	907 mm	12.5 mm
F3S-TGR-CL__-035-1050S	3.98 kg	1064 mm	1054 mm	12.5 mm
F3S-TGR-CL__-035-1200S	4.54 kg	1211 mm	1201 mm	12.5 mm
F3S-TGR-CL__-035-1350S	5.10 kg	1358 mm	1348 mm	12.5 mm
F3S-TGR-CL__-035-1500S	5.66 kg	1505 mm	1495 mm	12.5 mm
F3S-TGR-CL__-035-1650S	6.22 kg	1652 mm	1642 mm	12.5 mm
F3S-TGR-CL__-035-1800S	6.78 kg	1799 mm	1798 mm	12.5 mm
F3S-TGR-CL__-035-1950S	7.34 kg	1925 mm	1936 mm	12.5 mm
F3S-TGR-CL__-035-2100S	7.90 kg	2072 mm	2083 mm	12.5 mm
F3S-TGR-CL__-035-2250S	8.46 kg	2219 mm	2230 mm	12.5 mm

14-11 F3S-TGR-CL Slave system data with 70 mm resolution

Modul number	Weight	Dimension		
		F	L	A
F3S-TGR-CL-_070-0300S	1.39 kg	347 mm	364 mm	59 mm
F3S-TGR-CL-_070-0600S	2.51 kg	641 mm	685 mm	59 mm
F3S-TGR-CL-_070-0900S	3.63 kg	931 mm	952 mm	59 mm
F3S-TGR-CL-_070-1200S	4.75 kg	1229 mm	1246 mm	59 mm
F3S-TGR-CL-_070-1500S	5.87 kg	1523 mm	1540 mm	59 mm
F3S-TGR-CL-_070-1800S	7.00 kg	1817 mm	1834 mm	59 mm
F3S-TGR-CL-_070-2100S	8.11 kg	2111 mm	2128 mm	59 mm

14-12 List of models standalone models

14-12-1 Safety Category 2, 14 mm resolution, Standalone unit

Type Name	Version	Resolution [mm]	Length [mm]	Operation
F3S-TGR-CL2B-014-0150	Basic	14 mm	150	Standalone
F3S-TGR-CL2B-014-0300	Basic	14 mm	300	Standalone
F3S-TGR-CL2B-014-0450	Basic	14 mm	450	Standalone
F3S-TGR-CL2B-014-0600	Basic	14 mm	600	Standalone
F3S-TGR-CL2B-014-0750	Basic	14 mm	750	Standalone
F3S-TGR-CL2B-014-0900	Basic	14 mm	900	Standalone
F3S-TGR-CL2B-014-1050	Basic	14 mm	1050	Standalone
F3S-TGR-CL2B-014-1200	Basic	14 mm	1200	Standalone
F3S-TGR-CL2B-014-1350	Basic	14 mm	1350	Standalone
F3S-TGR-CL2B-014-1500	Basic	14 mm	1500	Standalone
F3S-TGR-CL2B-014-1650	Basic	14 mm	1650	Standalone
F3S-TGR-CL2B-014-1800	Basic	14 mm	1800	Standalone
F3S-TGR-CL2B-014-1950	Basic	14 mm	1950	Standalone
F3S-TGR-CL2B-014-2100	Basic	14 mm	2100	Standalone
F3S-TGR-CL2B-014-2250	Basic	14 mm	2250	Standalone
F3S-TGR-CL2B-014-2400	Basic	14 mm	2400	Standalone

Type Name	Version	Resolution [mm]	Length [mm]	Operation
F3S-TGR-CL2A-014-0150	Advanced	14 mm	150	Standalone
F3S-TGR-CL2A-014-0300	Advanced	14 mm	300	Standalone
F3S-TGR-CL2A-014-0450	Advanced	14 mm	450	Standalone
F3S-TGR-CL2A-014-0600	Advanced	14 mm	600	Standalone
F3S-TGR-CL2A-014-0750	Advanced	14 mm	750	Standalone
F3S-TGR-CL2A-014-0900	Advanced	14 mm	900	Standalone
F3S-TGR-CL2A-014-1050	Advanced	14 mm	1050	Standalone
F3S-TGR-CL2A-014-1200	Advanced	14 mm	1200	Standalone
F3S-TGR-CL2A-014-1350	Advanced	14 mm	1350	Standalone
F3S-TGR-CL2A-014-1500	Advanced	14 mm	1500	Standalone
F3S-TGR-CL2A-014-1650	Advanced	14 mm	1650	Standalone
F3S-TGR-CL2A-014-1800	Advanced	14 mm	1800	Standalone
F3S-TGR-CL2A-014-1950	Advanced	14 mm	1950	Standalone
F3S-TGR-CL2A-014-2100	Advanced	14 mm	2100	Standalone
F3S-TGR-CL2A-014-2250	Advanced	14 mm	2250	Standalone
F3S-TGR-CL2A-014-2400	Advanced	14 mm	2400	Standalone

14-12-2 Safety Category 2, 35 mm resolution, Standalone unit

Type Name	Version	Resolution [mm]	Length [mm]	Operation
F3S-TGR-CL2B-035-0150	Basic	35 mm	150	Standalone
F3S-TGR-CL2B-035-0300	Basic	35 mm	300	Standalone
F3S-TGR-CL2B-035-0450	Basic	35 mm	450	Standalone
F3S-TGR-CL2B-035-0600	Basic	35 mm	600	Standalone
F3S-TGR-CL2B-035-0750	Basic	35 mm	750	Standalone
F3S-TGR-CL2B-035-0900	Basic	35 mm	900	Standalone
F3S-TGR-CL2B-035-1050	Basic	35 mm	1050	Standalone
F3S-TGR-CL2B-035-1200	Basic	35 mm	1200	Standalone
F3S-TGR-CL2B-035-1350	Basic	35 mm	1350	Standalone
F3S-TGR-CL2B-035-1500	Basic	35 mm	1500	Standalone
F3S-TGR-CL2B-035-1650	Basic	35 mm	1650	Standalone
F3S-TGR-CL2B-035-1800	Basic	35 mm	1800	Standalone
F3S-TGR-CL2B-035-1950	Basic	35 mm	1950	Standalone
F3S-TGR-CL2B-035-2100	Basic	35 mm	2100	Standalone
F3S-TGR-CL2B-035-2250	Basic	35 mm	2250	Standalone
F3S-TGR-CL2B-035-2400	Basic	35 mm	2400	Standalone

Type Name	Version	Resolution [mm]	Length [mm]	Operation
F3S-TGR-CL2A-035-0150	Advanced	35 mm	150	Standalone
F3S-TGR-CL2A-035-0300	Advanced	35 mm	300	Standalone
F3S-TGR-CL2A-035-0450	Advanced	35 mm	450	Standalone
F3S-TGR-CL2A-035-0600	Advanced	35 mm	600	Standalone
F3S-TGR-CL2A-035-0750	Advanced	35 mm	750	Standalone
F3S-TGR-CL2A-035-0900	Advanced	35 mm	900	Standalone
F3S-TGR-CL2A-035-1050	Advanced	35 mm	1050	Standalone
F3S-TGR-CL2A-035-1200	Advanced	35 mm	1200	Standalone
F3S-TGR-CL2A-035-1350	Advanced	35 mm	1350	Standalone
F3S-TGR-CL2A-035-1500	Advanced	35 mm	1500	Standalone
F3S-TGR-CL2A-035-1650	Advanced	35 mm	1650	Standalone
F3S-TGR-CL2A-035-1800	Advanced	35 mm	1800	Standalone
F3S-TGR-CL2A-035-1950	Advanced	35 mm	1950	Standalone
F3S-TGR-CL2A-035-2100	Advanced	35 mm	2100	Standalone
F3S-TGR-CL2A-035-2250	Advanced	35 mm	2250	Standalone
F3S-TGR-CL2A-035-2400	Advanced	35 mm	2400	Standalone

14-12-3 Safety Category 4, 14 mm resolution, Standalone unit

Type Name	Version	Resolution [mm]	Length [mm]	Operation
F3S-TGR-CL4B-014-0150	Basic	14 mm	150	Standalone
F3S-TGR-CL4B-014-0300	Basic	14 mm	300	Standalone
F3S-TGR-CL4B-014-0450	Basic	14 mm	450	Standalone
F3S-TGR-CL4B-014-0600	Basic	14 mm	600	Standalone
F3S-TGR-CL4B-014-0750	Basic	14 mm	750	Standalone
F3S-TGR-CL4B-014-0900	Basic	14 mm	900	Standalone
F3S-TGR-CL4B-014-1050	Basic	14 mm	1050	Standalone
F3S-TGR-CL4B-014-1200	Basic	14 mm	1200	Standalone
F3S-TGR-CL4B-014-1350	Basic	14 mm	1350	Standalone
F3S-TGR-CL4B-014-1500	Basic	14 mm	1500	Standalone
F3S-TGR-CL4B-014-1650	Basic	14 mm	1650	Standalone
F3S-TGR-CL4B-014-1800	Basic	14 mm	1800	Standalone
F3S-TGR-CL4B-014-1950	Basic	14 mm	1950	Standalone
F3S-TGR-CL4B-014-2100	Basic	14 mm	2100	Standalone
F3S-TGR-CL4B-014-2250	Basic	14 mm	2250	Standalone
F3S-TGR-CL4B-014-2400	Basic	14 mm	2400	Standalone

Type Name	Version	Resolution [mm]	Length [mm]	Operation
F3S-TGR-CL4A-014-0150	Advanced	14 mm	150	Standalone
F3S-TGR-CL4A-014-0300	Advanced	14 mm	300	Standalone
F3S-TGR-CL4A-014-0450	Advanced	14 mm	450	Standalone
F3S-TGR-CL4A-014-0600	Advanced	14 mm	600	Standalone
F3S-TGR-CL4A-014-0750	Advanced	14 mm	750	Standalone
F3S-TGR-CL4A-014-0900	Advanced	14 mm	900	Standalone
F3S-TGR-CL4A-014-1050	Advanced	14 mm	1050	Standalone
F3S-TGR-CL4A-014-1200	Advanced	14 mm	1200	Standalone
F3S-TGR-CL4A-014-1350	Advanced	14 mm	1350	Standalone
F3S-TGR-CL4A-014-1500	Advanced	14 mm	1500	Standalone
F3S-TGR-CL4A-014-1650	Advanced	14 mm	1650	Standalone
F3S-TGR-CL4A-014-1800	Advanced	14 mm	1800	Standalone
F3S-TGR-CL4A-014-1950	Advanced	14 mm	1950	Standalone
F3S-TGR-CL4A-014-2100	Advanced	14 mm	2100	Standalone
F3S-TGR-CL4A-014-2250	Advanced	14 mm	2250	Standalone
F3S-TGR-CL4A-014-2400	Advanced	14 mm	2400	Standalone

14-12-4 Safety Category 4, 35 mm resolution, Standalone unit

Type Name	Version	Resolution [mm]	Length [mm]	Operation
F3S-TGR-CL4B-035-0150	Basic	35 mm	150	Standalone
F3S-TGR-CL4B-035-0300	Basic	35 mm	300	Standalone
F3S-TGR-CL4B-035-0450	Basic	35 mm	450	Standalone
F3S-TGR-CL4B-035-0600	Basic	35 mm	600	Standalone
F3S-TGR-CL4B-035-0750	Basic	35 mm	750	Standalone
F3S-TGR-CL4B-035-0900	Basic	35 mm	900	Standalone
F3S-TGR-CL4B-035-1050	Basic	35 mm	1050	Standalone
F3S-TGR-CL4B-035-1200	Basic	35 mm	1200	Standalone
F3S-TGR-CL4B-035-1350	Basic	35 mm	1350	Standalone
F3S-TGR-CL4B-035-1500	Basic	35 mm	1500	Standalone
F3S-TGR-CL4B-035-1650	Basic	35 mm	1650	Standalone
F3S-TGR-CL4B-035-1800	Basic	35 mm	1800	Standalone
F3S-TGR-CL4B-035-1950	Basic	35 mm	1950	Standalone
F3S-TGR-CL4B-035-2100	Basic	35 mm	2100	Standalone
F3S-TGR-CL4B-035-2250	Basic	35 mm	2250	Standalone
F3S-TGR-CL4B-035-2400	Basic	35 mm	2400	Standalone

Type Name	Version	Resolution [mm]	Length [mm]	Operation
F3S-TGR-CL4A-035-0150	Advanced	35 mm	150	Standalone
F3S-TGR-CL4A-035-0300	Advanced	35 mm	300	Standalone
F3S-TGR-CL4A-035-0450	Advanced	35 mm	450	Standalone
F3S-TGR-CL4A-035-0600	Advanced	35 mm	600	Standalone
F3S-TGR-CL4A-035-0750	Advanced	35 mm	750	Standalone
F3S-TGR-CL4A-035-0900	Advanced	35 mm	900	Standalone
F3S-TGR-CL4A-035-1050	Advanced	35 mm	1050	Standalone
F3S-TGR-CL4A-035-1200	Advanced	35 mm	1200	Standalone
F3S-TGR-CL4A-035-1350	Advanced	35 mm	1350	Standalone
F3S-TGR-CL4A-035-1500	Advanced	35 mm	1500	Standalone
F3S-TGR-CL4A-035-1650	Advanced	35 mm	1650	Standalone
F3S-TGR-CL4A-035-1800	Advanced	35 mm	1800	Standalone
F3S-TGR-CL4A-035-1950	Advanced	35 mm	1950	Standalone
F3S-TGR-CL4A-035-2100	Advanced	35 mm	2100	Standalone
F3S-TGR-CL4A-035-2250	Advanced	35 mm	2250	Standalone
F3S-TGR-CL4A-035-2400	Advanced	35 mm	2400	Standalone

14-13 List of models in MIX operation**14-13-1 Safety Category 2, 14 mm resolution, Master unit**

Type Name	Version	Resolution [mm]	Length [mm]	Operation
F3S-TGR-CL2A-014-0150M	Advanced	14 mm	150	Master
F3S-TGR-CL2A-014-0300M	Advanced	14 mm	300	Master
F3S-TGR-CL2A-014-0450M	Advanced	14 mm	450	Master
F3S-TGR-CL2A-014-0600M	Advanced	14 mm	600	Master
F3S-TGR-CL2A-014-0750M	Advanced	14 mm	750	Master
F3S-TGR-CL2A-014-0900M	Advanced	14 mm	900	Master
F3S-TGR-CL2A-014-1050M	Advanced	14 mm	1050	Master
F3S-TGR-CL2A-014-1200M	Advanced	14 mm	1200	Master
F3S-TGR-CL2A-014-1350M	Advanced	14 mm	1350	Master
F3S-TGR-CL2A-014-1500M	Advanced	14 mm	1500	Master
F3S-TGR-CL2A-014-1650M	Advanced	14 mm	1650	Master
F3S-TGR-CL2A-014-1800M	Advanced	14 mm	1800	Master
F3S-TGR-CL2A-014-1950M	Advanced	14 mm	1950	Master
F3S-TGR-CL2A-014-2100M	Advanced	14 mm	2100	Master
F3S-TGR-CL2A-014-2250M	Advanced	14 mm	2250	Master

14-13-2 Safety Category 2, 35 mm resolution, Master unit

Type Name	Version	Resolution [mm]	Length [mm]	Operation
F3S-TGR-CL2A-035-0150M	Advanced	35 mm	150	Master
F3S-TGR-CL2A-035-0300M	Advanced	35 mm	300	Master
F3S-TGR-CL2A-035-0450M	Advanced	35 mm	450	Master
F3S-TGR-CL2A-035-0600M	Advanced	35 mm	600	Master
F3S-TGR-CL2A-035-0750M	Advanced	35 mm	750	Master
F3S-TGR-CL2A-035-0900M	Advanced	35 mm	900	Master
F3S-TGR-CL2A-035-1050M	Advanced	35 mm	1050	Master
F3S-TGR-CL2A-035-1200M	Advanced	35 mm	1200	Master
F3S-TGR-CL2A-035-1350M	Advanced	35 mm	1350	Master
F3S-TGR-CL2A-035-1500M	Advanced	35 mm	1500	Master
F3S-TGR-CL2A-035-1650M	Advanced	35 mm	1650	Master
F3S-TGR-CL2A-035-1800M	Advanced	35 mm	1800	Master
F3S-TGR-CL2A-035-1950M	Advanced	35 mm	1950	Master
F3S-TGR-CL2A-035-2100M	Advanced	35 mm	2100	Master
F3S-TGR-CL2A-035-2250M	Advanced	35 mm	2250	Master

14-13-3 Safety Category 4, 14 mm resolution, Master unit

Type Name	Version	Resolution [mm]	Length [mm]	Operation
F3S-TGR-CL4A-014-0150M	Advanced	14 mm	150	Master
F3S-TGR-CL4A-014-0300M	Advanced	14 mm	300	Master
F3S-TGR-CL4A-014-0450M	Advanced	14 mm	450	Master
F3S-TGR-CL4A-014-0600M	Advanced	14 mm	600	Master
F3S-TGR-CL4A-014-0750M	Advanced	14 mm	750	Master
F3S-TGR-CL4A-014-0900M	Advanced	14 mm	900	Master
F3S-TGR-CL4A-014-1050M	Advanced	14 mm	1050	Master
F3S-TGR-CL4A-014-1200M	Advanced	14 mm	1200	Master
F3S-TGR-CL4A-014-1350M	Advanced	14 mm	1350	Master
F3S-TGR-CL4A-014-1500M	Advanced	14 mm	1500	Master
F3S-TGR-CL4A-014-1650M	Advanced	14 mm	1650	Master
F3S-TGR-CL4A-014-1800M	Advanced	14 mm	1800	Master
F3S-TGR-CL4A-014-1950M	Advanced	14 mm	1950	Master
F3S-TGR-CL4A-014-2100M	Advanced	14 mm	2100	Master
F3S-TGR-CL4A-014-2250M	Advanced	14 mm	2250	Master

14-13-4 Safety Category 4, 35 mm resolution, Master unit

Type Name	Version	Resolution [mm]	Length [mm]	Operation
F3S-TGR-CL4A-035-0150M	Advanced	35 mm	150	Master
F3S-TGR-CL4A-035-0300M	Advanced	35 mm	300	Master
F3S-TGR-CL4A-035-0450M	Advanced	35 mm	450	Master
F3S-TGR-CL4A-035-0600M	Advanced	35 mm	600	Master
F3S-TGR-CL4A-035-0750M	Advanced	35 mm	750	Master
F3S-TGR-CL4A-035-0900M	Advanced	35 mm	900	Master
F3S-TGR-CL4A-035-1050M	Advanced	35 mm	1050	Master
F3S-TGR-CL4A-035-1200M	Advanced	35 mm	1200	Master
F3S-TGR-CL4A-035-1350M	Advanced	35 mm	1350	Master
F3S-TGR-CL4A-035-1500M	Advanced	35 mm	1500	Master
F3S-TGR-CL4A-035-1650M	Advanced	35 mm	1650	Master
F3S-TGR-CL4A-035-1800M	Advanced	35 mm	1800	Master
F3S-TGR-CL4A-035-1950M	Advanced	35 mm	1950	Master
F3S-TGR-CL4A-035-2100M	Advanced	35 mm	2100	Master
F3S-TGR-CL4A-035-2250M	Advanced	35 mm	2250	Master

14-13-5 Safety Category 2, 14 mm resolution, Slave unit

Type Name	Version	Resolution [mm]	Length [mm]	Operation
F3S-TGR-CL2A-014-0150S	Advanced	14 mm	150	Slave
F3S-TGR-CL2A-014-0300S	Advanced	14 mm	300	Slave
F3S-TGR-CL2A-014-0450S	Advanced	14 mm	450	Slave
F3S-TGR-CL2A-014-0600S	Advanced	14 mm	600	Slave
F3S-TGR-CL2A-014-0750S	Advanced	14 mm	750	Slave
F3S-TGR-CL2A-014-0900S	Advanced	14 mm	900	Slave
F3S-TGR-CL2A-014-1050S	Advanced	14 mm	1050	Slave
F3S-TGR-CL2A-014-1200S	Advanced	14 mm	1200	Slave
F3S-TGR-CL2A-014-1350S	Advanced	14 mm	1350	Slave
F3S-TGR-CL2A-014-1500S	Advanced	14 mm	1500	Slave
F3S-TGR-CL2A-014-1650S	Advanced	14 mm	1650	Slave
F3S-TGR-CL2A-014-1800S	Advanced	14 mm	1800	Slave
F3S-TGR-CL2A-014-1950S	Advanced	14 mm	1950	Slave
F3S-TGR-CL2A-014-2100S	Advanced	14 mm	2100	Slave
F3S-TGR-CL2A-014-2250S	Advanced	14 mm	2250	Slave

14-13-6 Safety Category 2, 35 mm resolution, Slave unit

Type Name	Version	Resolution [mm]	Length [mm]	Operation
F3S-TGR-CL2A-035-0150S	Advanced	35 mm	150	Slave
F3S-TGR-CL2A-035-0300S	Advanced	35 mm	300	Slave
F3S-TGR-CL2A-035-0450S	Advanced	35 mm	450	Slave
F3S-TGR-CL2A-035-0600S	Advanced	35 mm	600	Slave
F3S-TGR-CL2A-035-0750S	Advanced	35 mm	750	Slave
F3S-TGR-CL2A-035-0900S	Advanced	35 mm	900	Slave
F3S-TGR-CL2A-035-1050S	Advanced	35 mm	1050	Slave
F3S-TGR-CL2A-035-1200S	Advanced	35 mm	1200	Slave
F3S-TGR-CL2A-035-1350S	Advanced	35 mm	1350	Slave
F3S-TGR-CL2A-035-1500S	Advanced	35 mm	1500	Slave
F3S-TGR-CL2A-035-1650S	Advanced	35 mm	1650	Slave
F3S-TGR-CL2A-035-1800S	Advanced	35 mm	1800	Slave
F3S-TGR-CL2A-035-1950S	Advanced	35 mm	1950	Slave
F3S-TGR-CL2A-035-2100S	Advanced	35 mm	2100	Slave
F3S-TGR-CL2A-035-2250S	Advanced	35 mm	2250	Slave

14-13-7 Safety Category 2, 70 mm resolution, Slave unit

Type name	Version	Resolution [mm]	Length [mm]	Operation
F3S-TGR-CL2A-070-0300S	Advanced	70 mm	300	Slave
F3S-TGR-CL2A-070-0600S	Advanced	70 mm	600	Slave
F3S-TGR-CL2A-070-0900S	Advanced	70 mm	900	Slave
F3S-TGR-CL2A-070-1200S	Advanced	70 mm	1200	Slave
F3S-TGR-CL2A-070-1500S	Advanced	70 mm	1500	Slave
F3S-TGR-CL2A-070-1800S	Advanced	70 mm	1800	Slave
F3S-TGR-CL2A-070-2100S	Advanced	70 mm	2100	Slave

14-13-8 Safety Category 4, 14 mm resolution, Slave unit

Type Name	Version	Resolution [mm]	Length [mm]	Operation
F3S-TGR-CL4A-014-0150S	Advanced	14 mm	150	Slave
F3S-TGR-CL4A-014-0300S	Advanced	14 mm	300	Slave
F3S-TGR-CL4A-014-0450S	Advanced	14 mm	450	Slave
F3S-TGR-CL4A-014-0600S	Advanced	14 mm	600	Slave
F3S-TGR-CL4A-014-0750S	Advanced	14 mm	750	Slave
F3S-TGR-CL4A-014-0900S	Advanced	14 mm	900	Slave
F3S-TGR-CL4A-014-1050S	Advanced	14 mm	1050	Slave
F3S-TGR-CL4A-014-1200S	Advanced	14 mm	1200	Slave
F3S-TGR-CL4A-014-1350S	Advanced	14 mm	1350	Slave
F3S-TGR-CL4A-014-1500S	Advanced	14 mm	1500	Slave
F3S-TGR-CL4A-014-1650S	Advanced	14 mm	1650	Slave
F3S-TGR-CL4A-014-1800S	Advanced	14 mm	1800	Slave
F3S-TGR-CL4A-014-1950S	Advanced	14 mm	1950	Slave
F3S-TGR-CL4A-014-2100S	Advanced	14 mm	2100	Slave
F3S-TGR-CL4A-014-2250S	Advanced	14 mm	2250	Slave

14-13-9 Safety Category 4, 35 mm resolution, Slave unit

Type Name	Version	Resolution [mm]	Length [mm]	Operation
F3S-TGR-CL4A-035-0150S	Advanced	35 mm	150	Slave
F3S-TGR-CL4A-035-0300S	Advanced	35 mm	300	Slave
F3S-TGR-CL4A-035-0450S	Advanced	35 mm	450	Slave
F3S-TGR-CL4A-035-0600S	Advanced	35 mm	600	Slave
F3S-TGR-CL4A-035-0750S	Advanced	35 mm	750	Slave
F3S-TGR-CL4A-035-0900S	Advanced	35 mm	900	Slave
F3S-TGR-CL4A-035-1050S	Advanced	35 mm	1050	Slave
F3S-TGR-CL4A-035-1200S	Advanced	35 mm	1200	Slave
F3S-TGR-CL4A-035-1350S	Advanced	35 mm	1350	Slave
F3S-TGR-CL4A-035-1500S	Advanced	35 mm	1500	Slave
F3S-TGR-CL4A-035-1650S	Advanced	35 mm	1650	Slave
F3S-TGR-CL4A-035-1800S	Advanced	35 mm	1800	Slave
F3S-TGR-CL4A-035-1950S	Advanced	35 mm	1950	Slave
F3S-TGR-CL4A-035-2100S	Advanced	35 mm	2100	Slave
F3S-TGR-CL4A-035-2250S	Advanced	35 mm	2250	Slave

14-13-10 Safety Category 4, 70 mm resolution, Slave unit

Type name	Version	Resolution [mm]	Length [mm]	Operation
F3S-TGR-CL4A-070-0300S	Advanced	70 mm	300	Slave
F3S-TGR-CL4A-070-0600S	Advanced	70 mm	600	Slave
F3S-TGR-CL4A-070-0900S	Advanced	70 mm	900	Slave
F3S-TGR-CL4A-070-1200S	Advanced	70 mm	1200	Slave
F3S-TGR-CL4A-070-1500S	Advanced	70 mm	1500	Slave
F3S-TGR-CL4A-070-1800S	Advanced	70 mm	1800	Slave
F3S-TGR-CL4A-070-2100S	Advanced	70 mm	2100	Slave

14-14 Accessories

14-14-1 Mechanical accessories

Mounting bracket
F39-TGR-ST-SB (included)

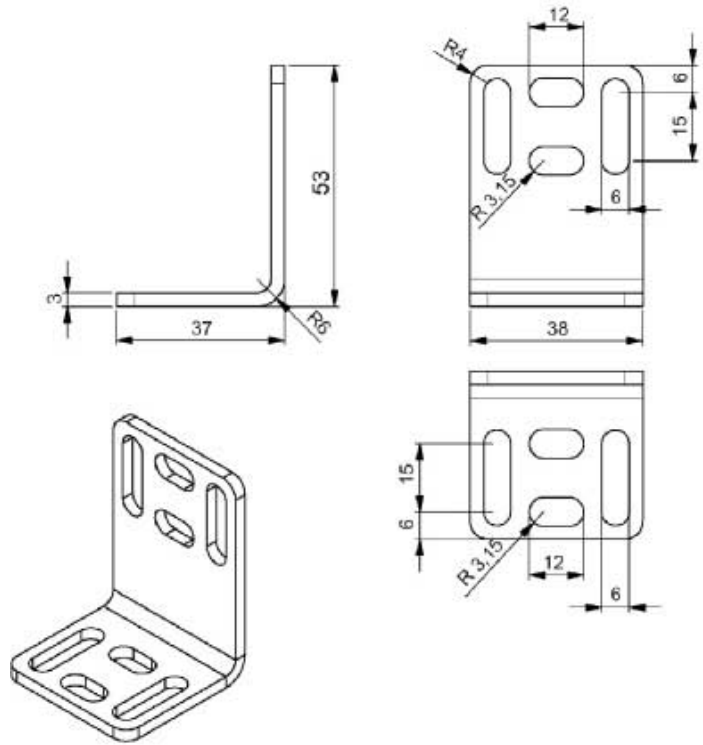

Mounting bracket
F39-TGR-ST-ADJ

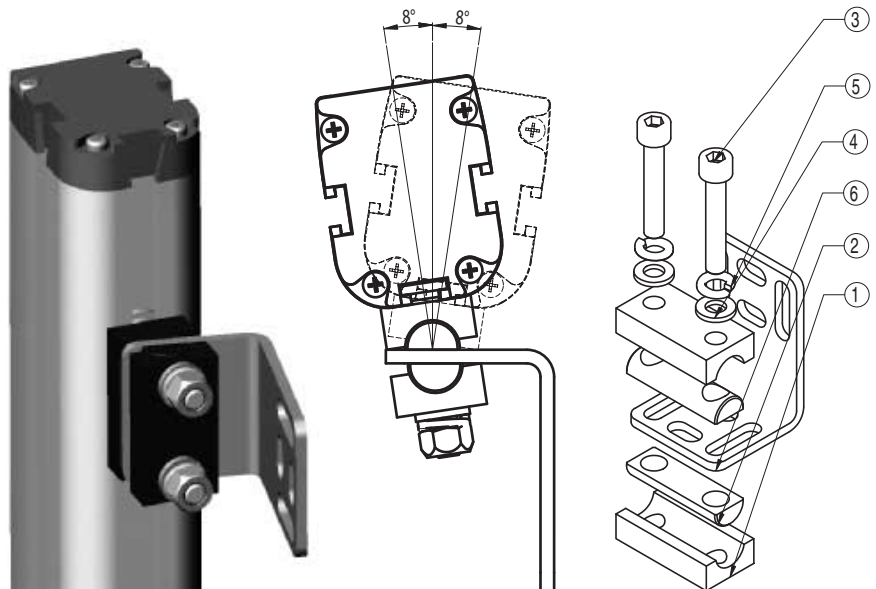

Stands ECO-1

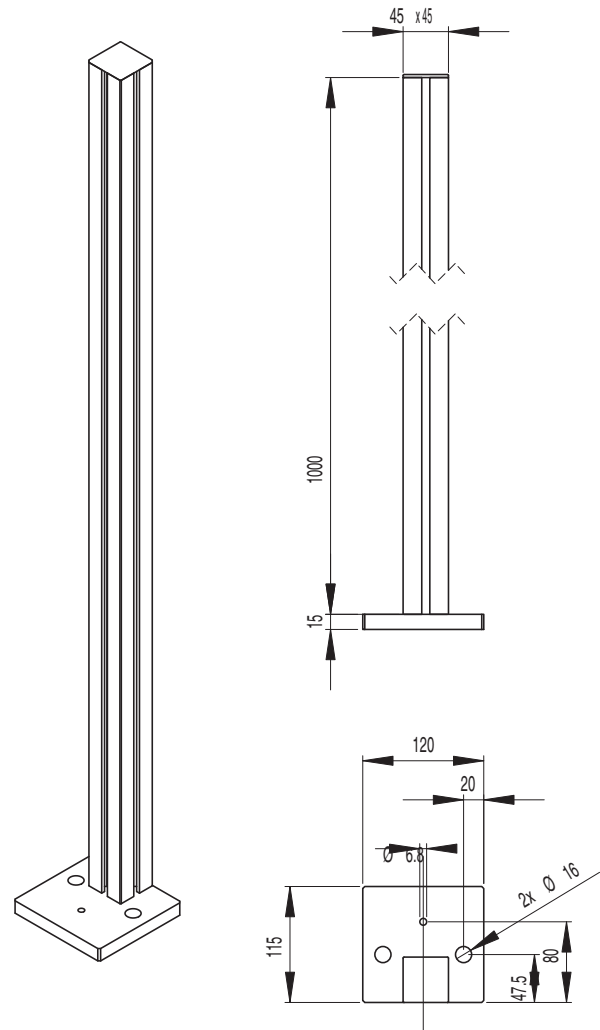

90° bracket ECO-L

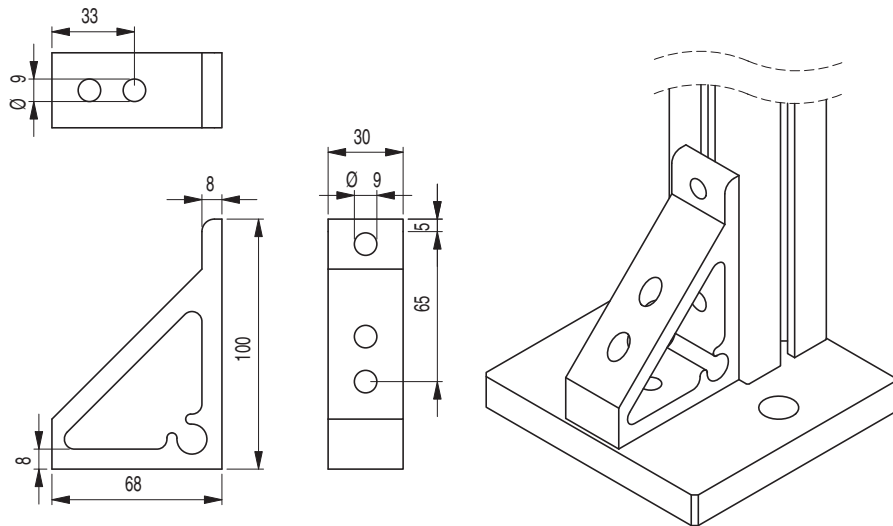

Stands F39-TGR-AS

Model	Height L
F39-TGR-AS-B-1200	1200
F39-TGR-AS-B-1600	1600



Cable cover

F39-TGR-AS-MA-CC16

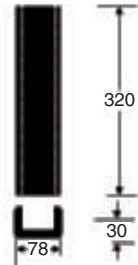

F39-TGR-AS-MA-CC12



Additional mirrors

Single mirror
F39-TGR-AS-AM1



Mirror mounting plate F39-TGR-AS-MM1
(shown with three single mirrors)



Radial arm

Radial arm L-Muting
F39-TGR-AS-MA-MBL

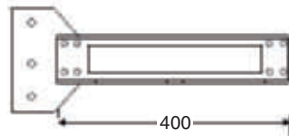

Radial arm X- or T-Muting
F39-TGR-AS-MA-MBXT

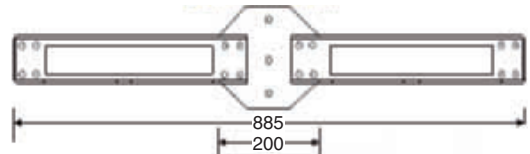

Mounting brackets

F39-TGR-AS-MA-MSM
(for muting sensors)

F39-TGR-AS-MA-MRM
(for reflectors)

E3G-R17-G
E3Z-R81



E39R-1S

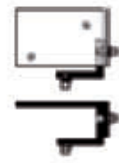

14-14-2 Mirrors

Model	Height L
F39-TGR-MDG-0310	362
F39-TGR-MDG-0460	512
F39-TGR-MDG-0607	658
F39-TGR-MDG-0750	801
F39-TGR-MDG-0907	958
F39-TGR-MDG-1057	1108
F39-TGR-MDG-1207	1258
F39-TGR-MDG-1357	1408
F39-TGR-MDG-1500	1551
F39-TGR-MDG-1657	1708
F39-TGR-MDG-1822	1873

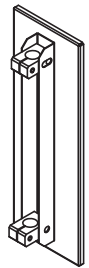
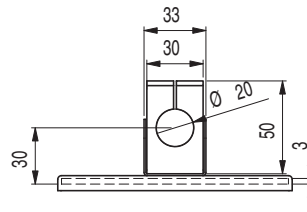
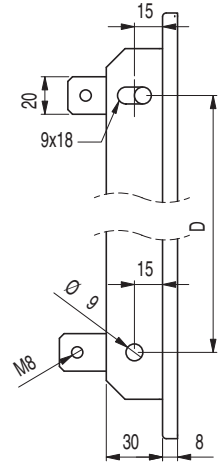
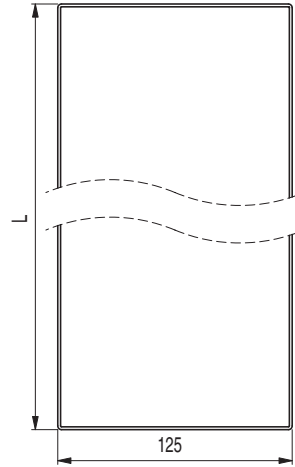

14-14-3 Safety Relay Units

Family	Type Name	Configuration
G9SB	G9SB-200-D	DPST-NO
	G9SB-301-D	3PST-NO
G9SA	G9SA-301	3PST-NO
	G9SA-501	5PST-NO
	G9SA-321-T075	3PST-NO, Time del. 7.5 s
	G9SA-321-T15	3PST-NO, Time del. 15 s
	G9SA-321-T30	3PST-NO, Time del. 30 s
G9SX	G9SX-BC202-RT	2 Safe Outputs
	G9SX-BC202-RC	2 Safe Outputs
	G9SX-AD322-T15-RT	3 Safe Outputs, Time del. 15 s
	G9SX-AD322-T15-RC	3 Safe Outputs, Time del. 15 s
	G9SX-AD322-T150-RT	3 Safe Outputs, Time del. 150 s
	G9SX-AD322-T150-RC	3 Safe Outputs, Time del. 150 s
	G9SX-ADA222-T15-RT	2 Safe Outputs, Time del. 15 s
	G9SX-ADA222-T15-RC	2 Safe Outputs, Time del. 15 s
	G9SX-ADA222-T150-RT	2 Safe Outputs, Time del. 150 s
	G9SX-ADA222-T150-RC	2 Safe Outputs, Time del. 150 s
DeviceNet-Safety	NE1A-SCPU01	16 In, 8 Out, Safety Master
	NE1A-SCPU02	40 In, 8 Out, Safety Master
Safety Controller	G9SP-N10S	10 In, 4 Out
	G9SP-N10D	10 In, 16 Out
	G9SP-N20S	20 In, 8 Out
Relay interface	F39-TGR-SB-R	Relay interface for Semiconductor OSSDs

14-14-4 Muting Accessories

Muting actuators
F39-TGR-MCL

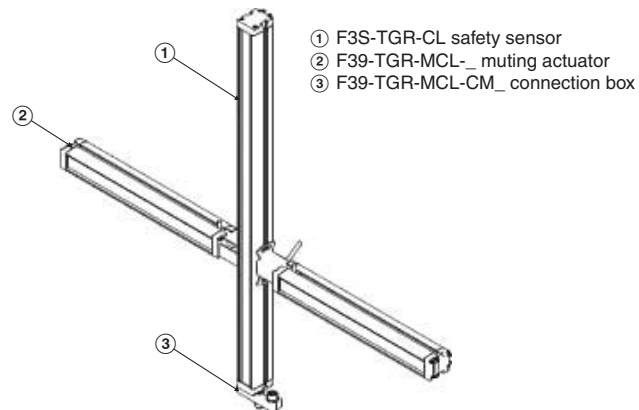

Mounting bracket
F39-TGR-MCL-ST
(included in shipment)

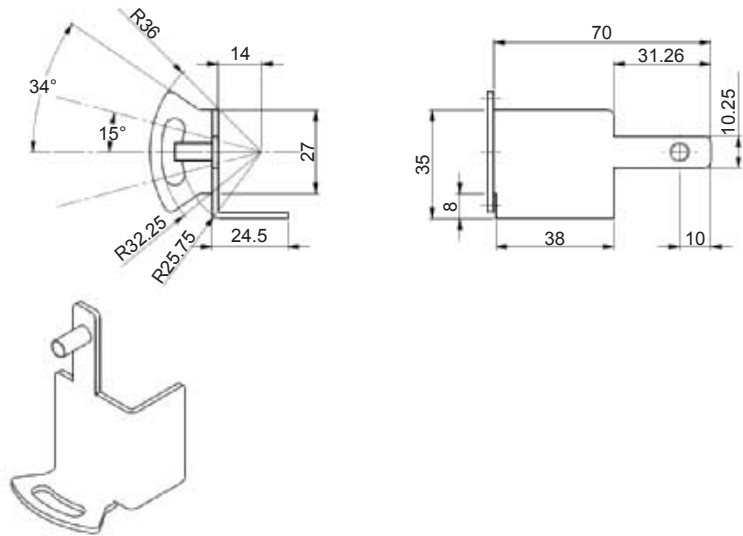

Active/passive-system
F39-TGR-MCL-R

Active part F39-TGR-MCL-R-A

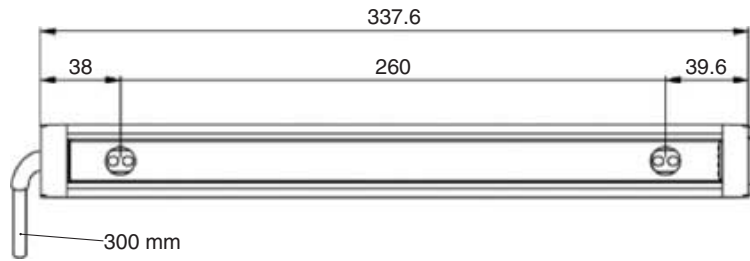

Passive part F39-TGR-MCL-R-P



Active/active-system
F39-TGR-MCL

Transmitter and receiver part

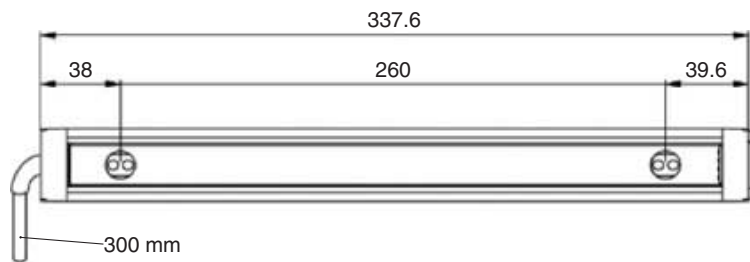

Connection box

Connection box for Transmitter F39-TGR-MCL-CML

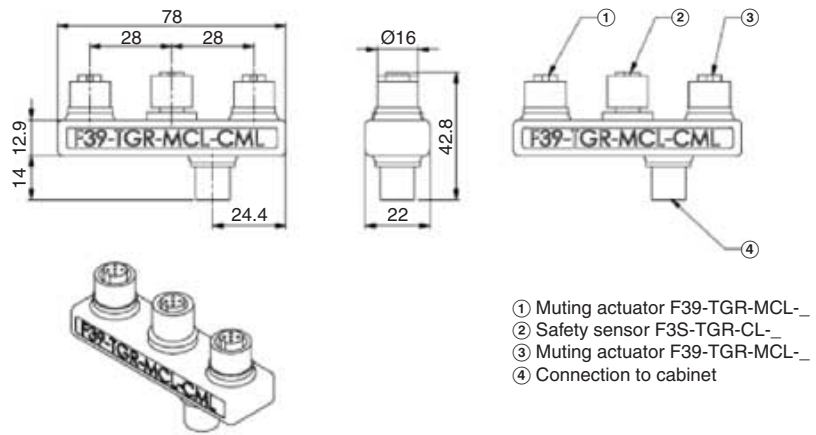

Connection box for Receiver and Transceiver F39-TGR-MCL-CMD

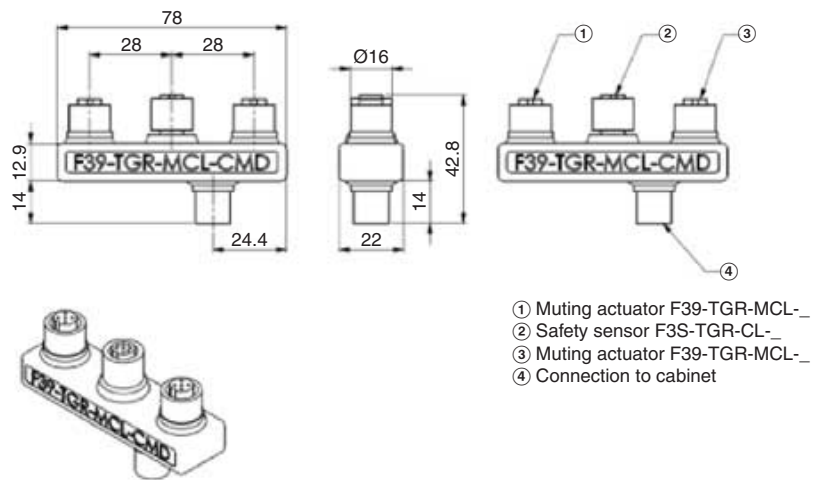

Laser alignment kit
 F39-LLK2-CL

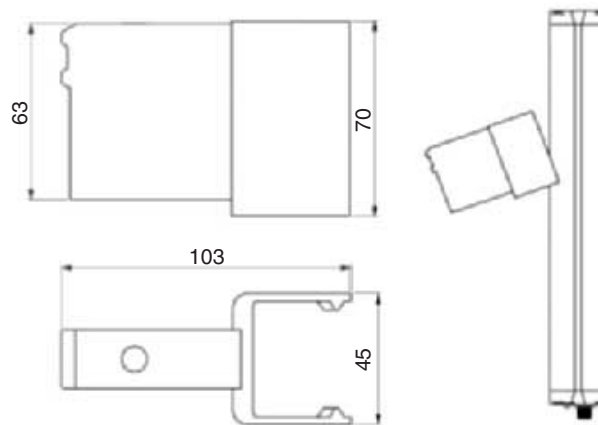

Note Special description just for the bracket without Laser: F39-TGR-CL-LLK-BR

Connection and Control boxes

Interface
F39-TGR-CL-CMB1

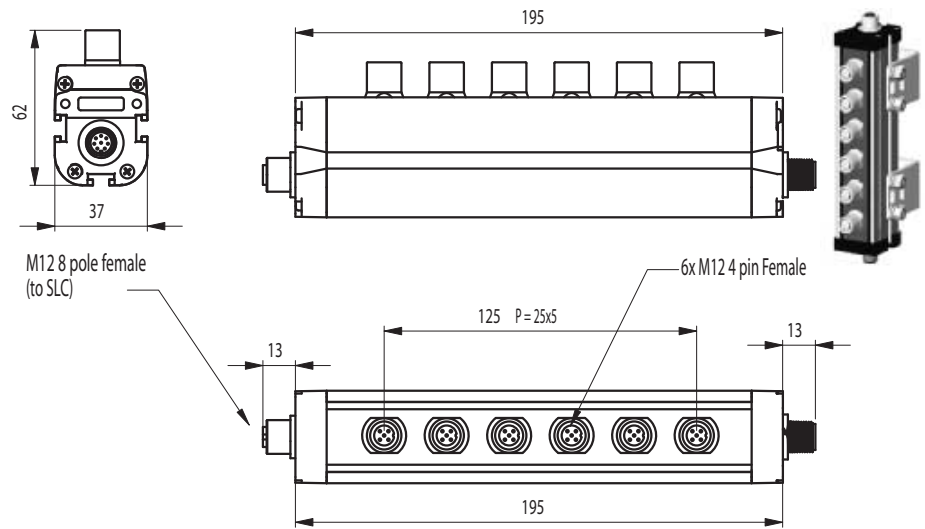

Interface
F39-TGR-CL-CMB2
(with 900 mm cable)

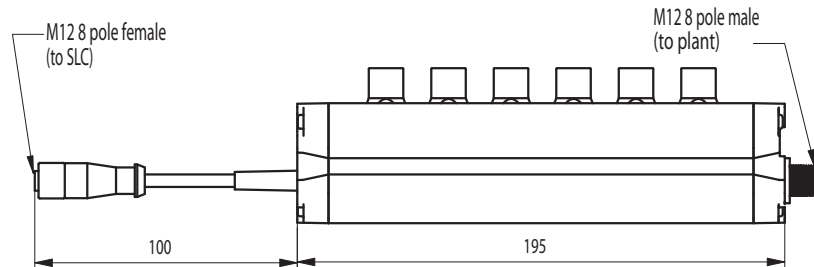

Please refer to *Cables* on page 77 for the system connection cables.

Control boxes

Model Name	Features
F39-TGR-CL-W-IBOX1	Connection box with Test- and Restart-Button
F39-TGR-CL-W-IBOX2	Connection box with Test- and Restart-Button and muting indicator
F39-TGR-CL-W-IBOX3	Connection box with Test- and Restart-Button and muting lamp
F39-TGR-CL-W-IBOX4	Connection box with Test- and Restart-Button, OSSD indicator and muting lamp Separate M12 connectors for each muting sensor

Note Do not use the F39-TGR-CL-W-IBOX_ with other safety sensor than F3S-TGR-CL series. Failure to do so may cause damage of the safety sensor or the connection box.

F39-TGR-CL-W-IBOX-1

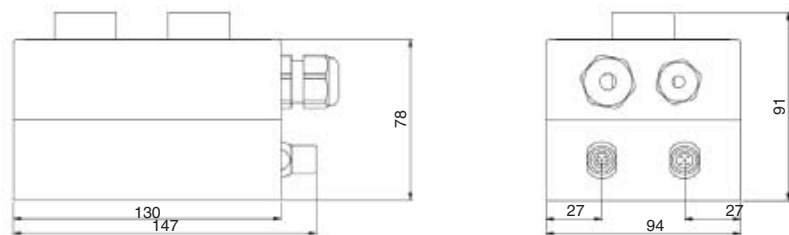

F39-TGR-CL-W-IBOX-2

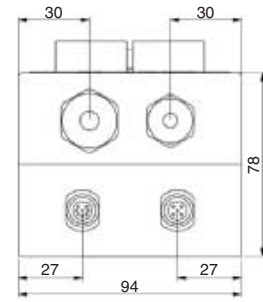
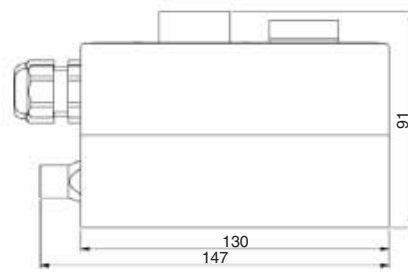

F39-TGR-CL-W-IBOX-3

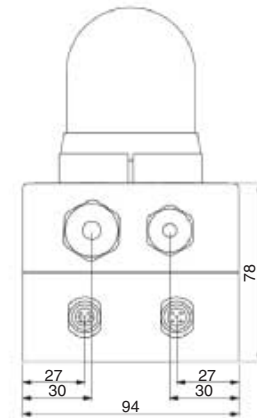
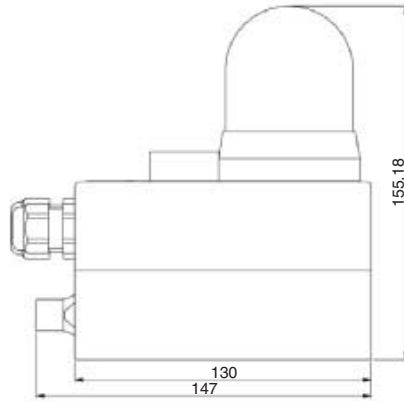

F39-TGR-CL-W-IBOX-4

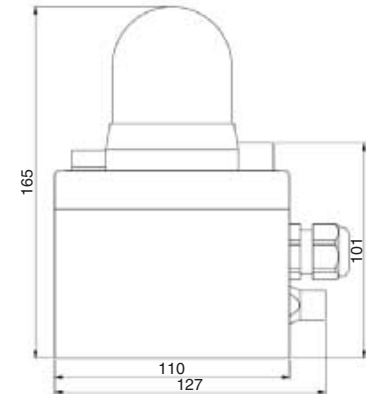
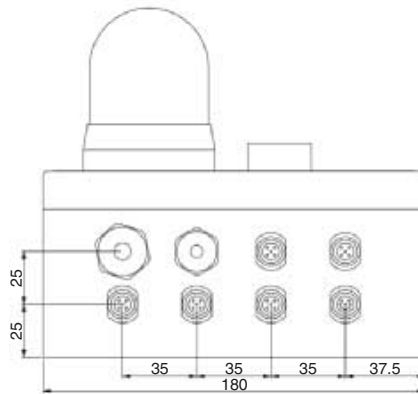

14-14-5 Cables

Standard cables

Receiver Cables (M12-8pin, shielded, flying leads)		
Y92E-M12PURSH8S2M-L	F39-TGR-CVL-B-2-R	Receiver Cable, 2 m length
Y92E-M12PURSH8S5M-L	F39-TGR-CVL-B-5-R	Receiver Cable, 5 m length
Y92E-M12PURSH8S10M-L	F39-TGR-CVL-B-10-R	Receiver Cable, 10 m length
Y92E-M12PURSH8S25M-L	F39-TGR-CVL-B-25-R	Receiver Cable, 25 m length

Transmitter Cables (M12-4pin, shielded, flying leads)		
Y92E-M12PURSH4S2M-L	F39-TGR-CVL-B-2-T	Transmitter Cable, 2 m length
Y92E-M12PURSH4S5M-L	F39-TGR-CVL-B-5-T	Transmitter Cable, 5 m length
Y92E-M12PURSH4S10M-L	F39-TGR-CVL-B-10-T	Transmitter Cable, 10 m length
Y92E-M12PURSH4S25M-L	F39-TGR-CVL-B-25-T	Transmitter Cable, 25 m length

Connector cables F3S-TGR-CL → F39-TGR-CL-W-IBOX

Receiver Cables (M12-8pin, male/female connector)		
Y92E-M12FSM12MSPURSH82M-L	F39-TGR-CVL-B-2-RR	Receiver Cable, 2 m length
Y92E-M12FSM12MSPURSH85M-L	F39-TGR-CVL-B-5-RR	Receiver Cable, 5 m length
Y92E-M12FSM12MSPURSH810M-L	F39-TGR-CVL-B-10-RR	Receiver Cable, 10 m length

Transmitter Cables (M12-4pin, male/female connector)		
Y92E-M12FSM12MSPURSH42M-L	F39-TGR-CVL-B-2-EE	Transmitter Cable, 2m length
Y92E-M12FSM12MSPURSH45M-L	F39-TGR-CVL-B-5-EE	Transmitter Cable, 5m length
Y92E-M12FSM12MSPURSH410M-L	F39-TGR-CVL-B-10-EE	Transmitter Cable, 10m length

Connector cables Muting sensors → F39-TGR-SB-CMB, F39-TGR-CL-W-IBOX

Interconnect Cables (M12-4pin, male/female connector)		
Y92E-M12FSM12MSPURSH42M-L	F39-TGR-CVL-B-2-EE	Connector cable, 2 m length
Y92E-M12FSM12MSPURSH45M-L	F39-TGR-CVL-B-5-EE	Connector cable, 5 m length
Y92E-M12FSM12MSPURSH410M-L	F39-TGR-CVL-B-10-EE	Connector cable, 10 m length

Wiring accessories (connectors and Y-connector cables)

Type	
F39-TGR-CT-B-R	Connector M12, 8-pin, female for wiring
F39-TGR-CT-B-E	Connector M12, 4-pin, female for wiring
F39-TGR-CT-W-R	Connector M12, 8-pin, male for wiring
F39-TGR-CT-W-E	Connector M12, 4-pin, male for wiring
F39-TGR-CVL-D-B-5-R	Cable for Sensor system and muting lamp connection "Y" configuration. Receiver cable 5 m length and 2 m to muting lamp

SECTION 15

Glossary







Automatic Start	Upon completion of power-up, the ESPE will enter the MACHINE RUN state as soon as the detection zone is clear of opaque objects of the specified size.
Detection Zone	The IR light sensing area of the ESPE. When a specified test piece enters this area then the ESPE must detect its presence and set its safety outputs to the OFF-state.
Electro-Sensitive Protective Equipment (ESPE)	An assembly of devices and/or components working together for protective tripping or presence sensing purposes and comprising as a minimum: <ul style="list-style-type: none"> • a sensing device • controlling/monitoring devices • output signal switching devices
LOCKOUT condition	When the ESPE detects a fault, it transitions to this state. The OSSD will be held to the OFF-state and the ESPE will not attempt to leave this state without performing a comprehensive power up self-test. A power-up self test will be initiated by either cycling the ESPE power or by a Start signal transition.
MACHINE RUN	When the ESPE is in this state, the two OSSD are both active. In this state the Green GUARD LED is on, the red BREAK LED is off and the Yellow INTERLOCK LED is off.
MACHINE STOP	When the ESPE is in this state, the two OSSD are both inactive. In this state the Green GUARD LED is off, the Red BREAK LED is on.
OFF-STATE	The state in which the output circuit is interrupted and does not permit the flow of current.
ON-STATE	The state in which the output circuit is completed and permits the flow of current.
Output Signal Switching Device (OSSD)	The safety output of the ESPE that is used to enable and disable the guarded machine.
Response Time	The maximum amount of time required for the ESPE to set its OSSD outputs to the OFF-state once the detection zone is blocked by an opaque object of the specified size.
Start/Restart INTER-LOCK	The ESPE will go into the INTERLOCK state upon completion of power-up and during zone violations which causes a transition to the BREAK state. A Start signal transition must occur before returning to MACHINE RUN following any transition to MACHINE STOP.

SECTION 16

Diagnostics and Troubleshooting

16-1 Receiver Diagnostic information

16-1-1 Normal operation

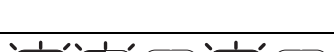







Disposition of indicator	Name of indicator	Colour
	POWER	Green
	STATUS	Yellow
	GUARD	Green
	BREAK	Red
	INTERLOCK	Yellow
	Description	
	MACHINE RUN state, OSSDs on	
	MACHINE STOP state, OSSDs off	
	Interlock, waiting for restart	
	Alignment mode - best optical alignment	
	Short circuit on output	
	Special function active/special function status, please refer to the chapters "Setting F3S-TGR-CL features" on page 14 and "Control functions" on page 34 for details	
	Floating blanking active, additional object in the protective field Note: only on Advanced (A) version	

16-1-2 Interlock LED indication

If a special function like pre-reset or single/double break is active, the Interlock LED uses blink codes to display the status.

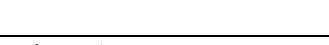

- 1 flash per second: Pre-reset mode active
- 2 flashes per second: Waiting for Restart on single/double break function
- 3 flashes per second: Normal operation of single/double break function

16-1-3 LED error indication

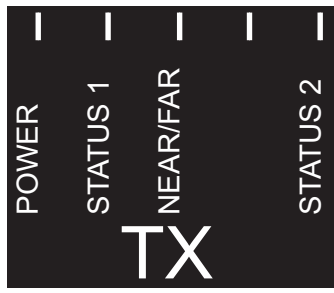

Disposition of indicator	Name of indicator	Colour
	POWER	Green
	STATUS	Yellow
	GUARD	Green
	BREAK	Red
	INTERLOCK	Yellow
	Description of Error	Corrective action needed
	Low supply voltage	Check if power-supply is within the specification (24 VDC±20%)
	Control logic fault	Remove and reapply power. If the error is still present please check the DIP switch settings, otherwise please contact your local Omron distributor
	Error in Safety Outputs	Check the wiring of the OSSD outputs.
	Muting lamp connection fault of muting lamp defective	Check the connection of the muting lamp and/or check the condition of the muting lamp
	Mutual light interference	Check the presence of ambient light sources close to the protection field. Use coding option or remove the light source.
	Error in floating blanking mode. Object outside the blanking area or missing fixed blanking object	Check the position of the blanking object. Make sure it is inside the blanking area.
	EDM fault	Check and correct EDM wiring.
	Error in pre-reset function	Pre-reset condition was not met. Correct placement of the pre-reset switch to keep timing within the specification.

16-2 Transmitter Diagnostic information

16-2-1 Normal operation

Disposition of indicator	Name of indicator	Colour
	POWER	Green
	STATUS 1	Yellow
	NEAR/FAR	Green
	Not used	-
	STATUS 2	Yellow
	Description	
	Normal operation, long range selected	
	Normal operation, short range selected	

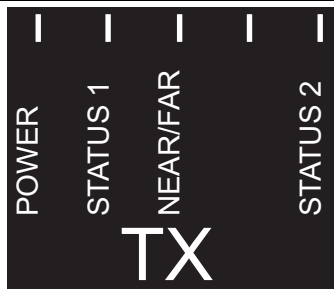
16-2-2 LED error indication

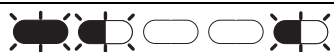
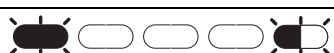
Disposition of indicator	Name of indicator	Colour
	POWER	Green
	STATUS 1	Yellow
	NEAR/FAR	Green
	Not used	-
	STATUS 2	Yellow
	Description of Error	
	Low supply voltage	Check if power-supply is within the specification (24 VDC±20%)
	Control logic fault	Remove and reapply power. If the error is still present, contact your local Omron distributor
	Error on range selection	Check the setting of the selector switches for the range selection

SECTION 17

Appendix

17-1 Checkout procedure log

The following checkout procedure must be performed by qualified personnel during initial F3S-TGR-CL system installation and at least every three months or more frequently depending on machine usage and company guidelines.

Item	Condition	Comments
Verify that the guarded machine is compatible with the type of machine which may be used with the F3S-TGR-CL system. See the chapter " <i>Safety precautions</i> " on page xi for further information.	<input type="checkbox"/> Pass <input type="checkbox"/> Fail	
Verify that the mounting distance of the F3S-TGR-CL system is equal to or greater than the minimum safe distance from the danger point. See the chapter " <i>Safe Mounting Distances</i> " on page 21 for further information.	<input type="checkbox"/> Pass <input type="checkbox"/> Fail	
Determine that all access to the danger point not protected by the F3S-TGR-CL system is guarded by other means, such as gates, fencing or other approved methods. Verify that all additional guarding devices are installed and operating properly.	<input type="checkbox"/> Pass <input type="checkbox"/> Fail	
Make sure the operator is not able to stand between the F3S-TGR-CL system detection zone and the machine danger point. Verify that the light curtain can only be reset from a position outside and within view of the hazardous machine area.	<input type="checkbox"/> Pass <input type="checkbox"/> Fail	
Inspect the electrical connections between the guarded machine's control system and the F3S-TGR-CL system. Verify that they are properly connected to the machine such that a stop signal from the F3S-TGR-CL system results in an immediate halt of the machine's cycle. See the chapter " <i>Connection to the Machine control circuit</i> " on page 30 for further information.	<input type="checkbox"/> Pass <input type="checkbox"/> Fail	
If the EDM monitoring feature is not used, proceed to the next step. To test the EDM feature, verify that the feature has been enabled. Turn the machine power on. Cycle the machine. Place a temporary jumper wire between the EDM connections. The F3S-TGR-CL should enter an alarm condition. Remove the temporary jumper. Press and release the test button.	<input type="checkbox"/> Pass <input type="checkbox"/> Fail	
Record the test results in the machine log, then perform the test procedure.	<input type="checkbox"/> Pass <input type="checkbox"/> Fail	

Technician's Signature _____

17-2 Test procedure log

The following test procedure must be performed by qualified personnel during initial F3S-TGR-CL system installation, according to the employer's regular inspection program and after any maintenance, adjustment or modification to the F3S-TGR-CL system or the guarded machine. Testing ensures that the light curtain, safety system, and machine control system work together to properly stop the machine. Failure to test properly could result in serious injury to personnel. To test the F3S-TGR-CL system, use the correct size test object.

Item	Condition	Comments
Disable the guarded machine. Apply power to the F3S-TGR-CL system.	<input type="checkbox"/> Pass <input type="checkbox"/> Fail	
Visually inspect the machine to ensure that access to the danger point is only through the F3S-TGR-CL detection zone. If not, additional guarding, including mechanical barriers may be required. Verify that all additional guarding devices and barriers are installed and operating properly.	<input type="checkbox"/> Pass <input type="checkbox"/> Fail	
Verify that the mounting distance of the F3S-TGR-CL system is equal to or greater than the calculated minimum safety distance from the danger point. See the chapter "Safe Mounting Distances" on page 21 for further information. Ensure that the operator is not able to stand between the F3S-TGR-CL detection zone and the danger point.	<input type="checkbox"/> Pass <input type="checkbox"/> Fail	
Check for signs of external damage to the F3S-TGR-CL system, the machine and the electrical cables and wiring. If damage is found, lock the machine off and report to the supervisor.	<input type="checkbox"/> Pass <input type="checkbox"/> Fail	
Interrupt the F3S-TGR-CL system detection zone with the proper size test object. Move the test object inside the perimeter (along the top, sides and bottom) of the detection zone and up and down through the centre. If in automatic start mode, verify that the red BREAK led is lit. If in manual mode, verify that the red break and yellow INTERLOCK lights are on. Press and release restart button before proceeding to next step.	<input type="checkbox"/> Pass <input type="checkbox"/> Fail	
Start the machine. While the machine is in motion, interrupt the detection zone with the test object. The machine should stop immediately. Never insert the test object into the dangerous parts of the machine. With the machine at rest, interrupt the detection zone with the test object. Verify that the machine will not start with the test object in the detection zone.	<input type="checkbox"/> Pass <input type="checkbox"/> Fail	
Verify that the braking system is working properly. If the machine does not stop fast enough, adjust the braking system or increase the distance from the detection zone to the danger point.	<input type="checkbox"/> Pass <input type="checkbox"/> Fail	
If the safety devices or the machine fails any of these tests, do not run the machine. Immediately tag or LOCKOUT the machine to prevent its use and notify the supervisor.	<input type="checkbox"/> Pass <input type="checkbox"/> Fail	

Technician's Signature _____

17-3 Wiring examples

17-3-1 F3S-TGR-CL and GSB-301-D in manual reset

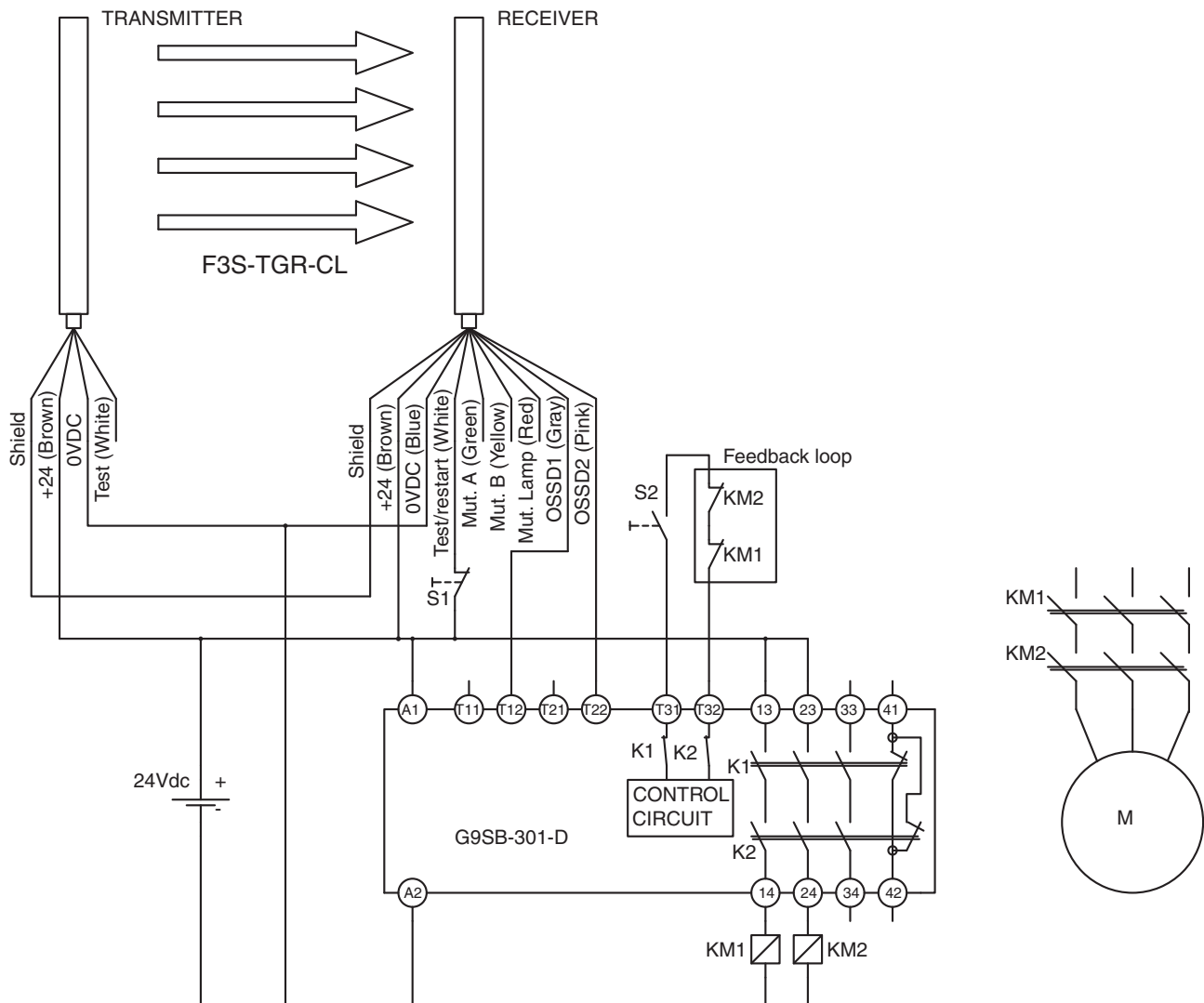

Note The achievable safety category or performance level using this circuit depends on the safety light curtain in use and the correct wiring of the safety control unit.

Note This circuit can achieve a PL=e acc. ISO 13849-1 if a F3S-TGR-CL-4_ is used.

17-3-2 F3S-TGR-CL and G9SB-301-D in manual reset and Muting connection

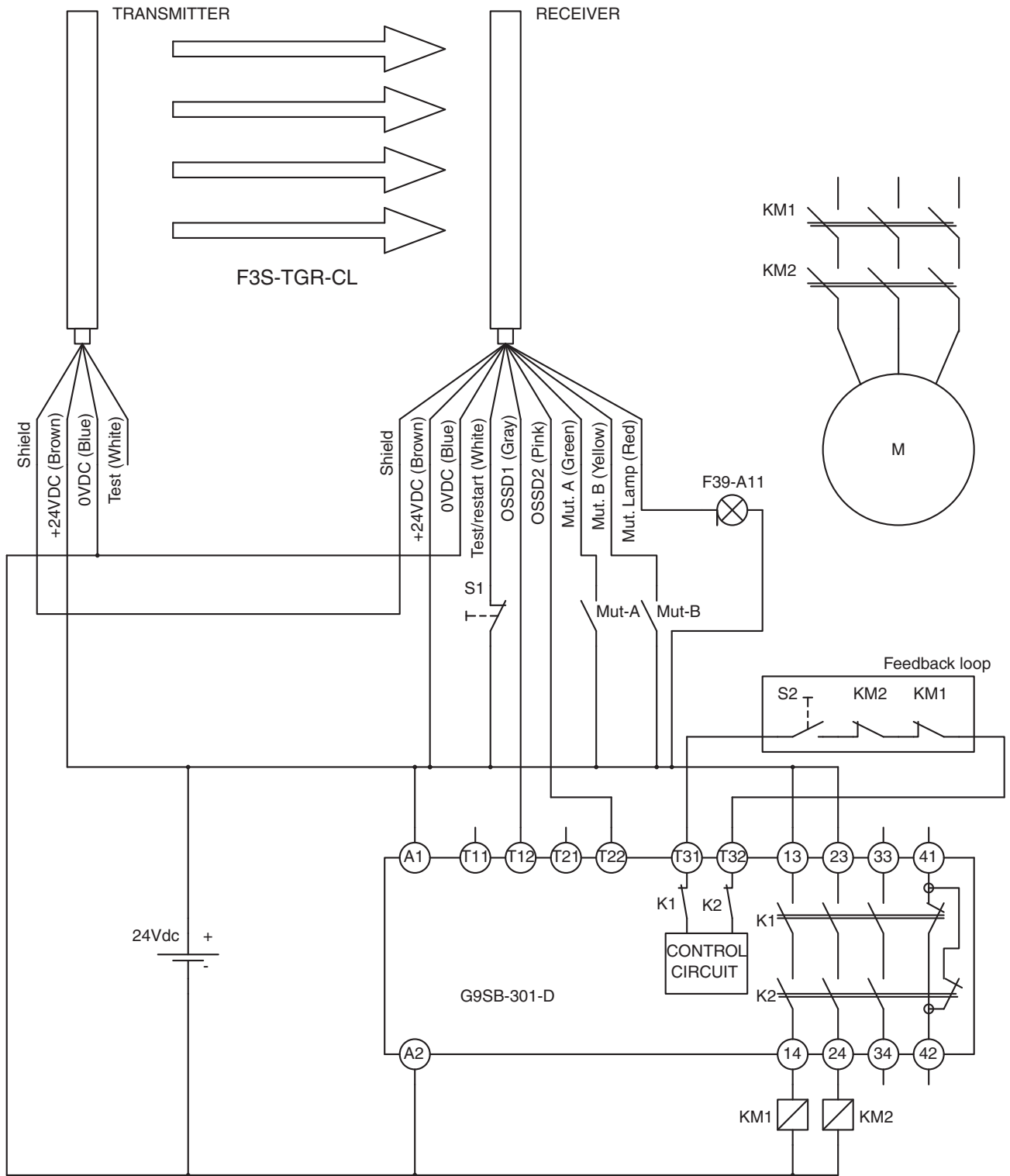

Note The achievable safety category or performance level using this circuit depends on the safety light curtain in use and the correct wiring of the safety control unit.

Note This circuit can achieve a PL=e acc. ISO 13849-1 if a F3S-TGR-CL-4_ is used.

17-3-3 F3S-TGR-CL in combination with DST1-ID12SL1

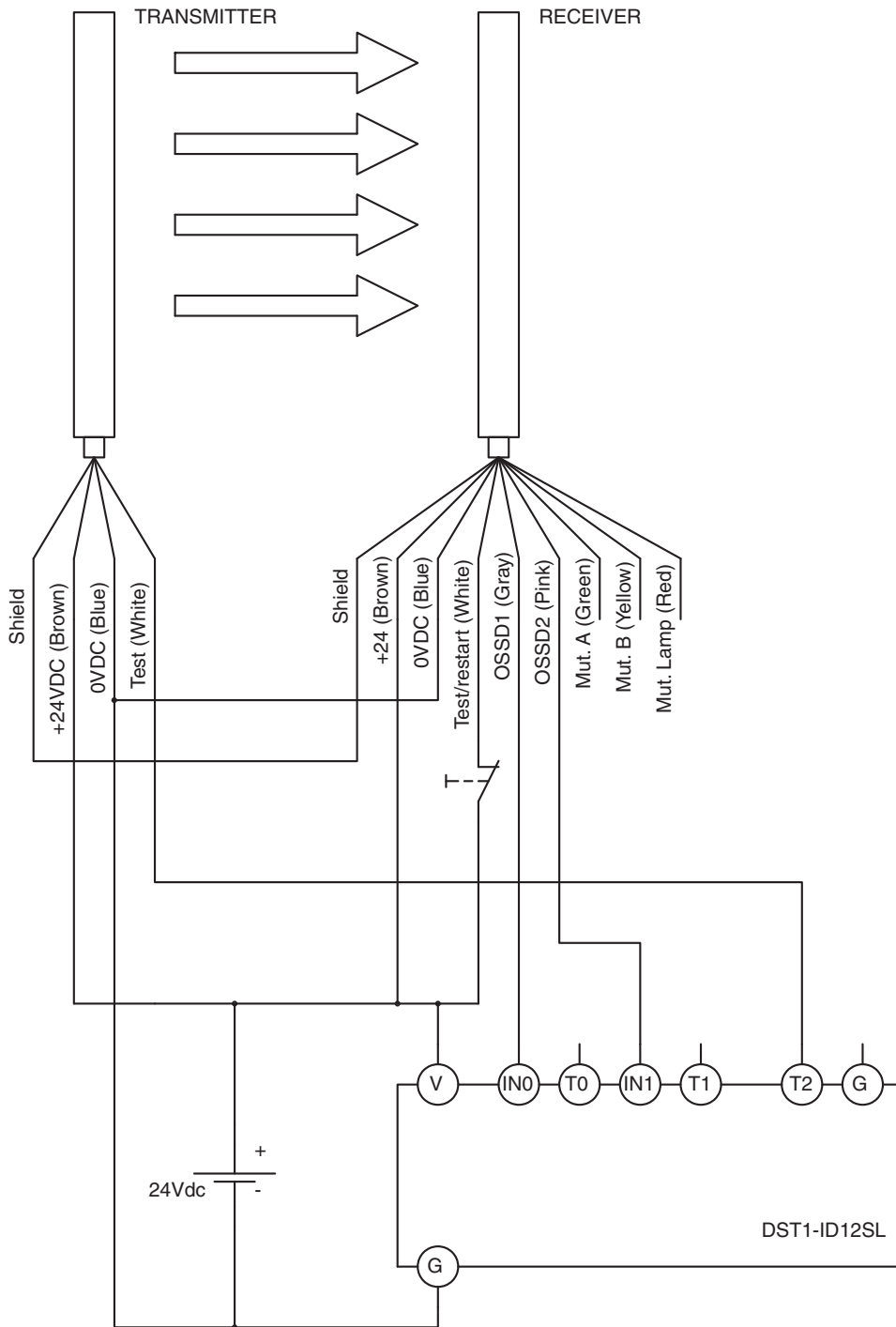

Note The achievable safety category or performance level using this circuit depends on the safety light curtain in use and the correct wiring of the safety control unit.

Note This circuit can achieve a PL=e acc. ISO 13849-1 if a F3S-TGR-CL-4_ is used.

17-3-4 F3S-TGR-CL with DST1-MD16-SL1

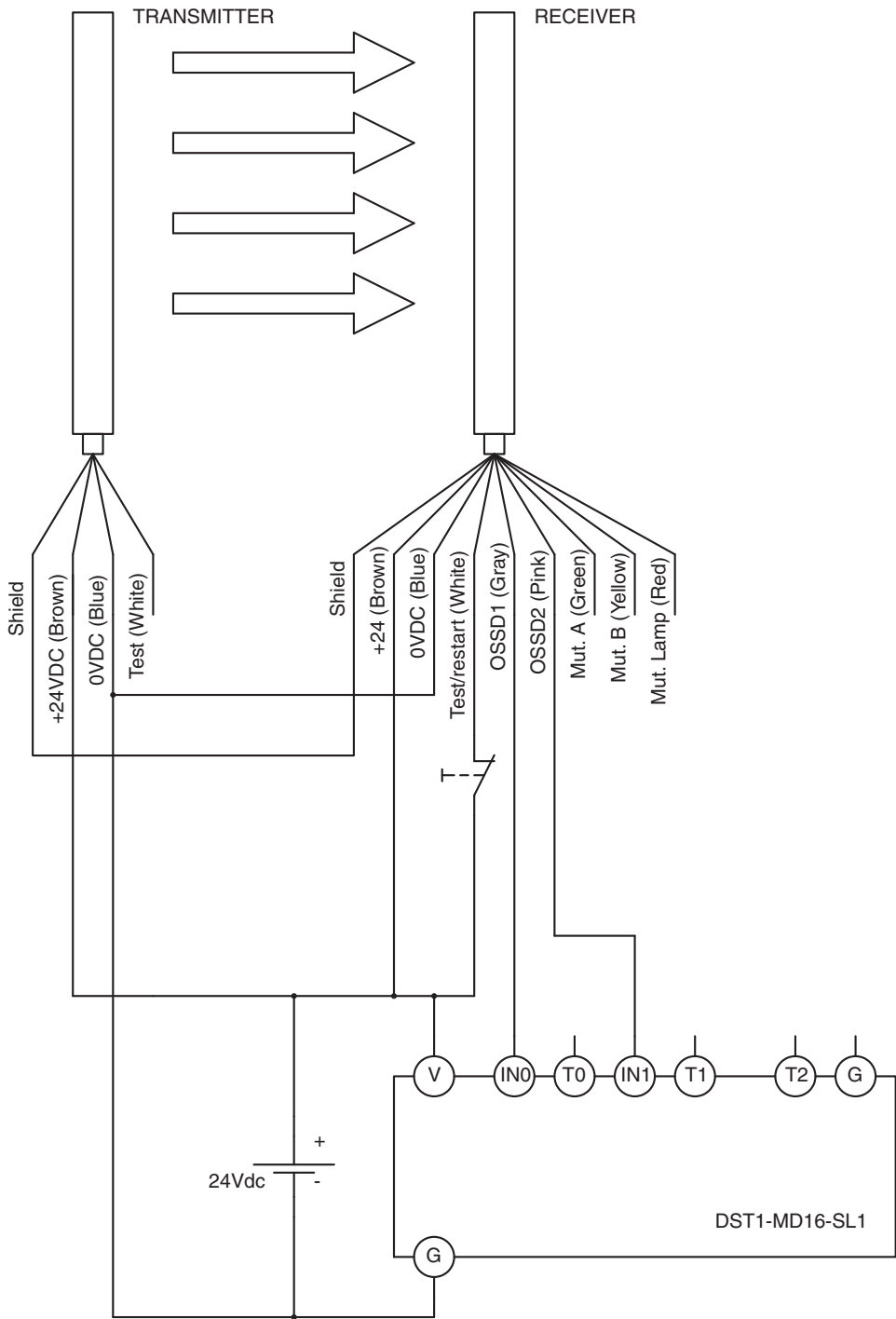

Note The achievable safety category or performance level using this circuit depends on the safety light curtain in use and the correct wiring of the safety control unit.

Note This circuit can achieve a PL=e acc. ISO 13849-1 if a F3S-TGR-CL-4_ is used.

17-3-5 F3S-TGR-CL and G7SA-3A1B and EDM function

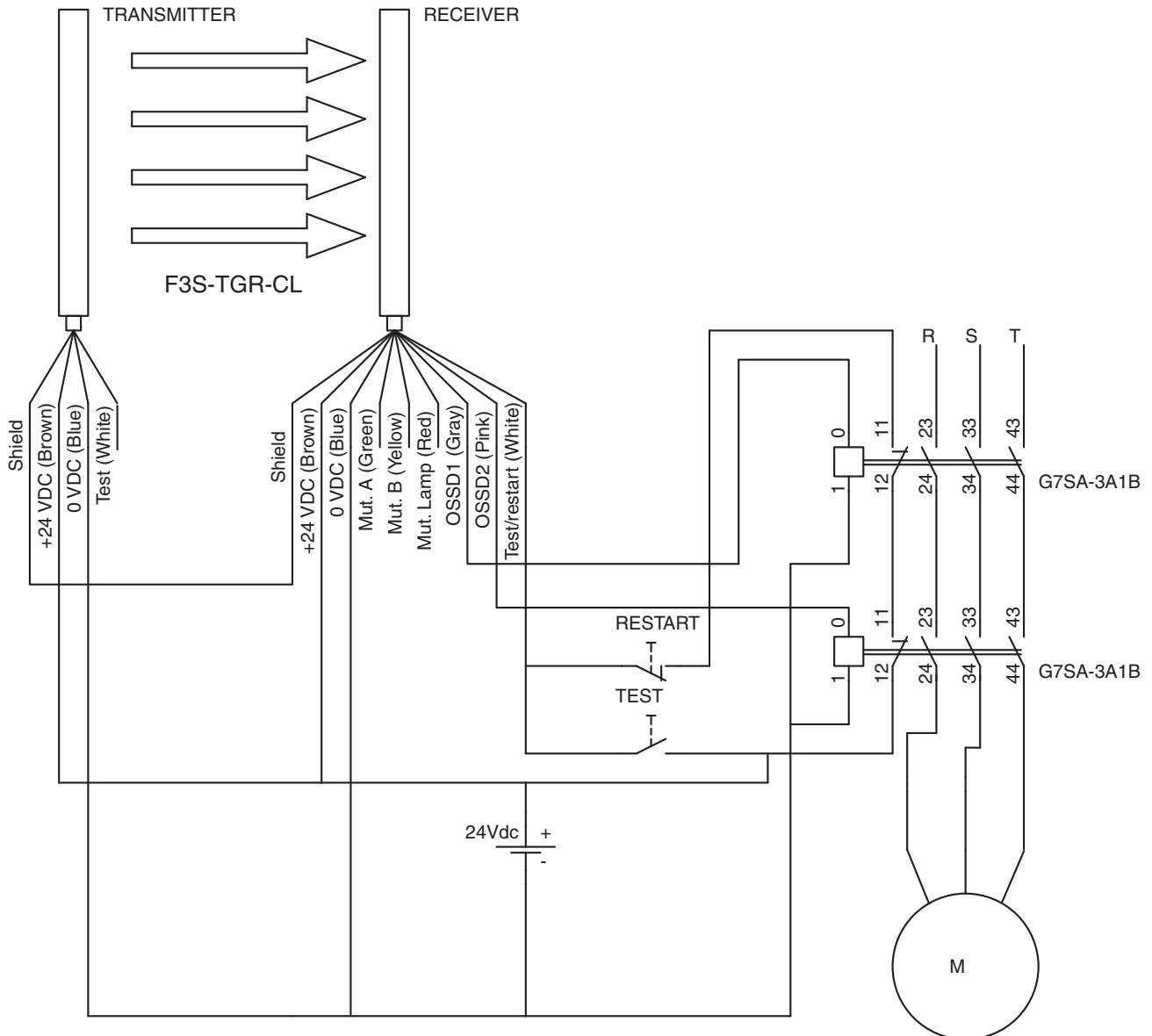

Note The achievable safety category or performance level using this circuit depends on the safety light curtain in use and the correct wiring of the safety control unit.

Note This circuit can achieve a PL=e acc. ISO 13849-1 if a F3S-TGR-CL-4_ is used.

Revision history

A manual revision code appears as a suffix to the catalog number on the front cover of the manual.

Cat. No. F05E-EN-03

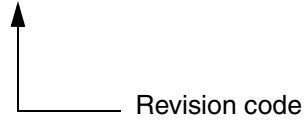

The following table outlines the changes made to the manual during each revision. Page numbers refer to the previous version.

Revision code	Date	Revised content
01	January 2009	Original production
02	June 2009	Revision
03	August 2011	Revision and Firmware 1.3.6 added

EC DECLARATION OF CONFORMITY

We hereby declare that the following product is in conformity with requirements of the following EC Directives:

Product: SAFETY LIGHT CURTAIN
Types: F3S-TGR-CL (refer to appending list of models)

Title and No. of Directive: EMC Directive: 2004/108/EC
 Machinery Directive: 2006/42/EC

YEAR CE MARK AFFIXED: 2009

These products are designed and manufactured in accordance with the following standards:

Safety of machinery:	Electro sensitive protective equipment Active opto-electronic protective devices Safety related part of control systems	EN 61496-1/A1:2008 IEC 61496-2:2006 EN ISO 13849-1:2008 PL e, Cat 4
Functional safety:	of electrical/electronic/programmable electronic safety related control system	IEC 61508 part 1 to 4:2001 SIL 3
Electrical safety:	Electronic equipment used in power installation	EN 50178:1997
Electromagnetic immunity:	Electro sensitive protective equipment	EN 61496-1/A1:2008
Electromagnetic Emission:	Industrial, scientific and medical equipment	EN 55011:2007

Description of Product:

The F3S-TGR-CL series are electro-sensitive protective equipment designed specifically to detect persons in order to ensure their safety.

F3S-TGR-CL4_ models are ESPE type 4 according to EN61946-1/A1:2008 and AOPD Type 4 according to IEC61496-2:2006 and can be used as a safeguard for personnel protection at machinery and other hazardous areas, which require safeguards according to Cat 4 and "PL e" according to EN ISO13849-1:2008.

F3S-TGR-CL2_ models are ESPE type 2 according to EN61946-1/A1:2008 and AOPD Type 2 according to IEC61496-2:2006 and can be used as a safeguard for personnel protection at machinery and other hazardous areas, which require safeguards according to Cat 2 and "PL c" according to EN ISO13849-1:2008.

Product covered:

Model name F3S-TGR-CL covers a family of products. Refer to the technical report for available models.

Certificate:

Machinery Directive Certificate for EC Type examination
 Notified body: TÜV SÜD rail GmbH, Notified body EC Commission no. 0123
 Address: Ridlerstr. 57, 80339 München, Germany

Responsible person for documentation:

Hugo Sintnicolaas Omron Europe B.V.
 Zilverenberg 2, 5234 GM, 's-Hertogenbosch, The Netherlands

Manufacturer

Omron Electronics
 Manufacturing of Germany GmbH
 Carl-Benz-Strasse 4
 71154 Nufringen
 Germany

Name and address of the representative in the EU

Omron Europe B.V.
 Wegalaan 67-69
 2132 JD Hoofddorp
 The Netherlands

Date: 25/08/2011



Hugo Sintnicolaas, European Manufacturing Manager

F3S-TGR-CL Series list of models

Amendment-B: as of August 25th, 2011

Product	Type
F3S-TGR-CL4x-014-xxx	014mm (finger) protection Safety Light curtain, Type 4
F3S-TGR-CL4x-035-xxx	035mm (hand) protection Safety Light curtain, Type 4
F3S-TGR-CL4x-070-xxx	070mm (body) protection Safety light curtain, Type 4
F3S-TGR-CL4x-Kxx-xxx	Body protection Safety light curtain emitter-receiver set-up, Type 4
F3S-TGR-CL4x-KxC-xxx	Body protection Safety light curtain emitter-receiver on same housing plus passive part, Type 4
F3S-TGR-CL2x-014-xxx	014mm (finger) protection Safety Light curtain , Type 2
F3S-TGR-CL2x-035-xxx	035mm (hand) protection Safety Light curtain, Type 2
F3S-TGR-CL2x-070-xxx	070 mm (body) protection Safety Light curtain, Type 2
F3S-TGR-CL2x-Kxx-xxx	Body protection Safety light curtain emitter-receiver set-up, Type 2
F3S-TGR-CL2x-KxC-xxx	Body protection Safety light curtain emitter-receiver on same housing plus passive part, Type 2

This product was tested ok according to the
factory test specifications of Omron Europe B.V

OMRON

Authorized Distributor: