



The miniTwin Safety Light Curtain

Minivation:
the smallest Light Curtain from SICK.

Minivation – 120 mm, all inclusive: integrated intelligence, minimised format.

Minivation is an innovation in miniature housings: for the first time, sender and receiver elements have been integrated in an extremely compact housing – in the miniTwin light curtain. Miniaturisation optimises machine integration, permits cost-cutting standardisation and simplifies handling.

Limited space in the machinery?

miniTwin is the perfect answer to current requirements in machine construction. The trend is towards increasingly compact machines in electronic production and in the automation of handling and assembly. In addition to protecting service and access openings on fully automated CNC-controlled machines, miniTwin also fully exploits its size advantage in semi-automated workplaces.

Safety for many industries

The miniTwin light curtain provides innovative safety solutions for flexible serial production of small batch sizes and for low-level serial production. Many industrial sectors can profit from this:

- suppliers to the automotive and aerospace industries
- the electronics industry
- the pharmaceutical industry
- food and beverages production
- the packaging machine industry





Miniaturisation creates space

- Very compact housing
- No blind zones
- Flexible machine integration
- More ergonomic work processes

Standardisation reduces costs

- MiniTwin is both sender and receiver unit
- MiniTwin offers both stand-alone and cascade use
- Device connection with 5-pin M12 standard cable with full functional scope

Simplest handling for maximum availability

- Simplified installation through application-specific bracket
- LED-guided start-up
- Rapid alignment through coloured LEDs
- Rapid, easy wiring
- Intelligent configuration without software

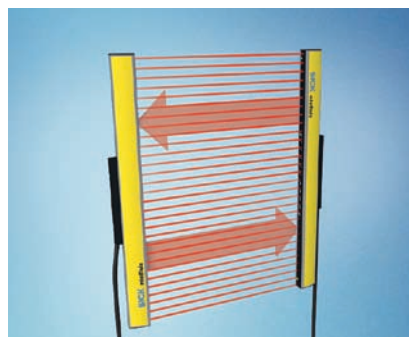
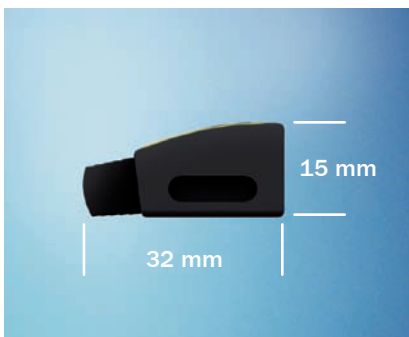

There is space in even the smallest of gaps: space for innovation through maximum miniaturisation.

miniTwin's miniaturisation opens up new solutions for space-saving machine integration because savings in mounting space and the size of production areas are becoming increasingly important. And the optimisation of work processes thanks to ergonomic workplace design offers even more potentials.

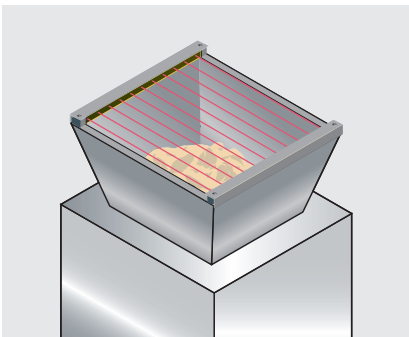

Small housing for optimum machine design

miniTwin enables safety concepts that permit compact machine design. Optimum machine integration reduces safety distances and minimises the size of production areas.

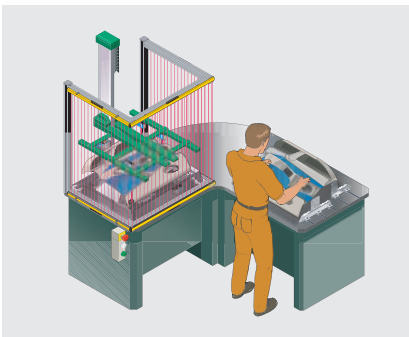

Productivity increases through optimised work processes

The miniTwin safety light curtain is suitable for every mounting type and any machine design. Cycle and equipping times can be optimised without interfering with the operator's work process. The short response time and high resolution permit short safety distances between the light curtain and the hazardous movement. Free access and minimised safety distances accelerate processes and increase the availability of production equipment.



Small housing for great safety

The extremely compact housing of the miniTwin has permitted the creation of a safety light curtain that has no blind zones at either end of the housing. This means that a consistent high-resolution protective field stretches to the edges and, with cascading, the protective field extends beyond the corners.

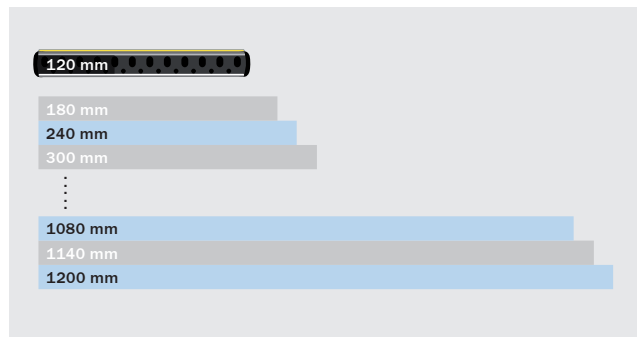

Graduated lengths in 60 mm increments

Scalable protective field heights and three resolutions

The shortest miniTwin stick measures just 120 mm, the protective field height of each individual miniTwin stick is scalable up to a height of 1,200 mm in increments of 60 mm. Each of these miniTwin stick lengths is available with resolutions of 14 mm, 24 mm and 34 mm. The safety light curtain can thus be ideally adapted to individual requirements.

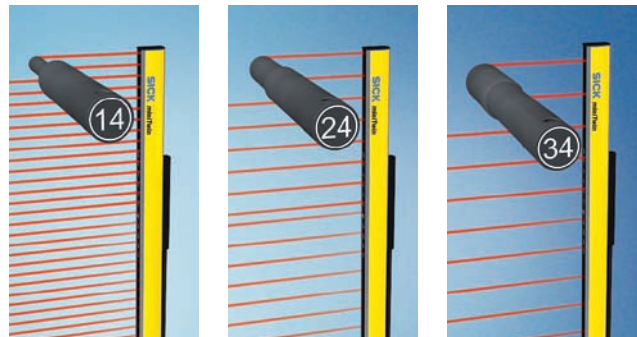

Resolutions of 14 mm, 24 mm and 34 mm

An endless story: sender = receiver = cascading.

miniTwin brings a new uniformity to safety technology. The result of this standardisation is fewer components and thus substantially less ordering, logistical, handling and service effort.

One stick does the trick: the miniTwin stick

The miniTwin safety light curtain consists of two identical miniTwin sticks of the same size. Each miniTwin stick contains both the sender and receiver elements, each symmetrically mounted in one half of a housing. The safe light grid is created by mounting two miniTwin sticks offset by 180° so that the sender and receiver are located opposite one another. In the case of cascading, the particular system plug used (with one or two outgoing cables) defines which miniTwin stick acts as the host and which is the guest – and they automatically configure themselves.



Cables and plugs are also standardised

The system plug on the back of the miniTwin housing is symmetrically constructed and can be mounted with the cable exit facing upwards or downwards depending on the particular installation situation. Cascading connections and integration in the safety controller always take place with a 5-pin M12 standard plug via reasonably priced 5-wire cable – with full functionality: reset and external device monitoring.





SICK *miniTwin*

SICK *miniTwin*



**Standardisation with the miniTwin stick –
for many protective field shapes**

Whether as a stand-alone variant or as a cascade:
the miniTwin meets all requirements:

- profile frame mounting with two miniTwin sticks
- L-shaped application with four miniTwin sticks
- U-shaped application with six miniTwin sticks

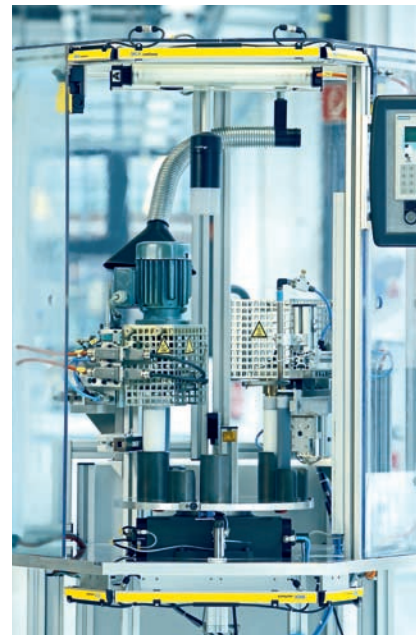

Whichever way you look at it:
the miniTwin can be mounted anywhere
and in any orientation.

Development of the miniTwin focused on easy handling. Application-specific brackets simplify installation, and integrated LED indicators accelerate commissioning and diagnosis.

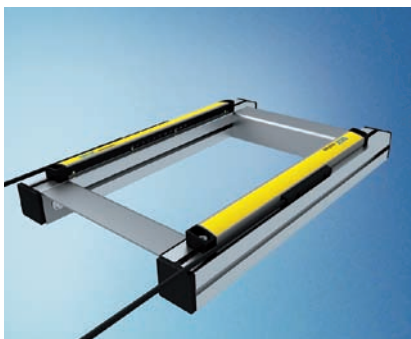

O-Fix brackets for flat mounting

- Mounting on the device ends for flat installation on profile frames or in machine niches
- 20 mm resolution at housing ends (incl. O-Fix bracket)



C- and L-Fix brackets for vertical mounting

- Mounting on profile or machine frames
- For fixed positioning
- 14 mm resolution at housing ends
- No blind zones

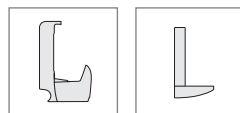

C-Fix brackets for cascade structures around corners

- Space-saving corner mounting for cascade structures
- Fixing on device profile
- 14 mm resolution at housing ends
- No blind zones

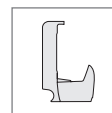

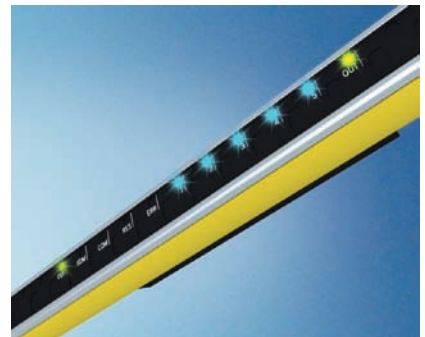
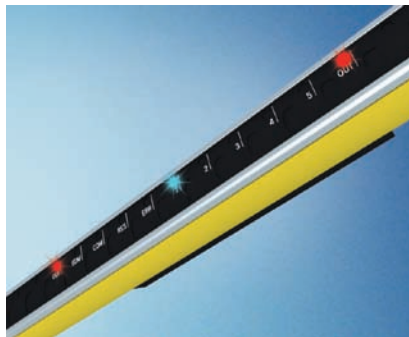

Blue LEDs simplify alignment: the more blue LEDs light up, the better the alignment.

LED indicators for alignment, configuration, status and diagnosis

Each miniTwin stick unit has an integrated display with eleven coloured LEDs. The information provided by this practical indicator concept can be appreciated intuitively: constantly lit LEDs act as a status indicator, blinking LEDs show that an action is necessary. Faults are signalled via a red LED.

Reset (RES) and external device monitoring (EDM)

Configuration of the miniTwin light curtain's reset and external device monitoring takes place after electrical connection during the power-up cycle – automatically for EDM and by pressing a button in the case of RES. The configuration is stored and can be reset if required.

miniTwin4 Safety Light Curtain

Connection examples and dimensions

Wiring plan of miniTwin4 with UE10-2FG safety relay

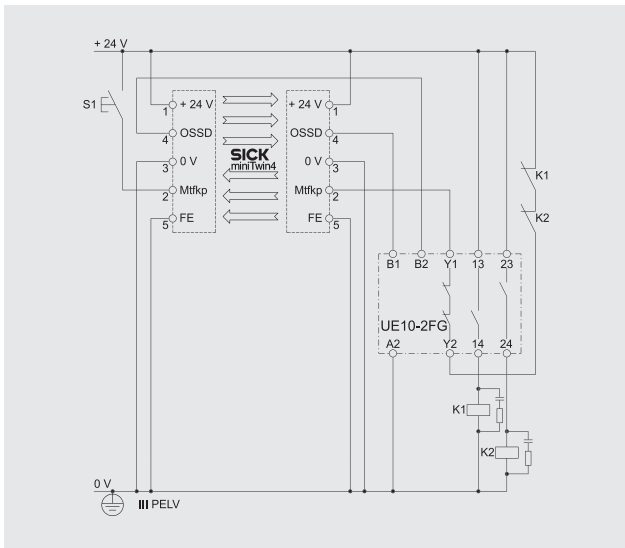

Wiring plan of miniTwin4 and emergency stop pushbutton with UE410-MU/XU Flexi Classic safety controller

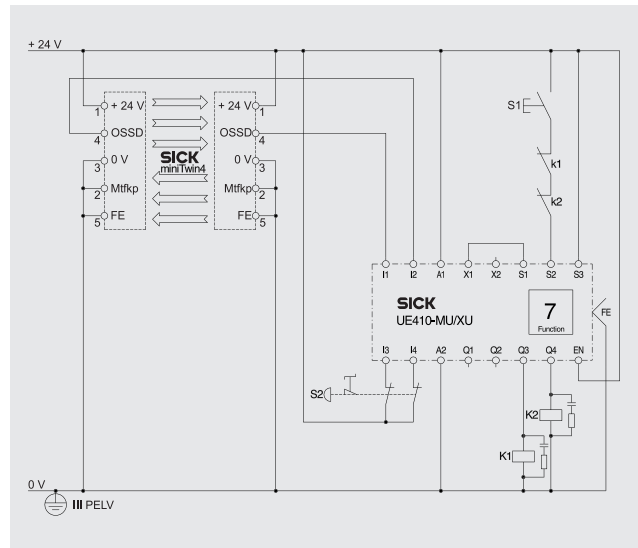

Dimensions of miniTwin stick and brackets (in mm)

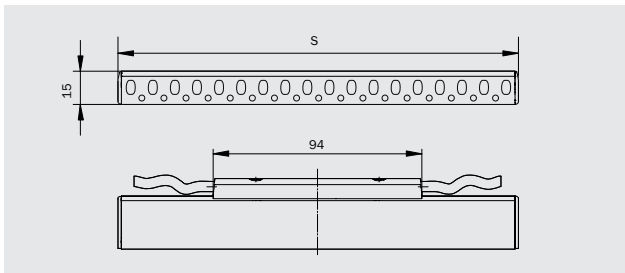

The protection field height S and the housing size (length) are identical.

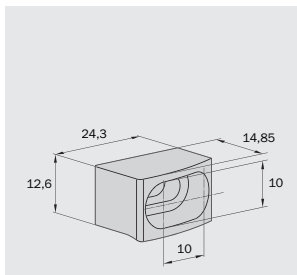
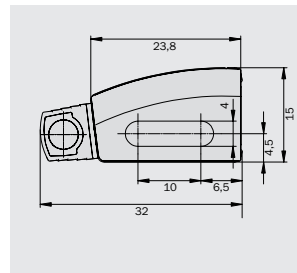

O-Fix bracket

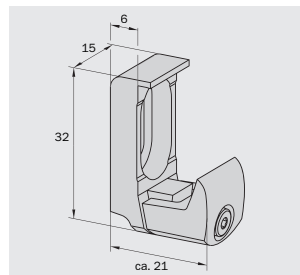

C-Fix bracket

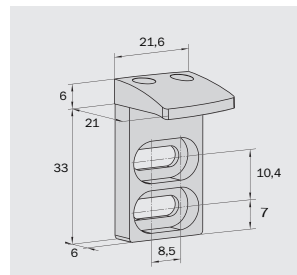

L-Fix bracket

Further information and miniTwin Operating Instructions can be found in the SICK Partner Portal on the Internet.

www.sick-minitwin.com



Technical data miniTwin4

General system data	
Type	4 (IEC 61 496)
Safety Integrity Level	SIL3 (IEC 61 508) SILCL3 (EN 62 061)
Category	Category 4 (EN ISO 13 849)
Performance Level	PL e (EN ISO 13 849)
PFHd (average probability of dangerous failure per hour)	Stand-alone systems 4.3×10^{-9} 1/h Cascaded systems 1.3×10^{-8} 1/h
TM (service life)	20 years (EN ISO 13 849)
Category according to EN 954-1 ¹⁾	Category 4 (EN 954-1)
Protection class (DIN EN 61 140) ²⁾	III
Enclosure rating (IEC 60 529)	IP 65
Housing size, type-dependent	120 mm to 1200 mm, in 60 mm increments
Resolution	14 mm, 24 mm, 34 mm
Protective field width	0 to 4 m
Power supply, U _v at device ³⁾	Minimum 19.2 V typically 24 V maximum 28.8 V
Switching outputs (OSSD)	300 mA, PNP semiconductor, short-circuited protected ⁴⁾
Response time Stand-alone, 24 mm and 34 mm resolution Stand-alone, 14 mm resolution Additional time for cascade of 4 miniTwin sticks Additional time for cascade of 6 miniTwin sticks	≤ 13 ms ≤ 14 ms for protection field heights from 120–720 mm ≤ 17 ms for protection field heights from 780–1200 mm 2 ms 4 ms

Operating data	
System plug	M12x4 + FE plug
Cable length ⁵⁾	Maximum 20 m
Cable cross-section	0.34 mm ²
Operating ambient temperature	Minimum 0 °C maximum +55 °C
Air humidity (non-condensing)	Minimum 15 % maximum 95 %
Storage temperature	Minimal -25 °C maximum +70 °C
Housing cross-section	15 mm × 24 mm
Dimensions incl. plug	15 mm × 32 mm
Vibration resistance	5 g, 10–55 Hz acc. to IEC 60 068-2-6
Shock resistance	10 g/16 ms acc. to IEC 60 068-2-29

¹⁾ Only valid for conformity assumption until 29.11.2009. Thereafter only the successor standard EN ISO 13 849-1:2006 can be applied.

²⁾ Safe extra-low voltage SELV/PELV.



³⁾ In order to comply with the requirements of the relevant product standards (e.g. IEC 61 496-1), the device's external voltage supply (SELV) must be capable of bridging for the permitted temporary power failure of 20 ms according to EN 60 204-1.

⁴⁾ Applies for voltages within the range of between -3 V and +30 V.

⁵⁾ According to IEC 61 131-2.



Ordering the miniTwin4

The “Stand-alone” or “End-device cascade” miniTwin-stick package

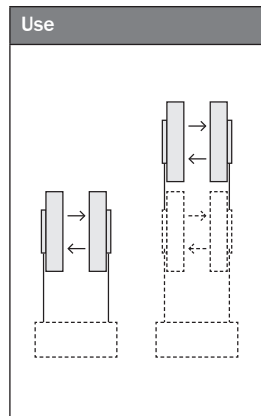
Scope of delivery ¹⁾	Length ²⁾ mm	14 mm resolution		24 mm resolution		34 mm resolution	
		Type No.	Part No.	Type No.	Part No.	Type No.	Part No.
1 x  miniTwin stick	120	C4MT-01214ABB03BE0	1207094	C4MT-01224ABB03BE0	1207222	C4MT-01234ABB03BE0	1207242
	180	C4MT-01814ABB03BE0	1207097	C4MT-01824ABB03BE0	1207223	C4MT-01834ABB03BE0	1207243
2 x  C-Fix bracket	240	C4MT-02414ABB03DE0	1207098	C4MT-02424ABB03DE0	1207224	C4MT-02434ABB03DE0	1207244
	300	C4MT-03014ABB03DE0	1207099	C4MT-03024ABB03DE0	1207225	C4MT-03034ABB03DE0	1207245
2 x  L-Fix bracket	360	C4MT-03614ABB03DE0	1207100	C4MT-03624ABB03DE0	1207227	C4MT-03634ABB03DE0	1207246
	420	C4MT-04214ABB03DE0	1207101	C4MT-04224ABB03DE0	1207228	C4MT-04234ABB03DE0	1207247
Two identical miniTwin-stick packages must always be ordered for a complete system.	480	C4MT-04814ABB03DE0	1207102	C4MT-04824ABB03DE0	1207229	C4MT-04834ABB03DE0	1207248
	540	C4MT-05414ABB03DE0	1207103	C4MT-05424ABB03DE0	1207230	C4MT-05434ABB03DE0	1207249
	600	C4MT-06014ABB03FE0	1207104	C4MT-06024ABB03FE0	1207231	C4MT-06034ABB03FE0	1207250
	660	C4MT-06614ABB03FE0	1207105	C4MT-06624ABB03FE0	1207232	C4MT-06634ABB03FE0	1207251
	720	C4MT-07214ABB03FE0	1207106	C4MT-07224ABB03FE0	1207233	C4MT-07234ABB03FE0	1207252
	780	C4MT-07814ABB03FE0	1207107	C4MT-07824ABB03FE0	1207234	C4MT-07834ABB03FE0	1207253
	840	C4MT-08414ABB03FE0	1207108	C4MT-08424ABB03FE0	1207235	C4MT-08434ABB03FE0	1207254
	900	C4MT-09014ABB03FE0	1207109	C4MT-09024ABB03FE0	1207236	C4MT-09034ABB03FE0	1207255
	960	C4MT-09614ABB03FE0	1207110	C4MT-09624ABB03FE0	1207237	C4MT-09634ABB03FE0	1207256
	1020	C4MT-10214ABB03FE0	1207111	C4MT-10224ABB03FE0	1207238	C4MT-10234ABB03FE0	1207257
	1080	C4MT-10814ABB03FE0	1207112	C4MT-10824ABB03FE0	1207239	C4MT-10834ABB03FE0	1207258
	1140	C4MT-11414ABB03FE0	1207113	C4MT-11424ABB03FE0	1207240	C4MT-11434ABB03FE0	1207259
1200	C4MT-12014ABB03FE0	1207114	C4MT-12024ABB03FE0	1207241	C4MT-12034ABB03FE0	1207260	



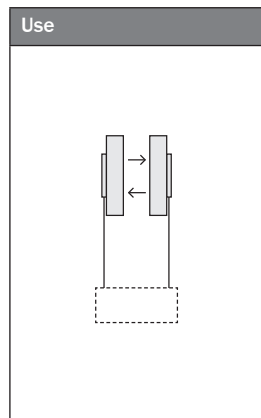

“Stand-alone” miniTwin-stick package with O-Fix brackets

Scope of delivery ¹⁾	Length ²⁾ mm	14 mm resolution		24 mm resolution		34 mm resolution	
		Type No.	Part No.	Type No.	Part No.	Type No.	Part No.
1 x  miniTwin stick	120	C4MT-01214ABB03BB0	1206951	C4MT-01224ABB03BB0	1207318	C4MT-01234ABB03BB0	1207334
	180	C4MT-01814ABB03BB0	1206945	C4MT-01824ABB03BB0	1207177	C4MT-01834ABB03BB0	1207335
2 x  O-Fix bracket	240	C4MT-02414ABB03DB0	1206954	C4MT-02424ABB03DB0	1207319	C4MT-02434ABB03DB0	1207336
	300	C4MT-03014ABB03DB0	1206953	C4MT-03024ABB03DB0	1207320	C4MT-03034ABB03DB0	1207337
Two identical miniTwin-stick packages must always be ordered for a complete system.	360	C4MT-03614ABB03DB0	1206955	C4MT-03624ABB03DB0	1207321	C4MT-03634ABB03DB0	1207338
	420	C4MT-04214ABB03DB0	1206956	C4MT-04224ABB03DB0	1207322	C4MT-04234ABB03DB0	1207339
	480	C4MT-04814ABB03DB0	1206957	C4MT-04824ABB03DB0	1207178	C4MT-04834ABB03DB0	1207340
	540	C4MT-05414ABB03DB0	1206958	C4MT-05424ABB03DB0	1207323	C4MT-05434ABB03DB0	1207341
	600	C4MT-06014ABB03FB0	1206959	C4MT-06024ABB03FB0	1207324	C4MT-06034ABB03FB0	1207342
	660	C4MT-06614ABB03FB0	1206960	C4MT-06624ABB03FB0	1207325	C4MT-06634ABB03FB0	1207343
	720	C4MT-07214ABB03FB0	1206961	C4MT-07224ABB03FB0	1207326	C4MT-07234ABB03FB0	1207344
	780	C4MT-07814ABB03FB0	1206962	C4MT-07824ABB03FB0	1207327	C4MT-07834ABB03FB0	1207345
	840	C4MT-08414ABB03FB0	1206963	C4MT-08424ABB03FB0	1207328	C4MT-08434ABB03FB0	1207346
	900	C4MT-09014ABB03FB0	1206964	C4MT-09024ABB03FB0	1207329	C4MT-09034ABB03FB0	1207347
	960	C4MT-09614ABB03FB0	1206965	C4MT-09624ABB03FB0	1207330	C4MT-09634ABB03FB0	1207348
	1020	C4MT-10214ABB03FB0	1206966	C4MT-10224ABB03FB0	1207331	C4MT-10234ABB03FB0	1207349
1080	C4MT-10814ABB03FB0	1206967	C4MT-10824ABB03FB0	1207332	C4MT-10834ABB03FB0	1207350	
1140	C4MT-11414ABB03FB0	1206968	C4MT-11424ABB03FB0	1207180	C4MT-11434ABB03FB0	1207351	
1200	C4MT-12014ABB03FB0	1206969	C4MT-12024ABB03FB0	1207333	C4MT-12034ABB03FB0	1207169	







“Cascade Host/Guest“ miniTwin-stick package

Scope of delivery ¹⁾	Length ²⁾ mm	14 mm resolution		24 mm resolution		34 mm resolution	
		Type No.	Part No.	Type No.	Part No.	Type No.	Part No.
1 x  miniTwin stick	120	C4MT-01214ABB04BE0	1207115	C4MT-01224ABB04BE0	1207168	C4MT-01234ABB04BE0	1207300
	180	C4MT-01814ABB04BE0	1207116	C4MT-01824ABB04BE0	1207283	C4MT-01834ABB04BE0	1207301
2 x  C-Fix bracket	240	C4MT-02414ABB04DE0	1207117	C4MT-02424ABB04DE0	1207284	C4MT-02434ABB04DE0	1207302
2 x  L-Fix bracket	300	C4MT-03014ABB04DE0	1207118	C4MT-03024ABB04DE0	1207285	C4MT-03034ABB04DE0	1207303
	360	C4MT-03614ABB04DE0	1207119	C4MT-03624ABB04DE0	1207286	C4MT-03634ABB04DE0	1207304
Two identical miniTwin-stick packages must always be ordered for a complete system.	420	C4MT-04214ABB04DE0	1207120	C4MT-04224ABB04DE0	1207287	C4MT-04234ABB04DE0	1207305
	480	C4MT-04814ABB04DE0	1207121	C4MT-04824ABB04DE0	1207181	C4MT-04834ABB04DE0	1207306
	540	C4MT-05414ABB04DE0	1207122	C4MT-05424ABB04DE0	1207288	C4MT-05434ABB04DE0	1207307
	600	C4MT-06014ABB04FE0	1207123	C4MT-06024ABB04FE0	1207289	C4MT-06034ABB04FE0	1207308
	660	C4MT-06614ABB04FE0	1207124	C4MT-06624ABB04FE0	1207290	C4MT-06634ABB04FE0	1207309
	720	C4MT-07214ABB04FE0	1207125	C4MT-07224ABB04FE0	1207291	C4MT-07234ABB04FE0	1207310
	780	C4MT-07814ABB04FE0	1207126	C4MT-07824ABB04FE0	1207292	C4MT-07834ABB04FE0	1207311
	840	C4MT-08414ABB04FE0	1207127	C4MT-08424ABB04FE0	1207293	C4MT-08434ABB04FE0	1207312
	900	C4MT-09014ABB04FE0	1207128	C4MT-09024ABB04FE0	1207294	C4MT-09034ABB04FE0	1207313
	960	C4MT-09614ABB04FE0	1207129	C4MT-09624ABB04FE0	1207295	C4MT-09634ABB04FE0	1207314
	1020	C4MT-10214ABB04FE0	1207130	C4MT-10224ABB04FE0	1207296	C4MT-10234ABB04FE0	1207315
	1080	C4MT-10814ABB04FE0	1207131	C4MT-10824ABB04FE0	1207297	C4MT-10834ABB04FE0	1207316
1140	C4MT-11414ABB04FE0	1207132	C4MT-11424ABB04FE0	1207298	C4MT-11434ABB04FE0	1207317	
1200	C4MT-12014ABB04FE0	1207133	C4MT-12024ABB04FE0	1207299	C4MT-12034ABB04FE0	1206993	

Connection cable depending on the protection field height:

Protection field height 120–180 mm:	160 mm connection cable
Protection field height 240–540 mm:	350 mm connection cable
Protection field height 600–1200 mm:	700 mm connection cable

Accessories

	Part No.	Type	Description
	System connection		
	6008899	DOL-1205-G02M	Connection cable 2 m; socket M12 x 5 and open cable end
	6009868	DOL-1205-G05M	Connection cable 5 m; socket M12 x 5 and open cable end
	6010544	DOL-1205-G10MC	Connection cable 10 m; socket M12 x 5 and open cable end
	6029215	DOL-1205-G15MC	Connection cable 15 m; socket M12 x 5 and open cable end
	6022083	STE-1205-G	Cable plug M12 x 5, straight, adaptable
	Cascade enlargement cable		
	6029280	DSL-1205-G01MC	Connecting cable 1 m; socket M12 x 5 and plug M12 x 5
	6025931	DSL-1205-G02MC	Connecting cable 2 m; socket M12 x 5 and plug M12 x 5
	Flexi Classic safety controller		
	6026136	UE410-MU3T5	4 inputs, 4 PNP semiconductor outputs, 24 V DC, delay 0...5 s, removable terminals
	UE10-2FG and UE12-2FG safety relays with positively driven contacts		
	1043915	UE10-2FG	with 2 safety outputs
	1043917	UE12-2FG	with 2 safety outputs, cascadable

¹⁾ Scope of delivery: Operating Instructions on CD-ROM, test rod, test instruction sticker.
²⁾ Consistent with the protection field height S in dimensional drawing on page 10.

miniTwin2 Safety Light Curtain

Connection examples and dimensions

Wiring plan of miniTwin2 with UE10-2FG safety relay

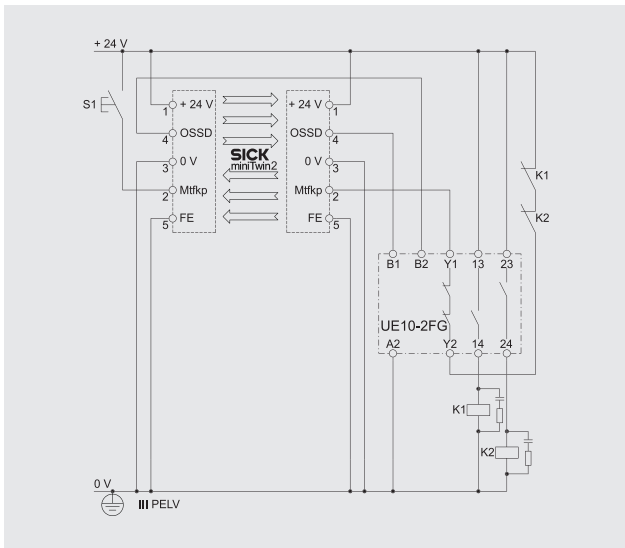

Wiring plan of miniTwin2 and emergency stop pushbutton with UE410-MU/XU Flexi Classic safety controller

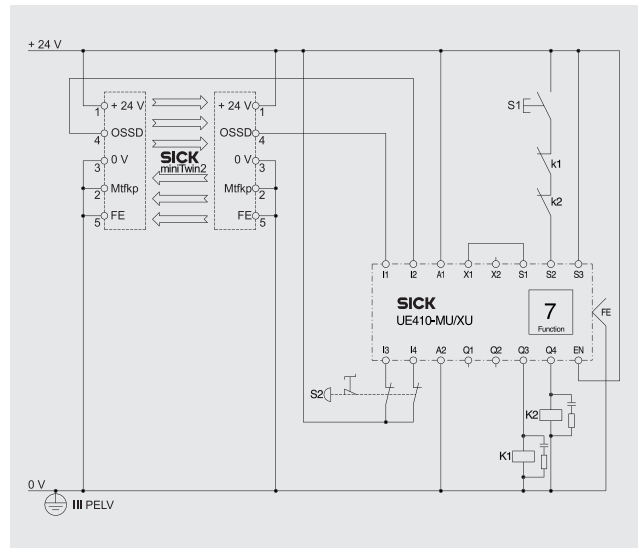

Dimensions of miniTwin stick and brackets (in mm)

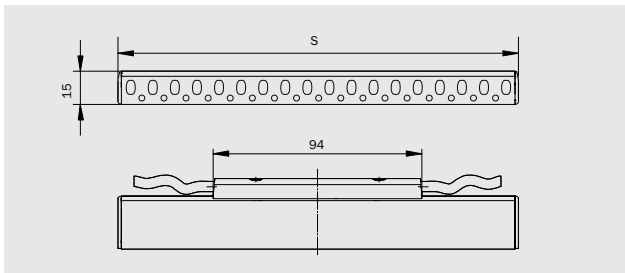

The protection field height S and the housing size (length) are identical.

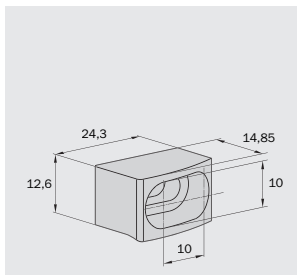
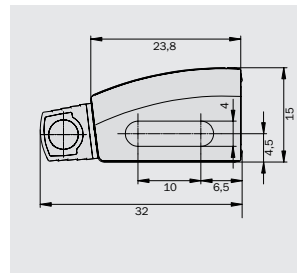

O-Fix bracket

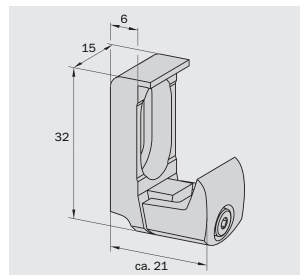

C-Fix bracket

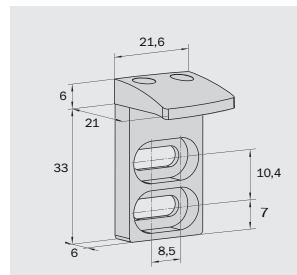

L-Fix bracket

Further information and miniTwin Operating Instructions can be found in the SICK Partner Portal on the Internet.

www.sick-minitwin.com

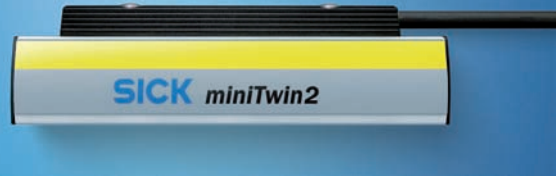

Technical data miniTwin2

General system data	
Type	2 (IEC 61 496)
Safety Integrity Level	SIL2 (IEC 61 508) SILCL2 (EN 62 061)
Category	Category 2 (EN ISO 13 849)
Performance Level	PL d (EN ISO 13 849), pay attention to optical characteristics! ⁶⁾
PFHd (average probability of dangerous failure per hour)	Stand-alone systems 2.4 x 10 ⁻⁸ 1/h Cascaded systems 5.2 x 10 ⁻⁸ 1/h
TM (service life)	20 years (EN ISO 13 849)
Category according to EN 954-1 ¹⁾	Category 2 (EN 954-1)
Protection class (DIN EN 61 140) ²⁾	III
Enclosure rating (IEC 60 529)	IP 65
Housing size, type-dependent	120 mm to 1200 mm, in 60 mm increments
Resolution	14 mm, 24 mm, 34 mm
Protective field width	Minimum 0 to 6 m, typical 0 to 8 m
Power supply, U _v at device ³⁾	Minimum 19.2 V typically 24 V maximum 28.8 V
Switching outputs (OSSD)	300 mA, PNP semiconductor, short-circuited protected ⁴⁾
Response time Stand-alone, 24 mm and 34 mm resolution Stand-alone, 14 mm resolution Additional time for cascade of 4 miniTwin sticks Additional time for cascade of 6 miniTwin sticks	≤ 13 ms ≤ 14 ms for protection field heights from 120–720 mm ≤ 17 ms for protection field heights from 780–1200 mm 2 ms 4 ms

Operating data	
System plug	M12x4 + FE plug
Cable length ⁵⁾	Maximum 20 m
Cable cross-section	0.34 mm ²
Operating ambient temperature	Minimum -10 °C maximum +55 °C
Air humidity (non-condensing)	Minimum 15 % maximum 95 %
Storage temperature	Minimal -25 °C maximum +70 °C
Housing cross-section	15 mm × 24 mm
Dimensions incl. plug	15 mm × 32 mm
Vibration resistance	5 g, 10–55 Hz acc. to IEC 60 068-2-6
Shock resistance	10 g/16 ms acc. to IEC 60 068-2-29

¹⁾ Only valid for conformity assumption until 29.11.2009. Thereafter only the successor standard EN ISO 13 849-1:2006 can be applied.

²⁾ Safe extra-low voltage SELV/PELV.

³⁾ In order to comply with the requirements of the relevant product standards (e.g. IEC 61 496-1), the device's external voltage supply (SELV) must be capable of bridging for the permitted temporary power failure of 20 ms according to EN 60 204-1.



⁴⁾ Applies for voltages within the range of between -3 V and +30 V.

⁵⁾ According to IEC 61 131-2.

⁶⁾ The Performance Level does not contain any specific requirements on aspects such as the optical characteristics. You will find more detailed information on this topic in www.sick-safetyplus.com, Safety Know-how.



Ordering the miniTwin2

The “Stand-alone” or “End-device cascade” miniTwin-stick package

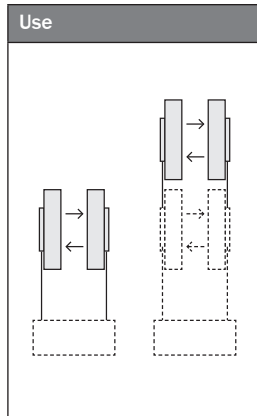
Scope of delivery ¹⁾	Length ²⁾ mm	14 mm resolution		24 mm resolution		34 mm resolution	
		Type No.	Part No.	Type No.	Part No.	Type No.	Part No.
1 x  miniTwin stick	120	C2MT-01214BBC03BE0	1207793	C2MT-01224BBC03BE0	1207822	C2MT-01234BBC03BE0	1207847
	180	C2MT-01814BBC03BE0	1207794	C2MT-01824BBC03BE0	1207823	C2MT-01834BBC03BE0	1207848
2 x  C-Fix bracket	240	C2MT-02414BBC03DE0	1207795	C2MT-02424BBC03DE0	1207824	C2MT-02434BBC03DE0	1207849
	300	C2MT-03014BBC03DE0	1207796	C2MT-03024BBC03DE0	1207825	C2MT-03034BBC03DE0	1207850
2 x  L-Fix bracket	360	C2MT-03614BBC03DE0	1207797	C2MT-03624BBC03DE0	1207832	C2MT-03634BBC03DE0	1207851
	420	C2MT-04214BBC03DE0	1207798	C2MT-04224BBC03DE0	1207833	C2MT-04234BBC03DE0	1207852
Two identical miniTwin-stick packages must always be ordered for a complete system.	480	C2MT-04814BBC03DE0	1207799	C2MT-04824BBC03DE0	1207834	C2MT-04834BBC03DE0	1207853
	540	C2MT-05414BBC03DE0	1207800	C2MT-05424BBC03DE0	1207835	C2MT-05434BBC03DE0	1207854
	600	C2MT-06014BBC03FE0	1207801	C2MT-06024BBC03FE0	1207836	C2MT-06034BBC03FE0	1207855
	660	C2MT-06614BBC03FE0	1207802	C2MT-06624BBC03FE0	1207837	C2MT-06634BBC03FE0	1207856
	720	C2MT-07214BBC03FE0	1207803	C2MT-07224BBC03FE0	1207838	C2MT-07234BBC03FE0	1207857
	780	C2MT-07814BBC03FE0	1207813	C2MT-07824BBC03FE0	1207839	C2MT-07834BBC03FE0	1207858
	840	C2MT-08414BBC03FE0	1207814	C2MT-08424BBC03FE0	1207840	C2MT-08434BBC03FE0	1207859
	900	C2MT-09014BBC03FE0	1207816	C2MT-09024BBC03FE0	1207841	C2MT-09034BBC03FE0	1207860
	960	C2MT-09614BBC03FE0	1207817	C2MT-09624BBC03FE0	1207842	C2MT-09634BBC03FE0	1207861
	1020	C2MT-10214BBC03FE0	1207818	C2MT-10224BBC03FE0	1207843	C2MT-10234BBC03FE0	1207862
	1080	C2MT-10814BBC03FE0	1207819	C2MT-10824BBC03FE0	1207844	C2MT-10834BBC03FE0	1207863
	1140	C2MT-11414BBC03FE0	1207820	C2MT-11424BBC03FE0	1207845	C2MT-11434BBC03FE0	1207864
1200	C2MT-12014BBC03FE0	1207821	C2MT-12024BBC03FE0	1207846	C2MT-12034BBC03FE0	1207865	



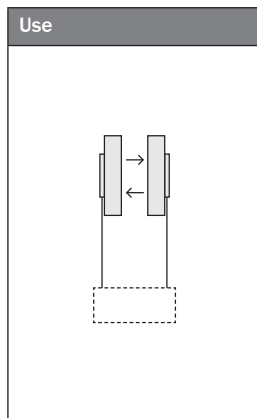

“Stand-alone” miniTwin-stick package with O-Fix brackets

Scope of delivery ¹⁾	Length ²⁾ mm	14 mm resolution		24 mm resolution		34 mm resolution	
		Type No.	Part No.	Type No.	Part No.	Type No.	Part No.
1 x  miniTwin stick	120	C2MT-01214BBC03BB0	1207923	C2MT-01224BBC03BB0	1207942	C2MT-01234BBC03BB0	1207961
	180	C2MT-01814BBC03BB0	1207924	C2MT-01824BBC03BB0	1207943	C2MT-01834BBC03BB0	1207962
2 x  O-Fix bracket	240	C2MT-02414BBC03DB0	1207925	C2MT-02424BBC03DB0	1207944	C2MT-02434BBC03DB0	1207963
	300	C2MT-03014BBC03DB0	1207926	C2MT-03024BBC03DB0	1207945	C2MT-03034BBC03DB0	1207964
Two identical miniTwin-stick packages must always be ordered for a complete system.	360	C2MT-03614BBC03DB0	1207927	C2MT-03624BBC03DB0	1207946	C2MT-03634BBC03DB0	1207965
	420	C2MT-04214BBC03DB0	1207928	C2MT-04224BBC03DB0	1207947	C2MT-04234BBC03DB0	1207966
	480	C2MT-04814BBC03DB0	1207929	C2MT-04824BBC03DB0	1207948	C2MT-04834BBC03DB0	1207967
	540	C2MT-05414BBC03DB0	1207930	C2MT-05424BBC03DB0	1207949	C2MT-05434BBC03DB0	1207968
	600	C2MT-06014BBC03FB0	1207931	C2MT-06024BBC03FB0	1207950	C2MT-06034BBC03FB0	1207969
	660	C2MT-06614BBC03FB0	1207932	C2MT-06624BBC03FB0	1207951	C2MT-06634BBC03FB0	1207970
	720	C2MT-07214BBC03FB0	1207933	C2MT-07224BBC03FB0	1207952	C2MT-07234BBC03FB0	1207971
	780	C2MT-07814BBC03FB0	1207934	C2MT-07824BBC03FB0	1207953	C2MT-07834BBC03FB0	1207972
	840	C2MT-08414BBC03FB0	1207935	C2MT-08424BBC03FB0	1207954	C2MT-08434BBC03FB0	1207973
	900	C2MT-09014BBC03FB0	1207936	C2MT-09024BBC03FB0	1207955	C2MT-09034BBC03FB0	1207974
	960	C2MT-09614BBC03FB0	1207937	C2MT-09624BBC03FB0	1207956	C2MT-09634BBC03FB0	1207975
	1020	C2MT-10214BBC03FB0	1207938	C2MT-10224BBC03FB0	1207957	C2MT-10234BBC03FB0	1207976
1080	C2MT-10814BBC03FB0	1207939	C2MT-10824BBC03FB0	1207958	C2MT-10834BBC03FB0	1207977	
1140	C2MT-11414BBC03FB0	1207940	C2MT-11424BBC03FB0	1207959	C2MT-11434BBC03FB0	1207978	
1200	C2MT-12014BBC03FB0	1207941	C2MT-12024BBC03FB0	1207960	C2MT-12034BBC03FB0	1207979	







“Cascade Host/Guest“ miniTwin-stick package

Scope of delivery ¹⁾	Length ²⁾ mm	14 mm resolution		24 mm resolution		34 mm resolution	
		Type No.	Part No.	Type No.	Part No.	Type No.	Part No.
1 x  miniTwin stick	120	C2MT-01214BBC04BE0	1207866	C2MT-01224BBC04BE0	1207885	C2MT-01234BBC04BE0	1207904
	180	C2MT-01814BBC04BE0	1207867	C2MT-01824BBC04BE0	1207886	C2MT-01834BBC04BE0	1207905
2 x  C-Fix bracket	240	C2MT-02414BBC04DE0	1207868	C2MT-02424BBC04DE0	1207887	C2MT-02434BBC04DE0	1207906
	300	C2MT-03014BBC04DE0	1207869	C2MT-03024BBC04DE0	1207888	C2MT-03034BBC04DE0	1207907
2 x  L-Fix bracket	360	C2MT-03614BBC04DE0	1207870	C2MT-03624BBC04DE0	1207889	C2MT-03634BBC04DE0	1207908
	420	C2MT-04214BBC04DE0	1207871	C2MT-04224BBC04DE0	1207890	C2MT-04234BBC04DE0	1207909
Two identical miniTwin-stick packages must always be ordered for a complete system.	480	C2MT-04814BBC04DE0	1207872	C2MT-04824BBC04DE0	1207891	C2MT-04834BBC04DE0	1207910
	540	C2MT-05414BBC04DE0	1207873	C2MT-05424BBC04DE0	1207892	C2MT-05434BBC04DE0	1207911
	600	C2MT-06014BBC04FE0	1207874	C2MT-06024BBC04FE0	1207893	C2MT-06034BBC04FE0	1207912
	660	C2MT-06614BBC04FE0	1207875	C2MT-06624BBC04FE0	1207894	C2MT-06634BBC04FE0	1207913
	720	C2MT-07214BBC04FE0	1207876	C2MT-07224BBC04FE0	1207895	C2MT-07234BBC04FE0	1207914
	780	C2MT-07814BBC04FE0	1207877	C2MT-07824BBC04FE0	1207896	C2MT-07834BBC04FE0	1207915
	840	C2MT-08414BBC04FE0	1207878	C2MT-08424BBC04FE0	1207897	C2MT-08434BBC04FE0	1207916
	900	C2MT-09014BBC04FE0	1207879	C2MT-09024BBC04FE0	1207898	C2MT-09034BBC04FE0	1207917
	960	C2MT-09614BBC04FE0	1207880	C2MT-09624BBC04FE0	1207899	C2MT-09634BBC04FE0	1207918
	1020	C2MT-10214BBC04FE0	1207881	C2MT-10224BBC04FE0	1207900	C2MT-10234BBC04FE0	1207919
	1080	C2MT-10814BBC04FE0	1207882	C2MT-10824BBC04FE0	1207901	C2MT-10834BBC04FE0	1207920
	1140	C2MT-11414BBC04FE0	1207883	C2MT-11424BBC04FE0	1207902	C2MT-11434BBC04FE0	1207921
1200	C2MT-12014BBC04FE0	1207884	C2MT-12024BBC04FE0	1207903	C2MT-12034BBC04FE0	1207922	

Connection cable depending on the protection field height:

Protection field height 120–180 mm:	160 mm connection cable
Protection field height 240–540 mm:	350 mm connection cable
Protection field height 600–1200 mm:	700 mm connection cable

Accessories

	Part No.	Type	Description
	System connection		
	6008899	DOL-1205-G02M	Connection cable 2 m; socket M12 x 5 and open cable end
	6009868	DOL-1205-G05M	Connection cable 5 m; socket M12 x 5 and open cable end
	6010544	DOL-1205-G10MC	Connection cable 10 m; socket M12 x 5 and open cable end
	6029215	DOL-1205-G15MC	Connection cable 15 m; socket M12 x 5 and open cable end
	6022083	STE-1205-G	Cable plug M12 x 5, straight, adaptable
	Cascade enlargement cable		
	6029280	DSL-1205-G01MC	Connecting cable 1 m; socket M12 x 5 and plug M12 x 5
	6025931	DSL-1205-G02MC	Connecting cable 2 m; socket M12 x 5 and plug M12 x 5
	Flexi Classic safety controller		
	6026136	UE410-MU3T5	4 inputs, 4 PNP semiconductor outputs, 24 V DC, delay 0...5 s, removable terminals
	UE10-2FG and UE12-2FG safety relays with positively driven contacts		
	1043915	UE10-2FG	with 2 safety outputs
	1043917	UE12-2FG	with 2 safety outputs, cascable

¹⁾ Scope of delivery: Operating Instructions on CD-ROM, test rod, test instruction sticker.
²⁾ Consistent with the protection field height S in dimensional drawing on page 14.

Complete system for effective accident prevention and human protection



The plus for greater safety and efficiency: safetyPLUS®. SICK has been developing safety innovations for 60 years. As a complete supplier with the world's most comprehensive safety portfolio, we set international standards in performance and functionality. This makes us the leading supplier of trailblazing products and services covering all aspects of industrial safety.

Experience and competence

safetyPLUS® forms the ideal wide-ranging safety concept from a unique range of performance, because the safety of persons and machines largely depends on the correct application of complex directives and standards. Another advantage: a comprehensive safety concept based on safetyPLUS® saves time and money.

State-of-the-art technology and system openness

We offer complete safety applications from a diverse product portfolio. Particularly important: SICK's typical openness provides smooth integration in all safety and system environments.



EtherNet





User-friendly and clever safety solutions

Trendsetting products and application-oriented functions: safetyPLUS® offers a unique all-round safety package from safety switches, through opto-electronic sensors and safe camera systems, to safe controller solutions and networks. And every SICK technology is fundamentally as easy as possible in practical use and remains up-to-date for years to come.

All-embracing services

You can be confident that legal demands are met: CE conformity advice, application support, assistance during commissioning, accredited inspection services, product support, modernisation, service contracts, training. From the initial idea to running maintenance: experts from SICK accompany you during every phase of a project.



Worldwide presence with subsidiaries in the following countries:

Australia
Belgium/Luxembourg
Brasil
Ceská Republika
China
Danmark
Deutschland
España
France
Great Britain
India
Israel
Italia
Japan
Nederland
Norge

Österreich
Polska
Republic of Korea
Republika Slovenija
România
Russia
Schweiz
Singapore
Suomi
Sverige
Taiwan
Türkiye
United Arab Emirates
USA/Canada/México

Please find detailed addresses and additional representatives and agencies in all major industrial nations at www.sick.com

Handed over by:

Our Business Segment Expertise

Factory automation

With its intelligent sensors, safety systems, and automatic identification applications, SICK provides comprehensive solutions for factory automation.



- Non-contact detecting, counting, classifying, and positioning of any type of object
- Accident protection and personal safety using sensors, as well as safety software and services

Logistics automation

Sensors made by SICK form the basis for automating material flows and the optimisation of sorting and warehousing processes.



- Automated identification with bar-code and RFID reading devices for the purpose of sorting and target control in industrial material flow
- Detecting volume, position, and contours of objects and surroundings with laser measurement systems

Process automation

Optimised system solutions from SICK ensure efficient acquisition of environmental and process data in many industrial processes.



- Precise measurement of gases, liquids and dust concentrations for continuous monitoring of emissions and the acquisition of process data in production processes
- Gas flow measurements with maximum accuracy thanks to compact gas metres