

V500-R521B2
V500-R521C2

Bar Code Reader

USERS MANUAL

OMRON

Introduction	READ AND UNDERSTAND THIS DOCUMENT (Be sure to read this.)	Introduction
Section 1	Product Overview	Section 1
Section 2	Wiring and Installation	Section 2
Section 3	Function Explanation	Section 3
Section 4	Setting Method	Section 4
Section 5	Example of System Configuration	Section 5
Section 6	Appendix	Appendix

Bar Code Reader User's Manual

V500-R521B2

V500-R521C2

READ AND UNDERSTAND THIS DOCUMENT

Please read and understand this document before using the products. Please consult your OMRON representative if you have any questions or comments.

WARRANTY

OMRON's exclusive warranty is that the products are free from defects in materials and workmanship for a period of one year (or other period if specified) from date of sale by OMRON.

OMRON MAKES NO WARRANTY OR REPRESENTATION, EXPRESS OR IMPLIED, REGARDING NON-INFRINGEMENT, MERCHANTABILITY, OR FITNESS FOR PARTICULAR PURPOSE OF THE PRODUCTS. ANY BUYER OR USER ACKNOWLEDGES THAT THE BUYER OR USER ALONE HAS DETERMINED THAT THE PRODUCTS WILL SUITABLY MEET THE REQUIREMENTS OF THEIR INTENDED USE. OMRON DISCLAIMS ALL OTHER WARRANTIES, EXPRESS OR IMPLIED.

LIMITATIONS OF LIABILITY

OMRON SHALL NOT BE RESPONSIBLE FOR SPECIAL, INDIRECT, OR CONSEQUENTIAL DAMAGES, LOSS OF PROFITS OR COMMERCIAL LOSS IN ANY WAY CONNECTED WITH THE PRODUCTS, WHETHER SUCH CLAIM IS BASED ON CONTRACT, WARRANTY, NEGLIGENCE, OR STRICT LIABILITY.

In no event shall responsibility of OMRON for any act exceed the individual price of the product on which liability is asserted.

IN NO EVENT SHALL OMRON BE RESPONSIBLE FOR WARRANTY, REPAIR, OR OTHER CLAIMS REGARDING THE PRODUCTS UNLESS OMRON'S ANALYSIS CONFIRMS THAT THE PRODUCTS WERE PROPERLY HANDLED, STORED, INSTALLED, AND MAINTAINED AND NOT SUBJECT TO CONTAMINATION, ABUSE, MISUSE, OR INAPPROPRIATE MODIFICATION OR REPAIR.

SUITABILITY FOR USE

THE PRODUCTS CONTAINED IN THIS DOCUMENT ARE NOT SAFETY RATED. THEY ARE NOT DESIGNED OR RATED FOR ENSURING SAFETY OF PERSONS, AND SHOULD NOT BE RELIED UPON AS A SAFETY COMPONENT OR PROTECTIVE DEVICE FOR SUCH PURPOSES. Please refer to separate catalogs for OMRON's safety rated products.

OMRON shall not be responsible for conformity with any standards, codes, or regulations that apply to the combination of products in the customer's application or use of the product.

At the customer's request, OMRON will provide applicable third party certification documents identifying ratings and limitations of use that apply to the products. This information by itself is not sufficient for a complete determination of the suitability of the products in combination with the end product, machine, system, or other application or use.

The following are some examples of applications for which particular attention must be given. This is not intended to be an exhaustive list of all possible uses of the products, nor is it intended to imply that the uses listed may be suitable for the products:

- Outdoor use, uses involving potential chemical contamination or electrical interference, or conditions or uses not described in this document.

- Nuclear energy control systems, combustion systems, railroad systems, aviation systems, medical equipment, amusement machines, vehicles, safety equipment, and installations subject to separate industry or government regulations.
- Systems, machines, and equipment that could present a risk to life or property.

Please know and observe all prohibitions of use applicable to the products.

NEVER USE THE PRODUCTS FOR AN APPLICATION INVOLVING SERIOUS RISK TO LIFE OR PROPERTY WITHOUT ENSURING THAT THE SYSTEM AS A WHOLE HAS BEEN DESIGNED TO ADDRESS THE RISKS, AND THAT THE OMRON PRODUCT IS PROPERLY RATED AND INSTALLED FOR THE INTENDED USE WITHIN THE OVERALL EQUIPMENT OR SYSTEM.

PERFORMANCE DATA

Performance data given in this document is provided as a guide for the user in determining suitability and does not constitute a warranty. It may represent the result of OMRON's test conditions, and the users must correlate it to actual application requirements. Actual performance is subject to the OMRON Warranty and Limitations of Liability.

CHANGE IN SPECIFICATIONS

Product specifications and accessories may be changed at any time based on improvements and other reasons.

It is our practice to change model numbers when published ratings or features are changed, or when significant construction changes are made. However, some specifications of the product may be changed without any notice. When in doubt, special model numbers may be assigned to fix or establish key specifications for your application on your request. Please consult with your OMRON representative at any time to confirm actual specifications of purchased products.

DIMENSIONS AND WEIGHTS

Dimensions and weights are nominal and are not to be used for manufacturing purposes, even when tolerances are shown.

ERRORS AND OMISSIONS

The information in this document has been carefully checked and is believed to be accurate; however, no responsibility is assumed for clerical, typographical, or proofreading errors, or omissions.

PROGRAMMABLE PRODUCTS

OMRON shall not be responsible for the user's programming of a programmable product, or any consequence thereof.

COPYRIGHT AND COPY PERMISSION

This document shall not be copied for sales or promotions without permission.

This document is protected by copyright and is intended solely for use in conjunction with the product. Please notify us before copying or reproducing this document in any manner, for any other purpose. If copying or transmitting this document to another, please copy or transmit it in its entirety.

Meanings of Signal Words

In this manual, precautions are indicated using the following symbols and signal words to ensure safe use of the V500-R521B2/C2. The precautions indicated by these symbols and signal words are important for safety and must be observed.



WARNING

Indicates a potentially hazardous situation which, if not avoided, will result in minor or moderate injury, or may result in serious injury or death. Additionally there may be significant property damage.



CAUTION

Indicates a potentially hazardous situation which, if not avoided, may result in minor or moderate injury or in property damage.

Meanings of Alert Symbols



Indicates the possibility of laser radiation.



Indicates prohibition when there is a risk of minor injury from electrical shock or other source if the product is disassembled.



Indicates instruction for the user to always connect the ground wire.

For the Safety Use of Laser Products

- Warning display

WARNING

Avoid eye exposure to direct or scattered radiation reflected by a mirror surface.

Laser beam emitted from a laser has high power density and may become blind when the beam is directed into eyes.



Do not disassemble this bar code reader.

Laser beam may be scattered around when it is disassembled.



This Bar Code Reader uses a laser as the light source.

Lasers are classified on IEC standard (IEC 60825-1).

	V500-R521B2/R521C2
Wavelength	650 nm
Peak power	1 mW max.
Classification	2

Labeling on Laser Use

The Bar Code Reader has the following WARNING Label on the bottom.



A different set of regulations, European, IEC 60825 applies when exporting this product to Europe. Replace the warning label with the corresponding English label (supplied with this product.)

When using devices in which a Bar Code Reader is installed in the U.S., the product is subjected to the U.S. FDA (Food and Drug Administration) laser regulations. Replace the warning label with the corresponding English label (supplied with this product.)



Usage

- Use laser enclosure device to prevent specular object from reflecting laser beam.
When used without an enclosure, be sure to avoid a laser path from eye level.
- Although the safety distance (NOHD) is approximately 1 m; it is advisable, however, to terminate the laser on its path if possible. Nonreflective, flattening material is recommendable for termination.
- Wear protective glasses to protect against laser light during set up and adjustment.

Outline of IEC 60825-1 Standard

The following are the safety measures to be taken by the user for each type of laser equipment.

Classification Required items	Class 1	Class 2	Class 3A	Class 3B*	Class 4
Remote interlock	Not required			Connect to room or door circuits.	
Key control	Not required			Remove key when not in use.	
Beam attenuator	Not required			When in use prevents inadvertent exposure.	
Emission indicator device	Not required			Indicates laser is energized.	
Warning signs	Not required			Follow precautions on warning signs.	
Beam path	Not required	Terminate beam at end of useful length.			
Specular reflection	Not required			Prevent unintentional reflections.	
Eye protection	Not required			Required if engineering and administrative procedures not practicable and MPE exceeded.	
Protective clothing	Not required			Sometimes required.	Specific requirements.
Training	Not required		Required for all operator and maintenance personnel.		

* With respect to the requirements of remote interlock connector, key control, beam attenuator, emission indicator device, and eye protection, Class 3B laser products not exceeding five times the AEL of Class 2 in the wavelength range of 400 nm to 700 nm are to be treated as Class 3A laser products.

Precautions for Safe Use

Observe the following precautions to ensure safe use of the product.

■ Installation Environment Precautions

- Do not use the product in environments with flammable or explosive gases.
- Do not install the product close to high-voltage devices and power devices in order to secure the safety of operation and maintenance.
- During installation, make sure that screws are tightened firmly.

■ Power Supply and Wiring Precautions

- Use the product with the power supply voltages specified in this manual.
- Use a DC power supply with countermeasures against high-voltage spikes (safe extra low-voltage circuits on the secondary side).

 p.30

■ Other Precautions

- If the product becomes extremely hot, or abnormal odors or smoke occurs, stop using the product immediately, turn OFF the power, and consult with your OMRON representative.
- Dispose of the product as industrial waste.
- Do not apply pressure or deform the product when disposing of it.

Precautions for Correct Use

Always observe the following precautions to prevent operation failures, malfunctions, and adverse effects on performance and equipment.

1. Installation of the bar code reader

■ The bar code should be mounted in a place:

- where is not subject to direct sunlight (indoor use),
- without any corrosive gas, dust, metallic powder or salt content,
- where operation temperature does not exceed the specified range,
- where temperature change is not rapid, without dew condensation (within the specified value),
- where humidity change is not rapid, without dew condensation (within the specified value),
- where vibration or shock does not reach to the bar code reader directly (within the specified value),
- and without any droplet of water, oil or chemical agent.

2. Power supply

- Apply voltage to be +5 VDC $\pm 10\%$ at the connector of the bar code reader side.
- Used cable should be 0.3 mm² or equivalent, within 5 m. When the wiring is too long or resistance is too huge, voltage may be decreased due to fluctuation of consumption current of the bar code reader.
- Be careful so that noise or switching surge of relay is not applied on +5 V power voltage supplied to the bar code reader.
- To suppress influence such as noise, use direct current of insulation transformer, not auto transformer.

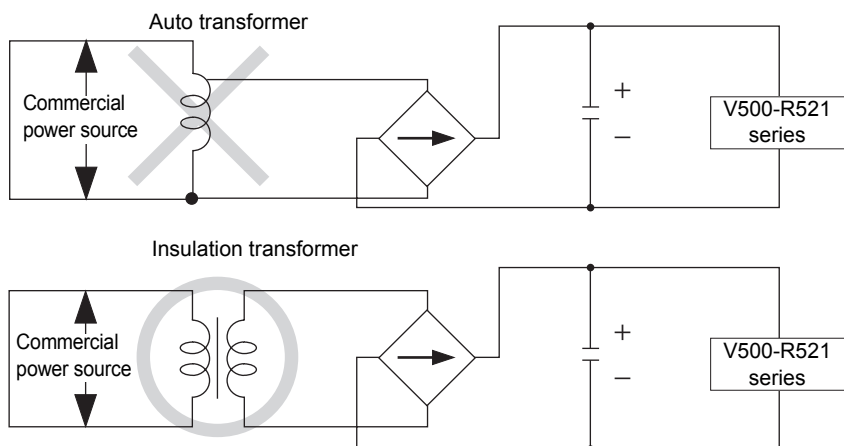

- When high frequency wave such as ultrasonic welding machine is used, insulate it using auxiliary insulation plate to avoid malfunction due to induction current.
- S82K-00705 (made by OMRON Corporation) is recommended for the driving power supply of the bar code reader.

3. Wiring

- Extension length of the RS-232C line (SD, RD, SG) should be up to 15 m.
- For trigger and power line, use a cable with 0.3 mm² or more and extension length should be up to 5 m.
- Wiring should avoid approaching to a high-power heavy electric current wire.
- Check the polarity of terminals and be careful of faulty wiring.
- Avoid reverse connection of power supply or connection to alternating current.
- Turn off the power switch before connecting or disconnecting a connector.
- Use a wrist strap etc. to avoid electrostatic charge when you touch terminals and signal lines, to avoid damage due to static electricity.

4. Installation

- When using the bar code reader, fix it to the associated mounting bracket.
- When inductive noise is generated at the mounting bracket, attach an associated insulation board. Use the associated screw to mount the insulation board.
- Incline the bar code reader about 15 ° to read the target bar code.
- Do not apply stress on the cable when mounting and using.
- Distance and angle allowed to read differs according the bar code. Check if the used bar code can be read actually, before mounting.

5. Timing input with photo-electronic sensor

When taking timing with the photo-electronic sensor, mount the bar code reader so that the footlight beam of the photo-electronic sensor does not spot directly on the reading window of the bar code reader or on the bar code.

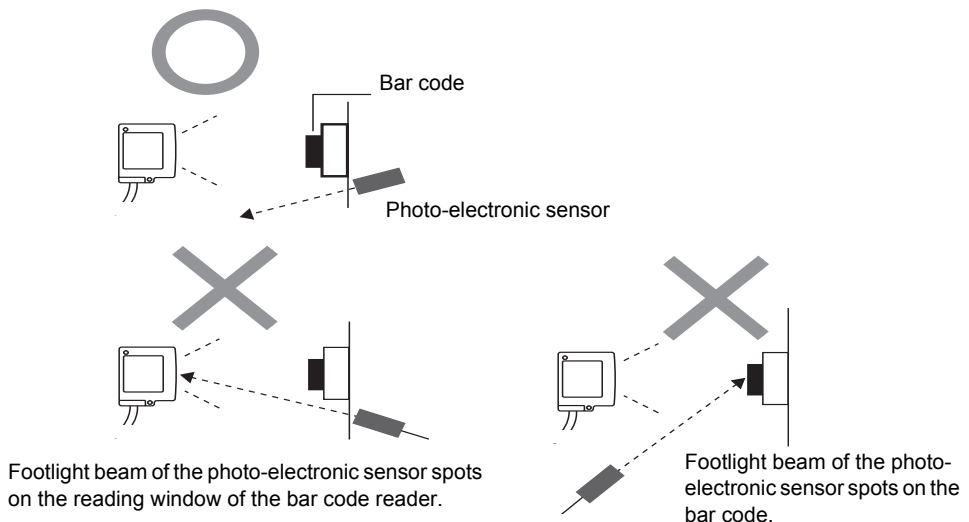

6. Influence of reflective objects

When there is any reflective object such as metal or mirror surface on the bar code beam-scanning surface, reading character may be deteriorate. Cover the reflective object with something or change the bar code position to avoid influence.

7. Mutual interference

When mounting the bar code readers side-by-side, laser beams may interfere reading each other. The bar code readers should be placed far enough not to affect reading.

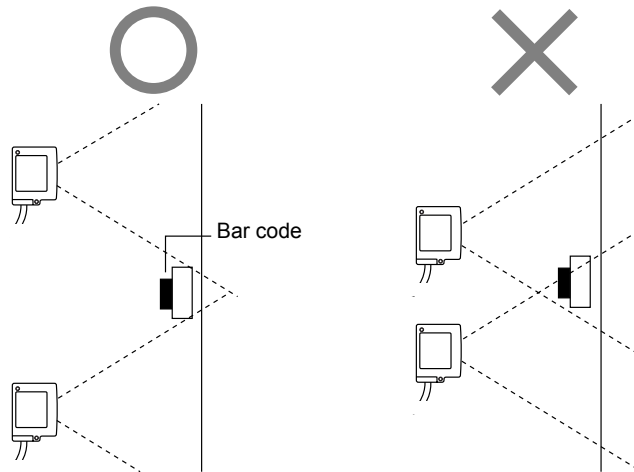

8. Bar code label

- The height of the bar code should be more than the raster scan width (max. 10 mm) and use a label considering attaching error.
- When reading bar code, margin is necessary on the both sides of the bar code. Set the label so that margin parts do not hide. A space of one character or more and 2.5 mm or more is necessary of both right and left side of the label. (Rough standard: 12 or 13 times or more of the narrow bar width)

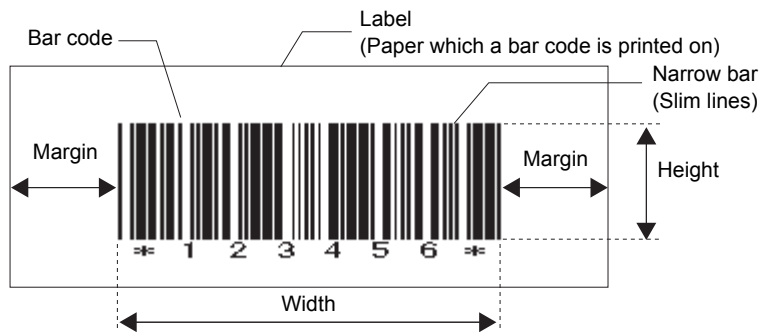

9. To improve reading reliability

- When the digit is determined, designate the digit to use the bar code.
- Use the modulus check (addition of check digit).
- Bar codes other than the reading object should be set to reading prohibition.

 p.61

10. Maintenance and check

- Check for any dust or dirt on the reading window regularly. When it is dirty, wipe with a dry, soft and clean cloth. Do not use solutions such as thinner.
- Handle with care, not to apply strong shock such as dropping.

How to Use This Manual

In this manual, each part of the bar code is described as follows.

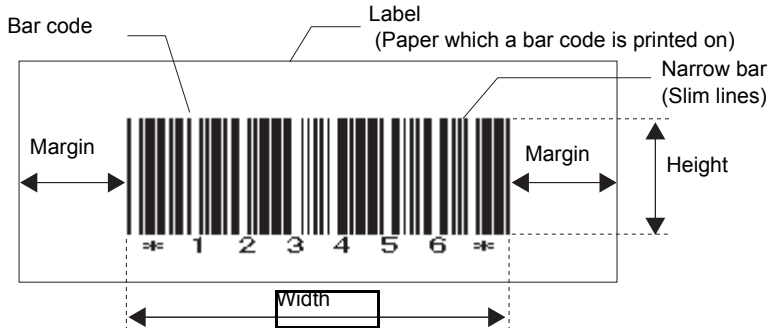

For a page format

Section 4 System Settings

Creating Setting Files Using the 2DCR Configear

Creates the data setting file for loading set data to the Handheld 2D Code Reader. Make the settings for the communications conditions, functions, and display conversion.

Select **Setting Reader - Create Data...** from the menu.
The following window for creating the setting data file will be displayed.

- Open**
Opens the previously created data setting file for editing. The [Receive (R)] function can be used to open the data file downloaded from the Code Reader and edit it.
- Save**
Saves the created data setting file.

CHECK!
To save data to the Memory Card, create a folder with the name SETTINGS, and save. If the data is saved to a folder other than "SETTINGS", it cannot be uploaded.

Communication Settings

The settings shown in the following table are set in the Communication Settings Tab Page in the Create Setting Data Window.

Setting Item	Settings
Baud Rate	9,600, 19,200, or 38,400
Parity	None, odd, or even
Data Length	77 bits or 8 bits
Stop Bit	1sbit* or 2 bits
Header/Footer	Prefix: None*, 02 <STX>, or 1B <ESC>
	Suffix: ETX, 0A LF, 0D CR , or 0D0A CR+LF
	FCS: ON or OFF *

The default settings are indicated with an asterisk.

V500-R521B2/C2 User's Manual 65

V500-R521B2/C2 User's Manual 69

Procedure and additional explanations

Information useful during the operation and reference pages are provided here with special marks to indicate the kind of information being provided.



*This page does not actually exist in this manual.

Visual Aids



Indicates points that are important in using product functions or in application procedures.

CHECK!



Indicates page numbers providing related information.



Indicates helpful information when a problem occurs and explanations of technical terms.

Contents

Introduction

Meanings of Signal Words	4
Meanings of Alert Symbols	4
For the Safety Use of Laser Products	5
Precautions for Safe Use	6
Precautions for Correct Use	7
How to Use This Manual	10
Visual Aids	11

Section 1 Product Overview 15

Features	16
Product Composition	18
Part Names	19
Rating/Performance	20
Usage Flow Chart	24

Section 2 Wiring and Installation 27

Wiring	28
Installation	32

Section 3 Function Explanation 35

Explanation of Reading System	36
Operation Flow Chart	38
Communication Data Format	46
Test Reading Function	49





Section 4	Setting Method	51
	How to Use Menu Sheet/Command	52
	Menu Sheet/Command List	56
Section 5	Example of System Configuration	87
	Example of Connection with a PC	88
	Example of Connection with Programmable Controller (CS1)	89
	Example of Multi-drop Connection	92
	How to Use Command Link Unit V700-L12	96
Section 6	Appendix	113
	External Dimension	114
	Troubleshooting	120
	ASCII Code Table	121
	Explanation of Terms	122
	Corresponding Bar Code List	127
	Revision History	132

MEMO

Section 1

Product Overview

This section explains about features and rating/performance of this bar code reader.

 Features	16
 Product Composition	18
 Part Names	19
 Rating/Performance	20
 Usage Flow Chart	24

Features

A bar code reader is a device to read a bar code attached on a product and transfer the information to upper equipment.

Various types of information can be managed efficiently by using it combining with PC and programmable controllers.

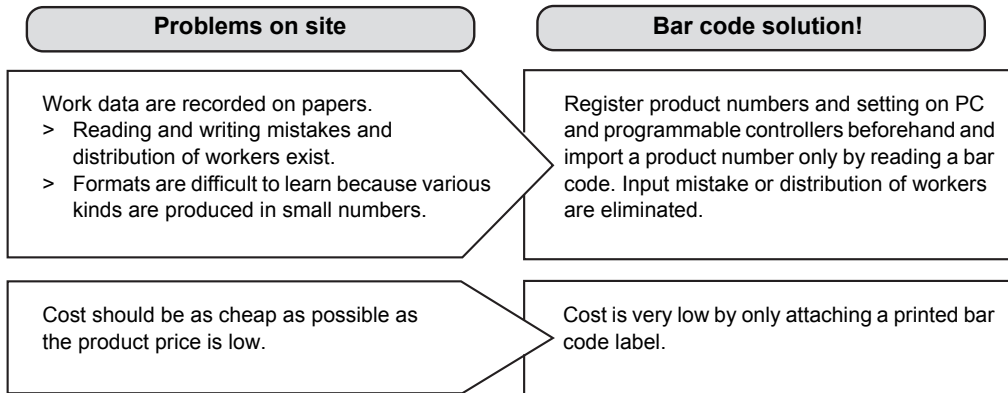

▪ Ultra-compact design

Optimum for the assembly to each device

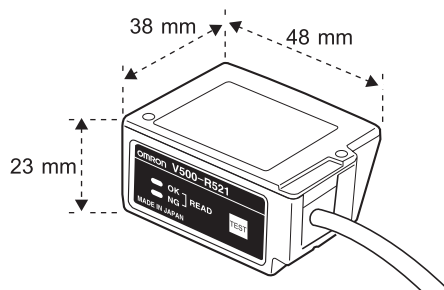

▪ Easy installation

Easy to read by pressing the TEST button and know the reading rate with LED illumination and buzzer sound in real time.

As reading position is easy to check at site before connecting with upper equipment, installation work and maintenance work hour can be greatly reduced.

p.49

▪ Simple function setting

You can either set the function by reading a menu sheet or by inputting a command on the upper equipment. You can select the setting method according to the condition.

p.52

- Perfect reading performance

High speed reading with 500 scan/sec. realized high reliability and wide reading distance of 60 mm to 270 mm (in case of narrow bar width 1.0 mm).

 p.21

- Easy multi-drop

Connect communication link unit V700-L12 to collect read data from plural bar code readers (max. 31) for one set of upper equipment.

 p.92

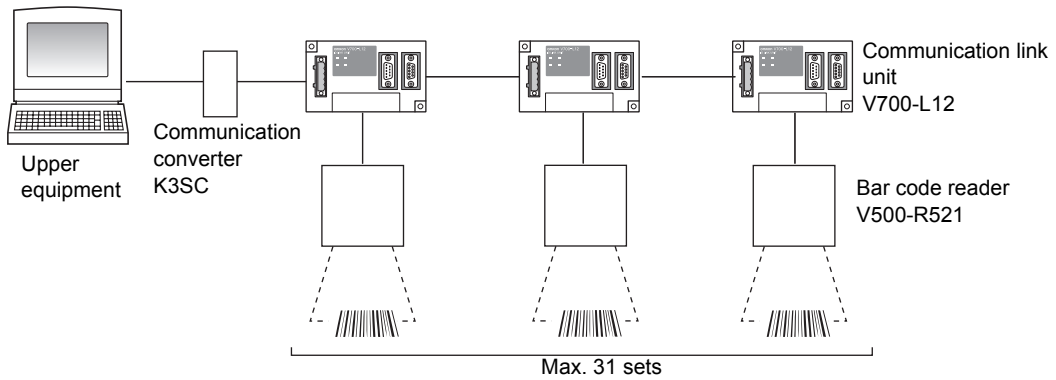

Product Composition

The bar code reader is used by connecting with upper equipment such as PC and programmable controllers.

The upper equipment receives information which the bar code reader reads and refers with the registered information and records.

There are two types in V500-R521 differing in connector shape as follows. Select according to connecting upper equipment.

V500-R521B2 (Cable output type)

Tip of the cable is loose end.

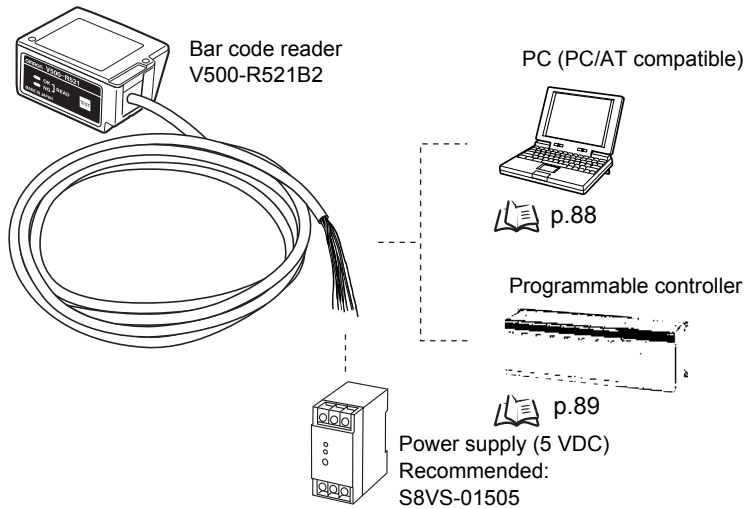

V500-R521C2 (Connector output type)

Tip of the cable is a connector. Use an appropriate connecting cable according to the upper equipment.

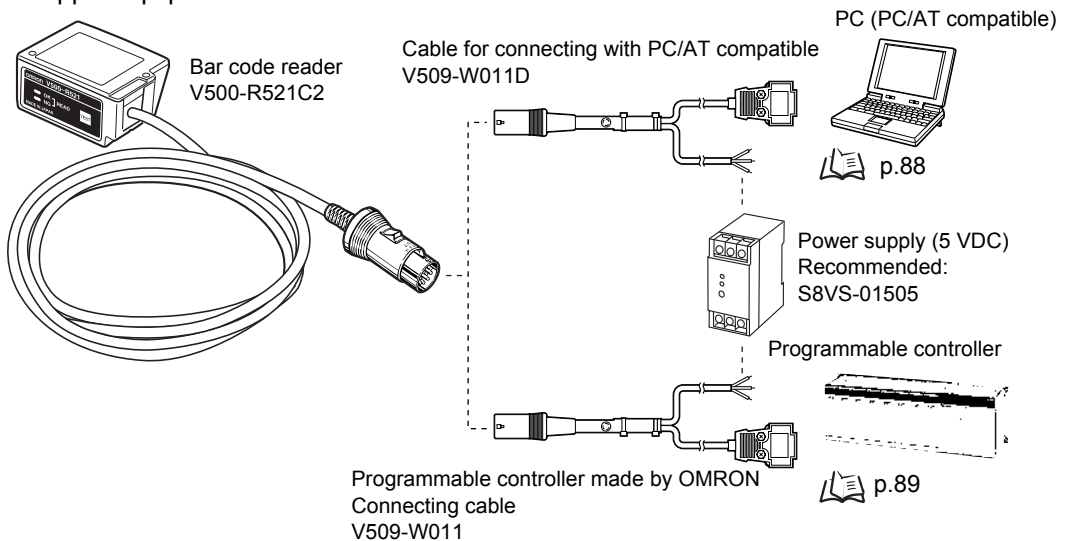

Part Names

Front side

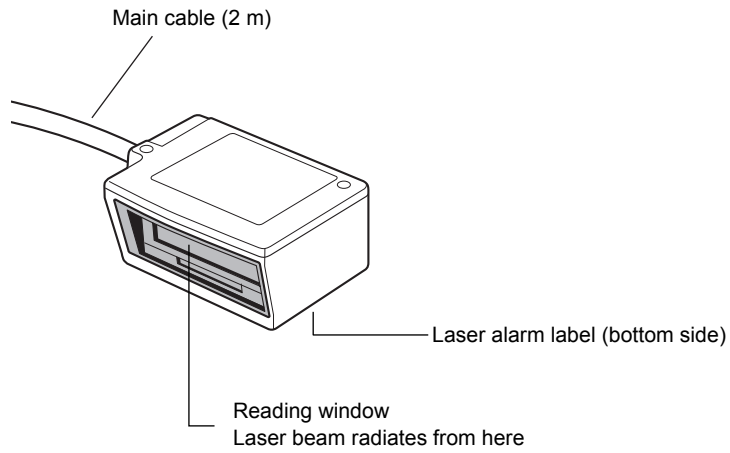

Back side

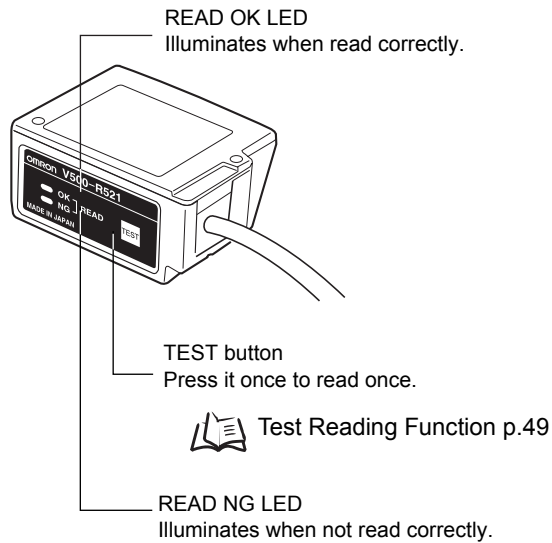

Rating/Performance

General specification

Applicable bar code	Types of bar code	EAN/UPC (A, E), CODE39, NW-7, ITF STF (2 of 5 bar), CODE93, CODE128 (including EAN128)
	Number of reading digits	32 digits MAX (Changes according to bar width and reading size)
Reading performance (*1)	Resolution	0.15 mm (at PCS 0.9)
	Contrast (PCS)	0.45 or more (white reflectance 70 % or more)
	Reading distance	60 to 270 mm (At narrow bar: 1.0 mm)
	Reading angle	Within 40 ° (Including margins at left and right sides)
	Skew angle	±50 ° (However, exclude from 10 ° upper side to 5 ° lower side)
	Pitch angle	±25 ° (Left and right 25 °)
	Light source	Red semiconductor laser (Wave length: 650 nm)
	Light output	1.0 mW or less (Correspond to JIS class 2)
	Scan type	Raster scan
	Number of scan	500 scan/sec.
	Number of reading coincidence	2 to 6 times (Verification: 1 to 5 times)
	Reading check	Buzzer sound, indication LED
Interface	Communication specification	RS-232C
	OK/NG output (Only V500-R521B2)	NPN open collector output 24 VDC, 30 mA
Function set method	Menu sheet reading method or host command method	
Reading trigger	External trigger (Transistor input)	
	Trigger by command (RS-232C)	
	Trigger a test reading by pressing the TEST button on the product	
Reading result output	RS-232C output	Reading data output
	OK/NG signal (Only V500-R521B2)	OK signal is turned on when reading succeeded NG signal is turned on when reading failed
	Indication LED	OK LED illuminates when reading succeeded NG LED illuminates when reading failed
	Buzzer	Notifies a successful reading with a buzzer sound (Muting available)
Power supply specification	Power voltage	5 VDC ±10 % (*2)
	Consumption current	220 mA typ. (330 mA MAX)
	Inrush current	2.5 A MAX
Environment	Ambient temperature	At operation: 0 to + 45 °C; At storage: -10 to + 60 °C
	Ambient humidity	At operation and storage: 30 to 85 % RH (Without due condensation)
	Vibration resistance	12 to 100 Hz 19.6 m/s ² (2G) X, Y, Z, 3H each
	Ambient light resistance	3000 lx or less (Fluorescent lamp. Excluding inverter florescent lamp.)
Enclosure rating	IP54 (IEC60529 Standard)	
Mass	80 g (Excluding cables and connectors)	
Input/output connector	V500-R521B2: Cable output	
	V500-R521C2: DIN 8 pin connector	
Code length	2 m	

- *1 Unless otherwise specified, use a bar code of EAN 1x, MRD 63 % or more (PCS = 0.9 or more).
Specified at a condition of pitch angle $\alpha = 0^\circ$, skew angle $\beta = 0^\circ$, tilt angle $\gamma = 0^\circ$, curvature $R = \infty$
- *2 Power voltage is specified at the input/output connector end of the bar code reader side.

Number of reading range performance

Explained with examples of following conditions:

- Contrast: MRD 63 % (PCS = 0.9)
- Bar code: CODE39
- Installation condition: Pitch angle $\alpha = 0^\circ$, skew angle $\beta = 15^\circ$
Tilt angle $\gamma = 0^\circ$, curvature $R = \infty$

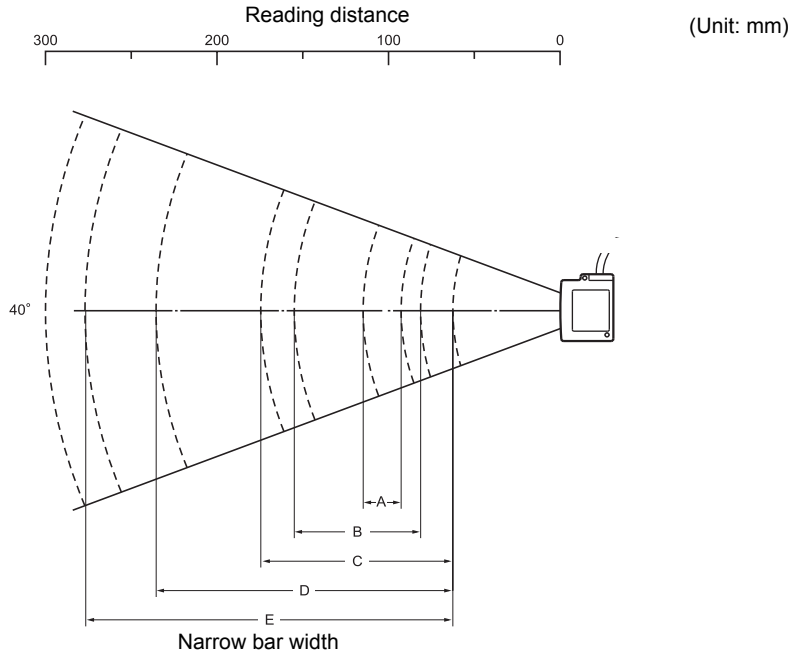

Narrow bar width		Reading distance (*1)
A	0.15 mm (*2)	90 to 110 mm (*2)
B	0.2 mm	80 to 150 mm
C	0.25 mm	60 to 170 mm
D	0.5 mm	60 to 230 mm
E	1.0 mm	60 to 270 mm

*1 Distance from the end of the case.

*2 Value at a reading angle 30° .

Reading angle performance

■ Pitch angle

In the following conditions, readable up to $\alpha = 25^\circ$ on either side.

- Bar code: Resolution = 0.25 mm, CODE39 (9 digits), MRD 63 % (PCS = 0.9)
- Reading distance: 100 mm from the case end
- Installation condition: Skew angle $\beta = 15^\circ$, tilt angle $\gamma = 0^\circ$, curvature $R = \infty$

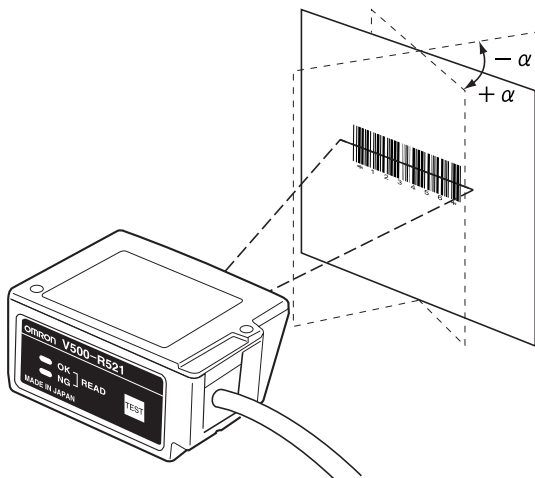

■ Skew angle

In the following conditions, readable up to $\beta = \pm 50^\circ$. However, range from $\beta = -10$ to $+5^\circ$ is an area difficult to read due to regular reflection.

- Bar code: Resolution = 0.25 mm, CODE39 (9 digits), MRD 63 % (PCS = 0.9)
- Reading distance: 100 mm from the case end
- Installation condition: Pitch angle $\alpha = 0^\circ$, tilt angle $\gamma = 0^\circ$, curvature $R = \infty$

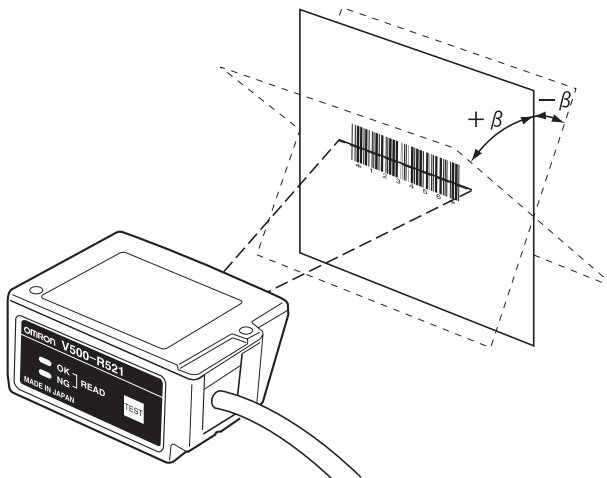

■ Tilt angle

Generally, a tilt angle is not specified, because it differs according to the bar code height.

Scan all the bar code with the laser.

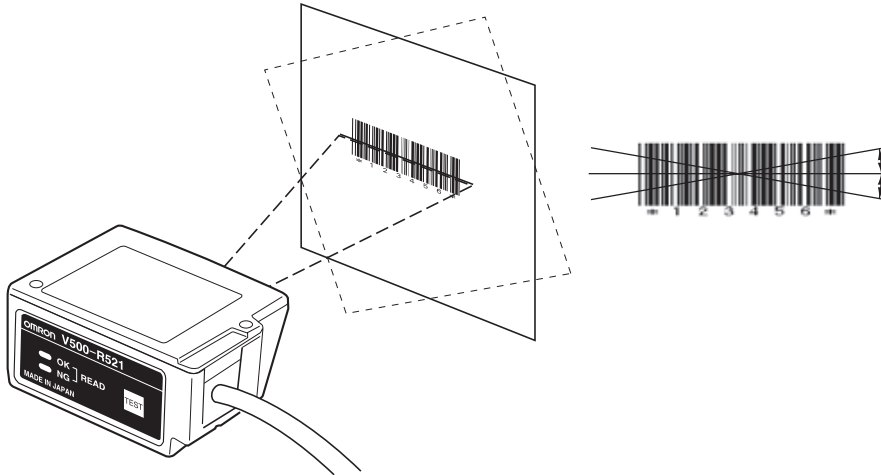

■ Curvature

In case of the following conditions, the bar code of 8-digit EAN, curvature range 15 mm or more and 13-digit EAN, curvature range 20 mm or more can be read.

- Bar code: Resolution = 0.26 mm, EAN, MRD 63 % (PCS = 0.9)
- Reading distance: 100 mm from the case end
- Installation condition: Pitch angle $\alpha = 0^\circ$, skew angle $\beta = 15^\circ$, tilt angle $\gamma = 0^\circ$

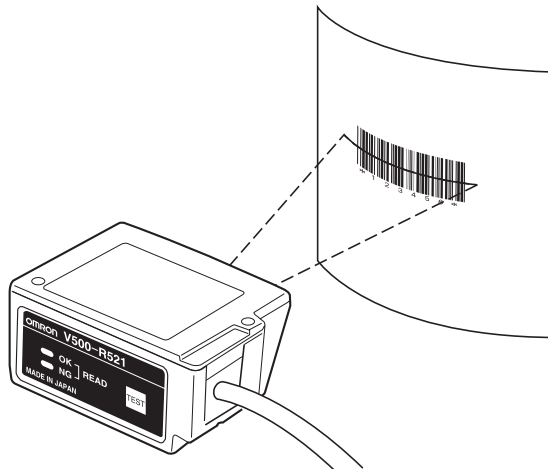

Usage Flow Chart

Examination of the bar code beforehand, installation, and introduction flow chart is as shown below.

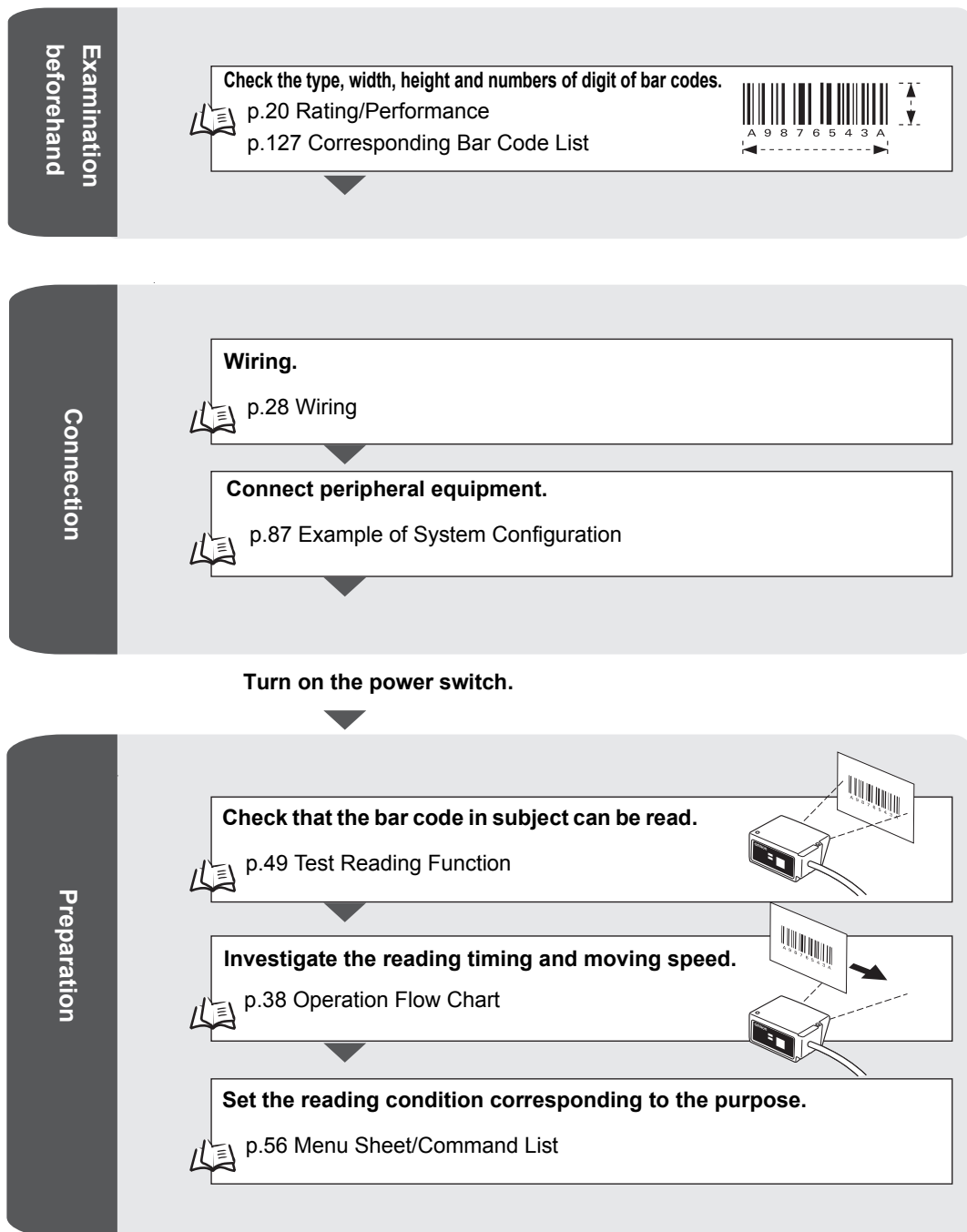

Execution of reading

Installation -

Install.



p.32 Installation

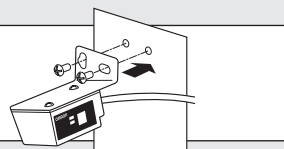

Test in the actual usage environment.



p.49 Test Reading Function

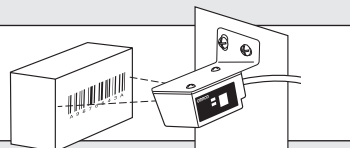

Execute reading.

Applied way
of using

Read only the registered bar code.



p.83 Setting related to sorting read

In case of trouble:



A bar code cannot be read correctly.



p.120 Troubleshooting



I don't know the communication specification.



p.46 Communication Data Format



I can't understand the operation flow.



p.38 Operation Flow Chart

MEMO

Section 2

Wiring and Installation

This section explains about the wiring method and installation method of the bar code reader.

 Wiring	28
 Installation	32

Wiring



- Extension length of the RS-232C line (SD, RD, and SG) should be up to 15 m.
- For trigger and power line, use a cable with 0.3 mm² or more and extension length should be up to 5 m.
- Wiring should avoid approaching to a high-power heavy electric current wire.
- Check the polarity of terminals and be careful of faulty wiring.
- Avoid reverse connection of power supply or connection to alternating current.
- Do not use exceeding rating voltage.
- Turn off the power switch before connecting or disconnecting a connector.
- Use a wrist strap etc. to avoid electrostatic charge when you touch terminals and signal lines, to avoid damage due to static electricity.

Wiring diagram

■ V500-R521B2 (Cable output type)

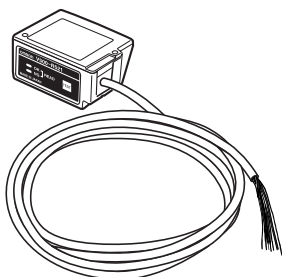

Wiring color	Signal name	Function	Signal direction	
			Bar code reader	Upper equipment
Brown	TRIG	External trigger signal	←	→
Yellow	OK	READ OK signal	→	←
Orange	NG	READ NG signal	→	←
Blue	CS	Transmission allowed	←	→
Gray	RS	Transmission request	→	←
White	RD	Received data	←	→
Green	SD	Transmission data	→	←
Red	VCC	Power supply	←	External
Black	S.GND	0 V (Signal ground)	←	External
Shield (FG)	F.GND	FG (Frame ground)	→	←

Connection with upper equipment p.88, p.89



Logic of external trigger signal can be selected.

Positive logic (HIGH active)	Trigger ON
Negative logic (LOW active)	Trigger ON

Setting method p.57

You can select the output logic of READ OK and READ NG signal.

System	Description
Trigger signal synchronous system	Maintains ON condition until the next trigger is input. You can select positive logic/negative logic.
One-shot system	READ OK/NG signal is turned on during the preset time (one-shot time). One-shot time can be set from 10 to 100 ms (in 10 ms interval). You can select positive logic/negative logic.

Setting method p.75

■ V500-R521C2 (Connector output type)

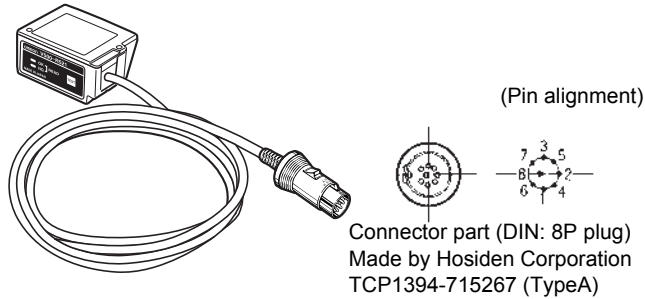

Pin No.	Signal name	Function	Signal direction	
			Bar code reader	Upper equipment
1	SD	Transmission data	←	→
2	RD	Received data	←	→
3	RS	Transmission request	←	→
4	CS	Transmission allowed	←	→
5	TRIG	External trigger signal	←	→
6	NC	Not connected		
7	S.GND	0 V	←	→
8	VCC	Power supply	←	→

Connection with upper equipment p.88, p.89

When you make a connection cable, use the following connectors.

Recommended parts for the connector

Usage	Manufacturer	Model
For cable relay	Hosiden Corporation	TCS8587-0170477
For panel installation 2	Hosiden Corporation	TCS1080-0120177



Logic of external trigger signal can be selected.

Positive logic (HIGH active)	Trigger ON
Negative logic (LOW active)	Trigger ON

Setting method p.57

You can select the output logic of READ OK and READ NG signal.

Power supply

Recommended parts for the power supply

Manufacturer	Model
OMRON Corporation	S8VS-01505

Input/output circuit

- Input circuit for the external trigger signal (Common to V500-R521B2/V500-R521C2)

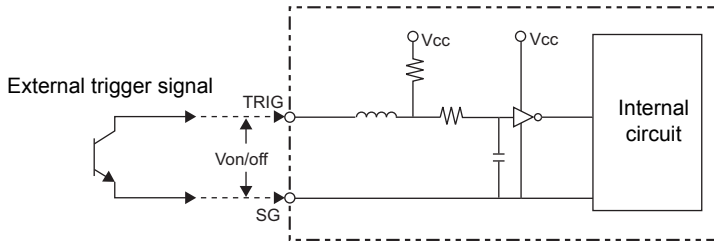

Item	Minimum value	Maximum value
Terminal voltage Von when a transistor is turned on	0 V	1.3 V
Terminal voltage Voff when a transistor is turned off	2.5 V	Vcc

- Output circuit of the READ OK/NG signal (Only V500-R521B2)

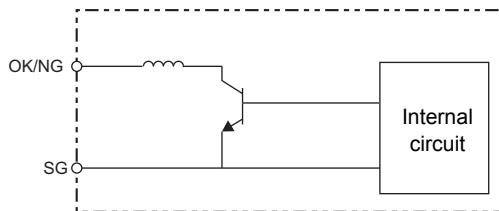

Item	Specification
Output system	NPN open collector
Rated load	24 VDC 30 mA
Leak current at OFF	0.5 mA or less
Residual voltage at ON	1.0 V or less

Cable specification

- Shape: Straight cable
- Diameter: $\phi 3.8 \pm 0.5$ mm
- Length: 2000 ± 50 mm
- Number of core: 9

Installation

To avoid regular reflection of laser, incline approx. 15 ° against the bar code subject to read when installing the bar code reader. Use this mounting bracket as the mounting surface of an associated mounting bracket is inclined 15 °. (Tightening torque 0.54 N/m)

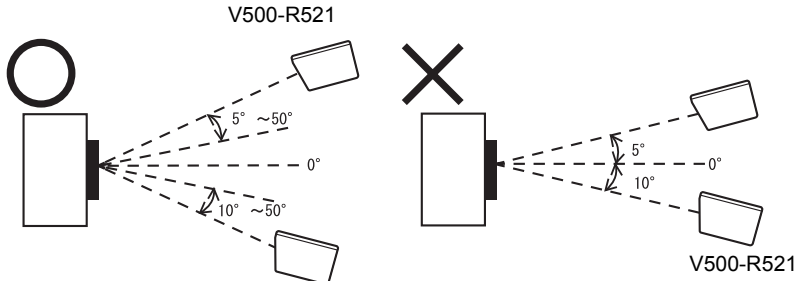

1. Attach the mounting bracket on the bar code reader.

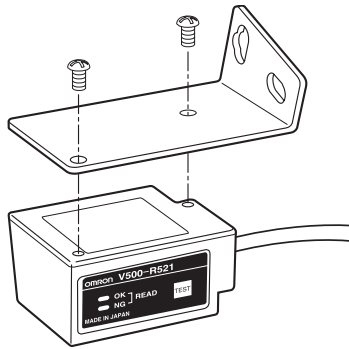

2. Install.

When you attach this line of the bracket horizontally, the bar code reader inclines 15 °.

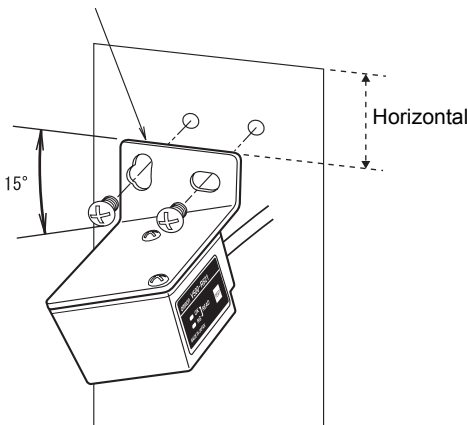

When you attach this line of the bracket vertically, the bar code reader inclines 15 °.

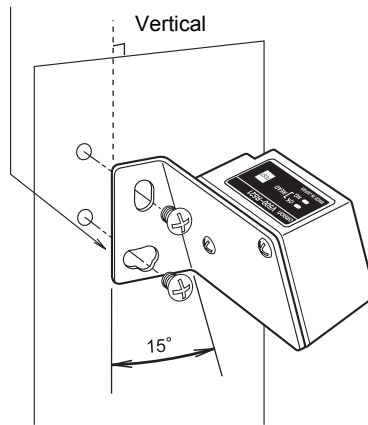

- When inductive noise is generated at the mounting bracket, attach an associated insulation board. Use the associated screw to install the insulation board.
- Do not apply stress on the cable when installing or using.
- Distance and angle allowed to read differs according the bar code. Check if the used bar code can be read actually, before installing.

External dimension

■ Mounting bracket (accessory)

Material: SUS304

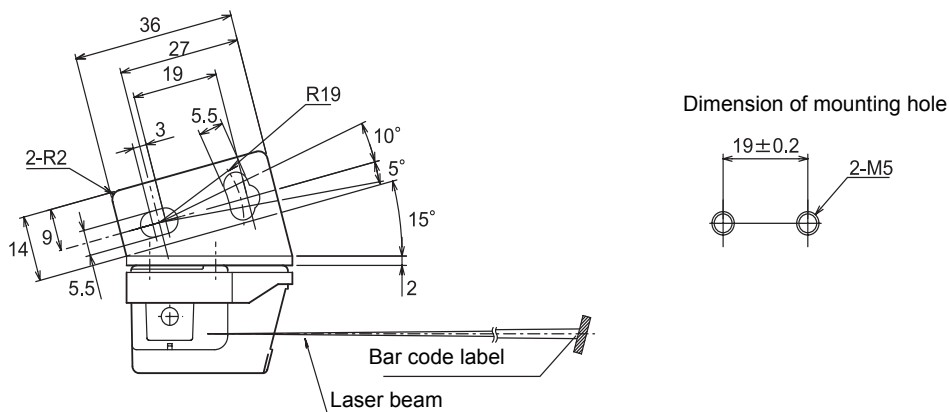
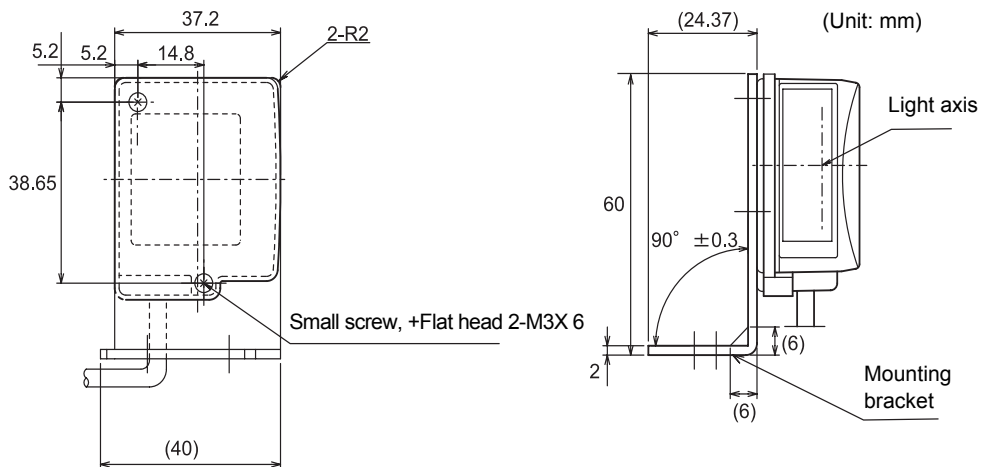

■ Insulation board (accessory)

Material: Fabric bake

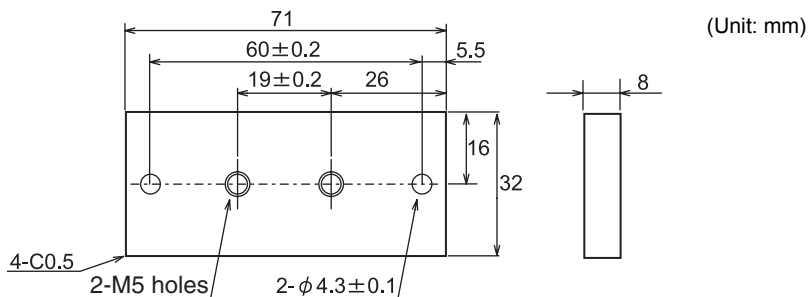

When the associated mounting bracket and insulation board are not used, install it by referring to the outline dimension figure.





p.114

MEMO

Section 3

Function Explanation

This section explains about representative functions of the bar code reader.

 Explanation of Reading System	36
 Operation Flow Chart	38
 Communication Data Format	46
 Test Reading Function	49

Explanation of Reading System

There are following reading systems for this bar code reader.

 Setting method p.67

Reading system		Trigger reading	Full-time reading
		Reading starts by applying reading trigger from outside. This system is mainly used when operation.	During the power is turned on, laser is radiated all the time, to be able to read any time. This system is mainly used at installation and system testing.
Trigger Input method	External trigger signal	When the external trigger signal is turned on, laser radiates and starts reading. The "Trigger controlled system" reads during the trigger is ON, and the "Effective duration designation system" reads only the effective duration (*1) which is set beforehand after the trigger is ON.	– (Ignored even when input.)
	RS-232C command	The upper equipment sends the communication command and the laser beam radiates to start reading. After receiving the command, it reads only for the effective duration (*1) which is set beforehand.	– (Ignored even when input.)
	TEST button (Back side)	Press the TEST button once to read once. Handy to use to check if the reading condition setting is appropriate.	– (Ignored even when pressed.)
Reading operation (*2)	Single reading	When the reading succeeds, the data is output and ends reading automatically.	Reads continuously and outputs the data continuously.
	Plural reading	Reads bar codes continuously during the trigger is ON or effective duration (*1). When the first reading is completed, data is once output and while reading the same bar codes continuously, no output is made. Outputs newly only when the data differ from the adjacent bar code.	The bar code reading continues in series. While reading the same bar code, output is not newly made. Outputs newly only when the data differ from the adjacent bar code.
	Continuous reading	Reads bar codes continuously during the trigger is ON or effective duration (*1). Outputs data continuously even for the same bar code.	Reads continuously and outputs the data continuously.

*1 Effective duration of reading

When the trigger input method is external trigger signal effective duration designation system or RS-232C command, effective duration setting is required beforehand. Effective duration is set by combining "effective duration" from 0 to 10 sec. and "minor setting" from 0 to 750 ms.

E.g. 1: When you want to set the effective duration to 2.5 sec., set the effective duration to 2 sec. and the minor setting to 500 ms.

E.g. 2: When you want to set the effective duration to 0.7 sec., set the effective duration to 0 sec. and the minor setting to 700 ms.

E.g. 3: When you want to set the effective duration to 10.0 sec., set the effective duration to 10 sec. and the minor setting to 0 ms.

 Effective duration setting method p.70

*2 Reading operation

Presence of the READ OK/NG signal output differs according to the reading operation setting.

(READ OK/NG signal output is only for V500-R521B1)

In case of single reading and plural reading:

When reading succeeded: OK signal is output.

When reading failed: NG signal is output.

In case of continuous reading:

OK or NG signal after reading is not output.

 READ OK/NG signal output p.28

Operation Flow Chart

Basic operation flow chart

This clause explains steps of "Power on > Reading > Data output" in case of trigger reading.

■ In case of single reading

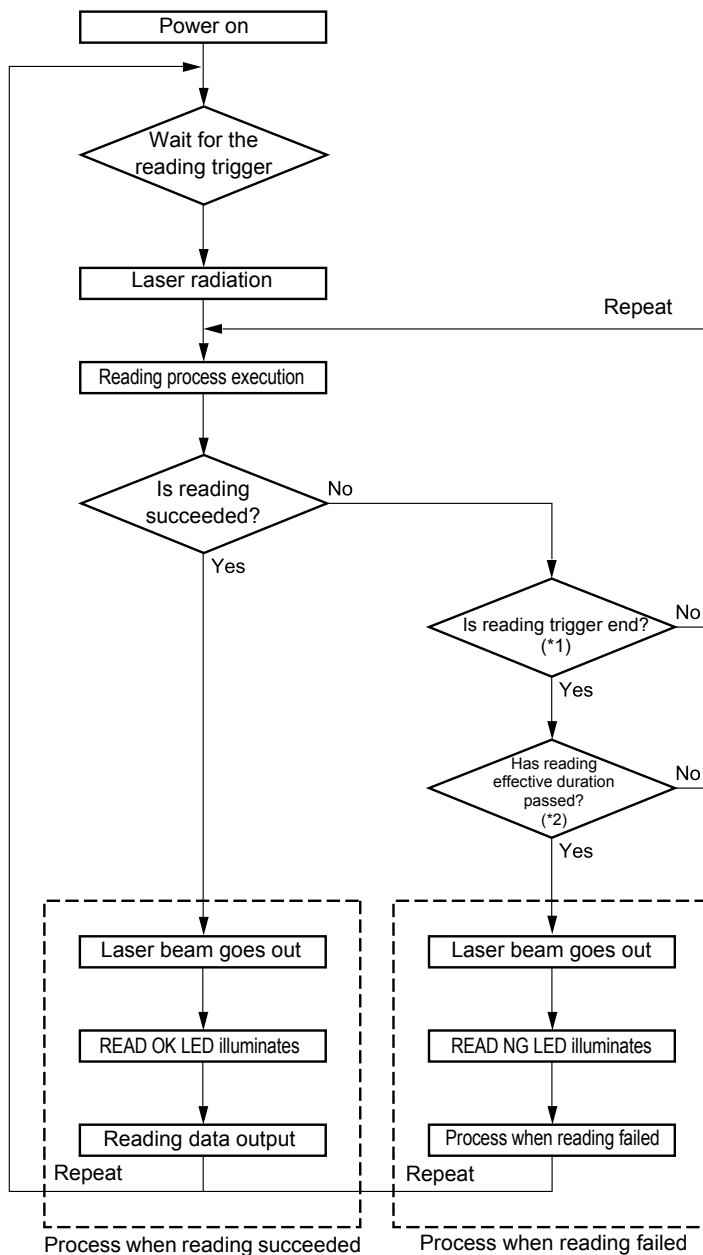

*1 When the trigger by a command is used, ignore this clause.

*2 In case of trigger controlled system (reads while the trigger is ON), consider that the reading effective duration is set to 0.

■ In case of plural reading

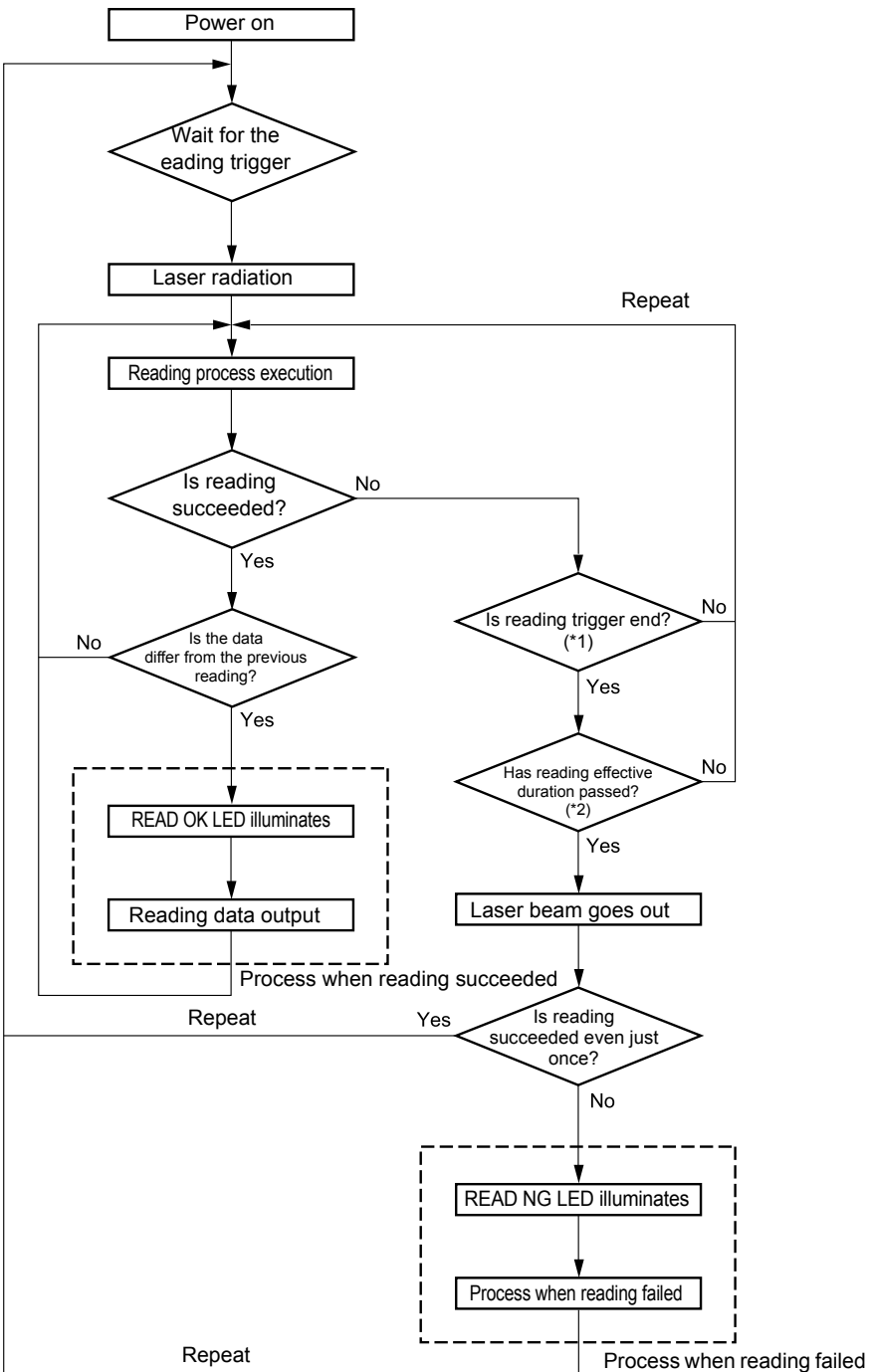

*1 When the trigger by a command is used, ignore this clause.

*2 In case of trigger controlled system (reads while the trigger is ON), consider that the reading effective duration is set to 0.

■ In case of continuous reading

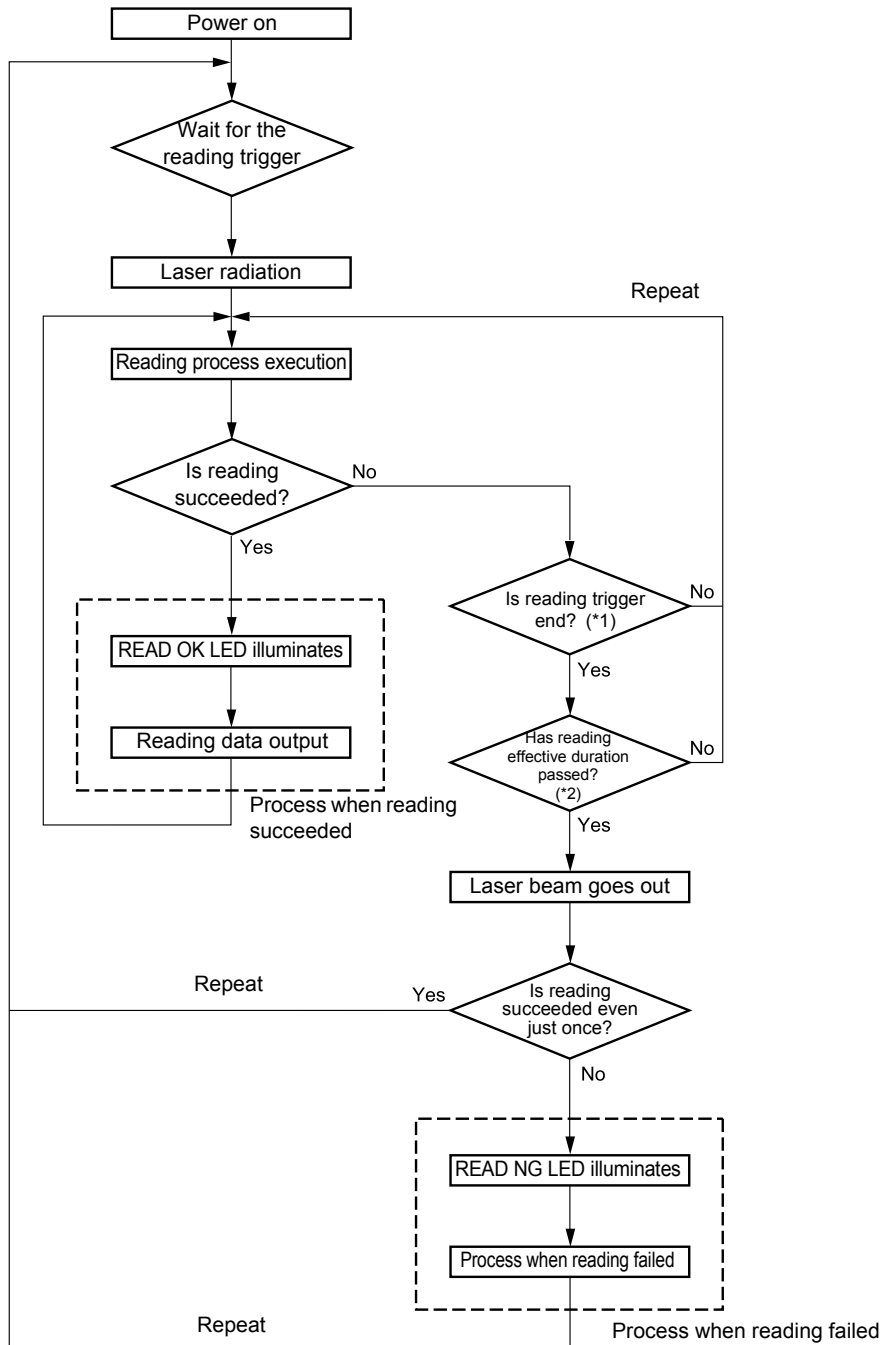

*1 When the trigger by a command is used, ignore this clause.

*2 In case of trigger controlled system (reads while the trigger is ON), consider that the reading effective duration is set to 0.

Communication protocol

There are following two types of system to transmit the data read by the bar code reader to the upper equipment.

■ Nonprocedural system (no protocol system)

The bar code reader transmits the data to the upper equipment and ends.

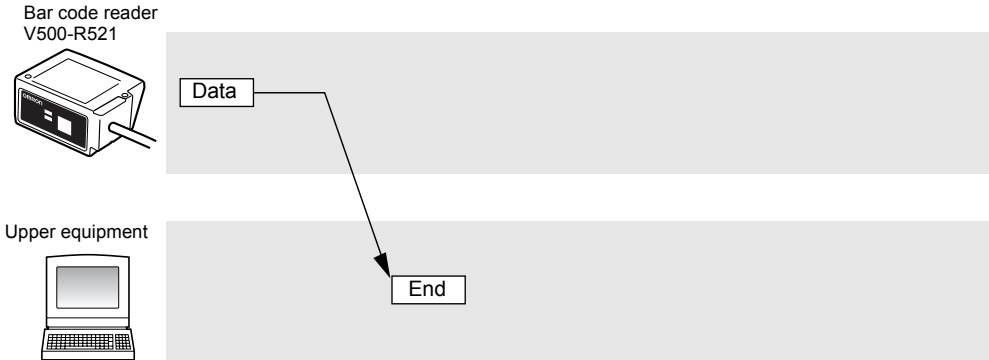

■ ACK/NAK system

This bar code reader waits for the upper equipment response after transmitting the data. When ACK (06H) 1 byte is received from the upper equipment, buzzer sounds indicating the normal finishing and ends data transmission.

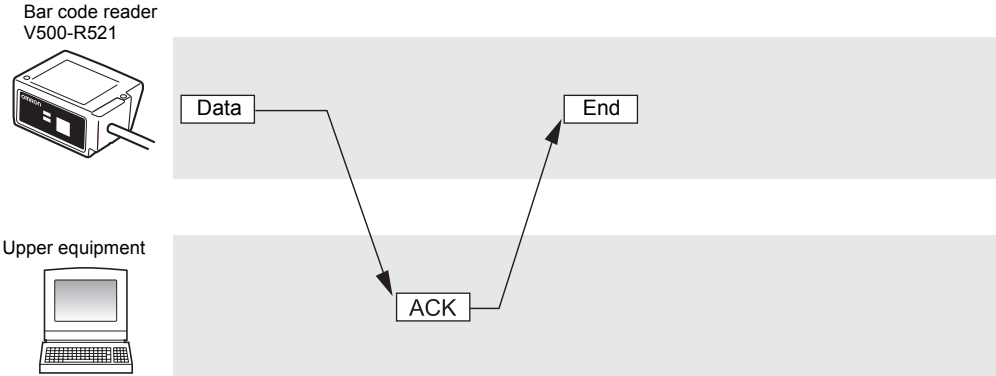

When NAK (15H) 1 byte is received from the upper equipment data is transmitted again. When the time-up time comes which is set beforehand, the time-up buzzer sounds and the data transmission ends.

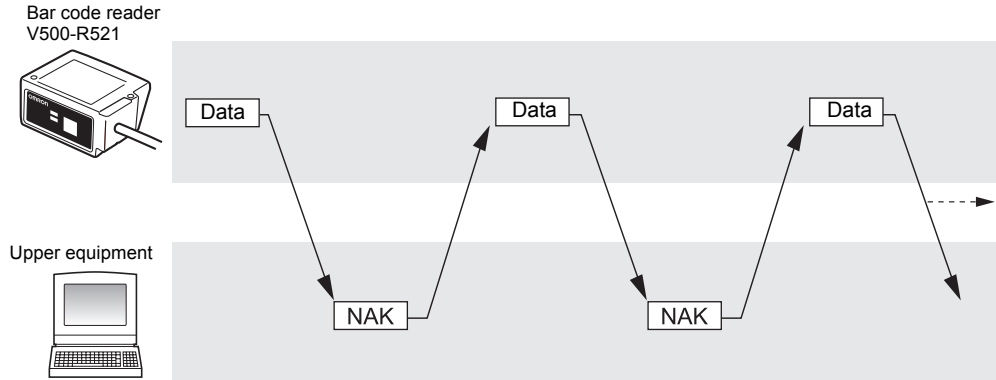

Communication timing chart

This section explains the indication timing of the buzzer and LED indication.

■ In case when reading OK (single reading)

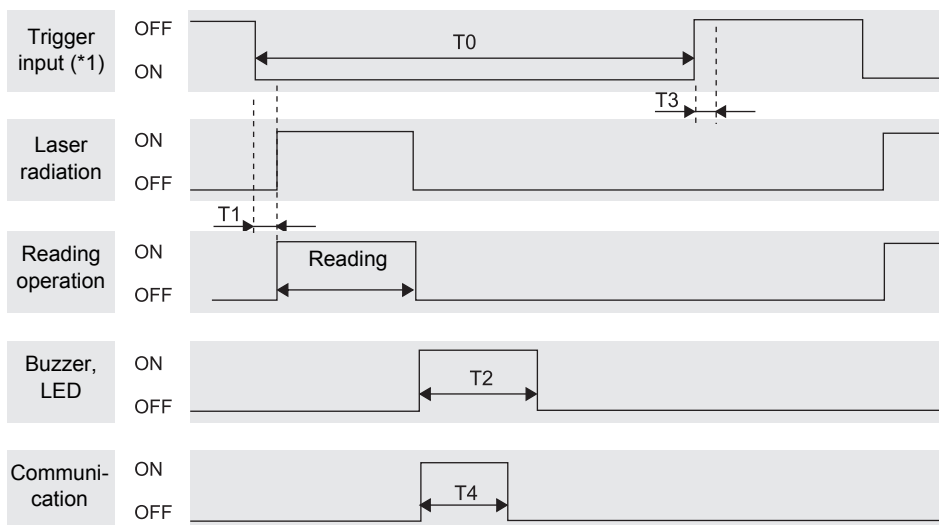

*1 You can change the setting for the trigger input logic.

p.53

Time	Description
T0	Trigger ON time. (When effective duration is designated, consider it as effective duration.)
T1	Chattering prevention time. (5 ms)
T2	Buzzer and indication LED illumination time. (Initial value: 200 ms, changing allowed)
T3	Trigger signal minimum OFF time. Be sure to set 30 ms or more.
T4	Communication time. Differs according to communication condition.



CHECK!

- In case of continuous reading and plural reading, laser is always radiating during trigger input is ON (or during reading effective duration). Concept of T0 to T4 other than this is the same as the case of single reading.
- A rough guide of reading time
As this bar code reader is approx. 500 decode/sec., decode process time for once is 2 ms. In case of plural time conformance, "2 ms x (conformance time + 1)". However, it differs according to the reading bar code condition (dirt or thin spot, etc.)
- Concept of communication time

$$\text{Communication time (ms)} = \frac{(\text{Data length}) + (1: \text{In case when parity exists}) + (\text{Number of stop bit})}{(\text{Communication speed})} \times \frac{(\text{Number of digit of transmission data} + \text{Number of header characters} + \text{Number of footer characters}) \times 10^3}{1}$$

■ In case when reading NG (single reading)

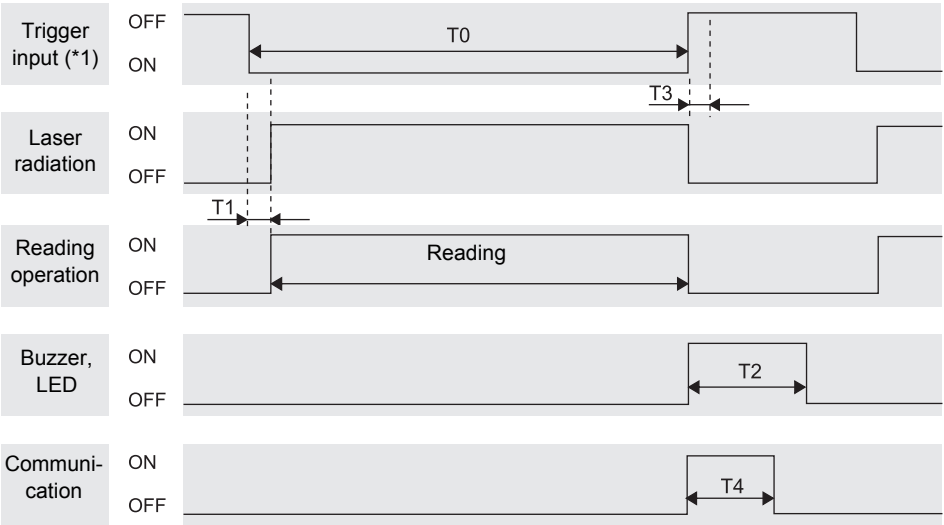

*1 You can change the setting for the trigger input logic.

p.57

Time	Description
T0	Trigger ON time. (When effective duration is designated, consider it as effective duration.)
T1	Chattering prevention time (5 ms)
T2	Buzzer and indication LED illumination time. (Initial value: 200 ms, changing allowed)
T3	Trigger signal minimum OFF time. Be sure to set 30 ms or more.
T4	Communication time. Differs according to communication condition.



- In case of continuous reading and plural reading, laser is always radiating during trigger input is ON (or during reading effective duration). Concept of T0 to T4 other than this is the same as the case of single reading.
- Concept of communication time

$$\text{Communication time (ms)} = \frac{(\text{Data length}) + (1: \text{In case when parity exists}) + (\text{Number of stop bit})}{(\text{Communication speed})} \times (\text{Number of digit of transmission data} + \text{Number of header characters} + \text{Number of footer characters}) \times 10^3$$

Concept of moving direction/line speed

When reading a moving bar code, fully investigate from the following viewpoint.

■ Confirmation of the timing chart

Duration from the reading trigger and outputting the data of actual reading differs according to condition.

 Operation Flow Chart p.38

■ Confirmation of trigger input timing

When constructing the system to read the moving bar code, input timing of the external trigger signal is important. Input the external trigger signal allowing enough timing considering the moving speed (moving distance) of the bar code.

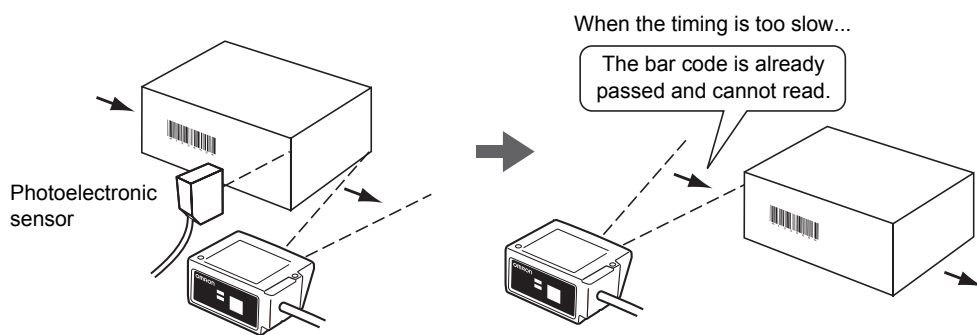

■ Checking the tack timing

In case when bar codes come continuously, calculate how close the bar codes may come, considering above two points.

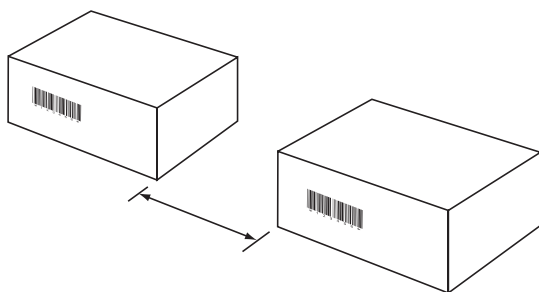

■ Moving direction of a bar code

Stability of reading differs according to the moving direction against the scanning direction.

As the appropriate direction differs according to the size of a label, investigate when installing.

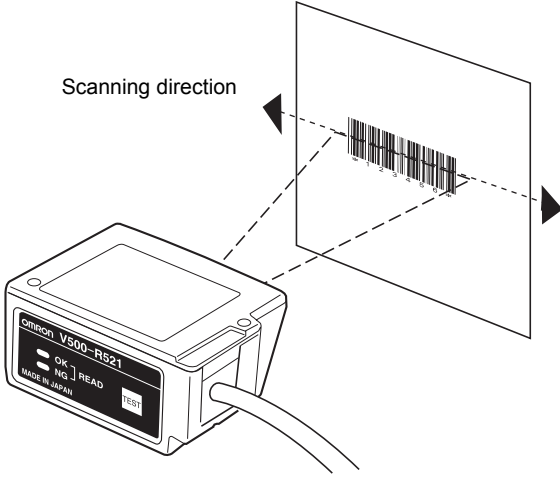

Bar code moving direction	Scanning range
	 <p data-bbox="960 1043 1221 1159">Whole height of a bar code is scanned. In case of tall size label, this direction is stable.</p>
	 <p data-bbox="1042 1294 1221 1468">A part of the height of a bar code is scanned. In case of short size label, this direction is stable.</p>

Communication Data Format

This section explains about communication data format of the bar code reader and the upper equipment.

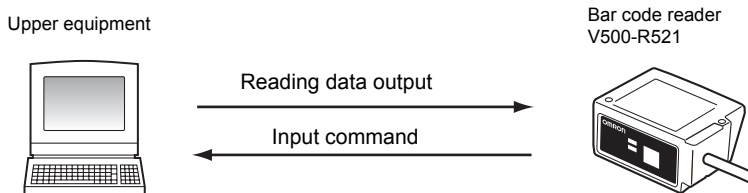

Reading trigger input by RS-232C command

Reading trigger command format is as shown below.

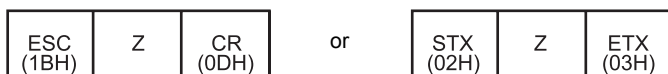

Set command input

Reading condition set command can be transmitted from the upper equipment. Format is as follows.

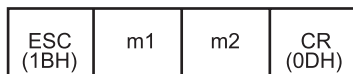

Command

(In case of one character, m1 only)

For details of command, refer to Section 4.

p.56

Data output format when reading succeeded

When bar code reading is succeeded, following data is transmitted to the upper equipment.

Header	Number	Data of read bar code	Footer
--------	--------	-----------------------	--------

Output item	Description	Initial setting
Header	Letter strings to add at the head of transmitted data. Max 4 arbitrary characters can be set.	No header
Number of digit	Number of digit of the read data is output in two-digit ASCII code. Whether or not to output the number of digit is selectable.	No number of digit output
Footer	Letter strings to add at the end of transmitted data. Max 4 arbitrary characters can be set.	CR (0DH)

 Setting methods of whether to output header, number of digit and footer p.79

Process when reading failed

Output format differs according to what is set to "reading failed process".

Selection of output format when reading failed	Remarks
No process	Nothing is transmitted
BR [CR] is transferred	–
[STX]?[ETX], [STX]>[ETX] is transferred	?: When it is judged as no bar code
?[CR], >[CR] are transferred	>: In cases other than above
[CAN] [CR] are transferred	–
[STX] [CAN] [ETX] are transferred	–

 Setting method p.68

Data transfer contents of each reading code type

Reading code	Description
UPC-A	You can select whether or not to transfer the head character "0" for transfer digit number adjustment and check digit C/D. ("0" is the additional character combining with C/D to adjust the number of digit to be in accordance with EAN-13.) 0 S X1 X2 X3 X4 X5 X6 X7 X8 X9 X10 C/D S: Number system character (Automatically decided according to the combination of each character of X1 to X10.)
UPC-E	You can select whether or not to transfer the head character "0" for transfer digit number adjustment and check digit C/D. ("0" is the additional character combining with C/D to adjust the number of digit to be in accordance with EAN-13.) 0 S X1 X2 X3 X4 X5 X6 C/D S: Number system character (Automatically decided according to the combination of each character of X1 to X10.)
EAN	Reading data (8-digit or 13-digit) is transferred as it is.
ITF, STF (2 of 5 bar)	Transfers in the order from the next character of the start code to the character before the stop code. (Start code and stop code are not transferred.)
NW-7, CODE39	You can select whether or not to transfer the start code and stop code. When the start code and stop code is permitted to transfer, you can select whether the transferred start/stop code of NW-7 is in lower-case "a/b/c/d" or in upper-case "A/B/C/D". Transfer start/stop code of CODE39 is "***".
EAN128	Add a control character "C1" (ASCII code 5D, 43, 31) which indicates EAN 128, at the head of the transfer data. Also, FNC1 character, as a separating character, is replaced to GS (ASCII code 1DH) character and transferred.

 Setting method p.63

Test Reading Function

You can check how stably the subject bar code can be read.

Read a bar code at resting state for one sec. and calculate the reading rate.

■ To enter reading measurement mode using a command

1. Install the bar code at a reading position.

2. Enter command "7U".

Mode enters to reading rate measurement mode.

Reading rate of every one sec. is measured.

3. To finish the reading rate measurement mode, enter reset command "Z1" or re-start the bar code reader.

Return to the normal measurement mode.



CHECK!

Do not execute write command "Z2" to nonvolatile memory.

A sample setting condition is overwritten and stored, which erases the already set reading condition.

■ To enter reading measurement mode using a TEST button on the back side

1. Install the bar code at a reading position.

2. Keep pressing the TEST button until the buzzer (tones repeating "Sol" and "Do") sounds.

3. Press the TEST button once.



CHECK!

Press the TEST button within 10 sec. after the buzzer sounds.

After 10 sec. or more have passed, it returns to the original state.

Mode entered to reading rate measurement mode.

(Reading rate of every one sec. is measured according to the reading condition of factory default.)

4. To finish the reading rate measurement mode, enter reset command "Z1" or re-start the bar code reader.

Return to the normal measurement mode.

■ **Output format**

Reading rate of every one sec. is output to the upper equipment, while in reading rate measurement mode.

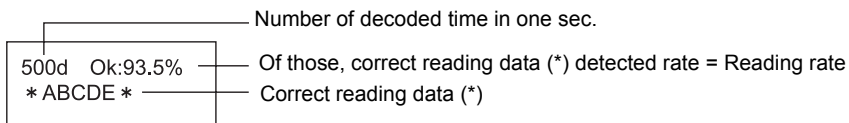

Data, which detected most during measurement mode, is “correct reading data”.

Communication data format

ESC	[3 A	CR	500d	SPACE	Ok:	93.5%	CR	*ABCDE*	CR
-----	-------	----	------	-------	-----	-------	----	---------	----

■ **A rough guide of reading rate**

The LED illumination patten on the back side changes according to the result of reading rate.

Reading rate	READ NG LED	READ OK LED	Description
76~100 %	●	☉	Reading is possible without problem.
51~75 %	●	☾	When the bar code is at still state when read, reading is possible without problem. However, when the target bar code is moving, reading may be failed according to speed.
26~50 %	●	●	There is a possibility to fail even reading at still state. Check if the installation location and angle of the bar code reader is appropriate once more.
0~25 %	●	●	Reading is not stable. Check if there is no dirt or lack on the bar code. Check if the installation location and angle of the bar code reader is appropriate once more.

LED indication

● : Lights out ☾ : Blink ☉ : Illuminate

Section 4

Setting Method

This section explains about setting methods using a menu sheet and entering command from the upper equipment.

☒ How to Use Menu Sheet/Command	52
☒ Menu Sheet/Command List	56

How to Use Menu Sheet/Command

There are following two setting methods for the bar code reader. Select either method according to the condition.

Setting method	Description
Read the menu sheet.	This method reads the menu sheet of the function you want to set. It is convenient for the initial setting and when testing.
Input a command from the upper equipment.	This method inputs a command from the upper equipment. It is convenient when changing setup according to the type of the bar code.

Read the menu sheet

The menu sheet is a special bar code used to set this bar code function. Setting can be changed by reading this menu sheet.

1. Read "Z7" of the menu sheet that means setting start/end.

Buzzer sounds continuously.

The bar code reader entered setting mode.



2. Read "UA" on the menu sheet that means to return to factory default setting.



3. Read the item on the menu sheet you want to change setting.

 Menu Sheet/Command List p.56

4. To finish setting, read "Z7" on the menu sheet for setting start/end, again.

Buzzer sound stops and returns to normal mode.



■ How to create menu sheet

The used menu sheet is a code system of CODE39. However, the code is special, using start code and stop code for a space mark. (Normally "**")

You can create a menu sheet using bar code creation software available in the market, as shown below.

E.g.: When creating a menu sheet "A3"

Create "** A3 **" and cut the parts of "**" with scissors to create the menu sheet "A3".



Input command from the upper equipment

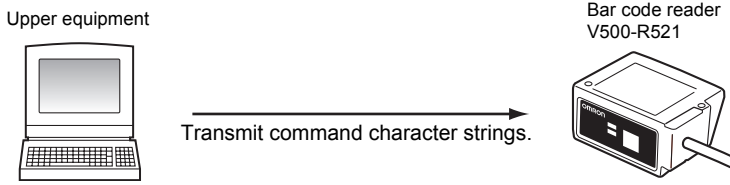

1. Transmit the command character strings of the function you want to set.

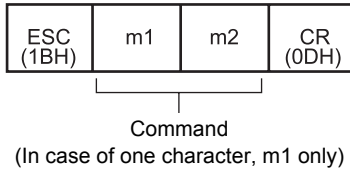

 Menu Sheet/Command List p.56



CHECK!

During the bar code reader is processing command, it notifies externally that it is in processing mode turning off the RS signal line.
When the RS signal line is not connected, interval between inputting commands should be taken sufficiently.

2. Transmits "Z2", in order to write the set data on the nonvolatile memory in the bar code reader.



CHECK!

Be sure to write when a condition is set by inputting command from the upper equipment. When you turn off the power without writing the setting in the memory, the set content may be deleted.

Transmission method of the command by designating values and characters is explained as follows.

E.g. 1: Set "AB [CR]" on header. (When designating codes directly)

ESC (1BH)	1	Y	CR (0DH)	Transmit a header setting command.
ESC (1BH)	0	A	CR (0DH)	Transmit a character "A".
ESC (1BH)	0	B	CR (0DH)	Transmit a character "B".
ESC (1BH)	1	C	CR (0DH)	Transmit CR code.

E.g. 2: Set "AB [CR]" on header. (When designating hexadecimal number directly)

ESC (1BH)	1	Y	CR (0DH)	Transmit a header setting command.
#	4	1	CR (0DH)	Transmit 41 "A" in hexadecimal number.
#	4	2	CR (0DH)	Transmit 42 "B" in hexadecimal number.
ESC (1BH)	1	C	CR (0DH)	Transmit CR code.



"00H" (zero) cannot be designated as header or footer. It is regarded as end character.
Characters until just before 00H are valid.

E.g. 3: Reading number of digit is set to "8-digit" and "12-digit".

ESC (1BH)	7	V	CR (0DH)	Transmit the number of digit command "A".
+	0	8	CR (0DH)	Transmit "8-digit". (Input in decimal number. Numbers are fix to 2-digit.)
ESC (1BH)	7	W	CR (0DH)	Transmit the number of digit command "B".
+	1	2	CR (0DH)	Transmit "12-digit". (Input in decimal number. Numbers are fix to 2-digit.)

Menu Sheet/Command List

Groups are classified as follows. Please refer to the corresponding pages.

Setting item	Reference
Setting start/end according to menu sheets	p.57
Write setting contents on the nonvolatile memory	p.57
Reset	p.57
Setting related to external trigger signal	p.57
Return to factory default setting	p.58
Collective setting	p.59
Setting of reading permission and prohibition	p.61
Detail setting for reading code	p.63
Setting for reading conformance	p.66
Setting for reading system	p.67
Setting for failed reading	p.68
Setting for number of reading digit	p.69
Setting for reading effective duration	p.70
Setting related to LED	p.72
Settings related to duration of buzzer sound and volume	p.73
Setting related to READ OK/NG signal output (Only when V500-R521B2 is used)	p.75
Setting related to communication condition	p.77
Setting related to communication protocol	p.78
Setting for header, footer and number of reading digit	p.79
Setting related to test reading	p.79
Direct code designation	p.80
Setting related to sorting read	p.83

Setting start/end according to menu sheets

When setting using menu sheets, read this menu sheet with the bar code to start and end the setting.

Menu sheet	Command
Setting start/end according to menu sheets  Z 7	None

Write setting contents on the nonvolatile memory

Be sure to write when a condition is set by inputting command from the upper equipment. When you turn off the power without writing the setting in the memory, the set content may be deleted.

Menu sheet	Command
Write the contents set with a command in the nonvolatile memory. (No menu sheet)	Z2



Reset

Return to the setting, which is already written in the nonvolatile memory.

Menu sheet	Command
Reset  Z 1	Z1

Setting related to external trigger signal

Select positive logic/negative logic of the external trigger signal.

Menu sheet	Command
External trigger signal Positive logic (H active)  8 A	8A
External trigger signal Negative logic (L active)  8 B (Factory default setting)	8B

Return to factory default setting

Menu sheet	Command
Factory default setting 	UA

Initial setting

Item	Setting content	Corresponding command	
Types of code, which is possible to read	EAN/UPC, CODE39, NW-7, STF, ITF	J1+R4+B2+B3+R7+R8	
Number of reading digits	No designated number of digits	H0	
Detail condition	CODE39 detail setting	Invalid C/D of CODE39	C0
		Transfer C/D of CODE39	C2
		Transfer ST/SP of CODE39	D1
	NW-7 detail setting	Invalid C/D of NW-7	F7
		Transfer C/D of NW-7	F5
		Transfer ST/SP of NW-7 (abcd/abcd)	F4
ITF/STF detail setting	Invalid C/D of ITF/STF	G0	
	Transfer C/D of ITF/STF	G2	
Reading condition	Reading system	Trigger reading	S8
	Reading operation	Single reading	S0
	Reading valid time	Trigger + 2 sec.	Y2
	Number of reading coincidence	Twice (Verification: once)	X1
Communication condition	Communication speed	9600 bps	K6
	Data length	8-bit	L1
	Parity	None	L2
	Stop bit length	1-bit	L5
	Header	None	1Y
	Footer	CR	1Z+1C
	Transfer number of digits	Not transferred	2Z
	RS/CS control	None	P0
	CS waiting time	Infinity	I0
	Communication protocol	No protocol system	P5
Process when reading is NG	No process (Nothing is transferred)	5E	
LED illumination	LED illumination time after decoding is 200 ms.	T5	
Buzzer sound	Buzzer sound duration after decoding is 200 ms.	W5	
Buzzer sound volume	Max.	T0	
Buzzer frequency	3 kHz, 2 kHz	W2	
External trigger signal	Negative logic (L active)	8B	
READ OK/NG signal output	Output	8Q	
READ OK/NG signal output system	Trigger synchronous system, positive logic (H active)	8C	

Collective setting

Collective setting of conditions appropriate for connection of programmable controller (UB) and for connection of multi-drop using link unit (UC) is allowed.

Menu sheet	Command
Setting of programmable controller connection 	UB

Hatching parts are the changed point from the factory default setting.

Collective setting

Item	Setting content	Corresponding command	
Types of code, which is possible to read	EAN/UPC, CODE39, NW-7, STF, ITF	J1+R4+B2+B3+R7+R8	
Number of reading digits	No designated number of digits	H0	
Detail condition	CODE39 detail setting	Invalid C/D of CODE39	C0
		Transfer C/D of CODE39	C2
		Transfer ST/SP of CODE39	D1
	NW-7 detail setting	Invalid C/D of NW-7	F7
		Transfer C/D of NW-7	F5
		Transfer ST/SP of NW-7 (abcd/abcd)	F4
	ITF/STF detail setting	Invalid C/D of ITF/STF	G0
		Transfer C/D of ITF/STF	G2
	Reading condition	Reading system	Trigger reading
Reading operation		Single reading	S0
Reading valid time		Trigger + 2 sec.	Y2
Number of reading coincidence		Twice (Verification: once)	X1
Communication condition	Communication speed	9600 bps	K6
	Data length	7-bit	L0
	Parity	Even number	L6
	Stop bit length	2-bit	L6
	Header	None	1Y
	Footer	CR	1Z+1C
	Transfer number of digits	Not transferred	2Z
	RS/CS control	None	P0
	CS waiting time	Infinity	I0
	Communication protocol	No protocol system	P5
Process when reading is NG	Transfer ? (CR), > (CR)	5H	
LED illumination	LED illumination time after decoding is 200 ms.	T5	
Buzzer sound	Buzzer sound duration after decoding is 200 ms.	W5	
Buzzer sound volume	Max.	T0	
Buzzer frequency	3 kHz, 2 kHz	W2	
External trigger signal	Negative logic (L active)	8B	
READ OK/NG signal output	Output	8Q	
READ OK/NG signal output system	Trigger synchronous system, positive logic (H active)	8C	

Menu sheet	Command
Setting for connecting link unit (V700-L12)	UC
 U C	

Hatching parts are the changed point from the factory default setting.







Collective setting







Item		Setting content	Corresponding command
Types of code, which is possible to read		EAN/UPC, CODE39, NW-7, STF, ITF	J1+R4+B2+B3+R7+R8
Number of reading digits		No designated number of digits	H0
Detail condition	CODE39 detail setting	Invalid C/Dof CODE39	C0
		Transfer C/D of CODE39	C2
		Transfer ST/SP of CODE39	D1
	NW-7 detail setting	Invalid C/D of NW-7	F7
		Transfer C/D of NW-7	F5
		Transfer ST/SP of NW-7 (abcd/abcd)	F4
ITF/STF detail setting	Invalid C/D of ITF/STF	G0	
	Transfer C/D of ITF/STF	G2	
Reading condition	Reading system	Trigger reading	S8
	Reading operation	Single reading	S0
	Reading valid time	Trigger + 2 sec.	Y2
	Number of reading coincidence	Twice (Verification: once)	X1
Communication condition	Communication speed	9600 bps	K6
	Data length	8-bit	L1
	Parity	Even number	L3
	Stop bit length	1-bit	L5
	Header	None	1Y
	Footer	CR	1Z+1C
	Transfer number of digits	Not transferred	2Z
	RS/CS control	None	P0
	CS waiting time	Infinity	I0
	Communication protocol	No protocol system	P5
	Process when reading is NG	Transfer ? (CR), > (CR)	5H
LED illumination	LED illumination time after decoding is 200 ms.	T5	
Buzzer sound	Buzzer sound duration after decoding is 200 ms.	W5	
Buzzer sound volume	Max.	T0	
Buzzer frequency	3 kHz, 2 kHz	W2	
External trigger signal	Negative logic (L active)	8B	
READ OK/NG signal output	Output	8Q	
READ OK/NG signal output system	Trigger synchronous system, positive logic (H active)	8C	









Setting of reading permission and prohibition

Select bar code types of which subject to read.

Prohibit bar codes, which is not subject to read, from reading in order to increase reading reliability.

Menu sheet	Command
Reading permission only for UPC-A/E  (Factory default setting)	J1
Reading permission only for EAN13/8 	J4
Reading permission only for CODE39 	A2
Reading permission only for NW-7 	A3
Reading permission only for ITF 	J8
Reading permission only for STF 	J7
Reading permission only for CODE93 	A5

Menu sheet	Command
Reading permission for UPC-A/E 	R1
Reading permission for EAN13/8  (Factory default setting)	R4
Reading permission for CODE39  (Factory default setting)	B2
Reading permission for NW-7  (Factory default setting)	B3
Reading permission for ITF  (Factory default setting)	R8
Reading permission for STF  (Factory default setting)	R7
Reading permission for CODE93 	B5

Menu sheet	Command
Reading permission only for CODE128 	A6
Reading prohibition for EAN/UPC 	4A
Reading prohibition for CODE39 	4H
Reading prohibition for NW-7 	4I
Reading prohibition for STF 	4K
Reading prohibition for ITF 	4L
Reading prohibition for CODE93  (Factory default setting)	4M
Reading prohibition for CODE128  (Factory default setting)	4N
Reading prohibition for all types 	4Z

Menu sheet	Command
Reading permission for CODE128 	B6

Detail setting for reading code

Conditions of detail reading code such as whether check digit (C/D) is used or start code/stop code (ST/SP) is transmitted are set.

UPC-A

Menu sheet	Command
Output UPC-A in 13-digit  (Factory default setting)	E2
Output UPC-A in 12-digit (without 0 in the beginning)	E3

Menu sheet	Command
Output UPC-A in 12-digit (without C/D)	E4
Output UPC-A in 11-digit (without 0 in the beginning or C/D)	E5

UPC-E

Menu sheet	Command
Output UPC-E in 8-digit 	E6
Output UPC-E in 7-digit (without 0 in the beginning)	E7



Menu sheet	Command
Output UPC-E in 7-digit (without C/D) (Factory default setting)	E8
Output UPC-E in 6-digit (without 0 in the beginning or C/D)	E9



CODE39

Menu sheet	Command
Invalid C/D of CODE39  (Factory default setting)	C0
Valid C/D of CODE39	C1

Menu sheet	Command
Not transfer ST/SP of CODE39 	D0
Transfer ST/SP of CODE39 (Factory default setting)	D1



Section 4 Setting Method

Menu sheet	Command
Transfer C/D of CODE39  (Factory default setting)	C2
Not transfer C/D of CODE39 	C3

Menu sheet	Command
CODE39 1-digit reading permission 	7C
CODE39 1-digit reading prohibition  (Factory default setting)	7D

NW-7

Menu sheet	Command
Invalid C/D of NW-7  (Factory default setting)	F7
Valid C/D of NW-7 (modulus 16) 	F9
Transfer C/D of NW-7  (Factory default setting)	F5
Not transfer C/D of NW-7 	F6
Not transfer ST/SP of NW-7 	F0

Menu sheet	Command
Transfer ST/SP of NW-7 (ABCD/ ABCD) 	F3
Transfer ST/SP of NW-7 (abcd/abcd)  (Factory default setting)	F4
NW-7 1-digit reading permission 	7K
NW-7 1-digit reading prohibition  (Factory default setting)	7L

ITF/STF

Menu sheet	Command
Invalid C/D of ITF/STF  (Factory default setting)	G0
Valid C/D of ITF/STF 	G1
Transfer C/D of ITF/STF  (Factory default setting)	G2

Menu sheet	Command
Not transfer C/D of ITF/STF 	G3
ITF/STF 2-digit reading permission 	7M
ITF/STF 2-digit reading prohibition  (Factory default setting)	7N

CODE128

After executing CODE128 reading permission command (B6), execute commands as shown below.

Menu sheet	Command
All reading permission including EAN128  (Factory default setting)	G5



Menu sheet	Command
Reading permission only for EAN128 in CODE128 	G6



 EAN128 (Reading specification) p.126

Setting for reading conformance

When decoded results coincide for the set number of conformance, the read results are output to RS-232C interface.

Verification system is AND verification (Continuous conformance system). (Change prohibition)

Menu sheet	Command
Reading conformance twice (Verification: once)  (Factory default setting)	X1
Reading conformance 3 times (Verification: 2 times) 	X2
Reading conformance 4 times (Verification: 3 times) 	X3

Menu sheet	Command
Reading conformance 5 times (Verification: 4 times) 	7R
Reading conformance 6 times (Verification: 5 times) 	7S

Setting for reading system

Set the reading system.



 Explanation of Reading System p.36

Reading system

Menu sheet	Command
Full-time reading 	S7

Menu sheet	Command
Trigger reading  (Factory default setting)	S8



Reading operation



Menu sheet	Command
Single reading  (Factory default setting)	S0
Plural reading 	S1

Menu sheet	Command
Continuous reading 	S2

Setting for failed reading

Process for failed reading is set.

Menu sheet	Command
When reading failed: no process  (Factory default setting)	5E
When reading failed: Transfer BR [CR] 	5F
When reading failed: Transfer [STX]?[ETX], [STX]>[ETX] (*) 	5G

Menu sheet	Command
When reading failed: Transfer ? [CR], >[CR] (*) 	5H
When reading failed: Transfer [CAN] [CR] 	5I
When reading failed: Transfer [STX] [CAN] [ETX] 	5J



* When it is judged as no bar code: ?
In cases other than above: >

Setting for number of reading digit

When the number of digit is fixed, designate the number of digit to improve reliability.

For number of digit, two types (A and B) can be set.

In case of the bar code including C/D, count the C/D as one digit.

Menu sheet	Command
Number of digit is not designated.  (Factory default setting)	None
Designation of number of digit A (Bar code reading system) *1 	None
Designation of number of digit B (Bar code reading system) *1 	None

Menu sheet	Command
Designation of number of digit A *2 (No menu sheet)	7V
Designation of number of digit B *2 (No menu sheet)	7W

*1 After reading this menu sheet, read the bar code of the number of digit you want to register twice, continuously. When the number of digit is one type, set A and B to the same setting.

*2 After transmitting this command, transmit the character string of the bar code you want to register, continuously.







 p.54





Setting for reading effective duration





After inputting a trigger, set the time for the continuous reading. Effective duration is set by combining "effective duration" from 0 to 10 sec. and "minor setting" from 0 to 750 ms. This is set only in case when the reading system, which is required to set the effective duration, is selected.

 Explanation of Reading System p.36

Menu sheet	Command
Coupled with trigger (trigger + 0 sec.) 	Y0
Trigger + 1 sec. 	Y1
Trigger + 2 sec.  (Factory default setting)	Y2
Trigger + 3 sec. 	Y3
Trigger + 4 sec. 	Y4
Trigger + 6 sec. 	Y5
Trigger + 8 sec. 	Y6



Menu sheet	Command
Trigger +0 ms (minor setting)  (Factory default setting)	YA
Trigger + 5.0 ms (minor setting) 	YB
Trigger + 100 ms (minor setting) 	YC
Trigger + 150 ms (minor setting) 	YD
Trigger + 200 ms (minor setting) 	YE
Trigger + 250 ms (minor setting) 	YF
Trigger + 300 ms (minor setting) 	YG



Menu sheet	Command
Trigger + 10 sec. 	Y7
Trigger + 400 ms (minor setting) 	YI
Trigger + 450 ms (minor setting) 	YJ
Trigger + 500 ms (minor setting) 	YK
Trigger + 550 ms (minor setting) 	YL

Menu sheet	Command
Trigger + 350 ms (minor setting) 	YH
Trigger + 600 ms (minor setting) 	YM
Trigger + 650 ms (minor setting) 	YN
Trigger + 700 ms (minor setting) 	YO
Trigger + 750 ms (minor setting) 	YP

Setting related to LED

When reading succeeded, READ OK LED illuminates and when reading failed, READ NG LED illuminates. Duration of illumination is allowed to set.

Menu sheet	Command
LED does not illuminate after decode. 	T4
The LED illuminates for 100 ms after decoding. 	T8
The LED illuminates for 200 ms after decoding.  (Factory default setting)	T5





Menu sheet	Command
The LED illuminates for 400 ms after decoding. 	T6
The LED illuminates for 800 ms after decoding. 	T7

Settings related to duration of buzzer sound and volume





When reading succeeded, buzzer sounds. Sound volume, frequency and duration of the buzzer are allowed to set.

(When sorting read function is used, buzzer sounds when reading result is disagree with the registered data.)

Buzzer sound volume



Menu sheet	Command
Buzzer sound volume; max.  (Factory default setting)	T0
Buzzer sound volume; middle or above 	T1
Buzzer sound volume; middle or below 	T2
Buzzer sound volume; min. 	T3
No buzzer sound after decoding 	W0

Duration of buzzer

Menu sheet	Command
Buzzer sound duration after decoding; 10 ms 	W8
Buzzer sound duration after decoding; 50 ms 	W7
Buzzer sound duration after decoding; 100 ms 	W4
Buzzer sound duration after decoding; 200 ms  (Factory default setting)	W5
Buzzer sound duration after decoding; 400 ms 	W6

Section 4 Setting Method

Buzzer frequency







Menu sheet	Command
Buzzer sound frequency after decoding; 3 kHz 	W1
Buzzer sound frequency after decoding; 3 kHz, 2 kHz  (Factory default setting)	W2







Menu sheet	Command
Buzzer sound frequency after decoding; 2 kHz, 3 kHz 	W3

Setting related to READ OK/NG signal output (Only when V500-R521B2 is used)

When you want to output reading succeeded/failed to READ OK/NG signal, set the conditions of output system and duration, then execute "signal output (8Q)".

 Output system p.28

Menu sheet	Command
Signal output  (Factory default setting)	8Q
No signal output 	8R
Signal output trigger signal synchronous system (positive logic)  (Factory default setting)	8C
Signal output trigger signal synchronous system (negative logic) 	8D
Signal output one-shot system (positive logic) 	8E
Signal output one-shot system (negative logic) 	8F
Signal output one-shot duration; 10 ms 	8G









Menu sheet	Command
Signal output one-shot duration; 30 ms 	8I
Signal output one-shot duration; 40 ms 	8J
Signal output one-shot duration; 50 ms 	8K
Signal output one-shot duration; 60 ms 	8L
Signal output one-shot duration; 70 ms 	8M
Signal output one-shot duration; 80 ms 	8N
Signal output one-shot duration; 90 ms 	8O









Section 4 Setting Method

Menu sheet	Command
Signal output one-shot duration 20 ms 	8H







Menu sheet	Command
Signal output one-shot duration; 100 ms 	8P





Setting related to communication condition

Menu sheet	Command
Communication speed; 300 bps  K 1	K1
Communication speed; 600 bps  K 2	K2
Communication speed; 1200 bps  K 3	K3
Communication speed; 2400 bps  K 4	K4
Communication speed; 4800 bps  K 5	K5
Communication speed; 9600 bps  K 6 (Factory default setting)	K6
Communication speed; 19200 bps  K 7	K7
Communication speed; 38400 bps  K 8	K8

Menu sheet	Command
Data length; 7-bit  L 0	L0
Data length; 8-bit  L 1 (Factory default setting)	L1
No parity  L 2 (Factory default setting)	L2
Parity even number  L 3	L3
Parity uneven number  L 4	L4
Stop bit; 1-bit  L 5 (Factory default setting)	L5
Stop bit; 2-bit  L 6	L6
Without RS/CS control  P 0 (Factory default setting)	P0
With RS/CS control (BUSY/READY)  P 1	P1

Setting related to communication protocol



Menu sheet	Command
Communication protocol: ACK/NAK system 	P3
Communication protocol: No protocol system  (Factory default setting)	P5
ACK/NAK response waiting time: Infinite  (Factory default setting)	I4
ACK/NAK response waiting time: 100 ms 	I5
ACK/NAK response waiting time: 500 ms 	I6
ACK/NAK response waiting time: 1000 ms 	I7



Menu sheet	Command
CS waiting time: Infinite  (Factory default setting)	I0
CS waiting time: 100 ms 	I1
CS waiting time: 200 ms 	I2
CS waiting time: 400 ms 	I3

Setting for header, footer and number of reading digit

Format when outputting the reading result is set.

 Data output format when reading succeeded p.47

Menu sheet	Command
Collective setting of header (Applied to all codes) 	1Y
Collective setting of footer (Applied to all codes) 	1Z

Menu sheet	Command
Number of reading digit is not transferred (Applied to all codes)  (Factory default setting)	2Z
Number of reading digit is transferred (Applied to all codes) 	3Z









Setting related to test reading









 Test reading function p.49









Menu sheet	Command
Mode enters to reading rate measurement mode. (No menu sheet)	7U



Direct code designation

Use to set character strings and values directly such as designation of header and footer or number of reading digit.



Menu sheet	Command
"A" is set. 	0A
"B" is set. 	0B
"C" is set. 	0C
"D" is set. 	0D
"E" is set. 	0E
"F" is set. 	0F
"G" is set. 	0G
"H" is set. 	0H



Menu sheet	Command
"I" is set. 	0I
"J" is set. 	0J
"K" is set. 	0K
"L" is set. 	0L
"M" is set. 	0M
"N" is set. 	0N
"O" is set. 	0O
"P" is set. 	0P

Menu sheet	Command
"Q" is set. 	0Q
"R" is set. 	0R
"S" is set. 	0S
"T" is set. 	0T
"U" is set. 	0U
"V" is set. 	0V
"W" is set. 	0W
"Y" is set. 	0Y

Menu sheet	Command
"Z" is set. 	0Z
"0" is set. 	Q0
"1" is set. 	Q1
"2" is set. 	Q2
"3" is set. 	Q3
"5" is set. 	Q5
"6" is set. 	Q6
"7" is set. 	Q7

Section 4 Setting Method



Menu sheet	Command
"8" is set. 	Q8
"9" is set. 	Q9
STX (02H) is set 	1A

Menu sheet	Command
ETX (03H) is set. 	1B
CR (ODH) is set. 	1C
LF (0AH) is set. 	1D

Setting related to sorting read

Bar code data to read are registered in this bar code reader beforehand and only the registered bar codes are read using this function. When the read bar code does not coincide with the registered data, buzzer sounds.

Up to 5 types of bar codes can be registered.

Menu sheet	Command
Register one character each using command. (*1) Register with regular expression. (*1) 	7Y
Sorting read operation starts. 	UE

*1 Execute the command "UE" to start sorting read operation.



When you enter the command "UE", reading system and communication specification are set as follows. When sorting read function is used, do not change the setting basically.

To change a part of communication condition, etc, change it after you input command "UE" and sorting read operation starts.

Item		Setting content
Types of code, which is possible to read		Reading permission for all types
Number of reading digits		No designated number of digits
Reading system	Reading trigger	Valid (Not full-time reading but trigger is used)
	Reading operation	Single reading
	Reading valid time	Trigger + 2 sec.
	Number of reading coincidence	Twice (Verification: once)
	Communication speed	9600 bps
	Data length	8-bit
	Parity	None
Communication condition	Stop bit length	1-bit
	Header	None
	Footer	CR
	Transfer number of digits	Not transferred
	RS/CS control	None
	CS waiting time	Infinity
	Communication protocol	No protocol system
	Process when reading is NG	No process (Nothing is transferred)

■ **How to register one character each using command**

Register the bar code one character each using the command "7Y".

After registration, execute the command "UE" to start sorting read operation.

E.g.: When registering two bar codes, "a123a" and "** ABC **".

Transmit following characters in sequence.

Transmitted character strings	Description
[ESC] 7 Y [CR]	Label registration command
# 6 1 CR	Designation of character string "a (61H)"
[ESC] Q 1 CR	Designation of character string "1 (direct code)"
[ESC] Q 2 CR	Designation of character string "2 (direct code)"
[ESC] Q 3 CR	Designation of character string "3 (direct code)"
# 6 1 CR	Designation of character string "a (61H)"
# 0 0 CR	Separation
# 2 A CR	Designation of character string "** (2AH)"
[ESC] 0 A CR	Designation of character string "A (direct code)"
[ESC] 0 B CR	Designation of character string "B (direct code)"
[ESC] 0 C CR	Designation of character string "C (direct code)"
# 2 A CR	Designation of character string "** (2AH)"
# 0 0 CR	Separation
# 0 0 CR	End of command

■ **How to register data using regular expression**

Width of registration data may extend by using regular expression. To use regular expression, use a setting command or "7Y" of the menu sheet.

Max. 5 data can be registered. Number of byte of definition character is up to 200.

Usable regular expression

Regular expression	Description
?	Arbitrary one character
!	From 0 to arbitrary characters (any number of characters)
[A B C D...]	One character designated (One character in the designated character)
[A-D]	One character designated (Character range described within a hyphen)
[A-D 0-5 X 8 Z]	Mixed designation
A	One character designation
[A]	One character designation
[^A]	One character negation designation (One character that is not A)
[^A B]	One character negation designation (One character that is not A nor B)
[^A-D]	One character negation designation (One character that is not A to D)

Application example

Registration data	Description	Reading data	Determination	Operation
[A F]?QR	A or F + one arbitrary character + QR	ABQR	Coincide	Reading succeeded
		F9QR	Coincide	Reading succeeded
		F9QF	Inconsistency	Reading failed
		C9QR	Inconsistency	Reading failed
V?[^X-Z]!	V + one arbitrary character + one character other than X, Y, Z + arbitrary	VA3ABC	Coincide	Reading succeeded
		VA3	Coincide	Reading succeeded
		VAZ123	Inconsistency	Reading failed

E.g.: [A|F] ? When registering "Q R" and "V ?[^X - Z] !" bar code, transmit following character strings in sequence.

Transmitted character strings	Description
ESC 7 Y CR	Label registration command
# 5 B CR	Designation of character string "(5BH)"
ESC 0 A CR	Designation of character string "A (direct code)"
# 7 C CR	Designation of character string " (7CH)"
ESC 0 F CR	Designation of character string "F (direct code)"
# 5 D CR	Designation of character string "]" (5DH)"
# 3 F CR	Designation of character string "? (3FH)"
ESC 0 Q CR	Designation of character string "Q (direct code)"
ESC 0 R CR	Designation of character string "R (direct code)"
# 0 0 CR	Separation
ESC 0 V CR	Designation of character string "V (direct code)"
# 3 F CR	Designation of character string "? (3FH)"
# 5 B CR	Designation of character string "(5BH)"
# 5 E CR	Designation of character string "^ (5EH)"
ESC 0 X CR	Designation of character string "X (direct code)"
# 2 D CR	Designation of character string "- (2DH)"
ESC 0 Z CR	Designation of character string "Z (direct code)"
# 5 D CR	Designation of character string "]" (5DH)"
# 2 1 CR	Designation of character string "[! (21H)"
# 0 0 CR	Character string separation
# 0 0 CR	End of command

MEMO

Section 5

Example of System Configuration

This section explains about connection method with upper equipment.

☒ Example of Connection with a PC	88
☒ Example of Connection with Programmable Controller (CS1)	89
☒ Example of Multi-drop Connection	92
☒ How to Use Command Link Unit V700-L12	96

Example of Connection with a PC

Example of connection with PC/AT compatible PC is explained.

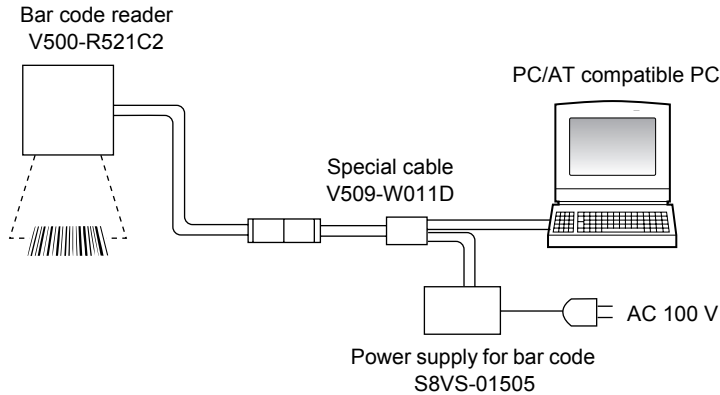

Wire (When V500-R521B2 is used)

Bar code reader side

Wiring color	Signal name
Brown	TRIG
Yellow	OK
Orange	NG
Blue	CS
Gray	RS
White	RD
Green	SD
Red	VCC
Black	S.GND
Shield	F.GND

Upper equipment side
(Example of PC/AT compatible PC)

Signal name	Pin No.
-	1
RD	2
SD	3
ER	4
SG	5
DR	6
CS	7
RS	8
-	9
Shield	Cover

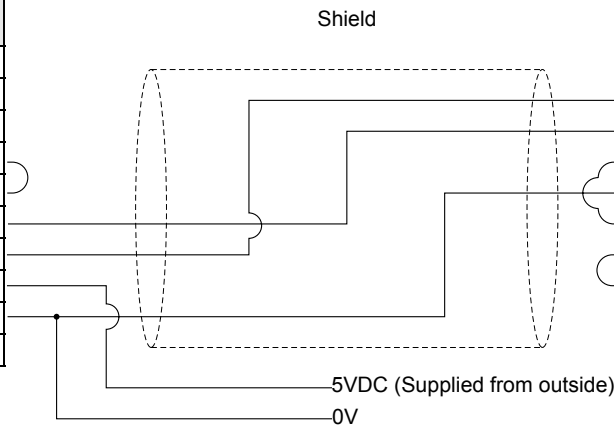

Example of BASIC program

```

100 CLS
110 CLOSE #1
120 OPEN "COM:N81NN" AS #1
130 BCDATA$=""
140 AA$=INPUT$(1,#1)
150 IF AA$=CHR$(&H03) GOTO 170
160 BCDATA$=BCDATA$+AA$:GOTO 140
170 PRINT "READ DATA=" ; BCDATA$
180 GOTO 130
    
```

Example of Connection with Programmable Controller (CS1)

Connection with programmable controller CS1 (Made by OMRON) is explained.

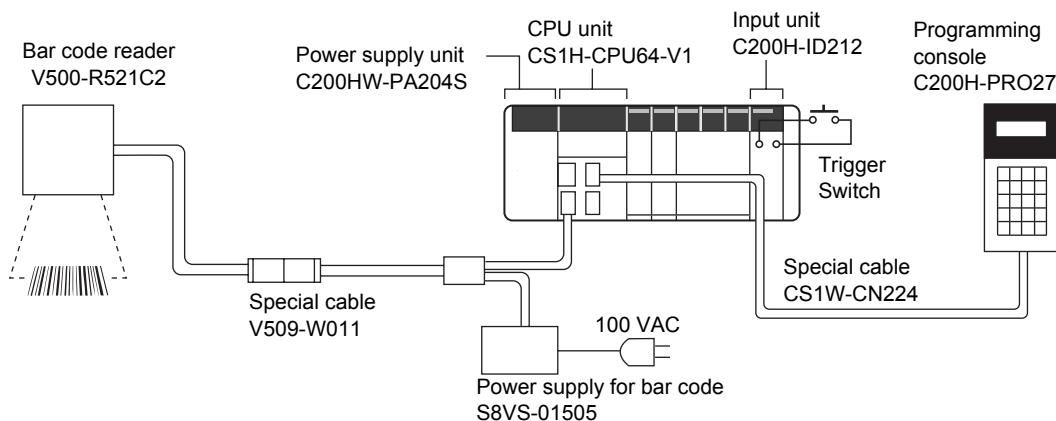

Connect the connection cable of this bar code reader to RS-232C port of the CPU unit.

Wire (When V500-R521B2 is used)

Bar code reader side

Wiring color	Signal name
Brown	TRIG
Yellow	OK
Orange	NG
Blue	CS
Gray	RS
White	RD
Green	SD
Red	VCC
Black	S.GND
Shield	F.GND

CS1
RS-232C port

Signal name	Pin No.
FG	1
SD	2
RD	3
RS	4
CS	5
-	6
-	7
-	8
SG	9

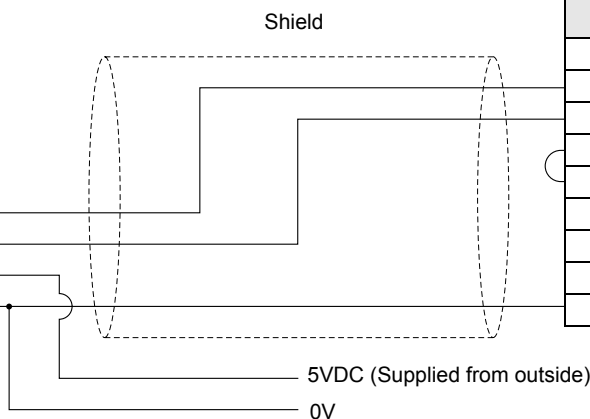

Setting at bar code side

Set as follows, using UB command (collective setting for programmable controller connection).

 p.59

Setting item	Setting content	Command
Communication speed	9600 bps	(Same as initial setting)
Data length	7-bit	L0
Parity	Even number	L3
Stop bit	2-bit	L6
Header	None	(Same as initial setting)
Footer	CR	(Same as initial setting)
Reading valid time	Trigger + 2 sec.	Y2
Process when reading failed	?[CR] or > [CR] is transferred	5H

Setting of CS1 side

For detail setting method, refer to the operation manual of your programmable controller.

Setting item	Setting content
Dip switch of CPU unit	OFF
PC system setting	160[8300]
	161[0000]
	164[000D]
	165[0100]
DM setting	Set [1B5A] to DM00100. (Memorize "Z" of ASCII code)

Example of program

When the trigger switch is turned on, the bar code reader starts reading operation and stores the read data to DM (data memory) of CS1. The content is displayed on the programming console. When the bar code cannot read within the duration which is set beforehand (2 sec. in this example), "?" or ">" is transmitted.

To check the read data with the programming console, press "Clear > FUN > Monitor" in this order.

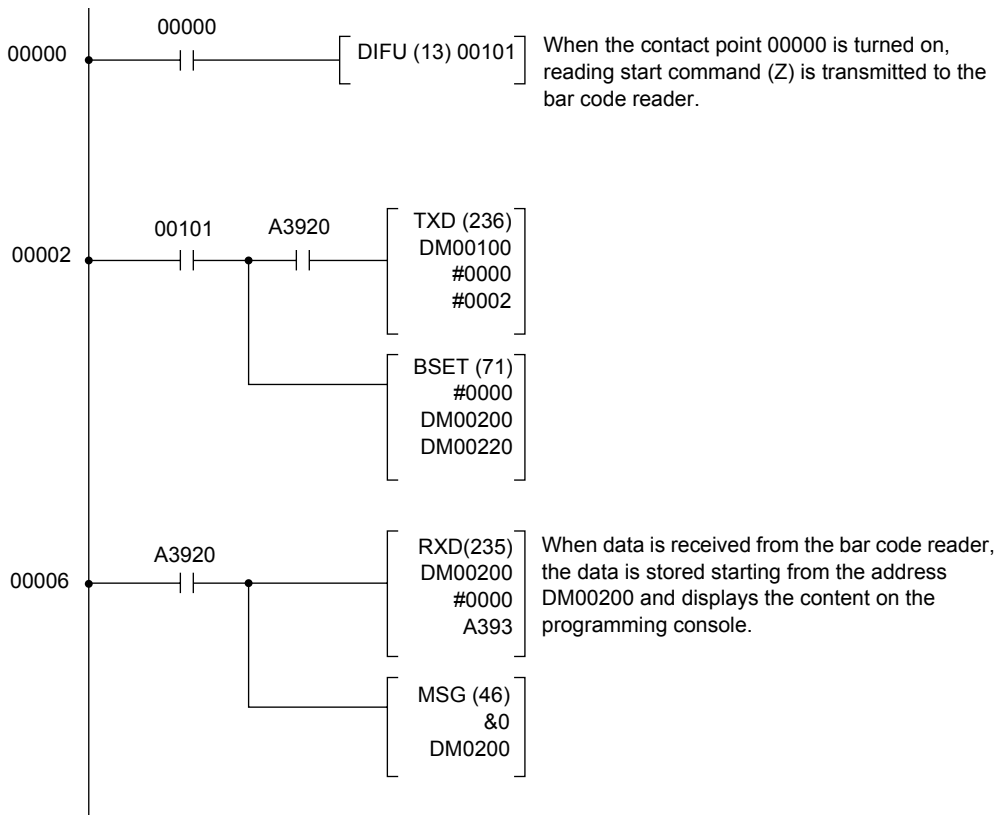

For the program command, refer to the operation manual of your programming console. (Items related to communication method by RS-232C nonprocedural system.)

Example of Multi-drop Connection

When communication link unit V700-L12 (sold separately) is used, you can connect max. 31 sets of the bar code reader to one upper equipment. This is called multi-drop connection. Connection configuration differs according to the interface (RS-485 or RS-232C) of the upper equipment side.

Example of connecting communication link unit (hereinafter referred to as "link unit") and the upper equipment using RS-485 is described in this section.

You can supply 5 V power to the bar code reader from V700-L12.



CHECK!

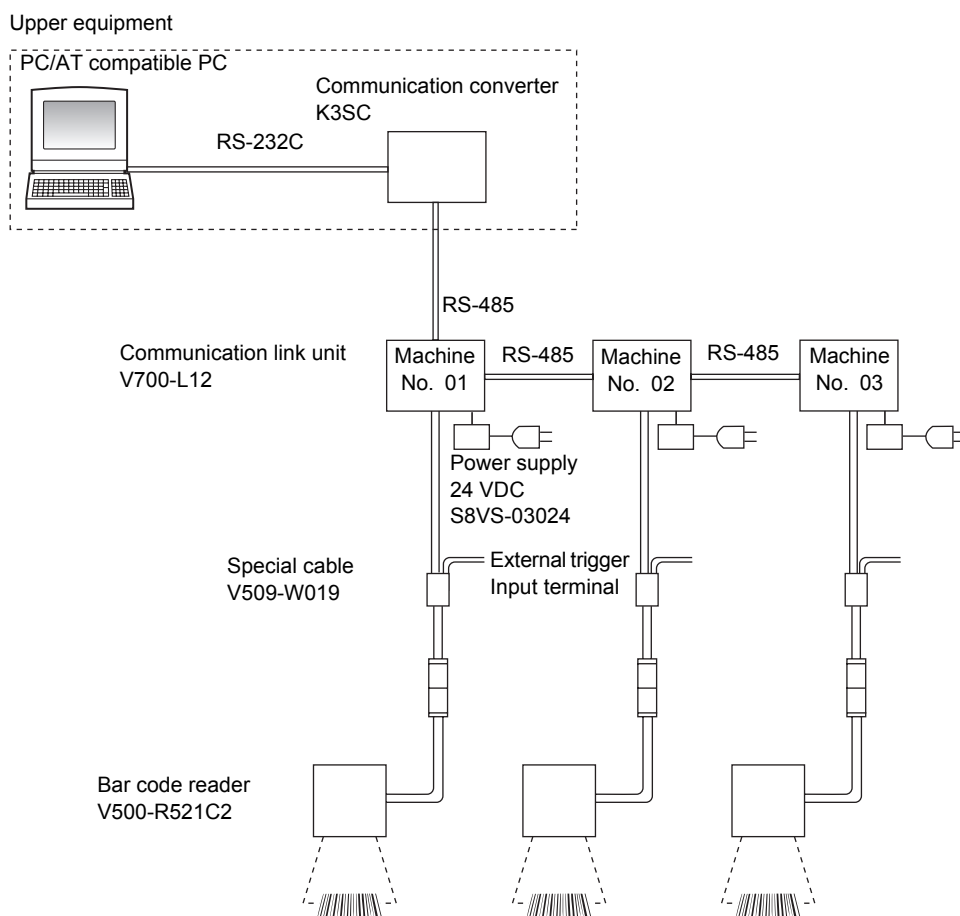

Setting at bar code reader side

Set as follows, using UC command (collective setting for link unit connection).

 p.60

Setting item	Setting content	Command
Communication speed	9600 bps	(Same as initial setting)
Data length	8-bit	(Same as initial setting)
Parity	Even number	L3
Stop bit	1-bit	(Same as initial setting)
Header	None	(Same as initial setting)
Footer	CR	(Same as initial setting)
RS/CS control	None	P0
Process when reading is NG	? [CR] or > [CR] is transmitted	5H
Other setting	Same as factory default setting.	-

Setting at link unit V700-L12 side

Setting item	Setting content	Setting
Machine No.	Set the machine No. differing in each link unit	Set DIP-SW 1 to 5.
Communication speed	9600 bps	DIP-SW 6, 7 are OFF
Transmission procedure	Normal procedure (polling procedure)	DIP-SW8 is OFF
Connection check	None	DIP-SW9 is OFF
RS-485 termination resistance	2 sets on both sides of transmission path are turned ON (*)	In case when turned ON, DIP-SW10 is ON

* In case of connection example shown here, termination resistors of the machine No. 3 and the upper equipment (interface converter) are turned ON.

 Specification and wiring of the link unit p.93

Operation flow chart

Each bar code reader reads bar codes when the trigger is input. Read data is transmitted to the unit and stored in a buffer inside the link unit.

When the data export command (polling command) is transmitted from the upper equipment, the link unit transmits the stored read data to the upper equipment.

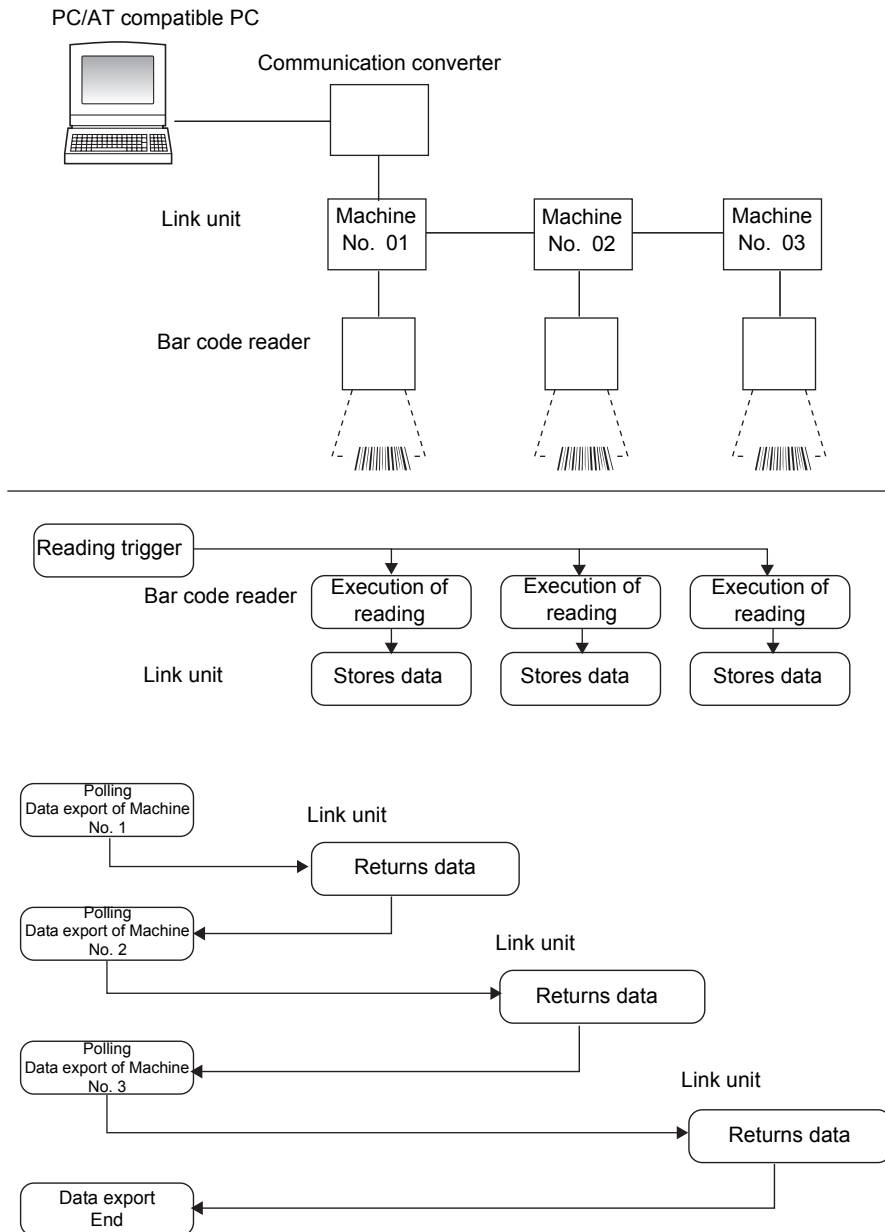

Communication format

Communication format used in this connection example is explained.
For details, refer to the following page.

 p.105

■ Reading trigger given from the upper unit

\$01	(Machine No.)	ESC	Z	(Check code)	\$0D
------	---------------	-----	---	--------------	------

E.g.: When a trigger is given to the bar code reader machine No. 2

\$01	0	2	ESC	Z	(Check code)	\$0D
------	---	---	-----	---	--------------	------

■ Polling command given from the upper equipment

\$01	(Machine No.)	DLE	P	(Check code)	\$0D
------	---------------	-----	---	--------------	------

E.g.: When exporting data of machine No. 2

\$01	0	2	DLE	P	(Check code)	\$0D
------	---	---	-----	---	--------------	------

■ Reading data transmitted from the bar code reader

\$01	(Machine No.)					Reading data				(Check code)	\$0D
------	---------------	--	--	--	--	--------------	--	--	--	--------------	------

E.g.: When the reading data of the machine No. 2 is "ABCDE"

\$01	0	2	A	B	C	D	E	(Check code)	\$0D
------	---	---	---	---	---	---	---	--------------	------

E.g.: When the read data is not accumulated

\$01	(Machine No.)	7	4	(Check code)	\$0D
------	---------------	---	---	--------------	------

Code indicating that there is no data

■ When the bar code reader setting is changed from the upper equipment

\$01	(Machine No.)	ESC	(m1)	(m2)	(Check code)	\$0D
------	---------------	-----	------	------	--------------	------

Command character string

How to Use Command Link Unit V700-L12

V700-L12 is a communication link unit for communication relay of RS-232C output equipment such as bar code readers and RFID system. (Hereinafter refer to as "link unit".) It is used to connect plural sets of RS-232C output equipment to one port of the upper equipment.



Information only required for connection of the bar code reader and the link unit is described here. When used, be sure to read the operation manual of the link unit V700-L12.

CHECK!

Part names

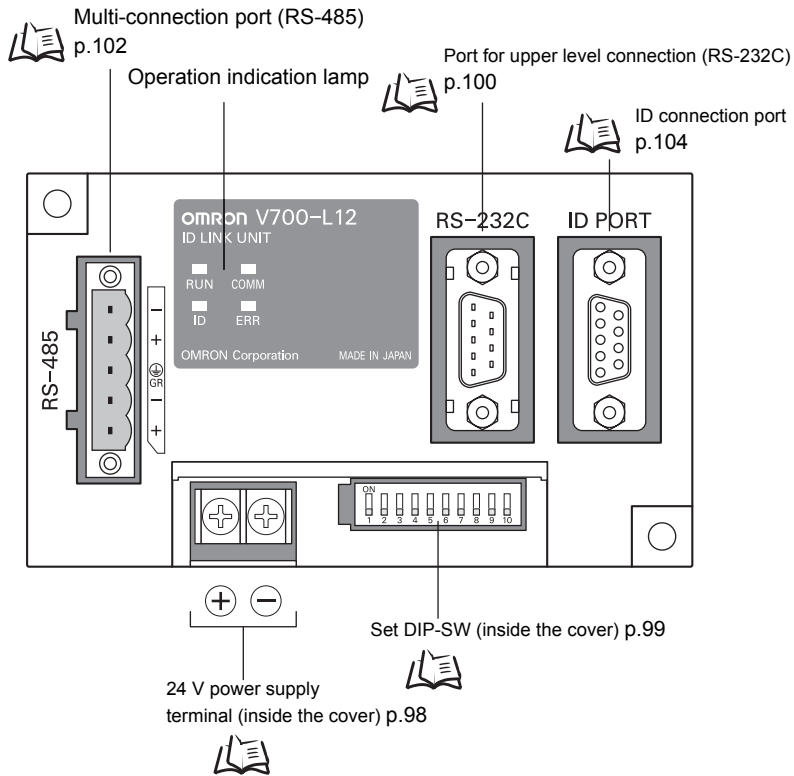

Operation indication lamp

Operation condition of the link unit is indicated with four LED.

LED	Description
RUN	Illuminate during normal operation of the link unit.
COMM	Illuminate during data communication with the upper equipment.
ID	Illuminate during data communication with the bar code reader.
ERR	Illuminate in the event of a failure during data communication with upper equipment or a bar code reader.

CAUTION

GR (frame ground) terminal is in the multi-connection port.

D type grounding (former type 3 grounding) should be performed.



General specification

Item	Specification
Number of connected antenna set	1
Power voltage	24 VDC + 10 % -15 %
Power consumption	10 W or less
Insulation resistance	50 mM ohm or more (at 500 VDC mega), between power terminal bulk blocs and ground terminals
Withstand voltage	100 VAC (50/60 Hz, 1 min), apply to power terminals and ground terminals, and leak current must be 5 mA or less
Resistance to vibration	10 to 150 Hz, double amplitude 0.20 mm, vibration with acceleration of 15 m/s ² , at each X, Y, Z direction 8 min. each, 10 sweeps applied, without abnormal
Impact resistance	Apply shock with acceleration of 150 m/s ² , 3 times for each X, Y, Z direction, total 18 times, without abnormality.
Ambient temperature	At operation: 0 to +45 °C At storage: -15 to +50 °C (without freeze or dew condensation)
Ambient humidity	At operation and storage: 35 to 85 % RH (without dew condensation)
Enclosure rating	IP20 (IEC60529 Standard)
Ground	D type grounding (former type 3 grounding)
Mass	Approx. 185 g

Communication function

Item	Specification
Machine No.	01 to 31
Communication speed with the upper equipment	48000/9600/19200/38400 bps
Data transmission procedure to the upper equipment	<p>Normal procedure (polling procedure)</p> <ul style="list-style-type: none"> • When inputting data from the upper equipment, it outputs to the ID port immediately and transmits received reply to the upper equipment. • When inputting data from the ID port, it waits for the inquire command and transmits data. • In case of 1: N connection, this procedure is recommended. <p>Through procedure (immediate transmission system)</p> <ul style="list-style-type: none"> • When inputting data from the upper equipment, it outputs to the ID port immediately. It does not transmit the received reply to the upper equipment. • When inputting data from the ID port, it transmits to the upper equipment immediately.
RS-485 termination resistance	OFF (invalid) ON (valid)

DIP-SW is used for setting each function.

Power supply

Open the cover of the upper side of the body. There is a power terminal.

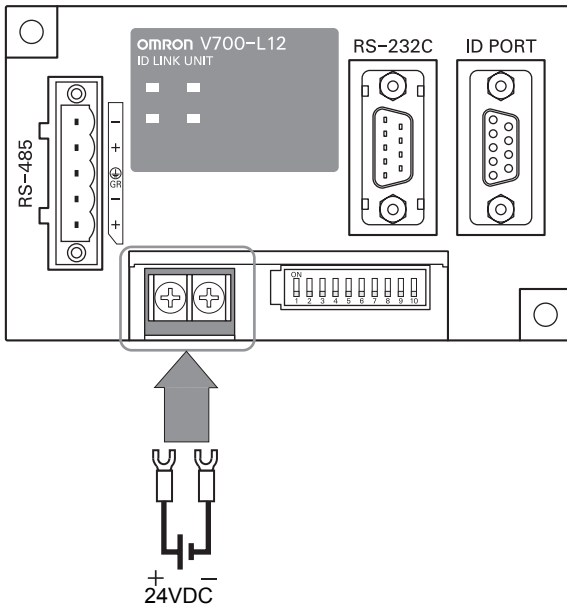

The terminal mounting screw size is M3. Use a crimping terminal which fits to M3 screw.

Shape	Size
Fork type	6.0 mm or less 
Round type	6.0 mm or less 

Connect 24 V power supply device.

Recommended device

Manufacturer	Model
OMRON Corporation	S8VS-03024



Confirmation should be fully made if there is no mistake after wiring.
Faulty wiring may be the cause of failure.

Function setting

Set each function using the DIP-SW of the bar code reader.

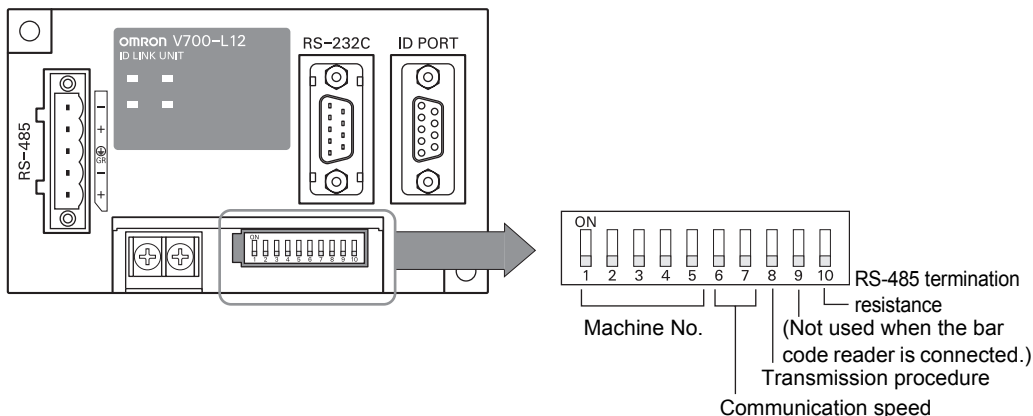

Setting of machine No.

Machine No.	DIP-SW				
	1	2	3	4	5
01	OFF	OFF	OFF	OFF	OFF
02	ON	OFF	OFF	OFF	OFF
03	OFF	ON	OFF	OFF	OFF
04	ON	ON	OFF	OFF	OFF
05	OFF	OFF	ON	OFF	OFF
06	ON	OFF	ON	OFF	OFF
07	OFF	ON	ON	OFF	OFF
08	ON	ON	ON	OFF	OFF
09	OFF	OFF	OFF	ON	OFF
10	ON	OFF	OFF	ON	OFF
11	OFF	ON	OFF	ON	OFF
12	ON	ON	OFF	ON	OFF
13	OFF	OFF	ON	ON	OFF
14	ON	OFF	ON	ON	OFF
15	OFF	ON	ON	ON	OFF
16	ON	ON	ON	ON	OFF

Machine No.	DIP-SW				
	1	2	3	4	5
17	OFF	OFF	OFF	OFF	ON
18	ON	OFF	OFF	OFF	ON
19	OFF	ON	OFF	OFF	ON
20	ON	ON	OFF	OFF	ON
21	OFF	OFF	ON	OFF	ON
22	ON	OFF	ON	OFF	ON
23	OFF	ON	ON	OFF	ON
24	ON	ON	ON	OFF	ON
25	OFF	OFF	OFF	ON	ON
26	ON	OFF	OFF	ON	ON
27	OFF	ON	OFF	ON	ON
28	ON	ON	OFF	ON	ON
29	OFF	OFF	ON	ON	ON
30	ON	OFF	ON	ON	ON
31	OFF	ON	ON	ON	ON
Setting not allowed	ON	ON	ON	ON	ON

Other setting

Setting item	Initial setting	Description
Communication speed	9600 bps	Communication speed between the link unit and the upper equipment is set. • 4800 bps: DIP-SW6 is set to ON, DIP-SW7 is set to OFF • 9600 bps: DIP-SW6 is set to OFF, DIP-SW7 is set to OFF • 19200 bps: DIP-SW6 is set to OFF, DIP-SW7 is set to ON • 38400 bps: DIP-SW6 is set to ON, DIP-SW7 is set to ON
Transmission procedure	Normal procedure	Set data transmission system to upper equipment. • Normal procedure (polling procedure): OFF • Through procedure (immediate transmission system): ON
RS-485 termination resistance	OFF (invalid)	Set whether to make RS-485 termination resistance valid. Turn on the link unit on both sides of transmission path. (When only one set is connected, turn it ON.)

Upper connection port specification

A port to connect with the upper equipment using RS-232C. A dust cover is attached before shipping. Remove it when used.

Item	Specification				
Connector specification	D-sub 9 pin Connector plug Lock screw: #4-40UNC				
Cable length	Max. 15 m				
Communication system	In compliance with RS-232C				
Synchronous system	Asynchronous system				
Communication control system	One-to-N procedure dedicated to OMRON				
Communication speed	4800/9600/19200/38400 bps (Set with DIP-SW)				
Character format (fixed)	Start bit	Data bit	Parity bit	Stop bit	Total
	1	8	None	1	10
Check code (Error detection system)	FCS (Frame Check Sequence)/Vertical parity system				

Pin arrangement

Connector cap is not conducting with GR (frame ground).

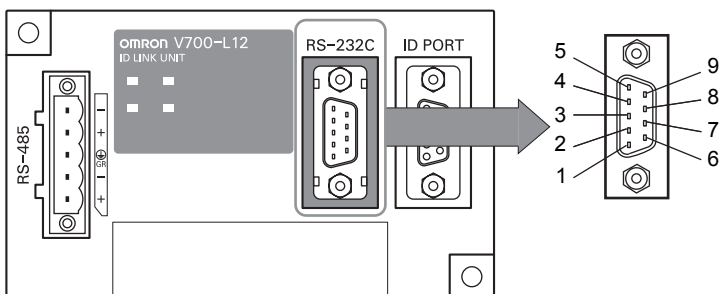

PinNo.	Signal name	Function	Signal direction
1	-	Not connected	-
2	RD	Received data	Input
3	SD	Transmission data	Output
4	-	Not connected	-
5	SG	Ground for signal	-
6	-	Not connected	-
7	RS	Transmission request (Normally ON when operating)	Output
8	CS	Transmission allowed	Input
9	-	Not connected	-



RS signal control from the upper equipment

In case of 1: N connection with RS-232C interface of the upper equipment, the RS signal of the upper equipment should be input to the CS signal of the link unit. Turn OFF the RS signal within 15ms after data transmission is finished. This control should be performed for normal operation.

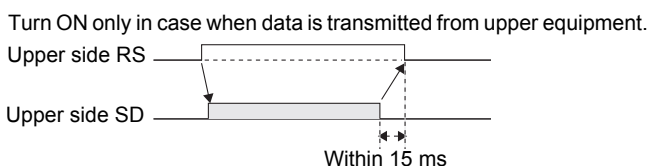

■ Wiring

Example of wiring when connecting with PC/AT compatible PC is explained.

Cable length should be 15 m or less.

Recommended parts

		Model	Manufacturer
Cable		CO-MA-VV-SB 5PX28AWG	Hitachi Cable, Ltd.
Connector	Socket	XM2D-0901	OMRON Corporation
	Hood	XM2S-0913	OMRON Corporation

Wiring method 1

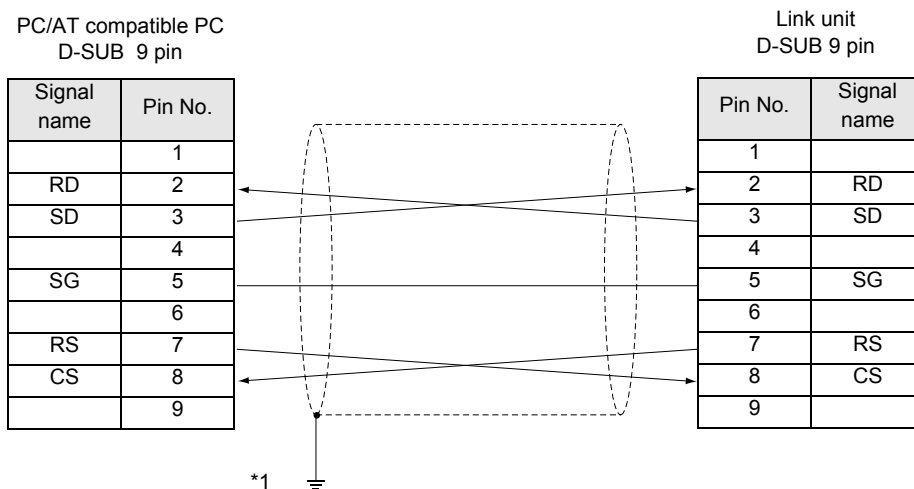

Wiring method 2

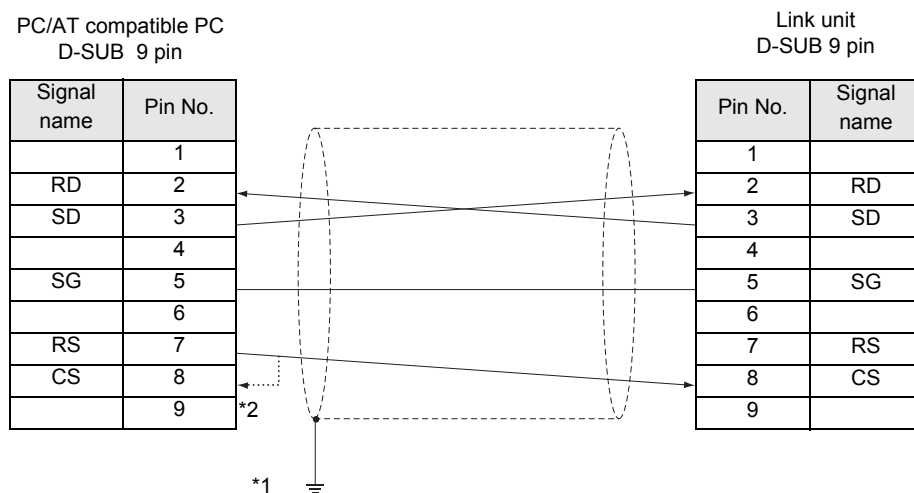

*1 Ground the shield wire on either PC/AT compatible PC side or link unit side.

*2 When CS function is used on PC side, a return line is required.

Multi-connection port specification

When plural bar code readers are connected to one RS-232C port of the upper equipment, connect to a multi-connection port of other link unit.

When the upper equipment has the RS-485 port, connect this port to act as upper connection port. However, when the multi-connection port is used as the upper connection port, the upper connection port (RS-232C) of the link unit cannot be used. GR (frame ground) terminal is also on this port.

Item	Specification				
Connector specification	5 pin special connector (accessory for the link unit)				
Cable length	Total length: Max. 1 km				
Communication system	In compliance with RS-485				
Synchronous system	Asynchronous system				
Communication control system	One-to-N procedure dedicated to OMRON				
Communication speed	4800/9600/19200/38400 bps (Set with DIP-SW)				
Character format (fixed)	Start bit	Data bit	Parity bit	Stop bit	Total
	1	8	None	1	10
Error detection system	FCS (Frame Check Sequence)				

Pin arrangement

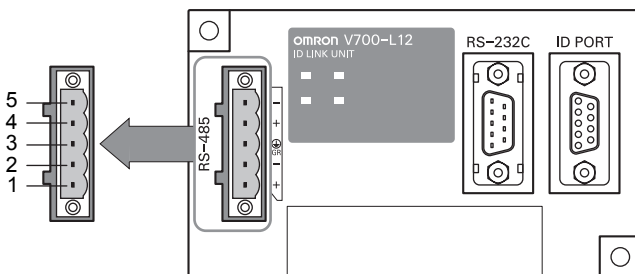

Pin No.	Signal name	Function
5	-	Short circuit with terminal 2 inside the circuit
4	+	Short circuit with terminal 1 inside the circuit
3	GR	Frame ground
2	-	Short circuit with terminal 5 inside the circuit
1	+	Short circuit with terminal 4 inside the circuit



When connecting with RS-485 interface of the upper equipment
The upper equipment should be in data reception condition within 15 ms after data transmission.
This control should be performed for normal operation.

CAUTION

GR (frame ground) terminal is in the multi-connection port.
D type grounding (former type 3 grounding) should be performed.



■ Cables

Recommended parts

		Model	Manufacturer
Cable	RS-485 signal line	MVVS 2CX0.5SQ	Tachii Electric Wire Co., Ltd.
	Frame ground wire	(Cables of AWG22 to 20)	
Crimping terminal	When connecting one wire to one terminal	AI0.5-8WH	PHOENIX CONTACT
	When connecting two wires to one terminal	AI-TWIN2 x 0.5-8WH	
Tools for crimping terminal		CRIMPFOX UD6	

■ Wiring method

1. Attach crimping terminals on a cable where coating is peeled.
2. Insert each wire to each connector hole with attention to the direction of the connector.
3. Tighten the screws for fixing the connector cable.

Appropriate tightening torque is approx. 0.3 N.m.



When connecting with RS-485 interface of the upper equipment
The upper equipment should be in data reception condition within 15 ms after data transmission. This control should be performed for normal operation.

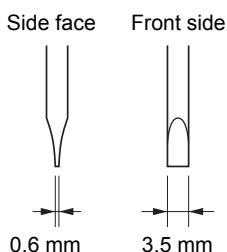

Recommended driver

Manufacturer	Model
OMRON Corporation	XW4Z-00C

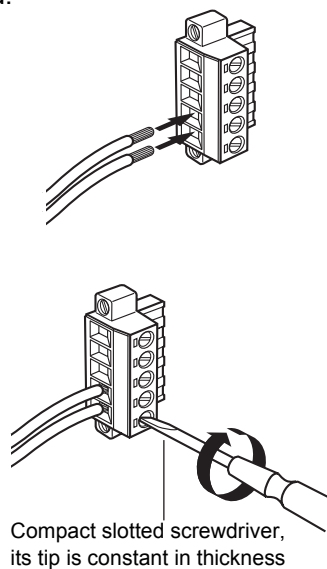

4. Connect the connector to the link unit.

Fit the direction of the connector on the link unit side and the cable, insert firmly to the end and tighten the fixing screws.



Uncoupling the connector
Loosen two fixing screws completely and pull off the connector straight back holding the protrusion. When it is not pulled off easily, hold the link unit body and pull it again.

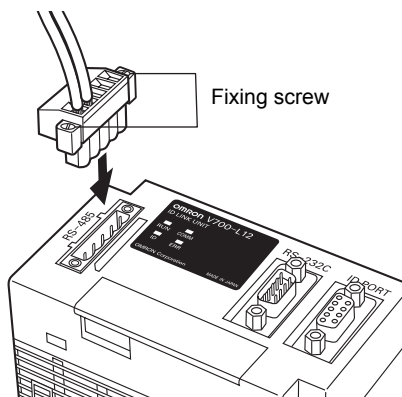

ID connection port specification

This is a dedicated port to connect the bar code reader.

Item		Specification				
Connector specification		D-Sub 9 pin connector socket M2.6				
Power supply	Electrical power supply	5 V \pm 5 %				
Communication part	Communication system	In compliance with RS-232C				
	Synchronous system	Asynchronous system				
	Communication control system	One-to-one procedure dedicated to OMRON				
	Communication speed (fixed)	9600 bps				
	Character format (fixed)	Start bit	Data bit	Parity bit	Stop bit	Total
		1	8	None	1	10
Error detection system		Even number parity				

Pin arrangement

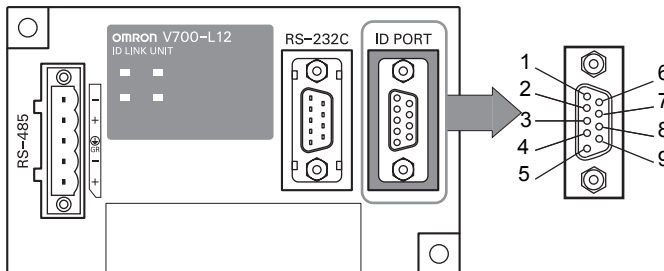

Pin No.	Signal name	Function	Signal direction
1	-	Not connected	-
2	SD	Transmission data	Output
3	RD	Received data	Input
4	RS	Transmission request	Output
5	CS	Transmission permitted (Normally ON when operating)	Input
6	5V	+5 V (5VDC \pm 5 %) supply	Output
7	0V	+0 V supply (connected to SG internally)	Output
8	-	Transmission allowed	-
9	SG	Ground for signal	-

Command specification

Command to control the link unit (in case of one-to-N procedure dedicated to OMRON) is explained in this section. Transmit so that distance between each character of the command is less than 200 ms. When the distance is 200 ms or more, it is recognized as separation of commands.

SOH	Machine No.	Communication data with the bar code reader	Check code	CR
\$01				

Designation of link unit process (DLE) command

Item	Description
SOH (Start Of Header)	Control code (\$01) indicating the head of a frame
Machine No.	Machine No. (1 to 32, 99) set with the DIP-SW. When the machine No. is 99, all units are regarded as own machine.
Bar code reader and communication data	Upper equipment > link unit Command data to transmit to the bar code reader. However, in case when the first character is DLE (10 h), it is handled as link unit process command defined by the next character. <ul style="list-style-type: none"> • P (50 h): Polling (Invalid in case of through procedure) • R (52 h): Resend request • C (43 h): Buffer clear
	Link unit > Upper equipment Response data from the bar code reader
Check code	2 characters of 8-bit from the character immediately after SOH to immediately before the check code, removing each exclusive OR (ExOR) which is converted to ASCII code. E.g.: In case of [SOH]01020000000600 (check code) [CR] Check code = "05" 30h (ExOR) 31h (ExOR) 30h (ExOR) 32h (ExOR) 30h (ExOR) 30h (ExOR) 30h (ExOR) 30h (ExOR) 30h (ExOR) 30h (ExOR) 30h (ExOR) 30h (ExOR) 30h (ExOR) 30h (ExOR) 36h (ExOR) 30h (ExOR) 30h = 05h (ASCII conversion) ↓ "0" (30h) "5" (35h)
CR (Carriage Return)	Control code (\$0D) indicating the end of a frame

■ **Polling (P)**

When the transmission procedure is "Normal procedure (polling procedure)", transmit the oldest data in the buffer as a response.

■ **Input command**

\$01	(Machine No.)	\$10	P	(Check code)	\$0D
------	---------------	------	---	--------------	------

■ **Response**

When there is data in buffer

\$01	(Machine No.)		Communication data with the bar code reader		(Check code)	\$0D
------	---------------	--	---	--	--------------	------

When there is no data in buffer

\$01	(Machine No.)	7	4	(Check code)	\$0D
------	---------------	---	---	--------------	------

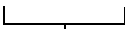
 Code indicating that there is no data

In case of "Through procedure (normal output procedure)", no response is output even if command is input.

■ **Resend request (R)**

The response sent before is transmitted again.

■ **Input command**

\$01	(Machine No.)	\$10	R	(Check code)	\$0D
------	---------------	------	---	--------------	------

■ **Response**

\$01	(Machine No.)		Communication data with the bar code (same as immediately before)		(Check code)	\$0D
------	---------------	--	---	--	--------------	------

■ Buffer clear (C)

Clears all the buffer in the link unit.

▪ Input command

\$01	(Machine No.)	\$10	C	(Check code)	\$0D
------	---------------	------	---	--------------	------

▪ Response

\$01	(Machine No.)	0	0	(Check code)	\$0D
------	---------------	---	---	--------------	------

When a code other than 00 is returned p.110

■ Change the communication frame with the bar code reader to [CR] (X)

▪ Input command

\$01	(Machine No.)	\$10	X	(Check code)	\$0D
------	---------------	------	---	--------------	------

▪ Response

\$01	(Machine No.)	0	0	(Check code)	\$0D
------	---------------	---	---	--------------	------

When a code other than 00 is returned p.110

Communication frame with the bar code is as shown below.

Communication data with the bar code reader								CR
								\$0D

Control code indicating frame end

■ Change the communication frame with the bar code reader to [STX] to [ETX] (Y)

▪ Input command

\$01	(Machine No.)	\$10	Y	(Check code)	\$0D
------	---------------	------	---	--------------	------

▪ Response

\$01	(Machine No.)	0	0	(Check code)	\$0D
------	---------------	---	---	--------------	------

When a code other than 00 is returned p.110

Communication frame with the bar code is as shown below.

SOH	Communication data with the bar code reader								CR
\$02									\$03

Control code indicating frame start

Control code indicating frame end

However, it returns to default ([CR] mode) when the power is turned on or off.

Connection with upper equipment

■ When connected with RS-232C

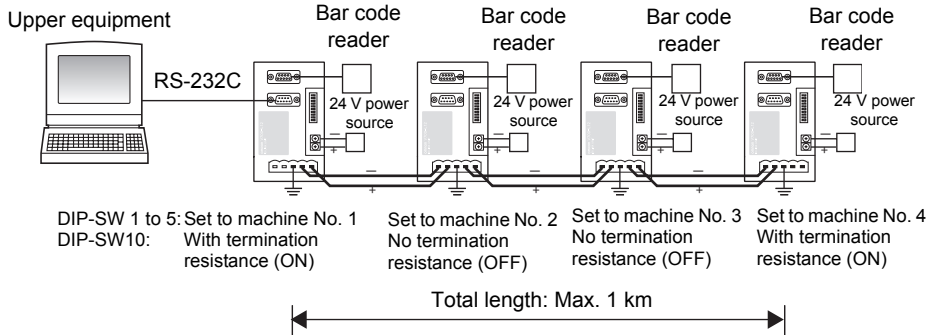

When connecting with 1:N using the link unit, it is required to input the RS signal normally controlled by the upper equipment to the CS signal. Turn OFF the RS signal within 15 ms after data transmission is finished. This control should be performed for normal operation.

■ How to deal in case when RS signal control on the upper equipment is impossible

Connect the upper equipment to the RS-485 communication line using K3SC-10, which makes communication switching control using RS signal unnecessary.

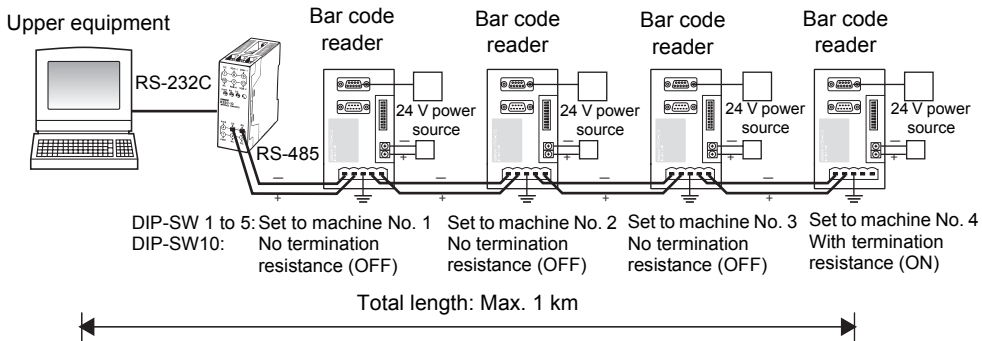

■ When connected with RS-485

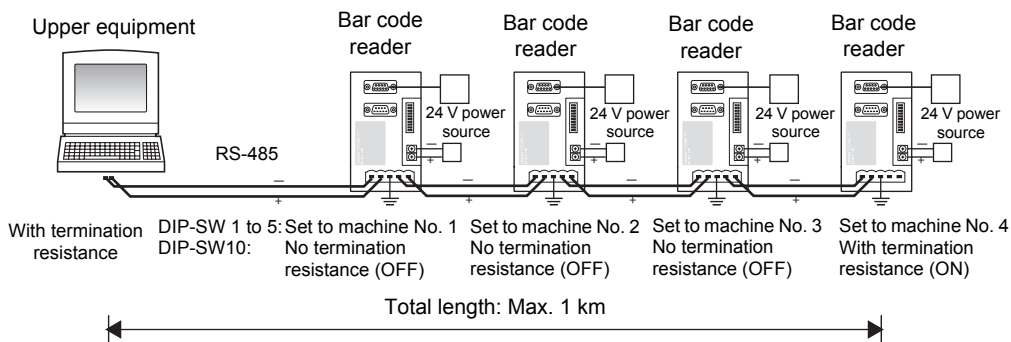

CHECK!

The upper equipment should be in data reception condition within 15 ms after data transmission.
This control should be performed for normal operation.

Troubleshooting of link unit

■ In case of no response (cannot receive) or garble

You can check the error condition with illumination condition of the operation indication lamp.

Operation indication lamp ● : Lights out ○ : Illuminate

RUN	COMM	ID	ERR	Check point
○	●	●	●	<ul style="list-style-type: none"> • Connection of RS-232C cable (Wrong connection) • Command format (Existence of [SOH])
○	●	●	○	<ul style="list-style-type: none"> • Inconsistency of communication condition setting on upper equipment side (communication speed, etc.) and communication setting on the link unit side • RS-232C cable wiring (effect of circumference noise)
○	○	●	●	<ul style="list-style-type: none"> • Inconsistency of the machine No. designated with the command and the machine No. setting on the link unit side
○	○	●	○	<ul style="list-style-type: none"> • Command format ([CR], calculation of check codes, distance of command characters, etc.) • RS-232C cable wiring (effect of circumference noise) • There are 2 sets or more machine No. settings of the link unit on one system (*1)
○	○	○	●	<ul style="list-style-type: none"> • Connection of RS-232C cable (Wrong connection) • When connected to the upper equipment with RS-485, switching timing (time) of communication with the upper equipment
●	●	●	●	<ul style="list-style-type: none"> • 24 VDC power source line check

*1 Operation indication lamp repeats to blink other than during command transmission.

■ When only a specified link unit communication is abnormal

You can check the error condition with illumination condition of the operation indication lamp.

Operation indication lamp ● : Lights out ○ : Illuminate

RUN	COMM	ID	ERR	Check point
○	●	●	●	<ul style="list-style-type: none"> • Connection of RS-485 cable (Wrong connection) • Connection of RS-232C cable (Wrong connection) • RS signal control with the upper equipment (RS signal is always OFF or turns ON after command transmission) (*2)
○	●	●	○	<ul style="list-style-type: none"> • Inconsistency of communication condition setting on upper equipment side (communication speed, etc.) and communication setting on the link unit side • RS-485 cable wiring (effect of circumference noise)
○	○	●	●	<ul style="list-style-type: none"> • Inconsistency of communication condition setting on upper equipment side (communication speed, etc.) and communication setting on the link unit side
○	○	●	○	<ul style="list-style-type: none"> • RS signal control of the upper equipment (Turns OFF before ending command transmission) (*2)
○	○	○	●	<ul style="list-style-type: none"> • RS signal control of the upper equipment (RS signal is always ON) (*2)
●	●	●	●	<ul style="list-style-type: none"> • 24 VDC power source line check

*2  Upper connection port p.100

■ **Error code**





When following codes are returned as a response, error occurred. Check by referring following table.

End code	Error cause	Check point
93	Bar code reader communication malfunction	<ul style="list-style-type: none"> • Cable wiring of the bar code reader (effect of circumference noise)
9A	Bar code reader malfunction	<ul style="list-style-type: none"> • Connection of the interface connector to the bar code reader • Bar code reader cable disconnection

MEMO

Section 6

Appendix

 External Dimension	114
 Troubleshooting	120
 ASCII Code Table	121
 Explanation of Terms	122
 Corresponding Bar Code List	127

External Dimension

Bar code reader
V500-R521B2

(Unit: mm)

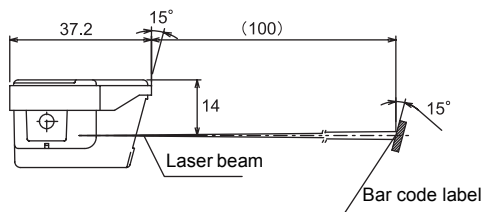
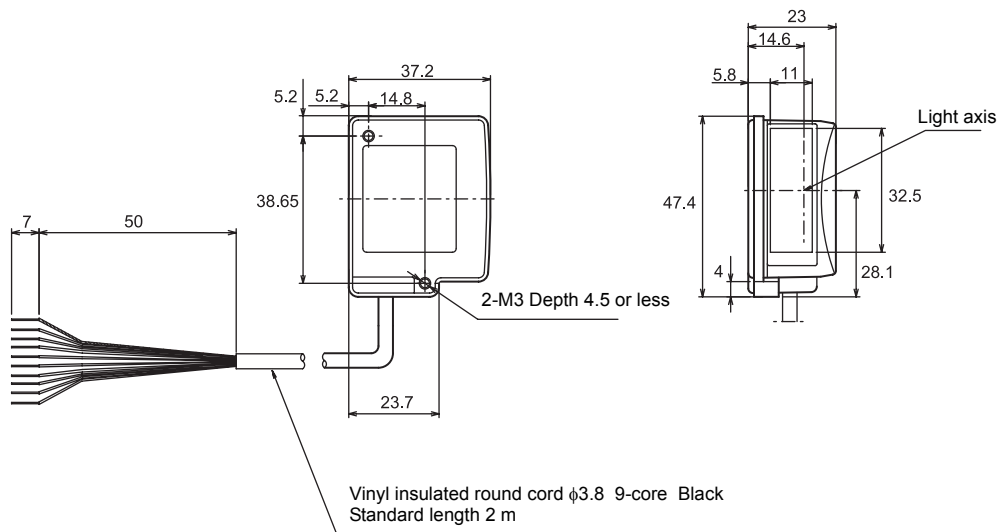

Bar code reader
V500-R521C2

(Unit: mm)

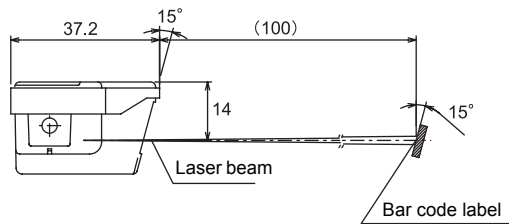
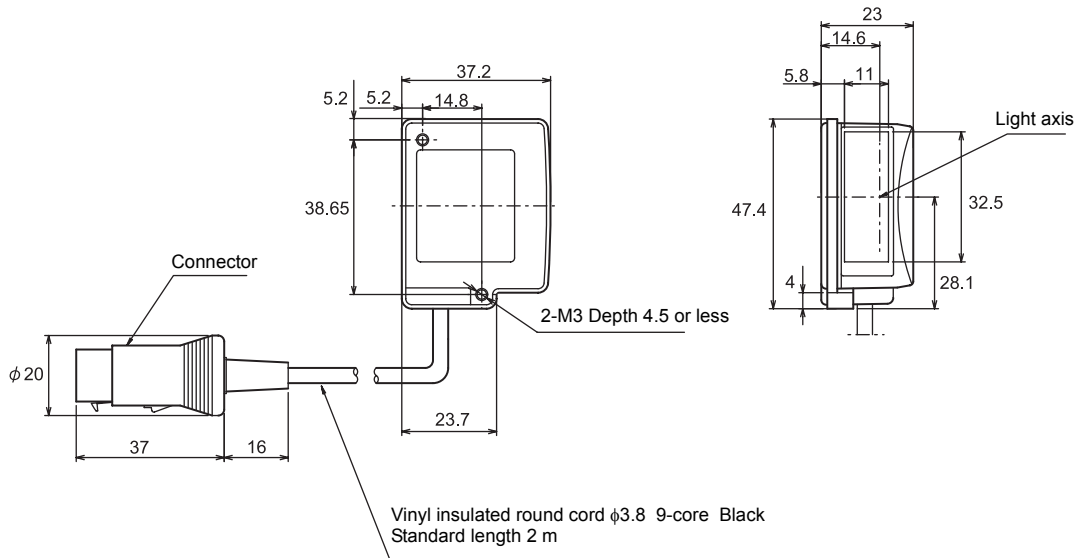

Cable for programmable controller connection made by OMRON
V509-W011

(Unit: mm)

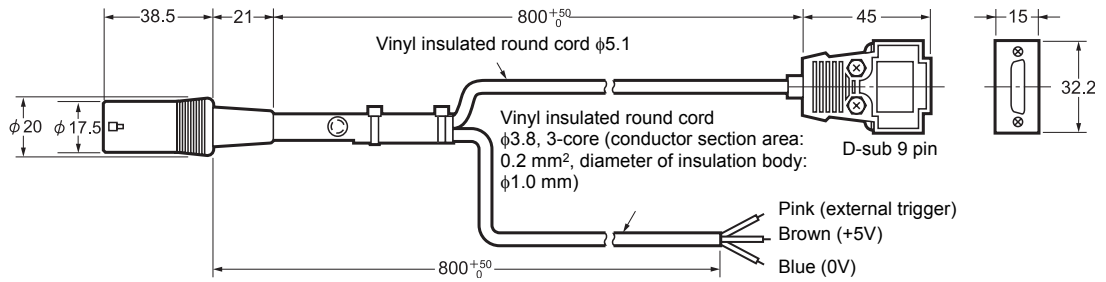

Bar code reader side
DIN 8 pin

No.	Signal name
1	SD
2	RD
3	RS
4	CS
5	TRIG
6	-
7	SG
8	+5V

Upper equipment side
D-sub 9 pin

Signal name	No.
FG	1
SD	2
RD	3
RS	4
CS	5
-	6
-	7
-	8
SG	9

Shield cable

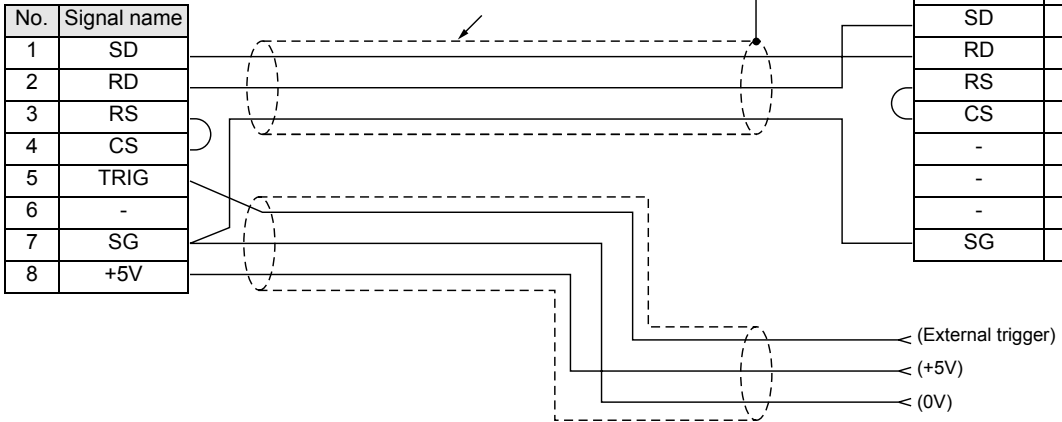

**Cable for connecting with PC/AT compatible PC
V509-W011D**

(Unit: mm)

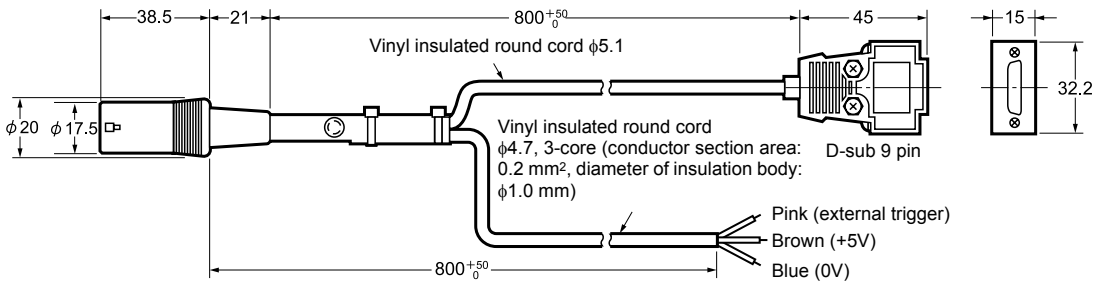

Bar code reader side
DIN 8 pin

No.	Signal name
1	SD
2	RD
3	RS
4	CS
5	TRIG
6	-
7	SG
8	+5V

Upper equipment side
D-sub 9 pin

Signal name	No.
-	1
RD	2
SD	3
ER	4
SG	5
DR	6
RS	7
CS	8
-	9
Shield wire	Connector Cover

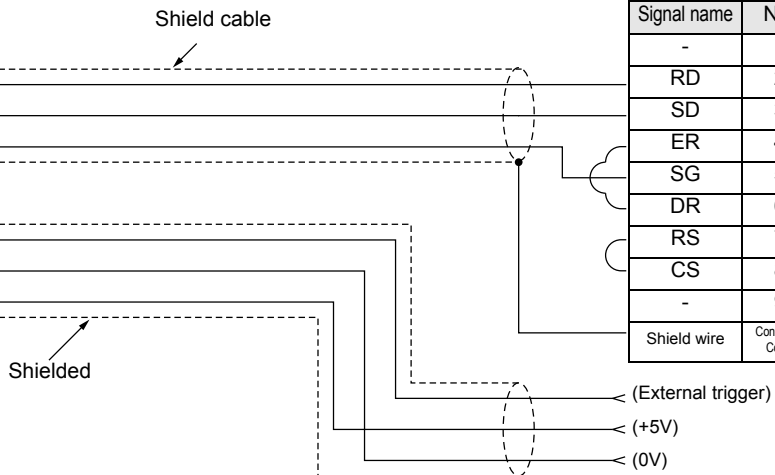

Communication link unit V700-L12 connection cable
V509-W019

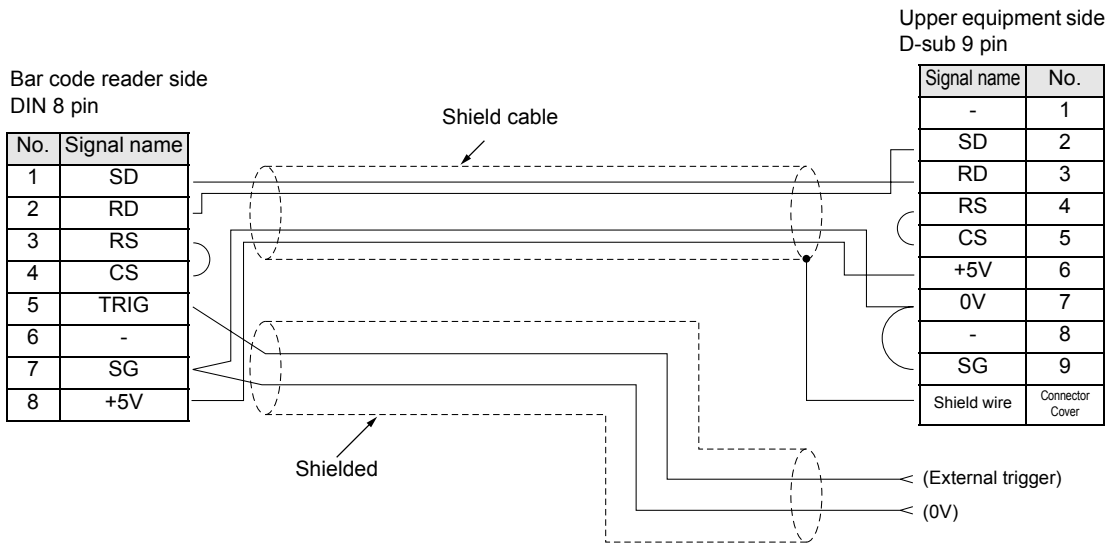
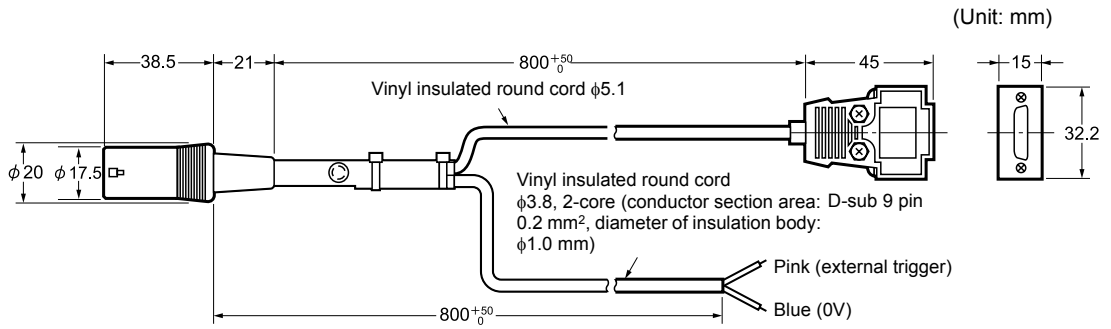

Communication link unit
V700-L12

(Unit: mm)

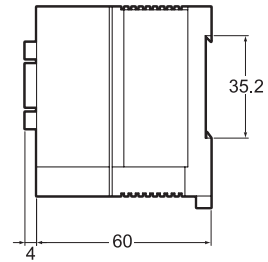
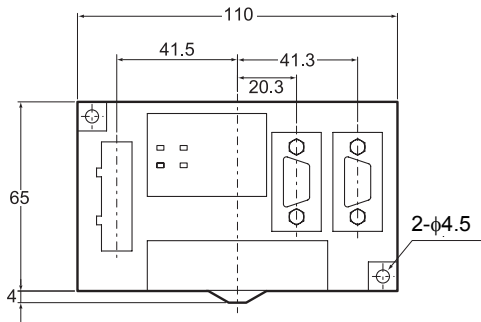

Dimension of mounting hole process

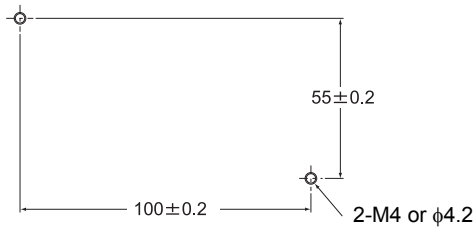

Troubleshooting

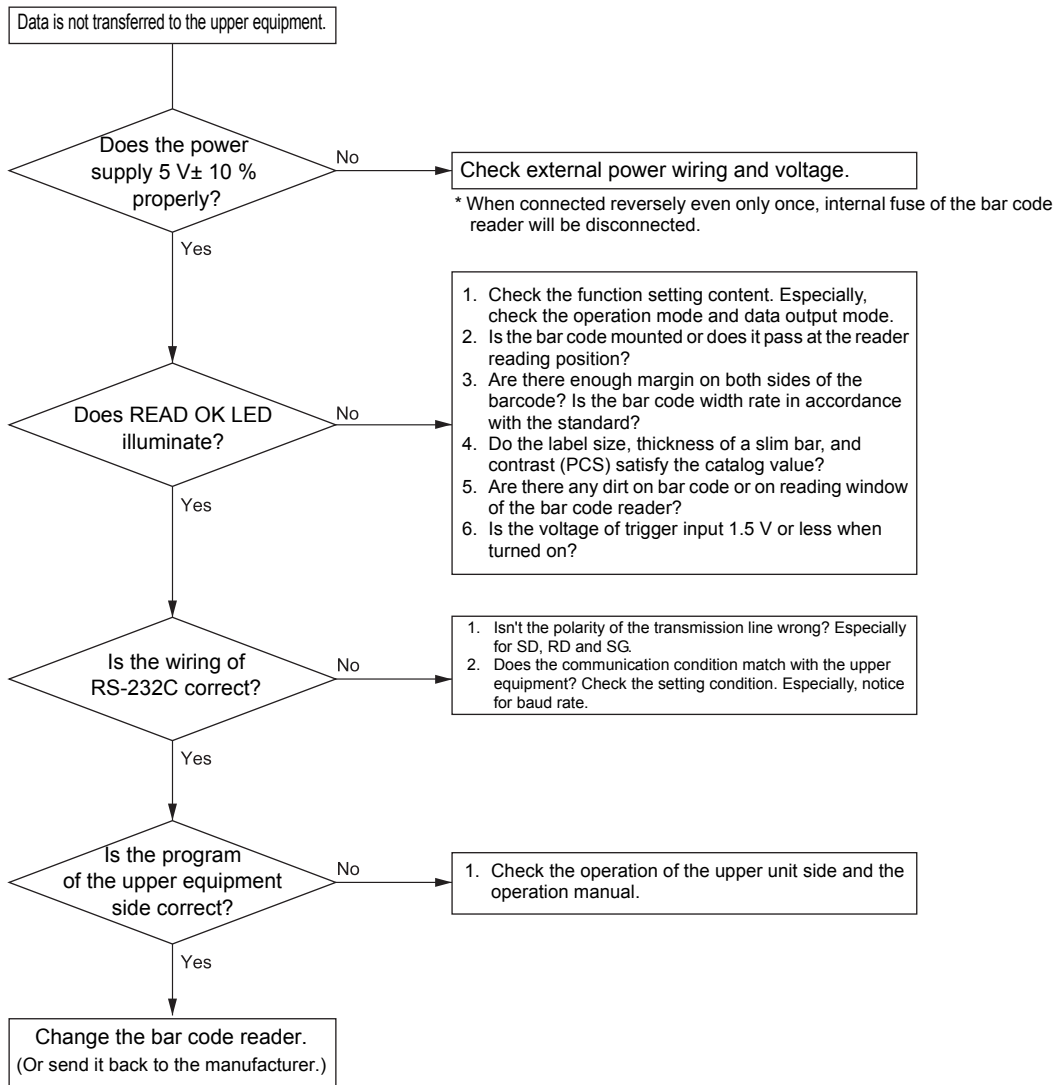

 Troubleshooting when communication link unit is used p.110

ASCII Code Table

Character	Data (Hexadecimal number)	Character	Data (Hexadecimal number)	Character	Data (Hexadecimal number)	Character	Data (Hexadecimal number)
NUL	00	SP	20	@	40	'	60
SOH	01	!	21	A	41	a	61
STX	02	"	22	B	42	b	62
ETX	03	#	23	C	43	c	63
EOT	04	\$	24	D	44	d	64
ENQ	05	%	25	E	45	e	65
ACK	06	&	26	F	46	f	66
BEL	07	'	27	G	47	g	67
BS	08	(28	H	48	h	68
HT	09)	29	I	49	i	69
LF	0A	*	2A	J	4A	j	6A
VT	0B	+	2B	K	4B	k	6B
FF	0C	,	2C	L	4C	l	6C
CR	0D	-	2D	M	4D	m	6D
S0	0E	.	2E	N	4E	n	6E
S1	0F	/	2F	O	4F	o	6F
DLE	10	0	30	P	50	p	70
DC1	11	1	31	Q	51	q	71
DC2	12	2	32	R	52	r	72
DC3	13	3	33	S	53	s	73
DC4	14	4	34	T	54	t	74
NAK	15	5	35	U	55	u	75
SYN	16	6	36	V	56	v	76
ETB	17	7	37	W	57	w	77
CAN	18	8	38	X	58	x	78
EM	19	9	39	Y	59	y	79
SUB	1A	:	3A	Z	5A	z	7A
ESC	1B	;	3B	[5B	{	7B
FS	1C	<	3C	¥(\)	5C		7C
GS	1D	=	3D]	5D	}	7D
RS	1E	>	3E	^	5E	(~)	7E
US	1F	?	3F	-	5F	DEL	7F

Explanation of Terms

■ Raster scan

Raster scan is a system to scan plural laser beams toward the bar code height direction as shown in the figure.



■ Number of conformance (number of verification)

Decode several times and verify if the results conform. When it conforms for the number of the conformance set beforehand, it is output to RS-232C interface. Number of conformance should be at least twice (number of verification is once) to increase reliability.

■ Narrow bar (slim bar)

The narrower bar in the bar code consists with horizontal bars is called a "narrow bar". The narrow bar should be wider than the minimum resolution which the bar code reader can resolve, to read it.

The thicker bar than the narrow bar is called a wide bar (thick bar).

■ Parity

This is a means to prevent communication error.

"Parity check" is a data check system which adds 1 bit to data and to have the total bit of "1" either in even number or odd number. The added 1 bit at this time is called "parity bit".

■ Modulus check

This is a method to increase bar code reading reliability.

Numerical character or character obtained by specific calculating formula is applied to the end of the data you want to express (also expressed as C/D: check digit in this manual).

After reading a barcode, check the C/D with this calculating formula to avoid reading failure. General check systems are the following three types.

System	Used barcode
Modulus 10/3	Used for barcodes with only numbers. Mainly used for EAN and ITF.
Modulus 43	Used for barcodes including alphabet. Mainly used for CODE39.
Modulus 16	Mainly used for NW-7.

■ Calculation method of modulus 10/3 weight

1. Add the digits in the even positions (the rightmost character is the 1st digit), and multiple it by 3.
2. Add up the odd numbers (excluding the rightmost check digit) in the data digit.
3. Add values of above clauses **1** and **2**, and add to the unit digit.
4. The check digit is the remainder of 10 minus first digit of clause **3**.

[E.g.] When the bar code data is 4901234 (JAN-8)

$$\begin{array}{r}
 \begin{array}{cccccccc}
 & 4 & 9 & 0 & 1 & 2 & 3 & 4 \\
 \hline
 \text{Even digit} & 4 & + & 0 & + & 2 & + & 4 & = & 10 & 10 \times 3 = & 30 \\
 \text{Odd digit} & & 9 & + & 1 & + & 3 & & = & 13 \\
 \hline
 & 30 & + & 13 & = & 43 & \text{(1st digit is 3)} \\
 & 10 & - & 3 & = & 7 & \text{•••Check digit}
 \end{array}
 \end{array}$$

Therefore, data with check character is "49012347".

- Calculation method of modulus 43

1. Allocate the value indicated in table 1 in each data character in a symbol.
2. Add all the data character and divide by 43.
3. The remainder calculated in clause 2 is the check character shown in Table 1.

Table 1: Character value calculated in Modulus 43

Character	Value	Character	Value	Character	Value
0	0	F	15	U	30
1	1	G	16	V	31
2	2	H	17	W	32
3	3	I	18	X	33
4	4	J	19	Y	34
5	5	K	20	Z	35
6	6	L	21	"	36
7	7	M	22	,	37
8	8	N	23	SPACE	38
9	9	O	24	\$	39
A	10	P	25	/	40
B	11	Q	26	+	41
C	12	R	27	%	42
D	13	S	28		
E	14	T	29		

[E.g.] When message "CODE39" is indicated in CODE39

C	O	D	E		3	9
↓	↓	↓	↓	↓	↓	↓

Numerical conversion $12 + 24 + 13 + 14 + 38 + 3 + 9 = 113$

$113 / 43 = 2$ Remainder 27 (Character of 27 is R)
R ... Check digit

Therefore, data with check character is "CODE39R".

- Calculation method of modulus 16
1. Allocate the value indicated in table 2 to the symbol character.
 2. Add all the message character (including start/stop character) and divide by 16.
 3. When the remainder is 0, check character is 0.
In other cases, take the remainder value from 16 and the result is the check character value.
 4. Result of clause 3 is the check character value shown in table 2.

Table 2: Character value calculated in Modulus 16

Character	Value	Character	Value
0	0	•	10
1	1	\$	11
2	2	:	12
3	3	/	13
4	4	,	14
5	5	+	15
6	6	A	16
7	7	B	17
8	8	C	18
9	9	D	19

[E.g.] When "A37859B" is indicated in Codabar

A 3 7 8 5 9 B
↓ ↓ ↓ ↓ ↓ ↓ ↓

Numerical conversion 16 + 3 + 7 + 8 + 5 + 9 + 17 = 65

65 / 16 = 4 Remainder 1 (Character of 1 is +)
+ ... Check digit

Therefore, data with check character is "A37859B+".

■ PCS

PCS is an abbreviation of "Print Contrast Signal" and is a value of reflectance ratio of space (ground color) and a bar indicated in a calculation formula.

PCS can be calculated by the following formula.

$$PCS = \frac{RL - RD}{RL}$$

- RD: Reflection ratio of a bar
- RL: Reflection ratio of ground color (space)

The PCS of this bar code reader is 0.45 or more. (However, ground color reflection ratio is 85 %.)

When expressing PCS, the above formula only may be a relative value. Ground color (space) reflection ratio condition is required to specify to recognize as an absolute value.

■ MRD

MRD is an abbreviation of "Minimum Reflectance Difference", indicating contrast of bars and spaces. MRD can be calculated by the following formula.

$$MRD = RL - RD$$

- RD: Reflection ratio of a bar
- RL: Reflection ratio of ground color (space)

The MRD of this bar code reader is 32 % or more. (However, ground color reflection ratio is 85 % or more.)

■ RS/CS control

Control system to communicate data between the bar code reader and the upper equipment. Data is transmitted while verifying to hardware through RS/CS line "whether to transmit or not".

■ EAN128 (Reading specification)

The head of EAN128 data always starts with "Start code" + "FNC1".

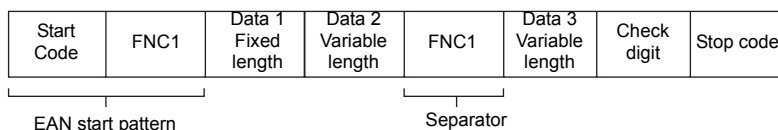

When "Only EAN128 reading is allowed (G6)" is set, codes other than this combination may be read error.

When "All reading allowed including EAN (G5)" is set, CODE128 other than this combination can be read.

Start pattern of EAN128 is converted to "C1" (5Dh43h31h in ASCII code) and output. "FNC1" (separator) indicating data separation is converted to "GS" and output.

Corresponding Bar Code List

■ EAN, UPC



■ CODE39



■ STF



■ NW-7



■ CODE93



■ ITF



■ CODE128



Index

A

ACK/NAK system	41, 78
AND verification	66
ASCII code	121

B

Bar code	20
Buzzer	73

C

C/D	63
Cable output type	18
Check digit	63
Communication condition	77
Communication link unit	
Command specification	105
Connecting cable	118
Error code	111
information	96
LED	96
Troubleshooting	110
Communication speed	77
Communication time	42
Connector output type	18
Consumption current	20
Continuous reading	36, 67
Curvature	23

D

Data length	77
Designation of number of digit	69
DIP-SW	99
Direct code designation	80

E

Effective duration	36, 70
Effective duration designation	
system	36
External dimension figure	33, 114
External trigger signal	29, 30, 36, 57

F

Flow chart	38
Footer	79
Full-time reading	36, 67

H

Header	79
Height	9

I

ID connection port	104
Immediate transmission system	99
Initial setting	58
Input circuit	31
Input command	54
Installation	32

L

Label	9
LED	
Illumination duration	72
Operation indication lamp of the link	
unit	96
READ OK/NG	19
Raster scan	122

M

Machine No.	99
Margin	9
Menu sheet	52
Modulus check	123
Mounting bracket	32, 33
Moving direction	45
MRD	126
Multi-connection port	102
Multi-drop	92
Communication format	95
Flow chart	94

N

Narrow bar	9, 122
No protocol system	41, 78
Nonprocedural system	41
Nonvolatile memory	57
Number of conformance	122
Number of reading digits	20, 69
Number of verification	122

O

One-shot system	29
Output circuit	31
Output format	47

P

Parity	83, 122
PC	88
Connecting cable	117
PCS	126
Pitch angle	22
Plural reading	36, 67
Polling	97, 106
Positive logic	29, 30
Power supply	30
Programmable controller	89
Connecting cable	116
Protocol	41, 78

R

READ NG LED	19
READ OK LED	19
READ OK/NG signal	28, 75
Reading angle	22
Reading conformance	66
Reading failed	47, 68
Reading operation	36
Reading permission/prohibition	61
Reading range	21
Reading rate measurement mode	49
Reading system	36, 67
Reading time	42
Reading trigger	46
Reading window	19
Regular expression	84
Reset	57
RS/CS control	77, 126
RS-232C command	36

S

Setting end	57
Setting start	57
Single reading	36, 67
Skew angle	20
Slim bar	122
Sort reading	83
ST/SP	63
Start code	63
Stop bit	77
Stop code	63

T

Termination resistance	108
TEST button	19, 36
Test reading	49, 79

Through	99
Tilt angle	23
Timing chart	42
Transmission procedure	99
Trigger controlled system	36
Trigger input method	36
Trigger reading	36, 67
Trigger signal synchronous system	29
Troubleshooting	
Communication link unit	110
Reading	120

U

Upper connection port	100
-----------------------	-----

W

Width	9
-------	---

MEMO

MEMO

Revision History

A manual revision code appears as a suffix to the catalog number at the bottom of the front and back covers.

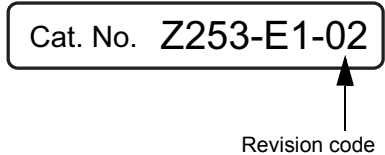

Reprint code	Date	Revised contents
01	March 2007	Original production
02	July 2008	P5: Changed discription in "Warning display." P20: Changed information in <i>General Specification</i> . P21: Deleted "Number of digit" in table P30: Changed model number of recommended parts. P33: Added information to diagram for insulation board. P88, 89: "Wire (When V500-R521B2 is used)" is changed. P95: Changed DLE to ESC in example. P101: "Wiring method 2" is changed. P111: Changed end code. P116: Changed size in figure. P118: Changed information on color and voltage.