

Easy-teach digital fiber amplifier

# E3X-HD

The E3X-HD with 1-button Smart tune set-up provides fast and simple teaching. Dual digital display and advanced features make the E3X-HD ideal even for demanding applications.

- Easy teaching by Smart tuning within a few seconds
- Dynamic Power Control (DPC) for highest operational stability for changing environmental conditions or challenging objects
- EtherCAT and CompoNet Communication units for high-speed field bus connectivity



### Ordering Information

Item	Order code		
	Transistor output models		Communication unit model <sup>*1</sup>
	NPN output	PNP output	
Pre-wired	E3X-HD11 2M	E3X-HD41 2M	-
Fiber amplifier connector	E3X-HD6	E3X-HD8	E3X-HD0

\*1. For field bus connection please chose Communication unit E3X-ECT for EtherCAT or E3X-CRT for CompoNet.

### Accessories (sold separately)

#### Fiber amplifier connectors

Shape	Type	Comment	Order code
	Fiber amplifier connector	2 m PVC cable (3-wire, Master Connector)	E3X-CN11
		2 m PVC cable (1-wire, Slave-Connector)	E3X-CN12
		30 cm PVC cable with M12 plug connector (4 pin)	E3X-CN21-M1J 0.3M
		30 cm PVC cable with M8 plug connector (4 pin)	E3X-CN21-M3J-2 0.3M

#### Communication units

Shape	Communications method	Applicable Fiber Amplifier Units	Order code
	CompoNet	E3X-HD0 E3X-MDA0 E3X-DA0-S	E3X-CRT
	EtherCAT		E3X-ECT

#### Mounting Brackets

Appearance	Model	Quantity
	E39-L143	1

#### End Plate

Appearance	Model	Quantity
	PFP-M	1

## Ratings and Specifications

Item	Type	Standard				For Communications Unit <sup>*1</sup>
	Model	E3X-HD11	E3X-HD41	E3X-HD6	E3X-HD8	E3X-HD0
	Connection method	Pre-wired		Wire-saving connector <sup>*2</sup>		Communications Unit Connector
	Control output	NPN output	PNP output	NPN output	PNP output	—
Light source (wavelength)		Red, 4-element LED (625 nm)				
Power supply voltage		12 to 24 VDC ±10%, ripple (P-P) 10% max.				12 to 24 VDC ±10%, ripple (P-P) 10% max. (Power is supplied from Communication Unit)
Power consumption		Normal Mode: 720 mW max. (Current consumption: 30 mA max. at 24 VDC, 60 mA max. at 12 VDC) Power Saving Eco Mode: 530 mW max. (Current consumption: 22 mA max. at 24 VDC, 44 mA max. at 12 VDC)				
Control output		Load power supply voltage: 26.4 VDC max., open-collector output (Differs for NPN and PNP outputs.) Load current: 50 mA max. (residual voltage: 2 V max.), OFF current: 0.5 mA max.				—
Protection circuits		Power supply reverse polarity protection, output short-circuit protection and output reverse polarity protection				
Response time	Super-high-speed Mode (SHS) <sup>*3</sup>	Operate or reset: 50 μs	Operate or reset: 55 μs	Operate or reset: 50 μs	Operate or reset: 55 μs	Operate or reset: 50 μs
	High-speed Mode (HS)	Operate or reset: 250 μs (default setting)				
	Standard Mode (Std)	Operate or reset: 1 ms				
	Giga-power Mode (GIGA)	Operate or reset: 16 ms				
Mutual interference prevention		Possible for up to 10 units (optical communications sync) <sup>*3</sup>				
Auto power control (APC)		Always ON				
Other functions		Power tuning, differential detection, DPC, timer (OFF-delay, ON-delay, or one-shot), zero reset, resetting settings, and Eco Mode				
Ambient Illumination (Receiver side)		Incandescent lamp: 20,000 lux max., Sunlight: 30,000 lux max.				
Maximum connectable Units		16 units				with E3X-CRT: 16 units with E3X-ECT: 30 units
Ambient temperature range		Operating: Groups of 1 to 2 Amplifiers: -25°C to 55°C Groups of 3 to 10 Amplifiers: -25°C to 50°C Groups of 11 to 16 Amplifiers: -25°C to 45°C  Storage: -30°C to 70°C (with no icing or condensation)				Operating: Groups of 1 to 2 Amplifiers: -25°C to 55°C Groups of 3 to 10 Amplifiers: -25°C to 50°C Groups of 11 to 16 Amplifiers: -25°C to 45°C Groups of 17 to 30 Amplifiers: -25°C to 40°C Storage: -30°C to 70°C (with no icing or condensation)
Ambient humidity range		Operating and storage: 35% to 85% (with no condensation)				
Insulation resistance		20 MΩ min. (at 500 VDC)				
Dielectric strength		1,000 VAC at 50/60 Hz for 1 minute				
Vibration resistance		Destruction: 10 to 55 Hz with a 1.5-mm double amplitude for 2 hours each in X, Y, and Z directions				
Shock resistance		Destruction: 500 m/s <sup>2</sup> , for 3 times each in X, Y, and Z directions				
Degree of protection		IEC 60529 IP50 (with Protective Cover attached)				—
Weight (packed state/Amplifier only)		Approx. 105 g/Approx. 65 g		Approx. 60 g/Approx. 20 g		Approx. 65 g/Approx. 25 g
Materials	Case	Heat-resistant ABS				Heat-resistant ABS (connector: PBT)
	Cover	Polycarbonate (PC)				
Accessories		Instruction Manual				

\*1. The E3X-ECT EtherCAT Communications Unit and the E3X-CRT CompoNet Communications Unit can be used.

\*2. Use either the E3X-CN11 (master connector, 3 conductors) or the E3X-CN12 (slave connector, 1 conductor).

\*3. The communications function and mutual interference prevention function are disabled when the detection mode is set to Super-high-speed mode (SHS).  
If E3X-DA-S or E3X-DA-MDA Amplifier Units are connected that power tuning is performed, mutual interference prevention can be used for up to 6 units.

Output Circuit Diagrams

NPN Output

Model	Operation mode	Timing chart	L/D indicators	Output circuit
E3X-HD11 E3X-HD6	Light-ON		L lit.	
	Dark-ON		D lit.	

PNP Output

Model	Operation mode	Timing chart	L/D indicators	Output circuit
E3X-HD41 E3X-HD8	Light-ON		L lit.	
	Dark-ON		D lit.	

ON delay	OFF delay	One-shot

Note: Timing Charts for Timer Settings (T: Set Time)

## Safety Precautions

### Warning

This product is not designed or rated for ensuring safety of persons either directly or indirectly. Do not use it for such purposes.



### Caution

Do not exceed the rated voltage. Excess voltage may result in malfunction or fire.



Do not use an AC power supply. Using an AC power supply may result in rupturing..



High-temperature environments may result in burn injury.



### Precautions for Safe Use

The following precautions must be observed to ensure safety.

1. Do not use the product in locations where flammable or explosive gas is present.
2. Do not use the product in locations subject to splashing water, oil, or chemicals, or in locations subject to steam.
3. Do not attempt to disassemble, repair, or modify the product.
4. Do not apply voltage or current in excess of the rated ranges.
5. Do not use the product in atmospheres or environments that exceed product ratings.
6. Do not wire the product incorrectly, such as using incorrect power supply polarity.
7. Connect the load properly.
8. Do not short-circuit both ends of the load.
9. Do not use the product if the case is damaged.
10. When disposing of the product, dispose of it as industrial waste.
11. Do not use the product in locations subject to direct sunlight.
12. The surface temperature of the product may rise as a result of the ambient temperature, power supply, or other usage conditions. Use caution when performing maintenance and washing. Failure to do so may result in burn injury.

### Precautions for Correct Use

Do not use the product in atmospheres or environments that exceed product ratings.

#### Amplifier Units

##### Designing

##### Communications Window

The window on the side of the Amplifier Unit provides an optical synchronisation between amplifiers for preventing mutual interference when Amplifier Units are mounted side-by-side. The E3X-MC11 Mobile Console (sold separately) cannot be used. If an excessive amount of light is received via the Sensor, the mutual interference prevention function may not work. In this case, make the appropriate adjustments using the sensitivity adjuster. Mutual interference prevention is effective among E3X-HD, E3X-DA\_S and E3X-MDA amplifiers. It does not function combined with E3X-SD, E3X-NA or E3X-DA\_N.

#### Mounting the Amplifier Unit

##### Mounting on DIN Track

1. Let the hook on the Amplifier Unit's Fiber Unit connection side catch the track and push the unit until it clicks.

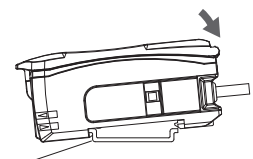

Fiber Unit Connection Side Hook

##### Removing from DIN Track

1. Push the unit in the direction 1
2. Lift it up in the direction 2

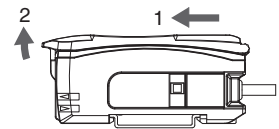

##### Mounting Amplifier Units in Group (Connector Type Models)

1. Mount the Amplifier Units one at a time onto the DIN track and push them until they click. Use E3X-CN11 (Master connector) for the master Amplifier Unit and E3X-CN12 (Slave connector) for the slave Amplifier Units.
2. Slide the Amplifier Units in the direction 2.
3. Use End Plates (PFP-M: separately sold) at the both ends of the grouped Amplifier Units to prevent them from separating due to vibration or other cause.
4. Tighten the screw on the End Plates using a driver.

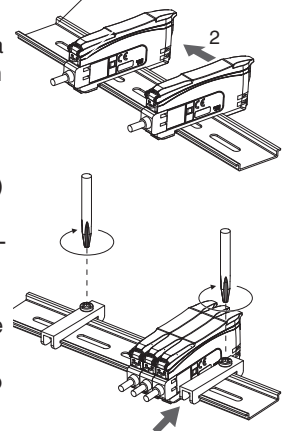

Tighten the screw while pressing the End Plate.

**Note 1.** Up to 16 Amplifier Units can be mounted in a group.  
**2.** Under environments such as vibration, use an end plate even with a single amplifier unit.

**Mounting the Fiber Unit**

**Use Fiber Cutter**

- 1. Insert a Fiber Unit into a fiber cutter hole.
- 2. Press down the blade at a single stroke to cut the Fiber Unit.

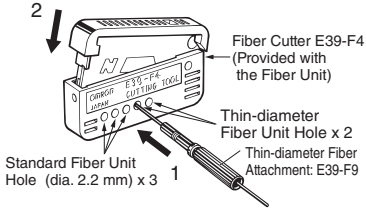

**Mount Fiber Unit**

- 1. Open the protective cover.
- 2. Raise the lock lever.
- 3. Insert the Fiber Unit in the fiber unit hole to the bottom.
- 4. Return the lock lever to the original position and fix the Fiber Unit.

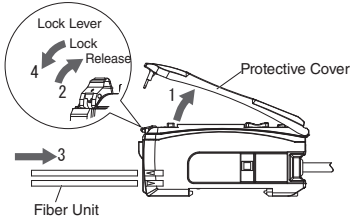

**Note** When mounting a coaxial reflective Fiber Unit, insert the single-core Fiber Unit to the upper hole (Emitter side) and the multi-core Fiber Unit to the lower hole (Receiver side).

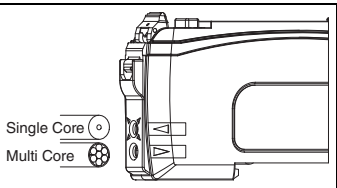

Dimensions

Amplifier Units

Pre-wired Models

E3X-HD11

E3X-HD41

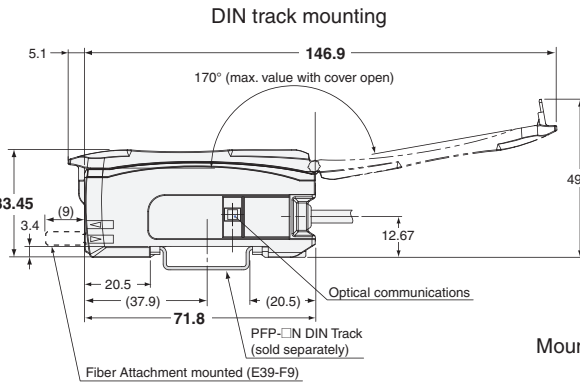
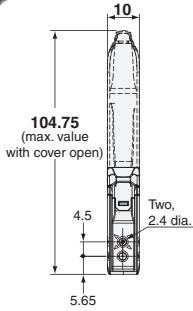
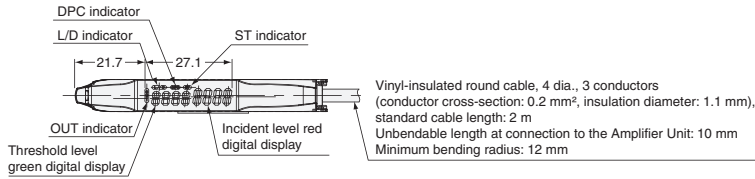

With Mounting Bracket Attached

**Note:** When using E39-L143 Mounting Brackets, there will be small gaps between the Amplifier Units if they are mounted side by side.

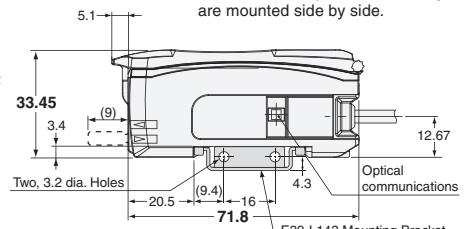

Mounting Holes

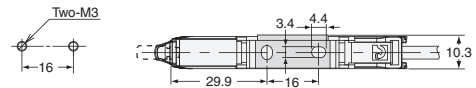

Wire-saving connector Models

E3X-HD6

E3X-HD8

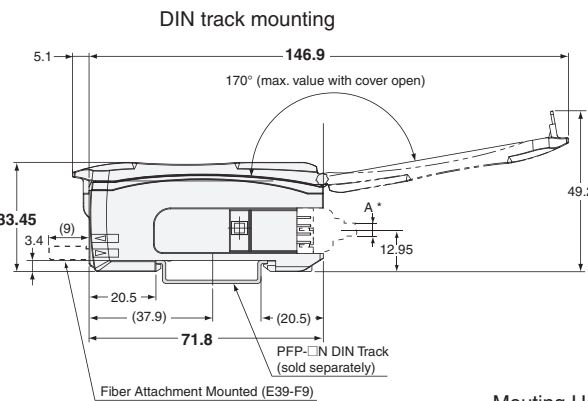
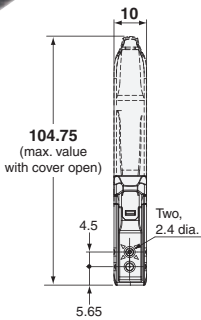
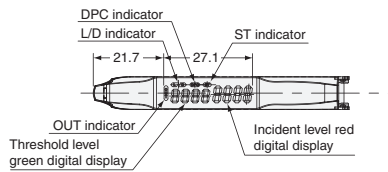

With Mounting Bracket Attached

**Note:** When using E39-L143 Mounting Brackets, there will be small gaps between the Amplifier Units if they are mounted side by side.

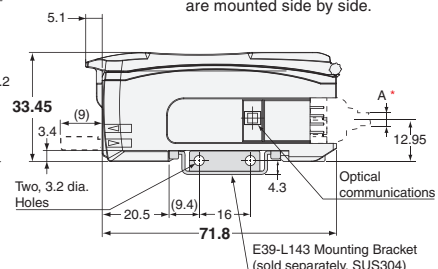

Mounting Holes

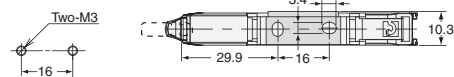

\* The cable diameters are as follows:

E3X-CN11 (3 conductors)	4.0 dia.
E3X-CN21 (1 conductor)	2.6 dia.

Communications Unit Connector Models

E3X-HD0

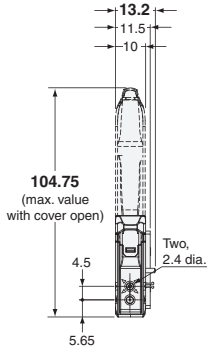
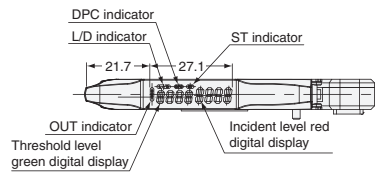

DIN track mounting

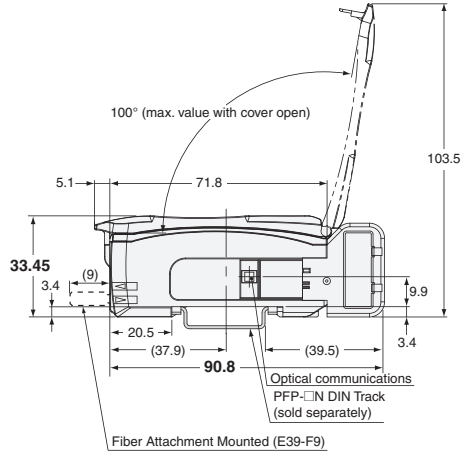

With Mounting Bracket Attached

**Note:** When using E39-L143 Mounting Brackets, there will be small gaps between the Amplifier Units if they are mounted side by side.

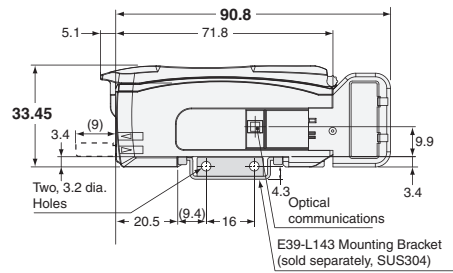

Mounting Holes

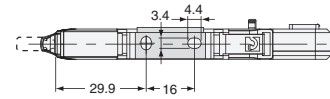

## Amplifier Unit Connectors (Wire-saving Connectors)

### Master Connector E3X-CN11

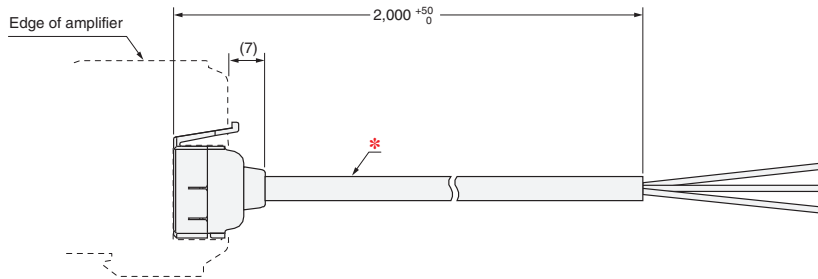

\* E3X-CN11: **4 dia. cable / 3 conductors** / Standard length: 2 m (Conductor cross section: 0.2 mm<sup>2</sup> (AWG24), Insulator diameter: 1.1 mm)

### Slave Connector E3X-CN12

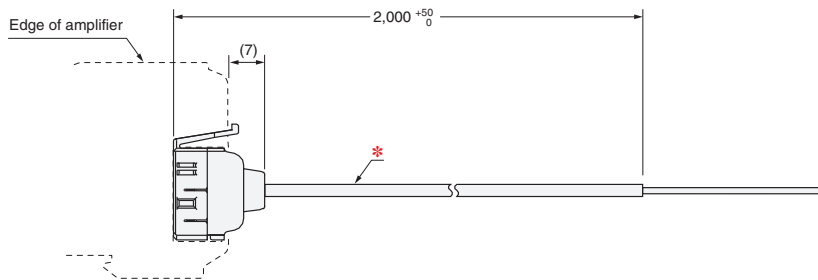

\* E3X-CN12: **2.6 dia. cable / 1 conductor** / Standard length: 2 m (Conductor cross section: 0.2 mm<sup>2</sup> (AWG24), Insulator diameter: 1.1 mm)

## Accessories (sold separately)

### Mounting Brackets E39-L143

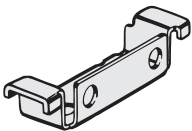

Material: Stainless steel (SUS304)

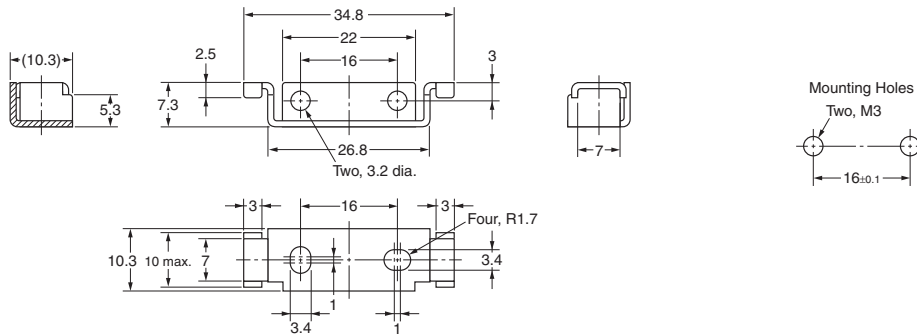

### End Plates PFP-M

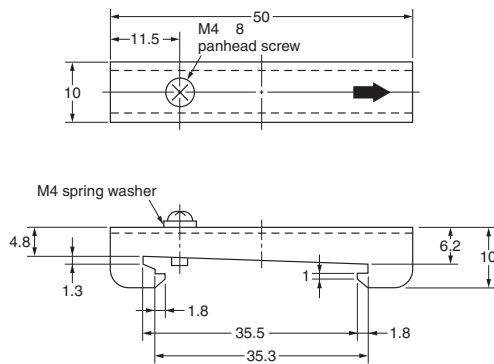
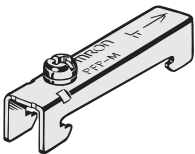



# Operating Procedure

## Setting and Display Overview

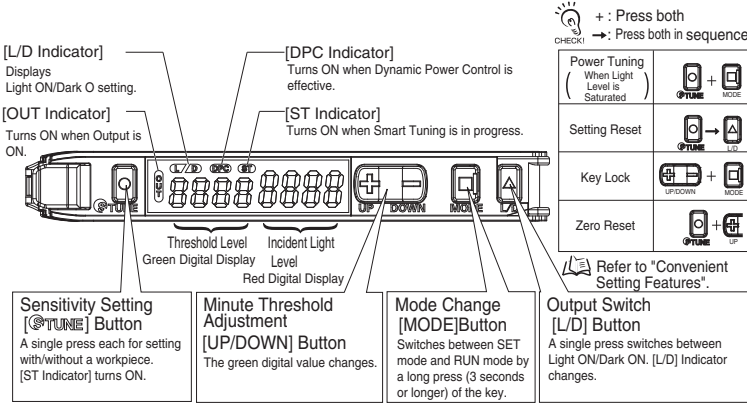

### Smart Tuning [Easy Sensitivity Setting]

#### ① Detect for Workpiece Presence/Absence

##### ● 2-point Tuning

1. Press [OPTUNE] button with a workpiece in the detection area.

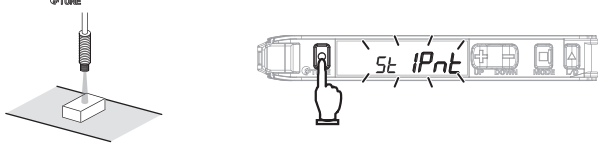

2. Press [OPTUNE] button again without a workpiece in the detection area.

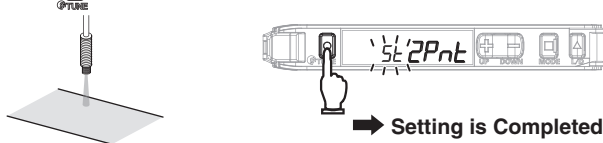

➔ Setting is Completed

Incident light level setting: The larger incident level of the Step 1 and 2 values is

adjusted to the power tuning level.

Threshold setting: Set to the middle between the Step 1 and 2 incident light levels.

Step 1 and Step 2 can be reversed.

#### ② Detect for Workpiece Presence/Absence

##### ● Maximum Sensitivity Tuning

1. Hold [OPTUNE] button for 3 seconds or longer with/without workpiece as shown below. Release the button when [SE FULL] is displayed. Through-beam: Workpiece is present

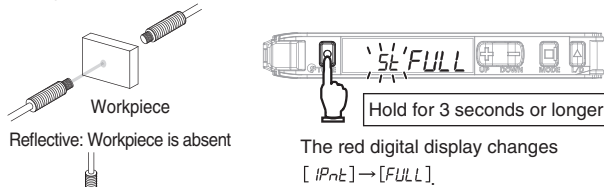

Reflective: Workpiece is absent

The red digital display changes [IPnt] → [FULL].

➔ Setting is Completed

Incident light level setting: The incident level in Step 1 is adjusted to "0".  
Threshold setting: The value is set to approx. 7% of the incident light level of 1.

If the incident light level of 1 is smaller during long distance detection, the minimum value by which an output is correctly turned ON will be set.

#### ③ Adjust for Moving Workpiece without Stopping Line

##### ● Full Auto Tuning

1. Hold the [OPTUNE] button without the presence of a workpiece, and pass the workpiece through while [SE IPnt] → [FULL] → [ALto] is displayed in red digital.  
(Keep holding the [OPTUNE] button while the workpiece passes through, and hold 7 seconds or longer until [ALto] is displayed in red digital. After the workpiece passes through, release your finger from the [OPTUNE] button.)

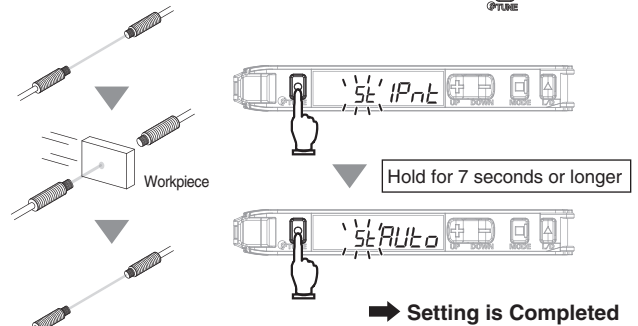

Hold for 7 seconds or longer

➔ Setting is Completed

Incident light level setting: Adjust the max. incident light level on Step 1 as the power tuning level.  
Threshold setting: Set to the middle between max. and min. incident light levels on Step 1.

#### ④ Determine Workpiece Position

##### ● Position Tuning

1. Press [OPTUNE] button without a workpiece in the area.

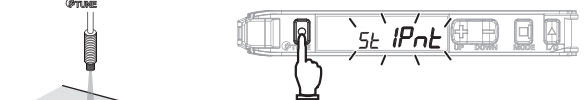

2. Place the workpiece at the desired position and hold [OPTUNE] button.

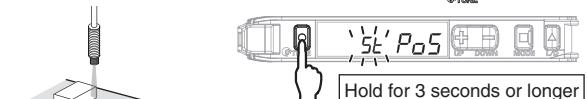

Hold for 3 seconds or longer

The red digital display changes [2Pnt] → [P05].

➔ Setting is Completed

Incident light level setting: The Step 2 incident level is adjusted to half the power tuning level.  
Threshold setting: Set to the same value as the Step 2 incident level.

⑤ Detect Transparent or Small Workpiece  
(Set Threshold by incident light level percentage)

● Percentage Tuning

1. Turn ON Percentage Tuning in SET mode. Refer to "Detailed Settings".
2. Press button without a workpiece in the area.

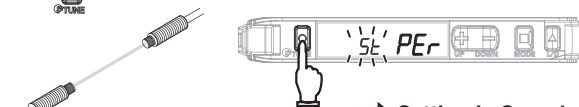

➡ Setting is Completed

Incident light level setting: The Step 2 incident light level is adjusted to the power tuning level.

Threshold setting: Set to the value obtained by [Incident Level at Step 2 × Percentage Tuning Level + Incident Level at Step 2].

No Smart Tuning other than Power Tuning can be used if Percentage Tuning is set.

● Smart Tuning Error

Error / Display / Cause	Error Origin Tuning Type	Remedy
<p>Near Error</p> <p>The light level difference between Points 1 and 2 are extremely small.</p>	<p>2-point Tuning Full Auto Tuning Positioning Tuning</p>	<ul style="list-style-type: none"> <li>• Change the detection function mode to a slower response time mode.</li> <li>• Narrow the emitter and receiver distance (Through-beam)</li> <li>• Mount the sensor closer to the workpiece (Reflective)</li> </ul>
<p>Over Error</p> <p>Incident light level is too high.</p>	<p>All</p>	<ul style="list-style-type: none"> <li>• Enhance the power tuning level.</li> <li>• Use a thin-diameter fiber.</li> <li>• Widen the emitter and receiver distance (Through-beam)</li> <li>• Distance the sensor from the workpiece (Reflective)</li> </ul>
<p>Low Error</p> <p>Incident light level is too low.</p>	<p>Tuning other than Maximum Sensitivity Tuning</p>	<ul style="list-style-type: none"> <li>• Decrease the power tuning level.</li> <li>• Narrow the emitter and receiver distance (Through-beam)</li> <li>• Locate the sensor closer to the workpiece (Reflective)</li> </ul>

The adjustment range of smart tuning is approx. 20 to 1/100 times. When selecting Giga Mode as detection function, the range will be approx. 2 to 1/100 times due to the large initial value.

Refer to "Detailed Settings" to change the power tuning level.

For detailed settings please refer to E3X-HD Instruction Manual

**READ AND UNDERSTAND THIS DOCUMENT**

Please read and understand this document before using the products. Please consult your OMRON representative if you have any questions or comments.

**WARRANTY**

OMRON's exclusive warranty is that the products are free from defects in materials and workmanship for a period of one year (or other period if specified) from date of sale by OMRON.

OMRON MAKES NO WARRANTY OR REPRESENTATION, EXPRESS OR IMPLIED, REGARDING NON-INFRINGEMENT, MERCHANTABILITY, OR FITNESS FOR PARTICULAR PURPOSE OF THE PRODUCTS. ANY BUYER OR USER ACKNOWLEDGES THAT THE BUYER OR USER ALONE HAS DETERMINED THAT THE PRODUCTS WILL SUITABLY MEET THE REQUIREMENTS OF THEIR INTENDED USE. OMRON DISCLAIMS ALL OTHER WARRANTIES, EXPRESS OR IMPLIED.

**LIMITATIONS OF LIABILITY**

OMRON SHALL NOT BE RESPONSIBLE FOR SPECIAL, INDIRECT, OR CONSEQUENTIAL DAMAGES, LOSS OF PROFITS OR COMMERCIAL LOSS IN ANY WAY CONNECTED WITH THE PRODUCTS, WHETHER SUCH CLAIM IS BASED ON CONTRACT, WARRANTY, NEGLIGENCE, OR STRICT LIABILITY.

In no event shall responsibility of OMRON for any act exceed the individual price of the product on which liability is asserted.

IN NO EVENT SHALL OMRON BE RESPONSIBLE FOR WARRANTY, REPAIR, OR OTHER CLAIMS REGARDING THE PRODUCTS UNLESS OMRON'S ANALYSIS CONFIRMS THAT THE PRODUCTS WERE PROPERLY HANDLED, STORED, INSTALLED, AND MAINTAINED AND NOT SUBJECT TO CONTAMINATION, ABUSE, MISUSE, OR INAPPROPRIATE MODIFICATION OR REPAIR.

**SUITABILITY FOR USE**

THE PRODUCTS CONTAINED IN THIS DOCUMENT ARE NOT SAFETY RATED. THEY ARE NOT DESIGNED OR RATED FOR ENSURING SAFETY OF PERSONS, AND SHOULD NOT BE RELIED UPON AS A SAFETY COMPONENT OR PROTECTIVE DEVICE FOR SUCH PURPOSES. Please refer to separate catalogs for OMRON's safety rated products.

OMRON shall not be responsible for conformity with any standards, codes, or regulations that apply to the combination of products in the customer's application or use of the product.

At the customer's request, OMRON will provide applicable third party certification documents identifying ratings and limitations of use that apply to the products. This information by itself is not sufficient for a complete determination of the suitability of the products in combination with the end product, machine, system, or other application or use.

The following are some examples of applications for which particular attention must be given. This is not intended to be an exhaustive list of all possible uses of the products, nor is it intended to imply that the uses listed may be suitable for the products:

- Outdoor use, uses involving potential chemical contamination or electrical interference, or conditions or uses not described in this document.

- Nuclear energy control systems, combustion systems, railroad systems, aviation systems, medical equipment, amusement machines, vehicles, safety equipment, and installations subject to separate industry or government regulations.
- Systems, machines, and equipment that could present a risk to life or property.

Please know and observe all prohibitions of use applicable to the products.

NEVER USE THE PRODUCTS FOR AN APPLICATION INVOLVING SERIOUS RISK TO LIFE OR PROPERTY WITHOUT ENSURING THAT THE SYSTEM AS A WHOLE HAS BEEN DESIGNED TO ADDRESS THE RISKS, AND THAT THE OMRON PRODUCT IS PROPERLY RATED AND INSTALLED FOR THE INTENDED USE WITHIN THE OVERALL EQUIPMENT OR SYSTEM.

**PERFORMANCE DATA**

Performance data given in this document is provided as a guide for the user in determining suitability and does not constitute a warranty. It may represent the result of OMRON's test conditions, and the users must correlate it to actual application requirements. Actual performance is subject to the OMRON Warranty and Limitations of Liability.

**CHANGE IN SPECIFICATIONS**

Product specifications and accessories may be changed at any time based on improvements and other reasons.

It is our practice to change model numbers when published ratings or features are changed, or when significant construction changes are made. However, some specifications of the product may be changed without any notice. When in doubt, special model numbers may be assigned to fix or establish key specifications for your application on your request. Please consult with your OMRON representative at any time to confirm actual specifications of purchased products.

**DIMENSIONS AND WEIGHTS**

Dimensions and weights are nominal and are not to be used for manufacturing purposes, even when tolerances are shown.

**ERRORS AND OMISSIONS**

The information in this document has been carefully checked and is believed to be accurate; however, no responsibility is assumed for clerical, typographical, or proofreading errors, or omissions.

**PROGRAMMABLE PRODUCTS**

OMRON shall not be responsible for the user's programming of a programmable product, or any consequence thereof.

**COPYRIGHT AND COPY PERMISSION**

This document shall not be copied for sales or promotions without permission.

This document is protected by copyright and is intended solely for use in conjunction with the product. Please notify us before copying or reproducing this document in any manner, for any other purpose. If copying or transmitting this document to another, please copy or transmit it in its entirety.

Cat. No. E88E-EN-01

In the interest of product improvement, specifications are subject to change without notice.

---

**OMRON EUROPE B.V.**

Wegalaan 67-69,  
NL-2132 JD, Hoofddorp,  
The Netherlands  
Phone: +31 23 568 13 00  
Fax: +31 23 568 13 88  
[www.industrial.omron.eu](http://www.industrial.omron.eu)