

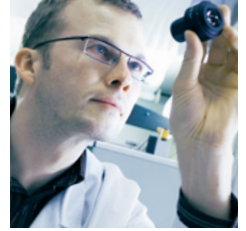

Dx100 Long Range Distance Sensors

Leading in versatility and flexibility

Accurate distance sensors for precise positioning tasks – DL100 and DL100 Hi



Laser-based distance sensors have their origins in the ingenuity of SICK engineers. Continuous development in response to customer requirements combined with the latest technology opens the door to new and increasingly innovative products.

But how can highly sophisticated distance sensors be improved even further? SICK set itself this challenge once again, and came up with the product family Dx100 – smaller, faster, more flexible and cost-effective to operate.



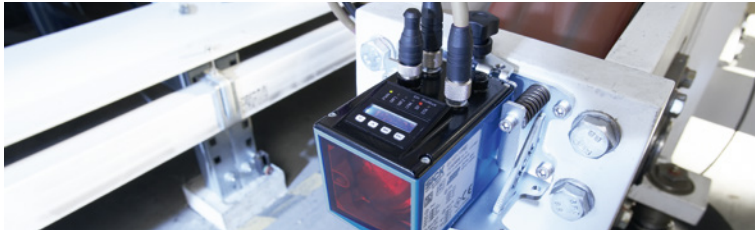

When positioning cranes and in automated storage and retrieval systems, accuracy, speed and minimal downtimes are the key to success. The product family Dx100 has been adapted to increasing drive speeds and now analyzes the signals in the control circuit even faster than before. The sensors feature preventive maintenance functions and send information to the control station if, for example, maintenance is required because of a contaminated working environment. Additional interfaces, bus capability and an innovative mounting concept improve the top performance of this product family even further.

Significantly smaller than comparable distance sensors

The housing dimensions of the Dx100 product family are 119.9 mm x 82.5 mm x 69.4 mm making them the smallest sensors in their performance class.

- + New application possibilities.
- + Low weight.
- + Easy to mount.

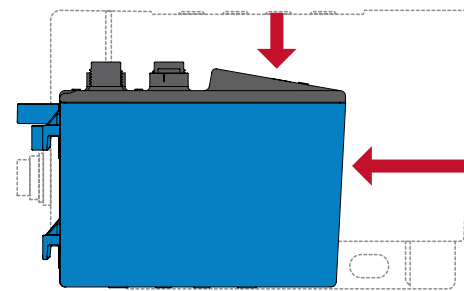

One housing, flexible content

The modular concept of the Dx100 platform means: one housing version with flexible content for different fields of application.

Because of this, performance can be tailored to, and selected on the basis of the application in question.

- + Only the required interfaces.
- + Only the required resolution.
- + Only the required accuracy.
- That means: only the costs for the required performance.

Innovative mounting system

Because the housing of all Dx100 versions is identical, the mechanical interfaces and accessories are the same for all versions.

- + Reduced logistic and storage costs.
- + Fast mounting and simple replacement of equipment.
- + Easy mounting:
 - 1 Mount the device in the precisely fitting plate.
 - 2 Tighten it using the black adjustment screw.
 - 3 Perform fine adjustment using 3 spring-loaded screws.

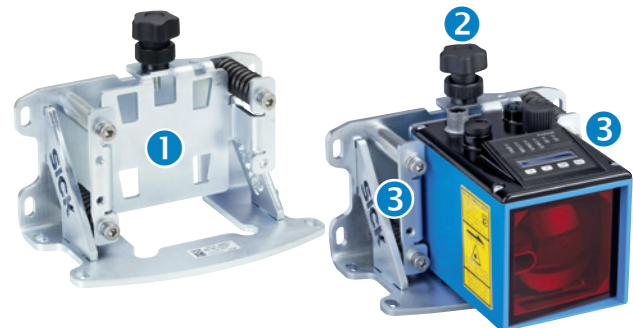

→ Increased performance and lower operating costs make the sensors of the Dx100 product family the optimal choice for your application.

Thermo Protection Cooling Case (TPCC) – keeps the sensor cool and inside the temperature operating range

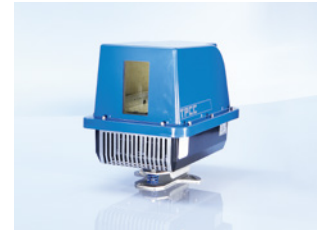

The Thermo Protection Cooling Case (TPCC) from SICK cools and protects laser-based sensors. By extending the sensor service life, it also contributes to protecting your investment.

With a maintenance-free Peltier cooler (24 V/15 A), the TPCC offers efficient protection at ambient temperatures from $-20\text{ }^{\circ}\text{C}$ to $+75\text{ }^{\circ}\text{C}$. The internal temperature is thermostat-controlled. If the temperature becomes too high, the TPCC shuts itself down automatically.

High temperature ranges, harsh environmental conditions

The use of the TPCC is particularly appropriate in locations with high ambient temperatures due to the process environment.

The TPCC is perfect for use:

- in the steel industry
- in the paper industry
- in glass manufacturing
- on overhead cranes under the ceiling of industrial buildings
- in countries and locations where high ambient temperatures can be expected

The rugged fibre glass housing with protective front screen offers additional protection against mechanical damage and remains dimensionally stable up to $+140\text{ }^{\circ}\text{C}$. This temperature is beyond the maximum value specified for the TPCC.

Increased sensor availability, extended service life

Due to physics of laser diodes, the service life of the laser halves for each $10\text{ }^{\circ}\text{C}$ increase in temperature (cf. diagram). By using the TPCC, the sensor is actively cooled by means of the Peltier effect. This extends the service life of the laser – and thus of your sensor: at $25\text{ }^{\circ}\text{C}$ it will already be extended by 15 %, at $45\text{ }^{\circ}\text{C}$ by 400 %.

In addition:

The low internal temperature of the TPCC also offers economic advantages. The constant conditions within the TPCC ensure that the measured values are more accurate. Sensor availability increases, and unexpected failures and system downtime can be avoided.

Benefit: replacement costs are reduced and productivity increases.

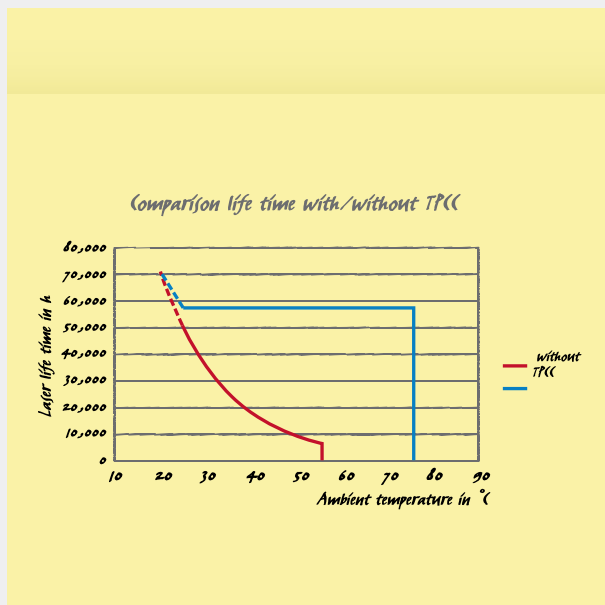

The amortization period for the TPCC is dependent on the purchase price of the sensor, the daily operating time of the sensor, and the prevailing ambient temperatures.

One will quickly discover that this is a worthwhile investment which saves a lot of money down the line.

DME to Dx100 upgrade kit: Straightforward sensor replacement to ensure the availability of your system



Upgrade kits from SICK often provide a cost-effective alternative to purchasing a brand new drive and control system. These solutions enable quick and easy integration of the latest technology, in order to increase the productivity of existing systems.

In the event of upcoming modernization of systems, preventative replacement of DME distance sensors after years of use: SICK DME-Dx100 upgrade kits are designed for carrying out the conversion of the tried and tested DME distance sensors to the current Dx100 with the least possible cost and effort.

We will also be happy to assist you with conversion at your site. Contact us!

Tailor-made, easy to use

The DME-Dx100 upgrade kit is characterized by a range of special features:

- ⊕ Upgrade kit specifically tailored to the application
- ⊕ All accessories required at the site are included ¹⁾
- ⊕ The enclosed upgrade instructions describe the detailed steps involved
- ⊕ The Dx100 is mechanically mounted on DME hole pattern using an adapter plate
- ⊕ Electrical connections are established with preassembled adapter cables

¹⁾ The Dx100 distance sensor is not included in the upgrade kit and must be selected and ordered separately.

Early conversion, clear advantages

Decide to upgrade soon using the tailor-made DME-Dx100 upgrade kit – and you will enjoy all the economic benefits:











- ⊕ Boost the productivity of your system by using the latest technology
- ⊕ Maximum system availability combined with minimum downtime during conversion
- ⊕ Avoid costly and unscheduled outage times by taking the precautionary step of converting your system to Dx100
- ⊕ Convert your existing system cost-effectively in just a few steps



DME to Dx100 upgrade kit ordering information

Previously available in the system	Data interface	Model name Dx100	Upgrade kit model name	Upgrade kit part no.
DME3000	SSI	Dx100-xxxxxx01	DME3-Dx100 SSI/RS-422	2065223
	PROFIBUS	Dx100-xxxxxx02	DME3-Dx100 PROFIBUS	2065222
	RS-422	Dx100-xxxxxx03	DME3-Dx100 SSI/RS-422	2065223
DME4000/ DME5000	SSI	Dx100-xxxxxx01	DME4/5-Dx100 SSI/RS-422	2065221
	PROFIBUS	Dx100-xxxxxx02	DME4/5-Dx100 PROFIBUS	2065220
	RS-422	Dx100-xxxxxx03	DME4/5-Dx100 SSI/RS-422	2065221

Product family overview

	 <p>DL100</p>	 <p>DL100 Hi</p>
	Solve positioning tasks intelligently	Reliable, fast, precise positioning
Technical data overview		
Measuring range	0.15 m ... 60 m 0.15 m ... 130 m 0.15 m ... 220 m	0.15 m ... 100 m 0.15 m ... 200 m 0.15 m ... 300 m
Repeatability	1.5 mm (at dead time 10 ms), 0.75 mm (at dead time 30 ms) 2 mm (at dead time 10 ms), 1 mm (at dead time 30 ms) 2.5 mm (at dead time 10 ms), 1.25 mm (at dead time 30 ms)	0.5 mm 1 mm 2 mm
Accuracy	± 3 mm ± 4 mm ± 5 mm	± 2 mm ± 2.5 mm ± 3 mm
Interfaces overview	SSI PROFIBUS RS-422 PROFINET CANopen	SSI PROFIBUS RS-422 PROFINET CANopen
Ambient temperature	Operation: -20 °C ... +55 °C Operation with cooling case: -20 °C ... +75 °C Operation with heating: -40 °C ... +55 °C Operation with cooling case: -40 °C ... +75 °C Storage: -40 °C ... +75 °C	Operation: -20 °C ... +55 °C Operation with cooling case: -20 °C ... +75 °C Operation with heating: -40 °C ... +55 °C Operation with cooling case: -40 °C ... +75 °C Storage: -40 °C ... +75 °C
Output rate	Synchronous to PLC request	Synchronous to PLC request
Light source	Laser, red	Laser, red
At a glance		
	   	   
	<ul style="list-style-type: none"> Measuring range up to 220 m Numerous fieldbus interfaces Pre-failure notification and diagnostic data available Display with intuitive menu structure and clearly visible status LEDs Small, rugged metal housing 3-axis alignment bracket with quick-lock system Elongated holes for zero point adjustment during device replacement 	<ul style="list-style-type: none"> Measuring range up to 300 m Numerous fieldbus interfaces Pre-failure notification and diagnostic data available Display with intuitive menu and easy to see status LEDs Small and rugged metal housing 3-axis alignment bracket with quick lock system Elongated holes for precise adjustment of sensor offset SPEEDCON™ and standard M12 electrical connections
Detailed information	→ 9	→ 16

Solve positioning tasks intelligently

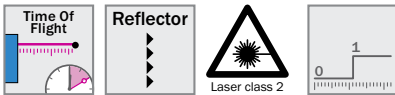
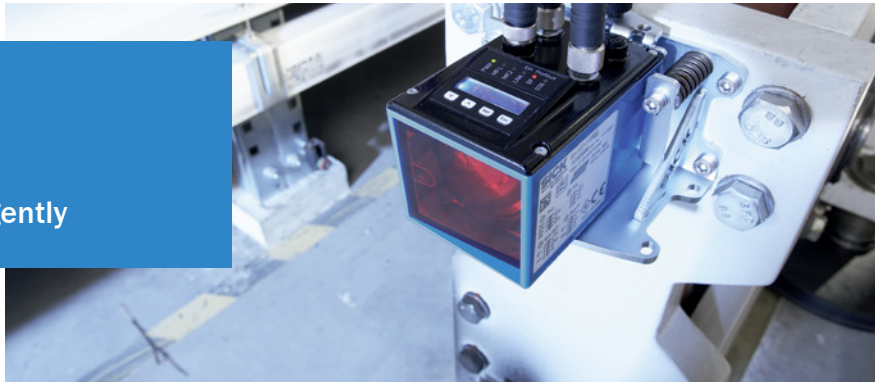

Product description

The distance sensors in the DL100 product family focus on what really matters – a sound, reliable solution for standard positioning tasks – and combine leading-edge technology with an innovative design. The phase-shift laser measurement process ensures a high level of accuracy, even at sensing ranges of up to 220 m. Additionally, this equipment affords optimum handling thanks to the

alignment bracket, a housing that is the smallest in this sensor class, plus its sophisticated connection design uses quick lock cables. The DL100 product family is based on a concept that is designed to achieve a low total cost of ownership, making it an attractive choice. It offers the right solution to accommodate any need.

At a glance

- Measuring range up to 220 m
- Numerous fieldbus interfaces
- Pre-failure notification and diagnostic data available
- Display with intuitive menu structure and clearly visible status LEDs
- Small, rugged metal housing
- 3-axis alignment bracket with quick-lock system
- Elongated holes for zero point adjustment during device replacement

Your benefits

- 100,000 hours of laser service life ensures that the sensor will have a long, useful life with maximum reliability
- Versions with integrated heating enable reliable use at ambient temperatures at up to -40 °C. The TPCC cooling housing, available as an option, enables use at up to +75 °C
- The numerous interfaces offer a high degree of flexibility as well as rapid communication for maximum productivity
- Pre-failure notification and diagnostic data for maximum plant availability
- Small, rugged metal housing with SpeedCon™ compatible connectors ensures smooth handling – even in confined spaces
- Alignment bracket with quick lock system ensures fast alignment and easy device replacement, reducing maintenance and mounting costs

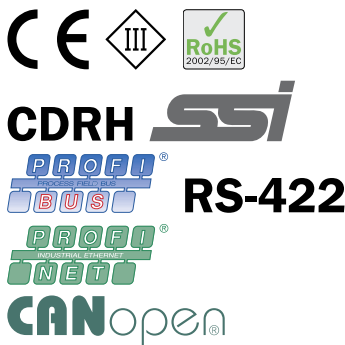

Additional information

Detailed technical data. 10

Ordering information. 11

Dimensional drawing 12

Adjustments 13

Connection type and diagram 13

Recommended accessories 14

→ www.mysick.com/en/DL100

For more information, just enter the link or scan the QR code and get direct access to technical data, CAD design models, operating instructions, software, application examples and much more.



Detailed technical data

Performance

Resolution	0.1 mm, 0.125 mm, 1 mm, 10 mm, 100 mm
Output rate	Synchronous to PLC request
Light source ¹⁾	Laser, red
Laser protection class	2 (EN 60825-1 / CDRH)
Typ. light spot size (distance)	5 mm (+ 2 mm x distance in m)
Max. movement speed	10 m/s
Internal measurement cycle	1 ms

¹⁾ Average service life of 100,000 h at $T_A = +25 \text{ }^\circ\text{C}$.

Interfaces

Switching output ¹⁾	B (push/pull), MF1, MF2
Multifunctional input ²⁾	1 x MF1

¹⁾ HIGH > $V_S - 3 \text{ V}$ / LOW < 2 V.

²⁾ HIGH > 12 V / LOW < 3 V.

Mechanics/electronics

Supply voltage V_S	DC 18 V ... 30 V, limit values
Ripple ¹⁾	5 V_{pp}
Initialization time ²⁾	Typ. 1.5 s
Housing material	Aluminum/zinc die-cast
Connection type	Connector M12, SPEEDCON™ compatible
Indication	6 digit 5 x 7 dot matrix display, LEDs
Weight ³⁾	Approx. 800 g ... 1,600 g
Output current I_A ⁴⁾	≤ 100 mA

¹⁾ May not fall short of or exceed V_S tolerances.

²⁾ After loss of reflector < 40 ms.

³⁾ Without mounting bracket: approx. 800 g, with mounting bracket: approx. 1,600 g.

⁴⁾ Short circuit/overload protected. Max. 100 nF / 20 mH.

Ambient data

Enclosure rating	IP 65
Protection class	III
Electromagnetic compatibility (EMC) ¹⁾	EN 61000-6-2, EN 61000-6-4
Effect of air pressure	0.3 ppm/hPa
Effect of air temperature	1 ppm/K
Temperature drift	Typ. 0.1 mm/K
Mechanical load	Shock: EN 600 68-2-27 Sine: EN 600 68-2-6 Noise: EN 600 68-2-64

¹⁾ This is a Class A device. This device can cause radio interference in living quarters.

Ordering information

Ambient temperature	Power consumption	Measuring range ²⁾	Accuracy	Repeatability ³⁾	Interface	Model name	Part no.
Operation -20 °C ... +55 °C ¹⁾ Operation with cooling case -20 °C ... +75 °C Storage -40 °C ... +75 °C	At 24 V DC < 250 mA	0.15 m ... 60 m	± 3 mm	1.5 mm (at dead time 10 ms), 0.75 mm (at dead time 30 ms)	SSI	DL100-11AA2101	1059957
					PROFIBUS	DL100-11AA2102	1059959
					RS-422	DL100-11AA2103	1059961
					PROFINET	DL100-11AA2112	1060045
		0.15 m ... 130 m	± 4 mm	2 mm (at dead time 10 ms), 1 mm (at dead time 30 ms)	CANopen	DL100-11AA2109	1060392
					SSI	DL100-12AA2101	1059963
					PROFIBUS	DL100-12AA2102	1059965
					RS-422	DL100-12AA2103	1059967
		0.15 m ... 220 m	± 5 mm	2.5 mm (at dead time 10 ms), 1.25 mm (at dead time 30 ms)	PROFINET	DL100-12AA2112	1060047
					CANopen	DL100-12AA2109	1060394
					SSI	DL100-13AA2101	1059969
					PROFIBUS	DL100-13AA2102	1059971
Operation with heating -40 °C ... +55 °C ¹⁾ Operation with cooling case -40 °C ... +75 °C Storage -40 °C ... +75 °C	At 24 V DC < 1,000 mA	0.15 m ... 60 m	± 3 mm	1.5 mm (at dead time 10 ms), 0.75 mm (at dead time 30 ms)	RS-422	DL100-13AA2103	1059973
					PROFINET	DL100-13AA2112	1060049
					CANopen	DL100-13AA2109	1060396
					SSI	DL100-11HA2101	1059958
		0.15 m ... 130 m	± 4 mm	2 mm (at dead time 10 ms), 1 mm (at dead time 30 ms)	PROFIBUS	DL100-11HA2102	1059960
					RS-422	DL100-11HA2103	1059962
					PROFINET	DL100-11HA2112	1060046
					CANopen	DL100-11HA2109	1060393
		0.15 m ... 220 m	± 5 mm	2.5 mm (at dead time 10 ms), 1.25 mm (at dead time 30 ms)	SSI	DL100-12HA2101	1059964
					PROFIBUS	DL100-12HA2102	1059966
					RS-422	DL100-12HA2103	1059968
					PROFINET	DL100-12HA2112	1060048
0.15 m ... 220 m	± 5 mm	2.5 mm (at dead time 10 ms), 1.25 mm (at dead time 30 ms)	CANopen	DL100-12HA2109	1060395		
			SSI	DL100-13HA2101	1059970		
			PROFIBUS	DL100-13HA2102	1059972		
			RS-422	DL100-13HA2103	1059974		
0.15 m ... 220 m	± 5 mm	2.5 mm (at dead time 10 ms), 1.25 mm (at dead time 30 ms)	PROFINET	DL100-13HA2112	1060050		
			CANopen	DL100-13HA2109	1060397		

¹⁾ Temperatures < -10 °C require warm-up time of typ. 7 minutes.

²⁾ On reflective tape "Diamond Grade".

³⁾ Statistical error 1 σ, environmental conditions constant, depending on operating mode.

Dimensional drawing

dimensions in mm

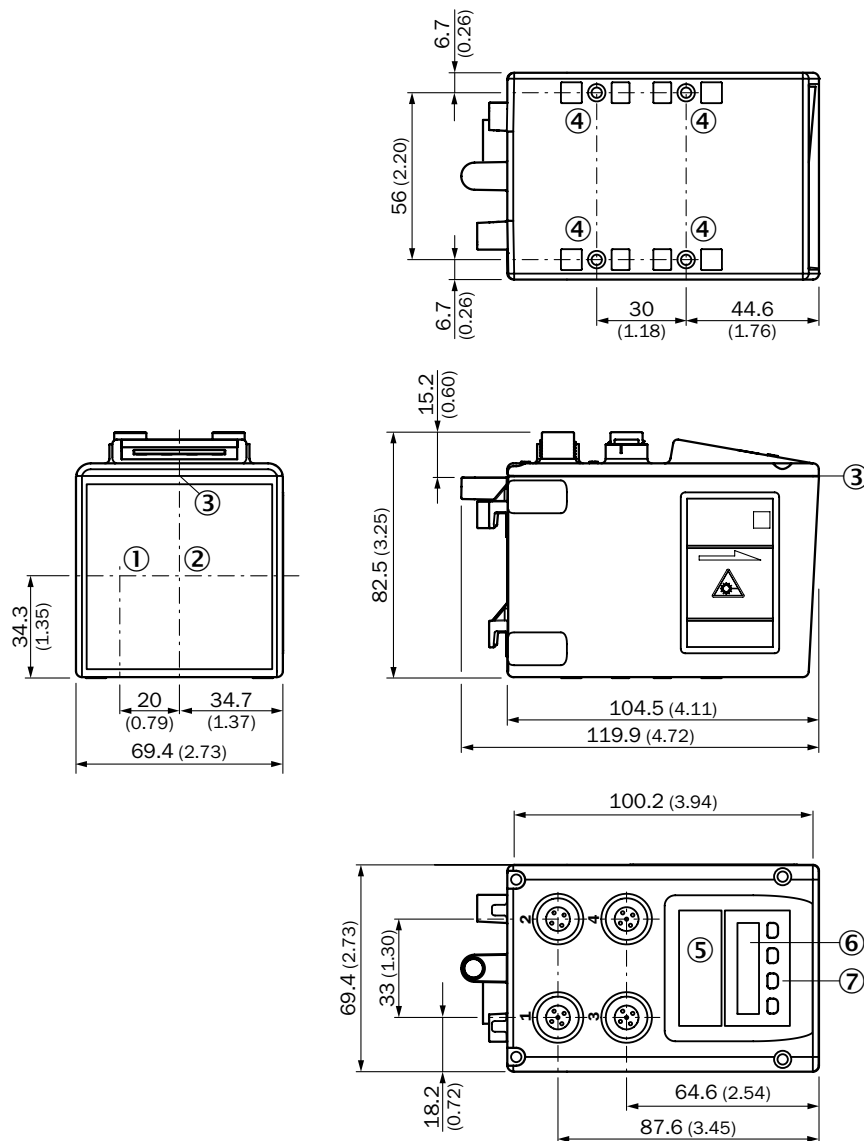

- ① Optical axis, sender
- ② Optical axis, receiver
- ③ Zero level
- ④ Threaded mounting hole M5
- ⑤ Status LED [status]
- ⑥ Display
- ⑦ Control elements

Adjustments

DL100-xxXXxx02

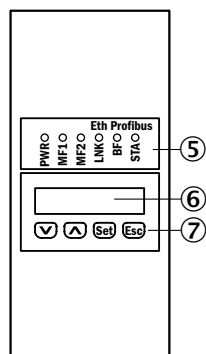

- ⑤ Status LED [status]
- ⑥ Display
- ⑦ Control elements

DL100-xxXXxx12

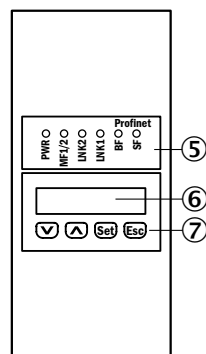

- ⑤ Status LED [status]
- ⑥ Display
- ⑦ Control elements

DL100-xxXXxx09

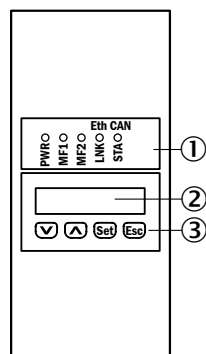

- ① Status LED [status]
- ② Display
- ③ Control elements

Connection type and diagram

Please note: Since wire color on 8-pin connection cables are not normed, always check for a correct pin to wire color assignment when using connection cables other than specified here.

Dx100 Ethernet Socket M12, 4-pin, D-coded

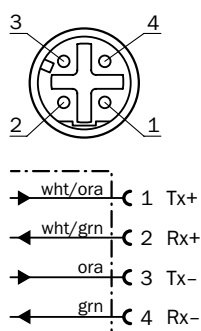

Dx100 SSI, RS-422 Connector M12, 8-pin, A-coded

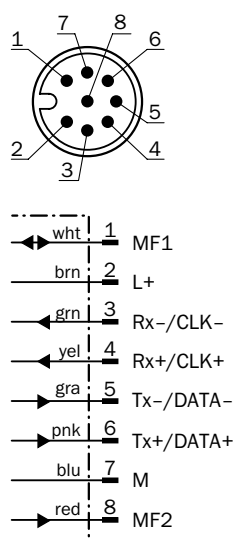

Dx100 PROFIBUS/PROFINET/CANopen Connector M12, 4-pin, A-coded

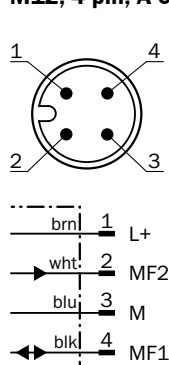

Dx100 PROFIBUS IN Connector M12, 5-pin B-coded

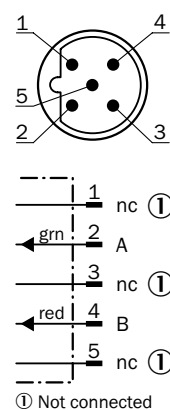

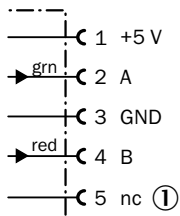
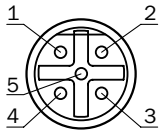
**Dx100 PROFIBUS OUT
Connector
M12, 5-pin, B-coded**

① Not connected

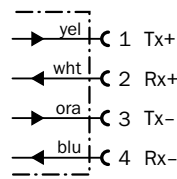
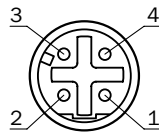
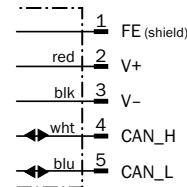
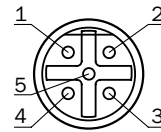
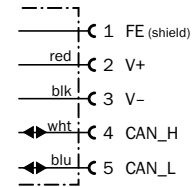
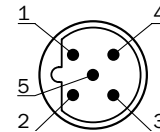
**Dx100 PROFINET, Port 1/
Port 2
Socket
M12, 4-pin, D-coded**

**Dx100 CANopen
Socket
M12, 5-pin, CANout**

**Dx100 CANopen
Socket
M12, 5-pin, CANin**

Recommended accessories

Plug connectors and cables

	Brief description	Model name	Part no.	Dx100 SSI	Dx100 PROFIBUS	Dx100 RS-422	Dx100 PROFINET	Dx100 CANopen
 Illustration may differ	Female connector, M12, 4-pin, straight, 2 m, PVC	DOL-1204-G02M	6009382	-	●	-	●	●
	Female connector, M12, 4-pin, straight, 5 m, PVC	DOL-1204-G05M	6009866	-	●	-	●	●
	Female connector, M12, 4-pin, straight, 10 m, PVC	DOL-1204-G10M	6010543	-	●	-	●	●
	Female connector, M12, 5-pin, straight, 5 m, PROFIBUS, shielded	DOL-1205-G05MQ	6026006	-	●	-	-	-
	Female connector, M12, 5-pin, straight, 10 m, PROFIBUS, shielded	DOL-1205-G10MQ	6026008	-	●	-	-	-
	Female connector, M12, 5-pin, straight, 15 m, PROFIBUS, shielded	DOL-1205-G15MQ	6032637	-	●	-	-	-
	Female connector, M12, 8-pin., straight, 2 m, PUR halogen free, shielded	DOL-1208-G02MAH1	6032448	●	-	●	-	-
	Female connector, M12, 8-pin., straight, 5 m, PUR halogen free, shielded	DOL-1208-G05MAH1	6032449	●	-	●	-	-
	Female connector, M12, 8-pin., straight, 10 m, PUR halogen free, shielded	DOL-1208-G10MAH1	6032450	●	-	●	-	-
	Male connector, M12, 4-pin, straight, PROFIBUS, terminal resistor	PR-STE-END	6021156	-	●	-	-	-
	Connection cable, Ethernet patch cable, 2 m, straight, connector M12, 4-pin to connector RJ-45	SSL-2J04-G02ME	6034414	●	●	●	-	●
	Connection cable, Ethernet patch cable, 5 m, straight, connector M12, 4-pin to connector RJ-45	SSL-2J04-G05ME	6035389	●	●	●	-	●
	Connection cable, Ethernet patch cable, 10 m, straight, connector M12, 4-pin to connector RJ-45	SSL-2J04-G10ME	6030928	●	●	●	-	●
	Connecting cable, M12 male connector, straight, to open end, 2 m	SSL-1204-G02MZ90	6048247	-	-	-	●	-
	Connecting cable, M12 male connector, straight, to open end, 5 m	STL-1204-G05MZ90	6048248	-	-	-	●	-
	Connecting cable, M12 male connector, straight, to open end, 10 m	STL-1204-G10MZ90	6048249	-	-	-	●	-
	Male connector, M12, 5-pin, straight, 5 m, PROFIBUS, shielded	STL-1205-G05MQ	6026005	-	●	-	-	-
	Male connector, M12, 5-pin, straight, 10 m, PROFIBUS, shielded	STL-1205-G10MQ	6026007	-	●	-	-	-
	Male connector, M12, 5-pin, straight, 15 m, PROFIBUS, shielded	STL-1205-G15MQ	6036898	-	●	-	-	-

Reflectors

	Brief description	Model name	Part no.	Dx100 SSI	Dx100 PROFIBUS	Dx100 RS-422	Dx100 PROFINET	Dx100 CANopen
	Reflector plate, DG tape 665 mm x 665 mm, material: base plate aluminum, screw connection	PL560DG	1016806	●	●	●	●	●

Terminal and alignment brackets

	Brief description	Model name	Part no.	Dx100 SSI	Dx100 PROFIBUS	Dx100 RS-422	Dx100 PROFINET	Dx100 CANopen
	Alignment unit for Dx100, steel, zinc coated, incl. mounting material	BEF-AH-DX100	2058653	●	●	●	●	●

For additional accessories, please see page 23.

Reliable, fast, precise positioning



Time Of Flight

Reflector

Performance

Laser class 2

CDRH SSI

PROFI[®]

BUS RS-422

PROFI[®]

NET

CANopen[®]

Additional information

Detailed technical data..... 17

Ordering information..... 18

Dimensional drawing 19

Adjustments 20

Connection type and diagram 20

Recommended accessories..... 21

Product description

The DL100 Hi family combines leading edge technology with innovative design. The product's phase-shift measurement technology ensures the highest performance, which, in co-operation with drives manufacturers, has been optimized for perfect integration into closed control

loops. Our innovative 3-axis bracket, the smallest housing in its sensor class, as well as the intelligent quick lock system with fast connectors, offers optimized handling and reduced costs of ownership.

At a glance

- Measuring range up to 300 m
- Numerous fieldbus interfaces
- Pre-failure notification and diagnostic data available
- Display with intuitive menu and easy to see status LEDs
- Small and rugged metal housing
- 3-axis alignment bracket with quick lock system
- Elongated holes for precise adjustment of sensor offset
- SPEEDCON™ and standard M12 electrical connections

Your benefits

- Enhanced closed-loop behavior offers highest performance and productivity
- Operating temperature down to -40 °C ensures the highest reliability in cold storage warehouses and freezers
- Numerous fieldbus and Ethernet-based interfaces offer the highest flexibility and fast communication for maximum efficiency
- Pre-failure and extensive diagnostic data allow for preventive maintenance, ensuring the highest machine uptime
- Small, rugged metal housing and SpeedCon™ compatible connectors ensure hassle-free installation – even in confined spaces
- 3-axis alignment bracket ensures fast alignment and easy exchange, reducing maintenance and setup costs
- Numerous accessories allow flexible use and guarantee high operation functionality

→ www.mysick.com/en/DL100_Hi

For more information, just enter the link or scan the QR code and get direct access to technical data, CAD design models, operating instructions, software, application examples and much more.



Detailed technical data

Performance

Resolution	0.1 mm, 0.125 mm, 1 mm, 10 mm, 100 mm
Dead time	2 ms
Output rate	Synchronous to PLC request
Light source ¹⁾	Laser, red
Laser protection class	2 (EN 60825-1 / CDRH)
Typ. light spot size (distance)	5 mm (+ 2 mm x distance in m)
Max. movement speed	10 m/s
Acceleration (max.)	≤ 15 m/s ²
Internal measurement cycle	1 ms

¹⁾ Average service life of 100,000 h at $T_A = +25\text{ °C}$.

Interfaces

Switching output ¹⁾	B (push/pull), MF1, MF2
Multifunctional input ²⁾	1 x MF1

¹⁾ HIGH > $V_S - 3\text{ V}$ / LOW < 2 V.

²⁾ HIGH > 12 V / LOW < 3 V.

Mechanics/electronics

Supply voltage V_S	DC 18 V ... 30 V, limit values
Ripple ¹⁾	5 V _{pp}
Initialization time ²⁾	Typ. 1.5 s
Housing material	Aluminum/zinc die-cast
Connection type	Connector M12, SPEEDCON™ compatible
Indication	6 digit 5 x 7 dot matrix display, LEDs
Weight ³⁾	Approx. 800 g ... 1,600 g
Output current I_A ⁴⁾	≤ 100 mA

¹⁾ May not fall short of or exceed V_S tolerances.

²⁾ After loss of reflector < 40 ms.

³⁾ Without mounting bracket: approx. 800 g, with mounting bracket: approx. 1,600 g.

⁴⁾ Short circuit/overload protected. Max. 100 nF / 20 mH.

Ambient data

Enclosure rating	IP 65
Protection class	III
Electromagnetic compatibility (EMC) ¹⁾	EN 61000-6-2, EN 61000-6-4
Effect of air pressure	0.3 ppm/hPa
Effect of air temperature	1 ppm/K
Temperature drift	Typ. 0.1 mm/K
Mechanical load	Shock: EN 600 68-2-27 Sine: EN 600 68-2-6 Noise: EN 600 68-2-64

¹⁾ This is a Class A device. This device can cause radio interference in living quarters.

Ordering information

Ambient temperature	Power consumption	Measuring range ²⁾	Accuracy	Repeatability ³⁾	Interface	Model name	Part no.
Operation -20 °C ... +55 °C ¹⁾ Operation with cooling case -20 °C ... +75 °C Storage -40 °C ... +75 °C	At 24 V DC < 250 mA	0.15 m ... 100 m	± 2 mm	0.5 mm	SSI	DL100-21AA2101	1052684
					PROFIBUS	DL100-21AA2102	1052686
					RS-422	DL100-21AA2103	1052688
					PROFINET	DL100-21AA2112	1058164
		0.15 m ... 200 m	± 2.5 mm	1 mm	CANopen	DL100-21AA2109	1060386
					SSI	DL100-22AA2101	1052690
					PROFIBUS	DL100-22AA2102	1052692
					RS-422	DL100-22AA2103	1052694
		0.15 m ... 300 m	± 3 mm	2 mm	PROFINET	DL100-22AA2112	1058166
					CANopen	DL100-22AA2109	1060388
					SSI	DL100-23AA2101	1052696
					PROFIBUS	DL100-23AA2102	1052698
Operation with heating -40 °C ... +55 °C Operation with cooling case -40 °C ... +75 °C Storage -40 °C ... +75 °C	At 24 V DC < 1,000 mA	0.15 m ... 100 m	± 2 mm	0.5 mm	RS-422	DL100-23AA2103	1052700
					PROFINET	DL100-23AA2112	1058168
					CANopen	DL100-23AA2109	1060390
					SSI	DL100-21HA2101	1052685
		0.15 m ... 200 m	± 2.5 mm	1 mm	PROFIBUS	DL100-21HA2102	1052687
					RS-422	DL100-21HA2103	1052689
					PROFINET	DL100-21HA2112	1058165
					CANopen	DL100-21HA2109	1060387
		0.15 m ... 300 m	± 3 mm	2 mm	SSI	DL100-22HA2101	1052691
					PROFIBUS	DL100-22HA2102	1052693
					RS-422	DL100-22HA2103	1052695
					PROFINET	DL100-22HA2112	1058167
0.15 m ... 300 m	± 3 mm	2 mm	CANopen	DL100-22HA2109	1060389		
			SSI	DL100-23HA2101	1052697		
			PROFIBUS	DL100-23HA2102	1052699		
			RS-422	DL100-23HA2103	1052701		
0.15 m ... 300 m	± 3 mm	2 mm	PROFINET	DL100-23HA2112	1058169		
			CANopen	DL100-23HA2109	1060391		

¹⁾ Temperatures < -10 °C require warm-up time of typ. 7 minutes.

²⁾ On reflective tape "Diamond Grade".

³⁾ Statistical error 1 σ , environmental conditions constant, min. warm-up time 10 min.

Dimensional drawing

dimensions in mm

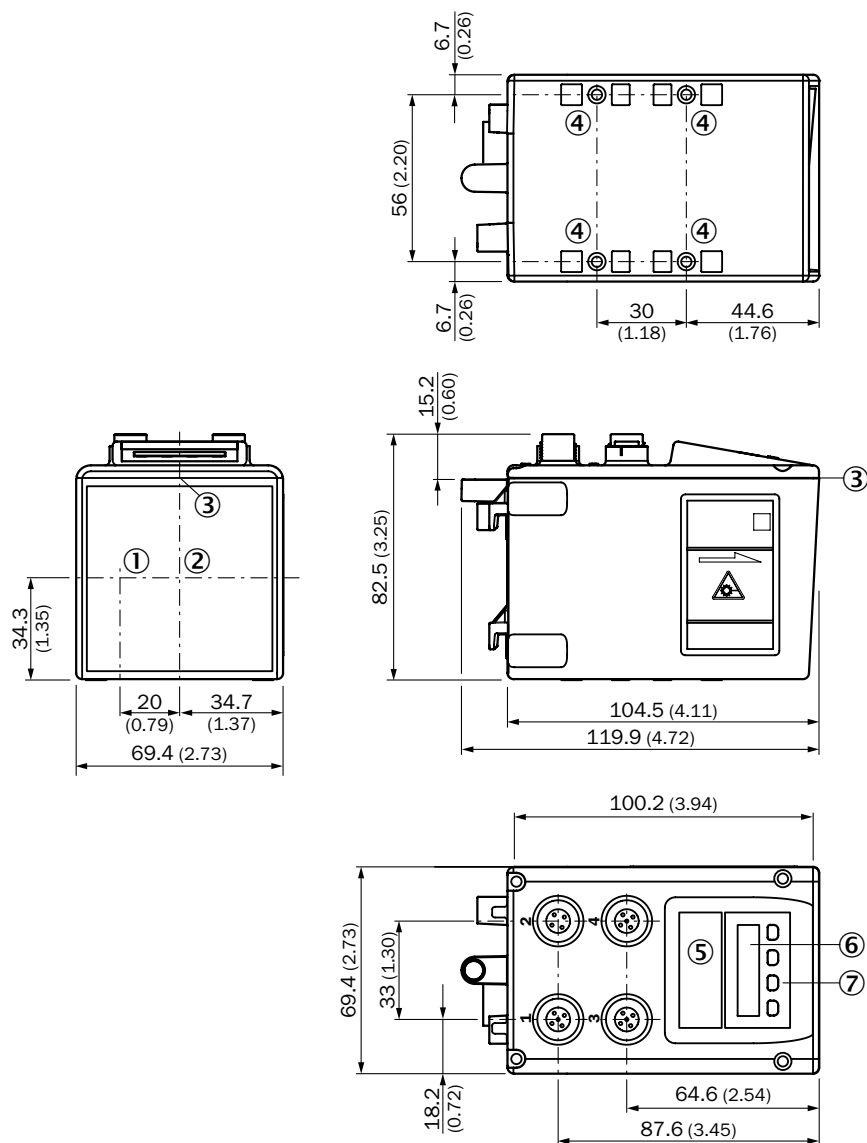

- ① Optical axis, sender
- ② Optical axis, receiver
- ③ Zero level
- ④ Threaded mounting hole M5
- ⑤ Status LED [status]
- ⑥ Display
- ⑦ Control elements

Adjustments

DL100-xxXXxx02

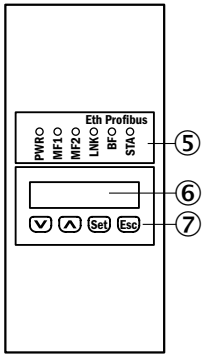

- ⑤ Status LED [status]
- ⑥ Display
- ⑦ Control elements

DL100-xxXXxx12

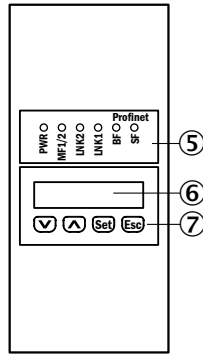

- ⑤ Status LED [status]
- ⑥ Display
- ⑦ Control elements

DL100-xxXXxx09

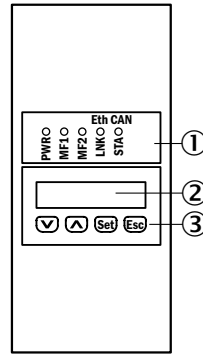

- ① Status LED [status]
- ② Display
- ③ Control elements

Connection type and diagram

Please note: Since wire color on 8-pin connection cables are not normed, always check for a correct pin to wire color assignment when using connection cables other than specified here.

Dx100 Ethernet Socket M12, 4-pin, D-coded

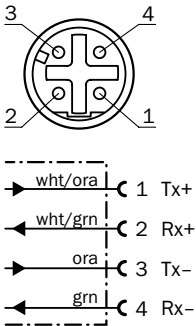

Dx100 SSI, RS-422 Connector M12, 8-pin, A-coded

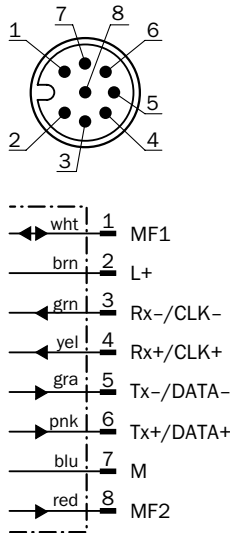

Dx100 PROFIBUS/PROFINET/CANopen Connector M12, 4-pin, A-coded

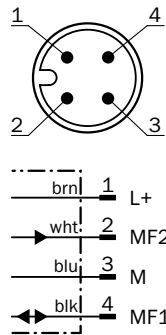

Dx100 PROFIBUS IN Connector M12, 5-pin B-coded

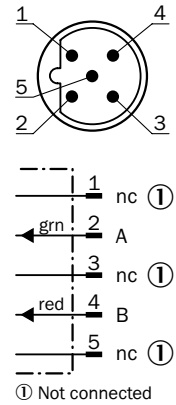

Dx100 PROFIBUS OUT Connector M12, 5-pin, B-coded

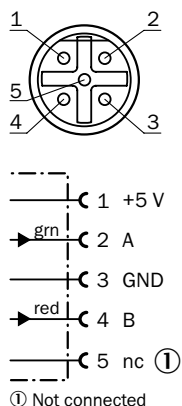

Dx100 PROFINET, Port 1/ Port 2 Socket M12, 4-pin, D-coded

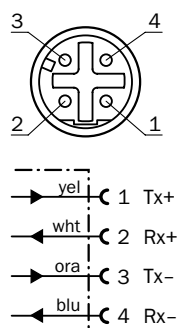

Dx100 CANopen Socket M12, 5-pin, CANout

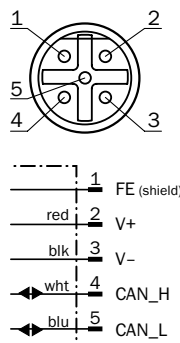

Dx100 CANopen Socket M12, 5-pin, CANin

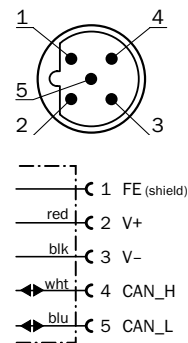

Recommended accessories

Plug connectors and cables

	Brief description	Model name	Part no.	Dx100 SSI	Dx100 PROFIBUS	Dx100 RS-422	Dx100 PROFINET	Dx100 CANopen
Illustration may differ	Female connector, M12, 4-pin, straight, 2 m, PVC	DOL-1204-G02M	6009382	-	●	-	●	●
	Female connector, M12, 4-pin, straight, 5 m, PVC	DOL-1204-G05M	6009866	-	●	-	●	●
	Female connector, M12, 4-pin, straight, 10 m, PVC	DOL-1204-G10M	6010543	-	●	-	●	●
Illustration may differ	Female connector, M12, 5-pin, straight, 5 m, PROFIBUS, shielded	DOL-1205-G05MQ	6026006	-	●	-	-	-
	Female connector, M12, 5-pin, straight, 10 m, PROFIBUS, shielded	DOL-1205-G10MQ	6026008	-	●	-	-	-
	Female connector, M12, 5-pin, straight, 15 m, PROFIBUS, shielded	DOL-1205-G15MQ	6032637	-	●	-	-	-
Illustration may differ	Female connector, M12, 8-pin., straight, 2 m, PUR halogen free, shielded	DOL-1208-G02MAH1	6032448	●	-	●	-	-
	Female connector, M12, 8-pin., straight, 5 m, PUR halogen free, shielded	DOL-1208-G05MAH1	6032449	●	-	●	-	-
	Female connector, M12, 8-pin., straight, 10 m, PUR halogen free, shielded	DOL-1208-G10MAH1	6032450	●	-	●	-	-
Illustration may differ	Male connector, M12, 4-pin, straight, PROFIBUS, terminal resistor	PR-STE-END	6021156	-	●	-	-	-
Illustration may differ	Connection cable, Ethernet patch cable, 2 m, straight, connector M12, 4-pin to connector RJ-45	SSL-2J04-G02ME	6034414	●	●	●	-	●
	Connection cable, Ethernet patch cable, 5 m, straight, connector M12, 4-pin to connector RJ-45	SSL-2J04-G05ME	6035389	●	●	●	-	●
	Connection cable, Ethernet patch cable, 10 m, straight, connector M12, 4-pin to connector RJ-45	SSL-2J04-G10ME	6030928	●	●	●	-	●
Illustration may differ	Connecting cable, M12 male connector, straight, to open end, 2 m	SSL-1204-G02MZ90	6048247	-	-	-	●	-
	Connecting cable, M12 male connector, straight, to open end, 5 m	STL-1204-G05MZ90	6048248	-	-	-	●	-
	Connecting cable, M12 male connector, straight, to open end, 10 m	STL-1204-G10MZ90	6048249	-	-	-	●	-
Illustration may differ	Male connector, M12, 5-pin, straight, 5 m, PROFIBUS, shielded	STL-1205-G05MQ	6026005	-	●	-	-	-
	Male connector, M12, 5-pin, straight, 10 m, PROFIBUS, shielded	STL-1205-G10MQ	6026007	-	●	-	-	-
	Male connector, M12, 5-pin, straight, 15 m, PROFIBUS, shielded	STL-1205-G15MQ	6036898	-	●	-	-	-

Reflectors

	Brief description	Model name	Part no.	Dx100 SSI	Dx100 PROFIBUS	Dx100 RS-422	Dx100 PROFINET	Dx100 CANopen
	Reflector plate, DG tape 665 mm x 665 mm, material: base plate aluminum, screw connection	PL560DG	1016806	●	●	●	●	●

Terminal and alignment brackets

	Brief description	Model name	Part no.	Dx100 SSI	Dx100 PROFIBUS	Dx100 RS-422	Dx100 PROFINET	Dx100 CANopen
	Alignment unit for Dx100, steel, zinc coated, incl. mounting material	BEF-AH-DX100	2058653	●	●	●	●	●

For additional accessories, please see page 23.

Accessories

Adapters/distributors

	Brief description	Model name	Part no.	Dx100 SSI	Dx100 PROFIBUS	Dx100 RS-422	Dx100 PROFINET	Dx100 CANopen
	Signal converter from SSI to analog signal (0 mA ... 20 mA / 4 mA ... 20 mA / 0 V ... 10 V)	HN.SK20.2	6021449	●	-	-	-	-











Device protection (mechanical)





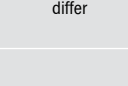







	Brief description	Model name	Part no.	Dx100 SSI	Dx100 PROFIBUS	Dx100 RS-422	Dx100 PROFINET	Dx100 CANopen
	Thermo protection cooling case DS/DT500, peltier cooling unit, fiber glass housing	TPCC Cooling Case Dx100	6048328	●	●	●	●	●







Mounting brackets/plates

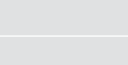

	Brief description	Model name	Part no.	Dx100 SSI	Dx100 PROFIBUS	Dx100 RS-422	Dx100 PROFINET	Dx100 CANopen
	Adapter plate for DME3000 to Dx100	BEF-AP3-Dx100	2064250	●	●	●	●	●
	Adapter plate for DME4000 / DME5000 to Dx100	BEF-AP4/5-Dx100	2062704	●	●	●	●	●

Plug connectors and cables

	Brief description	Model name	Part no.	Dx100 SSI	Dx100 PROFIBUS	Dx100 RS-422	Dx100 PROFINET	Dx100 CANopen
	Data cable for Ethernet with 4-pin M12 plug, angled, 8-pin RJ45 plug, 5 m	Connection cable (plug-plug)	6039488	●	●	●	-	●
 Illustration may differ	Female connector, M12, 4-pin, straight, 2 m, PVC	DOL-1204-G02M	6009382	-	●	-	●	●
	Female connector, M12, 4-pin, straight, 5 m, PVC	DOL-1204-G05M	6009866	-	●	-	●	●
	Female connector, M12, 4-pin, straight, 10 m, PVC	DOL-1204-G10M	6010543	-	●	-	●	●
	Female connector, M12, 4-pin, straight, 15 m, PVC	DOL-1204-G15M	6010753	-	●	-	●	●
	Female connector, M12, 4-pin, straight, 20 m, PVC	DOL-1204-G20M	6034401	-	●	-	●	●
	Female connector, M12, 4-pin, straight, 5 m, PVC, shielded	DOL-1204-G05MA	6042100	-	●	-	●	●
 Illustration may differ	Female connector, M12, 4-pin, straight, 2 m, PUR halogen free	DOL-1204-G02MC	6025900	-	●	-	●	●
	Female connector, M12, 4-pin, straight, 5 m, PUR halogen free	DOL-1204-G05MC	6025901	-	●	-	●	●
	Female connector, M12, 4-pin, straight, 10 m, PUR halogen free	DOL-1204-G10MC	6025902	-	●	-	●	●
	Female connector, M12, 4-pin, straight, 15 m, PUR halogen free	DOL-1204-G15MC	6034749	-	●	-	●	●
	Female connector, M12, 4-pin, straight, 20 m, PUR halogen free	DOL-1204-G20MC	6034750	-	●	-	●	●
	Female connector, M12, 4-pin, straight, 25 m, PUR halogen free	DOL-1204-G25MC	6034751	-	●	-	●	●
	Female connector, M12, 4-pin, straight, 5 m, PUR halogen free, shielded	DOL-1204-G05MAC	6038621	-	●	-	●	●
	Female connector, M12, 4-pin, straight, 10 m, PUR halogen free, shielded	DOL-1204-G10MA	6041797	-	●	-	●	●
 Illustration may differ	Female connector, M12, 4-pin, angled, 2 m, PVC	DOL-1204-W02M	6009383	-	●	-	●	●
	Female connector, M12, 4-pin, angled, 5 m, PVC	DOL-1204-W05M	6009867	-	●	-	●	●
	Female connector, M12, 4-pin, angled, 10 m, PVC	DOL-1204-W10M	6010541	-	●	-	●	●
	Female connector, M12, 4-pin, angled, 15 m, PVC	DOL-1204-W15M	6036474	-	●	-	●	●
	Female connector, M12, 4-pin, angled, 20 m, PVC	DOL-1204-W20M	6033559	-	●	-	●	●
 Illustration may differ	Female connector, M12, 4-pin, angled, 2 m, PUR halogen free	DOL-1204-W02MC	6025903	-	●	-	●	●
	Female connector, M12, 4-pin, angled, 5 m, PUR halogen free	DOL-1204-W05MC	6025904	-	●	-	●	●
	Female connector, M12, 4-pin, angled, 10 m, PUR halogen free	DOL-1204-W10MC	6025905	-	●	-	●	●
	Female connector, M12, 4-pin, angled, 15 m, PUR halogen free	DOL-1204-W15MC	6034752	-	●	-	●	●
	Female connector, M12, 4-pin, angled, 20 m, PUR halogen free	DOL-1204-W20MC	6034753	-	●	-	●	●
	Female connector, M12, 4-pin, angled, 25 m, PUR halogen free	DOL-1204-W25MC	6034754	-	●	-	●	●
	Female connector, M12, 4-pin, angled, 5 m, PVC, shielded	DOL-1204-W05MA	6042098	-	●	-	●	●
 Illustration may differ	Female connector, M12, 5-pin, straight, 5 m, PROFIBUS, shielded	DOL-1205-G05MQ	6026006	-	●	-	-	-
	Female connector, M12, 5-pin, straight, 10 m, PROFIBUS, shielded	DOL-1205-G10MQ	6026008	-	●	-	-	-
	Female connector, M12, 5-pin, straight, 12 m, PROFIBUS, shielded	DOL-1205-G12MQ	6032636	-	●	-	-	-
	Female connector, M12, 5-pin, straight, 15 m, PROFIBUS, shielded	DOL-1205-G15MQ	6032637	-	●	-	-	-
	Female connector, M12, 5-pin, straight, 20 m, PROFIBUS, shielded	DOL-1205-G20MQ	6032638	-	●	-	-	-
	Female connector, M12, 5-pin, straight, 30 m, PROFIBUS, shielded	DOL-1205-G30MQ	6032639	-	●	-	-	-
	Female connector, M12, 5-pin, straight, 50 m, PROFIBUS, shielded	DOL-1205-G50MQ	6032861	-	●	-	-	-

	Brief description	Model name	Part no.	Dx100 SSI	Dx100 PROFIBUS	Dx100 RS-422	Dx100 PROFINET	Dx100 CANopen
	Female connector, M12, 5-pin, straight, 5 m, CAN/CANopen, shielded on pin 1	DOL-1205-G05M_Can	6021166	-	-	-	-	●
	Female connector, M12, 5-pin, straight, 10 m, CAN/CANopen, shielded on pin 1	DOL-1205-G10M_Can	6021175	-	-	-	-	●
	Female connector, M12, 5-pin, straight, 6 m, DeviceNet/CANopen, dropcable shielded	DOL-1205-G06MK	6028326	-	-	-	-	●
	Female connector, M12, 5-pin, angled, 10 m, PROFIBUS, shielded	DOL-1205-W10MQ	6041425	-	●	-	-	-
	Female connector, M12, 8-pin., straight, 2 m, PUR halogen free, shielded	DOL-1208-G02MAH1	6032448	●	-	●	-	-
	Female connector, M12, 8-pin., straight, 5 m, PUR halogen free, shielded	DOL-1208-G05MAH1	6032449	●	-	●	-	-
	Female connector, M12, 8-pin., straight, 10 m, PUR halogen free, shielded	DOL-1208-G10MAH1	6032450	●	-	●	-	-
	Female connector, M12, 8-pin, straight, 20 m, PUR halogen free, shielded,	DOL-1208-G20MAH1	6032451	●	-	●	-	-
	Profibus adapter cable DME4000 / DME5000 to DL100 Hi	DSC-1608-1204	2062595	-	●	-	-	-
	SSI / RS-422 adapter cable DME4000 / DME5000 to DL100 Hi	DSC-1608-1208	2062563	●	-	●	-	-
	SSI / RS-422 adapter cable DME3000 to DL100 Hi	DSC-1612-1208	2061596	●	-	●	-	-
	Connection cable, M12, 5-pin, connector straight/socket straight, 2 m, CAN/CANopen, shielded	DSL-1205-G02MK	6028903	-	-	-	-	●
	Connection cable, M12, 5-pin, connector straight/socket straight, 3 m, CAN/CANopen, shielded	DSL-1205-G03MK	6021165	-	-	-	-	●
	Connection cable, M12, 5-pin, connector straight/socket straight, 5 m, CAN/CANopen, shielded	DSL-1205-G05MK	6021168	-	-	-	-	●
	Connection cable, M12, 5-pin, connector straight/socket straight, 6 m, CAN/CANopen, shielded	DSL-1205-G06MK	6028327	-	-	-	-	●
	Connection cable, M12, 5-pin, connector straight/socket straight, 10 m, PROFIBUS, shielded	DSL-1205-G10MQ	6032640	-	●	-	-	-
	Connection cable, M12, 5-pin, connector straight/socket straight, 1 m, CAN/CANopen, shielded	DSL1205-G01MK	6021164	-	-	-	-	●
	Female connector, M12, 5-pin, 2 m, PVC	DeviceNet cable	6030920	-	-	-	-	●
	Female connector, M12, 5-pin, 3 m, PVC	DeviceNet cable	6030739	-	-	-	-	●
	Female connector, M12, 5-pin, 4 m, PVC	DeviceNet cable	6030740	-	-	-	-	●
	Female connector, M12, 5-pin, 5 m, PVC	DeviceNet cable	6030741	-	-	-	-	●
	Female connector, M12, 5-pin, 6 m, PVC	DeviceNet cable	6030742	-	-	-	-	●
	Cable, by the meter, PROFIBUS, shielded	LTG-2102-MW	6021355	-	●	-	-	-
	Cable, by the meter, 8-pin, PUR halogen free, shielded, twinned wires	LTG-3108-MW	6032456	●	-	●	-	-
	Male connector, M12, 5-pin, straight, PROFIBUS, shielded	PR-STE-1205-G	6021354	-	●	-	-	-
	Male connector, M12, 4-pin, straight, PROFIBUS, terminal resistor	PR-STE-END	6021156	-	●	-	-	-



	Brief description	Model name	Part no.	Dx100 SSI	Dx100 PROFIBUS	Dx100 RS-422	Dx100 PROFINET	Dx100 CANopen
	Connecting cable, M12 male connector, D-coded, angled, to M12 male connector, straight, 2 m	SSL-1204-F02MZ90	6048250	-	-	-	●	-
	Connecting cable, M12 male connector, D-coded, angled, to M12 male connector, straight, 5 m	SSL-1204-F05MZ90	6048251	-	-	-	●	-
	Connecting cable, M12 male connector, D-coded, angled, to M12 male connector, straight, 10 m	SSL-1204-F10MZ90	6048252	-	-	-	●	-
	Connecting cable, M12 male connector D-coded straight to M12 male connector straight, 2 m	SSL-1204-G02MZ90	6048241	-	-	-	●	-
	Connecting cable, M12 male connector, D-coded, straight, to M12 male connector, straight, 5 m	SSL-1204-G05MZ90	6048242	-	-	-	●	-
	Connecting cable, M12 male connector, D-coded, straight, to M12 male connector, straight, 10 m	SSL-1204-G10MZ90	6048243	-	-	-	●	-
	Connecting cable, M12 male connector, D-coded, angled, to RJ45, straight, 2 m	SSL-2J04-F02MZ	6048253	-	-	-	●	-
	Connecting cable, M12 male connector, D-coded, angled, to RJ45, straight, 5 m	SSL-2J04-F05MZ	6048254	-	-	-	●	-
	Connecting cable, M12 male connector, D-coded, angled, to RJ45, straight, 10 m	SSL-2J04-F10MZ	6048255	-	-	-	●	-
 Illustration may differ	Connection cable, Ethernet patch cable, 2 m, straight, connector M12, 4-pin to connector RJ-45	SSL-2J04-G02ME	6034414	●	●	●	-	●
	Connection cable, Ethernet patch cable, 3 m, straight, connector M12, 4-pin to connector RJ-45	SSL-2J04-G03ME	6029630	●	●	●	-	●
	Connection cable, Ethernet patch cable, 5 m, straight, connector M12, 4-pin to connector RJ-45	SSL-2J04-G05ME	6035389	●	●	●	-	●
	Connection cable, Ethernet patch cable, 10 m, straight, connector M12, 4-pin to connector RJ-45	SSL-2J04-G10ME	6030928	●	●	●	-	●
	Connection cable, Ethernet patch cable, 20 m, straight, connector M12, 4-pin to connector RJ-45	SSL-2J04-G20ME	6036158	●	●	●	-	●
	Connection cable, Ethernet patch cable, 25 m, straight, connector M12, 4-pin to connector RJ-45	SSL-2J04-G25ME	6033555	●	●	●	-	●
	Connecting cable, M12 male connector, D-coded, straight, to RJ45, straight, 2 m	SSL-1204-G02MZ60	6048244	-	-	-	●	-
	Connecting cable, M12 male connector, D-coded, straight, to RJ45, straight, 5 m	SSL-1204-G05MZ60	6048245	-	-	-	●	-
	Connecting cable, M12 male connector, D-coded, straight, to RJ45, straight, 10 m	SSL-1204-G10MZ60	6048246	-	-	-	●	-
	Ethernet cable, M12, 4-pin, angled/RJ45, CAT5, 2 m	SSL-2J04-H02ME60	6047911	●	●	●	-	●
	Ethernet cable, M12, 4-pin, angled/RJ45, CAT5, 5 m	SSL-2J04-H05ME60	6045287	●	●	●	-	●
	Ethernet cable, M12, 4-pin, angled/RJ45, CAT5, 10 m	SSL-2J04-H10ME60	6045288	●	●	●	-	●
	Male connector, M12, 5-pin, straight, terminal resistor, DeviceNet and CANopen	STE-1205-GKEND	6037193	-	-	-	-	●
	Connecting cable, M12 male connector, straight, to open end, 2 m	STL-1204-G02MZ90	6048247	-	-	-	●	-
	Connecting cable, M12 male connector, straight, to open end, 5 m	STL-1204-G05MZ90	6048248	-	-	-	●	-
	Connecting cable, M12 male connector, straight, to open end, 10 m	STL-1204-G10MZ90	6048249	-	-	-	●	-
	Connecting cable, M12 male connector, angled, to open end, 2 m	STL-1204-W02MZ90	6048256	-	-	-	●	-
	Connecting cable, M12 male connector, angled, to open end, 5 m	STL-1204-W05MZ90	6048257	-	-	-	●	-
	Connecting cable, M12 male connector, angled, to open end, 10 m	STL-1204-W10MZ90	6048258	-	-	-	●	-
	Connecting cable, M12 male connector, angled, to open end, 25 m	STL-1204-W25MZ90	6048259	-	-	-	●	-

	Brief description	Model name	Part no.	Dx100 SSI	Dx100 PROFIBUS	Dx100 RS-422	Dx100 PROFINET	Dx100 CANopen
	Male connector, M12, 5-pin, straight, 5 m, PROFIBUS, shielded	STL-1205-G05MQ	6026005	-	●	-	-	-
	Male connector, M12, 5-pin, straight, 10 m, PROFIBUS, shielded	STL-1205-G10MQ	6026007	-	●	-	-	-
	Male connector, M12, 5-pin, straight, 12 m, PROFIBUS, shielded	STL-1205-G12MQ	6032635	-	●	-	-	-
	Male connector, M12, 5-pin, straight, 15 m, PROFIBUS, shielded	STL-1205-G15MQ	6036898	-	●	-	-	-
	Connection cable, DeviceNet drop cable, 10 m, straight, connector M12, 5-pin to open end, drag-chain compliant	STL-1205-G10M_CAN	6021293	-	-	-	-	●
	Male connector, M12, 5-pin, angled, 5 m, PROFIBUS, shielded	STL-1205-W05MQ	6041426	-	●	-	-	-
	Male connector, M12, 5-pin, angled, 10 m, PROFIBUS, shielded	STL-1205-W10MQ	6041427	-	●	-	-	-





Power supply units/ power cord connectors

	Brief description	Model name	Part no.	Dx100 SSI	Dx100 PROFIBUS	Dx100 RS-422	Dx100 PROFINET	Dx100 CANopen
	Power supply unit, DC 24 V / 10 A, 110 ... 120, 210 ... 240 VAC, 24 VDC, 10 A, for cap rail mounting and TPCC supply	Power supply unit	6020875	●	●	●	●	●

Reflectors

	Brief description	Model name	Part no.	Dx100 SSI	Dx100 PROFIBUS	Dx100 RS-422	Dx100 PROFINET	Dx100 CANopen
	Reflector plate, DG tape 1,200 mm x 1,200 mm, material: base plate aluminum, screw connection	PL1200DG	1051679	●	●	●	●	●
	Reflector plate, DG tape 330 mm x 330 mm, material: base plate aluminum, screw connection	PL240DG	1017910	●	●	●	●	●
	Reflector plate, DG tape 330 mm x 330 mm, material: base plate aluminum, screw connection, heated	PL240DG-H	1022926	●	●	●	●	●
	Reflector plate, DG tape 665 mm x 665 mm, material: base plate aluminum, screw connection	PL560DG	1016806	●	●	●	●	●
	Reflector plate, DG tape 665 mm x 665 mm, material: base plate aluminum, screw connection, heated	PL560DG-H	1023888	●	●	●	●	●
	Reflector plate, DG tape 1,000 mm x 1,000 mm, material: base plate aluminum, screw connection	PL880DG	1018975	●	●	●	●	●
	Diamond Grade reflective tape, sheet, 749 mm x 914 mm, self-adhesive	REF-DG	5320565	●	●	●	●	●
	Diamond Grade reflective tape, customizable by sheet, self-adhesive	REF-DG-K	4019634	●	●	●	●	●

Sets

		Model name	Part no.	Dx100 SSI	Dx100 PROFIBUS	Dx100 RS-422	Dx100 PROFINET	Dx100 CANopen
	Accessory kit for retrofit from DME3000 PROFIBUS to Dx100 PROFIBUS	DME3000 Dx100 PROFIBUS retrofit kit	2065222	-	●	-	-	-
	Accessory kit for retrofit from DME3000 SSI/RS-422 to Dx100 SSI/RS-422	DME3000 Dx100 SSI/RS-422 retrofit kit	2065223	●	-	●	-	-
	Accessory kit for retrofit from DME4000/5000 PROFIBUS to Dx100 PROFIBUS	DME4000/5000 Dx100 PROFIBUS retrofit kit	2065220	-	●	-	-	-
	Accessory kit for retrofit from DME4000/5000 SSI/RS-422 to Dx100 SSI/RS-422	DME4000/5000 Dx100 SSI/RS-422 retrofit kit	2065221	●	-	●	-	-

Terminal and alignment brackets

	Brief description	Model name	Part no.	Dx100 SSI	Dx100 PROFIBUS	Dx100 RS-422	Dx100 PROFINET	Dx100 CANopen
	Alignment unit for Dx100, steel, zinc coated, incl. mounting material	BEF-AH-DX100	2058653	●	●	●	●	●

www.mysick.com – search online and order

Search online quickly and safely – with the SICK “Finders”

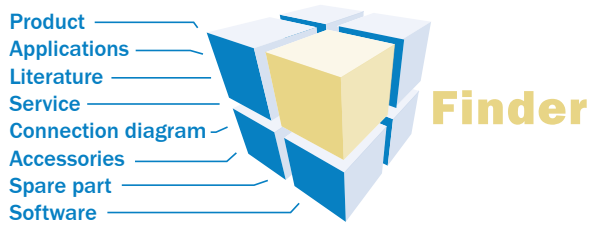

Product Finder: We can help you to quickly target the product that best matches your application.

Applications Finder: Select the application description on the basis of the challenge posed, industrial sector, or product group.

Literature Finder: Go directly to the operating instructions, technical information, and other literature on all aspects of SICK products.

Efficiency – with the e-commerce tools from SICK



Find out prices and availability: Determine the price and possible delivery date of your desired product simply and quickly at any time.

Request or view a quote: You can have a quote generated online here. Every quote is confirmed to you via e-mail.

Order online: You can go through the ordering process in just a few steps.

For safety and productivity: SICK LifeTime Services

SICK LifeTime Services is a comprehensive set of high-quality services provided to support the entire life cycle of products and applications from system design all the way to upgrades. These services increase the safety of people, boost the productivity of machines and serve as the basis for our customers’ sustainable business success.



Consulting & Design

Globally available experts for cost-effective solutions



Product & System Support

Fast and reliable, by telephone or on location



Verification & Optimization

Checks and recommendations for increased availability



Upgrade & Retrofits

Uncovers new potential for machines and systems



Training & Education

Employee qualification for increased competitiveness

SICK at a glance

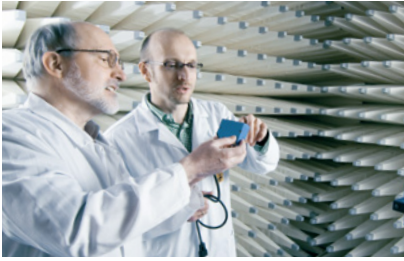

Leading technologies

With a staff of more than 6,000 and over 40 subsidiaries and representations worldwide, SICK is one of the leading and most successful manufacturers of sensor technology. The power of innovation and solution competency have made SICK the global market leader. No matter what the project and industry may be, talking with an expert from SICK will provide you with an ideal basis for your plans – there is no need to settle for anything less than the best.



Unique product range

- Non-contact detecting, counting, classifying, positioning and measuring of any type of object or media
- Accident and operator protection with sensors, safety software and services
- Automatic identification with bar code and RFID readers
- Laser measurement technology for detecting the volume, position and contour of people and objects
- Complete system solutions for analysis and flow measurement of gases and liquids



Comprehensive services

- SICK LifeTime Services – for safety and productivity
- Application centers in Europe, Asia and North America for the development of system solutions under real-world conditions
- E-Business Partner Portal www.mysick.com – price and availability of products, requests for quotation and online orders

Worldwide presence with subsidiaries in the following countries:

Australia
Belgium/Luxembourg
Brasil
Česká Republika
Canada
China
Danmark
Deutschland
España
France
Great Britain
India
Israel
Italia
Japan

México
Nederland
Norge
Österreich
Polska
România
Russia
Schweiz
Singapore
Slovenija
South Africa
South Korea
Suomi
Sverige
Taiwan
Türkiye
United Arab Emirates
USA

Please find detailed addresses and additional representatives and agencies in all major industrial nations at www.sick.com