

F3SN-A

Safety Light Curtain

TECHNICAL MANUAL

OMRON

F3SN-A

Safety Light Curtain

Technical Manual

November 2002



Introduction

Thank you for purchasing the F3SN-A Series Safety Light Curtain (hereinafter referred to as "the F3SN-A"). This is the Instruction Manual describing the use of the F3SN-A.

Always heed the following points when using the F3SN-A:

- Read this manual thoroughly and be sure you understand the information provided before attempting to operate the F3SN-A.
- It is assumed that the F3SN-A will be used properly according to the installation environment, performance and function of the machine. Qualified personnel should conduct a risk assessment on the machine and determine the suitability of this product before installation.
- Make sure that the personnel operating the F3SN-A are knowledgeable about its operation and the machine on which it is installed.
- Keep the manual in a secure and convenient location and refer to it as necessary.

Regulations and Standards

1. The F3SN-A has not received the type approval provided by Article 44-2 of the Industrial Safety and Health Law of Japan. Therefore, it cannot be used in Japan as a safety device for pressing or shearing machines provided by article 42 of that law.

2. a) The F3SN-A is electro-sensitive protective equipment (ESPE) in accordance with European Union (EU) Machinery Directive Annex IV, B, Safety Components, Item 1.

b) The F3SN-A complies with the following regulations and standards:

1. EU regulations

Machinery Directive: Directive 98/37/EC

EMC Directive: Directive 89/336/EEC

2. European standard: EN61496-1 (TYPE 4 ESPE)

3. International standard: IEC61496-1 (TYPE 4 ESPE), IEC61496-2 (TYPE 4 AOPD)

c) The F3SN-A received the following approvals from the EU accredited body DEMKO A/S:

- EC Type-Examination in accordance with the EU Machinery Directive

- Certificate of a Competent Body, in accordance with EMC guidelines

- DEMKO Type Approval TYPE 4 ESPE (EN61496-1)

TYPE 4 AOPD (IEC61496-2)

Use: EN954-1 Category B, 1, 2, 3, 4

d) The F3SN-A received the following approvals from the Third Party Assessment Body UL:

- Certificate of UL listing for US and Canadian safety standards

Both for: TYPE 4 ESPE (IEC61496-1)

TYPE 4 AOPD (IEC61496-2)

- Certificate of Programmable System (UL1998, IEC61496-1)

1. The F3SN-A is designed according to the following standards. To make sure that the F3SN-A complies with the following standards and regulations, you are asked to design and use it as provided by any other related standards, laws, and regulations.

Consult the TÜV, UL or other standardization bodies if you have any questions.

EN415-4, prEN691, EN692, prEN693 (European standard)

OSHA 29 CFR 1910.212 (US Industrial Safety and Health Regulation)

OSHA 29 CFR 1910.217 (US Industrial Safety and Health Regulation)

ANSI B11.1~B11.19 (US standard)

ANSI/RIA 15.06 (US standard)

Note Give sufficient safety considerations and make enough allowance with regard to ratings and functions of the system when using the F3SN-A under following conditions:

- a) Conditions or environment not specified in this manual
- b) Applications to devices and facilities requiring special safety precautions, such as; nuclear energy control, railway, aircraft, vehicles, combustion facility, medical system, space development, large amusement machines, etc.

Precautions Safety

General Conventions for Safe Use

The following conventions are used for precautionary items in this manual in order to ensure safe and proper use of the F3SN-A. Items listed here are critical for safety and must be heeded at all times.

 **WARNING** Indicates a potentially hazardous situation, which, if not avoided, could result in death or serious injury.

CAUTION Indicates prohibited actions.

 **WARNING** After setting the fixed blanking, check that the F3SN-A detects a test rod at any position in the detection zone through which a person can reach the hazardous part of the machine. If any positions are found by the check above, install protective structures to prevent intrusion which the F3SN-A cannot detect. Failure to do so may result in serious injury. (Chapter 1-2)

Use of the floating blanking increases the size of the detection capability. To calculate a safety distance, be sure to use the increased size of the detection capability. Failure to do so causes the machine to fail to stop before an operator reaches the dangerous area and may result in serious injury. (Chapter 1-2)

Do not use the F3SN-A on machines that cannot be stopped by electrical control in case of an emergency, such as a pressing machine with full-rotation clutch system. Serious injury may result if the machine does not stop before someone reaches the hazardous part. (Chapter 2-1)

Proper configuration of the control circuit is required between the F3SN-A and the machine which it is used in PSDI “presence sensing device initiator” mode. Refer to OSHA1910.217, IEC61496-1, and other related standards and regulations for more detail on PSDI. (Chapter 2-1)

Install protective structures around the machine so that you must pass through the detection zone of the F3SN-A to reach a hazardous part of the machine. Install the F3SN-A in such a way that when working on hazardous parts of the machine, some parts of the operator's body remain in the detection zone. (Chapter 2-1)

The switch to reset the interlock condition must be installed so that the entire hazardous area is visible and free of personnel, also the switch must not be able to be operated from within the hazardous area. (Chapter 2-1)

Do not use the F3SN-A in flammable or explosive environments. Failure to do this may cause an explosion. (Chapter 2-1)

The F3SN-A does not offer protection to the operator's body from projectiles exiting the hazardous area. Proper means of mechanical guarding must be provided to ensure protection from these potentially hazardous projectiles. (Chapter 2-1)

Always maintain the safe calculated distance between the F3SN-A and the hazardous part of a machine to avoid serious injury that may be caused by touching the hazard before the machine has stopped. (Chapter 2-1)

Do not install the F3SN-A in a location where it can be affected by wall reflections, to avoid detection failure which may result in serious injury. (Chapter 2-1)

Use the emitter and receiver in proper arrangement to avoid creation of undetectable zones. The set type of the emitter and receiver must be the same. (Chapter 2-1)

Be sure to securely fasten the F3SN-A to the machine and tighten the cable connector. (Chapter 2-1)

When using multiple sets of F3SN-A, arrange them to prevent mutual interference. (Chapter 2-1)

Do not short-circuit the outputs to the +24V. Doing so will cause the output to be always ON, creating a hazardous situation. Connect the 0V line of the power supply directly to protective earth to prevent the earth fault. Otherwise the earth fault causes the outputs to be ON. (Chapter 2-4)

Connect loads between the output and 0V line. (PNP output) Connecting loads between the output and +24V line will reverse the operation mode and the machine will be ON when it is light-interrupted. (Chapter 2-4)

Always use the two OSSD outputs to configure the safety system. Using only one OSSD of the safety system may result in serious injury when there is an output circuit failure. (Chapter 2-4)

Do not connect any of the F3SN-A lines to a DC power supply with more than 24VDC+10% or to an AC power supply to avoid the danger of electric shock. (Chapter 2-4) DC power supply units must satisfy all of the following conditions so that the F3SN-A can comply with the applicable standards IEC 61496-1, and UL 508.

- The power supply voltage must be within specified ratings (24 VDC \pm 10 %).
- The power supply is connected only to the F3SN-A and to the devices related to the electro-sensitive protective function of the F3SN-A, such as a safety controller and muting sensors, and it has enough rated current for all the devices.
- The power supply must not be connected to other devices or machines.
- The power supply uses double or reinforced insulation between the primary and secondary circuits. The power supply automatically resets over-current protection characteristics (voltage drop).
- The power supply maintains an output holding time of at least 20 ms. FG (frame ground terminal) must be connected to PE (protective earth) when using a commercially available switching regulator.
- The power supply must have output characteristics of Class 2 Circuit of Limited Voltage-Current Circuit as defined in UL508 (see "2-4-1 Note").
- The power supply must conform to regulatory requirements and standards, regarding EMC and electrical equipment safety, of the country where the F3SN-A is installed and where machinery will be operated.
Example: The EMC Directive (industrial environment) and the Low Voltage Directive in the EU.

A qualified person must confirm that installation, inspection and maintenance of the F3SN-A are implemented correctly as determined by local regulations where the equipment is installed and used.

Do not disassemble, repair or modify the F3SN-A.

Do not use the F3SN-A in a reflective configuration, otherwise detection may fail. (Chapter 2-1)

Reflective panel

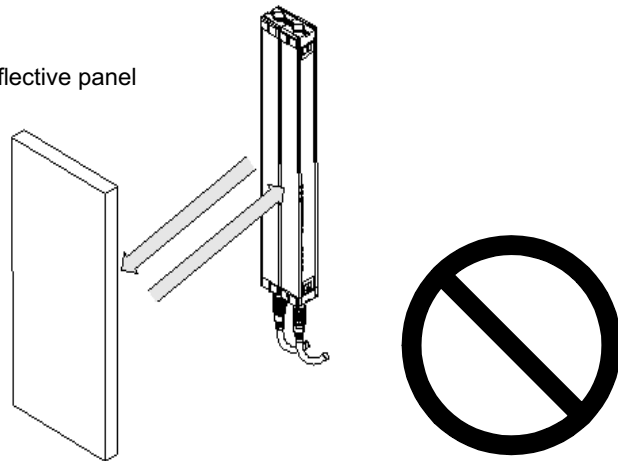

For Your Safety always heed the Following Points:

1. The procedures for installation, inspection and maintenance in this manual should be read carefully.
2. Loads must satisfy all the conditions below:
 - They must not be short-circuited.
 - They must not have characteristics which exceed the technical data.
3. All input lines and output lines of the F3SN-A should insulate against hazardous voltage levels (230 VAC, etc.), not simply against 24 VDC, with double or reinforced insulation to protect against electrical shock. In case of the combination with the F3SP-B1P, all relay output terminals (13-14, 23-24, 33-34, and 41-42) should insulate against hazardous voltage levels with basic insulation.
4. Be sure to dispose of the F3SN-A as industrial waste.

Correct Usage

For Your Safety always heed the Following Points:

Installation Environment

- Do not install the F3SN-A in the following environments:
 - Areas exposed to intense interference light, such as direct sunlight.
 - Areas with high humidity where condensation is likely to occur.
 - Areas exposed to corrosive gases.
 - Areas exposed to vibration or shock levels higher than specification provisions.
 - Areas where the light curtain may come in direct contact with water.
- Do not use radio equipment, such as cellular phones, walkie-talkies, or transceivers with high power, near the F3SN-A.

Wiring and Mounting

- Be sure to turn OFF the power prior to wiring, otherwise the diagnostic function may prevent the light curtain from operating.
- Use shielded twisted pair cable (cross-sectional area: 0.3mm² or more) when extending the communication lines with a cable other than the dedicated cable (F39-JC), and connect the shield to the 0V line.
- When replacing the cable connector with other connectors (e.g. resin connectors), make sure the connector is rated IP54 or higher.

- When the distance between the emitter and the receiver is less than 0.2m, there is a possibility of a malfunction in which the F3SN-A goes into the OFF state momentarily. Be sure to install the F3SN-A within the rated operating range.
- Check the signal names (cables and terminals) during wiring.
- Devise a measure to protect against mutual interference when using two or more sets of F3SN-A beside one another.
- Do not operate the control system until one second or more after turning ON the power of the F3SN-A.
- Be sure to route the F3SN-A cable separately from high-potential power lines or through its own duct or conduit.
- The emitter and receiver are to be mounted in parallel and facing one another.

Do not use any solvents such as paint thinners, benzine or acetone to clean the F3SN-A because it will dissolve resin and paint.

The F3SN-A cannot detect transparent or semi-transparent materials.

Prior to Use

Verify that the following items are supplied with each F3SN-A, contact your nearest OMRON representative or distributor if any item is missing.

- F3SN-A□□□□P□□ unit (emitter qty. 1, receiver qty. 1)
- Mounting brackets (top and bottom) qty. 4

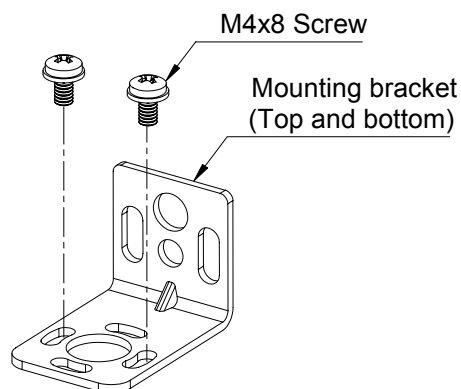

- Mounting brackets (intermediate)

Supplied with light curtains which have a mounting distance of 640 mm or more. A maximum of 4 sets can be mounted within 640 mm (max. 2 sets for each emitter and receiver), depending on the height of the light curtain.

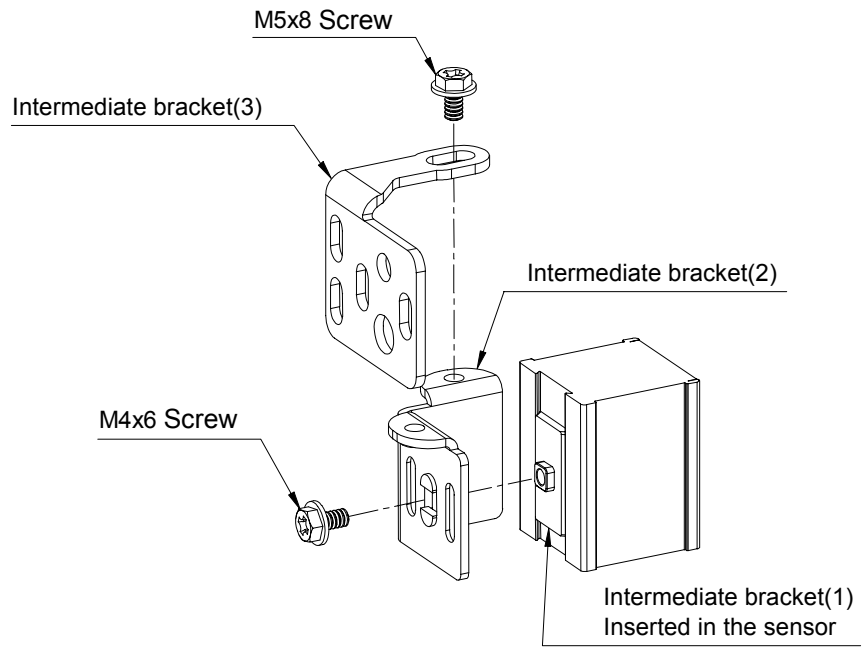

- Test Rod qty. 1
14mm dia. for F3SN-A□□□□P14 / P14-01
25mm dia. for F3SN-A□□□□P25 / P25-01
40mm dia. for F3SN-A□□□□P40 / P40-01
(Test rod is not supplied with the F3SN-A□□□□P70 / P70-01.)
- Error mode label qty. 1
- Instruction manual (this manual) qty. 1



TABLE OF CONTENTS

Chapter 1 - Description

1-1	Features	2
1-2	Functions	3
1-2-1	Interlock Function	3
1-2-2	Test Function	4
1-2-3	Auxiliary Output (Non-safety Output)	5
1-2-4	External Indicator Output	5
1-2-5	EDM (External Device Monitoring Function)	6
1-2-6	Fixed Blanking Function (Optional)	6
1-2-7	Floating Blanking Function (Optional)	7
1-2-8	Detection Zone	7
1-2-9	Series Connection	8
1-2-10	Indicators	9
1-3	Ratings and Performance	11
1-3-1	Specification	11
1-3-2	Response Time	12

Chapter 2 - Mounting and Adjustment Procedures

2-1	Installation Conditions	16
2-1-1	Detection Zone and Intrusion Path	16
2-1-2	Safety Distance	17
2-1-3	Distances from Reflective Surfaces	19
2-1-4	How to Prevent Mutual Interference	20
2-2	Dimensional Drawings	22
2-3	Mounting	27
2-3-1	How to Mount the Unit	27
2-3-2	Dimensional Drawing of the Mounting Bracket	28
2-4	Wiring	32
2-4-1	Power Supply Units	32
2-4-2	Wiring Diagram	34
2-4-3	Wiring Procedures	36
2-4-4	Adjustment Procedures	38
2-5	Check List	38

Chapter 3 - General Specifications

3-1	I/O Circuit	42
-----	-------------	----

Chapter 4 - Sample Circuits

4-1	Applications	46
-----	--------------	----

Chapter 5 - Maintenance

5-1	General	50
5-2	Daily Inspections	50
5-3	Inspections every Six Months	51

Chapter 6 - Troubleshooting

6-1 Lockout Condition 54
6-2 Other Trouble 55

Appendix

Appendix A - Optional Accessories 57
Appendix B - Applicable Standards 61
Appendix C - Function Settings 63
Appendix D - EU Declaration of Conformity 65

CHAPTER 1

Description

1-1	Features	2
1-2	Functions	3
1-2-1	Interlock Function	3
1-2-2	Test Function	4
1-2-3	Auxiliary Output (Non Safety Output)	5
1-2-4	External Indicator Output	5
1-2-5	EDM (External Device Monitoring Function)	6
1-2-6	Fixed Blanking Function (Optional)	6
1-2-7	Floating Blanking Function (Optional)	7
1-2-8	Detection Zone	7
1-2-9	Series Connection	8
1-2-10	Indicators	9
1-3	Ratings and Performance	11
1-3-1	Specification	11
1-3-2	Response Time	13

1-1 Features

■ **Available in either 7 m or 10 m detection distance:**

F3SN-A□□□□P14 series: 7 m

F3SN-A□□□□P25 series: 10 m

F3SN-A□□□□P40 series: 10 m (see note 1)

F3SN-A□□□□P70 series: 10 m (see note 1)

■ **Detection capability:**

F3SN-A□□□□P14 series: 14 mm dia.

F3SN-A□□□□P25 series: 25 mm dia.

F3SN-A□□□□P40 series: 40 mm dia. (see note 1)

F3SN-A□□□□P70 series: 70 mm dia. (see note 1)

■ **Protective height (light curtain length): Come in wide selection to suit individual requirements**

F3SN-A□□□□P14 series: 53 models in 18 mm increments between 189 mm and 1125 mm

F3SN-A□□□□P25 series: 108 models in 15 mm increments between 217 mm and 1822 mm

F3SN-A□□□□P40 series: 54 models in 30 mm increments between 217 mm and 1807 mm (see note 1)

F3SN-A□□□□P70 series: 27 models in 60 mm increments between 277 mm and 1777 mm (see note 1)

Note1: Supplied on request. To order, contact your OMRON representative.

■ **External size of the light curtain corresponds to the protective height:**

(Except for the F3SN-A□□□□P14 series)

■ **Indication of light intensity**

Received light intensity is indicated by a 5-bar LED display to aid in beam alignment.

■ **Indication of error mode**

Error mode is indicated by a separate 3-bar LED display.

■ **Safety-related functions:**

- External test function (Emission stop function)
- EDM (External device monitoring function)
- Interlock function
- Fixed blanking function / Floating blanking function (must be set using the F39-MC11)

■ **Auxiliary output (non-safety output)**

Allows the light curtain status to be transmitted to a PLC or other device.

■ **Control Unit: F3SP-B1P (optional accessory)**

Allows for quick connection of the light curtain into the safety circuit.

■ **Setting Console: F39-MC11 (optional accessory)**

By connecting this handheld console to the light curtain, various functions of the light curtain can be accessed.

■ **Degree of protection: IP65 (for light curtain only)**

■ **Series connectable models**

The series-connection type allows multiple units to be connected together to protect against mutual interference, or an external indicator can be connected to indicate the light curtain status.

Note The series connection types, with the exception of the F3SN-A□□□□P25-01, are available on request. To order, contact your sales office.

[Nomenclature]

1) 2) 3) 4) 5)
F3SN – A□□□□P□□ – □ – □□

- 1) Protective height (mm)
- 2) P: PNP output type
- 3) Detection capability (mm)
- 4) Blank: Set of emitter and receiver,
L: Emitter,
D: Receiver
- 5) Blank: stand-alone
01: Series-connection

1-2 Functions

1-2-1 Interlock Function

The auto and manual reset modes are optional features of the F3SN-A which can be set by wiring the device appropriately.

Auto Reset Mode

After the power is turned ON and if none of the beams are interrupted, the OSSD (Output Signal Switching Device) outputs will go to their ON-state.

1-2-1-1 To Enable Auto Reset Mode:

- 1) Leave the interlock selection input line open or connect it to 0VDC.
- 2) Connect the Reset input line to 24VDC. (9VDC to Vs, nominal 24VDC)
- 3) Turn ON the power to the F3SN-A.

Manual Reset Mode

There are 3 options for manual reset:

- Start/restart interlock
After the power is turned ON, or when at least one beam is interrupted, the light curtain enters the interlock condition.
- Start interlock
Only after power ON, the light curtain enters the interlock condition.
- Restart interlock
Only when at least one beam is interrupted, the light curtain enters the interlock condition.

For the factory setting, the start/restart interlock is selected in the manual reset mode. Other options are selected by the setting console, F39-MC11 (optional). When the light curtain enters the interlock condition, it keeps the OSSD outputs in the OFF-state. Even if all beams become free, the OSSD outputs will not go to the ON-state. When none of the beams are interrupted in the detection zone, applying the reset input (see the note) resets the interlock condition and the OSSD outputs go to the ON-state.

Note Apply a voltage of 24VDC (9VDC to Vs, nominal 24VDC) to the reset input line for 100 ms or more, then remove power to the reset input line or apply a voltage of 0 VDC.

1-2-1-2 To Enable Manual Reset Mode:

1. Connect the reset input line to 24VDC (9VDC to V_s , nominal 24VDC).
2. Connect the reset input line via a reset switch (normally open contact) to 24VDC (9VDC to V_s , nominal 24VDC).
3. Turn on the power to the light curtain while the reset switch contact remains open.

- Note 1:** The switch to reset the interlock condition has to be installed out of the hazardous area. Before the start/restart interlock is reset, the hazardous area must be visibly free of personnel.
- 2:** Prevent short-circuiting of unconnected wires of the light curtain with other wires.

1-2-2 Test Function

1-2-2-1 Self-test

After power ON, the F3SN-A performs a complete self-test within 1 second. In addition, it performs a self-test (within response time) periodically during operation.

1-2-2-2 External Test

This function will stop the light-emitting of the light curtain at any time to confirm the output is turned OFF normally. Applying a voltage of 24VDC (9V to V_s , nominal 24VDC) (see note 1) to the test input line of the emitter makes the emitter stop emitting.

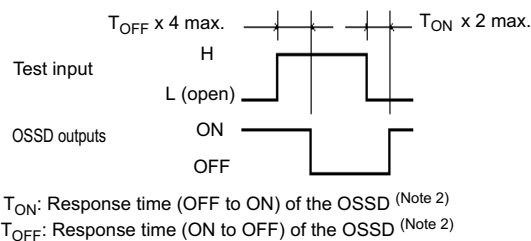

- Note 1:** Applied time should be more than four times T_{OFF} .
- 2:** For T_{ON} and T_{OFF} , refer to "1-3 Ratings and Performance".

1-2-2-3 Error Detection and Restoration (Lockout Condition)

If an error is detected by the self-test, the light curtain enters the lockout condition, keeps the OSSD outputs in their OFF-state and displays the error mode (see note 1).

Turning the power ON again, or applying power to the reset input (see note 2) of the light curtain, resets the lockout condition. (For noise, eliminating the noise automatically resets the lockout condition.)

- Note 1:** Refer to "1-2-10 Indicators" for the indicating patterns.
- 2:** In case of manual reset mode:
 Apply a voltage of 24VDC (9VDC to V_s , nominal 24VDC) to the reset input line for 100 ms or more, then remove power to the reset input line or apply a voltage of 0VDC.
 In case of auto reset mode:
 Open the reset input line or connect it to 0VDC for 100ms or more, then re-apply a voltage of 24VDC (9VDC to V_s , nominal 24VDC).

1-2-3 Auxiliary Output (Non-safety Output)

The default of this output is the reverse signal of the safety outputs (Dark-ON output). This output can be used for monitoring purposes by connecting it to a device such as a PLC.

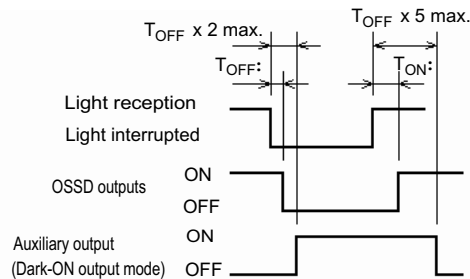

T_{ON} : Response time (OFF to ON) of the OSSD
 T_{OFF} : Response time (ON to OFF) of the OSSD

The auxiliary output can be selected to give one of the following output operation modes by the F39-MC11.

- Dark-ON output mode
- Light-ON output mode
- Light diagnosis mode
- Lockout mode
- Outermost-beam monitoring mode
- Specified-beam mode
- Blanking monitoring mode

The diagram above shows the timing chart for the Dark-ON output mode. For detailed information, refer to the instruction manual of the F39-MC11.

1-2-4 External Indicator Output

This output can be connected to an external indicator to display one of the operation modes as selected by the F39-MC11. The default of this output is Light-ON output. Selectable output modes are as follows:

- Dark-ON output mode
- Light-ON output mode
- Light diagnosis mode
- Lockout mode

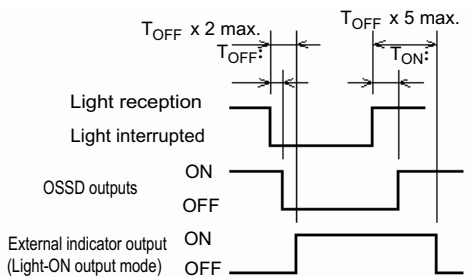

T_{ON} : Response time (OFF to ON) of the OSSD
 T_{OFF} : Response time (ON to OFF) of the OSSD

The diagram above shows the timing chart for the Light-ON output mode. For detailed information, refer to the instruction manual of the F39-MC11.

The indicator can be directly attached to the light curtain by using the external indicator F39-A01P□-□, as shown in the figure, for use with series-connection types only.

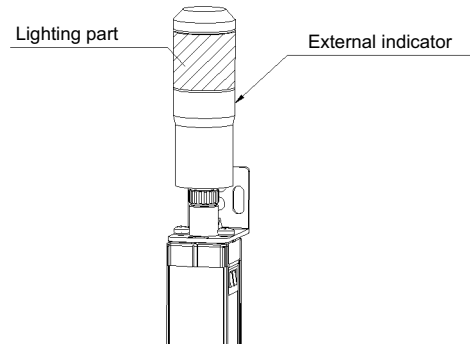

1-2-5 EDM (External Device Monitoring Function)

This function makes it possible to monitor the state of the NC contacts of the MPCEs (*1), so that a malfunction of a MPCE, such as a welded contact, can be detected. Connect (*2) the NC contact of the MPCEs to the EDM input line of the receiver. If the correct logical relationship between the OSSD outputs and the EDM input is not kept, the light curtain immediately enters the lockout condition and the OSSD outputs will go to their OFF-state. The light curtain's normal operation is up to 300ms max. (*3), this allows for the delay time caused by the release of the MPCEs. To ensure the correct usage of this function, the MPCEs must be safety-approved types with forcibly-guided contacts.

■ [When the EDM is not used]

In the case that the EDM input is not used, connect the auxiliary output in the Dark-ON output mode to the EDM input line, or disable the EDM with the F39-MC11 setting console.

- * 1. MPCEs (Machine Primary Control Elements) are usually relays or contactors used to control hazardous movement directly.
- * 2. Connect the wires such that 24VDC is applied to the EDM input via the series connected NC contacts. (Refer to 2-4 Wiring).
- * 3. The value can be changed by the F39-MC11.

1-2-6 Fixed Blanking Function (Optional)

⚠ WARNING After setting the fixed blanking, check that the F3SN-A detects a test rod at any position in the detection zone through which a person can reach the hazardous part of the machine. If any positions are found by the check above, install protective structures to prevent intrusion which the F3SN-A cannot detect. Failure to do so may result in serious injury.

This function is set with the F39-MC11 setting console and disables part of detection zone of the light curtain. If an object enters the disabled detection zone, the OSSD outputs status will not change. This function is used when there is a stationary object in the detection zone that needs to be ignored.

Refer to the instruction manual of the F39-MC11 for detailed information.

1-2-7 Floating Blanking Function (Optional)

⚠ WARNING Use of the floating blanking increases the size of the detection capability. To calculate a safety distance, be sure to use the increased size of the detection capability. Failure to do so causes the machine to fail to stop before an operator reaches the dangerous area and may result in serious injury.

This function is set with the F39-MC11 setting console.

During normal operation when floating blanking is disabled, and at least one beam is interrupted the light curtain will go to the OFF-state. However, using this function prevents the light curtain from going to the OFF-state until multiple beams (see the notes) are interrupted.

- Note 1:** The number of the floating blanking beams can be selected in the range of 1 to 3 beams.
- 2:** This function can be set so that the interrupted beams must be directly adjacent to each other.
- 3:** This function can be set so that the top and bottom beams cannot be set for the function.

The size of the detection capability is increased by using floating blanking as shown in the following table. The label on the light curtain indicates all 4 kinds of the possible detection capabilities. Obscure inapplicable sizes of the detection capability with a permanent marker, and leave only an applicable size on the label.

	No. of floating blanking beams			
	No beam	1 beam	2 beams	3 beams
F3SN-A□□□□P14/P14-01	14 mm	23 mm	32 mm	41 mm
F3SN-A□□□□P25/P25-01	25 mm	40 mm	55 mm	70 mm
F3SN-A□□□□P40/P40-01	40 mm	70 mm	100 mm	130 mm
F3SN-A□□□□P70/P70-01	70 mm	130 mm	190 mm	250 mm

For detailed information, refer to the instruction manual of the F39-MC11.

1-2-8 Detection Zone

[Protective height]

F3SN-A____P14 series: Protective height = Total length of the optical cover
 Other series: Protective height = Total length of the light curtain

[Beam center-line mark]

The two lines marked at the center of the caps indicate the center of the beams. (See the figure shown below). This position is a reference line for measuring safety distance. Use the line closer to the hazardous area as a reference line for the safety distance.

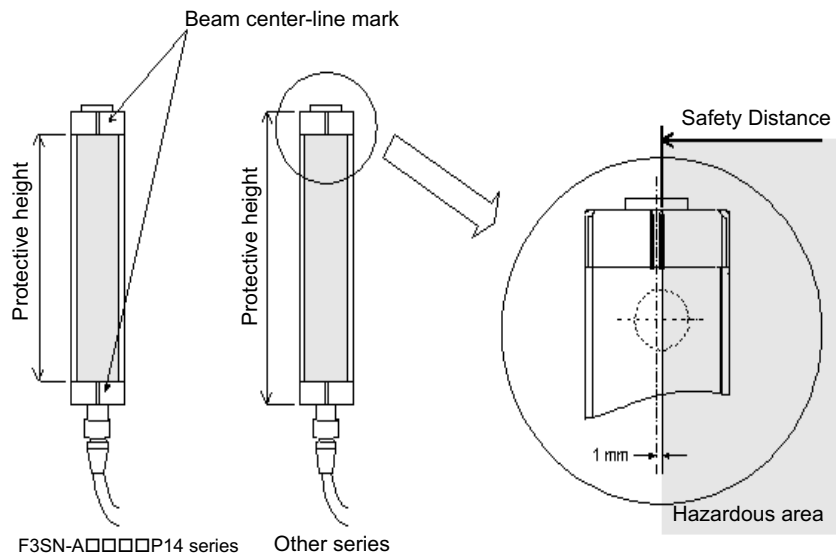

1-2-9 Series Connection

Light curtains can be connected in series using the connectors for series connection as shown in the figure below. Both the stand-alone type and the series connection type can be used for the light curtains located at the top end.

When any beam of the light curtains connected in series is interrupted, both the OSSD outputs go to the OFF-state. The LED indicators for each light curtain are individually lit.

- No. of series connected light curtains: Up to 3 sets
- No. of beams: Up to 240 beams
- Length of the series connection cable: 3 m max.

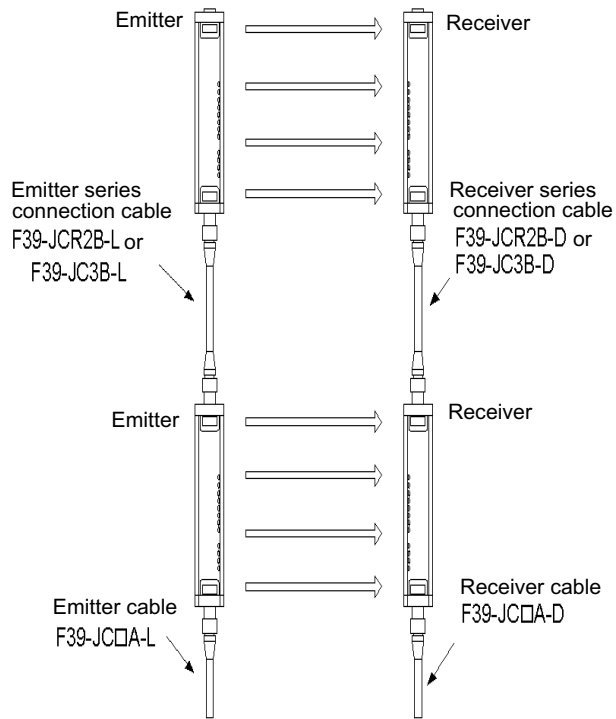

1-2-10 Indicators

[Emitter]

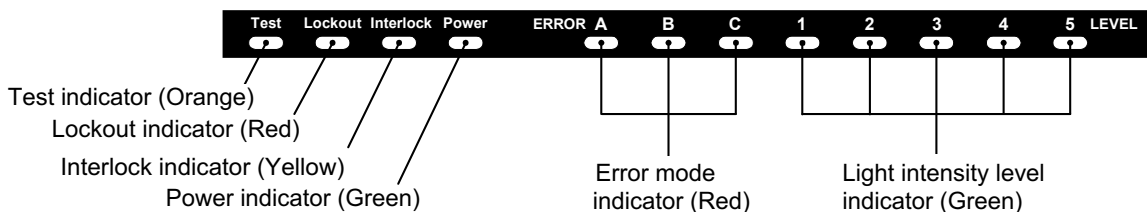



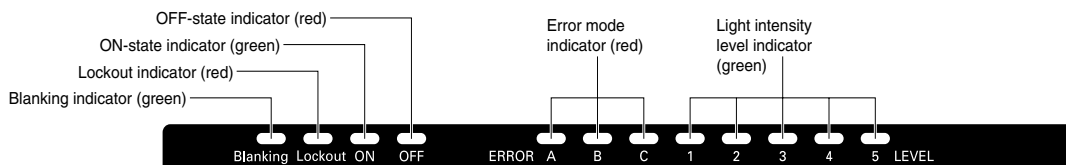





[Receiver]

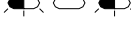

- Power indicator: Lit when power is supplied.
- Interlock indicator: Lit during interlock condition
- Lockout indicator: Flashing during lockout condition.
- Test indicator: Lit during external test, flashing after a lapse of 30000 hours.
- ON-state indicator: Lit when OSSD outputs are in ON-state.
- OFF-state indicator: Lit when OSSD outputs are in OFF-state.
- Blanking indicator: Lit when blanking is set, flashing when the F39-MC11 is connected, flashing after a lapse of 30000 hours.
- Light intensity level indicator: Lit according to light intensity. (See the table shown below).
- Error mode indicator: Flashing to indicate error mode. (Flashing pattern varies depending on the error condition. See the table shown below).

	1	2	3	4	5	Light intensity level
Light intensity level indicator Lit Not lit						200% and above of ON threshold level
						150 to 200% of ON threshold level
						100 to 150% of ON threshold level
						75 to 100% of ON threshold level
						50 to 75% of ON threshold level
						less than 50% of ON threshold level

	A B C	Cause of error
Error mode indicator   Flashing Not lit		The Interlock selection input line or the reset input line is not wired correctly or became open.
		Relay contact is welded. Releasing time of the relay takes too long. The EDM input line is not wired correctly or became open.
		Communication line (RS-485) is not wired correctly, became open, or causes other errors.
		One of the OSSD outputs is shorted or is not wired correctly.
		Mutual interference. Interference light is received.
		The receiver and emitter types are not identical. Number of receivers and emitters connected in series is not the same.
		External noise. Internal hardware failure of the receiver or the emitter.

Note Attaching the supplied error mode label near the light curtain facilitates diagnosis of the cause of errors.

1-3 Ratings and Performance

1-3-1 Specification

The four-digit numbers indicate the protective heights and are replaced by □□□□ in the model names.

Type	Stand-alone	F3SN-A□□□□P14 F3SN-A□□□□P14-02	F3SN-A□□□□P25 F3SN-A□□□□P25-02	F3SN-A□□□□P40 F3SN-A□□□□P40-02	F3SN-A□□□□P70 F3SN-A□□□□P70-02
Item	Series-connection	F3SN-A□□□□P14-01	F3SN-A□□□□P25-01	F3SN-A□□□□P40-01	F3SN-A□□□□P70-01
Detection capability:		min. 14 mm dia., not transparent	min. 25 mm dia., not transparent	min. 40 mm dia., not transparent	min. 70 mm dia., not transparent
Beam gap (P)		9 mm	15 mm	30 mm	60 mm
No. of beams (n)		21 to 125 (only odd numbers)	13 to 120	7 to 60	5 to 30
Protective height (PH)		189 to 1125 mm	217 to 1822 mm	217 to 1807 mm	277 to 1777 mm
		PH = n x P	PH = (n-1) x P + 37		
Operating range		0.2 to 7.0 m	0.2 to 10.0 m		
Response time		ON to OFF: 10 ms to 15.5 ms max., OFF to ON: 40 ms to 62 ms max. (under stable light incident condition). See 1-3-2 for more details.			
Startup waiting time		1 s max.			
Supply voltage (Vs)		24 VDC ±10% (ripple p-p 10% max.)			
Current consumption (under no-load conditions)	Emitter	Up to 50 beams: 140 mA max., 51 to 85 beams: 155 mA max., 86 beams and over: 170 mA max.			
	Receiver	Up to 50 beams: 100 mA max., 51 to 85 beams: 110 mA max., 86 beams and over: 120 mA max.			
Light source		Infrared LED (870 nm wavelength)			
Effective aperture angle (EAA)		Within ±2.5° for the emitter and receiver at a detection distance of at least 3 m according to IEC 61496-2			
OSSD *1		Two PNP transistor outputs, load current 300 mA max., residual voltage 2 V max. (except for voltage drop due to cable extension)			
Auxiliary output (Non-safety output)		One PNP transistor output, load current 50 mA max., residual voltage 2 V max. (except for voltage drop due to cable extension)			
External indicator output (Non-safety output) *2		One PNP transistor output, load current 50 mA max., residual voltage 2 V max. (except for voltage drop due to cable extension)			
Output operation mode *1		OSSD output: Light-ON Auxiliary output: Dark-ON (can be changed by the F39-MC11) External indicator output: Light-ON (can be changed by the F39-MC11) *2			
Input voltage		Test input, Interlock selection input, Reset input, EDM input: ON voltage: 9 to 24 VDC (3 mA max. sink current) OFF voltage: 0 to 1.5 VDC or open			
Indicators	Emitter	Light intensity level indicator (Green LED x5): Lit according to light intensity Error mode indicator (Red LED x3): Flashing to indicate error mode Power indicator (Green LED): Lit when power is supplied Interlock indicator (Yellow LED) Lit during interlock condition Lockout indicator (Red LED): Flashing during lockout condition Test indicator (Orange LED): Lit during external test *3			
	Receiver	Light intensity level indicator (Green LED x5): Lit according to light intensity Error mode indicator (Red LED x3): Flashing to indicate error mode OFF-state indicator (Green LED): Lit when OSSDs are in OFF-state ON-state indicator (Yellow LED): Lit when OSSDs are in ON-state Lockout indicator (Red LED) Flashing during lockout condition Blanking indicator (Orange LED): Lit when blanking is set *3			
Mutual interference prevention function *2		<ul style="list-style-type: none"> • Number of series connected light curtains: Up to three sets • No. of beams: Up to 240 beams • Length of the series connection cable: 3 m max. 			
Test functions		<ul style="list-style-type: none"> • Self-test (After power ON, and during operation) • External test (Light emission stop function by test input) 			
Safety-related functions		<ul style="list-style-type: none"> • Auto reset / manual reset (Interlock function) *4 • EDM (External device monitoring) • Fixed blanking *5 • Floating blanking *5 			

Connection method	M12 connector, 8 pins
Protection mode	Output short-circuit protection, Reverse polarity protection
Ambient temperature	During operation: -10 to 55°C (with no freezing) During storage: -30 to 70°C
Ambient humidity	During operation: 35 to 95% RH (with no condensation) During storage: 35 to 95% RH
Ambient light intensity	Incandescent lamp: 3,000 lx max. (light intensity on the receiver surface) Sunlight: 10,000 lx max. (light intensity on the receiver surface)
Insulation resistance	20 MΩ min. (at 500 VDC)
Dielectric strength voltage	1000 VAC 50/60 Hz 1 minute
Degree of protection	IP65 (IEC60529)
Vibration resistance	Normal operation: 10 to 55 Hz, double amplitude 0.7 mm, X, Y and Z directions 20 sweeps
Shock resistance	Normal operation: 100 m/s ² , X, Y and Z directions 1000 times
Cable (optional) *6	UL20276 (flame-resistant), 8 cores (0.3 mm ² x 4 pairs), external diameter 6.6 mm, with braided wire shield, allowable bending radius: R 36 mm.
Materials	Case: Aluminum, Cap: Zinc die-cast, Optical cover: PMMA (acrylic resin), Cable: Oil-proof PVC
Weight *Packaged	Calculate with the following equation: Weight of light curtain with protective height of 180 mm to 738 mm (g) = (Protective height + 100) x 2 + 1300 Weight of light curtain with protective height of 747 mm to 1402 mm (g) = (Protective height + 100) x 2 + 1700 Weight of light curtain with protective height of 1417 mm to 1822 mm (g) = (Protective height + 100) x 2 + 2100
Accessories	Test rod *7, Instruction manual, Mounting brackets (top and bottom), Mounting brackets (intermediate)*8, Error mode label
Applicable standards	IEC61496-1, EN61496-1 Type 4 ESPE (Electro-Sensitive Protective Equipment) IEC61496-2 Type 4 AOPD (Active Opto-electronic Protective Devices)

- Note**
- 1 Please note that the operation may differ from conventional ON/OFF switching because of the safety circuit.
 - 2 Available for the F3SN-A□□□□P□□-01
 - 3 Flashing after a lapse of 30000 hours as an indicator of preventive maintenance.
 - 4 For the factory setting, the manual reset mode is set to the start/restart interlock.
Using the F39-MC11 can select the start interlock or the restart interlock.
 - 5 For the factory setting, the function is not set. It can be enabled with the F39-MC11.
 - 6 When extending the cable, be sure to use a cable with at least same performance. Do not extend the cable more than the length below. Be sure to route the F3SN-A cable separately from high-potential power lines or through its own duct or conduit.
 - In the case of no series connection: 100 m max.
 - In the case of 2 light curtains connected in series: 80 m max.
 - In the case of 3 light curtains connected in series: 30 m max.
 - 7 Test rod is not supplied with the F3SN-A□□□□P70 / P70-01.
 - 8 The intermediate mounting bracket is supplied with the following types:
Types which have the total length of the light curtain from 640 mm to 1280 mm: 1 set for each of emitter and receiver
Types which have the total length of the light curtain over 1280 mm: 2 sets for each of emitter and receiver

1-3-2 Response Time

The response times of OSSD outputs are as follows:

F3SN-A□□□□P14 series	Protective height (mm)	No. of beams	Response time in ms (ON to OFF):	Response time in ms (OFF to ON):
	180 to 450	20 to 50	10.0	40
	459 to 765	51 to 85	12.5	50
	774 to 1080	86 to 120	15.0	60
	1089 to 1125	121 to 125	15.5	62
F3SN-A□□□□P25 F3SN-A□□□□P25-01	Protective height (mm)	No. of beams	Response time in ms (ON to OFF):	Response time in ms (OFF to ON):
	217 to 772	13 to 50	10.0	40
	787 to 1297	51 to 85	12.5	50
	1312 to 1822	86 to 120	15.0	60
F3SN-A□□□□P40 F3SN-A□□□□P40-01	Protective height (mm)	No. of beams	Response time in ms (ON to OFF):	Response time in ms (OFF to ON):
	217 to 757	7 to 25	10.0	40
	787 to 1297	26 to 43	12.5	50
	1327 to 1807	44 to 60	15.0	60
F3SN-A□□□□P70 F3SN-A□□□□P70-01	Protective height (mm)	No. of beams	Response time in ms (ON to OFF):	Response time in ms (OFF to ON):
	277 to 757	5 to 13	10.0	40
	817 to 1297	14 to 22	12.5	50
	1357 to 1777	23 to 30	15.0	60

■ **The response time for series-connected types is calculated as follows:**

For 2 sets:

Response time (ON to OFF): Response time of Light curtain 1 + Response time of Light curtain 2 + 3 ms

Response time (OFF to ON): Response time of Light curtain 1 + Response time of Light curtain 2 + 12 ms

For 3 sets:

Response time (ON to OFF): Response time of Light curtain 1 + Response time of Light curtain 2 + Response time of Light curtain 3 + 4 ms

Response time (OFF to ON): Response time of Light curtain 1 + Response time of Light curtain 2 + Response time of Light curtain 3 + 16 ms

■ **The response time of F3SP-B1P is 10 ms, operation time is 100 ms.**

Note If the F3SP-B1P controller is included in the safety circuit, calculate the safety distance by adding the controller response time to the F3SN response time.

CHAPTER 2

Mounting and Adjustment Procedures

2-1	Installation Conditions	16
2-1-1	Detection Zone and Intrusion Path	16
2-1-2	Safety Distance	17
2-1-3	Distances from Reflective Surfaces	19
2-1-4	How to Prevent Mutual Interference	20
2-2	Dimensional Drawings	22
2-3	Mounting	27
2-3-1	How to Mount the Unit	27
2-3-2	Dimensional Drawing of the Mounting Bracket	28
2-4	Wiring	32
2-4-1	Power Supply Units	32
2-4-2	Wiring Diagram	34
2-4-3	Wiring Procedures	36
2-4-4	Adjustment Procedures	38
2-5	Check List	38

2-1 Installation Conditions

2-1-1 Detection Zone and Intrusion Path

⚠ WARNING Do not use the F3SN-A on machines that cannot be stopped by electrical control in case of an emergency, such as a pressing machine with full-rotation clutch system. Serious injury may result if the machine does not stop before someone reaches the hazardous part.

Proper configuration of the control circuit is required between the F3SN-A and the machine which is used in PSDI “presence sensing device initiator” mode. Refer to OSHA1910.217, IEC61496-1, and other related standards and regulations for more detail on PSDI.

Install protective structures around the machine so that you must pass through the detection zone of the F3SN-A to reach a hazardous part of the machine. Install the F3SN-A in such a way that when working on hazardous parts of the machine, some parts of the operator's body remain in the detection zone.

The switch to reset the interlock condition must be installed so that the entire hazardous area is visible and free of personnel, also the switch must not be able to be operated from within the hazardous area.

Do not use the F3SN-A in flammable or explosive environments. Failure to do this may cause an explosion.

The F3SN-A does not offer protection to the operator's body from projectiles exiting the hazardous area. Proper means of mechanical guarding must be provided to ensure protection from these potentially hazardous projectiles.

Be sure to securely fasten the F3SN-A to the machine and tighten the cable connector.

Correct Installation

Hazardous parts of the machine can only be reached by crossing the detection zone.

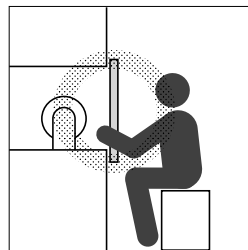

Some parts of the operator's body remains in the detection zone while they are working.

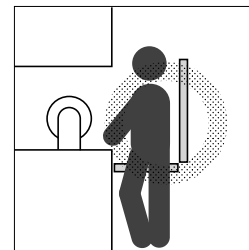

Incorrect Installation

Hazardous parts of a machine can be reached without passing through the light curtain detection zone.

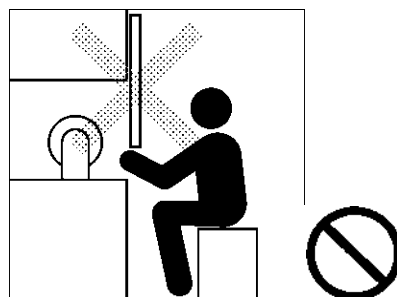

A worker is between the sensor detection zone and a hazardous part of a machine.

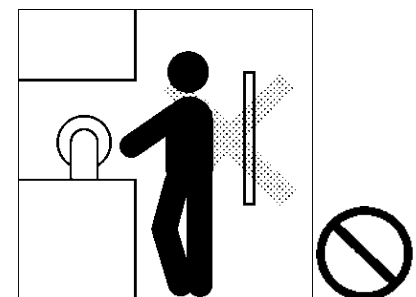

2-1-2 Safety Distance

⚠ WARNING Always maintain a safe distance (S) between the F3SN-A and a hazardous part of a machine. Serious injury may result if the machine does not stop before someone reaches the hazardous part.

The "Safety distance" is the minimum distance that must be maintained between the F3SN-A and a hazardous part of a machine in order to stop the machine before someone or something reaches it. The safety distance is calculated based on the following equation when a person moves perpendicular to the detection zone of a light curtain.

Safety distance (S) =
 Intrusion speed into the detection zone (K) x Total response time for the machine and light curtain (T) + Additional distance calculated based on the detection capability of the light curtain (C) ... (1)

The safety distance varies with national standards and individual machine standards. Be sure to refer to related standards.

The equation is also different if the direction of intrusion is not perpendicular to the detection zone of the light curtain.

■ **<Reference> Method for calculating safety distance as provided by European Standard EN999 (for intrusion perpendicular to the detection zone)**

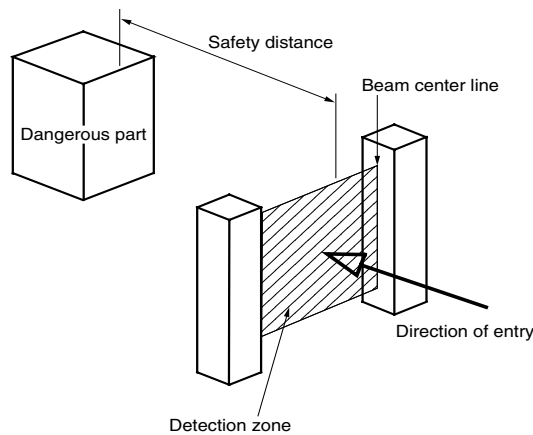

**[Detection capability]
 40mm or less]**

Substitute K = 2000 mm/s and C = 8 (d - 14 mm) in equation (1) and calculate as shown below.

$$S = 2000 \text{ mm/s} \times (T_m + T_s) + 8 (d - 14 \text{ mm}) \dots\dots(2)$$

- Where: S = Safety distance (mm)
- T_m = Machine response time (s) *1
- T_s = Light curtain response time (s) *2
- d = Detection capability of the light curtain (mm)

e.g.:

$$T_m = 0.05s, T_s = 0.01s, d = 14 \text{ mm}$$

$$S = 2000 \text{ mm/s} \times (0.05s + 0.01s) + 8 (14 \text{ mm} - 14 \text{ mm})$$

$$= 120 \text{ mm}$$

Use S = 100 mm if the result of equation (2) is less than 100 mm.

Recalculate using the following equation with K = 1600 mm/s if the result is over 500 mm.

$$S = 1600 \text{ mm/s} \times (T_m + T_s) + 8 (d - 14 \text{ mm}) \dots\dots(3)$$

Use S = 500 mm if the result of equation (3) is less than 500 mm.

[Detection capability: over 40mm]

Substitute $K = 1600 \text{ mm/s}$ and $C = 850 \text{ mm}$ in equation (1) and calculate as shown below.

$$S = 1600 \text{ mm/s} \times (T_m + T_s) + 850 \dots(4)$$

Where: S = Safety distance (mm)

T_m = Machine response time (s) *1

T_s = Light curtain response time (s) *2

e.g.:

$$T_m = 0.05\text{s}, T_s = 0.01\text{s}:$$

$$S = 1600 \text{ mm/s} \times (0.05\text{s} + 0.01\text{s}) + 850\text{mm} \\ = 946 \text{ mm}$$

1. The machine response time refers to the maximum time from the moment the machine receives a stop signal to the moment the hazardous part of the machine stops. The machine response time should be measured on the existing machine. The machine response time should be measured and confirmed periodically.
2. The light curtain response time refers to the time required for output to change from ON to OFF.

■ <Reference> Method for calculating the safety distance as provided by ANSI B11.19 (US)

Safety distance (S)=

$$\text{Intrusion speed into the detection zone (K)} \times \text{Response time} \\ (T_s + T_c + T_r + T_{bm}) + \text{Additional distance (Dpf)} \dots(5)$$

Where: K = Intrusion speed (the recommended value in OSHA standards is 1600 mm/s)

ANSI B11.19 does not define an intrusion speed (K). You should take into account all possible factors when determining K , including the physical characteristics of the operator.

T_s = Time required for the machine to stop (s)

T_r = F3SN-A response time (s) *1

T_c = Maximum response time required for the machine control system to apply the brakes

T_{bm} = Additional time (s)

If the machine is provided with a brake monitor, T_{bm} = brake monitor setting time - ($T_s + T_c$). If not provided with a brake monitor, it is recommended to determine a value more than 20% of ($T_s + T_c$) as the additional time.

D_{pf} = Additional distance. D_{pf} is calculated as follows based on ANSI standards.

$$D_{pf} = 3.4 \times (d - 7.0): d \text{ is the detection capability of the light curtain (mm).}$$

Example:

Where: $K = 1600 \text{ mm/s}$, $T_s + T_c = 0.06 \text{ s}$,
Brake monitor setting time = 0.1s , $T_r = 0.1\text{s}$, $d = 14 \text{ mm}$,

From equation (5):

$$T_{bm} = 0.1 - 0.06 = 0.04\text{s}$$

$$D_{pf} = 3.4 \times (14 - 7.0) = 23.8\text{mm}$$

$$S = 1600 \times (0.06 + 0.1 - 0.04) + 23.8 = 215.8\text{mm}$$

1. The light curtain response time refers to the time required for output to change from ON to OFF.

2-1-3 Distances from Reflective Surfaces

⚠ WARNING Be sure to install the F3SN-A to minimize the effects of reflection from nearby surfaces. Serious injuries can result if these effects are not taken into consideration.

Install the F3SN-A with minimum Distance D shown below from reflective surfaces (highly reflective surfaces) such as metal walls, floors, ceilings, and work pieces.

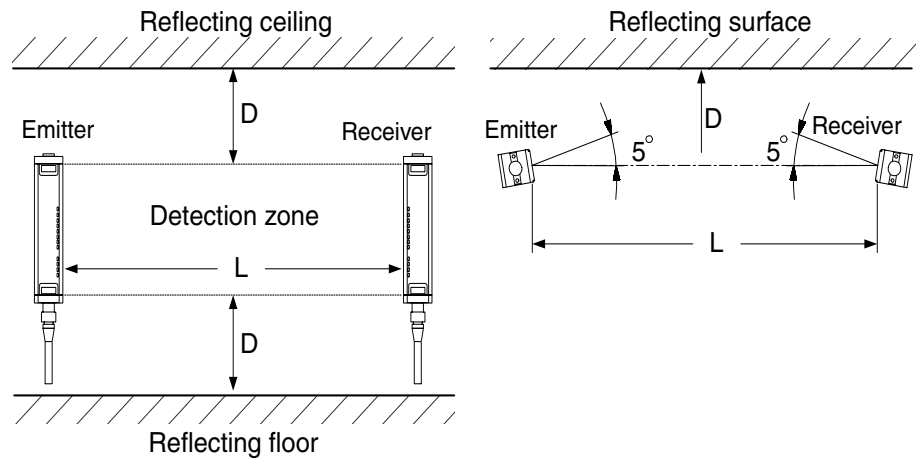

Distance between emitter and receiver (Operating range L)	Minimum permitted installation distance D
0.2 to 3 m	0.13 m
over 3 m	$L/2 \times \tan 5^\circ = L \times 0.044$ (m)

Note The effective aperture angle of the F3SN-A is $\pm 2.5^\circ$ (when $L > 3\text{m}$), as defined in IEC61496-2. However, you should assume that the effective aperture angle is $\pm 3^\circ$ and install the F3SN-A at a distance from the reflective surfaces. You must take into account the difference in the beams during the installation.

2-1-4 How to Prevent Mutual Interference

⚠ WARNING The set type of the emitter and receiver must be the same.

Do not use the F3SN-A in a reflective configuration, otherwise detection may fail. When using multiple sets of F3SN-A, use light interruption panels to prevent mutual interference.

1. Series connection (up to 3 sets, 240 beams, series-connection type)

Multiple sets of the F3SN-A can be connected in series.

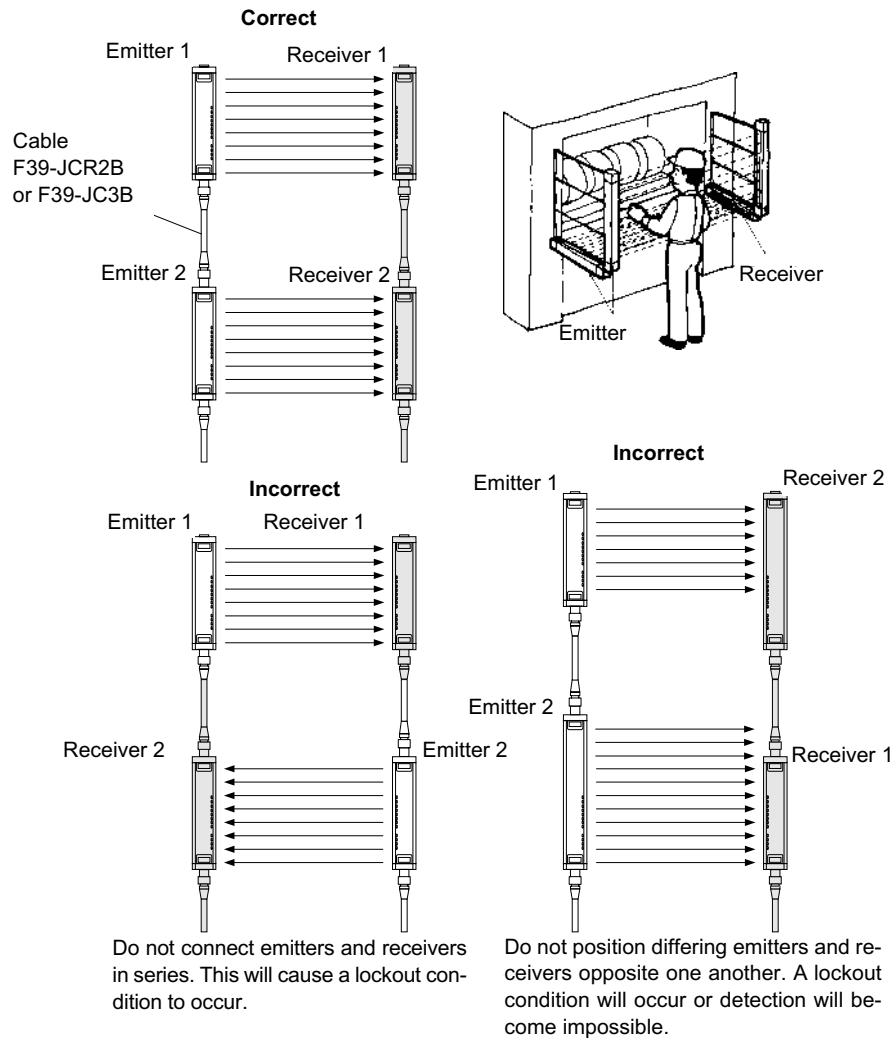

2. Not connected in series

When installing two or more light curtains without connecting them to each other, safety measures must be taken to prevent mutual interference. Failure to do so may cause the F3SN-A to go into a lockout condition.

- Installations which may cause mutual interference

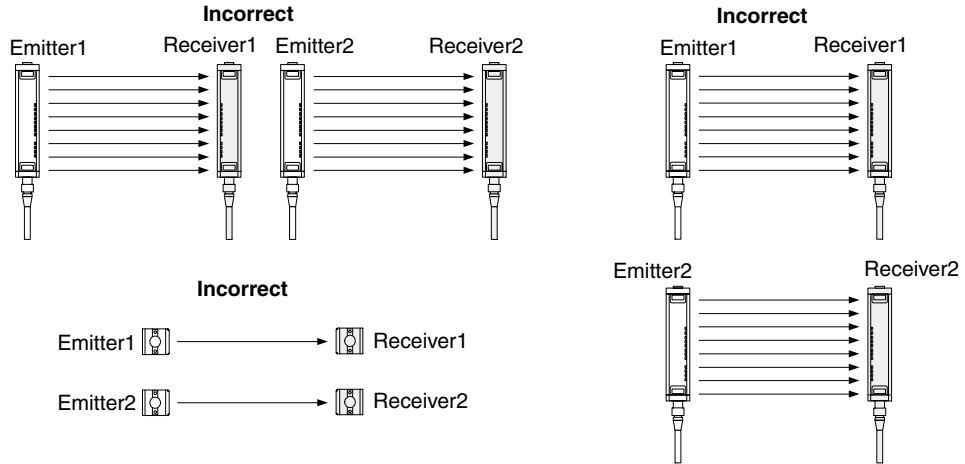

- Installation to prevent mutual interference
Install the two light curtains so that they emit in the opposite directions (staggered).

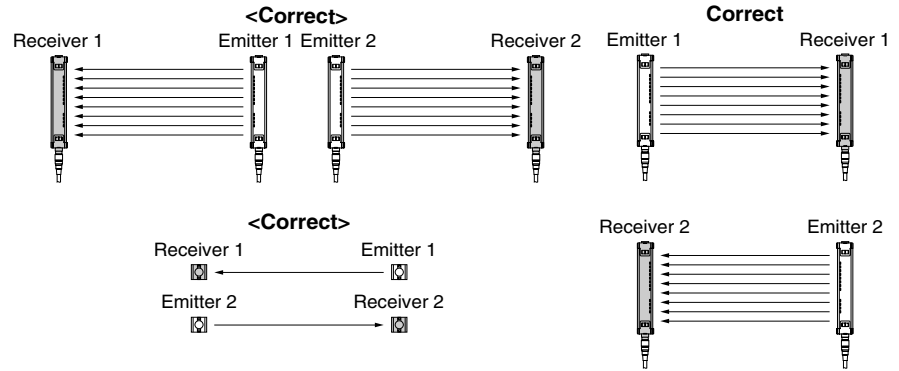

- Install a light interrupting wall in between the sensors

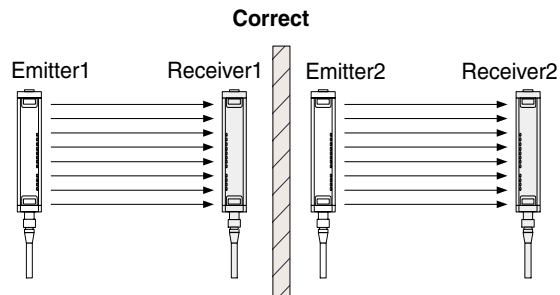

Install the light curtains so that they are an installation distance apart to minimize mutual interference.

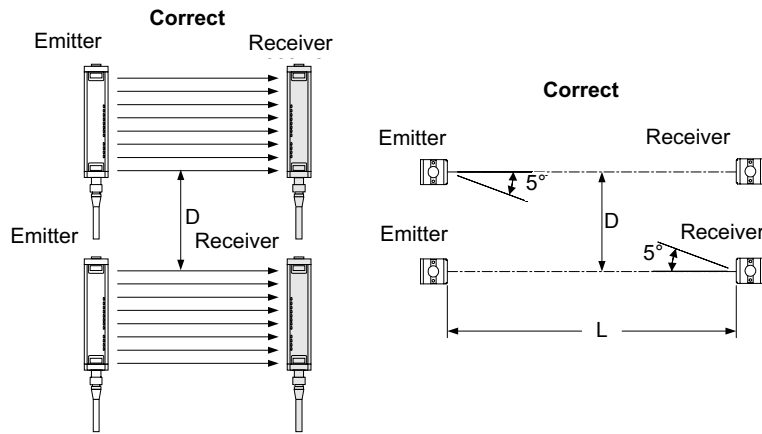

Distance between emitter and receiver (Operating range L)	Minimum permitted installation distance D
0.2 to 3 m	0.26 m
over 3 m	$L \times \tan 5^\circ =$ $L \times 0.088$ (m)

2-2 Dimensional Drawings

Dimensions according to the type can be calculated by using the following equations.

F3SN-A□□□□P14 series

Dimension C2 (Protective height) 4 digits in the type name

$$\text{Dimension A} = C2 + 86$$

$$\text{Dimension B} = C2 + 54$$

$$\text{Dimension D} = 15.5$$

$$\text{Dimension E} = C2 - 9$$

Dimension F: See the table shown below.

Protective height (C2)	Number of intermediate mounting brackets	Dimension F (*1)
Up to 0620	0	—
0621 ... 1125	1	$F = B / 2$

Other series

Dimension C1 (Protective height) : 4 digits in the type name

$$\text{Dimension A} = C1 + 64$$

$$\text{Dimension B} = C1 + 32$$

$$\text{Dimension D} = 18.5$$

$$\text{Dimension E} = C1 - 37$$

Dimension F: See the table shown below.

Protective height (C1)	Number of intermediate mounting brackets	Dimension F (see the note)
up to 0640	0	—
0641 to 1280	1	$F = B / 2$
1281 to 1822	2	$F = B / 3$

Note If value F obtained from the above equation is not used, set F to 670 mm or less.

Side Mounting (e.g.: Emitter)

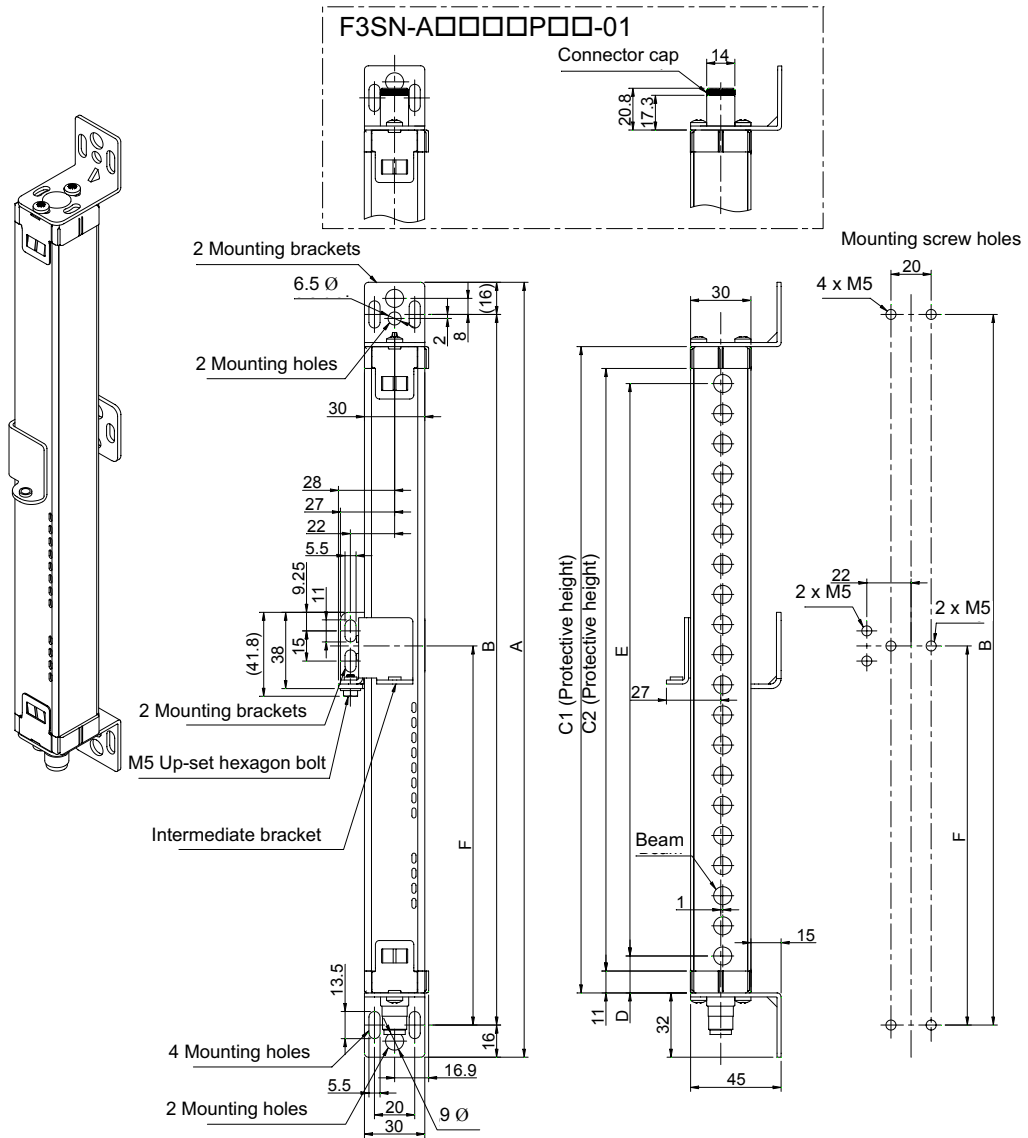

The following figures show only dimensions which are different from those of the F3SN-A□□□□P□□

• F3SN-A□□□□P□□-01

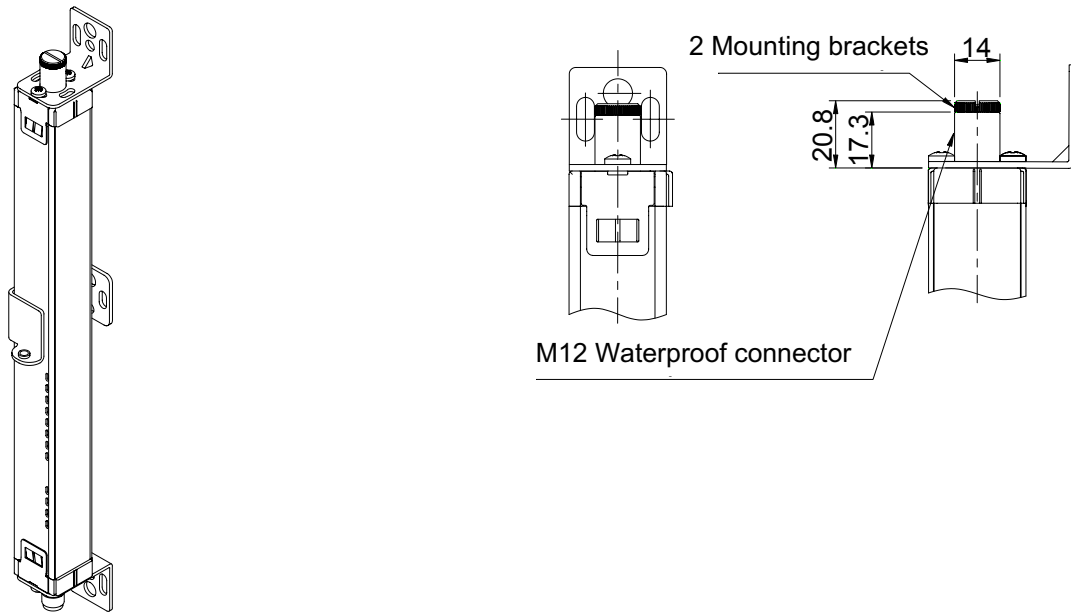

• F3SN-A□□□□P□□-02

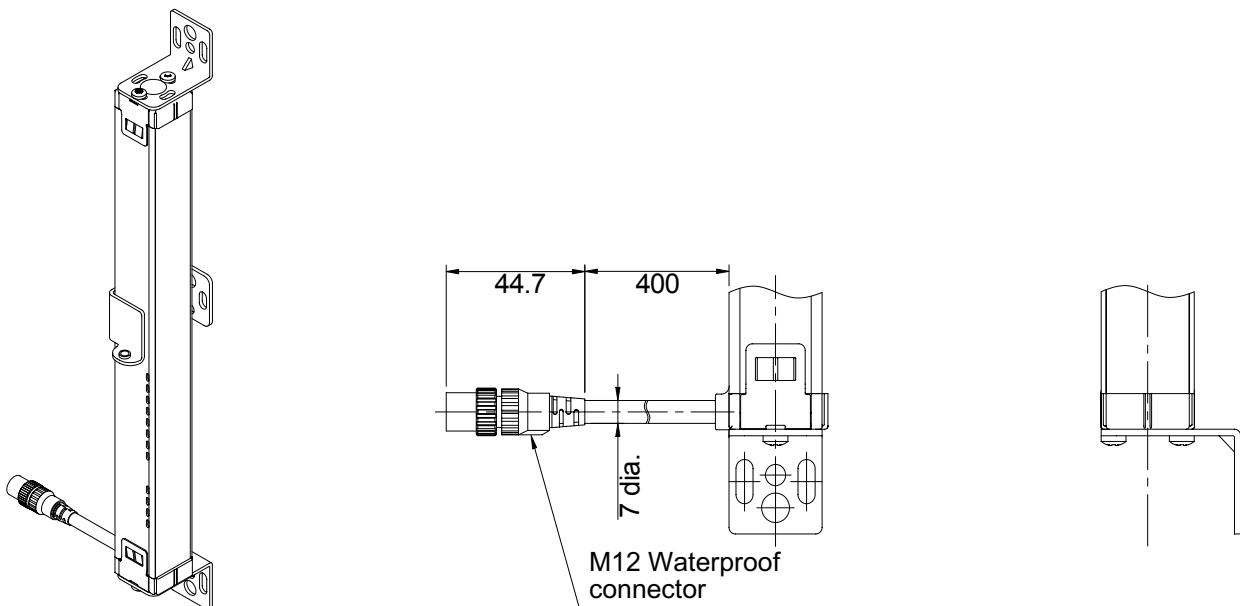

Rear Mounting (e.g.: Emitter)

• F3SN-A□□□□P□□

Dimensions according to the type can be calculated by using the following equations.

F3SN-A□□□□P□□P14 series

Dimension C2 (Protective height): 4 digits in the type name

Dimension A = C2 + 86

Dimension B = C2 + 54

Dimension D = 15.5

Dimension E = C2 - 9

Dimension F: See the right table.

Other series

Dimension C1 (Protective height) : 4 digits in the type name

Dimension A = C1 + 64

Dimension B = C1 + 32

Dimension D = 18.5

Dimension E = C1 - 37

Dimension F: See the right table.

*1. If value F obtained from the above equation is not used, set F to 670 mm or less.

Protective height (C2)	Number of intermediate mounting bracket	Dimension F (*1)
to 0620	0	-
0621 to 1125	1	F = B / 2

Protective height (C1)	Number of intermediate mounting bracket	Dimension F (*1)
to 0640	0	-
0641 to 1280	1	F = B / 2
1281 to 1822	2	F = B / 3

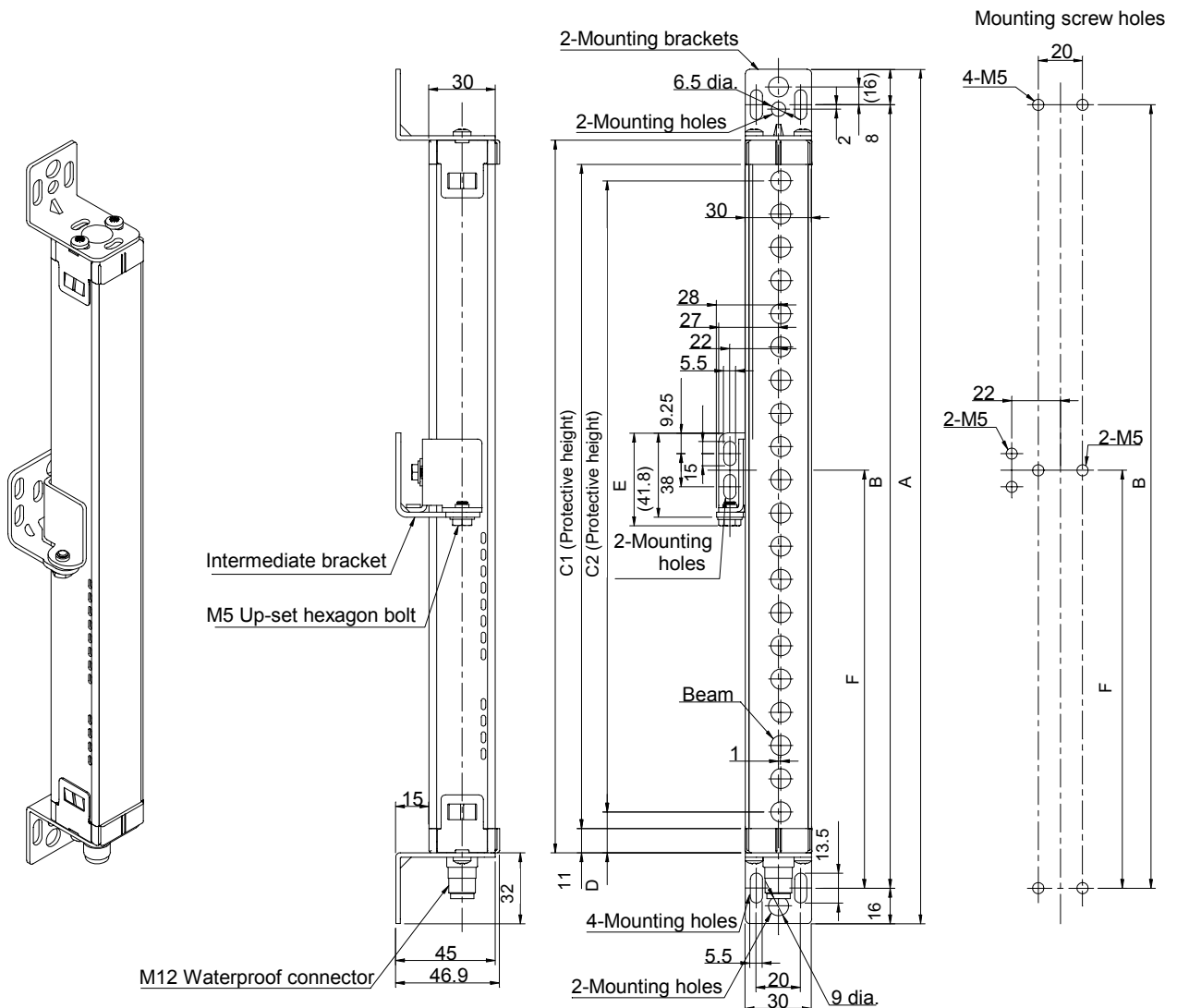

The following figures show only dimensions which are different from those of the F3SN-A□□□□□P□□

• F3SN-A□□□□□P□□-01

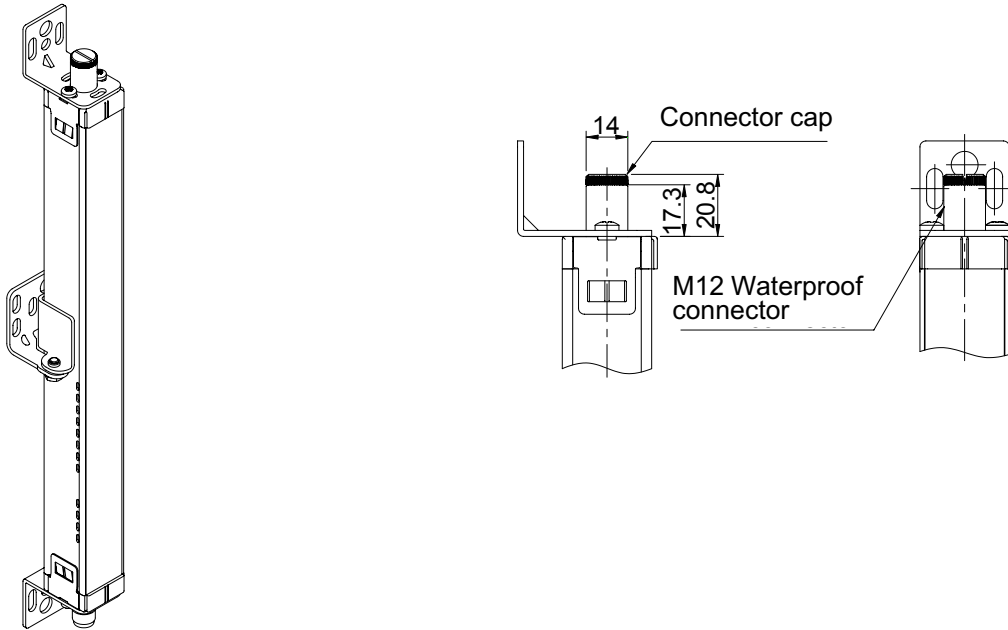

• F3SN-A□□□□□P□□-02

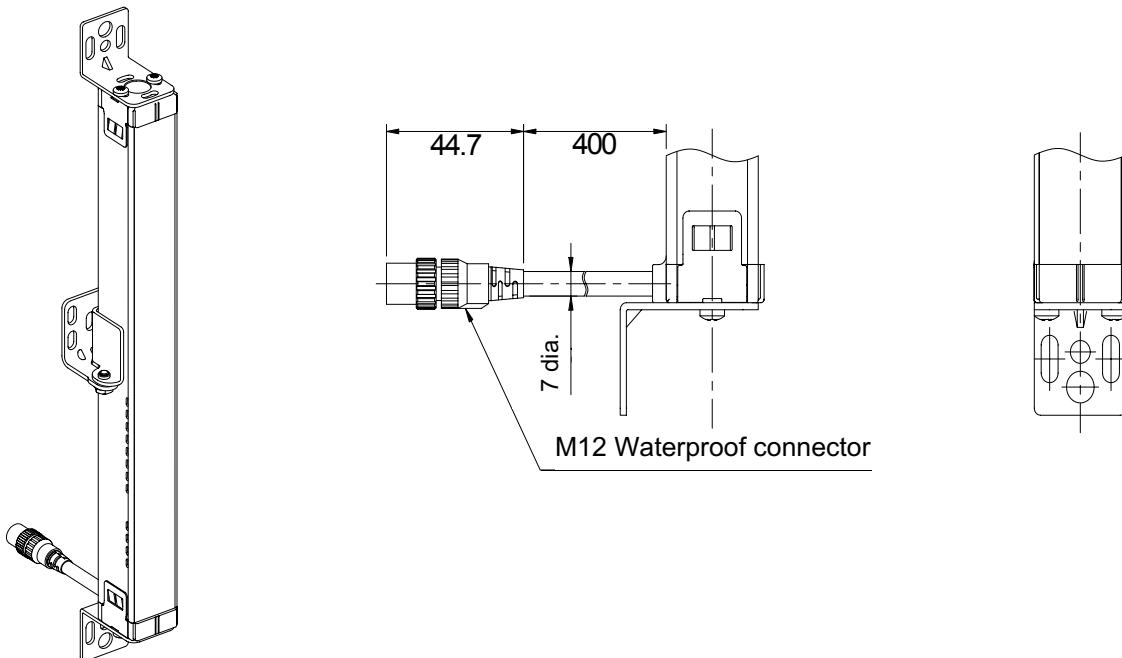

2-3 Mounting

2-3-1 How to Mount the Unit

- **Be sure to have a bend radius of the F3SN-A cable of R=36 (mm) or more. Otherwise eventual failure of the cable may result.**

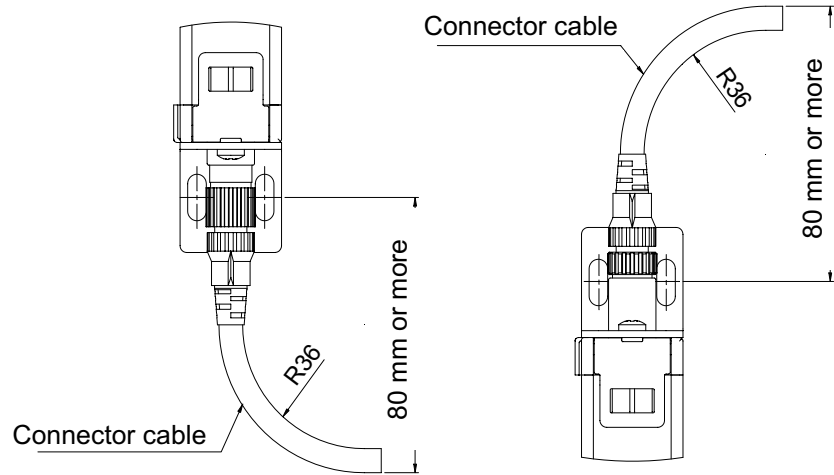

- **In the following figure the mounting brackets for the emitter and receiver are attached.**

Also shown is how to assemble the intermediate mounting bracket and positions where screw holes can be drilled to mount the brackets.

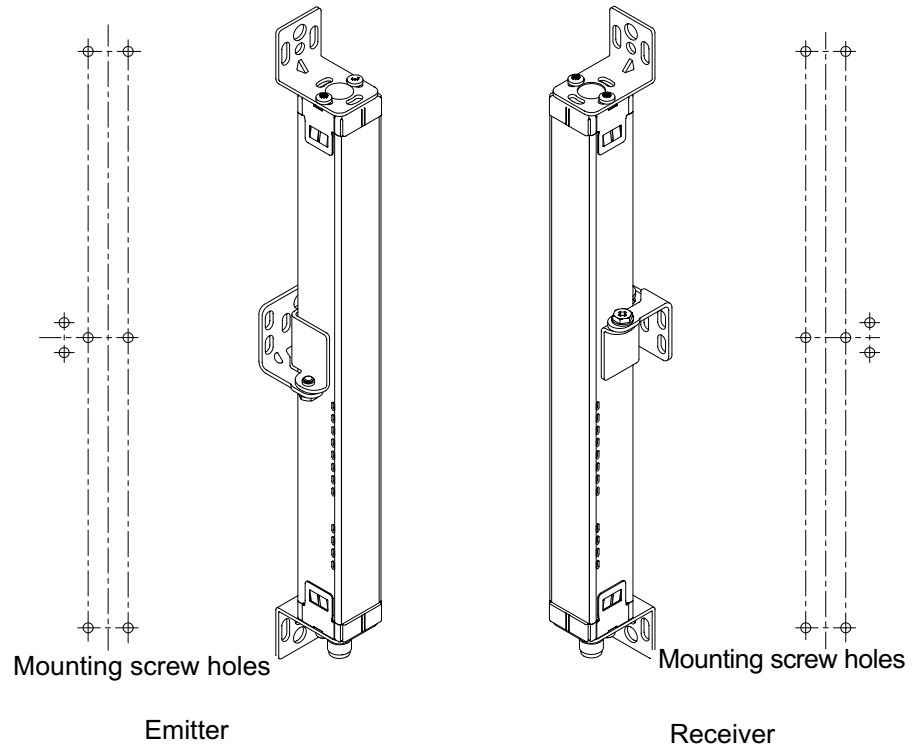

2-3-2 Dimensional Drawing of the Mounting Bracket

■ **Mounting bracket (top and bottom)**

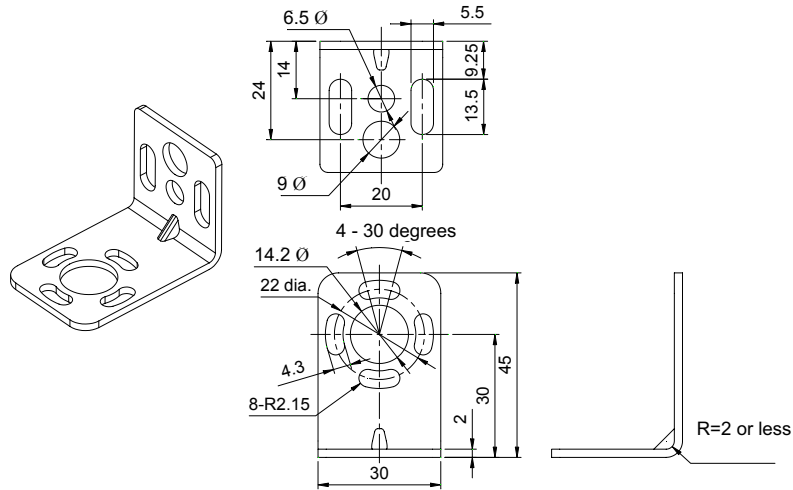

Material: Carbon steel

■ **Mounting bracket (intermediate)**

Configuration for rear mounting

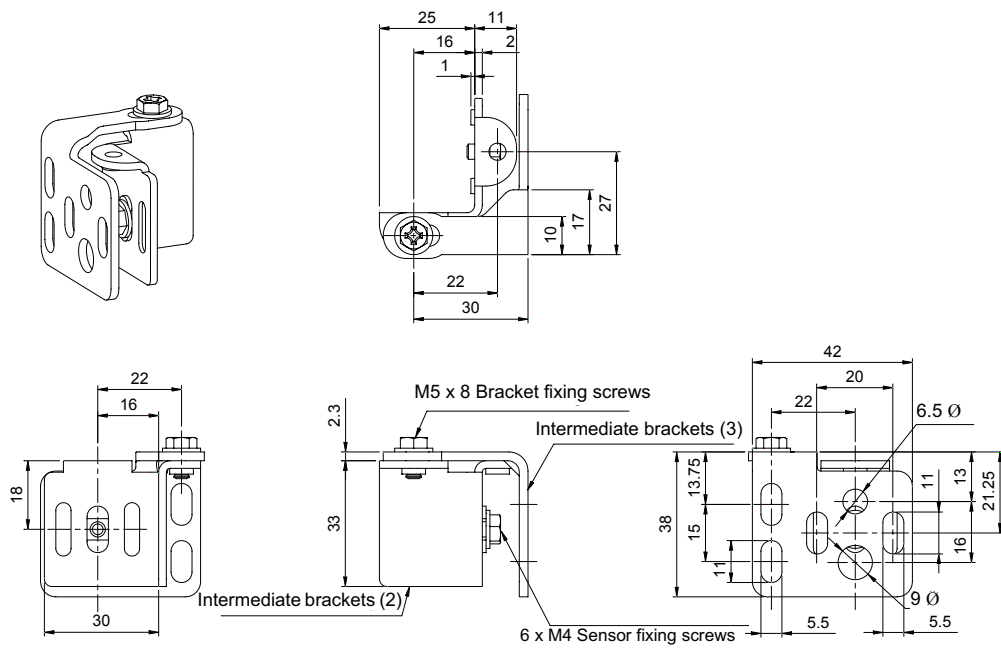

Material: Carbon steel

Configuration for rear mounting

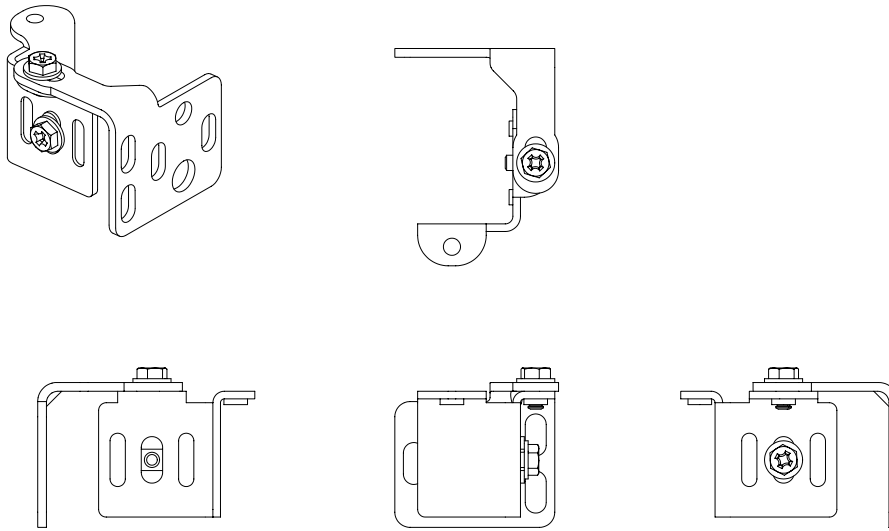

Setup procedure when the supplied mounting brackets are used

1. Secure the bottom bracket (power connector side) on a wall or column.

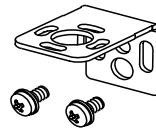

2. Secure the intermediate bracket (3) on a wall or column.

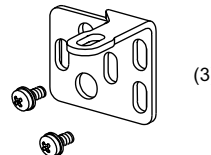

Note The intermediate bracket (3) of the receiver is mounted upside down compared with that of the emitter.

3. Align the intermediate bracket (2) with the protrusion of intermediate bracket (1) located on the rear side of the light curtain, and tighten the supplied screw (M4x6) slightly.

(2)

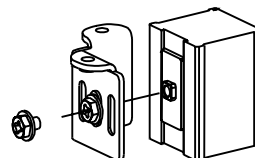

Note Mount the intermediate bracket (2) so that its direction (upwards or downwards) is the same as that of the intermediate bracket (3).

4. Insert the cable connector of the light curtain into the bottom bracket.

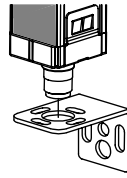

5. Move the intermediate bracket (2) until its height is aligned with that of the intermediate bracket (3)(5-a), securely tighten the screw (M4x6)(5-b).

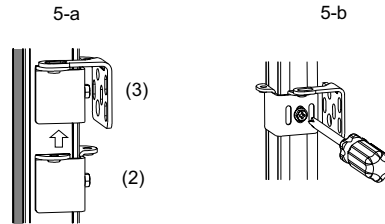

Note Be sure to perform this step prior to mounting the top bracket (cap side).

6. After having aligned the intermediate bracket (2) with the intermediate bracket (3) in the direction of mounting the light curtain, tighten the supplied screw (M5x8) slightly. Intermediate brackets (2) and (3) are assembled in the following three ways: 6-a, 6-b, 6-c.

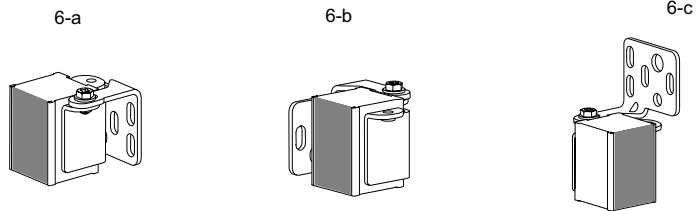

7. Align the top bracket (cap side) with the round hole on the cap, and secure it on a wall or column.

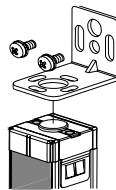

8. Insert two supplied screws (M4x8) into both top and bottom brackets, and tighten them slightly (8-a, 8-b). (The figure shown below describes the side mounting.)

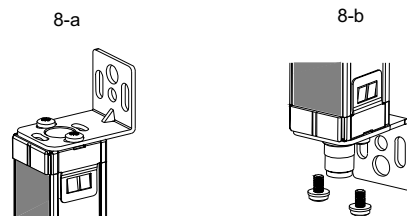

- Adjust the torsion angle of the light curtain in the point where the five light receiving level indicators are lit.

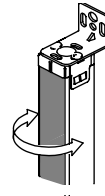

- Securely tighten the bottom and top brackets.

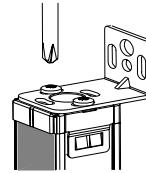

- Then, securely tighten the intermediate brackets.

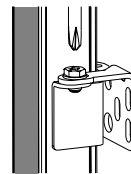

The procedure to mount the light curtain is now complete.

[Rear mounting]

[Side mounting]

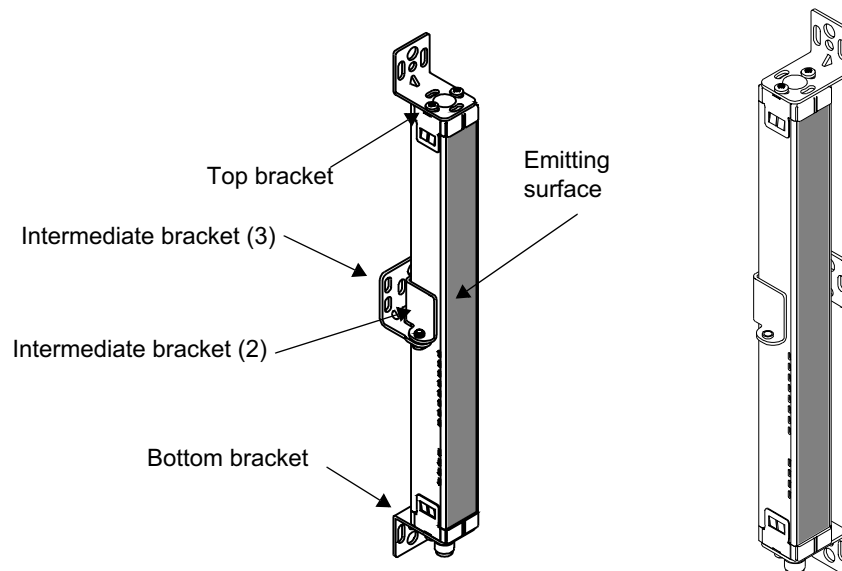

2-4 Wiring

⚠ WARNING Do not short-circuit the outputs to the +24V. Doing so will cause the output to be always ON, creating a hazardous situation. Connect the 0V line of the power supply directly to protective earth to prevent the earth fault. Otherwise the earth fault causes the outputs to be ON. (Chapter 2-4)

Connect loads between the output and 0V line. (PNP output)

Connecting loads between the output and +24V line will reverse the operation mode and the machine will be ON when it is light-interrupted.

Always use the two OSSD outputs to configure the safety system.

Using only one OSSD of the safety system may result in serious injury when there is an output circuit failure.

Do not connect any of the F3SN-A lines to a DC power supply with more than 24VDC+10% or to an AC power supply to avoid the danger of electric shock.

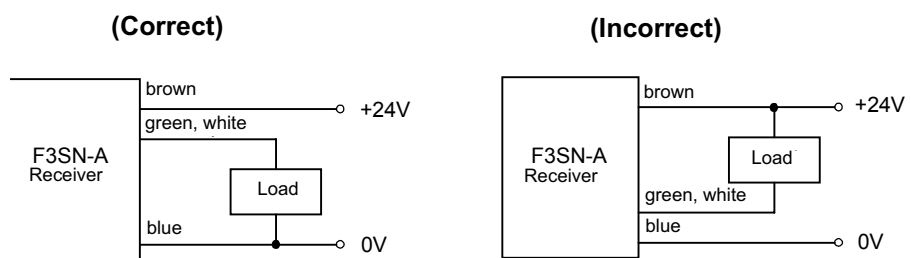

2-4-1 Power Supply Units

DC power supply units must satisfy all of the following conditions so that the F3SN-A can comply with the applicable standards IEC 61496-1, and UL 508.

- The power supply voltage must be within specified ratings (24 VDC \pm 10 %).
- The power supply is connected only to the F3SN-A and to the devices related to the electro-sensitive protective function of the F3SN-A, such as a safety controller and muting sensors, and it has enough rated current for all the devices. The power supply must not be connected to other devices or machines.
- The power supply uses double or reinforced insulation between the primary and secondary circuits.
- The power supply automatically resets overcurrent protection characteristics (voltage drop).
- The power supply maintains an output holding time of at least 20 ms.
- FG (frame ground terminal) must be connected to PE (protective earth) when using a commercially available switching regulator.
- The power supply must have output characteristics of Class 2 Circuit of Limited Voltage-Current Circuit as defined in UL508 (see the "Note").
- The power supply must conform to regulatory requirements and standards, regarding EMC and electrical equipment safety, of the country where the F3SN-A is installed and where machinery will be operated. Example: The EMC Directive (industrial environment) and the Low Voltage Directive in the EU.

Note The power supply must conform to the following requirement (1) or (2) regarding a secondary circuit, in accordance with UL 508, to avoid a fire.

1. The power supply includes a limited voltage/current circuit supplied by an isolating source like the secondary winding of an isolating type transformer. And, in the limited voltage/current circuit,
 - the current available is limited to a value not exceeding 8 A (including the case of short-circuit), or
 - a secondary fuse or other such secondary circuit protective device used to limit the available current shall be rated at not more than a value 4.2 amperes (for the power supply voltage of 24VDC)

Recommended power supply:

S82K (15 W, 30 W, 50 W or 90 W type) made by OMRON.

Certificate of UL Listing (UL508, Class2 Output) and CE Marked (EMC and Low Voltage Directives).

2. The power supply includes a Class 2 circuit supplied by an isolating source that complies with the requirement in the standard for Class 2 Power Units, UL 1310, or the requirements in the standard for Class 2 and Class 3 Transformers, UL 1585.

2-4-2 Wiring Diagram

■ Light curtain only

Wiring for the Manual Reset Mode and the EDM Function

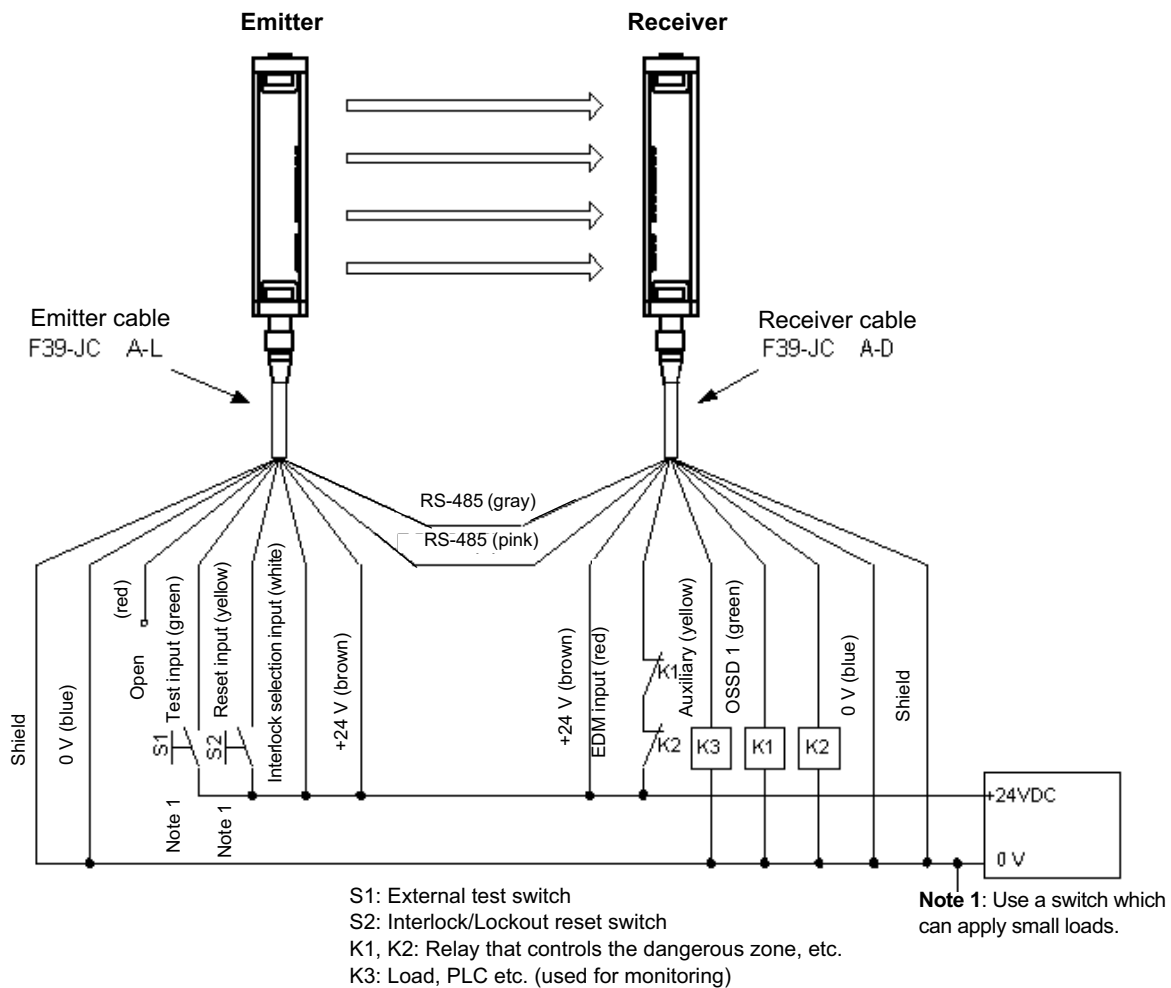

Wiring for the Auto Reset Mode

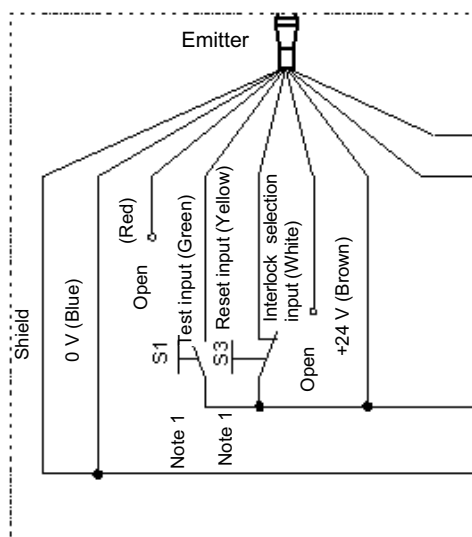

S3: Lockout reset switch
 (If the switch is not necessary, connect between the reset input and +24VDC.)

Wiring when the EDM is not used

When the EDM is not necessary

- 1) Use the F39-MC11 to disable the EDM or
- 2) If the auxiliary output is in the "Dark-ON output mode", wire the lines as shown in the figure below to disable the EDM.

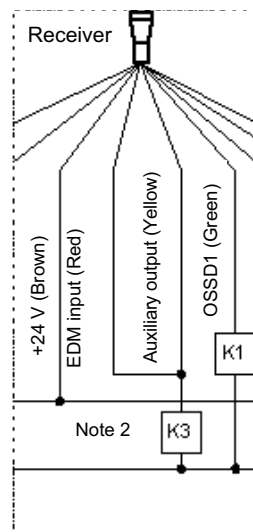

Note 2: If the K3 is not necessary, only connect the auxiliary output to the EDM input.

■ Combination with the F3SP-B1P

Wiring for the Manual reset mode and the EDM function

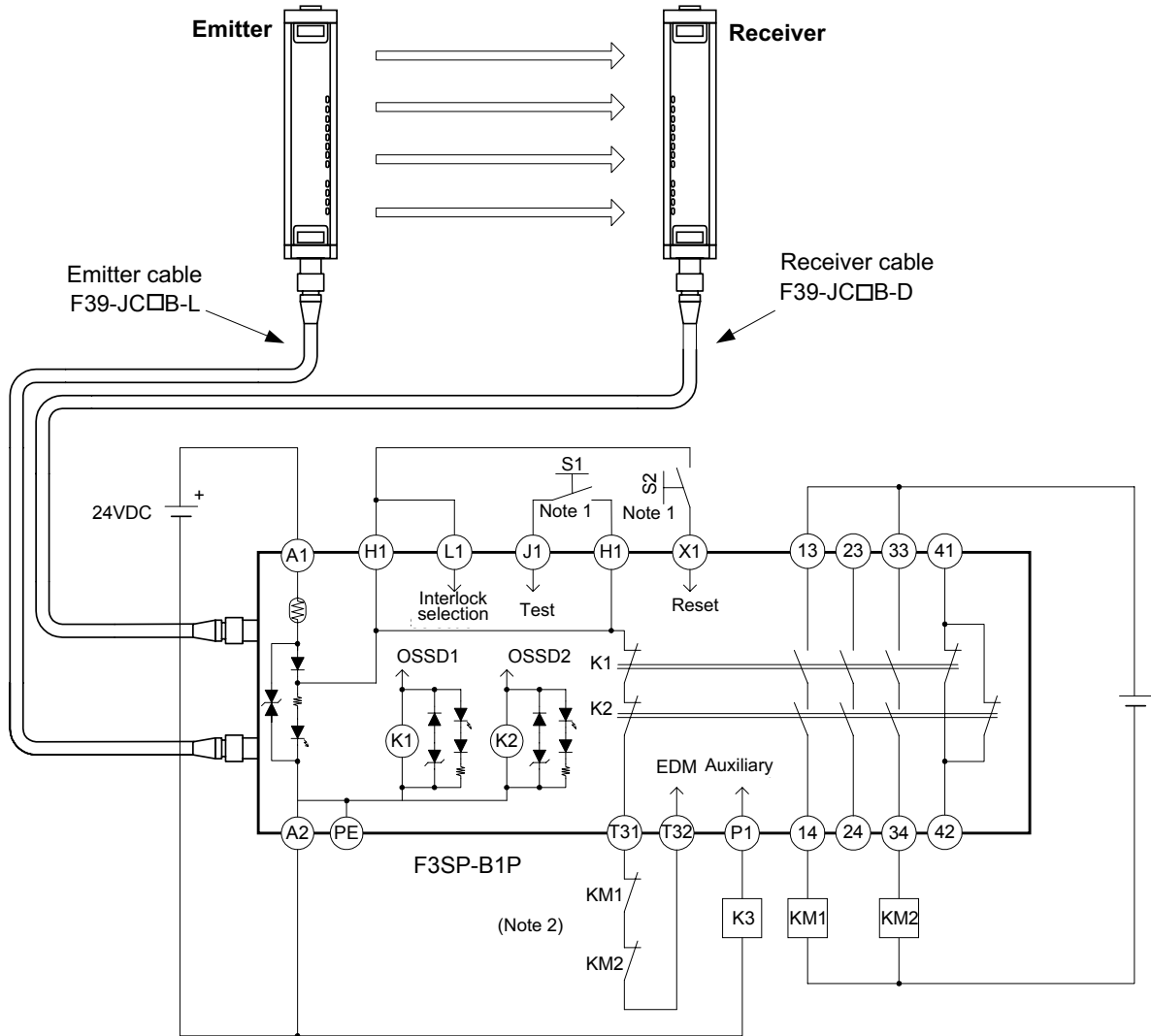

- S1: External test switch
- S2: Lockout reset switch
- K1, K2: Relay that controls the dangerous zone etc.
- K3: Load, PLC etc. (used for monitoring)

Wiring for the Auto reset mode

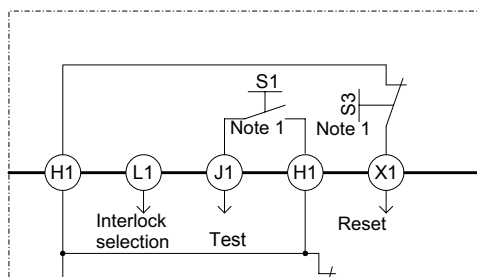

S3: Lockout reset switch
 (If the switch is not necessary, connect between X1 and H1.)

- Note 1:** Use a switch which can apply small loads.
- Note 2:** If the EDM is not necessary, short-circuit T31 and T32.

2-4-3 Wiring Procedures

1. Connect the emitter cable (F39-JC□□-L optional, gray color outer jacket) to the emitter.
2. Connect the receiver cable (F39-JC□□-D optional, black color outer jacket) to the receiver.
3. Connect the 0V line of the power supply directly to protective earth (PE).

Note Be sure to wire correctly. Failure to do so may damage the F3SN-A. Confirm the color of cables and outer jackets (emitter: gray, receiver: black). Matching colors prevents incorrect wiring.

■ **Connector (Main Unit End)**

Front View	Pin No.	Signal Name		Wire Color
		Receiver	Emitter	
	1	OSSD 2	Interlock selection input (INTERLOCK)	White
	2	+24 VDC	+24 VDC	Brown
	3	OSSD 1	Test input	Green
	4	Auxiliary output	Reset input (RESET)	Yellow
	5	RS-485 (A)	RS-485 (A)	Gray
	6	RS-485 (B)	RS-485 (B)	Pink
	7	0 V	0 V	Blue
	8	EDM input	N.C.	Red

■ **Single-ended connector cable (F39-JC□□A Optional)**

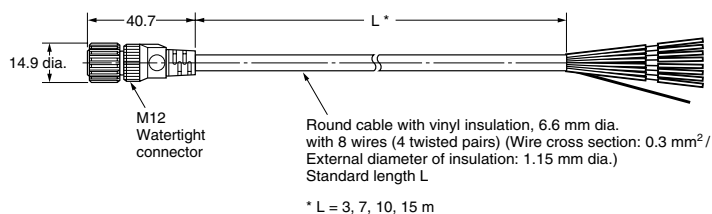

Unit: mm

Type (set name)	For Emitter		For Receiver		L
F39-JC3A	F39-JC3A-L	Gray outer jacket color	F39-JC3A-D	Black outer jacket color	3000
F39-JC7A	F39-JC7A-L		F39-JC7A-D		7000
F39-JC10A	F39-JC10A-L		F39-JC10A-D		10000
F39-JC15A	F39-JC15A-L		F39-JC15A-D		15000

■ **Double-ended connector cable for Series Connection and Connection to the F3SP-B1P (F39-JC□B, Optional)**

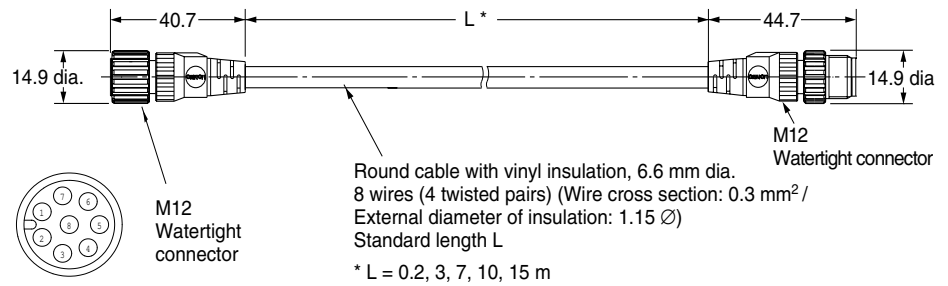

Unit: mm

Type (set name)	For Emitter		For Receiver		L	
F39-JCR2B	F39-JCR2B-L	Gray outer jacket color	F39-JCR2B-D	Black outer jacket color	200	Note:
F39-JC3B	F39-JC3B-L		F39-JC3B-D		3000	Note:
F39-JC7B	F39-JC7B-L		F39-JC7B-D		7000	Note:
F39-JC10B	F39-JC10B-L		F39-JC10B-D		10000	Note:
F39-JC15B	F39-JC15B-L		F39-JC15B-D		15000	Note:

Note Cannot use for series connection.

• **Double-ended connector cable for Series Connection and Connection to the F3SP-B1P (F39-JC□C Optional)**

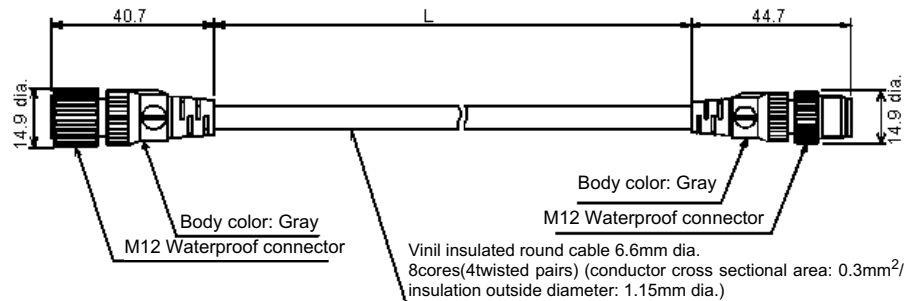

Unit: mm

Type (set name)	For Emitter		For Receiver		L	
F39-JCR2C	F39-JCR2C-L	Gray outer jacket color	F39-JCR2C-D	Black outer jacket color	200	Note
F39-JC1C	F39-JC1C-L		F39-JC1C-D		1000	Note
F39-JC3C	F39-JC3C-L		F39-JC3C-D		3000	Note
F39-JC7C	F39-JC7C-L		F39-JC7C-D		7000	Note
F39-JC10C	F39-JC10C-L		F39-JC10C-D		10000	Note
F39-JC15C	F39-JC15C-L		F39-JC15C-D		15000	Note

[Note]: Do not use for series connection.

2-4-4 Adjustment Procedures

[Procedures]

1. Preparation
 - The optical surfaces of the emitter and receiver must be clean.
 - There should be no light-interrupting objects in the F3SN-A detection zone.
2. Adjust the beams of the emitter.
Adjust the torsion angle of the emitter while monitoring the light intensity level indicators and locate the emitter in the point where the light intensity level indicators are lit.
3. Adjust the receiver.
Adjust the torsion angle of the receiver while monitoring the light intensity level indicators and locate the receiver in the point where the light intensity level indicators are lit.
4. Confirm all the light intensity level indicators are lit.
5. When the above adjustments have been completed, tighten all brackets and mounting screws while being careful not to change the beam adjustment for the light curtain.

Mounting bracket type	Screw designation and length (mm)	Tightening torque
Mounting bracket (top and bottom)	M4×8	1.2 Nm
Mounting bracket (intermediate)	M4×6	1.2 Nm
	M5×8	2.0 Nm

6. If all of the light intensity level indicators are not lit through the above angle adjustment of the receiver, check for parallelism between the emitter mounting surface and the receiver mounting surface and also check if the emitter and receiver are mounted to the same height.

2-5 Check List

A qualified person should complete the following test log.

Check the following items to make sure the installation is correct.

1. Machine structure does not hinder stop and other safety functions.
2. Intrusion into a hazardous part of the machine is not possible without passing through the F3SN-A detection zone.
3. The protective structure allows the F3SN-A to detect anyone working in the hazardous area.
4. The switch to reset the interlock condition must be installed so that the entire hazardous area is visibly free, also the switch must not be able to be operated from within the hazardous area.
5. The safety distance has been calculated.
Calculated distance: $S = (\quad)$ mm
6. The actual safety distance is greater than the calculated distance.
Actual distance = (\quad) mm
7. Reflective surfaces are not installed in prohibited areas.

Check the following items to make sure wiring is correct before turning ON power.

1. The power supply is connected only to the F3SN-A and to the devices related to the electro-sensitive protective function of the F3SN-A, such as a safety controller and muting sensors, and it has enough rated current for all the devices.
2. The power supply unit is a 24 VDC unit that conforms to the EMC Directive, Low-voltage Directive, and output holding specifications.
3. The polarity of the power supply connection is not reversed.
4. The emitter cable is properly connected to the emitter and the receiver cable is properly connected to the receiver.
5. Double insulation is used between I/O lines and the hazard potential (commercial power supplies, etc.).
6. Outputs are not shorted to the +24V line.
7. Loads are not connected to the +24V line.
8. No lines are connected to a commercial supply line.
9. When two or more units are used, they are connected or installed properly to prevent mutual interference, or measures have to be taken to prevent mutual interference.

Check the F3SN-A operations with the machine stopped.

1. The test rod is not deformed. (note 1)
2. Nothing is present in the detection zone.
The power indicator and all of the light intensity level indicators are lit within six seconds after the F3SN-A is turned ON.
3. A test rod can be detected at any position in the detection zone. In other words, all the light intensity level indicators go off and the OFF-state indicator remains lit as long as the test rod is present in the detection zone.
Guide the test rod through detection zone as shown in the figure. (note 2)

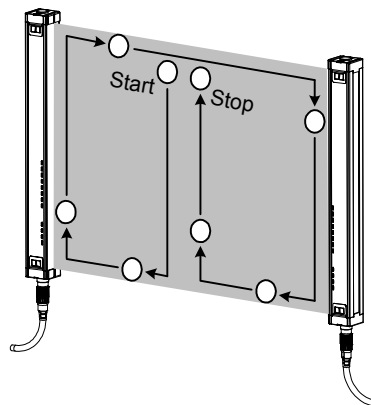

Note 1: The size of the detection capability varies depending on the light curtain type and the floating blanking setting. Perform inspection using a test rod with a proper diameter. (Test rod is not supplied with the F3SN-A□□□□P70 / P70-01.) The diameter of the supplied test rod is not suitable for the inspection when the floating blanking function is used. Prepare the test rod of the proper diameter. (Refer to “1-2-7 Floating Blanking function”).

Note 2: When the fixed blanking is used, confirm that all entries to the disabled detection zone are blocked by protective structures and the test rod can be detected at any position in the detection zone.

4. In case the external test function is used:
When the test input line is short-circuited to the 9 to 24 VDC line, the OFF-state indicator is lit.
5. In case the EDM function is used:
When the light curtain is interrupted and the EDM input line becomes open, the light curtain enters the lockout condition.
6. In case the start interlock function is used:
Even if the light curtain receives light after turning power ON, the OFF-state indicator remains lit. If the reset input is applied, the ON-state indicator is lit.
7. In case the restart interlock function is used:
When the light curtain is interrupted, then goes back to the light receiving condition, the OFF-state indicator remains lit. If the reset input is applied, the ON-state indicator is lit.

Operate the machine and check to see if a hazardous part stops under the conditions below.

1. The dangerous part stops immediately when each beam is interrupted by the test rod in the detection zone at 3 points: directly in front of the emitter, directly in front of the receiver, midway between the emitter and receiver. (Use the correct test rod described in step 3.)
2. The hazardous part remains stopped as long as the test rod is within the detection zone.
3. The hazardous part stops when the F3SN-A power supply is turned OFF.
4. The overall measured machine response time is less than the calculated time.

CHAPTER 3

General Specifications

This chapter contains general technical data.

3-1 I/O Circuit	42
-----------------------	----

3-1 I/O Circuit

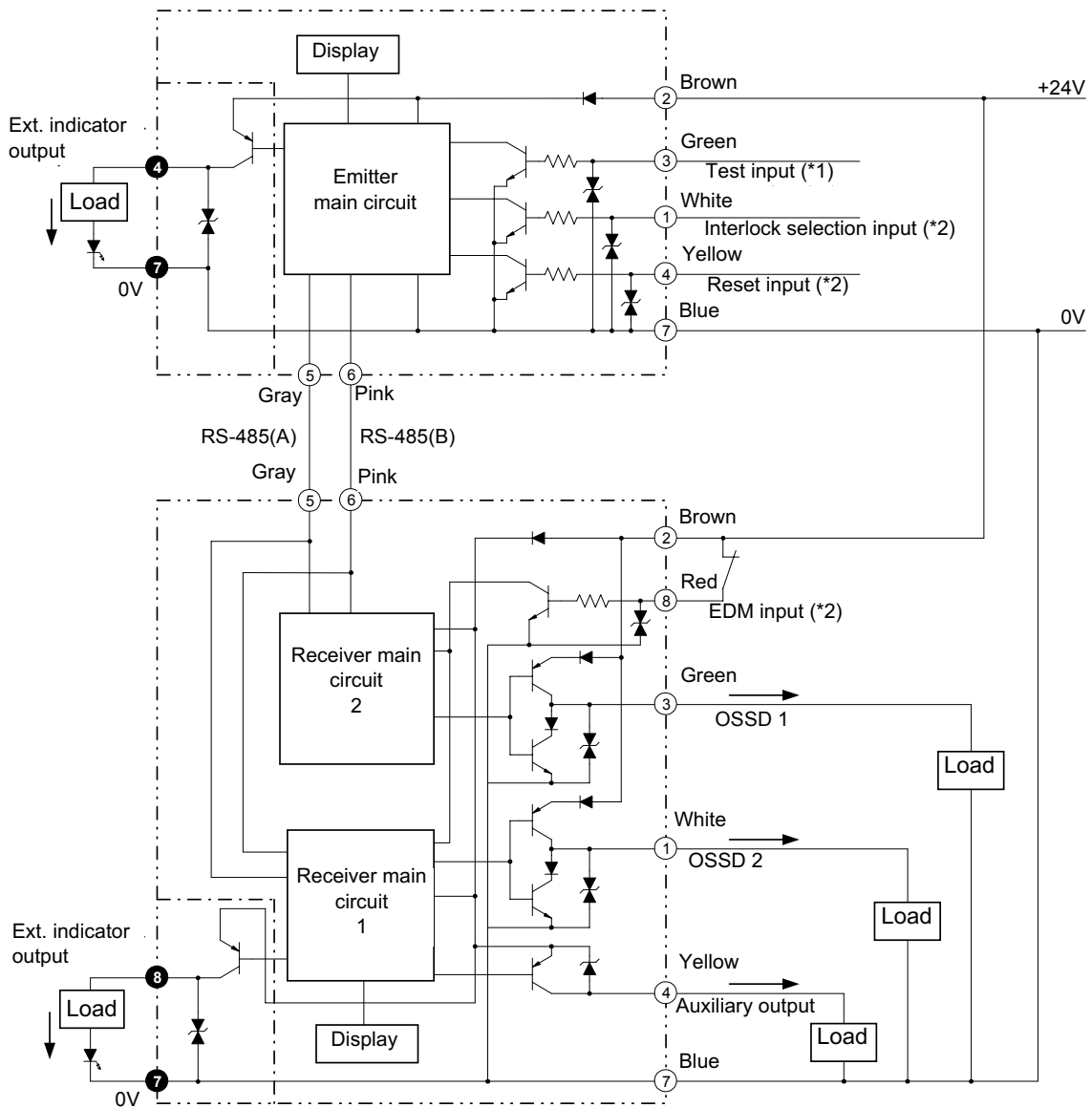

1. Open: normal light emission,
Connected to +24 VDC: Stops light emission
2. See the wiring diagram in chapter 2-4-2.
3. The section encircled with the dashed line applies to F3SN-A□□□□P□□-01 only.

Note The numbers in ❶ indicate pin numbers of the connectors. The numbers in ① indicate pin numbers of the series connection connectors.

Output Waveform of the OSSD outputs

The OSSD outputs will be temporarily OFF, as shown in the following figure, in order to perform the OSSD circuit self-test when the light curtain is in the ON-state. The OSSD circuit diagnosis is correct when this OFF signal is fed back. If the output signal does not contain an OFF signal, the receiver determines that there is an output circuit or wiring failure and goes into the lockout condition.

The number of OFF signals depends on the number of light curtains connected in series. (See the table below).

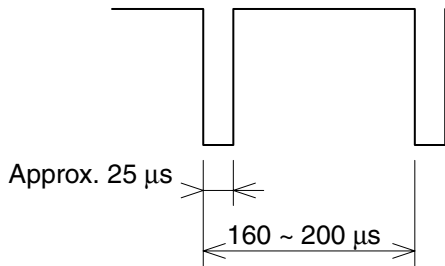
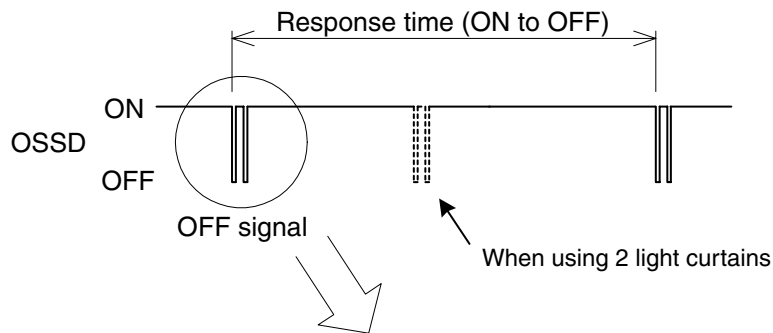

No. of light curtains connected in series	No. of OFF signals within the response time
No series connection	1
2 light curtains	2
3 light curtains	3

In the same way, the OSSD outputs will be ON as shown in the following figure, to perform the OSSD circuit self-test when the light curtain is in the OFF-state.

Check the input response time of a machine connected to the F3SN-A carefully to ensure the machine will not malfunction due to the OFF signal.

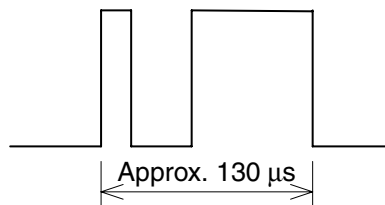
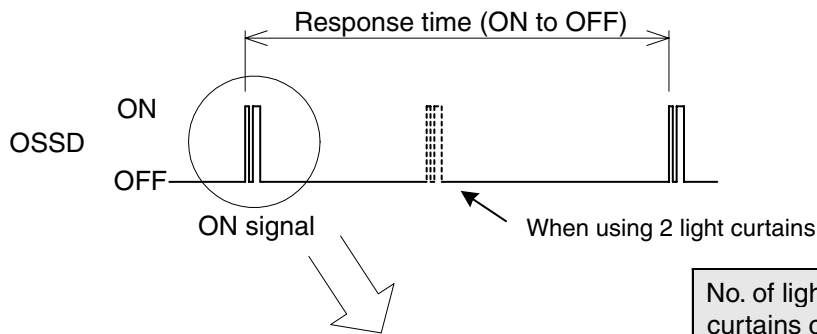

No. of light curtains connected in series	No. of ON signals within the response time
No series connection	1
2 light curtains	2
3 light curtains	3

CHAPTER 4

Sample Circuits

This chapter shows examples of a motor control system with an F3SN-A.

4-1 Applications	46
------------------------	----

4-1 Applications

This chapter shows examples of a motor control system with an F3SN-A. These are category 4 systems (EN954-1 provision).

• Application 1

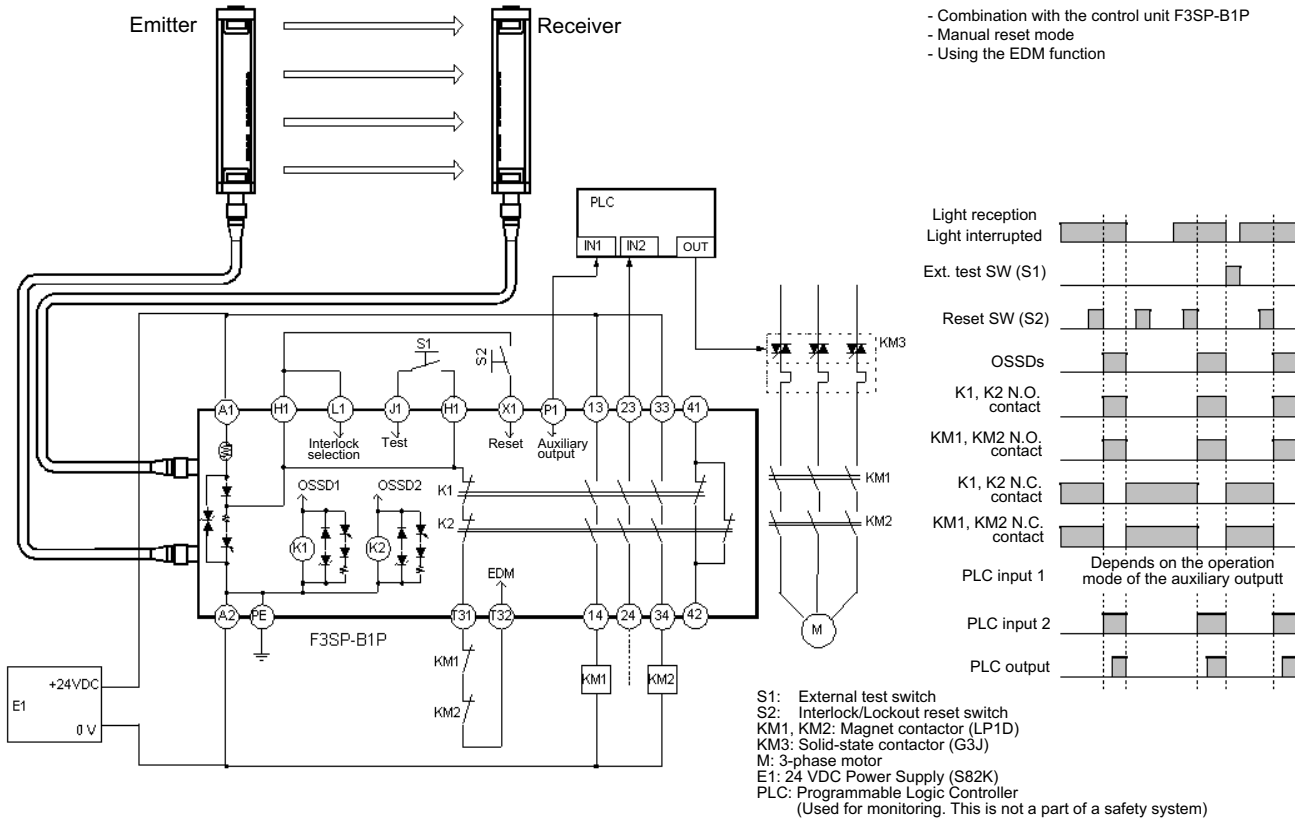

• Application 2

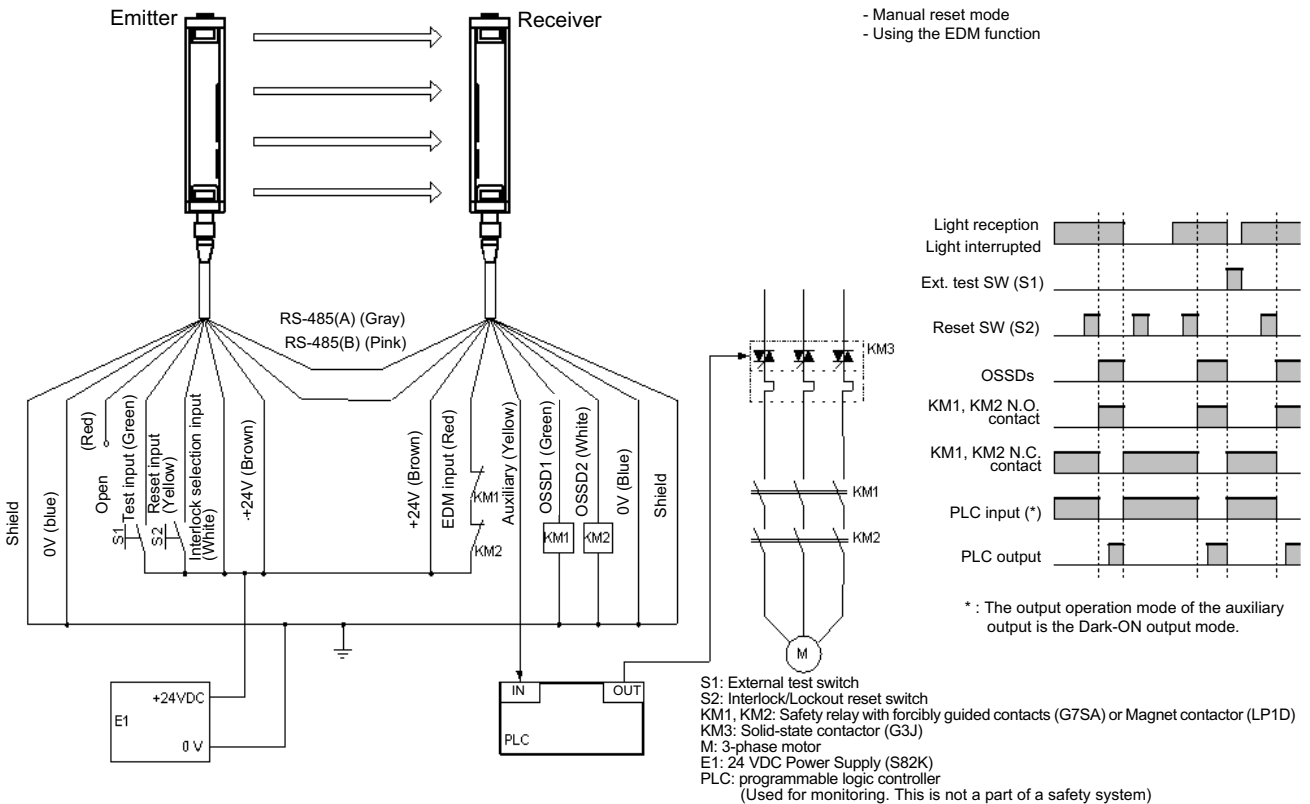

• Application 3

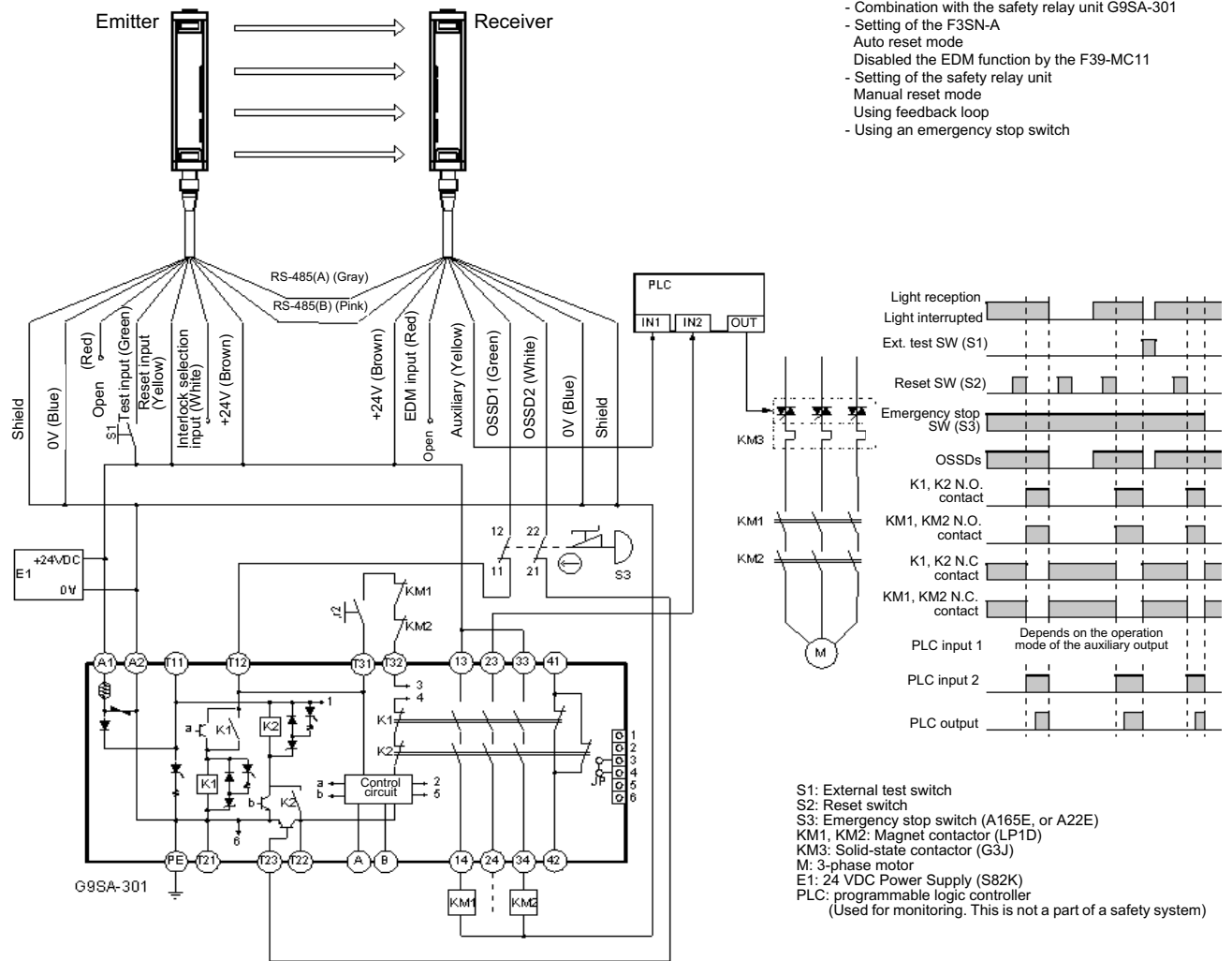

• Application 4

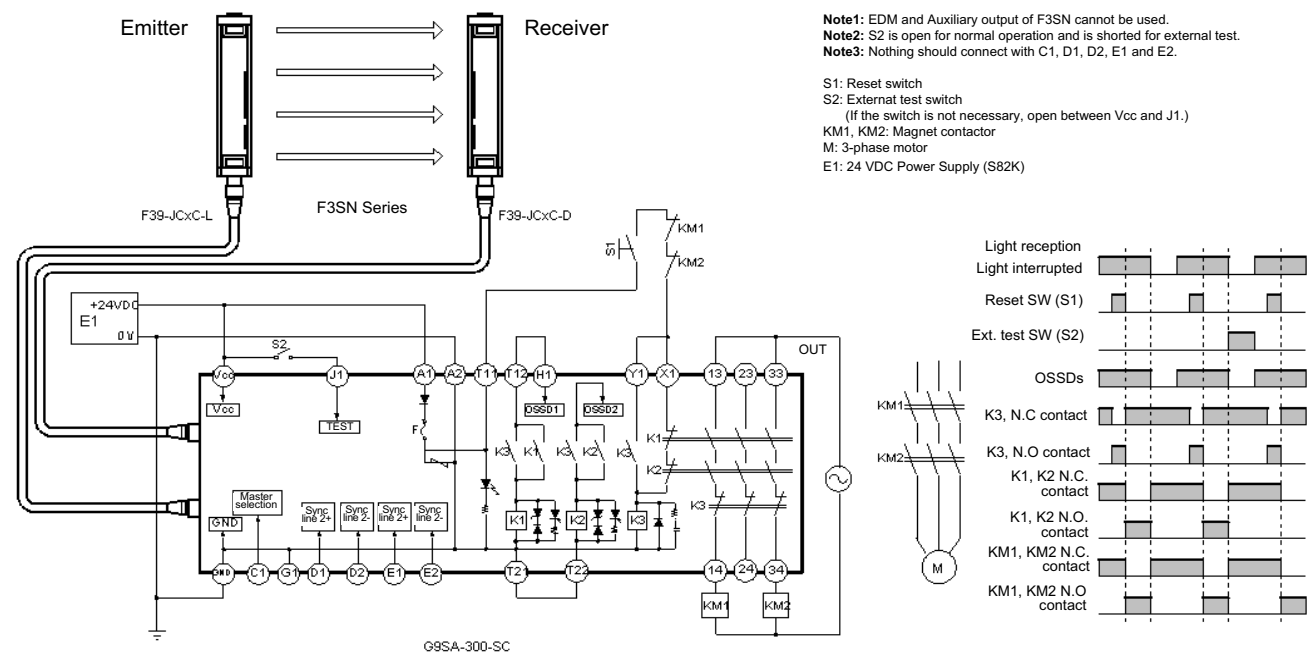

CHAPTER 5

Maintenance

5-1	General	50
5-2	Daily Inspections	50
5-3	Inspections every Six Months	51

5-1 General

WARNING Do not use the F3SN-A until the following inspections are completed. Failure to do so may result in loss of life or serious injury.

Do not disassemble, repair or modify the F3SN-A.

Note For safety, be sure to record and store inspection results. Make sure you are thoroughly familiar with the F3SN-A and the machine prior to conducting an inspection. If the installer, design technician and user are different individuals, make sure the user has adequate guidelines for performing maintenance.

5-2 Daily Inspections

Be sure to inspect the following items at the start of work or after a shift change.

1. No intrusion paths into dangerous machine parts except through the F3SN-A detection zone.
2. Some part of the operator's body remains in the F3SN-A detection zone at all times while working in dangerous machine parts.
3. The actual safety distance is greater than the calculated distance.
4. No dirt or scratches on the optical surface or the spatter protection cover (the F39-HN, optional) of the F3SN-A.
5. The test rod is not deformed.
6. Confirm nothing is present in the detection zone, then turn on the power of F3SN-A.

When the start interlock is not used: The power indicator and the ON-state indicator are lit within one second after turning ON the power.

When the start interlock is used: The power indicator and the OFF-state indicator are lit within one second after turning ON the power.

7. The test rod can be detected when guiding it through detection zone as shown in the figure. In other words, all the light intensity level indicators go off and the OFF-state indicator remains lit as long as the test rod is present in the detection zone.

Note Perform inspection with the proper size test rod in accordance with the light curtain type and the floating blanking setting.

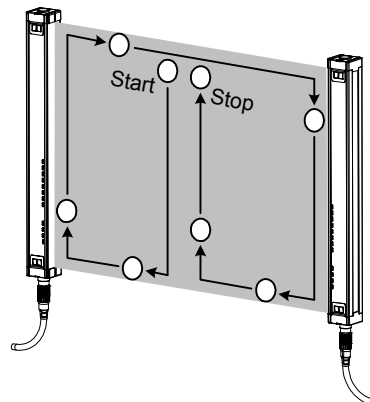

Operate the machine and check to see if a dangerous part stops under the conditions below.

8. The dangerous part moves when there is nothing in the detection zone.
9. The dangerous part stops immediately when each beam is interrupted by the test rod in the detection zone directly in front of the emitter, directly in front of the receiver and midway between the emitter and receiver. (Use the correct test rod.)
10. The dangerous part remains stopped as long as the test rod is within the detection zone.
11. The dangerous part stops when the F3SN-A power supply is turned OFF.

5-3 Inspections every Six Months

Inspect the following items every six months or when a machine setting is changed.

1. Machine structure does not hinder stop and other safety functions.
2. There is no machine modification or connection change that will adversely affect the control system.
3. F3SN-A outputs are correctly wired to the machine.
4. The actual overall response time of the machine is less than the calculated response time.
5. The control relay and/or contactor are good condition.
6. The screws for brackets are secured tightly.
7. There is no interference light.

CHAPTER 6

Troubleshooting



This chapter describes some possible causes of faults in a light curtain.

6-1	Lockout Condition	54
6-2	Other Trouble	55

6-1 Lockout Condition

When the light curtain enters the lockout condition, the error content will be displayed by a flashing pattern of the Error mode indicator. Devise a countermeasure in accordance with the following table.

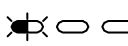
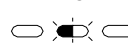
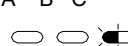
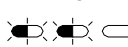
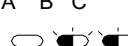
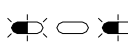
Note For some error conditions, either only the emitter or receiver will flash.

Error mode indicator	Cause		Remedy
A B C 	Wiring error for interlock function setting	1) The reset input line and the interlock selection input line are not wired correctly. 2) The interlock selection input line became open or shorted during power-on.	1)-2) Check the wiring for the auto reset mode or the manual reset mode.
A B C 	Error of the EDM function	1) One of the external relay contacts is welded. 2) The EDM input line is not wired correctly to the external relay. 3) The setting value of relay monitoring time is lower than the relay response time. 4) In the case of connecting the EDM input line to the auxiliary output line in order to make the EDM function inactive, lines are open or shorted to the 0 V line.	1) Replace the relay. 2) Check connection of the relay monitoring input line. 3) Replace with a relay of proper release time, or change the setting value of the relay monitoring time by the F39-MC11. 4) Check the EDM input line and the auxiliary output line for error. Then, confirm that the operation mode for the auxiliary output is in the Dark-ON output mode.
A B C 	RS-485 communication line error	1) The RS-485 communication line is open or shorted to the other I/O line. 2) Communication error by noises. 3) When the light curtains are connected in series, the connector of the series connection cable is disconnected. 4) Failure of the CPU.	1) Check connection of the RS-485 lines. 2) Check noise environment around the RS-485 communication lines. 3) Check the cable connection between the light curtains connected in series. 4) Replace the light curtain
A B C 	OSSD error	1) OSSD outputs are shorted together 2) At least one OSSD output is shorted to the +24V line, 0V line, or the other I/O line. 3) Failure of OSSD output circuit	1)-2) Rewire the OSSD outputs correctly. 3) Replace the receiver.
A B C 	Error by interference light	1) Interference light is received. 2) The emission light of the other photoelectric sensor is received.	1)-2) Interrupt the interference light. (Refer to 2-1-4)
A B C 	Incorrect configuration on the light curtain connection	1) The receiver set type is different from that of the emitter, (e.g. there is a different number of beams.) 2) The number of receivers connected in series is different from that of the emitter.	1)-2) Correct the set type or the number of light curtains connected in series.
A B C 	Error by noises or destruction of the light curtain	1) Influenced by significant noise. 2) Internal hardware failure of the receiver or the emitter.	1) Check noise environment around the light curtain. 2) Replace the receiver or the emitter.



Flashing Not lit

6-2 Other Trouble

In case the light curtain does not work, even if the lockout indicator and the error mode indicator are not flashing, devise a countermeasure in accordance with the following table.

Cause	Reason	Remedy
The light intensity level indicator is not lit although no beams are interrupted.	<ol style="list-style-type: none">1) RS-485 communication lines are not connected.2) RS-485 communication lines are influenced by significant noise.3) Auxiliary output is connected to + 24V line.	<ol style="list-style-type: none">1) Reconnect the RS-485 line correctly.2) Check noise environment around the RS-485 communication lines.3) Open the auxiliary output line, or connect to the 0V line via a load.

APPENDIX A

Optional Accessories

Single-ended connector cable (For emitter and for receiver, set of 2)

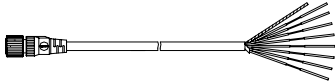

Type	Length	Specifications
F39-JC3A	3 m	M12 connector (8 pins)
F39-JC7A	7 m	
F39-JC10A	10 m	
F39-JC15A	15 m	

Double-ended connector cable (For emitter and for receiver, set of 2)



Type	Length	Specifications
F39-JCR2B	0.2 m	M12 connector (8 pins)
F39-JC3B	3 m	
F39-JC7B	7 m	
F39-JC10B	10 m	
F39-JC15B	15 m	



Control Unit

Type	Output
F3SP-B1P	Relay (3NO + 1NC)



Setting Console

Type	Accessories (supplied with the F39-MC11)
F39-MC11	Branching connector, connector cap, connector cable (2 m) Manual

External indicator *Series connection type is required for connection



Type	Light curtain	Indicator color	Specifications
F39-A01PR-L	Emitter	Red	M 12 connector
F39-A01PG-L		Green	
F39-A01PR-D	Receiver	Red	
F39-A01PG-D		Green	

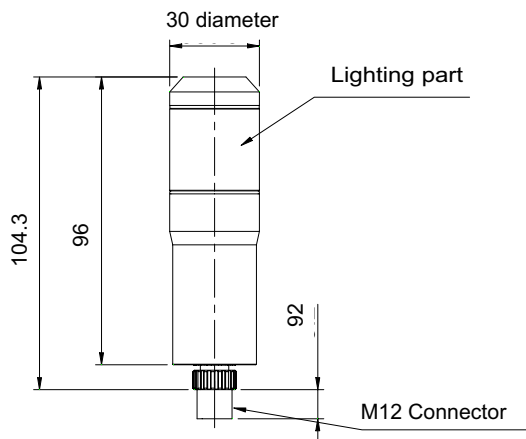

Spatter protection cover (for emitter and for receiver, set of 2)

Type *1	Light curtain
F39-HN□□□□-14	F3SN-A□□□□P14 / P14-01
F39-HN□□□□-25	F3SN-A□□□□P25 / P25-01 F3SN-A□□□□P40 / P40-01 F3SN-A□□□□P70 / P70-01

1. The same 4-digit numbers as the protective heights (□□□□ in the light curtain order number) are substituted by □□□□ in the type names.
2. The operating range of the light curtain will decrease by 10% when using the spatter protection cover.

[Spatter protection cover]

*L is as follows:

F39-HN□□□□-14	L = □□□□ mm
F39-HN□□□□-25	L = □□□□ - 22 mm

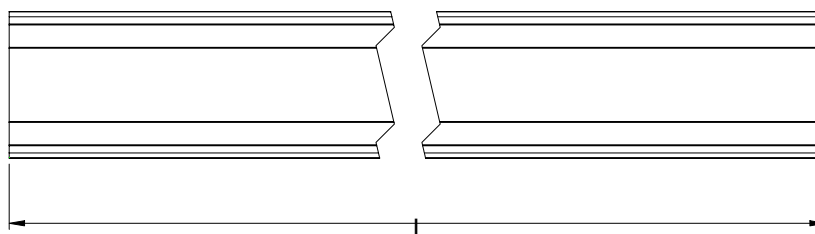
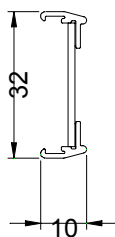

Material:
PC (transparent area)
ABS (non-transparent area)

[Fixing bracket]

Material:
Stainless steel

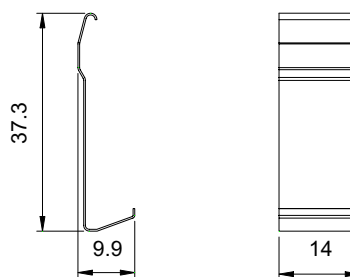

[Mounting dimensions]

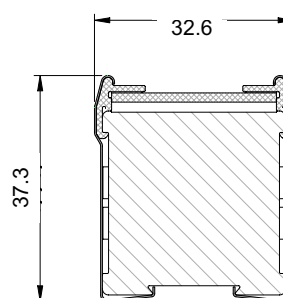

Reflection mirror (15% sensing distance attenuation)

Mirror material	Width (mm)	Thickness (mm)	Length (mm)	Model
Glass mirror	125	31	310	F39-MDG0310
			460	F39-MDG0460
			607	F39-MDG0607
			750	F39-MDG0750
			907	F39-MDG0907
			1,057	F39-MDG1057
			1,207	F39-MDG1207
			1,357	F39-MDG1357
			1,500	F39-MDG1500
			1,657	F39-MDG1657

Note: Other sizes are available upon request

APPENDIX B

Applicable Standards

International Standards

- IEC61496-1 Safety of Machinery: Electro-sensitive Protective Equipment – Part 1: General Requirements and Tests
- IEC61496-2 Safety of Machinery: Electro-sensitive Protective Equipment – Part 2: Particular Requirements for Equipment Using Active Opto-electronic Protective Devices

European Standards

- EN61496-1 Safety of Machinery: Electro-sensitive Protective Equipment – Part 1: General Requirements and Tests
- EN954-1 Safety of Machinery: Safety-related Parts of Control Systems – Part 1: General Principles for Design
- EN415-4 Palletizers and depalletizers
- prEN691 Woodworking machines
- EN692 Mechanical presses
- prEN693 Hydraulic presses

U.S. Federal Regulations

- OSHA 29 CFR 1910.212 General Requirements of All Machines
- OSHA 29 CFR 1910.217 Mechanical Power Presses

U.S. Standards

- ANSI B11.1 Mechanical Power Presses
- ANSI B11.2 Hydraulic Power Presses
- ANSI B11.3 Power Press Brakes
- ANSI B11.4 Shears
- ANSI B11.5 Iron Workers
- ANSI B11.6 Lathes
- ANSI B11.7 Cold Headers and Cold Formers
- ANSI B11.8 Drilling, Milling, and Boring Machines
- ANSI B11.9 Grinding Machines
- ANSI B11.10 Metal Sawing Machines
- ANSI B11.11 Gear Cutting Machines
- ANSI B11.12 Roll Forming and Roll Bending Machines
- ANSI B11.13 Single- and Multiple-Spindle Automatic Bar and Chucking Machines
- ANSI B11.14 Coil Slitting Machines/Systems
- ANSI B11.15 Pipe, Tube, and Shape Bending Machines
- ANSI B11.16 Metal Powder Compacting Presses
- ANSI B11.17 Horizontal Extrusion Presses
- ANSI B11.18 Machinery and Machine Systems for the Processing of Coiled Strip, Sheet, and Standards
- ANSI B11.19 Performance Criteria for the Design, Construction, Care, and Operation of Safeguarding when Referenced by the Other B11 Machine Tool Safety Standards
- ANSI/RIA 15.06 Safety Requirements for Industrial Robots and Robot Systems
- UL1998 Safety-related Software
- UL508 Industrial Control Equipment

APPENDIX C

Function Settings

F3SN

If function settings are changed so that they differ from the factory settings, these changes can be documented in the following function overview. Include this overview with the technical documentation for the machine/equipment on which the F3SN-A is installed.

Function		Setting	
Fixed blanking	Function	Active <input type="checkbox"/>	Inactive <input type="checkbox"/>
	Blanked beam	List selected beams no.: _____	
Floating blanking	Function	Active <input type="checkbox"/>	Inactive <input type="checkbox"/>
	number	1 <input type="checkbox"/> 2 <input type="checkbox"/> 3 <input type="checkbox"/> Delete <input type="checkbox"/>	
	Sequential mode	Active <input type="checkbox"/>	Inactive <input type="checkbox"/>
	Outermost beams included	Active <input type="checkbox"/>	Inactive <input type="checkbox"/>
Auxiliary output	Operation mode	Dark-ON	<input type="checkbox"/>
		Light-ON	<input type="checkbox"/>
		*) Light reception	<input type="checkbox"/>
		*) Lockout	<input type="checkbox"/>
		Outermost beams	<input type="checkbox"/>
		Specified beams	<input type="checkbox"/>
		Blanking	<input type="checkbox"/>
External indicator output	Operation mode	Dark-ON	<input type="checkbox"/>
		Light-ON	<input type="checkbox"/>
		*) Light reception	<input type="checkbox"/>
		*) Lockout	<input type="checkbox"/>
External device monitoring function (EDM)	Function	Active <input type="checkbox"/>	Inactive <input type="checkbox"/>
	Permitted response time	_____ ms (100 to 600 ms)	
Start interlock	Function	Active <input type="checkbox"/>	Inactive <input type="checkbox"/>
Restart interlock	Function	Active <input type="checkbox"/>	Inactive <input type="checkbox"/>
ID setting	Setting	_____ (0000 to 9999)	

*) Monitoring

APPENDIX D

EU Declaration of Conformity

OMRON

No. ESCS108A

Pages: 1 of 2

EC DECLARATION OF CONFORMITY

We hereby declare that the following product is in conformity with the requirements of the below referred EC Directives:

Safety Light Curtain Type: F3SN-A Series
Control Unit Type: F3SP-B1P

No. of Directive : 98/37/EC
Title of Directive : Machinery

No. of Directive : 89/336/EEC
Title of Directive : Electromagnetic Compatibility

The above referenced products conform to the following standards:

Safety of machinery:	
Electro-sensitive protective equipment	EN61496-1: 1997
Active opto-electronic protective devices	IEC61496-2: 1997
Electromagnetic compatibility:	
Immunity	EN61496-1: 1997

Description of Product

The F3SN-A series are electro-sensitive devices designed specifically to detect persons in order to ensure their safety.

The F3SP-B1P is a controller for use with the F3SN-A series.

The F3SN-A series, alone or with the F3SP-B1P, are ESPE Type 4 according to EN61496-1 & AOPD Type 4 according to IEC61496-2 and can be used as a safeguard for personal protection at machinery and other hazardous areas, which require safeguards according to Category B, 1, 2, 3, 4 according to EN954-1.

OMRON

No. ESCS108A

Pages: 2 of 2

Certificate

(1) Machinery Directive - Certificate for EC Type-Examination

Notified Body : UL International Demko A/S

Certificate No. : 129794-01

(2) EMC Directive - Certificate of a Competent Body

Competent Body : UL International Demko A/S

Certificate No. : 129794-02

Manufacturer

Name : OMRON Corporation, Industrial Automation Company,
Sensing Devices & Components Div. H.Q., Industrial Sensors Division

Address : Shiokoji-horikawa, Shimogyo-ku, Kyoto 600-8530 JAPAN

Date : 12.04.2001Signed : 
Yoshinobu Morishita
Division Manager

Representative in EU

Name : OMRON Europe B.V.

Address : Robert Bosch Str.1, P.O.Box 1165-D71154, Nufuringen, GERMANY

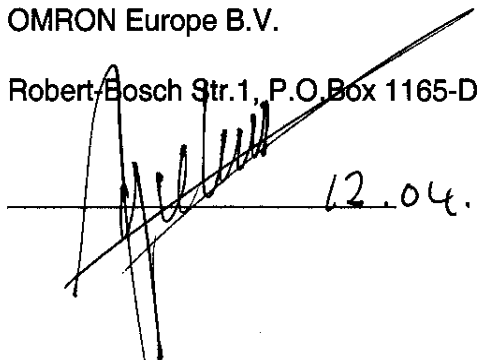
Date : 
12.04.2001Signed : _____
Faouzi Grebici
Deputy General Manager