

OD1000

Displacement measurement sensor

SICK
Sensor Intelligence.



Product described

OD1000

Manufacturer

SICK AG
Erwin-Sick-Str. 1
79183 Waldkirch
Germany

Legal information

This work is protected by copyright. Any rights derived from the copyright shall be reserved for SICK AG. Reproduction of this document or parts of this document is only permissible within the limits of the legal determination of Copyright Law. Any modification, abridgment or translation of this document is prohibited without the express written permission of SICK AG.

The trademarks stated in this document are the property of their respective owner.

© SICK AG. All rights reserved.

Original document

This document is an original document of SICK AG.



Contents

1	About this document.....	6
1.1	Information on the operating instructions.....	6
1.2	Explanation of symbols.....	6
1.3	Scope of delivery.....	6
1.4	Customer service.....	7
2	Safety information.....	8
2.1	Intended use.....	8
2.2	Improper use.....	8
2.3	Limitation of liability.....	8
2.4	Modifications and conversions.....	8
2.5	Requirements for skilled persons and operating personnel.....	9
2.6	Operational safety and particular hazards.....	9
2.6.1	Laser radiation.....	9
2.7	Warning signs on the device.....	10
3	Product description.....	11
3.1	Product characteristics.....	11
3.2	Setup and dimensions.....	12
3.3	Product ID.....	12
4	Transport and storage.....	14
4.1	Transport.....	14
4.2	Unpacking.....	14
4.3	Transport inspection.....	14
4.4	Storage.....	14
5	Mounting.....	15
5.1	Mounting instructions.....	15
5.2	Mounting device.....	15
6	Electrical installation.....	16
6.1	Safety.....	16
6.2	Wiring notes.....	16
6.3	Connecting the device electrically.....	18
7	Operation.....	20
7.1	General notes.....	20
7.2	Control elements and status indicators.....	20
7.2.1	Indicator lights.....	20
7.2.2	Operating buttons.....	21
7.3	Operating concept.....	21
8	Operation via display.....	22
8.1	Menu structure and parameter description.....	22

8.1.1	Main display level and main menu.....	22
8.1.2	Measurement menu group.....	23
8.1.3	I/O interface menu group: Q1 output.....	24
8.1.4	I/O interface menu group: Q2/Qa output, In1 input.....	25
8.1.5	Device menu group.....	26
8.1.6	Communication menu group.....	26
8.1.7	Info menu group.....	26
8.2	Main display level.....	26
8.3	Measurement.....	27
8.3.1	Application settings.....	27
8.3.2	Default settings.....	32
8.4	I/O interface.....	37
8.4.1	Q1 output.....	37
8.4.2	Q ₂ /Q _a output.....	43
8.4.3	In1 input.....	46
8.5	Device.....	51
8.5.1	User level.....	51
8.5.2	Reset.....	51
8.5.3	Saving customer settings.....	51
8.5.4	Language.....	52
8.5.5	Display settings.....	52
8.5.6	Measurement laser.....	52
8.6	Communication.....	53
8.7	Info.....	53
8.7.1	Firmware verification.....	53
8.7.2	Serial number.....	53
8.7.3	Sensor operating hours.....	53
8.7.4	Laser operating hours.....	54
8.7.5	Sensor status.....	54
8.7.6	Part number.....	54
9	Operation via IO-Link.....	55
9.1	Process data.....	55
9.2	Device data.....	55
10	Operation via SOPAS ET.....	56
11	Maintenance.....	58
11.1	Cleaning.....	58
11.2	Maintenance.....	58
12	Troubleshooting.....	59
12.1	General faults, warnings, and errors.....	59
12.2	Detecting and displaying errors.....	59
12.3	Information for service cases.....	60
12.4	Returns.....	60

12.5	Repairs.....	60
12.6	Disposal.....	60
13	Technical data.....	62
13.1	Performance.....	62
13.2	Interfaces.....	63
13.3	Mechanics/electronics.....	63
13.4	Ambient data.....	64
14	Accessories.....	65
14.1	Accessories.....	65
15	Annex.....	66
15.1	EU declaration of conformity / Certificates.....	66
15.2	Licenses.....	66
15.2.1	66

1 About this document

1.1 Information on the operating instructions

These operating instructions provide important information on how to handle the product from SICK AG. Adherence to all the specified safety notes and guidelines is a prerequisite for working safely. You must also comply with any local work safety regulations and general safety specifications applicable to the use of the product.

Ensure that you read through these operating instructions carefully before starting any work. They constitute an integral part of the product and should be stored in the direct vicinity of the product so they remain accessible to personnel at all times. If the product is passed on to a third party, these operating instructions should be handed over with it.

These operating instructions do not provide information on operating the machine in which the product is integrated. For information about this, refer to the operating instructions of the particular machine.

1.2 Explanation of symbols

Warnings and important information in this document are labeled with symbols. The warnings are introduced by signal words that indicate the extent of the danger. These warnings must be observed at all times and care must be taken to avoid accidents, personal injury, and material damage.



DANGER

... indicates a situation of imminent danger, which will lead to a fatality or serious injuries if not prevented.



WARNING

... indicates a potentially dangerous situation, which may lead to a fatality or serious injuries if not prevented.



CAUTION

... indicates a potentially dangerous situation, which may lead to minor/slight injuries if not prevented.



NOTICE

... indicates a potentially harmful situation, which may lead to material damage if not prevented.



NOTE

... highlights useful tips and recommendations as well as information for efficient and trouble-free operation.

1.3 Scope of delivery

Supplied documentation:

- SafetyNotes

**NOTE**

All available documentation can be found online at

▶ www.sick.com/OD1000

1.4 Customer service

If you require any technical information, our customer service department will be happy to help. To find your representative, see the final page of this document.

**NOTE**

Before calling, make a note of all type label data such as type code, serial number, etc., to ensure faster processing.

2 Safety information

2.1 Intended use

The displacement measurement sensor is an opto-electronic measuring device and is used for optical, non-contact distance measurement between the displacement measurement sensor and an object.

The required optical properties of the object that will be detected are specified in the technical data section of this document.

SICK AG assumes no liability for losses or damage arising from the use of the product, either directly or indirectly. This applies in particular to use of the product that does not conform to its intended purpose and is not described in this documentation.

2.2 Improper use

Any use outside of the stated areas, in particular use outside of the technical specifications and the requirements for intended use, will be deemed to be incorrect use.

- The device does not constitute a safety-relevant device according to the EC Machinery Directive (2006/42/EC).
- The device must not be used in explosion-hazardous areas, in corrosive environments or under extreme environmental conditions.
- Any use of accessories not specifically approved by SICK AG is at your own risk.



WARNING

Danger due to improper use!

Any improper use can result in dangerous situations.

Therefore, observe the following information:

- Device should be used only in accordance with its intended use.
 - All information in these operating instructions must be strictly observed.
-

2.3 Limitation of liability

Applicable standards and regulations, the latest state of technological development, and our many years of knowledge and experience have all been taken into account when assembling the data and information contained in these operating instructions. The manufacturer accepts no liability for damage caused by:

- Failing to observe the operating instructions
- Incorrect use
- Use by untrained personnel
- Unauthorized conversions
- Technical modifications
- Use of unauthorized spare parts, consumables, and accessories

With special variants, where optional extras have been ordered, or owing to the latest technical changes, the actual scope of delivery may vary from the features and illustrations shown here.

2.4 Modifications and conversions



NOTICE

Modifications and conversions to the device may result in unforeseeable dangers.

Interrupting or modifying the device or SICK software will invalidate any warranty claims against SICK AG. This applies in particular to opening the housing, even as part of mounting and electrical installation.

2.5 Requirements for skilled persons and operating personnel



WARNING

Risk of injury due to insufficient training.

Improper handling of the device may result in considerable personal injury and material damage.

- All work must only ever be carried out by the stipulated persons.

The operating instructions state the following qualification requirements for the various areas of work:

- **Instructed personnel** have been briefed by the operator about the tasks assigned to them and about potential dangers arising from improper action.
- **Skilled personnel** have the specialist training, skills, and experience, as well as knowledge of the relevant regulations, to be able to perform tasks delegated to them and to detect and avoid any potential dangers independently.
- **Electricians** have the specialist training, skills, and experience, as well as knowledge of the relevant standards and provisions to be able to carry out work on electrical systems and to detect and avoid any potential dangers independently. In Germany, electricians must meet the specifications of the BGV A3 Work Safety Regulations (e.g. Master Electrician). Other relevant regulations applicable in other countries must be observed.

The following qualifications are required for various activities:

Table 1: Activities and technical requirements

Activities	Qualification
Mounting, maintenance	<ul style="list-style-type: none"> ■ Basic practical technical training ■ Knowledge of the current safety regulations in the workplace
Electrical installation, device replacement	<ul style="list-style-type: none"> ■ Practical electrical training ■ Knowledge of current electrical safety regulations ■ Knowledge of the operation and control of the devices in their particular application
Commissioning, configuration	<ul style="list-style-type: none"> ■ Basic knowledge of the Windows™ operating system in use ■ Basic knowledge of the design and setup of the described connections and interfaces ■ Basic knowledge of data transmission
Operation of the device for the particular application	<ul style="list-style-type: none"> ■ Knowledge of the operation and control of the devices in their particular application ■ Knowledge of the software and hardware environment for the particular application

2.6 Operational safety and particular hazards

Please observe the safety notes and the warnings listed here and in other chapters of these operating instructions to reduce the possibility of risks to health and avoid dangerous situations.

2.6.1 Laser radiation

The device is equipped with a laser source:

- Measurement laser (red, visible to the human eye)



CAUTION

Optical radiation: Laser class 1

The accessible radiation does not pose a danger when viewed directly for up to 100 seconds. It may pose a danger to the eyes and skin in the event of incorrect use.

- Do not open the housing. Opening the housing will not switch off the laser. Opening the housing may increase the level of risk.
- Current national regulations regarding laser protection must be observed.

The laser qualifies as a class 1 laser based on standard IEC 60825-1: 2014 (Safety of laser products - Part 1: Equipment classification and requirements, Edition 3).

2.7 Warning signs on the device

A visible red laser is installed in the device. The laser corresponds to laser class 1. The housing is labeled with a warning sign.

3 Product description

3.1 Product characteristics

The displacement measurement sensor uses the triangulation principle for distance measurement. This technology makes it possible to measure the distance between the displacement measurement sensor and an object.

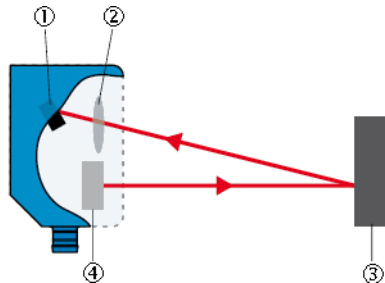

Figure 1: Triangulation principle

- ① Receiver
- ② Lens
- ③ Object
- ④ Laser

A point of light is projected onto the measuring object. The light reflected is captured by a light-sensitive receiver at a specific angle. Based on the angle between the send and receive direction, the position of the object is triangulated (lat. Triangulum: triangle).

The distance determined is transmitted via the IO-Link interface. The analog signal output converts the distance value into an output signal proportional to the distance (switchable: mA/V).

Digital switching outputs can be used to monitor when configured thresholds/distance values have been reached. The “Distance to the object”, “Window”, and “ObSB” switching functions are supported.

Measured distance values can be visualized and parameter settings can be made using the graphical OLED display. Alternatively, the displacement measurement sensor can be configured via the IO-Link interface in conjunction with an IO-Link master. The SOPAS user interface can be used for configuration as well. This process also takes place via the IO-Link interface in conjunction with an IO-Link master. For more information visit:

www.sick.com/SOPAS_ET

3.2 Setup and dimensions

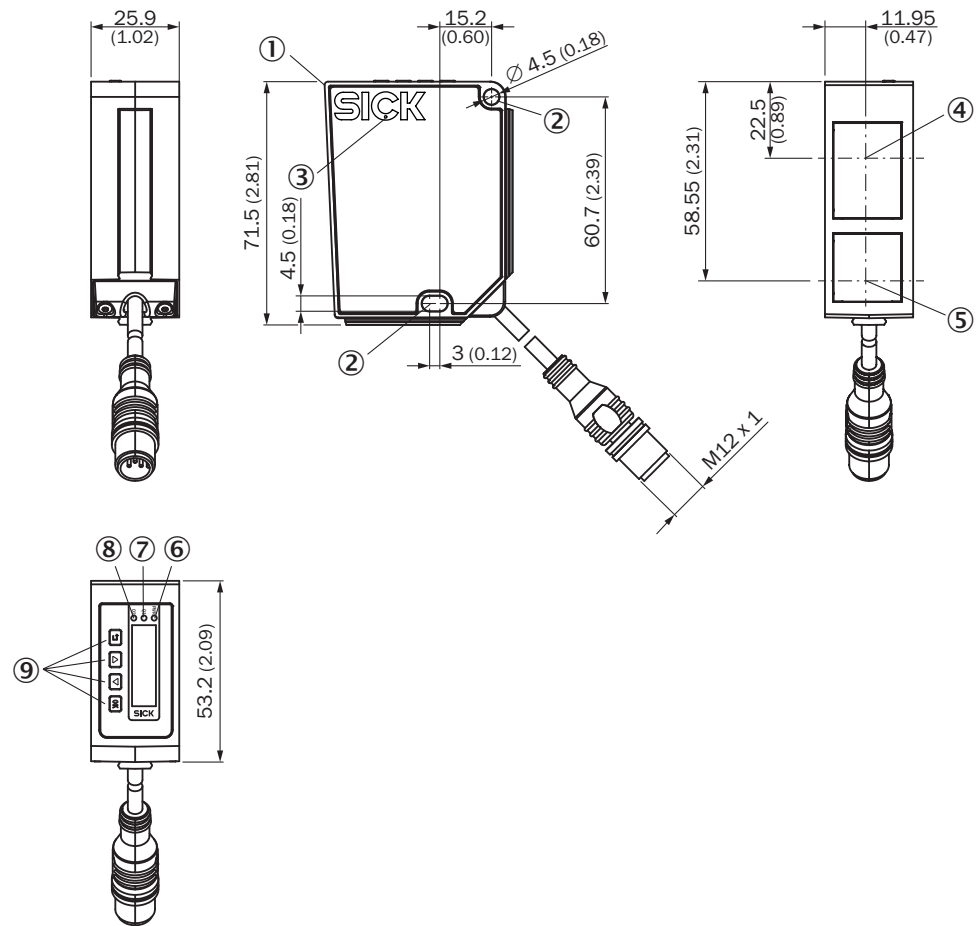

Figure 2: Setup and dimensions

- ① Device zero point (distance = 0 mm)
- ② Fixing holes (for M4)
- ③ Ventilation opening – do not cover!
- ④ Center of optical axis, receiver
- ⑤ Center of optical axis, sender
- ⑥ Display LED, green
- ⑦ Display LED, yellow
- ⑧ Display LED, yellow
- ⑨ Display operating elements

3.3 Product ID

Type label

The following information can be read off the device from the type label:

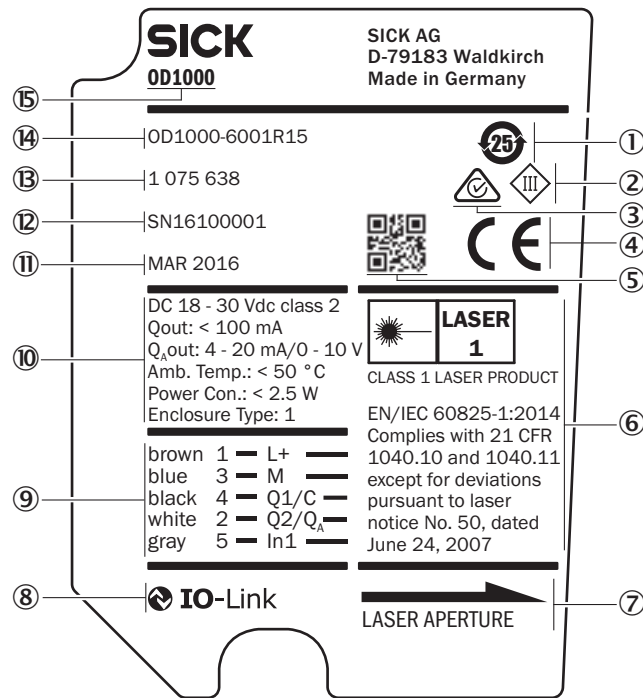

Figure 3: OD1000 type label

- ① EFUP information for China
- ② Protection class
- ③ RCM conformity mark
- ④ EU conformity mark
- ⑤ 2D code with part number and serial number
- ⑥ Laser information
- ⑦ Laser radiation direction
- ⑧ IO-Link symbol
- ⑨ Pin assignment
- ⑩ Electrical data and environmental data
- ⑪ Month and year of manufacture
- ⑫ Serial number
- ⑬ Part number
- ⑭ Type code
- ⑮ Device family

Device display

The following information can be called up using the info menu on the device display:

- Firmware verification
- Serial number
- Sensor operating hours
- Laser operating hours
- Sensor status (error history)
- Part number

4 Transport and storage

4.1 Transport

For your own safety, please read and observe the following notes:



NOTICE

Damage to the product due to improper transport.

- The device must be packaged for transport with protection against shock and damp.
 - Recommendation: Use the original packaging as it provides the best protection.
 - Transport should be performed by trained specialist staff only.
 - The utmost care and attention is required at all times during unloading and transportation on company premises.
 - Note the symbols on the packaging.
 - Do not remove packaging until immediately before you start mounting.
-

4.2 Unpacking

- Before unpacking, it may be necessary to equalize the temperature to protect the device from condensation.
- Handle the device with care and protect it from mechanical damage.

4.3 Transport inspection

Immediately upon receipt in Goods-in, check the delivery for completeness and for any damage that may have occurred in transit. In the case of transit damage that is visible externally, proceed as follows:

- Do not accept the delivery or only do so conditionally.
 - Note the scope of damage on the transport documents or on the transport company's delivery note.
 - File a complaint.
-



NOTE

Complaints regarding defects should be filed as soon as these are detected. Damage claims are only valid before the applicable complaint deadlines.

4.4 Storage

Store the device under the following conditions:

- Recommendation: Use the original packaging.
- Do not store outdoors.
- Store in a dry area that is protected from dust.
- So that any residual damp can evaporate, do not package in airtight containers.
- Do not expose to any aggressive substances.
- Protect from sunlight.
- Avoid mechanical shocks.
- Storage temperature: [see "Technical data", page 62](#).
- For storage periods of longer than 3 months, check the general condition of all components and packaging on a regular basis.

5 Mounting

5.1 Mounting instructions

- Observe the technical data.
- Protect the sensor from direct sunlight.
- To prevent condensation, avoid exposing the sensor to rapid changes in temperature.
- The mounting site has to be designed for the weight of the device.
- To avoid inaccurate measurements when installing multiple devices: Make sure that the laser light spot of one device is not in the visible range of another device.
- Only commission the device 30 minutes after switching it on. Measured values which are taken immediately after the device is switched on are not reliable.

5.2 Mounting device

1. Mount the displacement measurement sensor using the designated fixing holes, see ["Setup and dimensions", page 12](#).
2. Make the electrical connection. Attach and tighten a voltage-free cable, see ["Connecting the device electrically", page 18](#).
3. Switch on the supply voltage.
- ✓ The green operating LED lights up.
The device needs around 10 seconds of initialization time before it is ready for operation.
4. Align the light spot so that the desired object is measured.

6 Electrical installation

6.1 Safety



WARNING

Personal injury due to incorrect supply voltage.

An incorrect supply voltage may result in personal injury.

- Only operate the device using safety extra-low voltage and safe electrical insulation as per protection class III.



NOTICE

Equipment damage or unpredictable operation due to working with live parts.

Working with live parts may result in unpredictable operation.

- Only carry out wiring work when the power is off.
- Only connect and disconnect electrical connections when the power is off.

6.2 Wiring notes



NOTICE

Faults due to incorrect wiring.

Incorrect wiring may result in operational faults.

- Follow the wiring notes precisely.



NOTE

Preassembled cables can be found online at:

- ▶ www.sick.com/OD1000

The electrical connection of the device is configured as an M12 round connector. The protection class stated in the technical data is achieved only with a screwed plug connector or cover cap.

Please observe the following wiring notes:

- A correct and complete cable shielding design is required for trouble-free data transmission.
- The cable shield must be connected at both ends in the control cabinet and at the device. The cable shield of the pre-assembled cables is connected to the knurled nut and thus also to a large area of the device housing.
- The cable shield in the control cabinet must be connected to a large area of the signal ground, [see figure 7](#).
- Appropriate measures must be taken to prevent equipotential bonding currents flowing through the cable shield.
- During installation, pay attention to the different cable groups. The cables are grouped into the following 4 groups according to their sensitivity to interference or radiated emissions.
 - Group 1: Cables very sensitive to interference, such as analog measuring cables
 - Group 2: Cables sensitive to interference, such as device cables, communication signals, bus signals

- Group 3: Cables which are a source of interference such as control cables for inductive loads, motor brakes
- Group 4: Cables which are powerful sources of interference, such as output cables from frequency inverters, welding system power supplies, power cables
- ▷ Cables in groups 1, 2 and 3, 4 must be crossed at right angles (see figure 4).
- ▷ Route the cables in groups 1, 2 and 3, 4 in different cable channels or use metallic separators (see figure 5 and see figure 6). This applies particularly if cables of devices with a high level of radiated emission, such as frequency converters, are laid parallel to device cables.

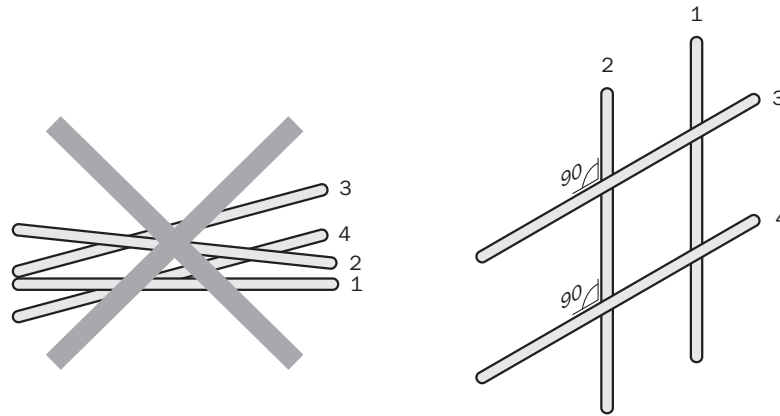

Figure 4: Cross cables at right angles

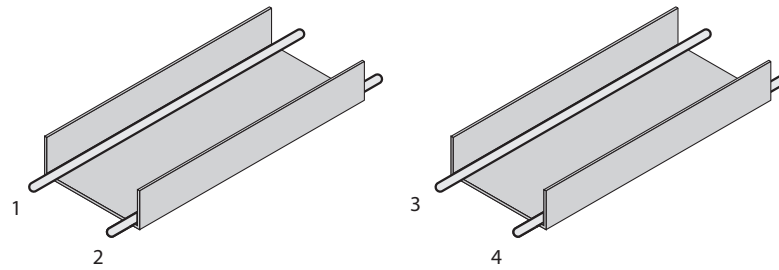

Figure 5: Ideal laying - Place cables in different cable channels

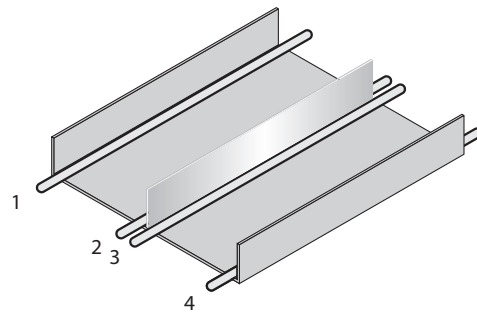

Figure 6: Alternative laying - Separate cables with metallic separators

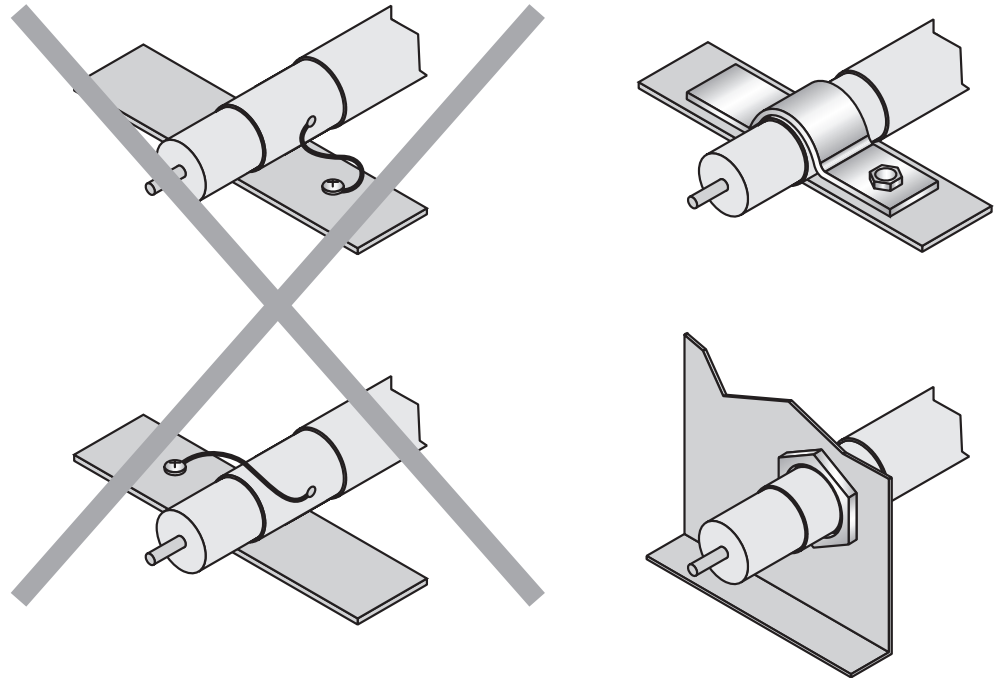

Figure 7: Make an extensive and low-impedance ground connection of the cable shield in the control cabinet.

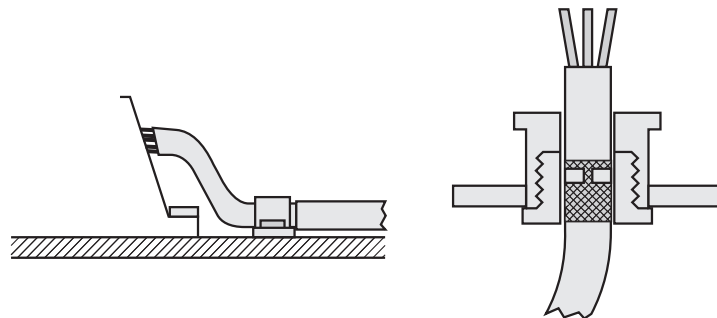

Figure 8: Shield connection in plastic housings



NOTE

Prevent equipotential bonding currents via the cable shield with a suitable grounding concept. If necessary, ground currents on the EtherNet/IP cabling can be prevented by the use of an EtherNet/IP adapter (part number 2044264).

6.3 Connecting the device electrically



NOTE

The connection diagram, and information on inputs and outputs, can be found on the side plate on the device.



NOTICE

All electrical circuits must be connected to the device with safety extra-low voltage (SELV or PELV).

1. Ensure that the voltage supply is not connected.
2. Connect the device according to the connection diagram.
3. Observe the wiring instructions, see "Wiring notes", page 16.

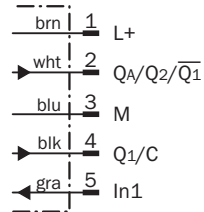
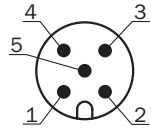

Figure 9: Connection diagram, 5-pin male connector

Table 2: Legend for connection diagram

Contact	Identification	Wire color	Description
1	L+	Brown	Supply voltage: +18 ... +30 V DC
2	$Q_A/Q_2/\overline{Q_1}$	White	Output 2: analog output / switching output 2 (push-pull stage) / Q_1 not
3	M	Blue	Supply voltage: 0 V
4	Q_1/C	Black	Output 1: switching output 1 (push-pull stage) / IO-Link
5	In1	Gray	Input 1

7 Operation

7.1 General notes

If the device is not able to perform a measurement even though the measuring object is within the specified measuring range, the alignment should be checked and optimized if necessary. In general, adjusting the measuring rate can increase the measuring ability for very dark objects, for example.

For a successful teach operation, the device must be able to measure. The distance to the teach object must not change during the teach operation. The object must be in the measuring range, and the distance values taught in for the distance near to the sensor and the distance far from the sensor must not be exactly the same during a switching window or the analog scaling.

To prevent EMC interference, observe the wiring instructions. If an environment is disrupted by EMC interference, data output via IO-Link is the preferred solution. If the application requires an output of the measured values in such an environment via the analog output, an analog current output should also be preferred to using the voltage output, because this is significantly less susceptible to EMC interference.

7.2 Control elements and status indicators

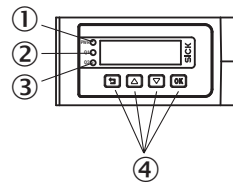

7.2.1 Indicator lights





- ① Status-LED PWR (grün)
- ② Status-LED Q1 (orange)
- ③ Status-LED Q2 (orange)
- ④ Bedientasten





Table 3: Meaning of the indicator lights

Display	Status	Meaning
PWR status indicator	●	Voltage supply available, device ready for use
	○	Voltage supply not available
	●☀	Voltage supply available, device ready for use, connection to an IO-Link master available
Output display Q ₁	●	Switching output active
	○	Switching output not active
Output display Q ₂	●	Switching output active or measured value within the scaling range for the analog output
	○	Switching output not active or measured value outside the scaling range for the analog output

Display	Status	Meaning
Output displays Q ₁	 Simultaneous	Teach-in operation is carried out
	 5 seconds in alternation	Teach-in operation has failed
	 Permanently in alternation	There is a fault



-  Does not light up
-  Flashing
-  Permanently on

7.2.2 Operating buttons

Pushbutton	Function	Description
	Open menu/ confirm	Opens the menu, confirms entries, or switches to the next menu level of a selected element. Moves the cursor to the right when entering numbers.
	Cancel	Switches to the previous menu level. Moves the cursor to the left when entering numbers.
	Navigate	Switches between multiple screens on one menu level. Increases the value when entering numbers.
	Navigate	Switches between multiple screens on one menu level. Reduces the value when entering numbers.

Activating / Deactivating the operating button lock

The operating buttons can be locked / unlocked using a shortcut in order to prevent accidental operation:

- ▶ Press and hold the  and  pushbuttons simultaneously for > 3 seconds.
- ✓ When the pushbutton lock is activated, the  padlock symbol appears in the display. When the pushbutton lock is deactivated, the padlock symbol is not displayed.



NOTE

The operating button lock can also be activated / deactivated via SOPAS ET or IO-Link.

7.3 Operating concept

The device can be operated using the following methods:

- Display and operating buttons on the device, see ["Operation via display"](#), page 22.
- SOPAS ET user interface (PC), see ["Operation via SOPAS ET"](#), page 56.
- IO-Link, see ["Operation via IO-Link"](#), page 55.

8 Operation via display



NOTE

Only certain functions are available depending on the user level set (see ["User level"](#), page 51):

- **Easy:** frequently required functions (factory setting)
- **Advanced:** all available functions

8.1 Menu structure and parameter description

8.1.1 Main display level and main menu

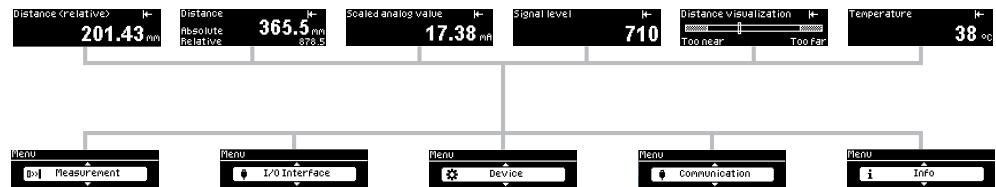

8.1.2 Measurement menu group

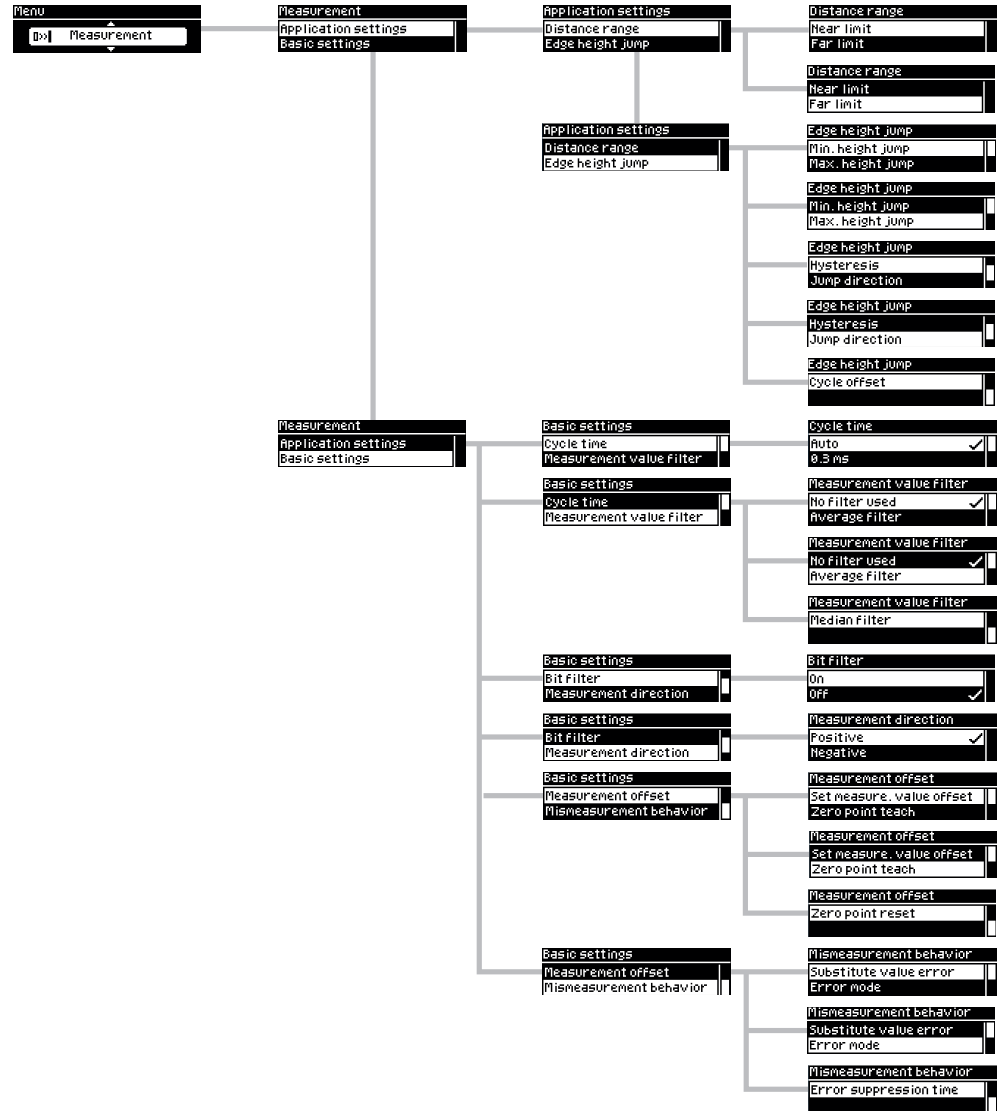

8.1.3 I/O interface menu group: Q1 output

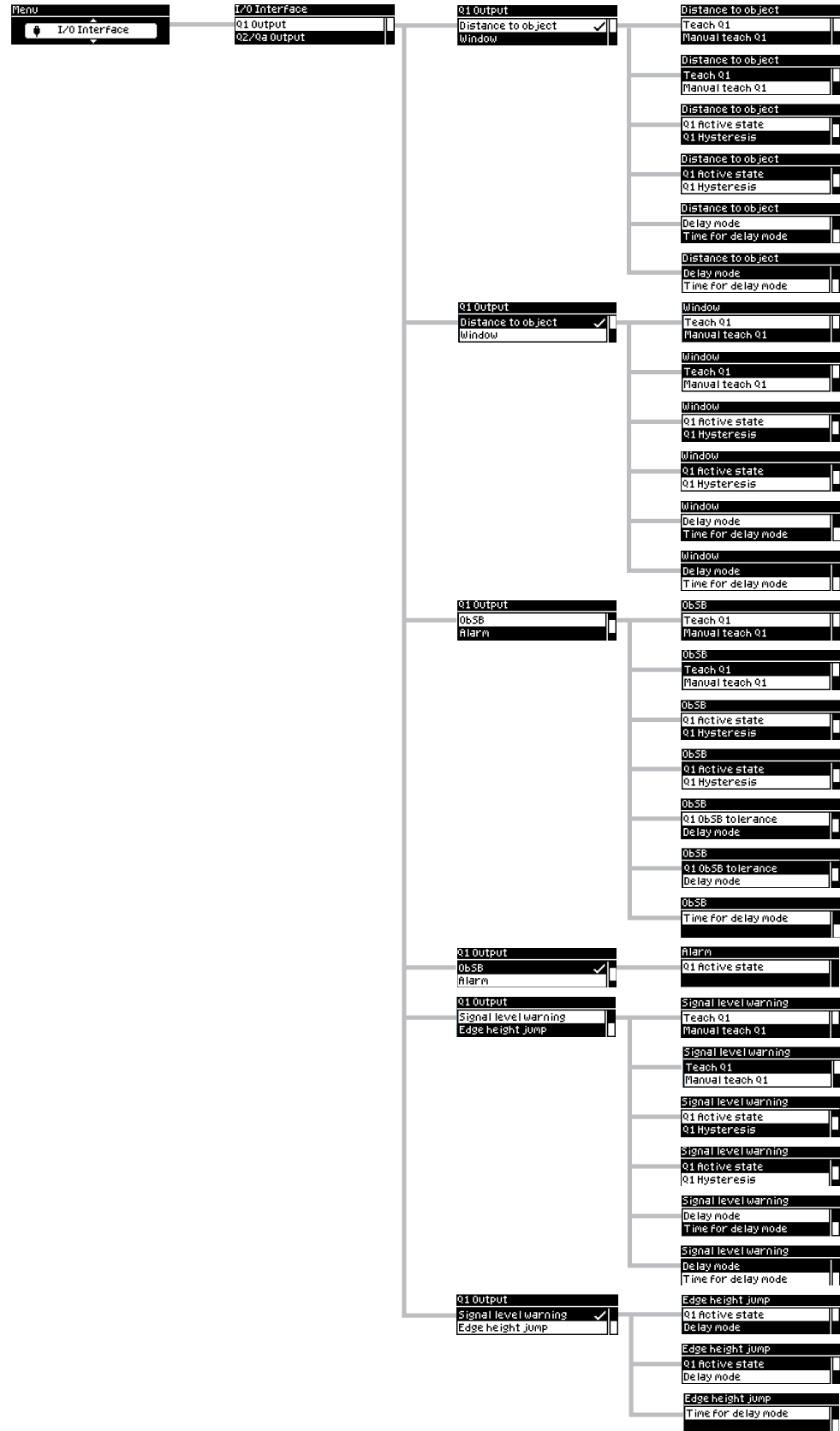

8.1.4 I/O interface menu group: Q2/Qa output, In1 input

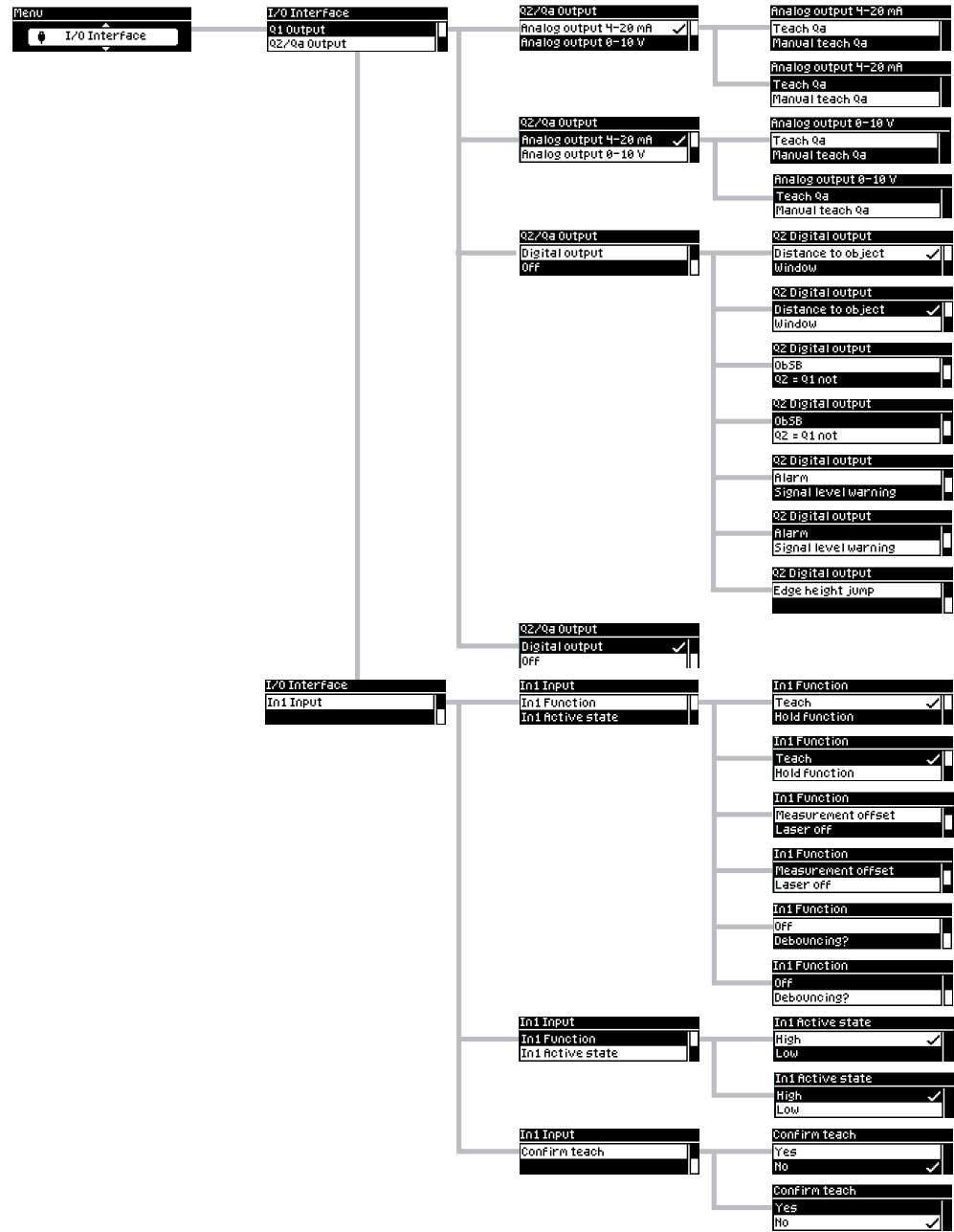

8.1.5 Device menu group

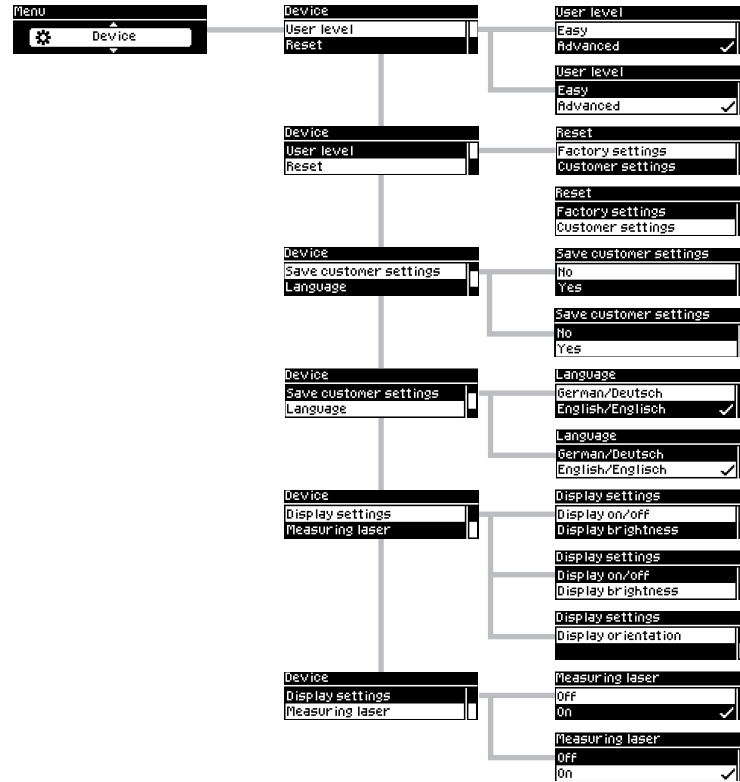

8.1.6 Communication menu group

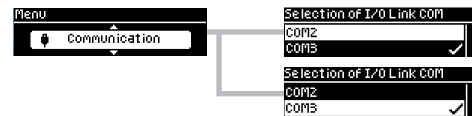

8.1.7 Info menu group

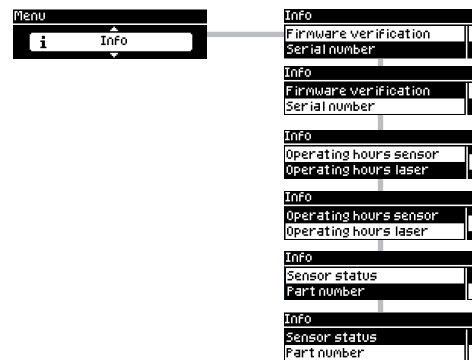

8.2 Main display level

As soon as voltage is supplied to the device, the display shows the main display level and a measured value is displayed.

The / pushbuttons can be used to switch between the following displays:

- Relative distance measured value:

Distance (relative) ←
201.43 mm

The (relative) distance value always takes into account the set measured value offset.

- Absolute and relative distance measured value:

Distance ←
Absolute 365.5 mm
Relative 878.5

Simultaneous display of the distance without (absolute) and with (relative) the set measured value offset.

- Scaled analog value:

Scaled analog value ←
17.38 mA

The current output value is only displayed when the analog output is activated.

- Signal level:

Signal level ←
710



NOTE

The signal level corresponds to the amount of light received by the device's receiver optics. This is a dimensionless value. It essentially depends on the distance from the measuring object, the surface of the measuring object (color, roughness/gloss, angle to the optical axis), and the cycle time set on the device.

To enable the device to measure the distance correctly, the signal level must not drop below a lower limit value. The dynamics of the device normally regulate the level to ensure an optimized value. Depending on the set cycle time, object properties, and object distance, the signal level may drop below the lower limit value and make it impossible to carry out a measurement. It may be possible to improve the measuring behavior by increasing the cycle time, optimizing the alignment of the device with the object, or reducing the distance to the measuring object.

- Distance visualization:

Distance visualization ←
Too near Too far

The cursor gives a qualitative indication of the position within the maximum measuring range.

- Temperature:

Temperature ←
38 °C

The value displays the temperature inside the device and is not relevant for the specified operating temperature range.

8.3 Measurement

8.3.1 Application settings

The functions are only available in the **Advanced** user level, see "Device", page 51.

8.3.1.1 Distance range

The “Distance range” function can be used to define an evaluation range in which the device measures object distances. All surrounding ranges are blanked. A typical application is the blanking of a transparent protective screen fitted between the object and the device.

During configuration, please note that the application must take into account a tolerance range of 15 mm outside the set limits of the distance range. Reliable blanking and detection of objects cannot be guaranteed within this tolerance range.

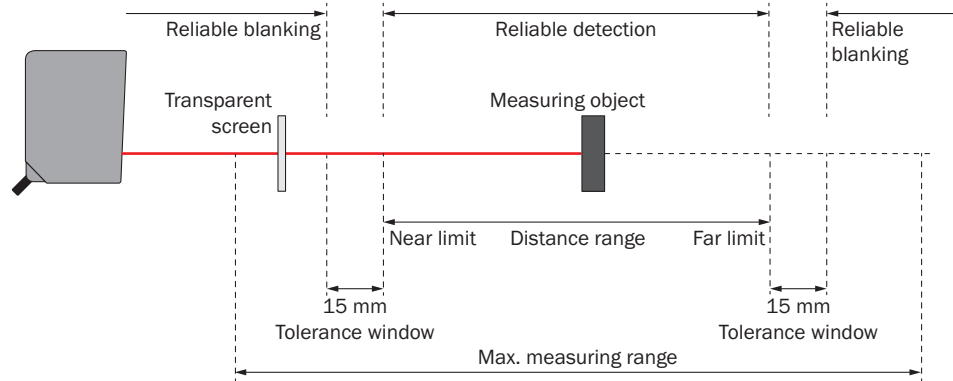

Figure 10: Blanking of a transparent protective screen by establishing the near limit and far limit of the distance range, taking into account the tolerance ranges

Near limit / Far limit

The near limit / far limit values are the distances in mm which define the limits of the evaluation range.



NOTE

As there are limited discretization steps, the device transfers the limit values entered to the next possible distance values (mm). The recalculated value is adopted by the device and is also shown on the display.

Simple configuration of the distance range is also possible via the SOPAS_ET software, see "Operation via SOPAS ET", page 56.

[OK] > Measurement > [OK] > Application settings > [OK] > Distance range > [OK] > Near limit > [OK]



[OK] > Measurement > [OK] > Application settings > [OK] > Distance range > [OK] > Far limit > [OK]



The near limit and far limit parameters are device-dependent and are set to the physical limit in the factory settings. The functionality and linear behavior are available in the valid measuring range of 200 to 1,000 mm.

8.3.1.2 Edge height change

The edge height change function supplies a switching signal at the set device output as soon as there is a change in value between two measured values. A typical application for this function is counting shingles in printing applications. The device takes on the complex evaluation tasks carried out by the control system.

The following settings must be configured on the device in order to use the edge height change function:

- Select the function on the switching output, see "Edge height change", page 43
- Set a fixed cycle time (recommended), see "Cycle time", page 32
- Set the minimum and maximum height change, see "Edge height change", page 29
- Set the hysteresis (if necessary), see "Edge height change", page 29
- Set the change direction (if necessary), see "Edge height change", page 29
- Set the cycle offset (if necessary), see "Cycle time", page 32

Min. / max. height change

The min. / max. height change values define the smallest and largest difference in mm by which the two measured values must differ in order for there to be an edge height change. The function only takes into account the difference between two measured values and is independent of the absolute distance of the object.

[OK] > Measurement > [OK] > Application settings > [OK] > Edge height change > [OK] > Min. height change > [OK]

Min. height jump
+ 0 1 0 .0 mm

[OK] > Measurement > [OK] > Application settings > [OK] > Edge height change > [OK] > Max. height change > [OK]

Max. height jump
+ 1 0 0 .0 mm

Parameter	Factory setting
Min. height change: -9,999.9 mm ... +9,999.9 mm	10 mm
Max. height change: -9,999.9 mm ... +9,999.9 mm	100 mm

Hysteresis

Hysteresis is the difference in distance between the switch-on and switch-off points. This is necessary for stable switching when the measured distance fluctuates around the switching point that has been set. Hysteresis can be configured freely with most distance sensors and is stated in mm. More precise logic can be achieved by setting a lower value. Choose a higher value to ensure more stable switching or reduce the probability of a faulty switch.

[OK] > Measurement > [OK] > Application settings > [OK] > Edge height change > [OK] > Hysteresis > [OK]

Hysteresis
+ 0 0 0 .5 mm

Parameter	Factory setting
0 mm ... +100 mm	0.5 mm

Change direction

The change direction value defines whether changes in measured values which result in smaller or larger distances are detected in both directions.

- Both: All changes in measured values within the set limits are detected
- Positive: Only changes in measured values within the set limits which result in larger distances are detected (description applies to factory setting).
- Negative: Only changes in measured values within the set limits which result in smaller distances are detected (description applies to factory setting).

OK > Measurement > OK > Application settings > OK > Edge height change > OK > Change direction > OK



Parameter	Factory setting
Both, positive, negative	Both

Cycle offset

The cycle offset value specifies which previous output value is compared with the value currently measured.



NOTE

We recommend using the edge height change operating mode with a fixed cycle time, see "Cycle time", page 32. This ensures time consistency for the output of measured values. In the Auto operating mode, fluctuating remission values of the object surface can change the cycle time of the device, which means that reliable detection cannot be guaranteed in the case of high detection speeds or small structures.

OK > Measurement > OK > Application settings > OK > Edge height change > OK > Cycle offset > OK

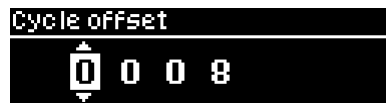

Parameter	Factory setting
1 ... 256	8

Examples of the digital output for the edge height change function

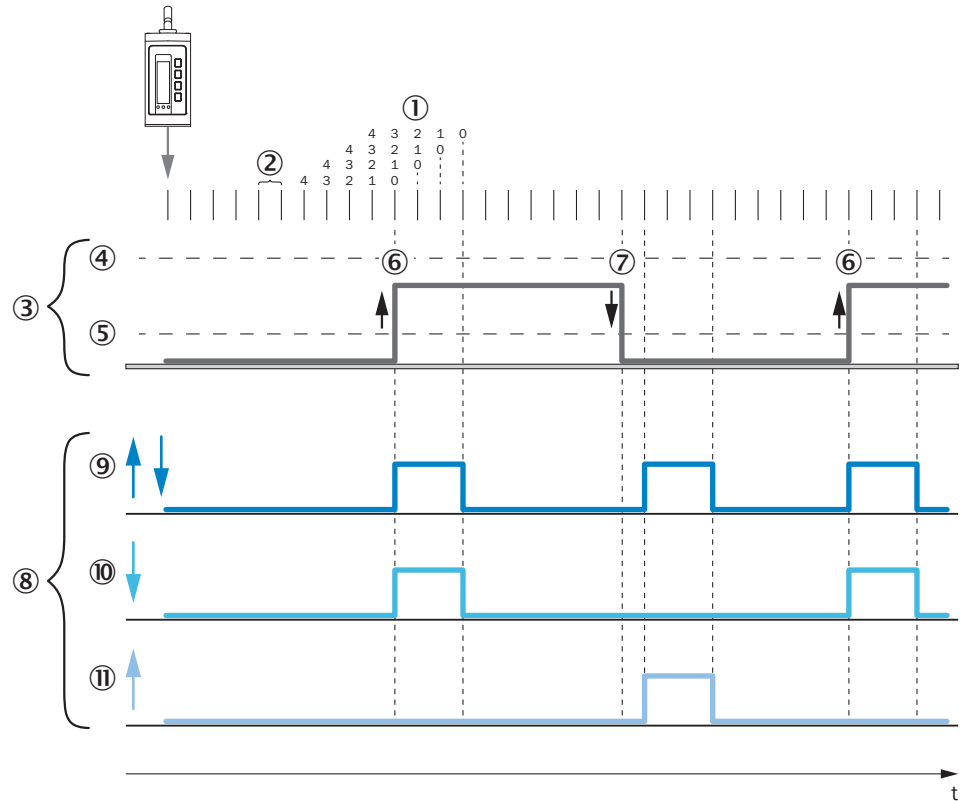

Figure 11: Edge height change – duration of the change in measured value is longer than the time span of the cycle offset

- ① Cycle offset: 4, without measured value filter
- ② Cycle time fixed, e.g. 1 ms
- ③ Signal diagram for real distance
- ④ Max. limit value for edge height change (mm)
- ⑤ Min. limit value for edge height change (mm)
- ⑥ Change in measured value, from large to small distance
- ⑦ Change in measured value, from small to large distance
- ⑧ Signal diagram for digital output
- ⑨ “Change direction: both” parameter
- ⑩ “Change direction: negative” parameter
- ⑪ “Change direction: positive” parameter

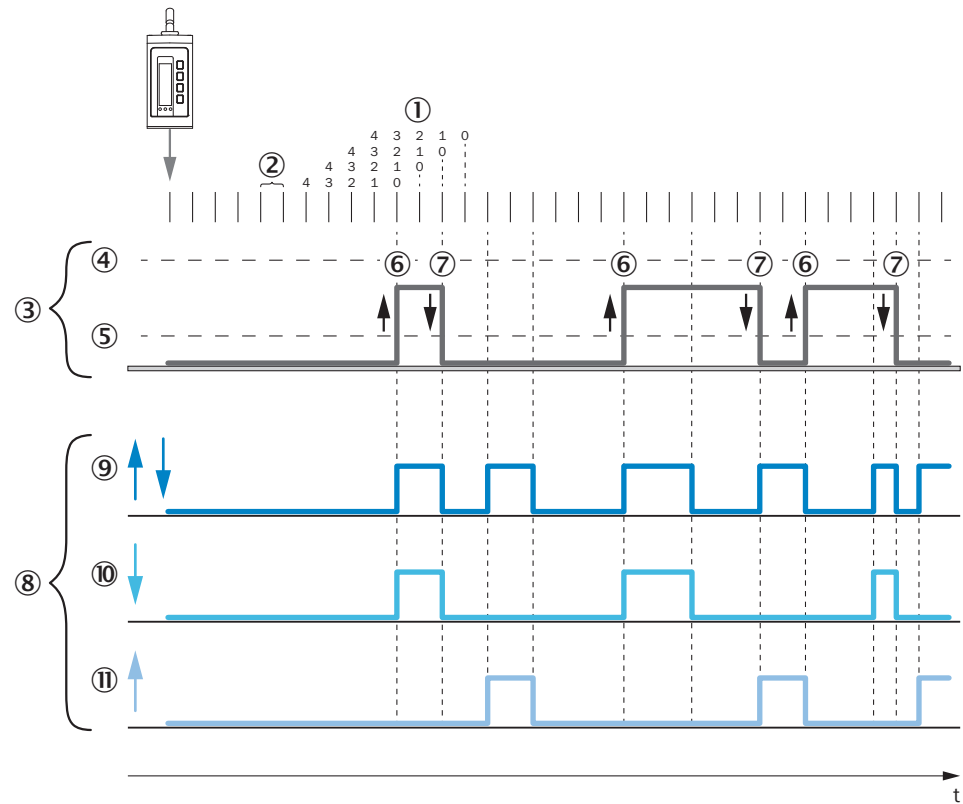

Figure 12: Edge height change – duration of the change in measured value is shorter than the time span of the cycle offset

- ① Cycle offset: 4, without measured value filter
- ② Cycle time fixed, e.g. 1 ms
- ③ Signal diagram for real distance
- ④ Max. limit value for edge height change (mm)
- ⑤ Min. limit value for edge height change (mm)
- ⑥ Change in measured value, from large to small distance
- ⑦ Change in measured value, from small to large distance
- ⑧ Signal diagram for digital output
- ⑨ “Change direction: both” parameter
- ⑩ “Change direction: negative” parameter
- ⑪ “Change direction: positive” parameter

8.3.2 Default settings

8.3.2.1 Cycle time

The cycle time defines the interval in which the device performs a measurement and essentially corresponds to the output rate of the measured values.

There are 2 modes available:

- Auto mode: The device adjusts itself to the maximum speed at which a stable measurement can be achieved, depending on the object surface.



NOTE

In the Auto operating mode, the cycle time is adjusted dynamically so the output rate of the measured values can vary over time.

- Fixed setting: The device uses the set cycle time as a maximum, regardless of the object surface. The output rate of the measured values corresponds to the set value and remains constant.

**NOTE**

If the remission properties of the object are not sufficient to perform a valid measurement, the device outputs the value of an incorrect measurement, see "Action in case of incorrect measurements", page 36.

[OK] > Measurement > [OK] > Default settings > [OK] > Cycle time > [OK]



Parameter	Factory setting
Auto, 0.3 ms, 0.5 ms, 1 ms, 5 ms, 10 ms	Auto

8.3.2.2 Measured value filter

The measured value filters are used to optimize the signal diagram in order to simplify the evaluation by the control system, e.g., for regulation tasks.

- Averaging filter: The averaging filter carries out a moving averaging of the measured values. This filter is suitable for smoothing a noisy signal diagram. This improves the reproducibility of the device.
- Median filter: The moving median filter sorts the measured values according to their size and selects the middle value from a sequence. This filter is suitable for excluding individual outliers from the calculation of an average value.

Both types of filter affect the response time of the distance sensor.

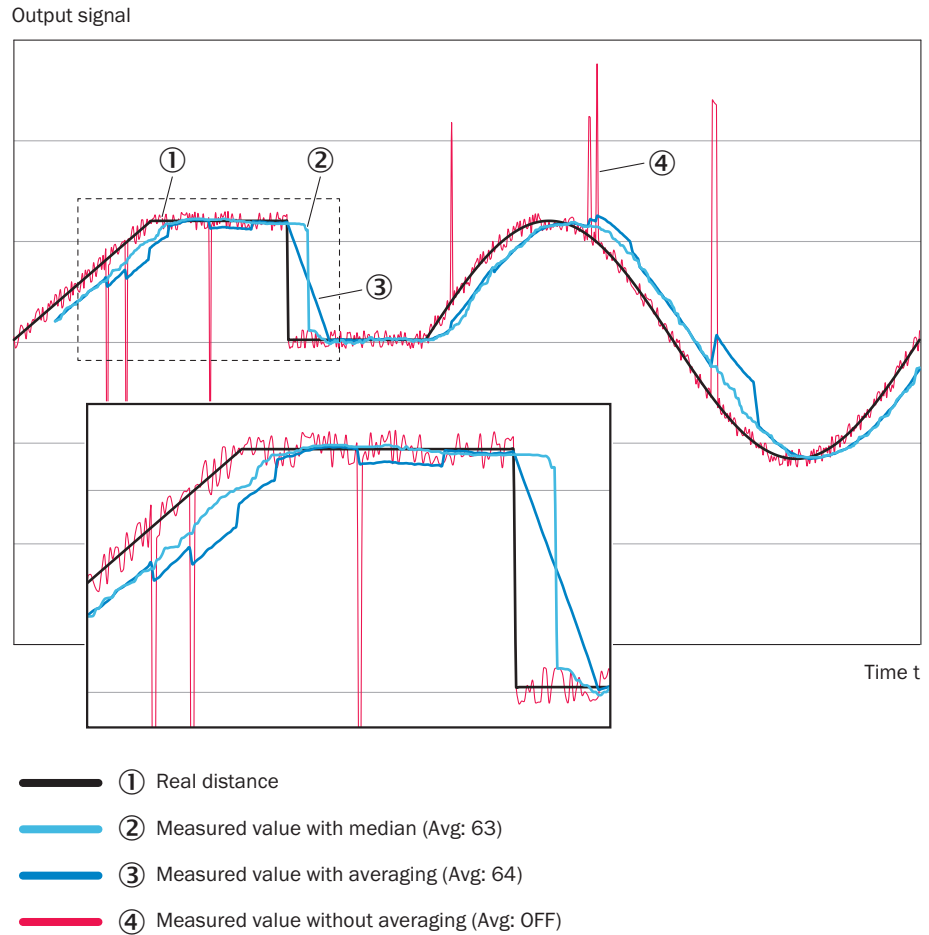

OK > Measurement > OK > Default settings > OK > Measured value filter > OK

```
Measurement value filter
No filter used      ✓
Average filter
```

Parameter	Factory setting
Do not use a filter	x
Averaging filter: 4, 8, 16, 32, 64, 512	-
Median filter: 3, 7, 15, 31, 63, 511	-

8.3.2.3 Bit filter

The bit filter for switching outputs determines how often an identical output state has to recur consecutively before the signal at the switching output changes accordingly.

If the defined number is not reached, the switching output remains unchanged. This may increase the reliability in the application if the distance value fluctuates around the selected switching point. This will not affect the cycle time or the output rate.

OK > Measurement > OK > Default settings > OK > Bit filter > OK



Parameter	Factory setting
On: 1 ... 32, off	2

8.3.2.4 Measuring direction

The function changes the plus/minus sign of the relative distance value depending on the direction from the center of the measuring range.

- Positive: Distances which are larger than the set zero position of the device are assigned a plus sign. Smaller distances are assigned a minus sign accordingly.
- Negative: Distances which are larger than the set zero position of the device are assigned a minus sign. Smaller distances are assigned a plus sign accordingly.

OK > Measurement > OK > Default settings > OK > Measuring direction > OK

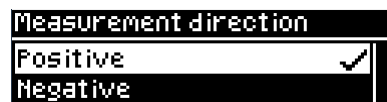

Parameter	Factory setting
Positive, negative	Positive

8.3.2.5 Measured value offset

The measured value offset moves the zero point of the device within the maximum measuring range. This makes it possible to measure absolute distance changes in relation to an individual reference distance.



NOTE

In the case of all offset settings, the current gradient of the analog characteristic curve remains unchanged.

Setting the measured value offset

A manual measured value offset may be set. The distance value that the distance sensor outputs and that is evaluated in the switching functions takes into account the set offset. Only absolute measured values are transferred via IO-Link communication.

Table 4: Example of measured value offset

	Distance (absolute)	Analog output	Set offset
In factory setting	600.0 mm	12.00 mA	-600.0 mm
With offset input +100.0 mm	600.0 mm	14.00 mA	-500.0 mm

OK > Measurement > OK > Default settings > OK > Measured value offset > OK > Set measured value offset > OK

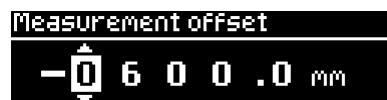

Parameter	Factory setting
-1,000.0 m ... +1,000.0 m	-600.0 m

Teaching in the zero point

The current distance is taught in as a new zero point (reference point). When the analog output is activated, the analog value is set to the center of the measuring range at this distance (12 mA / 5 V).

[OK] > Measurement > [OK] > Default settings > [OK] > Measured value offset > [OK] > Teach in zero point > [OK]

```
Zero point teach?
No
Yes
```



NOTE

This function can also be executed using a shortcut:

- ▶ In the main display level, press and hold the [OK] pushbutton for > 3 seconds until the relative distance value is set to 0.0 mm

Resetting the zero point

This resets the zero point to the center of the measuring range according to the factory setting.

[OK] > Measurement > [OK] > Default settings > [OK] > Measured value offset > [OK] > Reset zero point > [OK]

```
Zero point reset?
No
Yes
```



NOTE

This function can also be executed using a shortcut:

- ▶ In the main display level, press and hold the [OK] pushbutton for > 6 seconds until the relative distance value is set to the factory setting.

8.3.2.6 Action in case of incorrect measurements

If a distance measurement cannot be run, an error is output. Possible causes of the error:

- The measuring object is outside of the measuring range.
- The light signal received by the device is not strong enough.
- The laser is switched off.

You can configure the device behavior for the event that no measurement is possible. The following options are available:

- **Substitute value in the event of an error:** A numerical value can be entered which is output when no measurement is possible.
- **Error mode > User-defined values:** If no measurement is possible, the set **Substitute value in the event of an error** (see above) is displayed and held until a valid measured value is available again.
- **Error mode > Hold last value:** If no measurement is possible, the last valid measured value is displayed and held until a valid measured value is available again.

- **Error mode > Hold last value for a defined time:** If no measurement is possible, the last valid measured value is displayed and held for the time set under **Error suppression time** (see below). Once this time has elapsed, the set **Substitute value in the event of an error** (see above) is displayed and held until a valid measured value is available again.
- **Error suppression time:** It is possible to set a time for which the last valid measured value is displayed and held if the error mode **Hold last value for a defined time** (see above) is activated.

> Measurement > > Default settings > > Action in case of incorrect measurements >

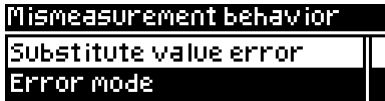

Parameter	Factory setting
Substitute value in the event of an error: -3,276.8 m ... +3,276.7 m	+3,276.7 m
Error mode: User-defined values Hold last value Hold last value for a defined time	✓ - -
Error suppression time: 0001 ms ... 9,999 ms	1 ms

8.4 I/O interface

8.4.1 Q1 output

The Q1 output is purely a switching output. In addition, the output serves as a communication line for bidirectional data transmission when using the IO-Link interface.

The Q1 output of the OD 1000 provides the following switching modes:

- DtO, distance to object (1-point), one switching point
- Window, two switching points
- ObSB, object between sensor (device) and background, one switching point
- Alarm (only in **Advanced** user level)
- Signal level warning (only in **Advanced** user level)
- Edge height change (only in **Advanced** user level)

The switching modes are explained in the subsequent chapters.

8.4.1.1 Notes on the measuring and setting functions

The following functions can be set independently from each other on both outputs depending on the selected output function.

Delay mode

Delay mode is used to output the output state change with a time delay or as a short switching pulse (1 shot).

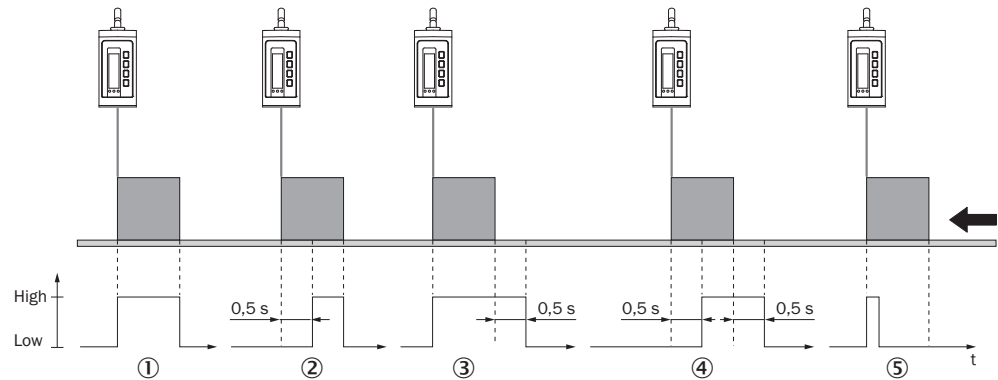

- ① **Off:** Right after the measured distance has exceeded the specified switching point, the state of the switching output changes (factory setting).
- ② **Switch-on delay:** The changeover of the switching output from an inactive to an active state is time-delayed. The delay time is adjustable. The changeover from an active to an inactive state is not delayed.
- ③ **Switch-off delay:** The changeover of the switching output from an active to an inactive state is time-delayed. The delay time is adjustable. The changeover from an inactive to an active state is not delayed.
- ④ **Switch-on/switch-off delay:** The changeover from an inactive to an active state and vice versa is time-delayed. The delay time is adjustable.
- ⑤ **1 shot:** Once the switching condition has been met, the switching output changes from an inactive to an active state. The output state remains in an active state for a specified period regardless of how long the switching condition is met. It does not switch back to an inactive state until this time has elapsed. Any additional changes made to the switching condition during this period are still not taken into account.



NOTE

For a combination of switch-on delay and switch-off delay, the following conditions must be met:

- Equidistant measuring frequency
- Min. 2x measuring frequency
- Cycle time must not be set to AUTO.

Active status

The active status describes the relationship between the output state (active or inactive) and the potential present on the switching output (high or low).

OK > I/O interface > OK > Q1 output > OK > Distance to object > OK

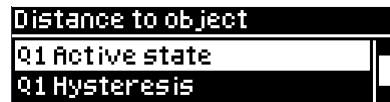

If the **Distance to object** switching mode is selected, the required settings can be taught in or set manually. These are described in the following.

8.4.1.2 Distance to object, DtO, single switching point

A signal is output if the measured distance value has undershot (normally open – High Active) or exceeded (normally closed – Low Active) the switching point.

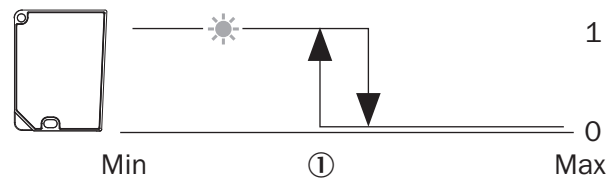

Figure 13: Distance to object or single switching point (normally open – High Active, PNP)

① Switching point

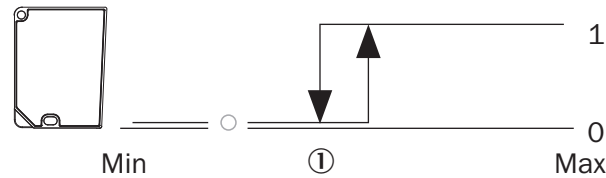

Figure 14: Distance to object or inverted single switching point (normally closed – Low Active, PNP)

① Switching point

If the “Distance to object” switching mode is selected, the required settings can be taught in or set manually.

In the “Distance to object” operating mode, the following settings can be configured:

- Teach-in
- Manual teach-in
- Active status
- Hysteresis
- Delay mode
- Time for delay mode

The possible settings are described below.

Teach-in: A single switching point can be taught in. The switching point is set to the current distance at the time the button is pressed.

- Q1: A signal is output if the switching point that has been taught in is undershot. Thus the output acts as a normally open contact (“High” active status).
- Q1not: A signal is output if the switching point that has been taught in is exceeded. Thus the output acts as a normally closed contact (“Low” active status).

Manual teach-in: The distance of the switching point can be set manually in 1/10 mm.

Q1 active status: The active status specifies the functionality of the switching output, see ["Notes on the measuring and setting functions", page 37](#).

- High: The switching output acts as a normally open contact. A signal is output if the switching point that has been taught in is undershot.
- Low: The switching output acts as a normally closed contact. A signal is output if the switching point that has been taught in is exceeded.

Delay mode

- see ["Notes on the measuring and setting functions", page 37](#) .

Time for delay mode

- The time for the delay mode can be set manually in ms.

[OK] > I/O interface > [OK] > Q1 output > [OK] > Distance to object > [OK]

```
Distance to object
Teach Q1
Manual teach Q1
```

Parameter	Factory setting
Q1 teach-in: Q1, Q1 not	-
Manual Q1 teach-in: -1,000.0 mm ... +1,000.0 mm	+400 mm
Q1 active status: High, Low	High
Q1 hysteresis: 0000.0 mm ... +0100.0 mm	+1.0 mm
Delay mode: Off Switch-on delay Switch-off delay Switch-on/switch-off delay 1 shot	✓ - - - -
Time for delay mode: 0000 ms ... 9,999 ms	100 ms

8.4.1.3 Window

Window mode: An upper and a lower switching threshold are set for the switching output. A switching signal is output when the measured value is between the two switching thresholds (in the window).

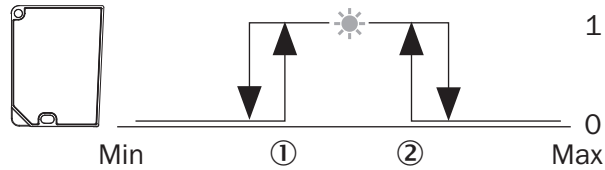

Figure 15: Normally open switching window (High Active, PNP)

- ① Switching point near
- ② Switching point far

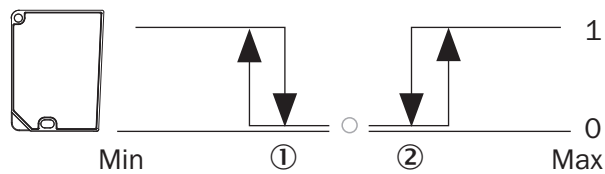

Figure 16: Normally closed switching window (Low Active, PNP)

- ① Switching point near
- ② Switching point far

[OK] > I/O interface > [OK] > Q1 output > [OK] > Window > [OK]



Parameter	Factory settings
Q1 teach-in: Switching point 1, switching point 2	-

Parameter	Factory settings
Manual Q1 teach-in: Switching point 1: -1,000.0 mm ... +1,000.0 mm Switching point 2: -1,000.0 mm ... +1,000.0 mm	+400.0 mm -400.0 mm
Q1 active status: High, Low	High
Q1 hysteresis: 0000.0 mm ... +0100.0 mm	+1.0 mm
Delay mode: Off Switch-on delay Switch-off delay Switch-on/switch-off delay 1 shot	✓ - - - -
Time for delay mode: 0 ms ... 9,999 ms	100 ms

8.4.1.4 ObSB (object between sensor and background)

Object between device and background: In this switching mode, any background can be taught in as a reference. If an object obscures the background or the distance to the background changes significantly, this causes the device to switch. This switching mode is primarily suited to the reliable detection of high-gloss or extremely dark materials. This makes it possible to detect even painted vehicle parts with large approach angles, for example.

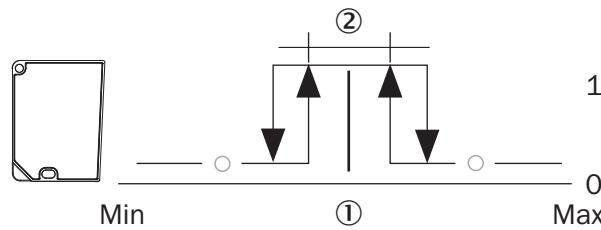

Figure 17: Object between device and background (normally open – High Active, PNP)

- ① Switching point (reference background)
- ② Tolerance around teach point: ± 4.0 mm

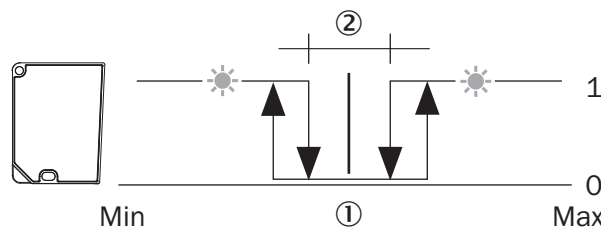

Figure 18: Object between device and background (normally closed – Low Active, PNP)

- ① Switching point (reference background)
- ② Tolerance around switching point: ± 4.0 mm

OK > I/O interface > OK > Q1 output > OK > ObSB > OK



Parameter	Factory setting
Q1 teach-in: Q1, Q1 not	-
Manual Q1 teach-in: -1,000.0 mm ... +1,000.0 mm	+400 mm
Q1 active status: High, Low	High
Q1 hysteresis: 0000.0 mm ... +0100.0 mm	+1.0 mm
Q1 ObSB tolerance -1,000.0 mm ... +1,000.0 mm	+4.0 mm
Delay mode: Off, switch-on delay, switch-off delay, switch-on/switch-off delay, 1 shot	Off
Time for delay mode: 0000 ms ... 9,999 ms	100 ms

8.4.1.5 Alarm

The alarm function is only available in the **Advanced** user level. A constant switching signal is output at the output of the device while no measurement is possible. This function can be used to evaluate the measured value at the analog output, for example.

OK > I/O interface > OK > Q1 output > OK > Alarm > OK



Parameter	Factory settings
Alarm	Off

8.4.1.6 Signal level warning

The signal level warning function is only available in the **Advanced** user level.

A warning can be output via the Q1 and Q2 switching outputs if the signal level drops below a certain value. This value can either be specified as a number value or determined by the **Teach-in** function. When the **Teach-in** function is used, the threshold value for outputting the warning is calculated by reducing the measured signal level value by about 12%. Then the warning will not be output until the signal level is about 12% lower than it was at the time it was taught in.

The level warning threshold or signal level switching point can be set manually using a signal level within the value range of 0 to 5,000. The signal level is a sensor-specific, unitless value. We recommend configuring the setting using application-specific test measurements.

In automatic mode, the device automatically regulates the reception level to around 1000. In the case of very critical object surfaces, an abrupt loss of signal can therefore occur as soon as a readjustment is no longer possible. In settings other than **Auto**, there is no automatic adjustment, which makes it easier to define thresholds for the signal level warning.

OK > I/O interface > OK > Q1 output > OK > Signal level warning > OK

Signal level warning
Teach Q1
Manual teach Q1

Parameter	Factory settings
Q1 teach-in: Switching point 1, switching point 2	-
Manual Q1 teach-in: -0 ... 5,000	112
Q1 active status: High, Low	High
Q1 hysteresis: 0 ... 10,000	10
Delay mode: Off, switch-on delay, switch-off delay, switch-on/switch-off delay, 1 shot	Off
Time for delay mode: 0000 ms ... 9,999 ms	100 ms

8.4.1.7 Edge height change

The edge height change function is only available in the **Advanced** user level, see ["Device", page 51](#).

[OK] > I/O interface > [OK] > Q1 output > [OK] > Edge height change > [OK]

Edge height jump
Q1 Active state
Delay mode

Parameter	Factory settings
Q1 active status: High, Low	High
Delay mode: Off, switch-on delay, switch-off delay, switch-on/switch-off delay, 1 shot	Off
Time for delay mode: 0000 ms ... 9,999 ms	100 ms

8.4.2 Q₂/Q_a output

The output Q₂/Q_a can be configured either as an analog output or a switching output.

8.4.2.1 Notes on the output functions

8.4.2.1.1 4-20 mA output function

If the 4-20 mA setting is selected, output 2 functions as an analog current output. The measured value of the device is output as a proportional-linear current value that corresponds to the other device settings.

8.4.2.1.2 0-10 V output function

If the 0-10 V setting is selected, output 2 functions as an analog voltage output. The measured value of the device is output as a proportional-linear voltage value that corresponds to the other device settings.

8.4.2.1.3 Digital output function

In the case of the digital output function, output 2 functions as a switching output. Since output 1 is used exclusively for switching, this setting corresponds to the behavior of output 1. A switching signal that corresponds to the other device settings is output based on the current measured value.

8.4.2.1.4 Off output function

When the **Off** output function is activated, output 2 does not have any function and is therefore deactivated.

8.4.2.2 4-20 mA analog output

[OK] > I/O interface > [OK] > Q2/Qa output > [OK] > 4-20 mA analog output > [OK]

```
Q2/Qa Output
Analog output 4-20 mA ✓
Analog output 0-10 V
```

Parameter	Factory setting
Qa teach-in: Distance (4 mA) Distance (20 mA)	- -
Manual Qa teach-in: Distance (4 mA): -1,000.0 mm ... +1,000.0 mm Distance (20 mA): -1,000.0 mm ... +1,000.0 mm	-400.0 mm +400.0 mm

8.4.2.3 0-10 V analog output

[OK] > I/O interface > [OK] > Q2/Qa output > [OK] > 0-10 V analog output > [OK]

```
Q2/Qa Output
Analog output 4-20 mA ✓
Analog output 0-10 V
```

Parameter	Factory setting
Qa teach-in: Distance (0 V) Distance (10 V)	- -
Manual Qa teach-in: Distance (0 V): -1,000.0 mm ... +1,000.0 mm Distance (10 V): -1,000.0 mm ... +1,000.0 mm	-400.0 mm +400.0 mm

8.4.2.4 Digital output

The Q2 digital output provides the following switching modes:

- DtO, distance to object (1-point), one switching point
- Window, two switching points
- ObSB, object between sensor (device) and background, one switching point
- Q2 = Q1 not

- Alarm (only in **Advanced** user level)
- Signal level warning (only in **Advanced** user level)
- Edge height change (only in **Advanced** user level)

[OK] > I/O interface > [OK] > Q2/Qa output > [OK] > Digital output > [OK]

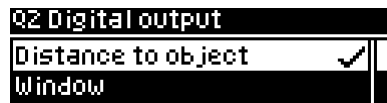

Parameter	Factory setting
Distance to object > Q2 teach-in: Q2, Q2 not	-
Distance to object > manual Q2 teach-in: -1,000.0 mm ... +1,000.0 mm	+400.0 mm
Distance to object > Q2 active status: High, Low	High
Distance to object > Q2 hysteresis: 0000.0 mm ... +0100.0 mm	+1.0 mm
Distance to object > delay mode: Off, switch-on delay, switch-off delay, switch-on/switch-off delay, 1 shot	Off
Distance to object > time for delay mode: 0000 ms ... 9,999 ms	100 ms
Window > Q2 teach-in: Switching point 1, switching point 2	-
Window > manual Q2 teach-in: Switching point 1, switching point 2	-
Window > Q2 active status: High, Low	High
Window > Q2 hysteresis: 0000.0 mm ... +0100.0 mm	+1.0 mm
Window > delay mode: Off, switch-on delay, switch-off delay, switch-on/switch-off delay, 1 shot	Off
Window > time for delay mode: 0000 ms ... 9,999 ms	100 ms
ObSB > Q2 teach-in: Q2, Q2 not	-
ObSB > manual Q2 teach-in: -1,000.0 mm ... +1,000.0 mm	+400.0 mm
ObSB > Q2 active status: High, Low	High
ObSB > Q2 hysteresis: 0000.0 mm ... +0100.0 mm	+1.0 mm
ObSB > Q2 ObSB tolerance -1,000.0 mm ... +1,000.0 mm	+4.0 mm
ObSB > delay mode: Off, switch-on delay, switch-off delay, switch-on/switch-off delay, 1 shot	Off
ObSB > time for delay mode: 0000 ms ... 9,999 ms	100 ms

8.4.2.5 Off

When the **Off** output function is activated, output 2 does not have any function and is therefore deactivated.



8.4.3 In1 input

8.4.3.1 Notes on the input functions

8.4.3.1.1 Description

The In1 input is used for the following tasks:

- Configuration of various device parameters, see "Teach-in", page 48
- Switching the laser on or off at defined times

If the function is set to **Teach** (factory setting), the specific parameters or different measured value hold functions can be configured by creating signal levels of different lengths at pin 5. If the function is set to **Laser off**, when a signal is created the laser is switched off for the duration of the created signal.

The In1 input must be active in order to be used accordingly (every setting apart from **Off**). The **Off** setting deactivates the input and, therefore, all functions.



NOTE

Deactivating the input is possible only via the display, SOPAS ET, or IO-Link, but not via the input itself.

The input behavior can be selected as normally open (High Active, factory setting) or normally closed (Low Active). When **Laser off** is used, the logic also determines whether the creation of a signal at the input causes the laser to switch off (factory setting) or on.

8.4.3.1.2 Hold function

The following hold functions are available:

- **Measured value:** Holds the measured value which is present when there is a hold input signal (rising edge).

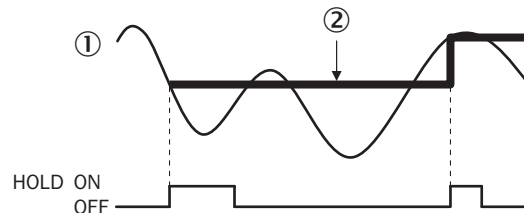

- ① Measured value
- ② Output hold value (sample hold value)

- **Peak value:** Holds the largest measured value which is present in the interval between the last falling edge and the hold input signal (next rising edge).

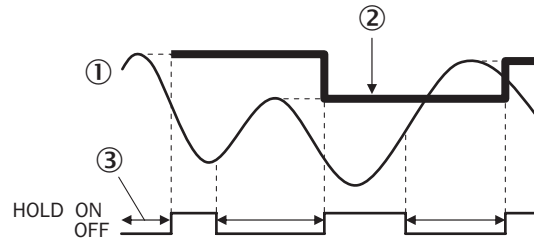

- ① Measured value
- ② Output hold value (peak hold value)
- ③ Interval in which an analysis is carried out

- Lowest value: Holds the smallest measured value which is present in the interval between the last falling edge and the hold input signal (next rising edge).

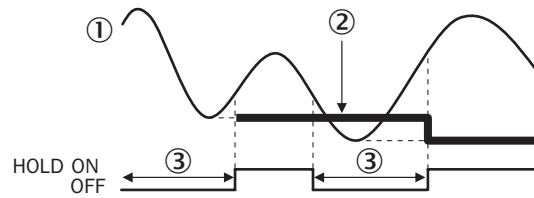

- ① Measured value
- ② Output hold value (bottom hold value)
- ③ Interval in which an analysis is carried out

- Peak-to-peak value: Holds the differential value between the smallest and the largest measured value present in the interval between the last falling edge and the hold input signal (next rising edge).

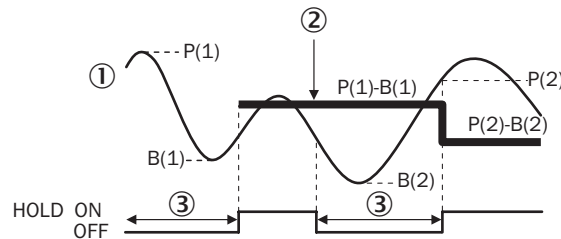

- ① Measured value
- ② Output hold value (peak-to-peak hold value)
- ③ Interval in which an analysis is carried out

- Average value: Holds the mathematical average of all measured values present in the interval between the last falling edge and the hold input signal (next rising edge).

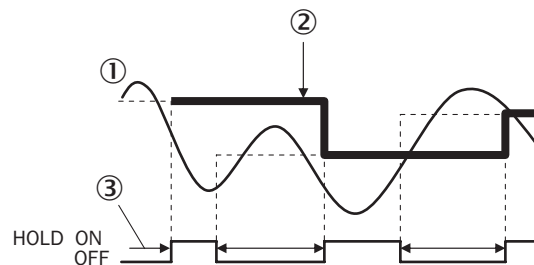

- ① Measured value
- ② Output hold value (average hold value)
- ③ Interval in which an analysis is carried out

8.4.3.1.3 Teach-in

Description

In the **Teach-in** operating mode you can use various teach functions by creating signal levels of various lengths at the In1 input.

The timing tolerance for all teach functions is +/- 20 ms.

The following functions are available:

Teach function	Time [ms]
Switching off laser	200
Switching on laser	300
Distance to object for Q ₁ : Teach Q	400
Distance to object for Q ₁ : Teach Q not	500
Switching window for Q ₁ : Teach Q near	600
Switching window for Q ₁ : Teach Q far	700
ObSB (Background) for Q ₁ : Teach Q	800
ObSB (Background) for Q ₁ : Teach Q not	900
Switching window for Q ₁ : Centering teach	1000
Distance to object for Q ₂ : Teach Q	1100
Distance to object for Q ₂ : Teach Q not	1200
Switching window for Q ₂ : Teach Q near	1300
Switching window for Q ₂ : Teach Q far	1400
ObSB (Background) for Q ₂ : Teach Q	1500
ObSB (Background) for Q ₂ : Teach Q not	1600
Switching window for Q ₂ : Centering teach	1700
Q _A with 4-20 mA for Q ₂ : Teach 4 mA	1800
Q _A with 4-20 mA for Q ₂ : Teach 20 mA	1900
Q _A with 0-10 V for Q ₂ : Teach 0 V	2000
Q _A with 0-10 V for Q ₂ : Teach 10 V	2100
Q _A (4-20 mA or 0-10 V): Centering teach	2200
Switching off teach confirmation	2300
Switching on teach confirmation	2400
Signal level warning Q ₁ : Teach Q	2500
Signal level warning Q ₁ : Teach Q not	2600
Signal level warning Q ₂ : Teach Q	2700
Signal level warning Q ₂ : Teach Q not	2800
Teaching in the zero point	2900
Laser off	> 5,000

¹ Centering limits. The near and far points that have been moved via centering must always lie within the value range limits. Moved points must always be evaluated by the user.

8.4.3.2 In1 function

Various device parameters can be configured, the laser can be switched on or off at defined times, and device functions can be activated. The debounce function can be activated or deactivated.

> I/O interface > [OK] > In1 input > [OK] > In1 function > [OK]

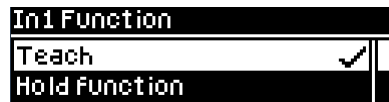

Parameter	Factory setting
Teach-in	✓
Hold function	-
Measured value offset	-
Laser off	-
Off	-

Debouncing

The debounce function is only available in the **Advanced** user level.

When debouncing is activated, the input signal must be applied constantly to input In1 for 30 ms. The timing tolerances of the external teach-in functions take into account an activation or deactivation of the debounce function. It is not necessary to adjust the timings.

> I/O interface > [OK] > In1 input > [OK] > In1 function > [OK] > Debouncing > [OK]



Parameter	Factory setting
Debouncing?: Yes, no	Yes

8.4.3.3 In1 active status

The input behavior can be selected as normally open (High Active, factory setting) or normally closed (Low Active).

[OK] > I/O interface > [OK] > In1 input > [OK] > In1 active status > [OK]



Parameter	Factory setting
High, Low	High

8.4.3.4 Teach confirmation

If the function is activated, a confirmation can be output via the switching output Q1 for each teach-in via the In1 input.

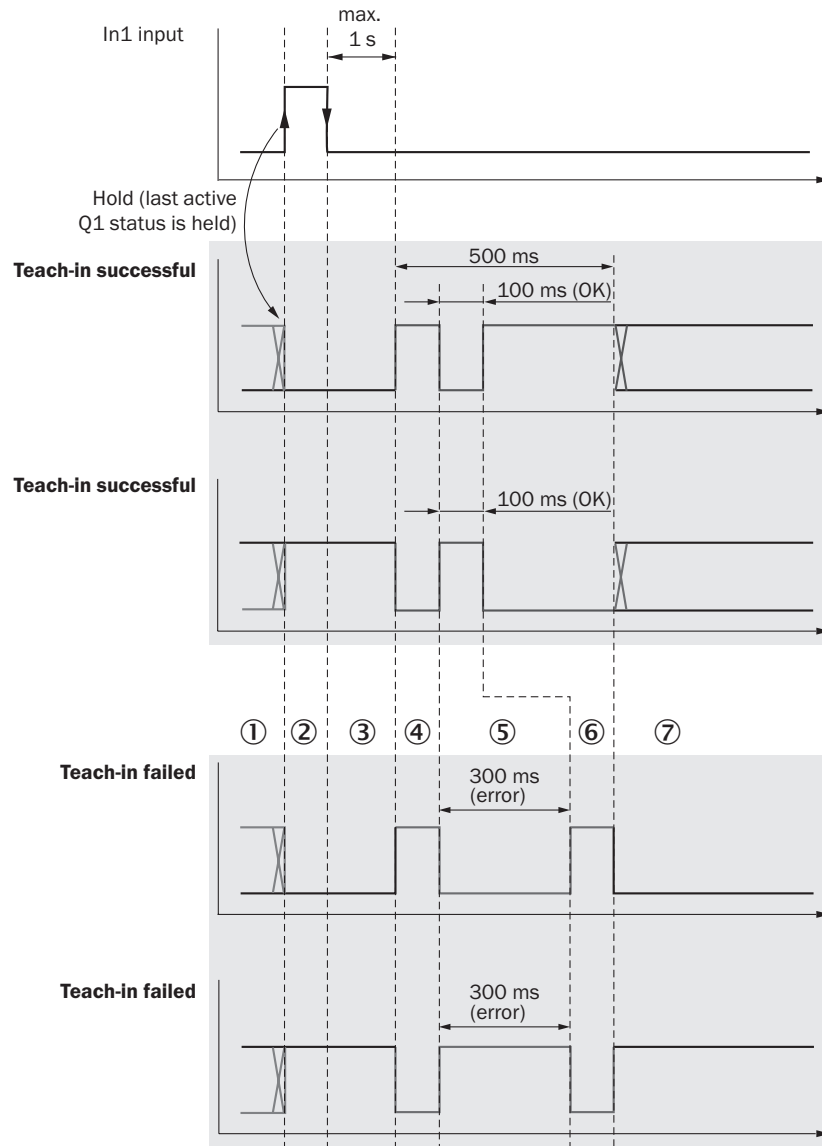
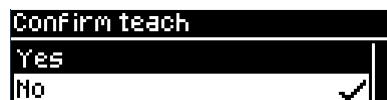

Figure 19: Teach confirmation

- ① Switching output before teach
- ② Teach request retains the last active Q₁ status in order, for example, to avoid toggling if hysteresis is too low
- ③ Teach execution time, max. 1 s
- ④ First signal edge at Q₁ after starting the teach: Initiate confirmation by inverting for 100 ms.
- ⑤ Result: OK (100 ms), error (300 ms)
- ⑥ Quit confirmation after 500 ms.
- ⑦ Return to current switching output. The switching output can be modified via a new teach point.

[OK] > I/O interface > [OK] > In1 input > [OK] > Teach confirmation > [OK]



Parameter	Factory setting
Yes, no	No

8.5 Device

8.5.1 User level

Easy / Advanced

Only certain functions are available depending on the user level set:

- Easy: frequently required functions (factory setting)
- Advanced: virtually all available functions

Changing the user level only affects operation via display and via SOPAS ET. All functions can always be used for operation and configuration via IO-Link.

[OK] > Device > [OK] > User level > [OK]

User level
Easy
Advanced ✓

Parameter	Factory setting
Easy, Advanced	Easy

8.5.2 Reset

The device can be reset to the **factory settings** or to saved **customer settings** (see "Saving customer settings", page 51).



NOTE

Upon confirmation that the device is to be reset, it carries out a warm start. During the device restarting process, the device and its function are temporarily deactivated.

[OK] > Device > [OK] > Reset > [OK] > Factory settings > [OK]

Reset
Factory settings
Customer settings

[OK] > Device > [OK] > Reset > [OK] > Customer settings > [OK]

Reset
Factory settings
Customer settings

Parameter	Factory setting
Yes, no	-

8.5.3 Saving customer settings

Once settings have been made, they can be saved as customer settings. These settings can be restored at any time via **Reset > Customer settings**.

[OK] > Device > [OK] > Save customer settings > [OK]



Parameter	Factory setting
No, yes	-

8.5.4 Language

The language of the display texts can be set.



Parameter	Factory setting
Deutsch/German, Englisch/English	Englisch/English

8.5.5 Display settings

Settings can be made for the alignment, brightness, and switch-on/switch-off behavior of the display.

Description of the parameters for the **switch display on/off** function:

- Auto: The display switches itself off if no buttons are pressed for 3 minutes. The display switches on again when a button is pressed.
- Off: The display switches itself off when the button lock is activated. If the button lock is not activated, the display switches itself off if no buttons are pressed for 3 minutes. The display switches on again when a button is pressed.
- On: The display remains permanently on (not recommended, reduces the service life of the OLED display).



Parameter	Factory setting
Switch display on/off: Auto, off, on	Auto
Display brightness: 0% ... 100%	50%
Display alignment: 0°, 180°	0°

8.5.6 Measurement laser

The measurement laser can be switched off. No measurement is possible when the laser is switched off.



NOTE

The laser can also be switched on/off via the In1 input.

[OK] > Device > [OK] > Measurement laser > [OK]

```

Device
Display settings
Measuring laser
  
```

Parameter	Factory setting
Off, on	On

8.6 Communication

I/O-Link COM selection

The IO-Link communication mode of the device can be set. Associated IODD device description files are available on the website, see www.sick.com/OD1000.

[OK] > Communication

```

Selection of I/O Link COM
COM2
COM3
  
```

Parameter	Factory setting
COM2, COM3	COM3

8.7 Info

Various types of status information are displayed for the device.

8.7.1 Firmware verification

The firmware version of the device is displayed.

[OK] > Info > [OK] > Firmware verification > [OK]

```

Info
Firmware verification
Serial number
  
```

8.7.2 Serial number

The serial number of the device is displayed.

[OK] > Info > [OK] > Serial number > [OK]

```

Info
Firmware verification
Serial number
  
```

8.7.3 Sensor operating hours

The operating hours of the device are displayed.

[OK] > Info > [OK] > Sensor operating hours > [OK]

```

Info
Operating hours sensor
Operating hours laser
  
```

8.7.4 Laser operating hours

The operating hours of the laser are displayed.

[OK] > Info > [OK] > Laser operating hours > [OK]

```

Info
-----
Operating hours sensor
Operating hours laser
    
```

8.7.5 Sensor status

Information about the status of the device is displayed.

The following data can be accessed:

- Number of errors: States the number of errors that have occurred
- Number of warnings: States the number of active warnings
- Error history: Detailed information and history of the most recent errors (max. 10)

[OK] > Info > [OK] > Sensor status > [OK]

```

Info
-----
Sensor status
Part number
    
```

Parameter	Factory setting
Number of errors, number of warnings, error history	-

8.7.6 Part number

The part number of the device is displayed.

[OK] > Info > [OK] > Part number > [OK]

```

Info
-----
Sensor status
Part number
    
```

9 Operation via IO-Link

The device can exchange process data and parameters via IO-Link. To do this, it is connected to a suitable IO-Link master.

The IO-Link interface of the device has the following properties:

Table 5: Properties of the IO-Link interface

IO-Link specification	V 1.1 V 1.0
Minimum cycle time	2.3 ms (COM2) 0.46 ms (COM3)
Transmission rate	adjustable COM2 (38.4 kBaud) COM3 (230.4 kBaud)
Process data width	16-bit outgoing (from the device to the master)
Process data type	INT (signed integer)
Parameter configuration server function (data storage)	Yes

9.1 Process data

In the factory settings, the process data telegram displays the distance value measured by the device in millimeters (16-bit width unsigned).

By configuring the parameters of the device you can change the process data format as well as resolution and offset for the distance value.

The following process data formats are available:

Table 6: Process data formats

No.	Description	Comments
1	Distance (16-bit)	Factory setting
2	Level (16-bit)	-
3	Timer (16-bit)	-
4	Edge height change (16-bit)	-
5	Distance (14-bit) + Status Q ₁ + Status Q ₂	-
6	Level (14-bit) + Status Q ₁ + Status Q ₂	-
7	Timer (14-bit) + Status Q ₁ + Status Q ₂	-
8	Edge height change (14-bit) + Status Q ₁ + Status Q ₂	-

9.2 Device data

In addition to the process data, device data (parameters, identification data, and diagnostic information) can be transmitted to and from the device. To use this function, a sensor-specific device description file (IODD) is needed in the IO-Link master.

A download package with the IODD and supplementary documentation is available at www.sick.com/OD1000.

10 Operation via SOPAS ET

Version 3.3 and higher of the SOPAS Engineering Tool (SOPAS ET) software can be used to configure the device and for service and diagnostic purposes.

The following are required to configure the device parameters using a computer:

- A computer with SOPAS ET installed and a free USB2.0-compatible port
- SICK SiLink2 Master (Order No. 1061790)
- Connection cable with M12 male and female connectors, 5-pin (e.g. Order No. 6025930)

Connect the device to the SiLink2 Master via the plug connection or an additional connection cable. Connect the SiLink2 Master to the PC using the USB cable provided and also connect the wall plug provided to the SiLink2 Master in order to ensure a sufficient voltage supply to the device.



NOTE

The most up-to-date version of the SOPAS ET software can be downloaded from www.sick.com/SOPAS_ET. The respective system requirements for installing SOPAS ET are also specified there.



NOTE

To use SOPAS ET with the device, you need a device description file (SDD) for this device. You can install this within SOPAS ET using the device catalog. An Internet connection is required to install the SDD file.

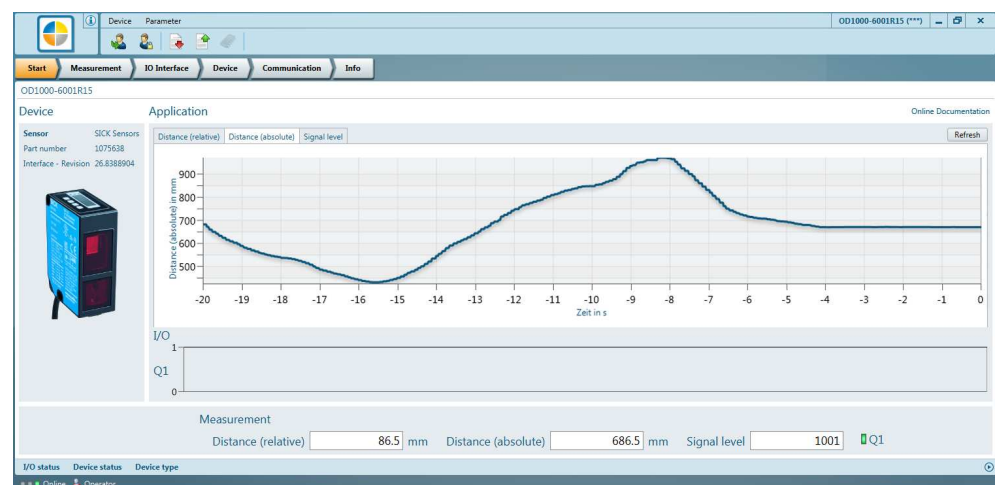

Figure 20: SOPAS ET start screen – visualization of the distance values and the output state

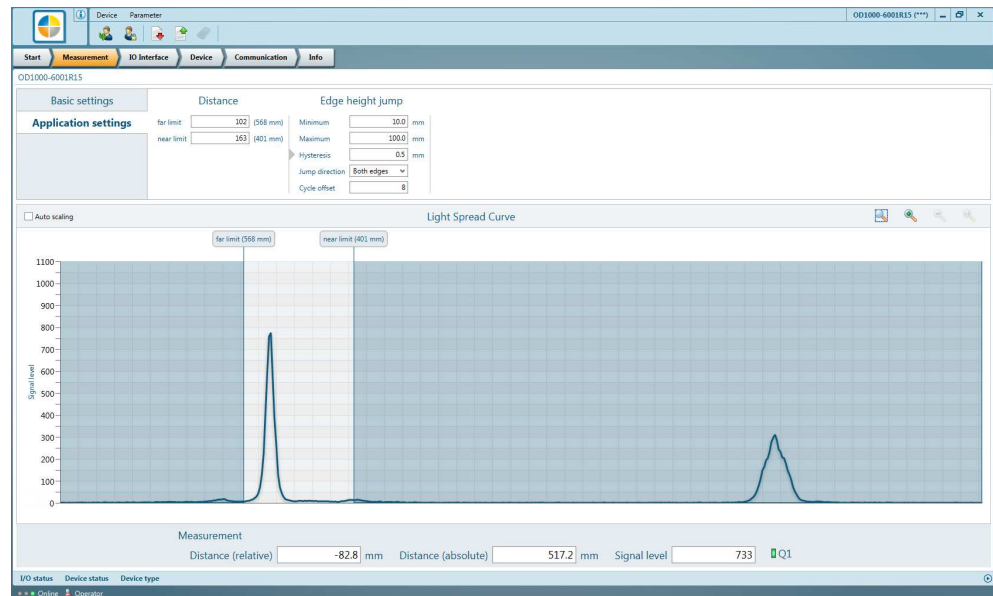

Figure 21: SOPAS ET function menus – visualization of the light distribution curve on the receiver for easy setting of the distance range



NOTE

The device immediately applies parameters that have been modified using SOPAS ET and permanently saves them. This does not require calling up a separate function.

As well as visualizing the measured values, all device functions can also be set and checked in SOPAS ET. SOPAS ET is particularly useful for configuring the distance range and edge height change functions, which are only available in the **Advanced** user level.

11 Maintenance

11.1 Cleaning



NOTICE

Equipment damage due to improper cleaning.

Improper cleaning may result in equipment damage.

- Only use recommended cleaning agents.
- Never use sharp objects for cleaning.

- ▶ Clean the front screens at regular intervals and in the event of contamination with a lint-free lens cloth (part no. 4003353) and plastic cleaning agent (part no. 5600006). The cleaning interval essentially depends on the ambient conditions.



NOTE

Static charge may cause dust particles to stick to the inspection window. This effect can be avoided by using an anti-static cleaning agent in combination with the SICK lens cloth (can be obtained from www.sick.com).

Cleaning the housing

In order to ensure that heat is adequately dissipated from the device, the housing surface must be kept clean.

- ▶ Clear the build up of dust on the housing with a soft brush.

11.2 Maintenance

During operation, the device works maintenance-free.

Depending on the assignment location, the following preventive maintenance tasks may be required for the device at regular intervals:

Table 7: Maintenance schedule

Maintenance work	Interval	To be carried out by
Clean housing and front screen	Cleaning interval depends on ambient conditions and climate	Specialist
Check the screw connections and plug connections	Every 6 months	Specialist

12 Troubleshooting

Possible faults and rectification measures are described in the table below. In the case of faults that cannot be rectified using the information below, please contact the manufacturer. See the back page for your agency.

12.1 General faults, warnings, and errors

General faults are subdivided into warnings and errors. Current measured values continue being output when there are warnings; measurement is no longer possible when there are faults.

Table 8: Troubleshooting questions and replies

Question	Reply
The device is not displaying a measurement.	Advanced application settings Check first whether the device laser is activated and whether the laser light spot is pointing at the object. Make sure that the object is within the measuring range of the device. Check the light distribution curve in SOPAS ET. This function is only available under the section in the user level. The light distribution curve shows whether the receiver element of the device is receiving light. In this case, the light distribution curve normally displays a maximum within the area shown. This graphic visualizes the remission of light onto the receiver element.
The display shows a warning triangle in the top right.	No measurement possible. Check the possible causes: Light path obscured / device not in measuring range / reflective surface.

12.2 Detecting and displaying errors

In addition to measurement errors (see ["Action in case of incorrect measurements"](#), page 36), the device can also detect and display other errors. These are output by the display, Sopas ET, or IO-Link.

In addition to measurement errors, the device can also detect and display other errors. These are output by Sopas ET, IO-Link, or via the software user interface.

Error memory

The device has an error memory where its internal error states are recorded. The last error to have occurred is always saved. The content of the error memory is retained when the device is switched off and when the **Reset > Factory settings** function is used.

Possible errors

Table 9: Explanation of the error codes

Error code	SOPAS ET hex code / device status	Meaning	Countermeasure(s)
-	- / No signal	No measurement possible	Check the measuring range, increase the cycle time setting, or reduce the distance to the object. Alternatively, contact the technical support team of the manufacturer
-	- / Laser switched off	Laser is deactivated	Activate laser
Temperature error	0x50 / Temperature error 0x10 / Temperature warning	Operating temperature undershot or exceeded	Check the ambient temperature and raise or lower it if necessary

Error code	SOPAS ET hex code / device status	Meaning	Countermeasure(s)
Laser error	0x11 / Laser warning 0x60 / Laser error 1 0x61 / Laser error 2 0x62 / Laser error 3	Laser error	Please contact the manufacturer's technical support
Internal error	0x80 / Internal error 1 0x81 / Internal error 2 0x82 / Internal error 3 0x83 / Internal error 4	Operating fault	Check the electrical environment and improve it, if necessary (stability, voltage supply, EMC influences). If the error cannot be rectified: Please contact the manufacturer's technical support.

If a different message is output, please contact the manufacturer's technical support.

12.3 Information for service cases

You should collect and write down the following device information ahead of time if you need to contact the manufacturer's service department:

- Information about the firmware version
- Information about the hardware
- Information about operating hours

This information can be accessed via SOPAS AIR.

12.4 Returns

- Do not dispatch devices to the SICK service department without consultation.



NOTE

To enable efficient processing and allow us to determine the cause quickly, please include the following when making a return:

- Details of the contact person
- Description of the application
- Description of the fault that occurred

12.5 Repairs

Repair work on the device may only be performed by qualified and authorized personnel from SICK AG. Interruptions or modifications to the device by the customer will invalidate any warranty claims against SICK AG.

12.6 Disposal



CAUTION

Risk of injury due to hot device surface.

The surface of the device can become hot during operation.

- ▶ Before commencing disassembly, switch off the device and allow it to cool down as necessary.

Any device which can no longer be used at the end of the product life cycle must be disposed of in an environmentally friendly manner in accordance with the respective applicable country-specific waste disposal regulations. Do not dispose of the product along with household waste.

**NOTICE**

Danger to the environment due to improper disposal of the device.

Disposing of devices improperly may cause damage to the environment.

Therefore, observe the following information:

- ▶ Always observe the valid regulations on environmental protection.
 - ▶ Separate the recyclable materials by type and place them in recycling containers.
-

13 Technical data



NOTE

The relevant online data sheet for your product can be downloaded, saved, and printed, including technical data, dimensions, and connection diagrams:

► www.sick.com/OD1000

13.1 Performance

Table 10: Technical data for performance

Measuring range	200 mm ... 1,000 mm ¹
Resolution	50 µm ²
Reproducibility	0.4 mm ^{2,3}
Linearity	± 1.5 mm ^{2,4}
Response time	1.5 ms ⁵
Measuring frequency	≤ 3 kHz
Light sender	Laser, red (visible, wavelength 655 nm, max. pulse output 0.78 mW, max. average power 0.39 mW, max. pulse duration 1.8 ms)
Laser class	1 (EN 60825-1:2014)
Typical light spot size	1.5 mm x 1.5 mm
Additional function	Adjustable averaging or median filter, switching mode: distance to object (DtO), window or ObSB (object between sensor (device) and background), teachable switching output, invertible switching output, teachable analog output, invertible analog output, switchable analog output mA/V, multifunctional input: laser off / external teach-in / deactivated, display switch-off, user interface lock, display can be rotated by 180°, alarm function, edge height change, time functions (ON/OFF delay), 1-shot)

¹ 6% ... 90% remission, with standard settings

² 90% remission (white), with constant ambient conditions

³ Statistical error 3 σ

⁴ For optimum performance observe min. warm-up time of 10 minutes

⁵ With measuring frequency of 3 kHz, target change white 90%/white 90%

Linearity

Typical linearity deviation in mm (inch)

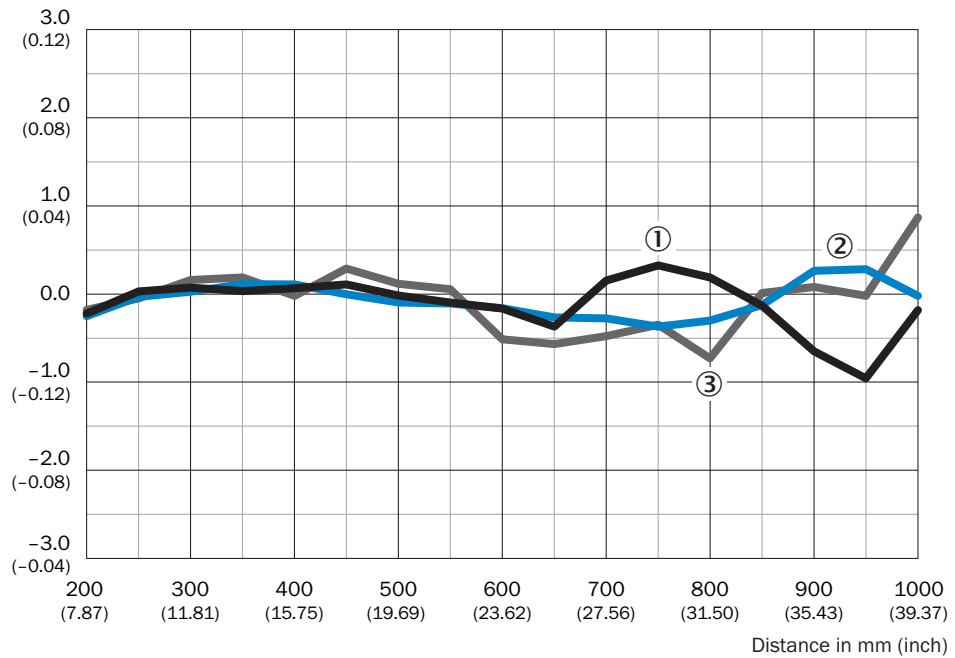

- ① Black 6 % remission
- ② White 90 % remission
- ③ Stainless steel

Figure 22: Linearity diagram

13.2 Interfaces

Table 11: Technical data for interfaces

Analog output	1x 4 mA ... 20 mA (< 600 Ω) / 1 x 0 V ... 10 V (> 20 kΩ) Resolution: 16-bit
Switching output	2 x push/pull ¹ , IO-Link
Multifunctional input (In1 input)	1 x ²
IO-Link	Function: Process data, configuration, diagnostics, data storage Data transmission rate: 230.4 kBit/s (COM3) / 38.4 kBit/s (COM2) Protocol: V 1.1 / V 1.0

- ¹ PNP: HIGH = UV- (< 3 V) / LOW = < 3 V; NPN: HIGH = < 3 V / LOW = UV
- ² Can be used as laser off, external teach-in, or deactivated

13.3 Mechanics/electronics

Table 12: Technical data for mechanics/electronics

Supply voltage U_v	DC 18 V ... 30 V ¹
Residual ripple	≤ 5 V _{ss} ²
Power consumption	≤ 2.5 W ³
Warm-up time	< 10 min
Housing material	Zinc die cast acrylic glass (PMMA), with scratch-proof coating

Connection type	20 cm cable with M12 male connector, 5-pin
Display	OLED display, 3 status LEDs
Weight	280 g
Dimensions	see "Setup and dimensions", page 12
Enclosure rating	IP 65, IP 67
Protection class	III in accordance with EN 50178

- 1 Limit values, reverse-polarity protected. Operation in short-circuit protected network: max. 8 A.
- 2 May not fall short of or exceed U_V tolerances
- 3 Without load, at +20 °C

13.4 Ambient data

Table 13: Ambient data

Ambient operating temperature	-10 °C ... +50 °C ¹
Storage temperature	-20 °C ... +60 °C
Temperature drift	0.15 mm/K
Typ. ambient light immunity	Artificial light: ≤ 3,000 lx ² Sunlight: ≤ 10,000 lx
Vibration resistance	EN 60068-2-6 / EN 60068-2-64
Shock resistance	EN 60068-2-27

- 1 At $U_V = 24 V$
- 2 With constant object movement in the measuring range

14 Accessories

14.1 Accessories

**NOTE**

Accessories and where applicable mounting information can be found online at:

▶ www.sick.com/OD1000

15 Annex

15.1 EU declaration of conformity / Certificates

The EU declaration of conformity and other certificates can be downloaded from the Internet at:

- www.sick.com/OD1000

15.2 Licenses

SICK uses open-source software. This software is licensed by the rights holders using the following licenses among others: the free licenses GNU General Public License (GPL Version2, GPL Version3) and GNU Lesser General Public License (LGPL), the MIT license, zLib license, and the licenses derived from the BSD license.

This program is provided for general use, but WITHOUT ANY WARRANTY OF ANY KIND. This warranty disclaimer also extends to the implicit assurance of marketability or suitability of the program for a particular purpose.

More details can be found in the GNU General Public License. View the complete license texts here: www.sick.com/licensetexts. Printed copies of the license texts are also available on request.

Australia

Phone +61 3 9457 0600
1800 334 802 - tollfree
E-Mail sales@sick.com.au

Austria

Phone +43 22 36 62 28 8-0
E-Mail office@sick.at

Belgium/Luxembourg

Phone +32 2 466 55 66
E-Mail info@sick.be

Brazil

Phone +55 11 3215-4900
E-Mail marketing@sick.com.br

Canada

Phone +1 905 771 14 44
E-Mail information@sick.com

Czech Republic

Phone +420 2 57 91 18 50
E-Mail sick@sick.cz

Chile

Phone +56 2 2274 7430
E-Mail info@schadler.com

China

Phone +86 20 2882 3600
E-Mail info.china@sick.net.cn

Denmark

Phone +45 45 82 64 00
E-Mail sick@sick.dk

Finland

Phone +358-9-2515 800
E-Mail sick@sick.fi

France

Phone +33 1 64 62 35 00
E-Mail info@sick.fr

Germany

Phone +49 211 5301-301
E-Mail info@sick.de

Hong Kong

Phone +852 2153 6300
E-Mail ghk@sick.com.hk

Hungary

Phone +36 1 371 2680
E-Mail office@sick.hu

India

Phone +91 22 4033 8333
E-Mail info@sick-india.com

Israel

Phone +972 4 6881000
E-Mail info@sick-sensors.com

Italy

Phone +39 02 274341
E-Mail info@sick.it

Japan

Phone +81 3 5309 2112
E-Mail support@sick.jp

Malaysia

Phone +6 03 8080 7425
E-Mail enquiry.my@sick.com

Mexico

Phone +52 472 748 9451
E-Mail mario.garcia@sick.com

Netherlands

Phone +31 30 2044 000
E-Mail info@sick.nl

New Zealand

Phone +64 9 415 0459
0800 222 278 - tollfree
E-Mail sales@sick.co.nz

Norway

Phone +47 67 81 50 00
E-Mail sick@sick.no

Poland

Phone +48 22 539 41 00
E-Mail info@sick.pl

Romania

Phone +40 356 171 120
E-Mail office@sick.ro

Russia

Phone +7 495 775 05 30
E-Mail info@sick.ru

Singapore

Phone +65 6744 3732
E-Mail sales.gsg@sick.com

Slovakia

Phone +421 482 901201
E-Mail mail@sick-sk.sk

Slovenia

Phone +386 591 788 49
E-Mail office@sick.si

South Africa

Phone +27 11 472 3733
E-Mail info@sickautomation.co.za

South Korea

Phone +82 2 786 6321
E-Mail info@sickkorea.net

Spain

Phone +34 93 480 31 00
E-Mail info@sick.es

Sweden

Phone +46 10 110 10 00
E-Mail info@sick.se

Switzerland

Phone +41 41 619 29 39
E-Mail contact@sick.ch

Taiwan

Phone +886 2 2375-6288
E-Mail sales@sick.com.tw

Thailand

Phone +66 2645 0009
E-Mail Ronnie.Lim@sick.com

Turkey

Phone +90 216 528 50 00
E-Mail info@sick.com.tr

United Arab Emirates

Phone +971 4 88 65 878
E-Mail info@sick.ae

United Kingdom

Phone +44 1727 831121
E-Mail info@sick.co.uk

USA

Phone +1 800 325 7425
E-Mail info@sick.com

Vietnam

Phone +84 945452999
E-Mail Ngo.Duy.Linh@sick.com

Further locations at www.sick.com