

NT11

Programmable Terminal

USER'S MANUAL

OMRON

NT11 Programmable Terminal

User's Manual

Produced January 2004

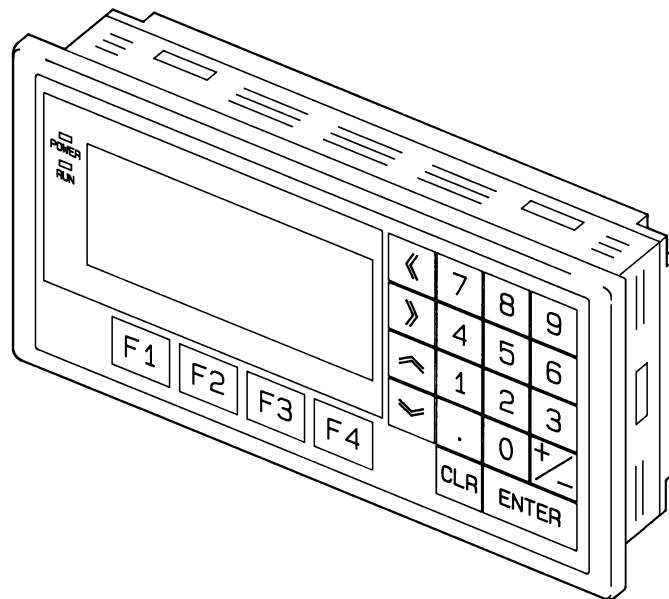



Notice:

OMRON products are manufactured for use according to proper procedures by a qualified operator and only for the purposes described in this manual.

The following conventions are used to indicate and classify precautions in this manual. Always heed the information provided with them. Failure to heed precautions can result in injury to people or damage to property.

 **DANGER** Indicates an imminently hazardous situation which, if not avoided, will result in death or serious injury.

 **WARNING** Indicates a potentially hazardous situation which, if not avoided, could result in death or serious injury.

 **Caution** Indicates a potentially hazardous situation which, if not avoided, may result in minor or moderate injury, or property damage.

OMRON Product References

All OMRON products are capitalized in this manual. The word “Unit” is also capitalized when it refers to an OMRON product, regardless of whether or not it appears in the proper name of the product.

The abbreviation “Ch,” which appears in some displays and on some OMRON products, often means “word” and is abbreviated “Wd” in documentation in this sense.

The abbreviation “PLC” means Programmable Controller. “PC” is used, however, in some Programming Device displays to mean Programmable Controller.

“Host” means a personal computer that controls the NT11.

Visual Aids

The following headings appear in the left column of the manual to help you locate different types of information.

Note Indicates information of particular interest for efficient and convenient operation of the product.

1,2,3... 1. Indicates lists of one sort or another, such as procedures, checklists, etc.

© OMRON, 2004

All rights reserved. No part of this publication may be reproduced, stored in a retrieval system, or transmitted, in any form, or by any means, mechanical, electronic, photocopying, recording, or otherwise, without the prior written permission of OMRON.

No patent liability is assumed with respect to the use of the information contained herein. Moreover, because OMRON is constantly striving to improve its high-quality products, the information contained in this manual is subject to change without notice. Every precaution has been taken in the preparation of this manual. Nevertheless, OMRON assumes no responsibility for errors or omissions. Neither is any liability assumed for damages resulting from the use of the information contained in this publication.

TABLE OF CONTENTS

PRECAUTIONS	xi
1 Intended Audience	xii
2 General Precautions	xii
3 Safety Precautions	xii
SECTION 1	
Functions of the NT11	1
1-1 Getting Starting	2
1-2 Role and Operation of NT11	2
1-3 Functions of NT11	4
1-4 System Configuration	8
1-5 Direct Connection Function	9
1-6 Before Operating	12
SECTION 2	
Hardware Settings and Connections	15
2-1 Description of Parts and Settings	16
2-2 Installation	19
2-3 Connecting to the NT Support Tool	22
2-4 Connection to a PLC by the Host Link (RS-232C Type)	22
2-5 Connection to a PLC by the Host Link (RS-422A Type)	38
2-6 Connection to a PLC by the NT Link (RS-232C Type)	50
2-7 Connection to a PLC by the NT Link (RS-422A Type)	55
2-8 Connecting a Printer	57
SECTION 3	
System Menu Operation	59
3-1 Operation Flow by the System Menu	60
3-2 Starting the NT11	60
3-3 Operation Modes and the System Menu	61
3-4 Initializing Memory	64
3-5 Transferring the System Program	66
3-6 Registering the Screen Data	69
3-7 Setting the Conditions of Communications with the PLC by Using the Memory Switches	71
3-8 Starting the Operation	77
3-9 Backlight OFF	78
3-10 System Maintenance	80

TABLE OF CONTENTS

SECTION 4

NT11 Functions	85
4-1 Outline of Functions	86
4-2 Screen Display	87
4-3 Areas for Control/Notification	89
4-4 Memory Tables	94
4-5 Bar Graphs	96
4-6 Numeral Setting	97
4-7 Menu Screen Function	99
4-8 Password Screen Display Function	100
4-9 Display History Screen Function	101
4-10 Daily Report/Display History Printing Function	102

SECTION 5

Using Host Link/NT Link	107
5-1 Screen Creation Procedure	108
5-2 Outline of Host Link/NT Link Operation	109
5-3 Memory Table Entries and Bar Graph	115
5-4 Numeral Setting	126
5-5 NT11 Status Control	129
5-6 Notification of the Operating Status to the PLC (Determining the NT11 Operating Status)	132

SECTION 6

Troubleshooting and Maintenance	135
6-1 Troubleshooting	136
6-2 Responding to Displayed Error Messages	138
6-3 Inspection and Cleaning	142

Appendices

A Specifications	145
B Dimensions	149
C Transporting and Storing the NT11	151
D Making the Cable	153
E Making the Cable for Connecting a Personal Computer	155
F NT11 Internal Processing	157
G Model List	159
H Special Characters	163

Index	165
--------------------	------------

Revision History	169
-------------------------------	------------

About this Manual:

This manual describes the basic functions and operation procedures of the NT-series programmable terminal NT11, its operations when connected to a PLC, and includes the sections described below.

Please read this manual carefully and be sure you understand the information provided before attempting to install and operate the NT-series programmable terminal NT11.

Section 1 describes the operation functions, system configuration, and the direct connection function of the NT11.

Section 2 describes the hardware settings, installation to an operation panel, connection to optional devices and PLC.

Section 3 describes the operation of the System Menu and the maintenance of the NT11.

Section 4 describes the functions of the NT11 when it is connected to a PLC.

Section 5 describes how to use the NT11 when it is connected to the PLC using the host link or NT link.

Section 6 describes the procedures to follow when the NT11 does not operate correctly.

APPENDIX describes the specifications and the method for making connecting cables, and includes an area list for the PLC.



WARNING Failure to read and understand the information provided in this manual may result in personal injury or death, damage to the product, or product failure. Please read each section in its entirety and be sure you understand the information provided in the section and related sections before attempting any of the procedures or operations given.

Related Manuals and Their Contents:

The related manuals are listed below.

The □ symbol at the end of the manual number is the revision history symbol.

[Operating the programmable terminal and communicating with the host]

- NT11 Programmable Terminal User's Manual (V084-E1-□)

----- This manual

This user's manual is the manual for the NT11-V□ itself.

The NT11 is a unit which integrates a programmable terminal body. This user's manual describes the functions and handling of the programmable terminal body.

[Creating and transferring screen data]

- NT-series Support Tool Operation Manual (V061-E1-□)

The screens displayed on the NT11 are created with the support tool and transferred to the NT11. This manual describes how to create and transfer screen data.

PRECAUTIONS

This section provides general precautions for using the Programmable Terminal.

The information contained in this section is important for the safe and reliable application of the Programmable Terminal. You must read this section and understand the information contained before attempting to set up or operate a Programmable Terminal.

1	Intended Audience	xii
2	General Precautions	xii
3	Safety Precautions	xii

1 Intended Audience

This manual is intended for the following personnel, who must also have knowledge of electrical systems (an electrical engineer or the equivalent).

- Personnel in charge of introducing FA systems into production facilities.
- Personnel in charge of designing FA systems.
- Personnel in charge of installing and connecting FA systems.
- Personnel in charge of managing FA systems and facilities.

2 General Precautions

The user must operate the product according to the performance specifications described in the user's manuals.

Before using the product under conditions that are not described in the manual or applying the product to nuclear control systems, railroad systems, aviation systems, vehicles, combustion systems, medical equipment, amusement machines, safety equipment, and other systems, machines and equipment that may have a serious influence on lives and property if used improperly, consult your OMRON representative.

Make sure that the ratings and performance characteristics of the product are sufficient for the systems, machines, and equipment, and be sure to provide the systems, machines, and equipment with double safety mechanisms.

This manual provides information for using the Programmable Terminal. Be sure to read this manual before attempting to use the software and keep this manual close at hand for reference during operation.

 **WARNING** It is extremely important that Programmable Terminals and related devices be used for the specified purpose and under the specified conditions, especially in applications that can directly or indirectly affect human life. You must consult with your OMRON representative before applying Programmable Terminals to the above-mentioned applications.

 **WARNING** Do not use input functions such as PT touch switches for applications where danger to human life or serious damage is possible, or for emergency switch applications.

3 Safety Precautions

Read these safety precautions carefully and make sure you understand them before using the Programmable Terminal so that you can use it safely and correctly.

Safety Conventions and their Meanings

This user's manual uses the following conventions and symbols to indicate cautions, warnings, and dangers in order to ensure safe use of the NT11. The cautions, warnings, and dangers shown here contain important information related to safety. The instructions in these cautions, warnings, and dangers must be observed.

The conventions used and their meanings are presented below.

 **WARNING** Indicates information that, if not heeded, could possibly result in loss of life or serious injury.

Caution Indicates information that, if not heeded, could result in relatively serious or minor injury, damage to the product, or faulty operation.

 **WARNING**

Do not attempt to take the Unit apart and do not touch any internal parts while the power is being supplied. Doing either of these may result in electrical shock.



SECTION 1

Functions of the NT11

NT11 is a new programmable terminal (PT) which incorporates a host interface unit in a programmable terminal body. It can be easily installed and used.

This section gives the operation examples and characteristics of the NT11 so that you will understand the applications of the NT11.

1-1	Getting Starting	2
1-2	Role and Operation of NT11	2
1-2-1	Operations of NT11	3
1-3	Functions of NT11	4
1-3-1	Features	4
1-3-2	Principal Functions of NT11	5
1-3-3	Displays	6
1-3-4	System Keys	7
1-4	System Configuration	8
1-4-1	Peripheral Devices That Can Be Connected	8
1-5	Direct Connection Function	9
1-5-1	NT Link	9
1-5-2	Functions of the Allocated Bits and Words	10
1-6	Before Operating	12

1-1 Getting Starting

To ensure that the NT11 works correctly, carefully observe the following when installing and handling it.

Location

Do not install the NT11 in a location subject to the following conditions;

- Near a computer, radio transmitter or receiver, etc.
- Dust, chemicals, or steam
- Severe temperature fluctuations
- High humidity and condensation
- Strong electrical or magnetic fields
- Poor ventilation
- Severe vibration

Handling

Do not;

- Subject the NT11 to strong shocks or vibrations
- Put heavy objects on the NT11
- Supply a voltage different from the specified voltage
- Disassemble or modify the NT11

Cautions on Cleaning

To clean the front panel, use a soft, dry cloth. If it is very dirty, use diluted (2%) neutral detergent.

Do not use volatile solvents such as benzene, thinner, or a chemically treated cloth. Their use will cause deformation or discoloration.

Cautions on Afterimage

If the same screen contents are kept displayed for a long time, an afterimage may occur. To prevent this problem, either set the afterimage prevention function or make a program which periodically changes the displayed screen.

Cautions on Operating the System Keys

Do not operate the system keys with sharply pointed objects, such as your fingernails or a screwdriver.

This could break the film.

1-2 Role and Operation of NT11

NT11 is a programmable terminal used to display and transmit the information in an FA site. The following gives a general description of the role and operation of the NT11 for those who use a programmable terminal (PT) for the first time.

Production Line Status Monitoring

The NT11 displays real-time information about the system and equipment operating status, etc.

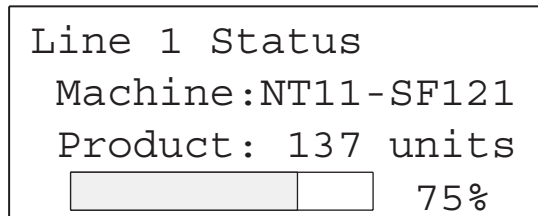

Messages

The NT11 warns of system or equipment failures and prompts the appropriate remedial action.

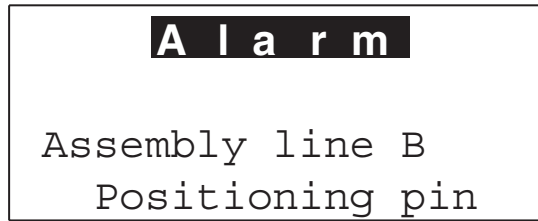

Panel Switch Functions

The NT11 can be used in place of external data input equipment such as an operation panel, to transmit data to a PLC.

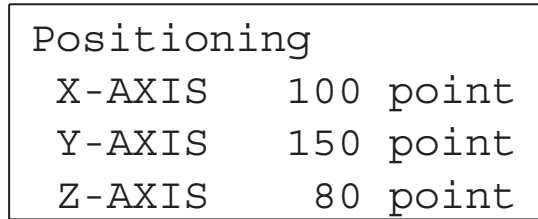

1-2-1 Operations of NT11

Displays Screens

The information to be displayed (screen data) can be created on a computer by using support tools and stored in the NT11. The screen data can be displayed on the NT11 in response to the instructions from a PLC or system keys operation.

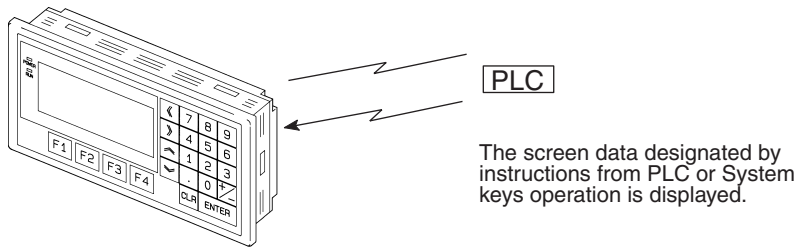

Receives Data from a PLC

NT11 can be connected to a PLC by a host link or NT link and receive necessary data from the PLC.

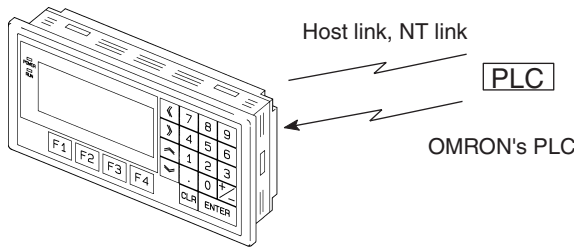

Sends Data to a PLC

Data input through a numeric key can be sent to a PLC.

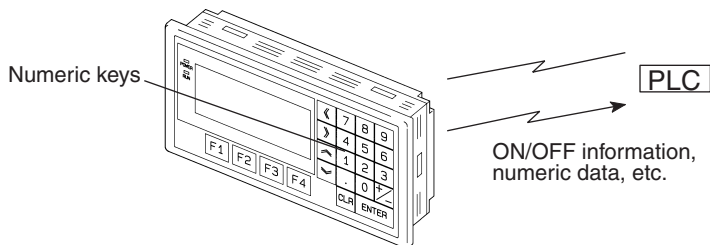

Screen Data

The screen data to be displayed on the NT11 can be created by a computer by using support tools. Connect the NT11 to an IBM PC/AT or compatible with an RS-232C cable so that the screen data are transferred to the NT11.

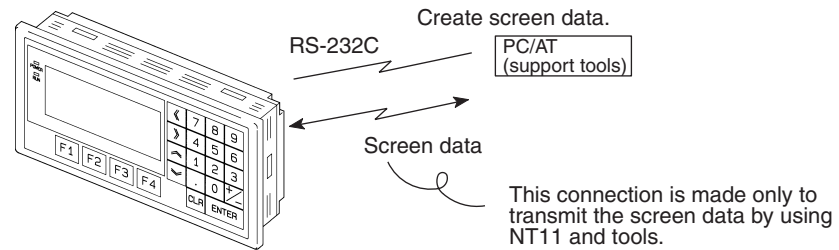

1-3 Functions of NT11

The NT11 has the following features and functions;

1-3-1 Features

Downsized Body

- The NT11 has the thinnest depth (31 mm or less in the panel) in the NT series.
- It is very compact, with a width of 218 mm and a height of 113 mm.
- Features three ports: for RS-232C, RS-422A, and printer output.
- The tool connectors and the PLC communication connectors are used in common.

Construction Best Suited to the FA Environment

- Easy-to-read screen even in direct sunlight.
- Waterproofed to a standard equivalent to IP65 and NEMA4.

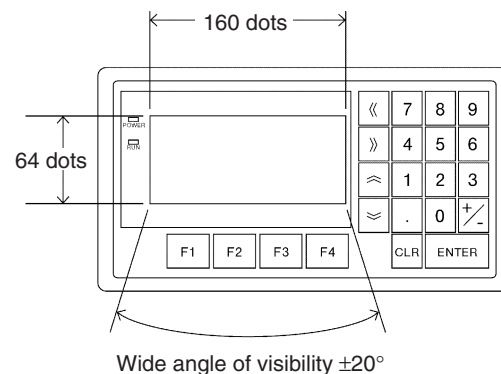

A Host I/F Unit, Screen Data Memory, and a system program transfer ROM are All Incorporated

- There is no complicated installation work except a simple connection to a PLC.
- A flash memory is used for the screen data memory. There is no need of backup battery.
- A host link (direct), and an NT link are standard equipment.

1-3-2 Principal Functions of NT11

Functions Related to the Data Display

- Character display
Characters of standard and double-width can be displayed. Characters can flash or be highlighted.
- Memory data display
Contents of the character-string memory table and the numeral memory table can be displayed. The memory table contents can be changed from the PLC.
- Bar graph display
Bar graphs corresponding to the contents of the numeral table can be displayed.

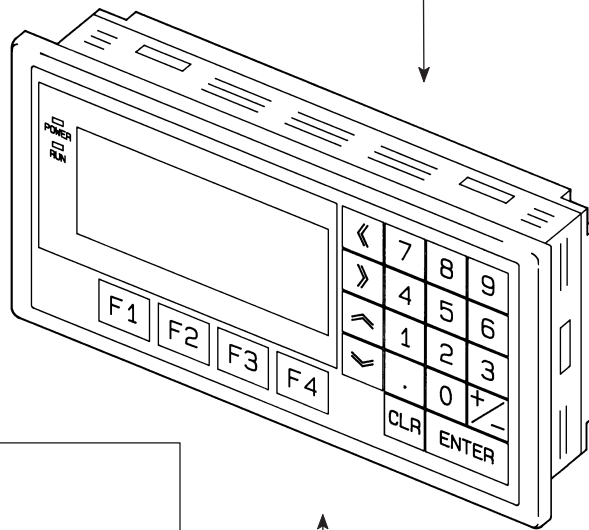

Functions Related to the Data Input

- Input by the system key
Data can be input, and the displayed screen changed, by using the numeric keys, function keys, and arrow keys on the panel of the NT11.
- Numeric setting function
The numeric values can be input at the operation site by the system key and sent to the PLC.

Other Functions

- Communications with a PLC
The host link, NT link is used to connect to a PLC for data communication.
- System function
The system setting and maintenance can be executed by using the System Menu on the screen.
- Screen data creation
The screen data can be created by using support tools on the computer and stored in the unit.

1-3-3 Displays

The NT11 can display elements such as characters, numeric value, and bar graphs on a screen. The screen data displayed on the NT11 are created by using support tools on a computer.

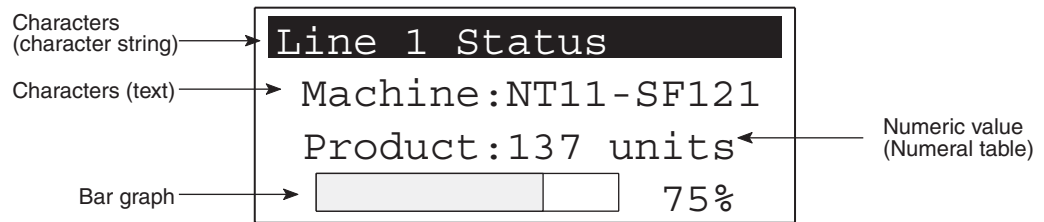

Characters (text) Characters and marks which do not need to be changed can be written directly to the screen.

Characters (character-string memory table) Character-strings stored in the character-string memory table are displayed. The display characters can be changed by changing the data stored in the character-string memory table.

Numeric Values (numeral memory table) Numbers stored in the numeral memory table are displayed. The display numbers can be changed by changing the data stored in the numeral table. Hexadecimal values can also be displayed.

Bar Graphs The bar graph extends and contracts in proportion to the data stored in the numeral memory table. A percentage value can also be displayed simultaneously.

Marks Marks can be designed, created, and handled like characters by the user.

Comparison with the NT11S

	Model	NT11	NT11S
Basic performance	Dimensions	218 x 113 x 38.2 mm (W x H x D)	
	Resolution	160 x 64 dots (4.24 inches)	
	Effective display area	100 x 40 mm	
	Display color	Black & white (with yellow mode)	
	Panel cut-out size (W x H)	204.2 x 98.8 mm	
	Max. number of registered screens	250	
	Screen data capacity	32 KB	
	Function keys	4	
	Other Keys	Numeric Keys, Cursor Keys, Function Keys	
	Special functions	Emergency transfer mode*	DIP switch pin 3
Backlight service life		50,000 hours min.	10,000 hours min.
Communications	Host Link Speed	Up to 115,200	9,600/19,200
	Compatibility (Screen data types that can be used.)	NT11-V1, NT11S	NT11S

* Emergency transfer mode: When power to the NT11 is turned ON with DIP switch pin 3 turned ON, data transfer mode will be entered directly without any other operation.

1-3-4 System Keys

The NT11 has system keys on its panel for input functions.

The system keys are used for inputting numerical values and for notifications to the PLC.

The system keys can be classified into the three types shown below.

- Numeric keys
- Arrow keys
- Function keys

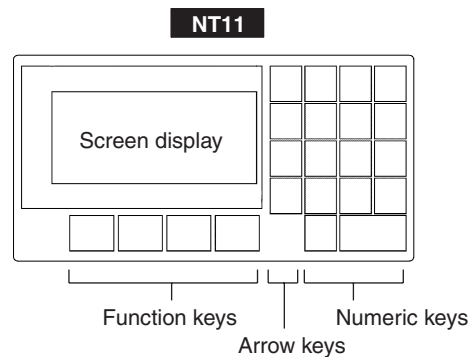

- **Numeric keys**
These are the numeral keys from [0] to [9], the decimal point key [.] , the sign key [+/-], the [CLR] key and the [ENTER] key. These keys are used for inputting numerical values.
- **Arrow keys**
Used to select the required numerical value input field when there is more than one on the screen.
- **Function keys**
Used for notifications from the NT11 to the PLC.
Also used to switch between the RUN mode and the system menu when the power is switched on.

⚠ Caution Do not use input functions such as PT function keys for applications where danger to human life or serious property damage is possible, or as the emergency stop switch.

⚠ Caution If function keys are pressed in rapid succession, their inputs may not be successfully received. Confirm that the input of a function key has been successfully received before moving on to the next operation.

⚠ Caution Do not press function keys carelessly while the backlight is off or while nothing is displayed on the screen. Otherwise the system may operate unpredictably. Only press function keys after confirming system safety.

1-4 System Configuration

This section shows the configuration of a system that uses an NT11. For details on product models, refer to *Appendix G Model List* (page 159).

1-4-1 Peripheral Devices That Can Be Connected

The following peripheral devices can be connected to an NT11.

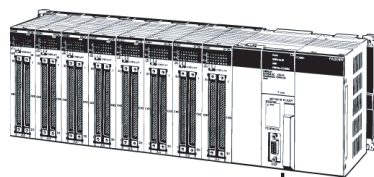

RS-232C cable
(15 m max.)
An RS-422A/485 cable
(500 m max.) can be
connected through an
RS-232C/RS-422A
Adapter.

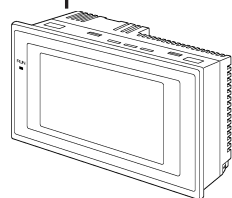

NT11

Displays production line monitoring and commands to the operation site, and notifies the switch ON/OFF status and numeric value inputs to the host.

Host

Controls the NT11 as required while controlling machines and monitoring the production line.

Host Link: CS-series/CJ-series/C-series PLCs, CVM1/CV-series PLCs, SRM1
Can be connected to CPU Units, Host Link Units, and SRM1. However, connection is not possible to some models of CPU Unit and SRM1 (pages 23 and 39).

NT Link: C-series PLCs, CVM1/CV-series PLCs, SRM1
Can be connected to CPU Units and SRM1. However, connection is not possible to some models (pages 51 and 55).

Personal computer

Running Windows 95, 98,
NT, 2000, Me, XP

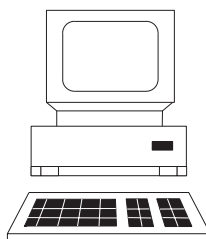

NT Support Tool

Used to create screens for the NT11 at the personal computer and transfer them to the NT11, and to make NT11 settings.

System installer

Used to change the system program of the NT11.

- NT Support Tool (page 22)
NT-series Support Tool Version 4.7 for Windows (Made by OMRON)
 - NT-ZJCAT1-EV4.7 (CD-ROM version for IBM PC/AT or compatible computers)
- System installer (page 22)
System Installer (made by OMRON)
The System Installer is supplied as a standard accessory with the NT Support Tool (NT-ZJCAT1-EV4.7).

1-5 Direct Connection Function

The communication method applied between the NT11 and the PLC is either a host link or NT link.

The NT11 can be used to refer to the contents necessary for the display information or to allocate the bits and words used for storing the input data to any area in the PLC. The NT11 can directly write and read such allocated bits and words so as to change the display elements, control the operating status, and notify the status.

This function is called the “direct connection function”. The NT11 is designed exclusively for use with the direct connection.

The bits and words allocated by the direct connection function are called “allocated bit” and “allocated word” respectively.

This function allows to read the information to be displayed on the NT11 from the memory area in the PLC and to write it to the memory table in the NT11. Also, the data input on the NT11 can be written to the PLC’s memory area. The NT11 screen status can be switched according to the PLC’s memory area, and the NT11’s status data can be written to the PLC’s memory area.

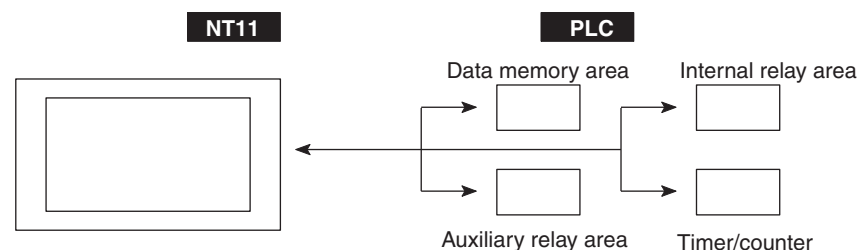

Features of the Direct Connection Function

- The bits and words referring to operating status and work instruction information and those for storing input data can be freely allocated to almost any part of the PLC memory. Bits and words in the PLC can be referenced from any memory table.
- The NT11 can directly refer to PLC bit and word data so that it can be connected to a PLC without changing the PLC program which controls currently running production line.
- The area to control and notify the NT11 status, including display screens, ON/OFF of the backlight, and printing of daily reports and display histories, can be freely allocated to any part of the PLC memory.

The direct connection function allows the NT11 to directly read and write almost all bits and words in the PLC and to automatically change the NT11 screen display. This function can reduce the load on the PLC so that the program development efficiency of the PLC improves.

1-5-1 NT Link

The NT link is a new communication method applied between the NT11 and a PLC.

The NT link uses the direct connection function and can execute high speed communications with a CPU (built-in NT link) of the CQM1, C200HS, and other PLCs.

Features of the NT Link

- High speed communications with specific types of PLCs can be executed.
- Writing in units of bits to the PLC memory area is possible. (*)

- This can be used even when the PLC is in the RUN mode.
 (*) Except a DM area.

The NT link is compatible with the host link. The NT11 screen data and the PLC programs handled by the host link direct connection can be used with for the NT link as they are.

1-5-2 Functions of the Allocated Bits and Words

Elements displayed on the NT11 and the NT11 status can be allocated to the bits and words of the PLC. By changing the contents of the bits and words, the NT11 can be controlled by the PLC. It is also possible to send data to the PLC by pressing the function keys on the panel of the NT11.

- Controlling the NT11 by a PLC

The following NT11 functions can be controlled by a PLC.

- Screens: Display of designated screens, confirmation of screen numbers, etc.
- Memory tables: Writing to a memory table, copying from a memory table to another memory table, etc.
- System control: ON/OFF of backlight, control of output of daily reports and display histories at a printer.

- Notifying from the NT11 to a PLC

Data in the NT11 is sent to a PLC when a numeric key is pressed. The following types of data are sent to a PLC.

- NT11 status
- Password input status
- Numeric values input by the numeral keys
- Function key input status

Functions of Display Elements

- Numeral memory table
 Allocation destination: Word

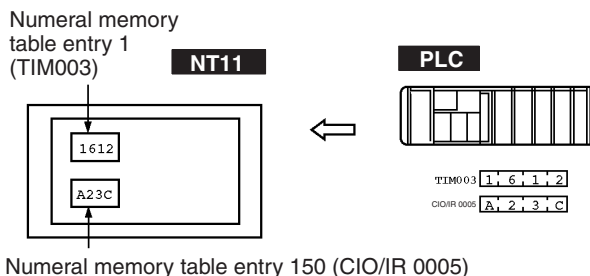

Allocate numeral memory table entries to arbitrary words in the PLC. If word contents change when corresponding numeral memory table entry is displayed on the screen, the value on the screen will also change. Monitoring of words can also be made easily.

Reading and writing are executed so that the contents of allocated words are always the same as those of the numeral memory table entries.

- Character-string memory table
Allocation destination: Word

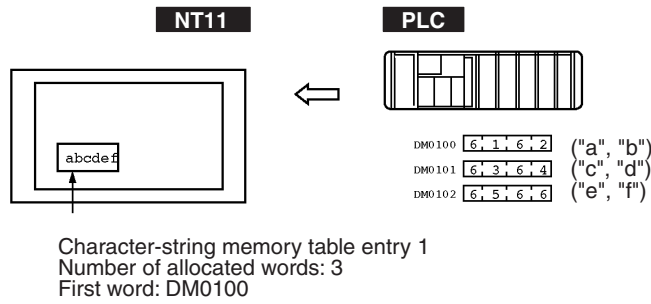

Allocate character-string memory table entries to arbitrary words in the PLC. If word contents change when corresponding character-string memory table entry is displayed on the screen, the value on the screen will also change. Messages can be displayed easily.

Reading and writing are executed so that the contents of allocated words are always the same as those of the character-string memory table entries.

Functions of the PT Status Control Area (PLC to NT11)

The “PT status control area” is used to control the NT11 status. When data is written to this area in the PLC, the NT11 reads the contents and operates according to the contents.

[Example of the PT status control area application]

When data is written to the PT status control area, the NT11 will operate as given below.

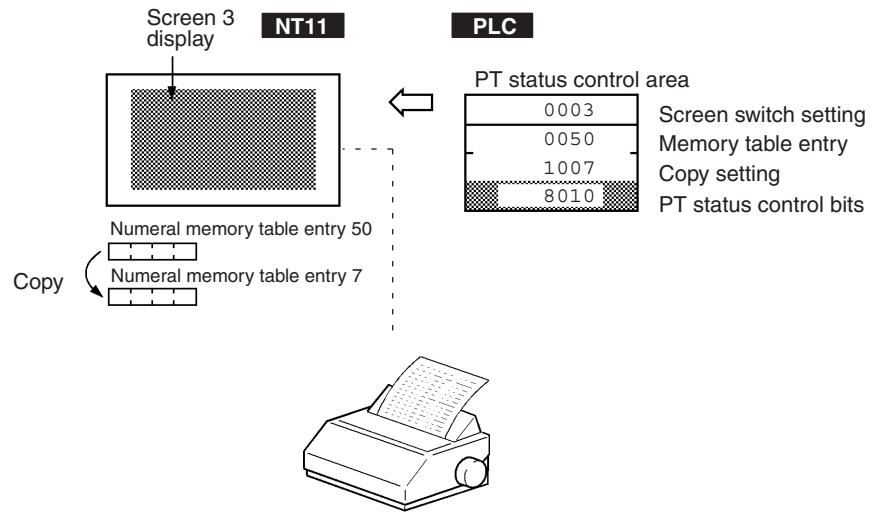

Printing of daily reports or display histories

Functions of the PT Status Notify Area (NT11 to PLC)

The “PT status notify area” is used to notify the changes of the NT11 status. When a change is made in the NT11 status, the change is written to this area in the PLC. By reading the data from the area, the NT11 status can be checked.

[Example of the PT status notify area application]

When a change is made in the NT11 status, such change will be notified to the PT status notify area as mentioned below.

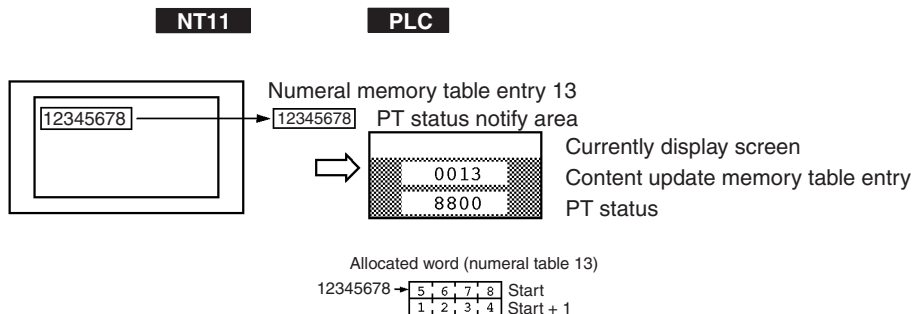

1-6 Before Operating

Follow the procedure given below to start the system of the NT11.

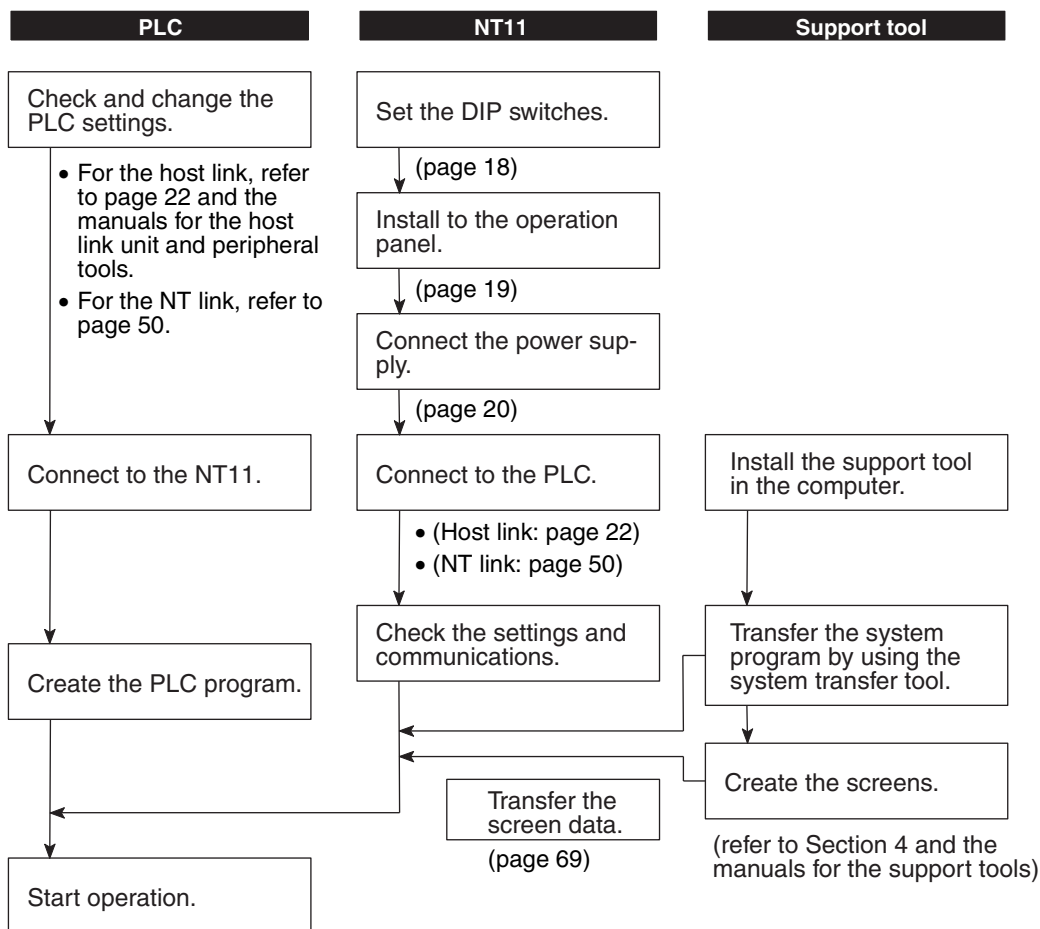

Reference Use support tool NT-series Support Tool (NT-ZJCAT1-EV4.7).

⚠ Caution Carefully check the operation of all screen data and host programs before using them.
Otherwise the system may operate unpredictably.

Refer to the following manuals for the equipment and software.

Device or Software	Manual Title	Cat. No.
NT11	User's Manual	V084-E1-□
System Installer	NT-series Support Tool for Windows (Ver. 4.7) Operation Manual	V061-E1-□
NT Support Tool	NT-series Support Tool for Windows (Ver. 4.7) Operation Manual	V061-E1-□
PLC	SYSMAC CPM1 Operation Manual	W262-E1-□
	SYSMAC CPM1A Operation Manual	W317-E1-□
	SYSMAC CPM2A Operation Manual	W352-E1-□
	SYSMAC CPM2C Operation Manual	W356-E1-□
	SYSMAC C200H Operation Manual (for CPU01/03/11) (Programming)	W130-E1-□
	SYSMAC C200H Operation Manual (for CPU21/23/31) (Programming)	W217-E1-□
	SYSMAC C200HS Installation Guide	W236-E1-□
	SYSMAC C200HS Operation Manual (Programming)	W235-E1-□
	SYSMAC C200HX/HG/HE (-Z) Installation Guide	W302-E1-□
	SYSMAC C200HX/HG/HE Operation Manual	W303-E1-□
	SYSMAC C200HX/HG/HE-Z Operation Manual	W322-E1-□
	SYSMAC CQM1/CPM1/CPM1A/SRM1 Programming Manual	W228-E1-□
	SYSMAC CQM1H Operation Manual	W363-E1-□
	SYSMAC CVM1/CV500/CV1000/CV2000/CVM1 Operation Manual: Ladder Diagrams	W202-E1-□
	CS Series Programmable Controllers Operation Manual	W339-E1-□
	CJ Series CJ1G-CPU□□-E Programmable Controllers Operation Manual	W393-E1-□
	CS/CJ Series Programming Manual	W394-E1-□
CS/CJ Series Serial Communications Boards/Units Operation Manual	W336-E1-□	
SYSMAC CQM1H Series Serial Communications Board Operation Manual	W365-E1-□	
CompoBus Master Control Unit	SRM1 (-V2) Operation Manual	W318-E1-□
Programming Tools	SYSMAC Support Software Operation Manual: C-series PLCs	W248-E1-□
	SYSMAC Support Software Operation Manual: CVM1 PLCs	W249-E1-□
	SYSMAC CPT User Manual and Quick Start Guide	W332-E1-□ W333-E1-□
	CX-Programmer Ver. 4 User Manual	W425-E1-□
Host Link Unit/ Serial Communications Board	SYSMAC C Series Host Link Unit System Manual	W143-E1-□
	SYSMAC CVM1/CV Series Host Link Operation Manual	W205-E1-□
	SYSMAC C200HW-COM01 C200HW-COM02-V1 to C200HW-COM06-EV1 Communications Board Operation Manual	W304-E1-□

SECTION 2

Hardware Settings and Connections

This section describes the settings of the NT11, connections to a PLC, and other hardware settings.

2-1	Description of Parts and Settings	16
2-1-1	Description of Parts	16
2-1-2	DIP Switch Settings	18
2-2	Installation	19
2-2-1	Installation to the Operation Panel	19
2-2-2	Power Supply Connection	20
2-2-3	Wiring the Ground Wire	21
2-3	Connecting to the NT Support Tool	22
2-4	Connection to a PLC by the Host Link (RS-232C Type)	22
2-4-1	Compatible PLCs	23
2-4-2	Connecting the NT11	24
2-4-3	PLC Switch Settings	27
2-5	Connection to a PLC by the Host Link (RS-422A Type)	38
2-5-1	Compatible PLCs	38
2-5-2	Parts Required for Connection	40
2-5-3	Method for Connection	40
2-5-4	Connector Specifications and Wiring for Each Unit	41
2-5-5	PLC Switch Settings	42
2-6	Connection to a PLC by the NT Link (RS-232C Type)	50
2-6-1	Compatible PLCs	50
2-6-2	Connecting the NT11	54
2-7	Connection to a PLC by the NT Link (RS-422A Type)	55
2-8	Connecting a Printer	57
2-8-1	How to Connect	57

2-1 Description of Parts and Settings

Before getting to the operation, confirm the names and functions of parts.
Also set the DIP switches on the NT11.

2-1-1 Description of Parts

Front View

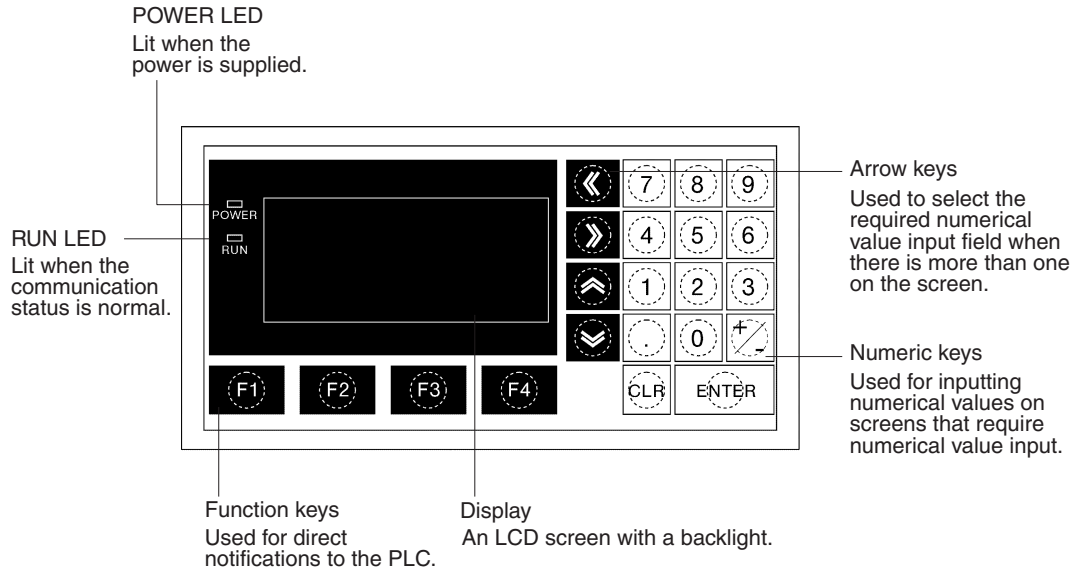

Reference The NT11 comes in two body colors.

- NT11-SF121-EV1:Beige
- NT11-SF121B-EV1:Black

Rear View

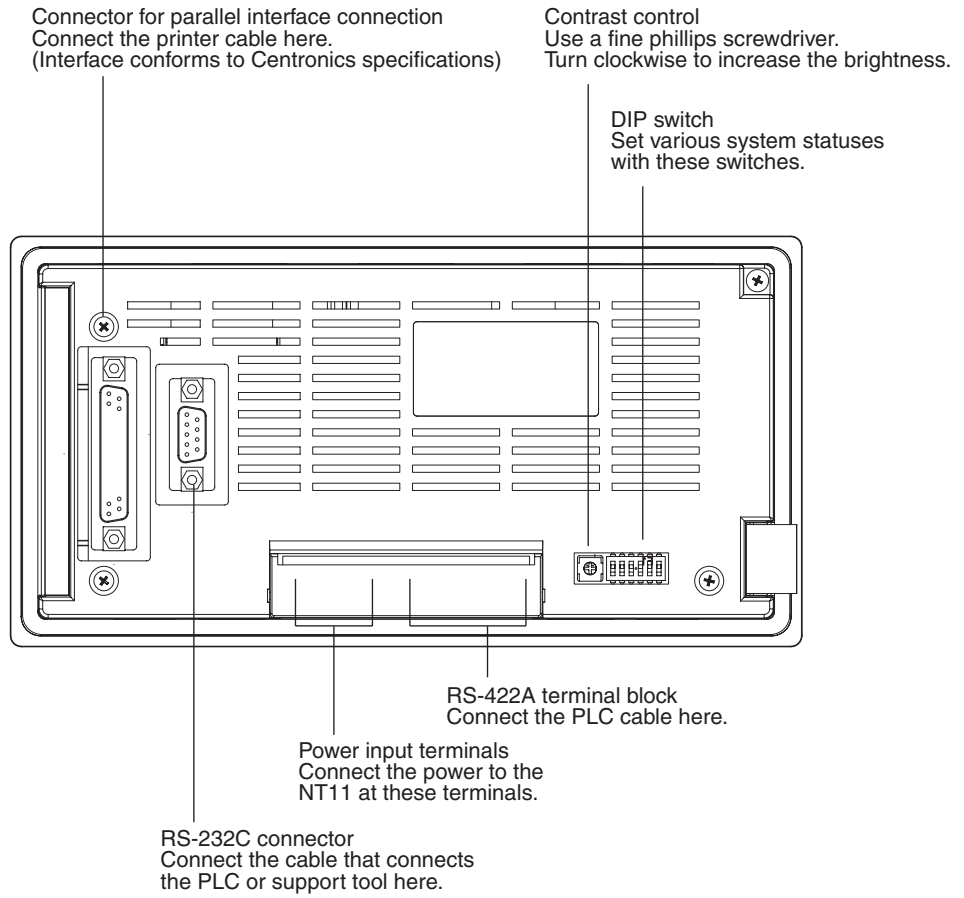

2-1-2 DIP Switch Settings

Set the NT11 operation status with the DIP switches located in the bottom right corner on the rear side of the body.

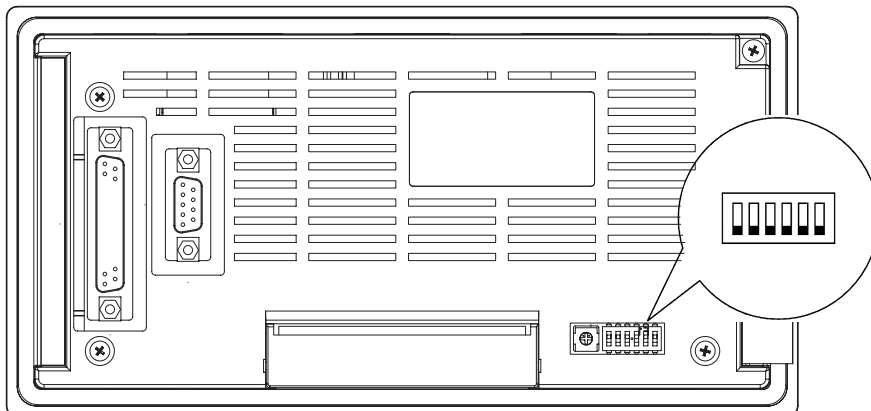

DIP Switch Settings

Factory setting: ALL OFF

DIP Switch Pin	Function	
SW1	1	RS-422A terminating resistance used
	0	Not used
SW2	1	Screen data forced initialize effective
	0	Ineffective
SW3	1	Emergency transfer mode
	0	Ineffective
SW4	1	Switching to the System Menu disabled
	0	Enabled
SW5	Reserved.	
SW6	1	System program erase enabled
	0	Disabled

Emergency transfer mode: When power to the NT11 is turned ON with DIP switch pin 3 turned ON, data transfer mode will be entered directly without any other operation.

⚠ Caution In addition to the DIP switches, set also the “Comm. Method”, “Host Link Speed”, “Automatic Reset”, etc. at the memory switches. For these settings, refer to *3-7 Setting the Conditions of Communications with the PLC by Using the Memory Switches* (page 71).

⚠ Caution After changing the switch settings, always press the reset switch or turn the power off and back on. Otherwise the system will not operate as expected.

⚠ Caution Confirm system safety before turning the power ON/OFF or resetting. Otherwise the system may operate unpredictably.

Correct Use

Use the “System program erase” function only when changing the system program.

If the system program is erased, it will not be possible to use the functions of the NT11 unless another system program is transferred.

If the DIP switch settings have been changed when the NT11 is powered, reset the power to the NT11. The changes with the DIP switches become effective only after the power supply is reset.

2-2 Installation

Install the NT11 to the operation panel and connect the power to the NT11 as described below.

1. Do not install the unit at sites subject to the following conditions. Otherwise, the product may malfunction.
 - Severe temperature variations
 - Temperature or humidity outside the ranges stated in the specifications
 - High humidity, condensation
 - Splashing chemical agents
 - Severe oil splashing
 - Corrosive or flammable gases
 - Strong vibrations or shocks
 - Direct exposure to wind and rain (outdoor sites)
 - Strong ultra-violet irradiation
2. Take adequate measures to ensure shielding if the unit is used at a location subject to any of the following conditions. Otherwise, the product may malfunction.
 - Static electricity, or noise from other equipment
 - Strong electromagnetic fields
 - Nearby power cables
 - Potential exposure to radioactivity

2-2-1 Installation to the Operation Panel

The NT11 can be flush mounted to an operation panel.

Use the panel fittings and tools included in the product package and follow the procedure below.

 **Caution** On unpacking the unit, check its external appearance and confirm that there is no damage. Also confirm that there is no abnormal noise on shaking the unit lightly. The product may malfunction if it is damaged.

 **Caution** During work at the panel, take care to ensure that no metal scraps enter the unit.
Otherwise, the product may malfunction.

 **Caution** The thickness of applicable operation panel is 1.6 mm to 4.8 mm. All fittings must be tightened uniformly to a torque of 0.5 to 0.6 N·m in order to ensure water- and dust-resistance. The panel must not be soiled or warped, and must be able to support an installation that will remain secure and strong.

- 1,2,3...**
1. Open a hole, shown below, in the panel and install the NT11 from the front side of the panel.

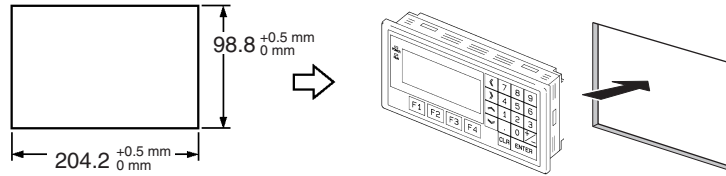

2. Attach the panel fittings at four positions for the upper/lower sides and at two positions for the right and left sides, shown below, on the rear side of the NT11.

Fit the hook of the fitting in the square hole in the body and tighten the screw with a Phillips head screwdriver while lightly pulling the fitting.

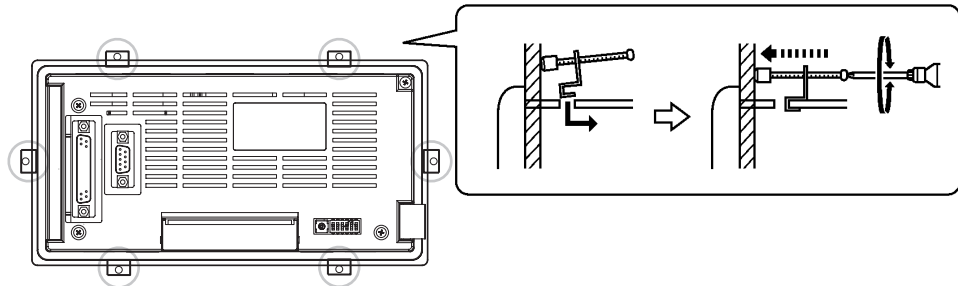

2-2-2 Power Supply Connection

Connect a 24 VDC power supply to the power input terminals.

- ⚠ **Caution** Carefully check the wiring before switching ON the power.
- ⚠ **Caution** Do not connect AC power to the DC terminals.
- ⚠ **Caution** Use DC and AC power supplies with low voltage and frequency fluctuations.
- ⚠ **Caution** Do not perform withstand voltage test. Performing withstand voltage test may result in malfunction.

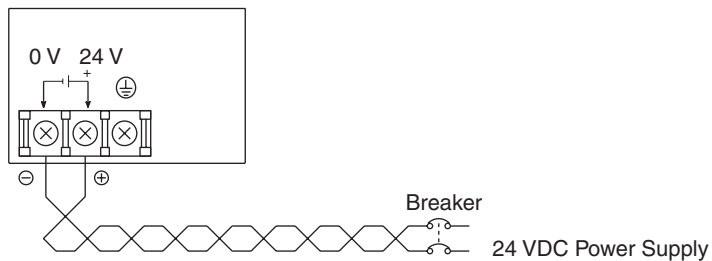

- **Noise prevention**
The NT11 has a noise preventive feature against the power supply line noise. To further reduce noise, connect a noise filter to the power line. This will drastically reduce the ground noise.

- Power supply

Applicable power supply specifications are as follows.

Item	Value
Power supply voltage	24 VDC
Allowable power supply voltage fluctuation range	20.4 VDC to 26.4 VDC (24 VDC -15%, +15%)
Power supply capacity	10 W or lower

- Parts used for connection

Use crimp terminals to connect the power supply to the power input terminals. Recommended crimp terminals for M3.5 are given below.

⚠ Caution For the connection to the power supply terminal block, twisted wires of 2 mm² or greater cross sectional area and M 3.5 size crimp terminals must be used. Tighten the screws on the terminal block to a torque of 0.5 N·m. Otherwise fire may occur.

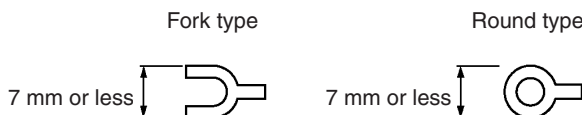

[Recommended terminals]

Maker	Type (fork type)	Type (round type)	Applicable Wire (stranded wire)
Japan Solderless Terminal MFG	2-YS3A	2-3.5	1.04 to 2.63 mm ²
Fuji Terminal	2-YAS3.5	V2-S3.5	
Nichifu Terminal	2Y-3.5	2-3.5	

Note When surge noise occurs in the DC power supply, connect a Transistor Voltage Suppressor (TVS) between the 24-V and 0-VDC terminals. Recommended TVS model: 1.5KE33CA
Manufacturers: Vishay Intertechnology Inc, STMicroelectronics

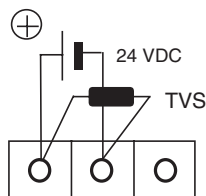

2-2-3 Wiring the Ground Wire

The PT is provided with a functional ground (FG: ) terminal.

Wire the FG terminal according to the following conditions.

1. Ground according to Figure when there is difference in potential between the PT and host. Do not ground the functional ground of the PT if it is far from the host and one-point grounding is difficult.
2. Do not ground the functional ground (FG: ) of the PT if it is mounted to the same panel as devices that generate noise, such as motors and inverters.

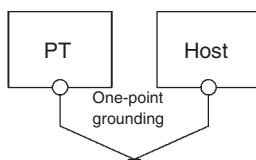

Note Ground correctly to prevent malfunctions caused by noise.

2-3 Connecting to the NT Support Tool

In order to install the system program in the NT11, or to transmit screen data created with the NT Support Tool to the NT11, the NT11 must be connected to a personal computer with an RS-232C cable.

The NT11 connects with the RS-232C cable from a personal computer at the RS-232C serial port.

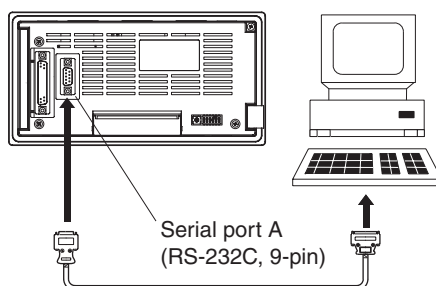

Communication Conditions

The communication conditions are automatically set when the system installer and NT Support Tool are started.

Recommended Connector Cable

Use the cable indicated below.

- XW2Z-S002 (length: 2 m), made by OMRON
(D-SUB 9-pin, male ↔ D-SUB 9-pin, female)

For details on making a connector cable, refer to *Appendix E Making the Cable for Connecting a Personal Computer* (page 155).

2-4 Connection to a PLC by the Host Link (RS-232C Type)

Connect the NT11 to an OMRON PLC by using RS-232C type the host link method.

In order to make a connection to the PLC using the host link method (RS-232C type), the “Comm. Type” memory switch of the NT11 must be set to “host link”, and the “Comm. Port” memory switch must be set to “RS-232C”. For details on memory switch settings, refer to *3-7-1 Selecting the Host Communication Method* (page 73).

2-4-1 Compatible PLCs

Some models and series of OMRON PLCs have the host link function built in. Check the model and series of the PLC against the type of host link unit before making the connections.

The compatible PLCs are listed in the table below.

PLC Series	Units with Built-in Host Link Function	CPU Units Connectable with Host Link Units or Expansion Communication Board	Host Link Unit/Communication Board	Connectable to
CS Series	CS1G-CPU42/43/44/45-EV1 CS1H-CPU63/64/65/66/67-EV1 CS1G-CPU42H/43H/44H/45H CS1H-CPU63H/64H/65H/66H/67H	CS1G-CPU42/43/44/45-EV1 CS1H-CPU63/64/65/66/67-EV1 CS1G-CPU42H/43H/44H/45H CS1H-CPU63H/64H/65H/66H/67H	CS1W-SCU21 CS1W-SCB21 CS1W-SCB41	CS1G CS1H CS1G-H CS1H-H
CJ Series	CJ1G-CPU44/45	CJ1G-CPU44/45	CJ1W-SCU41	CJ1G
C Series	---	C200HS-CPU01/03/21/23/31/33-E C200HE-CPU11/32/42-E C200HE-CPU11/32/42-ZE C200HG-CPU33/43/53/63-E C200HG-CPU33/43/53/63-ZE C200HX-CPU34/44/54/64-E C200HX-CPU34/44/54/64/65/85-ZE	C200H-LK201-EV1	C200HS C200HE C200HE-Z C200HG C200HG-Z C200HX C200HX-Z
	C200HS-CPU21/23/31/33-E	---	---	C200HS
	C200HE-CPU42-E C20HE-CPU42-ZE	C200HE-CPU32/42-E C200HE-CPU32/42-ZE	C200HW-COM02/04/05/06-EV1	C200HE C200HE-Z
	C200HG-CPU43/63-E C200HG-CPU43/63-ZE	C200HG-CPU33/43/53/63-E C200HG-CPU33/43/53/63-ZE		C200HG C200HG-Z
	C200HX-CPU44/64-E C200HX-CPU44/64/65/85-ZE	C200HX-CPU34/44/54/64-E C200HX-CPU34/44/54/64/65/85-ZE		C200HX C200HX-Z
	CPM1-10/20/30CDR-□ +CPM1-CIF01	---		---
	CPM1A-10/20/30/40CD□-□ +CPM1-CIF01	---	---	
	CPM2A-30/40/60CD□□-□ +CPM1-CIF01 (Peripheral port connection)	---	---	CPM2A
	CPM2C-10/20□□□□□□-□ (*1)	---	---	CPM2C
	CQM1-CPU21-E CQM1-CPU41/42/43/44-EV1 CQM1H-CPU11/21/51/61 (*2)	---	---	CQM1
		CQM1H-CPU51/61	CQM1H-SCB41	CQM1H
CVM1 Series (*3)	CVM1-CPU01-EV2 CVM1-CPU11-EV2 CVM1-CPU21-EV2	CVM1-CPU01-EV2 CVM1-CPU11-EV2 CVM1-CPU21-EV2	CV500-LK201	CVM1
Compo-Bus/S Master Unit	SRM1-C02-V1	---	---	SRM1

*1: Use a CPM2C-CN111 or CS1W-CN114/118 Connecting Cable, CPM1-CIF01 RS-232C Adapter, or CPM1-CIF11 RS-422A Adapter to connect.

*2: The CQM1H-CPU11 does not have a built-in RS-232C port, so connect to the PT at the peripheral port with a CS1W-CN118 Connecting Cable.

*3: CPU Units of CVM1/CV-series PLCs without the suffix -EV□ cannot be connected.

2-4-2 Connecting the NT11

Refer to the illustrations below to select the appropriate cable for the unit connectors and connect the NT11 to the PLC.

To make a connector cable, refer to *Appendix D Making the Cable* (page 153).

Caution Before inserting or removing the connectors, make sure that the NT11 and the PLC are turned OFF.

Caution After connecting a communication cable, always secure it with the screws. Otherwise the cable may disconnect, causing operation to fail.

Caution The cable's tensile load is 30 N. Do not subject it to loads greater than this. Otherwise a discontinuity may occur, causing operation to fail.

Connecting to a PLC with a 25-pin Connector

Use a connector cable with a 25-pin connector on one end and a 9-pin connector on the other end (NT11 side) to connect the NT11 to a PLC with a 25-pin connector.

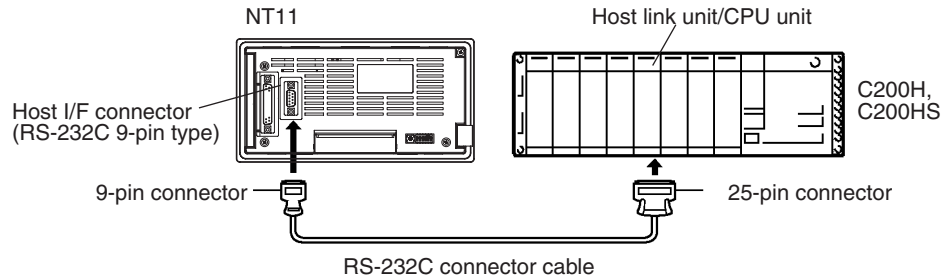

Connecting to a PLC with a 9-pin Connector

Use a connector cable with a 9-pin connector on both ends to connect the NT11 to a PLC with a 9-pin connector.

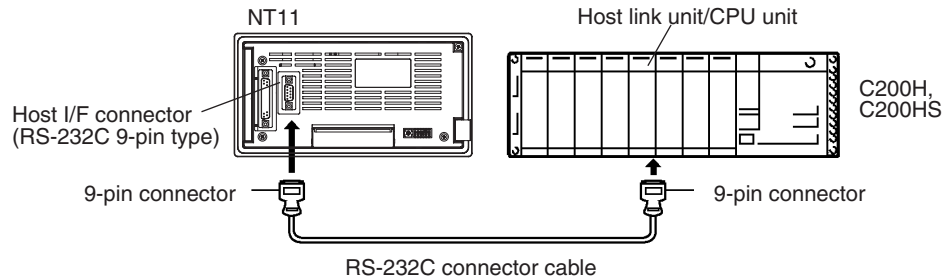

The method for connection between the RS-232C ports of the NT11 and the host is described here.

Recommended Connector Cable

When making the connector cable, as far as possible use the recommended connectors, connector hoods, and cables indicated in the table below. Some Units come supplied with one connector and one connector hood.

Check the required components and prepare them in advance.

Name	Model	Remarks	Delivered with
Connector	XM2A-0901	9-pin Made by OMRON	CS-series CS1G/CS1H, CS1G-H/CS1H-H CJ-series CJ1G C-series CQM1, C200HS, C200HX/HG/HE(-Z)E, CVM1/CV-series CPU Units CV500-LK201
	XM24-2501	25-pin Made by OMRON	CV500-LK201 C200H-LK201-EV1
Connector hood	XM2S-0911	9-pin Made by OMRON	C-series CQM1, C200HS, C200HX/HG/HE(-Z)E, CVM1/CV-series CPU Units CV500-LK201
	XM2S-0913	9-pin Made by OMRON	---
	XM2S-0911-E	9-pin Made by OMRON	CS-series CS1G/CS1H, CS1G-H/CS1H-H CJ-series CJ1G
	XM2S-2511	25-pin Made by OMRON	CV500-LK201 C200H-LK201-EV1
Connector set	XM2S-0911-S003	9-pin Made by OMRON, connector and hood included	---
Cable	AWG28×5P IFVV-SB	Multi-core shielded cable Made by Fujikura, Ltd.	---
	CO-MA-VV-SB 5P×28AWG	Multi-core shielded cable Made by Hitachi Cable, Ltd.	---

Note After connecting a communication cable, always secure it with the screws. Otherwise the cable may disconnect, causing operation to fail.

OMRON Cables with Connectors

The OMRON cables listed below can be used when connecting with a method other than the memory link method.

Model	Cable Length	Connector Specification
XW2Z-200S	2 m	9-pin ↔ 25 pin
XW2Z-500S	5 m	
XW2Z-200T	2 m	9-pin ↔ 9-pin
XW2Z-500T	5 m	

Note The cable's tensile load is 30 N. Do not subject it to loads greater than this. Otherwise a discontinuity may occur, causing operation to fail.

Wiring for a Host Link Unit (25-pin) Connection

Applicable Units: C200H-LK201-EV1
CV500-LK201 (communication port 1)

Compatible cables with attached connectors:
XW2Z-200S (9-pin ↔ 25-pin, 2 m)
XW2Z-500S (9-pin ↔ 25-pin, 5 m)

CVM1/CV-series Host Link Units (CV500-LK201) have two types of connector; a 25-pin connector (communication port 1), and a 9-pin connector (communication port 2). When using communication port 2, refer to *Wiring for Other Connections (Other Than the Memory Link Method)* (page 26).

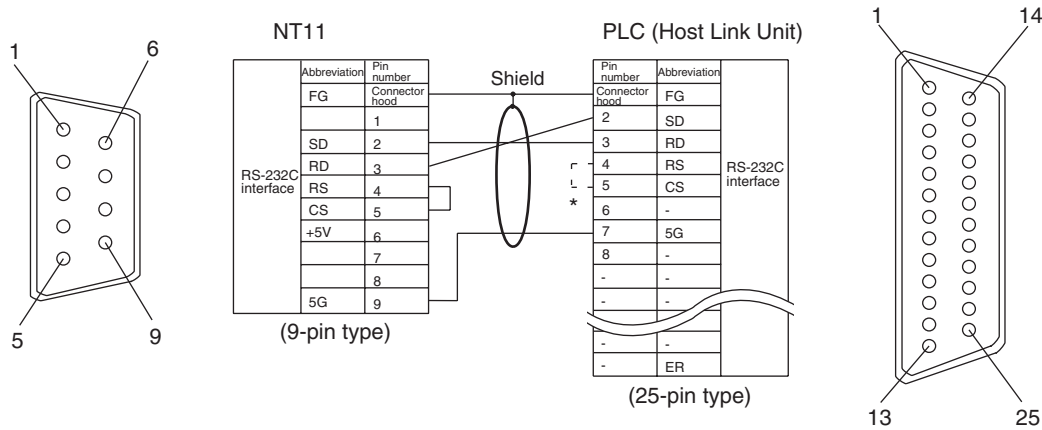

* For Units that have a CTS setting selector switch, RS and CS do not have to be shorted if this switch is set to 0 V.

Wiring for Other Connections

Applicable Units:

- | | |
|------------------------------------|-------------------|
| CV500-LK201 (communication port 2) | |
| CS1W-SCU21 | CJ1W-SCU41 |
| CPM1-10CDR-□ | CPM1-20CDR-□ |
| CPM1-30CDR-□ | |
| CPM1A-10CD□-□ | CPM1A-20CD□-□ |
| CPM1A-30CD□-□ | CPM1A-40CD□-□ |
| CPM2A-30CD□-□ | CPM2A-40CD□-□ |
| CPM2A-60CD□-□ | |
| CPM2C-10□□□□□□-□ | CPM2C-20□□□□□□-□ |
| CQM1-CPU21-E | |
| CQM1-CPU41-EV1 | CQM1-CPU42-EV1 |
| CQM1-CPU43-EV1 | CQM1-CPU44-EV1 |
| CQM1H-CPU11 | CQM1H-CPU21 |
| CQM1H-CPU51 | CQM1H-CPU61 |
| CS1G-CPU42-E(V1) | CS1G-CPU43-E(V1) |
| CS1G-CPU44-E(V1) | CS1G-CPU45-E(V1) |
| CS1H-CPU63-E(V1) | CS1H-CPU64-E(V1) |
| CS1H-CPU65-E(V1) | CS1H-CPU66-E(V1) |
| CS1H-CPU67-E(V1) | |
| CS1G-CPU42H | CS1G-CPU43H |
| CS1G-CPU44H | CS1G-CPU45H |
| CS1H-CPU63H | CS1H-CPU64H |
| CS1H-CPU65H | CS1H-CPU66H |
| CS1H-CPU67H | |
| CJ1G-CPU44 | CJ1G-CPU45 |
| C200HS-CPU21-E, -EC | C200HS-CPU23-E |
| C200HS-CPU31-E | C200HS-CPU33-E |
| C200HE-CPU32-(Z)E | C200HE-CPU42-(Z)E |
| C200HG-CPU33-(Z)E | C200HG-CPU43-(Z)E |
| C200HG-CPU53-(Z)E | C200HG-CPU63-(Z)E |
| C200HX-CPU34-(Z)E | C200HX-CPU44-(Z)E |

C200HX-CPU54-(Z)E C200HX-CPU64-(Z)E
 C200HX-CPU65-ZE C200HX-CPU85-ZE
 CVM1-CPU01-EV2 CVM1-CPU11-EV2
 CVM1-CPU21-EV2
 SRM1-C02-V2

Compatible cables with attached connectors:

XW2Z-200T (9-pin ⇔ 9-pin, 2 m)
 XW2Z-500T (9-pin ⇔ 9-pin, 5 m)

CPU Units of CVM1/CV-series PLCs without the suffix -EV□ cannot be connected by any connection method.

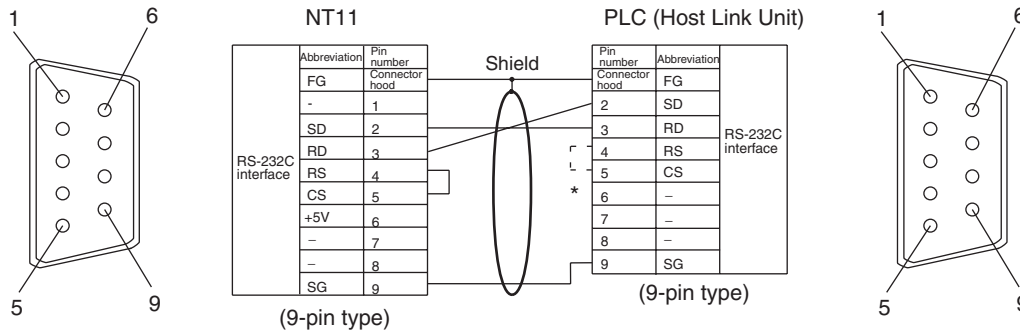

2-4-3 PLC Switch Settings

When the NT11 and PLC are connected to each other, set the conditions at the PLC host link unit or the CPU as given in the table below.

The following is a general description of switch settings.

Refer to the manual for respective units for the details of the switch settings.

Item	Switch Setting
I/O port	RS-232C
Baud rate	Set the same baud rate as the NT11. (*1)
Transfer code	ASCII 7 data bits, 2 stop bits
Parity	Even
1-to-1/1-to-N	1-to-N (*2)
Instruction level	Level 1, 2, 3
Unit No.	00

*1 Set the host link baud rate up to 115,200 bps with the memory switch for “host link baud rate”. For the details, refer to 3-7-2 *Selecting the Host Link Communication Speed* (page 74).

*2 The 1-to-N setting enables BCC (Block Check Character). The 1-to-1 connection cannot be used to connect the NT11 to a host link unit.

Connecting to a C-series Host Link Unit

**C200H/C200HS/C200HE/HG/HX (-Z)E Rack-mounted Unit:
C200H-LK201-V1**

Setting the Front Switches

Set each switch with a flat blade screwdriver so that the values or symbols in the setting value window agree with the following.

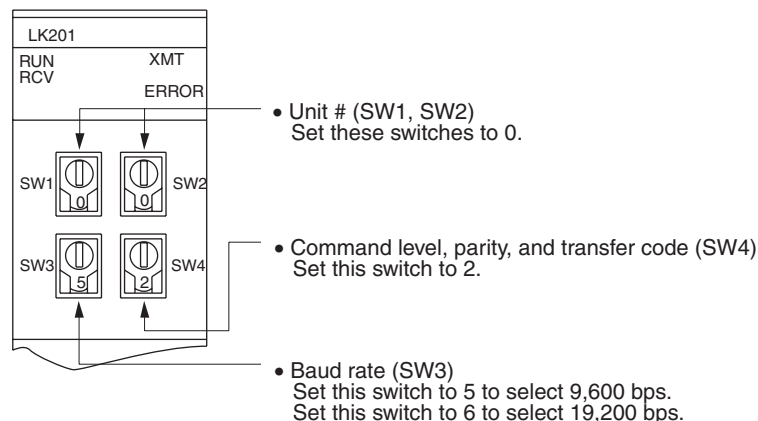

Setting the Rear Switches

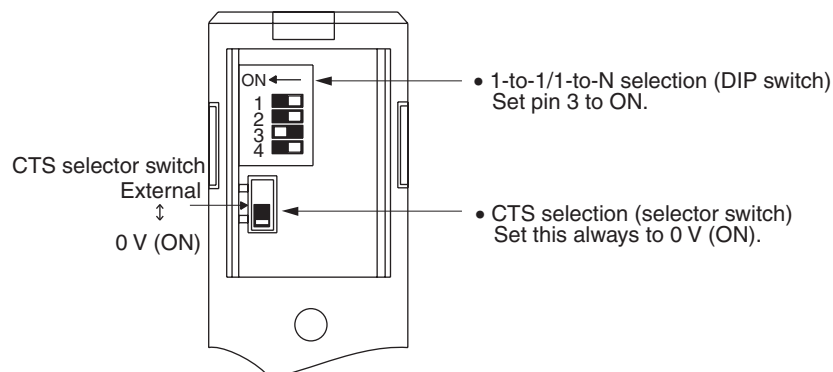

Connecting to a CVM1/CV-series Host Link Unit

CVM1/CV-series Rack-mounted Unit: CV500-LK201

A CVM1/CV-series Host Link Unit (CV500-LK201) has two connectors (communication ports 1 and 2). Either of these ports can be used for connection to an NT11 by the RS-232C method. However, since the connectors at these ports are of different types, a cable that matches the connector must be prepared.

- Communication port 1
Communication port 1 is a 25-pin connector for RS-232C use only.
- Communication port 2
Communication port 2 is a 9-pin connector that allows selection of the RS-232C or RS-422A method. When this port is used with the RS-232C method, the I/O port selector switch on the front of the Unit must be set to RS-232C (the upper position).

CPU Bus Unit Settings

When connecting to a CVM1/CV-series Host Link Unit, set the following communication conditions for the CPU Bus Unit settings.

Item	Setting at Host
Baud rate	Set the same baud rate as set at the NT11 ^(*1)
Transfer code	ASCII, 7 data bits, 2 stop bits
Parity	Even
1-to-1, 1-to-N	1-to-N ^(*2)
Command level	Level 1, 2, 3

*1 Set the Host Link baud rate up to 115,200 bps with the memory switch at the NT11. For details, refer to *Setting the Host Link Method* (page 74).

*2 The 1-to-N setting enables BCC (Block Check Character). It is not actually possible to connect more than one NT11 in a single Host Link.

Set the CPU Bus Unit settings directly from a Programming Device (e.g., SYSMAC Support Software).

For details on the CPU Bus Unit settings, refer to the *SYSMAC CVM1/CV-series Host Link Unit Operation Manual* (W205-E1-□).

Setting the Front Switches

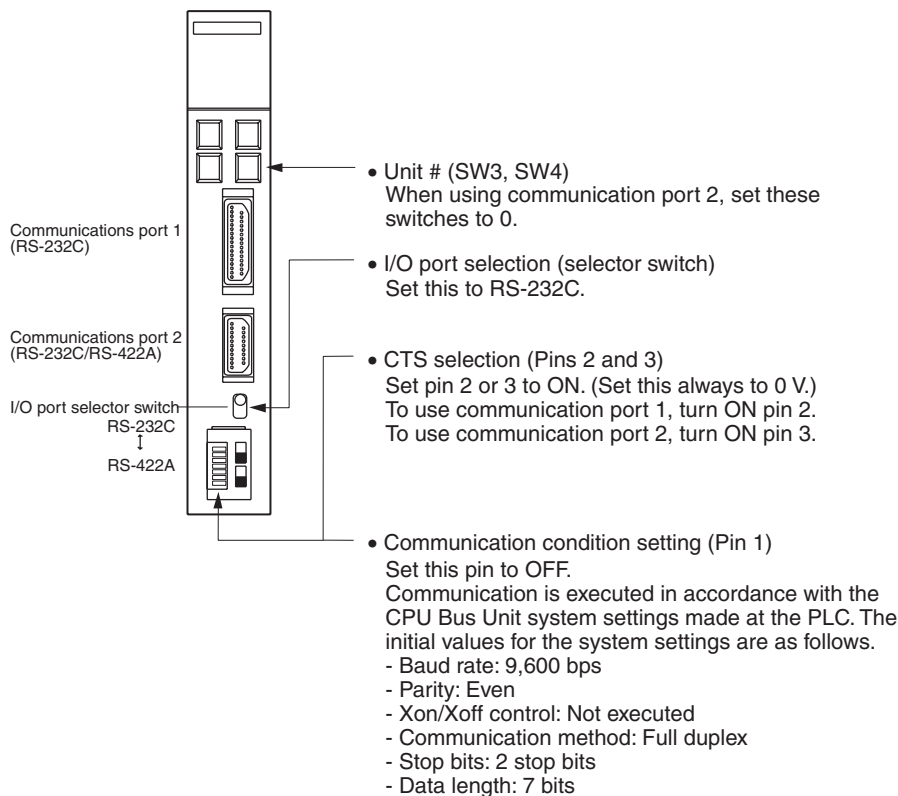

Connecting to a CS/CJ-series Serial Communications Unit

CS/CJ-series Rack-mounted Unit: CS1W-SCU21CJ-series: CJ1W-SCU41 (Port 2 is an RS-232C Port.)

Setting the Front Switches

Set the unit number of the Serial Communications Unit by using the rotary switch located on the front panel. Set each switch with a flat blade screwdriver

so that the values or symbols in the setting value window agree with the following.

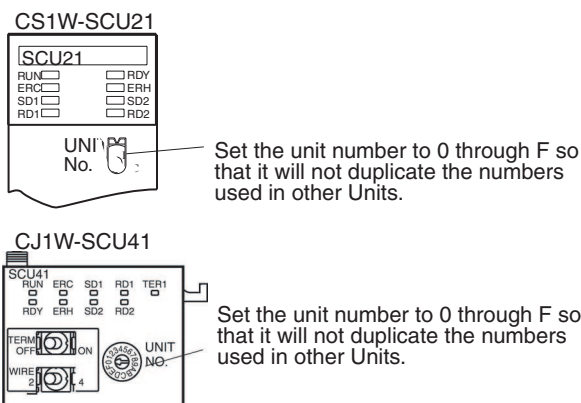

Allocation DM Area Settings for CPU Unit

Settings are written from the Programming Device (a Programming Console or CX-Programmer) directly into the allocated DM Area (PLC Setup) of the CPU Unit. After the settings are written, they become effective by turning the power ON, restarting the Unit, restarting the communication port, or execution of the STUP instruction.

The following table shows the words allocated in the DM Area and the settings.

$$m = DM30000 + 100 \times \text{unit number}$$

Allocated DM word		Value	Settings
Port 1	Port 2		
m	m+10	8000	Host Link mode, 2 stop bits, even parity, data length 7 bits
m+1	m+11	0000	Baud rate 9,600 bps
		0007	Baud rate 19,200 bps
		0008	Baud rate 38,400 bps
		0009	Baud rate 57,600 bps
		000A	Baud rate 115,200 bps
m+2	m+12	0000	Transmit delay time 0 ms
m+3	m+13	0000	No CTS control Unit No. 0 for Host Link

Connecting to a CPU Unit

CV-series and CVM1/CV-series (-EV□) CPU Units

CVM1-CPU01-EV2/CVM1-CPU11-EV2/CVM1-CPU21-EV2

PLC Setup

When connecting to a CVM1/CV-series CPU Unit, set the following communication conditions for the PLC Setup.

Item	Setting at Host
Baud rate	Set the same baud rate as set at the NT11 ^(*1)
Stop bits	2 stop bits
Parity	Even
Data length	ASCII 7 bits
Unit #	00

*1 Set the Host Link baud rate at 9,600 bps with the memory switch at the NT11. For details, refer to *Setting the Host Link Method* (page 74).

Either set PLC Setup directly from a Programming Device (e.g., SYSMAC Support Software), or transmit the PLC Setup made at a Programming Device to the CPU Unit.

For details on the PLC Setup, refer to the *SYSMAC CVM1/CV500/1000/2000 Operation Manual: Ladder Diagrams (W202-E1-□)*.

Setting the Front Switches

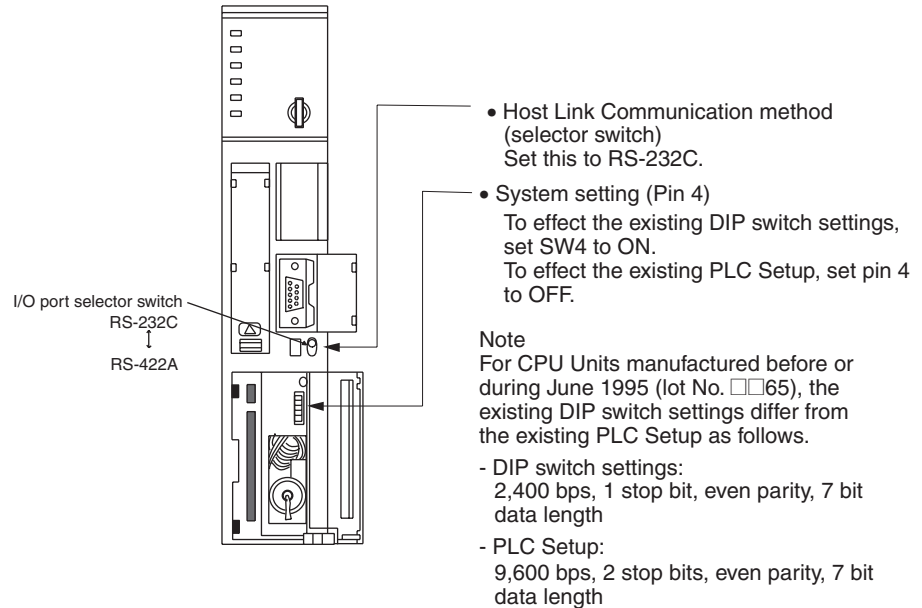

For CPU Units manufactured from July 1995 onward (lot No. □□75), the stipulated values in the DIP switch settings also are 9,600 bps and 2 stop bits.

C-series C200HS, C200HX/HG/HE(-Z)E, CPM1, CPM2A, CPM2C, CQM1, CQM1H CPU Units and SRM1

The connection method depends upon the model of PLC being used, as shown in the following table.

PLC model	Connection method
C200HS, CQM1	Connect to the CPU Unit's built-in RS-232C port.
C200HX/HG/HE(-Z)E	<ul style="list-style-type: none"> • Connect to the CPU Unit's built-in RS-232C port. • Connect to one of the RS-232C ports (port A or port B) on a Serial Communications Board.
CQM1H	<ul style="list-style-type: none"> • Connect to the CPU Unit's built-in RS-232C port. • Connect to the peripheral port through a CS1W-CN118 Connecting Cable. • Connect to the RS-232C port (port 1) on a Serial Communications Board.
CPM1	Connect to the peripheral port through a CPM1-CIF01 RS-232C Adapter.

PLC model	Connection method
CPM2A, SRM1	<ul style="list-style-type: none"> • Connect to the CPU Unit's built-in RS-232C port. • Connect to the peripheral port through a CPM1-CIF01 RS-232C Adapter.
CPM2C	<p>Connect to the CPU Unit's RS-232C port or the peripheral port through a Connecting Cable (CPM2C-CN111, CS1W-CN118, or CS1W-CN114).</p> <p>(The CPM2C-CN111 splits the Unit's Communication Port into a RS-232C port and a peripheral port. A CPM1-CIF01 RS-232C Adapter is also required to connect to this peripheral port.)</p>

PLC Setup Settings

When connecting to a C200HS, C200HX/HG/HE(-Z)E, CPM1, CPM2A, CPM2C, CQM1, or CQM1H CPU Unit, or SRM1, set the following communication conditions for the PLC Setup.

Item	Setting at Host
Communication mode	Host Link mode
Baud rate	Set the same speed as set at the NT11(*1)
Stop bits	2 stop bits
Parity	Even
Data length	ASCII 7 bits
Unit #	00

*1 Set the Host Link baud rate at 9,600 bps or 19,200 bps with the memory switch at the NT11. For details, refer to *Settings the Host Link Method* (page 74).

Set the PLC Setup settings directly from a Programming Device (e.g., the CX-Programmer Support Software).

For details on operations relating to the PLC Setup, refer to the manual for the PLC which is used.

The PLC Setup area word addresses and settings to be made depending on the Unit and port to which the connection is made are shown below.

CPM2A, CPM2C, CQM1H, or SRM1: Peripheral port connection

Word	Writing Value	Settings
DM6650	0001	Host Link mode, no CTS control Communication conditions set by the contents of DM
DM6651	0303	Data length 7 bits, 2 stop bits, even parity, baud rate: 9,600 bps
	0304	Data length 7 bits, 2 stop bits, even parity, baud rate: 19,200 bps
DM6653	0000	Unit # 00

C200HS, C200HX/HG/HE(-Z)E, CPM2A, CPM2C, CQM1, CQM1H (other than the CPU11), or SRM1: Built-in RS-232C port connection

Word	Writing Value	Settings
DM6645	0001	Host Link mode, no CTS control Communication conditions set by the contents of DM
DM6646	0303	Data length 7 bits, 2 stop bits, even parity, baud rate: 9,600 bps
	0304	Data length 7 bits, 2 stop bits, even parity, baud rate: 19,200 bps
DM6648	0000	Unit # 00

C200HX/HG/HE(-Z)E: Serial Communications Board port A

CQM1H: Serial Communications Board port 1

Word	Writing Value	Settings
DM6555	0001	Host Link mode, no CTS control Communication conditions set by the contents of DM
DM6556	0303	Data length 7 bits, 2 stop bits, even parity, baud rate: 9,600 bps
	0304	Data length 7 bits, 2 stop bits, even parity, baud rate: 19,200 bps
DM6558	0000	Unit # 00

C200HX/HG/HE(Z)E: Serial Communications Board port B

Word	Writing Value	Settings
DM6550	0001	Host Link mode, no CTS control Communication conditions set by the contents of DM
DM6551	0303	Data length 7 bits, 2 stop bits, even parity, baud rate: 9,600 bps
	0304	Data length 7 bits, 2 stop bits, even parity, baud rate: 19,200 bps
DM6553	0000	Unit # 00

CPM1: Peripheral port connection through a CPM1-CIF01 RS-232C Adapter

Word	Writing Value	Settings
DM6650	0001	Host Link mode Communication conditions set by the contents of DM
DM6651	0303	Data length 7 bits, 2 stop bits, even parity, baud rate: 9,600 bps
	0304	Data length 7 bits, 2 stop bits, even parity, baud rate: 19,200 bps
DM6653	0000	Unit # 00

Connecting to a CPM2C

The CPM2C PLCs do not have the same kind of port connectors found on CS1-series PLCs. The CPM2C's communication port handles both RS-232C and peripheral port connections, which are divided internally. Therefore, when using the CPM2C, it is necessary to select RS-232C or peripheral port connections, according to the kind of cable and port (on the cable) used, as shown in the following table. Refer to the *CPM2C Operation Manual* for more details.

Port connecting to PT	PLC Setup
RS-232C port (D-Sub 9-pin) of CPM2C-CN111	Built-in RS-232C port settings
Peripheral port of CPM2C-CN111	Peripheral port settings
RS-232C port (D-Sub 9-pin) of CS1W-CN118	Built-in RS-232C port settings
Peripheral port of CS1W-CN114	Peripheral port settings

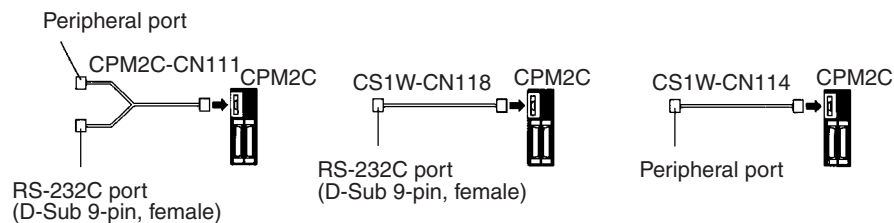

Setting the DIP Switches of a C200HX/HG/HE(-Z)E, CQM1, or CQM1H

When using a C200HX/HG/HE(-Z)E, CQM1, or CQM1H, the DIP switches on the front panel must be set as shown below in order to make the settings in the PLC Setup (in the DM Area) effective.

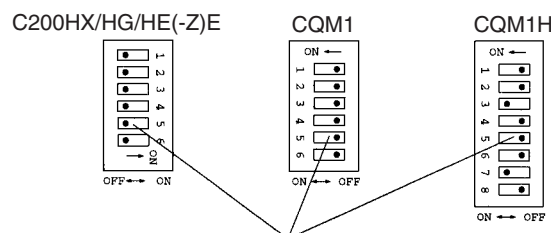

RS-232C port communication condition setting
Set pin 5 to OFF to make the settings made in PLC Setup effective.

When using the CQM1H's built-in peripheral port, turn ON SW7.

Setting the Switches of a CPM2A

When using a CPM2A, the switches on the front panel must be set as shown below in order to make the PLC Setup settings effective.

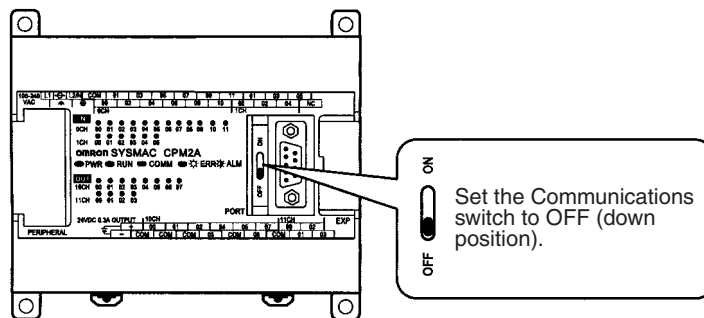

Setting the Switches of a CPM2C

When using a CPM2C, the switches on the front panel must be set as shown below in order to make the PLC Setup settings effective.

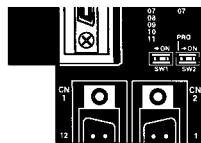

The settings for SW1 and SW2 depend upon the usage of the peripheral port and RS-232C port.

- Connecting PT to peripheral port
- Connecting PT to built-in RS-232C port (A device that requires non-standard communications settings is connected to the peripheral port.)

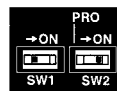

SW1: OFF
SW2: ON

- Connecting PT to built-in RS-232C port (A Programming Console is connected to the peripheral port.)

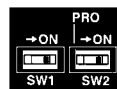

SW1: OFF
SW2: OFF

Setting the Switches on an RS-232C Adapter

When using a CPM1-CIF01 RS-232C Adapter, set the mode switch as shown in the following diagram.

Set the mode setting switch to HOST (upper position).

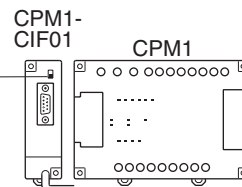

**CS/CJ-series CPU Unit model: CS1G/HCPU□□-E (-V1)
CS1G/H-CPU□□H
CJ1G-CPU□□**

Connect to the built-in RS-232C port of the CPU Unit, or the RS-232C port of the Communication Board. Note that the connection to a peripheral port must be made via an RS-232C Adapter (CS1W-CN118) specially designed for connecting to a peripheral port.

PLC Setup

When connecting to a CS/CJ-series CPU Unit, set the following communication conditions for the PLC Setup. Since the settings shown below are the PLC default settings for the CPU Unit, no change to the PLC Setup is necessary as long as the baud rate is maintained at 9,600 bps.

Item	Setting at Host
Baud rate	Set the same speed as set at the NT11 ^(*1)
Stop bits	2 stop bits
Parity	Even
Data length	ASCII 7 bits
Unit No. for the Host Link	00

*1 Set the Host Link baud rate up to 115,200 bps with the memory switch at the NT11. For details, refer to *Settings the Host Link Method* (page 74). When the baud rate is set to 19,200 bps, the PLC Setup of the CPU Unit need to be changed.

Either set the PLC Setup directly from a Programming Device (Programming Console), or transmit the PLC Setup made at a Programming Device (CX-Programmer) to the CPU Unit.

For details on PLC Setup, refer to the *SYSMAC CS Series Operation Manual* (W339-E1-□) or *SYSMAC CJ Series Operation Manual* (W393-E1-□).

When using the built-in RS-232C port of a CS1G/H, CS1G/H-H, or CJ1G

Word address	Writing Value	Settings
CIO 160	8000	Host Link mode, data length 7 bits, 2 stop bits, even parity
CIO 161	0000	Baud rate: 9,600 bps.
	0007	Baud rate: 19,200 bps.
	0008	Baud rate: 38,400 bps.
	0009	Baud rate: 57,600 bps.
	000A	Baud rate: 115,200 bps.
CIO 166	0000	Unit #00

When using the peripheral port of a CS1G/H, CS1G/H-H, or CJ1G

Word address	Writing Value	Settings
CIO 144	8000	Host Link mode, data length 7 bits, 2 stop bits, even parity
CIO 145	0000	Baud rate: 9,600 bps.
	0007	Baud rate: 19,200 bps.
	0008	Baud rate: 38,400 bps.
	0009	Baud rate: 57,600 bps.
	000A	Baud rate: 115,200 bps.
CIO 150	0000	Unit #00

Setting the Front Switches

Set pins 4 and 5 of the CPU Unit DIP switch in accordance with the port that the NT11 is connected to.

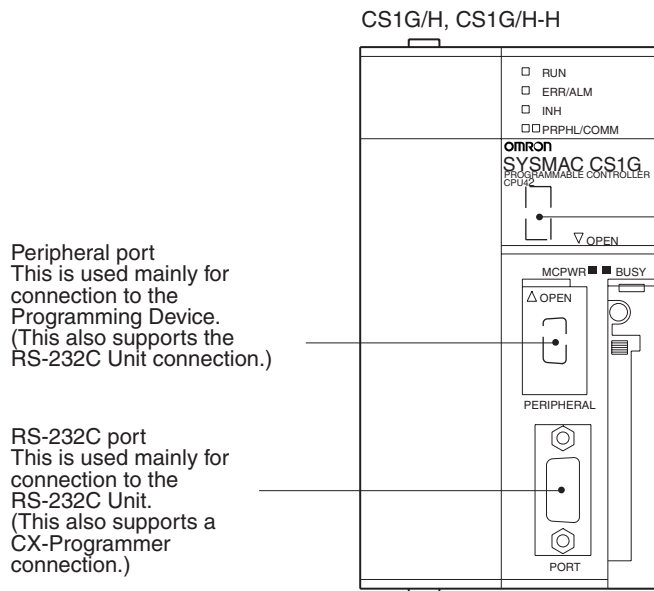

- DIP switches (inside the battery storage)
- Set pin 4 to ON (establishing communication in accordance with PLC Setup) when connecting the NT11 to the peripheral port.
 - Set pin 5 to OFF (establishing communication in accordance with PLC Setup) when connecting the NT11 to the RS-232C port.

Peripheral port
This is used mainly for connection to the Programming Device. (This also supports the RS-232C Unit connection.)

RS-232C port
This is used mainly for connection to the RS-232C Unit. (This also supports a CX-Programmer connection.)

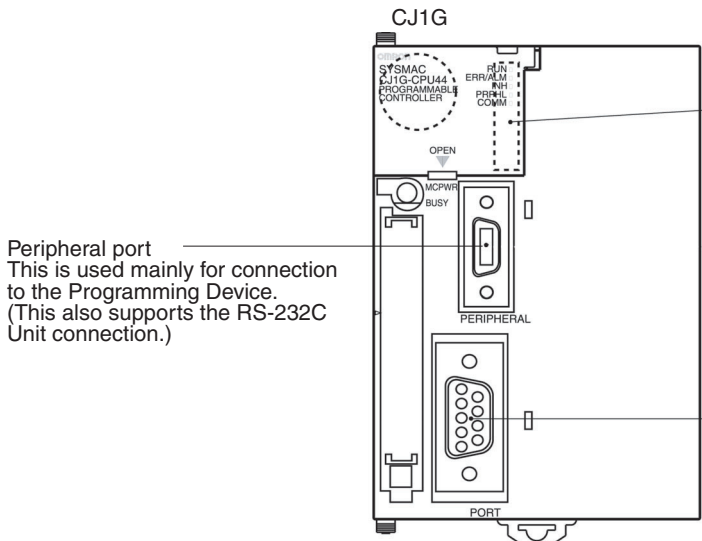

- DIP switches (inside the battery storage)
- Set pin 4 to ON (establishing communication in accordance with PLC Setup) when connecting the NT11 to the peripheral port.
 - Set pin 5 to OFF (establishing communication in accordance with PLC Setup) when connecting the NT11 to the RS-232C port.

Peripheral port
This is used mainly for connection to the Programming Device. (This also supports the RS-232C Unit connection.)

RS-232 port
This is used mainly for connection to the RS-232C Unit. (This also supports a CX-Programmer connection.)

Connecting to CS-series Serial Communications Board

Serial Communications Board equipped with a RS-232C port for CS-series CPU Units: CS1W-SCB41/21

Allocation DM Area Settings for CPU Unit

Settings are written from the Programming Device (a Programming Console or CX-Programmer) directly into the allocated DM Area (PLC Setup) of the CPU Unit. After the settings are written, they become effective by turning the power ON, restarting the Unit, restarting the communication port, or execution of the STUP instruction.

The following table shows the words allocated in the DM Area and the settings.

Allocated DM word		Value	Settings
Port 1	Port 2		
DM32000	DM32010	8000	Host Link mode, 2 stop bits, even parity, data length 7 bits
DM32001	DM32011	0000	Baud rate 9,600 bps.
		0007	Baud rate 19,200 bps.
		0008	Baud rate: 38,400 bps.
		0009	Baud rate: 57,600 bps.
		000A	Baud rate: 115,200 bps.
DM32002	DM32012	0000	Transmit delay time 0 ms.
DM32003	DM32013	0000	No CTS control Unit No. 0 for Host Link

2-5 Connection to a PLC by the Host Link (RS-422A Type)

Connect the NT11 to an OMRON PLC by using the RS-422A type host link method.

If the distance between the NT11 and the PLC is greater than 15 m, this method should be used. The maximum distance over which a connection can be made is 500 m.

when using the RS-422A method, the host computer and PLC are usually connected in a 1 to N ratio (more than one PLC), but in the special case of the connection between the NT11 and PLC, the ratio is 1 to 1.

In order to make a connection to the PLC using the host link method (RS-422A type), the “Comm. Type” memory switch of the NT11 must be set to the host link, and the “Comm. Port” memory switch must be set to RS-422A. For details on memory switch settings, refer to 3-7-1 *Selecting the Host Communication Method* (page 73).

2-5-1 Compatible PLCs

When Using the Host Link Method

Compatible Host Units

Some models and series of OMRON PLCs have the RS-422A type Host Link function built in. With a CS series, CJ series, and CQM1H Board or Unit, and CQM1H, the Host Link method can be used by installing a Serial Communications Board. In addition, some C200HX/HG/HE(-Z)E devices have an integral CPU Unit that can be connected in the Host Link method by installing a Serial Communications Board.

With the CPM2A and CPM2C, an RS-422A type of 1:1 NT Link can be connected through a CPM1-CIF11 RS-422A Adapter.

Check the model and series of the PLC and the type of the installed Board or Unit before making a connection.

The following table lists the Units that are equipped with an RS-422A Host Link function compatible with the NT11.

PLC Series	Units with Built-in Host Link Function		CPU Units Connectable with Host Link Units or Expansion Serial Communications Board	Connectable to		
	Host Link Unit/ Serial Communications Board	CPU Unit				
CS Series	CS1W-SCB41-E	---	CS1G-CPU42/43/44/45-EV1 CS1H-CPU63/64/65/66/67-EV1 CS1G-CPU42H/43H/44H/45H CS1H-CPU63H/64H/65H/66H/67H	CS1G CS1H CS1G-H CS1H-H		
CJ Series	CJ1W-SCU41	---	CJ1G-CPU44/45	CJ1G		
C Series	C200H-LK202-V1	---	C200HS-CPU01/03/21/23/31/33-E C200HS-CPU01/21-EC C200HE-CPU11/32/42-E C200HE-CPU11/32/42-ZE C200HG-CPU33/43/53/63-E C200HG-CPU33/43/53/63-ZE C200HX-CPU34/44/54/64-E C200HX-CPU34/44/54/64/65/85-ZE	C200HS C200HE C200HE-ZE C200HG C200HG-ZE C200HX C200HX-ZE		
			C200HW-COM03/06-EV1	---	C200HE-CPU32/42-E C200HE-CPU32/42-ZE	C200HE C200HE-ZE
					C200HG-CPU33/43/53/63-E C200HG-CPU33/43/53/63-ZE	C200HG C200HG-ZE
					C200HX-CPU34/44/54/64-E C200HX-CPU34/44/54/64/65/85-ZE	C200HX C200HX-ZE
	---	---	CPM1-10/20/30CDR-□ +CPM1-CIF11 CPM1A-10/20/30/40CD□-□ +CPM1-CIF11	---	CPM1	
			---	---	CPM2A-30/40/60CD□-□ +CPM1-CIF11 (Peripheral port connection)	---
	---	---	CPM2C-10/20□□□□□□-□ (*1)	---	CPM2C	
---	CQM1H-SCB41	---	CQM1H-CPU51/61	CQM1H		
CVM1 Series (*2)	CV500-LK201	CVM1-CPU01-EV2 CVM1-CPU11-EV2 CVM1-CPU21-EV2	CVM1-CPU01-EV2 CVM1-CPU11-EV2 CVM1-CPU21-EV2	CVM1		
SRM1	---	SRM1-C02-V1+CPM1-CIF11	---	SRM1		

*1 Use a CPM2C-CN111 or CS1W-CN114/118 Connecting Cable, CPM1-CIF01 RS-232C Adapter, or CPM1-CIF11 RS-422A Adapter to connect.

*2 CPU Units of CVM1/CV-series PLCs without the suffix -EV□ cannot be connected.

2-5-2 Parts Required for Connection

The RS-422A cable used for RS-422A communications is not supplied by OMRON. Make this cable in accordance with the environment (PLC used and transmission distance between the NT11 and PLC).

One connector, one connector cover and one cable are required to make up a connecting cable. One connector and one connector cover is supplied with the PLC. However, a cable of the type recommended by OMRON must be prepared.

For details on making the cable, refer to *Appendix D Making the Cable* (page 153). The table below lists the components supplied with each unit and the recommended cables.

Check the required parts and prepare them in advance.

Name	Model	Maker	Remarks
Connector set	XM2S-0911-S003	OMRON	9-pin connector Connector and Connector hood
Connector	XM2A-0901	9-pin connector Made by OMRON	
Connector hood	XM2S-0911	9-pin connector Made by OMRON	
Connector set	XM2S-0911-S003	9-pin Made by OMRON, connector and hood included	
Cable	TKVVBS4P-03	Tachii Electric Wire Co., Ltd.	
Crimp terminals	1.25-N3A (fork type)	Japan Solderless Terminal MFG	Recommended cable size: AWG22 to 18 (0.3 to 0.75 mm ²)
	Y1.25-3.5L (fork type)	Molex Inc.	

- Note**
1. Always use crimp terminals for wiring.
 2. Before connecting or disconnecting cables between devices, make sure that the power supply to all of the connected devices (NT11, PLC, etc.) is OFF.

Examples of applicable terminals

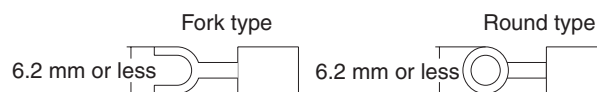

2-5-3 Method for Connection

For RS-422A type communication, an RS-422A cable is used as the transmission channel connecting the NT11 and PLC.

As shown in the figure below, the RS-422A cable is connected directly to the NT11.

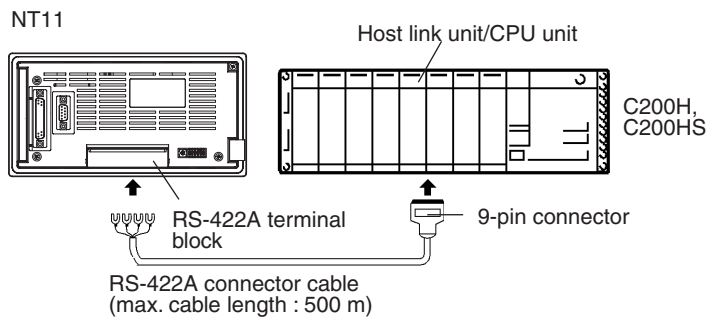

Reference Carry out class 3 grounding at the FG terminal of the PLC. For details, refer to the manual for the PLC.

Caution Switch off the NT11 power supply before connecting or disconnecting a connector.

2-5-4 Connector Specifications and Wiring for Each Unit

The combination of pin numbers to which the connecting wires are connected differs according to the connector specifications for each unit. Check the connector specifications of the unit to be connected and make the wiring connections by referring to the relevant connection combination among those indicated below.

For details on making the cable, refer to *Appendix D Making the Cable* (page 153).

[NT11 RS-422A terminal block specifications]

- Connected terminal block: RS-422A terminal block (M3.5 screws)
- Electrical characteristics: Conform to EIA RS-422A
- Signal direction: Signal input and output is relative to the NT11



Signal Name	Abbreviation	Signal Direction	
		Input	Output
Send data A	SDA (SD-)		○
Send data B	SDB (SD+)		○
Receive data A	RDA (RD-)	○	
Receive data B	RDB (RD+)	○	

- Connecting an NT11 to a C-series host link unit
 [C-series host link connector specifications]
 - Applicable host link units: C200H-LK202 (-V1)
 - Electrical characteristics: Conform to EIA RS-422A

- Signal direction: Signal input and output is relative to the host link unit.

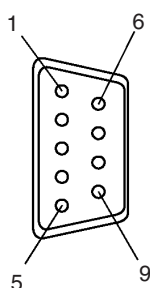

Connector Pin No.	Signal Name	Abbreviation	Signal Direction	
			Input	Output
1	Receive data B	RDB	○	
3	Signal ground	SG	—	—
5	Send data B	SDB		○
6	Receive data A	RDA	○	
7	Frame ground	FG	—	—
9	Send data A	SDA		○

[Wiring connections]

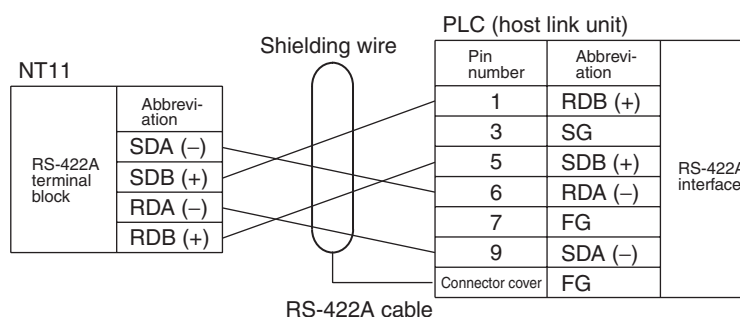

2-5-5 PLC Switch Settings

When the NT11 and PLC are connected to each other, set the conditions at the PLC host link unit or the CPU as given in the table below.

The following is a general description of switch settings.

Refer to the manual for respective units for the details of the switch settings.

Item	Switch Setting
I/O port	RS-422A
Baud rate	Set the same baud rate as the NT11
Transfer code	ASCII 7 data bits, 2 stop bits
Parity	Even
1-to-1/1-to-N	1-to-N (*1)
Instruction level	Level 1, 2, 3
Unit No.	00

*1: The 1-to-N setting enables BCC (Block Check Character). It is not possible to connect more than one NT11 in a single host link.

Connecting to a C-series Host Link Unit

C200H/C200HS/C200HE(-Z)E/C200HG(-Z)E/C200HX(-Z)E
Rack-mounting model: C200H-LK201-V1

Setting the Front Switches

Set each switch with a flat blade screwdriver so that the values or symbols in the setting value window agree with the following:

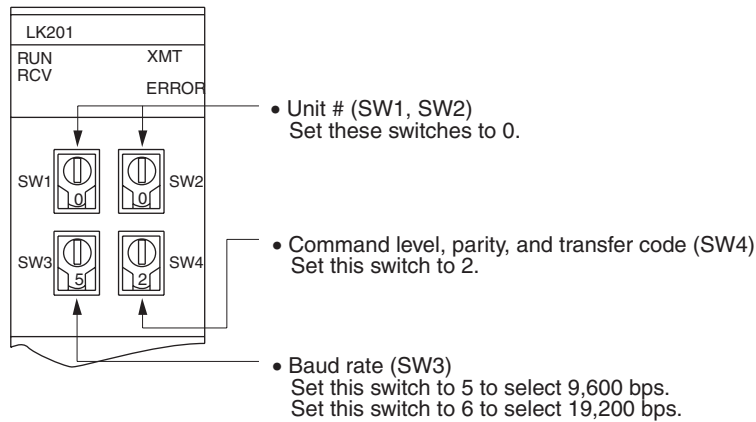

Setting the Rear Switches

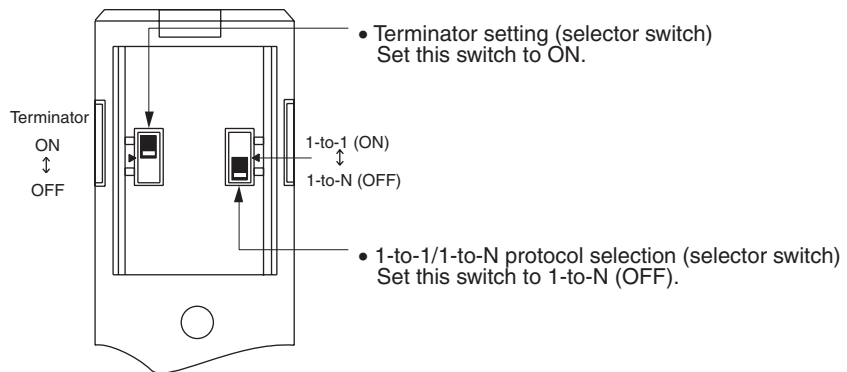

Connecting to a CVM1/CV-series Host Link Unit

CVM1/CV-series Rack-mounting model: CV500-LK201

A CVM1/CV-series Host Link Unit (CV500-LK201) has two connectors (communication ports 1 and 2). To use the RS-422A type Host Link method, set communication port 2 to RS-422A.

Communication port 2 is a 9-pin connector that allows selection of the RS-232C or RS-422A method. When this port is used with the RS-422A method, the I/O port selector switch on the front of the Unit must be set to RS-422A (the lower position).

CPU Bus Unit Settings

When connecting to a CVM1/CV-series Host Link Unit, set the following communication conditions for the CPU Bus Unit settings.

Item	Setting at Host
Baud rate	Set the same speed as for the NT11. (*1)
Transfer code	ASCII, 7 data bits, 2 stop bits
Parity	Even
1-to-1/1-to-N	1-to-N(*2)
Command level	Level 1, 2, 3

*1 Set the Host Link baud rate at 9,600 bps or 19,200 bps with the Comm. Speed memory switch at the NT11. For details, refer to *Setting the Host Link Method* (page 74).

*2 The 1-to-N setting enables BCC (Block Check Character). It is not actually possible to connect more than one NT11 in a single Host Link.

Set the CPU Bus Unit settings directly from a Programming Device (e.g., SYSMAC Support Software).

For details on the CPU Bus Unit settings, refer to the *SYSMAC CVM1/CV-series Host Link Unit Operation Manual* (W205-E1-□).

Setting the Front Switches

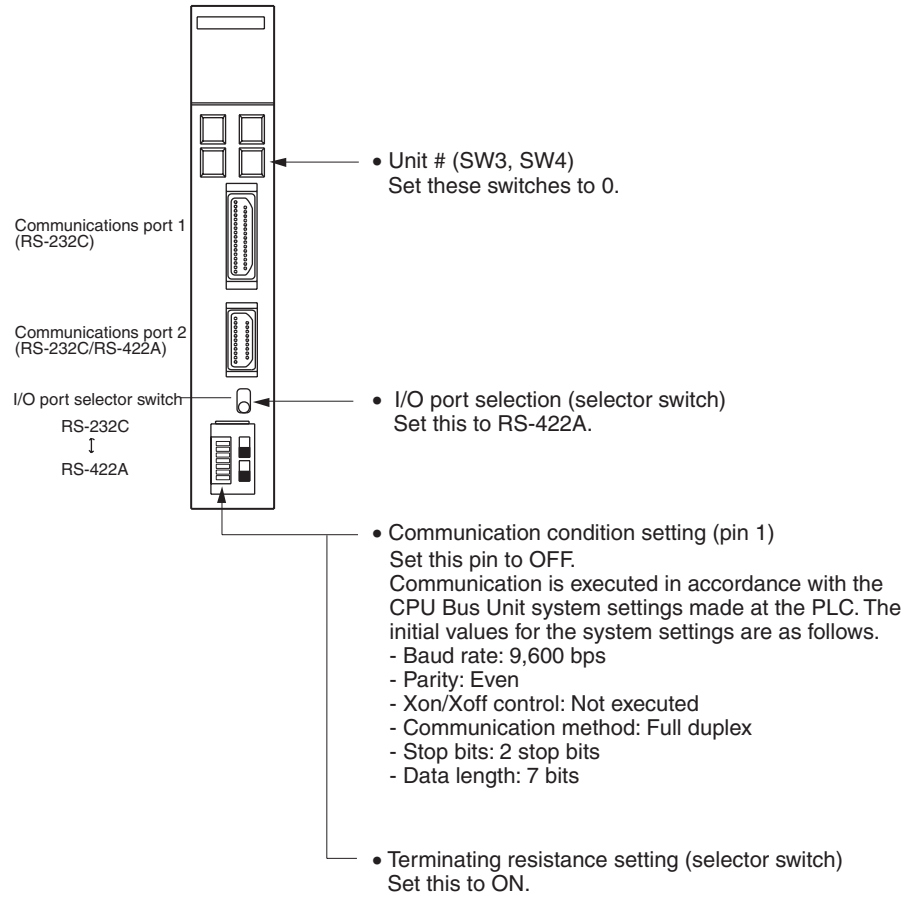

Connecting to a CJ-series Serial Communications Unit

CJ-series: CJ1W-SCU41 (Port 1 is an RS-422A/485 port.)

Setting the Front Switches

Set the unit number of the Serial Communications Unit with the rotary switch on the front of the Unit. Set the unit number with a flat blade screwdriver. Also, set the communications mode switch to select 4-wire (RS-422A) communications and turn ON the terminator switch to enable the terminating resistance.

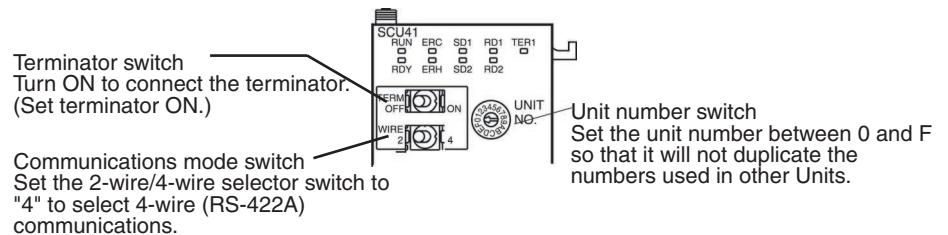

Allocation DM Area Settings for CPU Unit

Settings are written from the Programming Device (a Programming Console or CX Programmer) directly into the allocated DM Area (PLC Setup) of the

CPU Unit. After the settings are written, they become effective by turning the power ON, restarting the Unit, restarting the communication port, or execution of the STUP instruction.

The following table shows the words allocated in the DM Area and the settings.

$$m = DM30000 + 100 \times \text{unit number}$$

Allocated DM word	Value	Settings
Port 1		
m	8000	Host Link mode, 2 stop bits, even parity, data length 7 bits
m+1	0000	Baud rate 9,600 bps.
	0007	Baud rate 19,200 bps.
	0008	Baud rate: 38,400 bps.
	0009	Baud rate: 57,600 bps.
	000A	Baud rate: 115,200 bps.
m+2	0000	Transmit delay time 0 ms.
m+3	0000	No CTS control Unit No. 0 for Host Link

Connecting to a CPU Unit

CVM1/CV-series (-EV□) CPU Units

CVM1-CPU01-EV2/CVM1-CPU11-EV2/CVM1-CPU21-EV2

PLC Setup

When connecting to a CVM1/CV-series CPU Unit, set the following communication conditions for the PLC Setup.

Item	Setting at Host
Baud rate	Set the same baud rate as for the NT11. (*1)
Stop bits	2 stop bits
Parity	Even
Data length	ASCII 7 bits
Unit #	00

*1 Set the Host Link baud rate at 9,600 bps or 19,200 bps with the Comm. Speed memory switch at the NT11. For details, refer to *Setting the Host Link Method* (page 74).

Set the PLC Setup directly from a Programming Device (e.g., SYSMAC Support Software).

For details on the PLC Setup, refer to the *SYSMAC CVM1/CV500/CV1000/CV2000 Operation Manual: Ladder Diagrams (W202-E1-□)*.

Setting the Front Switches

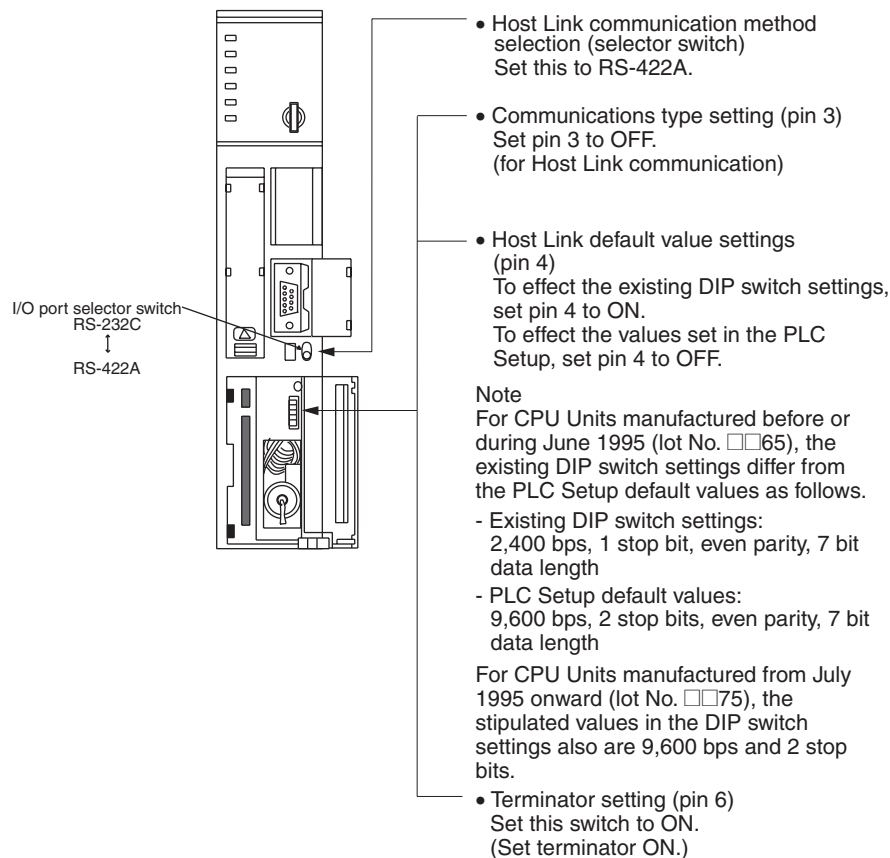

C200HX/HG/HE(-Z)E, CPM1, CPM2A, CPM2C, CQM1H, or SRM1

The connection method depends upon the model of PLC being used, as shown in the following table.

PLC model	Connection method
C200HX/HG/HE(-Z)E	• Connect to the RS-422A port (port A) on a Serial Communications Board.
CQM1H	• Connect to the RS-422A port (port 2) on a Serial Communications Board.
CPM1	• Connect to the peripheral port through a CPM1-CIF11 RS-422A Adapter.
CPM2A, SRM1	• Connect to the peripheral port through a CPM1-CIF11 RS-422A Adapter.
CPM2C	• Connect to the peripheral port (on a CPM2C-CN111 or CS1W-CN114 Connecting Cable) through a CPM1-CIF11 RS-422A Adapter. (The CPM2C-CN111 splits the Unit's Communication Port into a RS-232C port and a peripheral port.)

Reference

- There are no Serial Communications Boards for the C200HX/HG/HE(-Z)E in which port B is the RS-422A port.
- There are no Serial Communications Boards for the CQM1H in which port 1 is the RS-422A port.

PLC Setup Settings

When connecting to a C200HX/HG/HE(-Z)E or CPM1, CPM2A, CPM2C, CQM1H CPU Units or SRM1, set the following communication conditions for the PLC Setup.

Item	Setting at Host
I/O port	RS-422A
Communication mode	Host Link mode
Baud rate	Set the same baud rate as for the NT11. (*1)
Stop bits	2 stop bits
Parity	Even
Data length	ASCII 7 bits
Unit #	00

*1 Set the Host Link baud rate at 9,600 bps or 19,200 bps with the Comm. Speed at the NT11. For details, refer to *Setting the Host Link Method* (page 74).

Set the PLC Setup settings directly from a Programming Device (e.g., CX-Programmer).

For details on operations relating to the PLC Setup, refer to the manual for the PLC that is used.

The PLC Setup addresses and settings to be made depending on the Unit to which the connection is made are shown below.

When using port A of the Serial Communications Board of C200HX/HG/HE(-Z)E

Word	Writing Value	Settings
DM6555	0001	Host Link mode, no CTS control Communication conditions set by the contents of DM
DM6556	0303	Data length 7 bits, 2 stop bits, even parity, baud rate: 9,600 bps
	0304	Data length 7 bits, 2 stop bits, even parity, baud rate: 19,200 bps
DM6558	0000	Unit # 00

When using a CPM1, CPM2A, CPM2C, SRM1

Word	Writing Value	Settings
DM6650	0001	Host Link mode, no CTS control Communication conditions set by the contents of DM
DM6651	0303	Data length 7 bits, 2 stop bits, even parity, baud rate: 9,600 bps
	0304	Data length 7 bits, 2 stop bits, even parity, baud rate: 19,200 bps
DM6653	0000	Unit # 00

When using a CQM1H

Word	Writing Value	Settings
DM6550	0001	Host Link mode, no CTS control Communication conditions set by the contents of DM
DM6551	0303	Data length 7 bits, 2 stop bits, even parity, baud rate: 9,600 bps
	0304	Data length 7 bits, 2 stop bits, even parity, baud rate: 19,200 bps
DM6553	0000	Unit # 00

Connecting to a CPM2C

Only the CPM2C PLCs do not have the same kind of port connectors found on CS/CJ-series PLCs. The CPM2C's communication port handles both RS-232C and peripheral port connections, which are divided internally. Therefore, when using the CPM2C, it is necessary to select RS-232C or peripheral port connections, according to the kind of cable and port (on the cable) used, as shown in the following table. Refer to the *CPM2C Operation Manual* for more details.

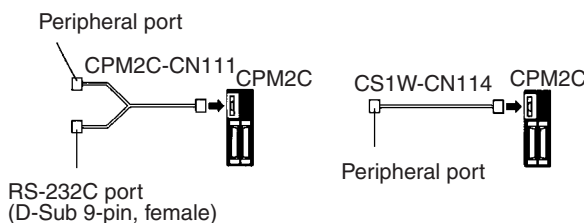

Setting Switches on a C200HX/HG/HE(-Z)E Serial Communications Board

Set the switches on a C200HX/HG/HE(-Z)E Serial Communications Board as follows.

Switch 1: Set to 4 (4-wire, for RS-422A)

Switch 2: Set to ON for terminator ON (terminating resistance applied)

Setting Switches on a CQM1H Serial Communications Board

Set the switches on a CQM1H Serial Communications Board as follows.

Wire selection (WIRE): Set to 4 (4-wire, for RS-422A)

Terminator (TERM): Set to ON for termination ON.

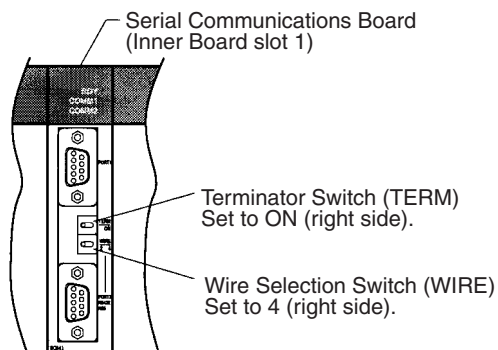

Setting the Switches on an RS-422A Adapter

Set the terminator selector switch to ON (upper position).

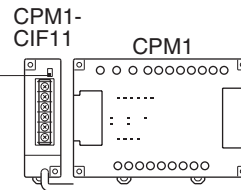

Connecting to a CS-series Serial Communications Board

Serial Communications Board with RS-422A/485 port equipped for CS-series CPU Unit Model:

CS1W-SCB41 (The port 2 is RS-422A/485 port.)

Setting the Front Switches

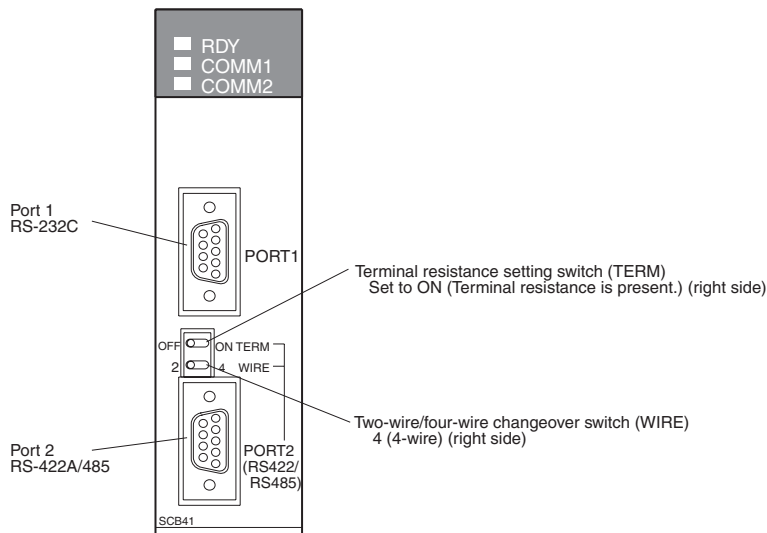

Allocated DM Area Settings for CPU Unit

Settings are written from the Programming Device (a Programming Console or CX-Programmer) directly into the allocated DM Area settings (PLC Setup) of the CPU Unit. After the settings are written, they become effective by turning the power ON, restarting the Unit, restarting the communication port, or executing the STUP instruction.

The following table shows the words allocated in the DM Area and the settings.

Allocated DM word	Value	Settings
Port 2		
DM32010	8000	Host Link mode, 2 stop bits, data length 7 bits, even parity,
DM32011	0000	Baud rate 9,600 bps.
	0007	Baud rate 19,200 bps.
	0008	Baud rate: 38,400 bps.
	0009	Baud rate: 57,600 bps.
	000A	Baud rate: 115,200 bps.
DM32012	0000	Transmit delay time 0 ms.
DM32013	0000	No CTS control Unit No. 0 for Host Link

2-6 Connection to a PLC by the NT Link (RS-232C Type)

Connect the NT11 to an OMRON PLC by the NT link method.

To connect the NT11 to a PLC by the NT link method, the NT11 memory switch for “host communication” must be set for the NT link. For the “host communication” setting, refer to *3-7-1 Selecting the Host Communication Method* (page 73).

2-6-1 Compatible PLCs

Some models and series of OMRON PLCs have the host link function built in. Check the model and series of the PLC against the type of host link unit before marking the connections.

The compatible PLCs are listed in the table below.

Using the 1:1 NT Link

Compatible Host Units

Some models and series of OMRON PLCs have the 1:1 NT Link function built in. With CQM1H PLCs, a Serial Communications Board can be added to provide 1:1 NT Link communications. Some C200HX/HG/HE(-Z)E CPU Units can be connected by the 1:1 NT Link by installing a Communication Board.

Check the model and series of the PLC against the model of CPU Unit before making the connections.

The hosts that can be connected to the NT11 by the 1:1 NT Link using the RS-232C ports of both Units are indicated in the table below.

PLC Series	CPU Units with Built-in NT Link Function	CPU Units Connectable with Expansion Communication Board ^(*1)	Connectable to
C Series	C200HS-CPU21-E, -EC C200HS-CPU23-E C200HS-CPU31-E C200HS-CPU33-E	---	C200HS
	C200HE-CPU42-(Z)E	C200HE-CPU32-(Z)E C200HE-CPU42-(Z)E	C200HE (-Z)E
	C200HG-CPU43-(Z)E C200HG-CPU63-(Z)E	C200HG-CPU33-(Z)E C200HG-CPU43-(Z)E C200HG-CPU53-(Z)E C200HG-CPU63-(Z)E	C200HG (-Z)E
	C200HX-CPU44-(Z)E C200HX-CPU64-(Z)E X200HX-CPU65-ZE C200HX-CPU85-ZE	C200HX-CPU34-(Z)E C200HX-CPU44-(Z)E C200HX-CPU54-(Z)E C200HX-CPU64-(Z)E C200HX-CPU65-ZE C200HX-CPU85-ZE	C200HX (-Z)E
	CPM1-10CDR-□ ^(*2) CPM1-20CDR-□ ^(*2) CPM1-30CDR-□ ^(*2) CPM1A-10CD□-□ ^(*2) CPM1A-20CD□-□ ^(*2) CPM1A-30CD□-□ ^(*2) CPM1A-40CD□-□ ^(*2)	---	CPM1
	CPM2A-30CD□□-□ CPM2A-40CD□□-□ CPM2A-60CD□□-□	---	CPM2A
	CPM2C-10□□□□□□-□ ^(*3) CPM2C-20□□□□□□-□	---	CPM2C
	CQM1-CPU41-EV1 CQM1-CPU42-EV1 CQM1-CPU43-EV1 CQM1-CPU44-EV1 CQM1-CPU45-EV1	---	CQM1
	CQM1H-CPU21-E CQM1H-CPU51-E CQM1H-CPU61-E	CQM1H-CPU51 ^(*4) CQM1H-CPU61 ^(*4)	CQM1H
	CVM1 Series ^(*5)	CVM1-CPU01-EV2 CVM1-CPU11-EV2 CVM1-CPU21-EV2	---
CompoBus/S Master Unit	SRM1-C02-V2	---	SRM1

*1 One of the following Communication Boards is required: C200HW-COM02/COM04/COM05/COM06-EV1.

*2 A CPM1-CIF01 adapter is required.

*3 Use a CPM2C-CN111 or CS1W-CN114/118 Connecting Cable, CPM1-CIF01 RS-232C Adapter, or CPM1-CIF11 RS-422A Adapter to connect.

*4 A CQM1H-SCB41 Serial Communications Board is required.

*5 CPU Units of CVM1/CV-series PLCs without the suffix -EV□ cannot be connected.

Reference CS/CJ-series CPU Unit cannot be connected with the 1:1 connection NT link method. Use the Host Link method (up to 115,200 bps).

Settings at The Host

The setting methods for each Unit are as follows:

Connecting to a C-series C200HS, C200HX/HG/HE(-Z)E, CPM1, CPM2A, CPM2C, CQM1, CQM1H, or SRM1

PLC Setup Settings

Write the PLC Setup (in the DM Area) settings directly from a Programming Device (e.g., SYSMAC Support Software) in accordance with the host model and port.

Host Model	Word	Writing Value	Setting
RS-232C port of C200HS, C200HX/HG/HE(-Z)E, CPM2A, CPM2C, CQM1, CQM1H, SRM1	DM6645	4000	Use 1:1 NT Link
Port A of C200HX/HG/HE(-Z)E (*1) Port 1 of CQM1H (*2)	DM6555		
Port B of C200HX/HG/HE(-Z)E (*1)	DM6550		
CPM1	DM6650		

*1 RS-232C port of the Communication Board

*2 RS-232C port of the Serial Communications Board

For details on operations relating to the PLC Setup, refer to the manual for the PLC that is used.

Connecting to a CPM2C

The CPM2C PLCs do not have the same kind of port connectors found on CS/CJ-series PLCs. The CPM2C's communication port handles both RS-232C and peripheral port connections, which are divided internally. Therefore, when using the CPM2C, it is necessary to select RS-232C or peripheral port connections, according to the kind of cable and port (on the cable) used, as shown in the following table. Refer to the *CPM2C Operation Manual* for more details.

Port connecting to PT	PLC Setup
RS-232C port (D-Sub 9-pin) of CPM2C-CN111	Built-in RS-232C port settings
Peripheral port of CPM2C-CN111	Peripheral port settings
RS-232C port (D-Sub 9-pin) of CS1W-CN118	Built-in RS-232C port settings
Peripheral port of CS1W-CN114	Peripheral port settings

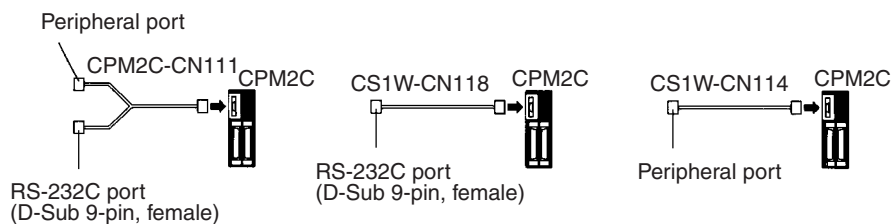

Setting the DIP Switches on the Front of a C200HX/HG/HE(-Z)E, CQM1, CQM1H

When using a C200HX/HG/HE(-Z)E, CQM1, or CQM1H, the DIP switches on the front panel must be set as shown below in order to make the settings in the PLC Setup (data memory) effective.

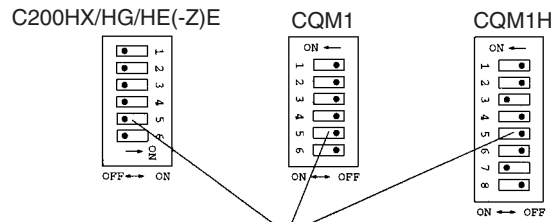

RS-232C port communication condition setting
Set pin 5 to OFF to make the settings made in PLC Setup effective.

Setting the Switches of a CPM2A

When using a CPM2A, the switches on the front panel must be set as shown below in order to make the PLC Setup settings effective.

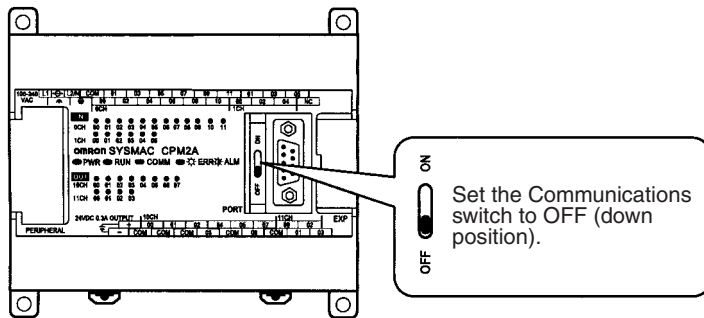

Setting the Switches of a CPM2C

When using a CPM2C, the switches on the front panel must be set as shown below in order to make the PLC Setup settings effective.

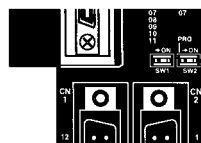

The settings for SW1 and SW2 depend upon the usage of the peripheral port and RS-232C port.

- Connecting PT to peripheral port
- Connecting PT to built-in RS-232C port
(A device that requires non-standard communications settings is connected to the peripheral port.)



- Connecting PT to built-in RS-232C port
(A Programming Console is connected to the peripheral port.)



Setting the Switches on an RS-232C Adapter

When using a CPM1-CIF01 RS-232C Adapter, set the mode switch as shown in the following diagram.

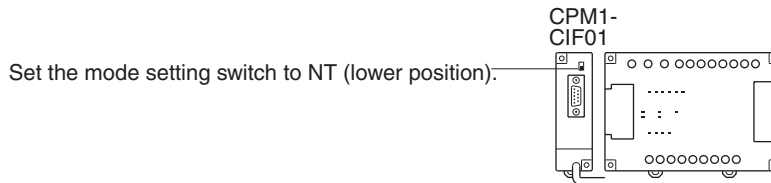

Connecting to CVM1/CV Series (-EV□)

Set the DIP switch on the front panel as follows:

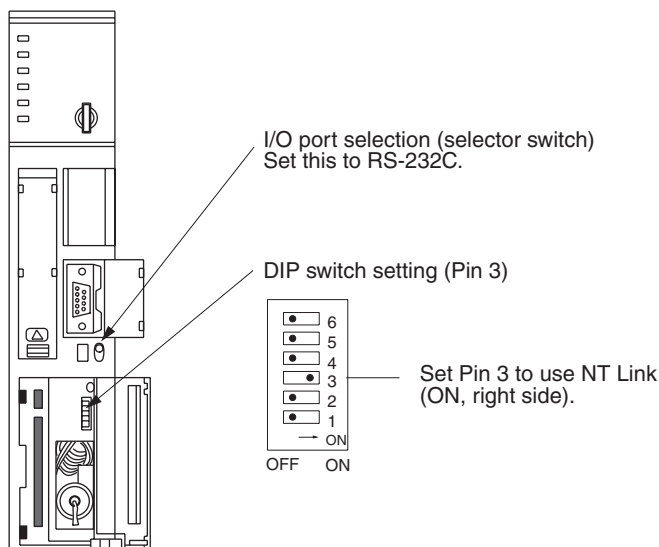

When using a CVM1/CV-series PLC, CPU Unit execution processing (execution control 2) in the PLC Setup must be set to Simultaneous processing.

2-6-2 Connecting the NT11

Refer to the illustrations below to select the appropriate cable for the unit connectors and connect the NT11 to the PLC.

To make a connector cable, refer to *Appendix D Making the Cable* (page 153).

Caution After connecting a communication cable, always secure it with the screws. Otherwise the cable may disconnect, causing operation to fail.

Caution The cable's tensile load is 30 N. Do not subject it to loads greater than this. Otherwise a discontinuity may occur, causing operation to fail.

Use a connector cable with a 9-pin connector on both ends to connect the NT11 to a PLC with a 9-pin connector.

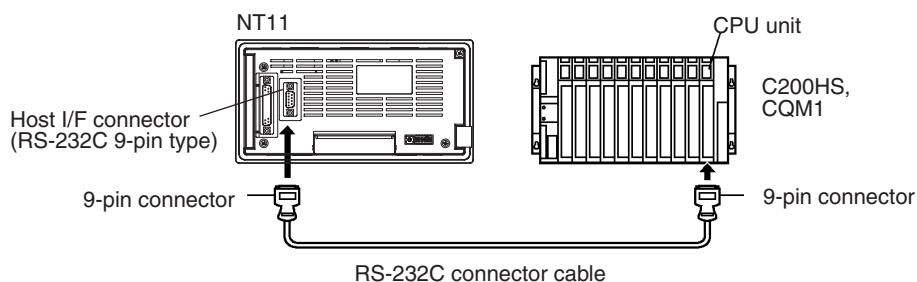

2-7 Connection to a PLC by the NT Link (RS-422A Type)

Using the 1:1 NT Link Method

Compatible Host Units

Some models and series of OMRON PLCs have the RS-422A 1:1 NT Link function built in.

- The C200HX/HG/HE(-Z)E CPU Units can be connected by the RS-422A 1:1 NT Link method by installing a Serial Communications Board.
- The CQM1H CPU Units can be connected by the RS-422A 1:1 NT Link method by installing a Serial Communications Board.

Check the model and series of the PLC and the type of installed Serial Communications Board before making connections.

The following table lists the Units that are equipped with an RS-422A 1:1 NT Link function compatible with the NT11.

PLC Series	CPU Units with Built-in RS-422A 1:1 NT Link Function	Model Name	
C Series	C200HE-CPU32-(Z)E ^(*1) C200HE-CPU42-(Z)E ^(*1)	C200HE (-Z)E	
	C200HG-CPU33-(Z)E ^(*1) C200HG-CPU43-(Z)E ^(*1) C200HG-CPU53-(Z)E ^(*1) C200HG-CPU63-(Z)E ^(*1)	C200HG (-Z)E	
	C200HX-CPU34-(Z)E ^(*1) C200HX-CPU44-(Z)E ^(*1) C200HX-CPU54-(Z)E ^(*1) C200HX-CPU64-(Z)E ^(*1) C200HX-CPU65-ZE ^(*1) C200HX-CPU85-ZE ^(*1)	C200HX (-Z)E	
	CQM1H-CPU51/61 ^(*2)	CQM1H	
	CVM1 Series ^(*3)	CVM1-CPU01-EV2 CVM1-CPU11-EV2 CVM1-CPU21-EV2	CVM1

*1 One of the following Serial Communications Boards is required:
C200HW-COM03-EV1 or C200HW-COM06-EV1.

*2 A CQM1H-SCB41 Serial Communications Board is required.

*3 CPU Units of CVM1/CV-series PLCs without the suffix -EV□ cannot be connected.

The 1:1 NT Link method cannot be used using RS-485. To use the 1:1 NT Link method, connect by RS-422A.

NT link connection using RS-422A/485 is not possible with the CPM1, CPM2A, and CPM2C.

Settings at the Host

The setting methods for each model of Unit are described below.

- Connecting to a CVM1/CV-series (-EV□) CPU Units
CVM1-CPU01-EV2/CVM1-CPU11-EV2/CVM1-CPU21-EV2

PLC Setup

When connecting to the CVM1/CV-series CPU Unit by the 1:1 NT Link method, no particular settings are required at the PLC Setup.

Setting the Front Switches

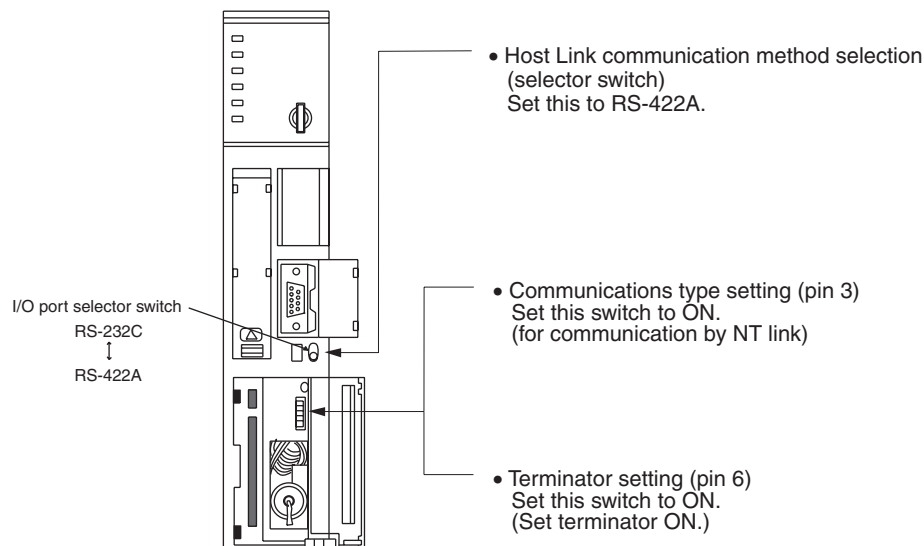

Connecting to a C-series C200HX/HG/HE(-Z)E or CQM1H

PLC Setup Settings

Write the PLC Setup (data memory) settings directly from a Programming Device (e.g., CX-Programmer) in accordance with the host model.

Host Model	Word	Writing Value	Setting
Port A of C200HX/HG/HE(-Z)E*1	DM6555	4000	Use 1:1 NT Link
Port 2 of CQM1H*2	DM6550	4000	

*1 RS-422A port of the Serial Communications Board

*2 RS-422A port of the Serial Communications Board

For details on operations relating to the PLC Setup, refer to the manual for the PLC you are using.

Setting the DIP Switches on a C200HX/HG/HE(-Z)E Serial Communications Board

Set the switches on a C200HX/HG/HE(-Z)E Serial Communications Board as follows.

Switch 1: Set to 4 (4-wire, for RS-422A)

Switch 2: Set to ON for terminator ON (terminating resistance applied)

Setting Switches on a CQM1H Serial Communications Board

Set the switches on a CQM1H Serial Communications Board as follows.

Wire selection (WIRE): Set to 4 (4-wire, for RS-422A)

Terminator (TERM): Set to ON for termination ON.

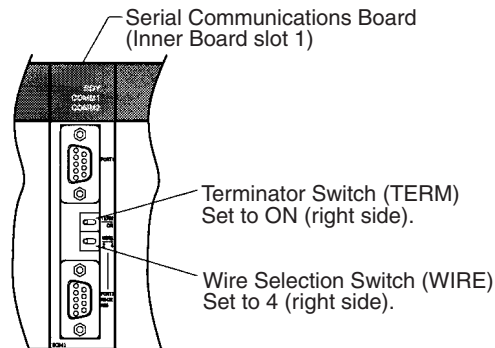

2-8 Connecting a Printer

Daily reports and display histories can be printed onto a printer connected to the NT11.

2-8-1 How to Connect

Connect the printer to the NT11 with a Centronics cable. The length of the cable should not exceed 3 meters.

Caution If the connection cable is connected or disconnected while the power of the printer is on, the NT11 may malfunction. Make sure to turn off the power of the printer before connecting or disconnecting the connection cable.

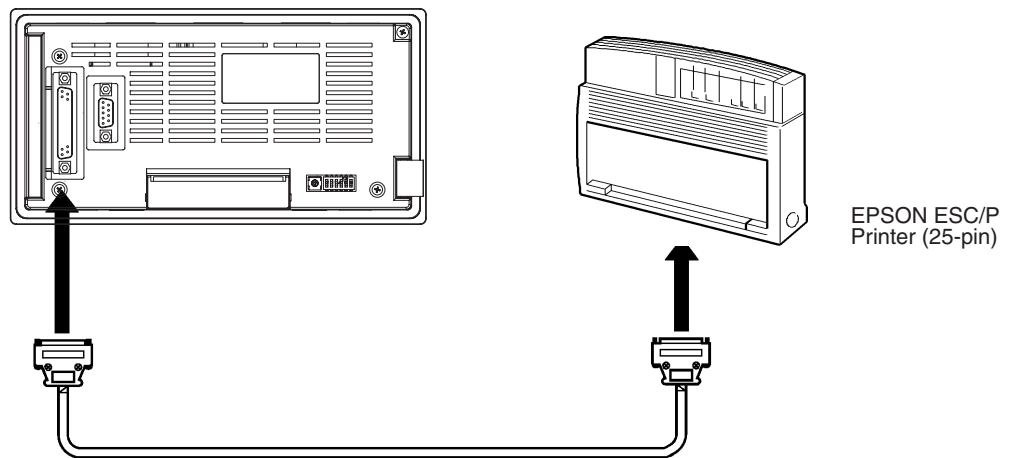

• Recommended printer

EPSON ESC/P Printer (25-pin)

If using other printer, such printer should conform to ESC/P 24-J81, which is the printer control standard of Epson.

SECTION 3

System Menu Operation

This section describes the operation of the System Menu focusing on the procedure to start up the NT11.

Functions which will be convenient to use the NT11 and those which are useful for the system maintenance are also explained here.

3-1	Operation Flow by the System Menu	60
3-2	Starting the NT11	60
3-2-1	Changing the System Settings etc.	61
3-3	Operation Modes and the System Menu	61
3-3-1	System Menu and the Operation Modes.	61
3-3-2	Menu Tree.	62
3-3-3	Operations with the System Menu	62
3-4	Initializing Memory	64
3-4-1	Initialization of the Screen Data.	64
3-4-2	Initialization by Using the DIP Switch (Forced Initialization).	65
3-5	Transferring the System Program	66
3-6	Registering the Screen Data	69
3-7	Setting the Conditions of Communications with the PLC by Using the Memory Switches	71
3-7-1	Selecting the Host Communication Method.	73
3-7-2	Selecting the Host Link Communication Speed.	74
3-7-3	Selecting the Automatic Restart Function	75
3-7-4	Selecting the Channel for Communication with the PLC	76
3-7-5	Selecting the History Data Property	77
3-8	Starting the Operation	77
3-9	Backlight OFF.	78
3-9-1	Turning the Backlight Back ON.	78
3-9-2	Backlight OFF Function.	78
3-10	System Maintenance	80
3-10-1	I/O Check	80
3-10-2	PT Setting Check	84

3-1 Operation Flow by the System Menu

Follow the procedure below when using the NT11 for the first time or when changing the system.

Create the Screen Data

Create the screen data to be displayed on the NT11 by using a support tool. For the screen data creation, refer to the “NT-series NT11 Support Tool Operation Manual” (V030-E1-1).

Start Up the NT11 (Display the System Menu.) (page 60)

Turn ON the power to the NT11.

When no screen data has been registered, the “SYSTEM MENU” will be displayed. If the NT11 enters the RUN mode, press appropriate function keys to display the System Menu.

Initialize Memory (page 64)

Select a System Menu and initialize the NT11 unit memory.

Transfer the System Program

Connect the NT11 to the system transfer tool and transfer the system program from the system transfer tool to the NT11.

For details on connecting the NT11 to the system transfer tool, refer to *3-5 Transferring the System Program* (page 66).

Transfer the Screen Data (page 69)

Connect a support tool to the NT11 and transfer the screen data from the support tool to the NT11.

For the connection of a support tool, refer to *2-3 Connecting to the NT Support Tool* (page 22).

Memory Switch Setting (page 71)

Select the System Menu and set the conditions for communications with the PLC using the memory switch.

Start the Operation (page 77)

Connect to the PLC and start the operation.

System Maintenance (page 78)

If an error has occurred during operation, check the I/Os, settings, etc. referring to this guide.

3-2 Starting the NT11

When the NT11 is started, it will enter the RUN mode if system settings and screen data registration have been completed. If no screen data has been registered or the screen data are destroyed, the System Menu will be displayed.

Before turning ON the power, check the following DIP switch settings on the NT11.

- SW2-2 “Screen data forced initialize effective/ineffective” is set to OFF (ineffective).
- DIP SW2-6, “system program erase”, is OFF.

For the DIP switch settings of the unit, refer to *2-1-2 DIP Switch Settings* (page 18).

3-2-1 Changing the System Settings etc.

Follow the procedure below to change the system settings or screen data contents.

Procedure

1. Switch on the power to the NT11 with two function keys held down to display the System Menu, then change the system settings. For the method for calling the System Menu, refer to *3-3-3 Operations with the System Menu* (page 62).

Reference

If the NT11 has failed to start up normally; an error message is displayed or no screen is displayed, memory needs to be initialized.

For the memory initializing procedure, refer to *3-4 Initializing Memory* (page 64).

3-3 Operation Modes and the System Menu

The NT11 operates in either “RUN”, “Transmit”, or “Maintenance” mode. The operation modes can be switched by using the System Menu.

3-3-1 System Menu and the Operation Modes

Select an operation mode by locating the cursor on the required item with the [↑] [↓] keys, then press [Enter] to confirm the selection. The operation modes with respect to the System Menu are related to each other as shown below.

For the operations with the System Menu, refer to *3-3-3 Operations with the System Menu* (page 62).

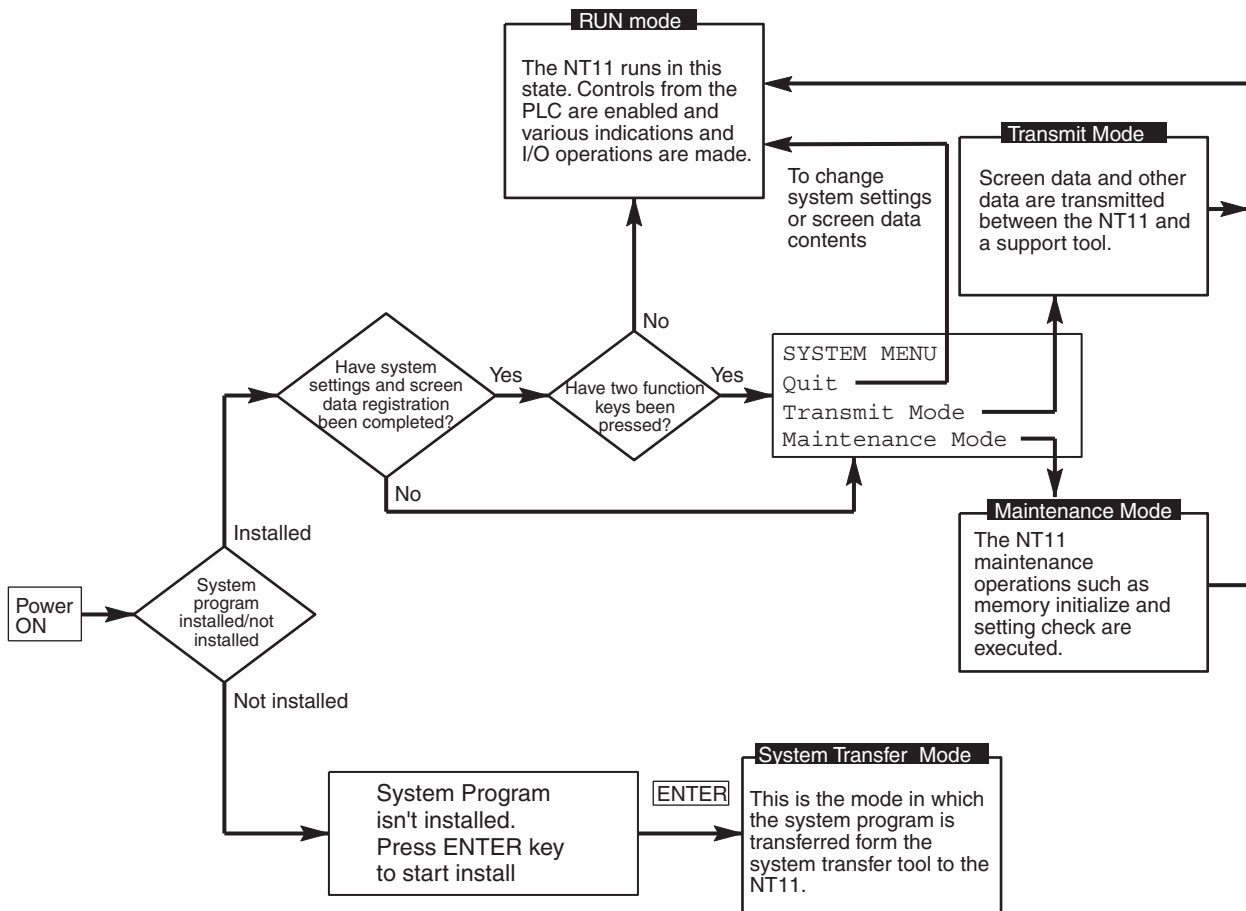

3-3-2 Menu Tree

The System Menu allows to effect various NT11 functions by using the System keys. The NT11’s functions with respect to the System Menu are related as shown below.

For the operations with the System Menu, refer to 3-3-3 Operations with the System Menu (page 62).

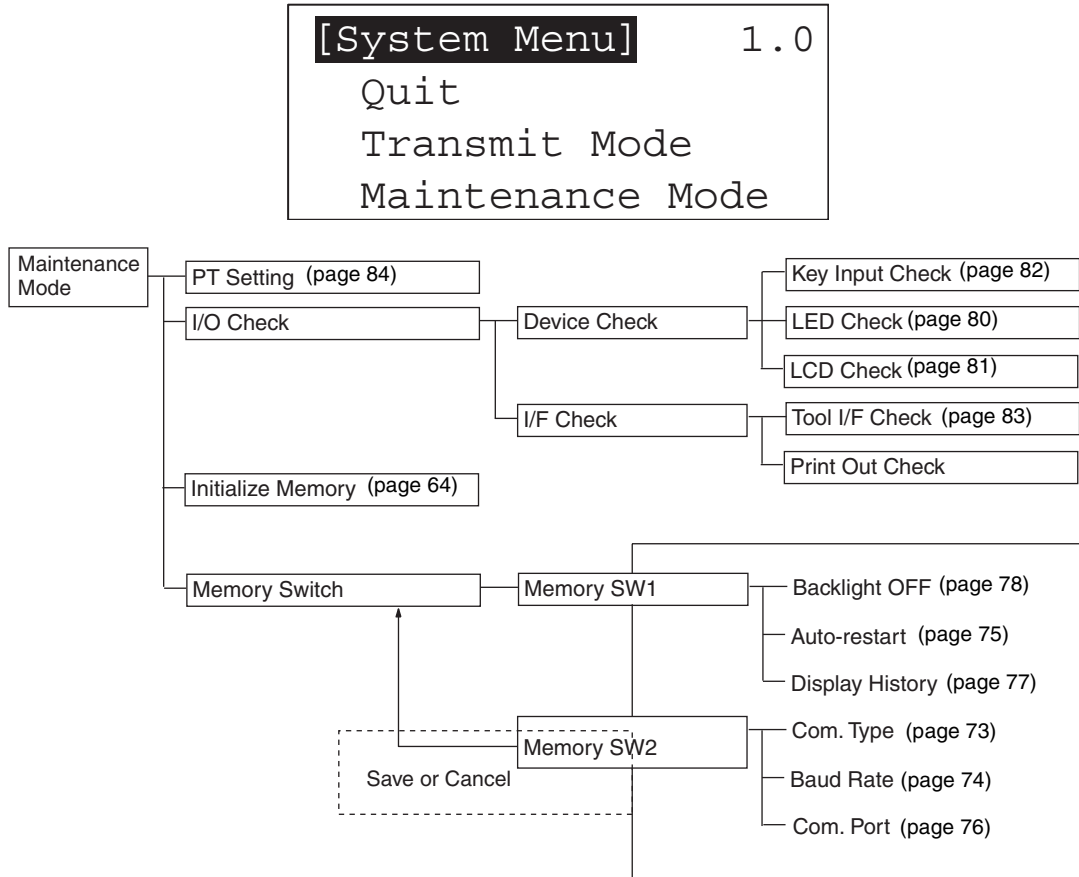

3-3-3 Operations with the System Menu

The following gives the procedure to call the System Menu, select the menu items, and other operations with the System Menu.

Note Make sure that DIP SW2-4 “Switching to the System Menu enabled/disabled” is set to OFF (enabled). If the setting is ON (disabled), the System Menu will not be displayed by following the procedure given below.

Displaying the System Menu

The system menu can be displayed by switching on the power while any two of the four function keys are held down.

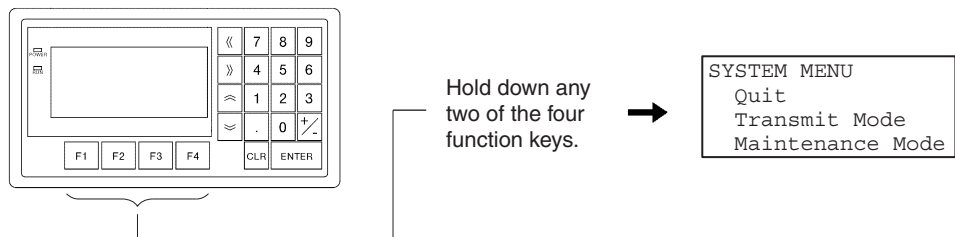



Basic key operations in the maintenance mode

Operation	Function
Any two function keys	Cancel
[ENTER] key	Set/execute
Arrow keys	Cursor motion

Note that on the screen for confirming erasure of the system program, the “Cancel” and “Set/execute” keys are displayed in reverse video in order to prevent mistaken deletion of the program.

Selecting the Menu Items

Press the  or  key on the panel of the NT11 to move the highlighting up or down. When the required item is highlighted, press the “ENTER” key to select it.

Menu items allow to make the ON/OFF selection or to call subsequent menu or screen.

Example 1

To call the “Maintenance Mode Menu” by selecting the “Maintenance Mode” on the System Menu screen:

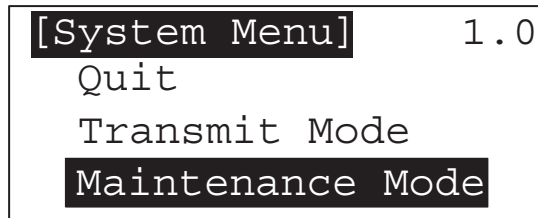

Select “Maintenance Mode” with the  key, then press “ENTER”.

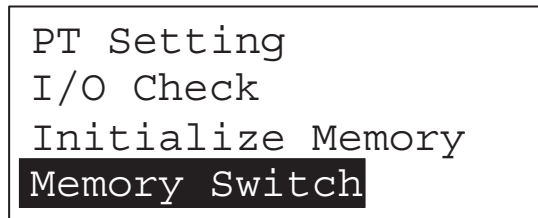

System Menu Items

The System Menu items and their functions are given below.

Menu Item	Function
Quit	The System Menu screen is cleared and the NT11 will return to the RUN mode.
Transmit Mode	The Transmit Mode screen will be displayed to allow the transmission of the screen data between the NT11 and the support tool. For the transmission of the screen data, refer to <i>3-6 Registering the Screen Data</i> (page 69).
Maintenance Mode	The Maintenance Mode menu will be displayed to allow the maintenance of the NT11 system.

Switching from the System Menu to the RUN mode

The NT11 will exit the System Menu and switch to the RUN mode in the cases mentioned below.

- Selecting “Quit” in the System Menu.
- The screen (System keys) is not pressed for over 10 seconds.

3-4 Initializing Memory

If the NT11 is used for the first time or if the screen data is ruined and the NT11 cannot be normally started, the memory needs to be initialized.

The memory initialization is required in the cases mentioned below.

- When the NT11 is used for the first time or when an error message indicating that the screen data is ruined etc. when the NT11 is started.
- When the screen has disappeared during the start-up or operation.

Use the NT11 DIP SW2-2 “Screen data forced initialize effective/ineffective”; initializes the memory.

Reference When an error has occurred, the error messages such as “Screen data corrupted” will be displayed. For the error messages displayed on the screen, refer to 6-2 *Responding to Displayed Error Messages* (page 138).

Note Initializing the screen data memory will erase entire screen data registered in the NT11. Make sure that there are backup copies of the screen data on floppy disks before starting the initialization.

3-4-1 Initialization of the Screen Data

The screen data can be initialized by either of the following two methods.

- Initialization by using the System Menu
- Initialization by using the DIP switch

Initialization by using the System Menu

Initialize the image data memory by following the procedure given below.

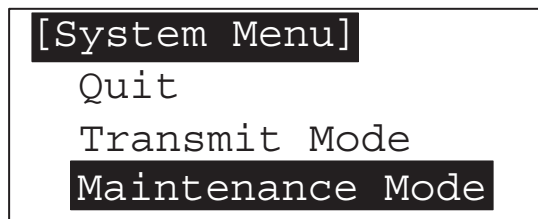

Select “Maintenance Mode” with the key, then press “ENTER”.

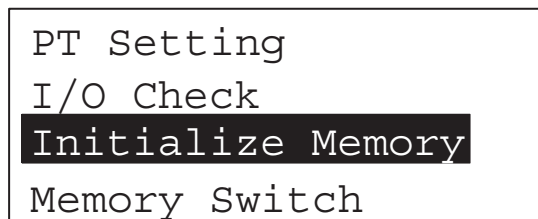

Select “Initialize Memory” with the key, then press “ENTER”.



```
[Initialize Memory]
Quit
Screen Data
History Data
```

Select "Screen Data" with the key, then press "ENTER".



```
Initialize
      Screen Data.
Are you sure?
(Yes:ENT No:F3+F4)
```

Press "ENTER".



```
Initializing...
```

The message shown to the left is displayed during initialization.



```
Completed.
Please transmit
screen data
(Quit:F3+F4)
```

On completion of initialization, the message shown to the left is displayed.

You can quit without initializing the memory by simultaneously pressing any two of the function keys while the "Initialize Screen Memory?" screen is displayed.

When the screen data memory initialization has been completed, transfer the screen data from the support tool.

3-4-2 Initialization by Using the DIP Switch (Forced Initialization)

Note Be sure to turn the power OFF before setting the NT11 DIP switch.

Set the DIP switch as follows to initialize the screen data memory.

Operation

1. Set DIP-SW2-2 on the NT11 to ON and turn the power ON.

```
Initialize
      Screen Data.
Are you sure?
      (Yes:ENT No:F3+F4)
```

Press "ENTER".



```
Initializing...
```

The message shown to the left is displayed during initialization.



```
Completed.

Set DIP-SW2-2 to off
and Power OFF/ON.
```

On completion of initialization, the message shown to the left is displayed.

2. Turn the NT11 power to OFF.
3. Set NT11 DIP SW2-2 to OFF and turn the power ON.

You can quit without initializing the memory by simultaneously pressing any two of the function keys while the "Initialize Screen Memory?" screen is displayed.

```
Set DIP-SW2-2 to off
and Power OFF/ON.
```

Reference To change the system settings or to register the screen data, set DIP-SW2-2 to OFF and call the System Menu screen by turning on the power to the NT11 while pressing two of the four function keys.

The NT11 DIP-SW2-2 is used to set "Screen data forced initialize effective/ineffective". Setting this to ON selects "effective", and OFF "ineffective".

3-5 Transferring the System Program

The system program of NT11 can be changed by the system transfer tool. The system transfer tool is automatically installed in the personal computer when the NT11 support tool is installed.

For details on how to start up the system transfer tool, and the system transfer tool operation, refer to the NT-series Support Tool Operation Manual (V061-E1-□).

Note An NT11 which has no system program registered in it will be able to execute only installation function.

For details on system transfer tool operations, refer to the NT-series Support Tool Operation Manual (V061-E1-□).

Transferring the system program from the system transfer tool

In order to transfer the system program from the system transfer tool, first connect the NT11 to a personal computer running the system transfer tool by using the appropriate cable, then proceed as follows.

Reference The NT11 uses one connector for the connection to both a PLC and a computer. If it has been connected to a PLC, disconnect the PLC and connect the system transfer tool (computer) to the NT11, and then, transmit the screen data.

Operation

1. Connect the NT11 to the personal computer running the system transfer tool, then switch on the power to the NT11.
2. Switch on the power to the personal computer and start up the system transfer tool.
3. When the power to the NT11 is switched ON, the screen shown below is displayed.

```
System Program
  isn't installed.
Press ENTER key
  to start install
```

4. Press the "ENTER" key to enter the system transfer mode, as shown below.

```
[INSTALL MODE]      1.0
```

5. The NT11 is now on standby for reception. Start transfer of the program by using the system transfer tool.
When the NT11 starts reception, the screen shown below is displayed.

```
[INSTALL MODE]      1.0
```

```
downloading...
```

6. When transfer of the system program is completed, the NT11 displays the screen shown below.

```
Downloading is
completed.

Press any key to run
```

7. Pressing any key when using the system transfer tool will return you to the main menu screen.
8. You can quit the system transfer mode and return to the RUN mode by simultaneously pressing any two of the four function keys on the panel of the NT11. The same result is achieved when the NT11 receives a transfer end instruction from the system transfer tool.

Points to observe during transfer of the system program

If any of the following events, or a system error, occurs during transfer of the system program, the program will not be installed in the NT11 correctly.

- The power to the NT11 is switched off, or the NT11 is reset, during transfer.
- The power to the personal computer that is running the system transfer tool is switched off, or the personal computer is reset, during transfer.
- The cable connecting the personal computer running the system transfer tool and the NT11 becomes disconnected or sustains a wire breakage during transfer.
- Transfer is terminated by pressing any two of the function keys on the panel of the NT11.
- Transfer is terminated by pressing the ESC key of the personal computer running the system transfer tool.

In the event of any of the above, there is a possibility that the NT11 will not operate or that unpredictable malfunctions will occur.

To prevent this, switch DIP switch SW2-6 ON to erase the system program after the problem has occurred. For details on erasing the system program with the DIP switch, refer to "Method for Erasing the System Program" (page 68).

Method for Erasing the System Program

In order to erase the system program, the system program area must be cleared. On shipment there is no data in the system program area and therefore the system program can be transferred without having to erase an existing system program first; however, if a system program already exists it must be erased before the new one can be transferred.

The following is the procedure for erasing the system program.

Operation

1. Set DIP SW2-6 to the ON position and turn on the power or reset: the following screen will be displayed.

```
Erase system program
Are you sure?

(Yes:F3+F4, No:ENT)
```

2. Press the “return” key if you want to quit without erasing the program. If you do want to erase the program, press any two of the function keys simultaneously: this will start erasure of the program.
During erasure, the screen shown below is displayed:

Erasing...

3. On completion of erasure, the screen shown below is displayed. At this point set DIP SW2-6 to the OFF position and reset the NT11.

Erasing is completed
Set DIP-SW2-6 to off
and Power OFF/ON

3-6 Registering the Screen Data

The screen data is created by using the support tool and registered to the NT11 screen data memory. This section describes the procedure to register the screen data to the NT11. For the screen data creation and the support tool operation, refer to the NT-series Support Tool Operation Manual (V061-E1-1).

Transmission – Transmission in File Units

The NT11 uses several screens which are switched on its display. The screen data of one NT11 unit corresponds to the screens created by using the support tool. Select a file which contains the screen data to be transmitted when selecting the screen data to be transmitted to the NT11 so that the required screen data can be transmitted to the NT11.

It is not possible to send screen data in screen units.

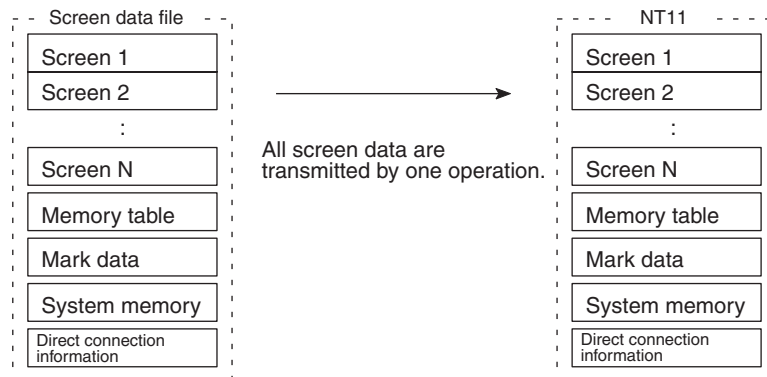

If an error message and the System Menu are displayed immediately after the NT11 has been started, the screen data memory needs to be initialized.

Transmitting the Screen Data from the Support Tool

To transmit the screen data from the support tool to the NT11, connect the NT11 to the computer on which the support tool is being used, and follow the procedure below.

Reference The NT11 uses one connector for the connection to both a PLC and a computer. If it has been connected to a PLC, disconnect the PLC and connect the support tool (computer) to the NT11, and then, transmit the screen data.

Operation

1. Connect the NT11 to the computer on which the support tool is being used, and turn ON the NT11.
2. Turn ON the computer and start up the support tool.
3. Enter the "Transmit Mode" by operating the menu of the NT11 as mentioned below.

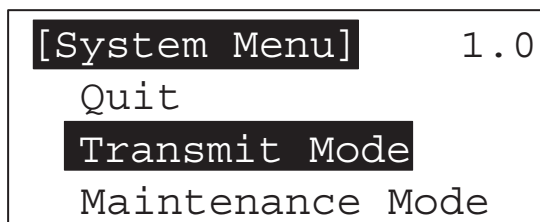

Select "Transmit Mode" with the key, then press "ENTER".

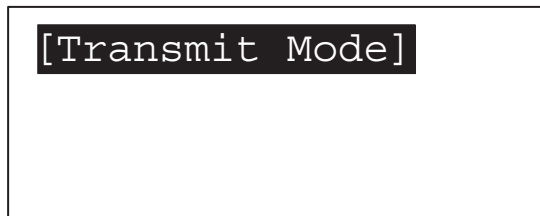

4. Specify downloading screen data from the NTST or Transfer Utility. (With the NTST, select "connect - Download - Application.")
5. The NT11 will display the following screen when the screen data is being transmitted.

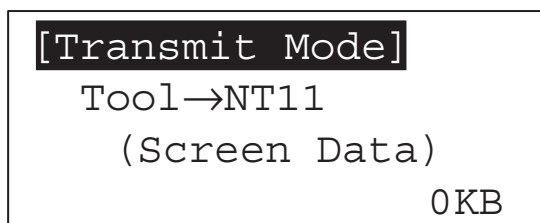

6. When the screen data transmission is completed, the support tool will display the following screen.

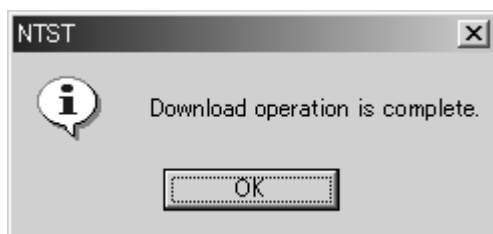

7. Press any key on the support tool to return to the File Selection screen.

8. You can quit the Transmit Mode and return to the RUN mode by simultaneously pressing any two of the four function keys on the panel of the NT11. The same result is achieved when the NT11 receives a transfer end instruction from the support tool.

Precautions to be Observed During the Screen Data Transmission

When any of the following or a system error occurs during the screen data transmission, the transmitted screen data will not be registered correctly to the NT11. If an error message is displayed in the System Menu and the Transmit Mode cannot be selected, the screen data memory needs to be initialized.

- The power to the NT11 is interrupted or the NT11 is reset.
- The power to the computer on which the support tool is running is interrupted or the computer is reset.
- The cable connecting the NT11 to the computer on which the support tool is running is disconnected or has a broken wire.
- Screen data transfer is terminated by pressing any two of the function keys on the panel of the NT11.
- The ESC key on the support tool is pressed to end the transmission.

When the power to the NT11 is turned ON or reset, the screen data is checked. However, if any of the above occurs during the screen data transmission, the screen may disappear and other unexpected problems may occur.

In the case of such problems, set DIP-SW2-2 to ON to initialize the memory.

For the memory initialization by using the DIP switch, refer to *3-4-2 Initialization by Using the DIP Switch (Forced Initialization)* (page 65).

3-7 Setting the Conditions of Communications with the PLC by Using the Memory Switches

The communications between the NT11 and a PLC are called the host communications.

The NT11 can be connected to a PLC by the host link or NT link. The link can be selected by setting the memory switch. Also, the host link baud rate, automatic reset function, etc. are set with the memory switches.

This section describes the communications condition settings by using the memory switches.

Memory Switches

The NT11 has the memory areas used to store the PLC connection method, communications conditions, system settings, etc. which can be used as the switches and called the “memory switches”. Since the memory switches use the flash memory, the stored data can be held even when the power supply is turned OFF.

Setting Functions and the Memory Switch Menu

The memory switches can be set easily by using the memory switch menu in the System Menu.

The following settings can be made with the memory switches. Refer to the subsequent pages for the details of each setting and function.

[Memory switch menu]

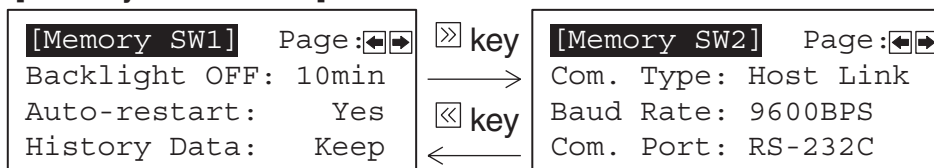

- Backlight OFF *3-9-2 Backlight OFF Function (page 78)*
- Auto-restart *3-7-3 Selecting the Automatic Restart Function (page 75)*
- Comm. Type Host Link *3-7-1 Selecting the Host Communication Method (page 73)*
- Baud Rate *3-7-2 Selecting the Host Link Communication Speed (page 74)*
- Comm. Port *3-7-4 Selecting the Channel for Communication with the PLC (page 76)*
- History Data *3-7-5 Selecting the History Data Property (page 77)*

3-7-1 Selecting the Host Communication Method

The NT11 can be connected to a PLC by the host link or NT link. Either link can be selected by setting the “Comm. Type” memory switch. The factory setting has been made to the “Host link”.

Select the host communication method by the menu operation from the System Menu as mentioned below.

```
[System Menu] 1.0
Quit
Transmit Mode
Maintenance Mode
```

Select “Maintenance Mode” with the key, then press “ENTER”.



```
PT Setting
I/O Check
Initialize Memory
Memory Switch
```

Select “Memory Switch” with the key, then press “ENTER”.



```
[Memory SW1] Page: ◀▶
Backlight OFF: 10min
Auto-restart: Yes
History Data: Erase
```

Display the next screen by pressing the key.



```
[Memory SW2] Page: ◀▶
Com. Type: Host Link
Baud Rate: 9600BPS
Com. Port: RS-232C
```

Pressing the [+/-] key while “Comm. Type” is highlighted will cause the selection for this item to alternate between “Host Link” and “NT Link 1:1”.

To quit after setting the selection made, press the “ENTER” key. To quit without setting the selection made, press any two function keys simultaneously.

Reference

The communication method must be selected according to the method that the connecting PLC supports.

3-7-2 Selecting the Host Link Communication Speed

When the host link is used, the baud rate of the communications with the PLC can be set. Use the “Baud Rate” switch and select 9,600 bps or 19,200 bps. The factory setting has been made at 9,600 bps.

Select the baud rate of the communication with the PLC by the menu operation from the System Menu as mentioned below.

```
[System Menu] 1.0
Quit
Transmit Mode
Maintenance Mode
```

Select “Maintenance Mode” with the key, then press “ENTER”.



```
PT Setting
I/O Check
Initialize Memory
Memory Switch
```

Select “Memory Switch” with the key, then press “ENTER”.



```
[Memory SW1] Page:◀▶
Backlight OFF: 10min
Auto-restart: Yes
History Data: Erase
```

Display the next screen by pressing the key.



```
[Memory SW2] Page:◀▶
Com. Type: Host Link
Baud Rate: 9600BPS
Com. Port: RS-232C
```

Select “Baud Rate” with the key.

Pressing the [+/-] key while “Baud Rate” is highlighted will cause the selection for this item to switch as follows: 9,600 bps, 19,200 bps, 38,400 bps, 57,600 bps, and 115,200 bps.

To quit after setting the selection made, press the “ENTER” key. To quit without setting the selection made, press any two function keys simultaneously.

Note If the NT link has been selected, the Baud Rate setting does not make any effect.

3-7-3 Selecting the Automatic Restart Function

The “Auto-restart” memory switch is used to set whether or not the communication is automatically reset after the occurrence of a communication error.

The factory setting has been made at “No”.

Select the Automatic Reset Function of the communication with the PLC by the menu operation from the System Menu as mentioned below.

```
[System Menu] 1.0
Quit
Transmit Mode
Maintenance Mode
```

Select “Maintenance Mode” with the key, then press “ENTER”.



```
PT Setting
I/O Check
Initialize Memory
Memory Switch
```

Select “Memory Switch” with the key, then press “ENTER”.



```
[Memory SW1] Page:◀▶
Backlight OFF: 10min
Auto-restart: Yes
History Data: Erase
```

Select “Auto-restart” with the key.

Pressing the [+/-] key while “Automatic Reset” is highlighted will cause the selection for this item to alternate between “No” and “Yes”.

To quit after setting the selection made, press the “ENTER” key. To quit without setting the selection made, press any two function keys simultaneously.

- “Yes”: If a communication error has occurred, corresponding error message is displayed and the operation stops.
- “No”: If a communication error has occurred, corresponding error message will not be displayed and the operation will be automatically reset.

3-7-4 Selecting the Channel for Communication with the PLC

The NT11 allows selection of RS-232C or RS-422A as the channel (communication port) for communication with the PLC. The channel to be used is selected at the “Comm. Port” item in the memory switch menu.

The setting on shipment is “RS-232C”.

Select the channel by performing the following operations, starting from the system menu.

```
[System Menu] 1.0
Quit
Transmit Mode
Maintenance Mode
```

Select “Maintenance Mode” with the key, then press “ENTER”.



```
PT Setting
I/O Check
Initialize Memory
Memory Switch
```

Select “Memory Switch” with the key, then press “ENTER”.



```
[Memory SW1] Page: [Left][Right]
Backlight OFF: 10min
Auto-restart: Yes
History Data: Erase
```

Display the next screen by pressing the key.



```
[Memory SW2] Page: [Left][Right]
Com. Type: Host Link
Baud Rate: 9600BPS
Com. Port: RS-232C
```

Select “Comm. Port” with the key.

Pressing the [+/-] key while “Comm. Port” is highlighted will cause the selection for this item to alternate between “RS-232C” and “RS-422”.

To quit after setting the selection made, press the “ENTER” key. To quit without setting the selection made, press any two function keys simultaneously.

Reference Select the system that is supported by the PLC to be connected.

3-7-5 Selecting the History Data Property

The “History Data” memory switch is used to set whether to erase the history data when the power supply is turned ON. The history data is backed up by a capacitor in the NT11. (The backup time is 5 minutes minimum and 16 hours at 25°C.) The factory setting is “Erase”.

Select the History Data property using the menu operation from the System Menu as shown below.

```
[System Menu] 1.0
Quit
Transmit Mode
Maintenance Mode
```

Select “Maintenance Mode” with the key, then press “ENTER”.



```
PT Setting
I/O Check
Initialize Memory
Memory Switch
```

Select “Memory Switch” with the key, then press “ENTER”.



```
[Memory SW1] Page: ◀▶
Backlight OFF: None
Auto-restart: No
History Data: Erase
```

Select “History Data” with the key.

Pressing the [+/-] key while “History Data” is highlighted will cause the selection for this item to alternate between “Keep” and “Erase”.

To quit after setting the selection made, press the “ENTER” key. To quit without setting the selection made, press any two function keys simultaneously.

- Keep: The history data will be held when the power supply is turned OFF. If, however, a data history error occurs, e.g., as the result of the capacitor being completely discharged, the system program will delete the history data even if “Keep” is set.
- Erase: The history data will be deleted when the power supply is turned OFF.

3-8 Starting the Operation

After completing the screen data transmission, connect the NT11 to the PLC and start the operation.

⚠ Caution Carefully check the operation of all screen data and host programs before using them. If incorrect, the system may operate unpredictably. Otherwise the system may operate unpredictably.

Switching to the RUN mode

Press the Quit in the System Menu. The start-up screen in the RUN mode will be displayed.

Reference

If the NT11 has failed to start correctly; e.g., the start-up screen is not displayed, an error message is displayed, or the screen is not displayed at all, refer to *6-2 Responding to Displayed Error Messages* (page 138) and take appropriate action.

Confirming the Communications between the NT11 and the PLC

Execute the PLC program and confirm that the following operations are normally performed.

- Confirm that the NT11 screens switch according to the PLC program execution.

If the screens do not switch correctly, check the connection between the NT11 and the PLC and also check the settings.

Refer to *SECTION 2 Hardware Settings and Connections*.

- Confirm that the information selected by the NT11 function keys has been set in the PLC by displaying the contents of the words and bits using a peripheral tool (CX-Programmer etc.). If the information sent from the NT11 has not been correctly received by the PLC, check the screen data settings (specifically the switch settings).

For the details of the screen data creation, refer to the *NT-series Support Tool Operation Manual* (V061-E1-1).

Reference

The start-up screen must be designated when the screen data is created by using the support tool. If the start-up screen has not been designated, the screen with screen number 1 will be displayed. If no screen data has been registered at screen number 1, the "Screen not registered." error message will be displayed. For the screen number setting, refer to *4-2 Screen Display* (page 87).

3-9 Backlight OFF

In order to prevent the formation of an afterimage on the screen, and to maximize the service life of the backlight, the NT11 has a function for turning off the backlight.

3-9-1 Turning the Backlight Back ON

After the backlight has been switched off by actuation of the backlight OFF function, it will come back on in response to any key operation on the panel of the NT11, if a screen is switched or redisplayed by the PLC, or if a backlight ON instruction is received from the PLC.

The backlight will not come back on merely because the numerals or characters displayed on the screen change.

3-9-2 Backlight OFF Function

There are two methods for implementing the backlight OFF function:

- Method whereby the backlight is automatically switched off when there have been no operations for a set length of time. (Designated with the memory switches)
- Method whereby the backlight is switched off by an instruction from the PLC. (Designated in the PT status control area)

For details on the method for switching the backlight off with an instruction from the PLC, refer to *5-5 NT11 Status Control* (page 129).

The settings relating to the backlight OFF function that can be made with the memory switches are: whether or not the backlight OFF function is used, and - if it is used - what length of time will elapse before the backlight goes OFF.

The setting on shipment specifies that the backlight will go OFF after a period of ten minutes during which there are no operations.

Select the backlight OFF time by performing the following operations, starting from the system menu.

```
[System Menu]      1.0
Quit
Transmit Mode
Maintenance Mode
```

Select "Maintenance Mode" with the key, then press "ENTER".



```
PT Setting
I/O Check
Initialize Memory
Memory Switch
```

Select "Memory Switch" with the key, then press "ENTER".



```
[Memory SW1] Page:◀▶
Backlight OFF: 10min
Auto-restart:   Yes
History Data:   Erase
```

Pressing the [+/-] key while "Backlight OFF" is highlighted will cause the selection for this item to change cyclically in the sequence "10 min" "60 min" "None".

- To quit after setting the selection made, press the "ENTER" key.
- To quit without setting the selection made, press any two function keys simultaneously.
- If "None" is selected, the backlight OFF function does not operate. As long as no operations are performed, the same screen will be displayed indefinitely.
- If "10 min" is selected, the backlight will be switched OFF if no operations are performed for ten minutes.
- If "60 min" is selected, the backlight will be switched OFF if no operations are performed for one hour.

Reference In order to maximize the service life of the backlight, select "10 min" or "60 min" if possible.

Correct Use

After images may remain if the same pattern is displayed for a long period. To prevent the formation of an afterimage, either use the screen saver function or periodically switch screens.

3-10 System Maintenance

In order to facilitate maintenance, the NT11 is provided with functions including the I/O check function and a function for confirming the NT11 settings.

3-10-1 I/O Check

The I/O check function checks whether the inputs and outputs for the following items are normal.

- LEDs
- LCD
- Key input
- Communication interface

LED check

Carry out the LED check by performing the following operations, starting from the system menu.

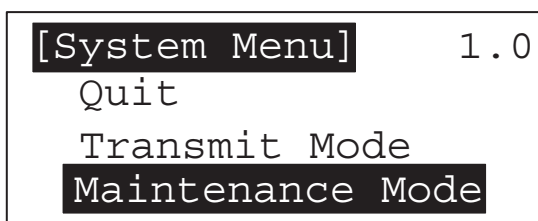

Select "Maintenance Mode" with the key, then press "ENTER".

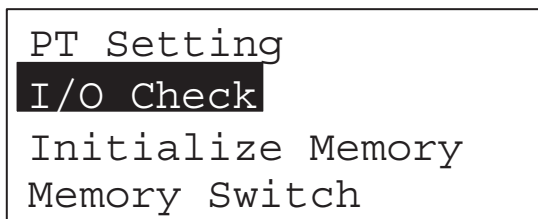

Select "I/O Check" with the key, then press "ENTER".

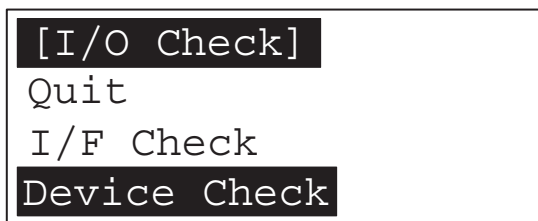

Select "Device Check" with the key, then press "ENTER".

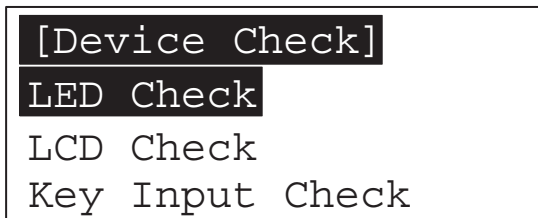

Select "LED Check" with the key, then press "ENTER".

The "RUN" LED on the panel of the NT11 will blink.

- To quit the LED check, press any two of the function keys simultaneously.

LCD check

Check the LCD of the NT11 by performing the following operations, starting from the system menu.

```
[System Menu]      1.0
Quit
Transmit Mode
Maintenance Mode
```

Select "Maintenance Mode" with the key, then press "ENTER".



```
PT Setting
I/O Check
Initialize Memory
Memory Switch
```

Select "I/O Check" with the key, then press "ENTER".



```
[I/O Check]
Quit
I/F Check
Device Check
```

Select "Device Check" with the key, then press "ENTER".



```
[Device Check]
LED Check
LCD Check
Key Input Check
```

Select "LCD Check" with the key, then press "ENTER".

- In the LCD check, all of the dots that comprise the screen are displayed, one at a time, starting at the top left corner of the screen. The LCD check is completed when all the dots are displayed.
- To abort the LCD check, press any two function keys simultaneously.

Key input check

Check the numeric keys, arrow keys, and function keys of the NT11 by performing the following operations, starting from the system menu.

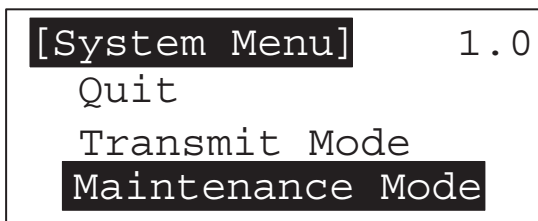

Select "Maintenance Mode" with the key, then press "ENTER".

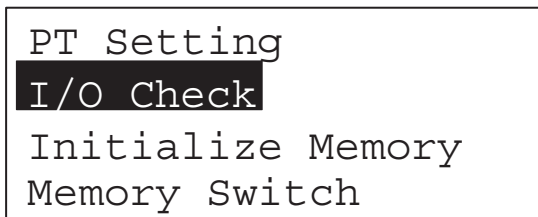

Select "I/O Check" with the key, then press "ENTER".

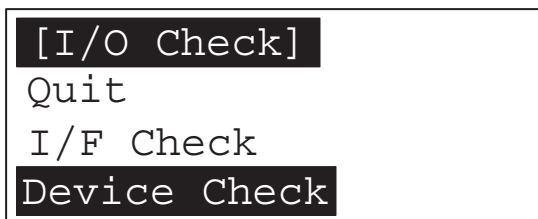

Display the next page by pressing the key.

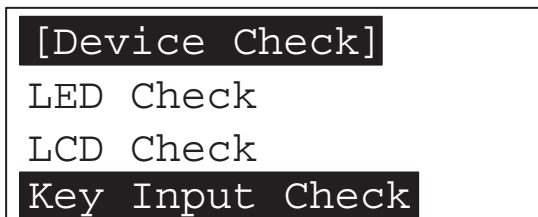

Press "ENTER".

All the keys to be checked are displayed on the screen.

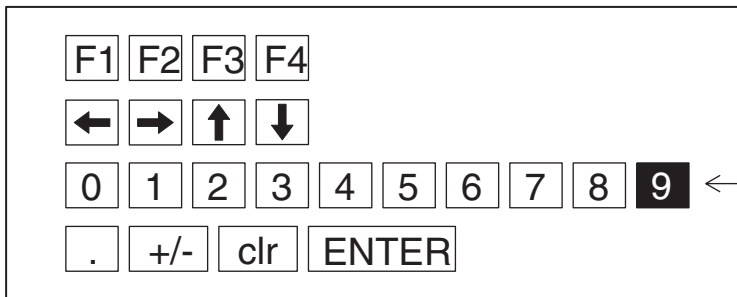

Display when the numeric key [9] is pressed.

- Press each of the numeric keys, arrow keys, and function keys on the panel of the NT11 in turn.
If the corresponding key in the display is highlighted when the panel key is pressed, it indicates that the key is operating normally.
- To quit the key input check, press any two of the function keys simultaneously.

Check on communication with the support tool

Check the communication between the NT11 and support tool by performing the following operations, starting from the system menu.

```
[SYSTEM MENU]
Quit
Transmit Mode
Maintenance Mode
```

Select "Maintenance Mode" with the key, then press "ENTER".



```
PT Setting
I/O Check
Initialize Memory
Memory Switch
```

Select "I/O Check" with the key, then press "ENTER".



```
[I/O Check]
Quit
I/F Check
Device Check
```

Select "I/F Check" with the key, then press "ENTER".



```
[I/F Check]
Quit
Tool I/F Input Check
Print Out Check
```

Select "Tool I/F Input Check" with the key, then press "ENTER".



```
TOOL I/F INPUT CHECK
```

- The data received from the connected support tool is displayed in hexadecimal notation.
- To quit the check on communication with the support tool, press any two function keys simultaneously.

Note The NT11 uses the same connector for connection to the support tool to the PLC. If this cable is connected to equipment other than the personal computer running the support tool, disconnect it from this equipment and connect it to the support tool before starting the communications check.

3-10-2 PT Setting Check

Display the settings of the NT11 on the screen by performing the following operations, starting from the system menu.

```
[System Menu]      1.0
Quit
Transmit Mode
Maintenance Mode
```

Select "Maintenance Mode" with the key, then press "ENTER".



```
PT Setting
I/O Check
Initialize Memory
Memory Switch
```

Press "ENTER".



```
Control Area
                DM 00000
Notify Area
                DM 00010
```

- The current settings of the NT11 are displayed.
- To quit the PT setting display, press any two function keys simultaneously.

SECTION 4 NT11 Functions

This section describes the functions of the NT11.

4-1	Outline of Functions	86
4-1-1	NT11 Screen	86
4-1-2	Characters and Figures Which can be Displayed	86
4-2	Screen Display	87
4-2-1	Classification of Screens.	87
4-2-2	Screen Attributes	88
4-3	Areas for Control/Notification	89
4-3-1	Allocatable Bits and Words	89
4-3-2	Data Exchange in the Host Link/NT Link	89
4-3-3	NT11 Status Control and Notification to PLC	90
4-4	Memory Tables	94
4-4-1	Character-String Memory Table	94
4-4-2	Numeral Memory Table	95
4-5	Bar Graphs	96
4-5-1	Bar Graph Functions	96
4-6	Numeral Setting	97
4-6-1	The Numeral Setting Function	97
4-6-2	Using Numeric Keys.	98
4-7	Menu Screen Function	99
4-8	Password Screen Display Function	100
4-9	Display History Screen Function	101
4-10	Daily Report/Display History Printing Function	102
4-10-1	Printing Daily Reports	102
4-10-2	Printing Display Histories.	104

4-1 Outline of Functions

4-1-1 NT11 Screen

This section gives the outline of the screen which is the basis of all NT11 functions.

For specific operation procedure using host link/NT link such as screen switching, refer to *4-2 Screen Display* (page 87).

Composition of the Screen

The NT11 screen is composed of horizontal 160 dots x vertical 64 dots. Each dot is set by the combination of the X (horizontal) and Y (vertical) coordinates. The origin of coordinates (0, 0) is set at the top left corner of the screen.

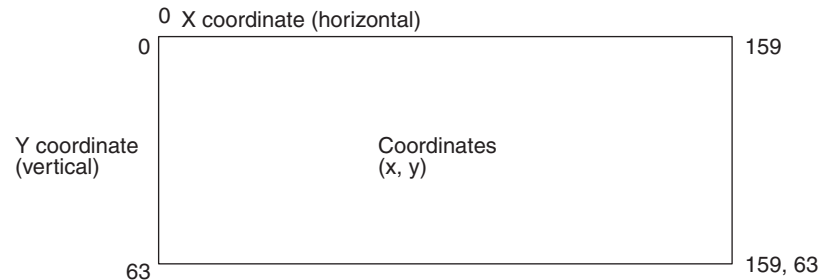

Screen Management

The screens displayed on the NT11 are managed by the screen numbers.

Screen numbers are set when the screen data are created by using the support tool. Up to 250 screens can be set by allocating arbitrarily selected numbers 1 to 250.

The display screens can be switched or the start-up screen can be set by designating the screen number from the PLC.

Special Screen Number

Screen number "0" is reserved for the system as the no-display screen. Select this to display nothing on the NT11 screen.

4-1-2 Characters and Figures Which can be Displayed

The NT11 screen can display characters, bar graphs, and other various elements.

This section describes the types and attributes of the characters and figures which can be displayed and do not need to be changed at all.

For the settings, display, and use of the characters, numeric values, and graphs which change according to the system operation status and other conditions, refer to *4-3 Areas for Control/Notification* (page 89) and *5-3 Memory Table Entries and Bar Graph* (page 115).

The power of expression of the screen can be increased by giving various attributes such as the enlarged or reverse display to the characters and figures.

The character and figure attributes can be set in the edit screen when creating the screen data by using the support tool.

Types and Attributes of Characters and Figures

The following types of characters can be input by using the support tool and be displayed during operation.

Character Type	Dots (vertical x horizontal)	Character Set	Maximum Number of Characters Displayed in One Screen (without overwriting)
Normal height characters	8 x 16	Alphanumerics and symbols	20 characters x 4 lines (80 characters)
Marks	8 x 16	Create by using the support tool	

- Marks

A mark is a graphic pattern created by 8 (horizontal) x16 (vertical) by using the support tool. Marks can be handled the same as the normal size characters. Up to 64 patterns can be defined within the total screen data.

- Enlarged display of the characters and marks

The characters and marks can be enlarged to the following scales.

PT	PT
x1 scale	Double width scale

- Reverse and flashing display

Reverse display: The display brightness of the character and the background is reversed comparing with the normal display.

Flashing display: Characters are displayed as they flash. The normal display alternates with no-display.

Reverse and flashing display: The reverse display alternates with the normal display.

4-2 Screen Display

This section describes the screen information required for the operation with the NT11.

4-2-1 Classification of Screens

The NT11 is provided with the following types of screens which are classified by the display method.

- Normal screen
- System screen

The screen type is determined by the screen number.

Normal screens (screen numbers 1 to 250)

These screens can be used without restriction by the user to create various kinds of monitor and setting screens, including fixed displays, character displays, numeral displays, and bar graph displays.

System screen (screen number 0)

The system screen is reserved by the NT11 for system applications.

Screen No. 0 Blank screen

4-2-2 Screen Attributes

Assigning an attribute to a screen makes it capable of a special function when it is displayed. For example, when an attempt is made to display a screen for which the "password" attribute is set, a message requesting input of the password will be displayed and the specified screen will not be displayed until the password has been input.

Set screen attributes for each screen by using the "screen selection" screen of the support tool.

It is possible to set more than one of the following attributes for a screen.

Numeral setting attribute

This attribute makes it possible to use numeric keys on the panel of the NT11 to input numerical values on screens on which numerical values have to be set.

For numeral setting, the write channel, display position, and display method must be set.

Password attribute

This attribute ensures security by requesting the input of a password before the screen is displayed.

If an incorrect password is input, the screen will not be displayed.

The password is set as a four-digit numerical value.

Display history attribute

The following three types of data are recorded each time a screen is displayed:

Display time: Time when the screen was displayed
(month, day, hour, minute)

Screen number: Screen number of the displayed screen

Screen comment: The comment set for the displayed screen

The recorded data can be printed out using the printing function of the NT11.

Menu screen attribute

This attribute makes it possible to switch to another screen by using the numeric keys.

Assigning the screen numbers of destination screens to numeric keys [1] through [4] enables switching to these screens by numeric key input.

4-3 Areas for Control/Notification

This section describes the basics for operating the NT11 through communications with the PLC using the host link/NT link.

4-3-1 Allocatable Bits and Words

The following bits and words are allocated to the PLC and used for the NT11 operation. The range of respective area varies with the type of PLC.

The allocations must be made without exceeding respective area range.

[OMRON PLCs]

Words Allocated for the PT Status Control Area

Words can be allocated for the PT status control area (host ↔ PT) in the following host (PLC) areas.

Symbol	C-series PLCs	Allocation	CV-series PLCs	Allocation	CS/CJ-series PLCs	Allocation
None	IR Area	OK	CIO Area	OK	CIO Area	OK
H	HR Area	OK	---	---	HR Area	Not for Host Link
A	AR Area	OK	Auxiliary Area	No	AR Area	OK
L	LR Area	OK	---	---	LR Area ^{*1}	Not for Host Link
T	TC Area, Timer PVs	No	Timer Area, Timer PVs	No	TC Area, Timer PVs	No
TU	---	---	---	---	TC area, Timer Completion Flags	No
C	TC Area, Counter PVs	No	Counter Area, Counter PVs	No	TC Area, Counter PVs	No
CU	---	---	---	---	TC Area, Counter Completion Flags	No
W	---	---	---	---	WR Area	Not for Host Link
TK	---	---	---	---	Task Flags	No
D	DM Area	OK	DM Area	OK	DM Area	OK
E	EM Area ^{*2} , current bank	OK	EM Area, current bank	Not for Host Link	EM Area, current bank	Not for Host Link
E0_ to EC_	---	---	---	---	EM Area, EM banks 0 to C	Not for Host Link

*1 LR 00000 to LR 00199 are converted to CIO 01000 to CIO 01199.

*2 The EM Area is supported only by the C200HX/HG/HE(-Z)E PLCs.

The Auxiliary Area of the CVM1 and CV-series PLCs is allocated to system functions, and cannot be used for purposes other than system use.

The range of each memory area differs according to the PLC.

4-3-2 Data Exchange in the Host Link/NT Link

There are two main methods for data exchange when using the host link/NT link, as follows:

- Using the PT status control area/PT status notify area
- Allocating numeral memory table entries/character string memory table entries

Using the PT status control area/PT status notify area

Contiguous areas (4 words for the PT status control area and 3 words for the PT status notify area) must be allocated in the PLC memory in advance.

Screen switching, memory table copy and PT status change operations, etc., are possible by using the PT status control area and PT status notify area.

Allocating numeral memory table entries/character string memory table entries

Allocating memory table entries to a data area secured in the PLC memory allows the display to be automatically updated.

4-3-3 NT11 Status Control and Notification to PLC

This section describes the fundamentals of the display elements, NT11 status control, and notification which are the basics of the NT11 functions.

For the detail method of use of the PT status control area and the PT status notify area, refer to 5-5 *NT11 Status Control* (page 129) and 5-6 *Notification of the Operating Status to the PLC (Determining the NT11 Operating Status)* (page 132).

Controlling the Display Elements by Using Allocated Bits and Words

The NT11 will operate as follows in the display element control operation.

[NT11 operation]

- 1,2,3...
1. The NT11 checks the allocation bits and words of the display elements and makes an inquiry to the PLC.
 2. The PLC answers the NT11 about the bit and word data.
 3. The NT11 changes the display status according to the bits and words obtained from the PLC.

[NT11 operation example]

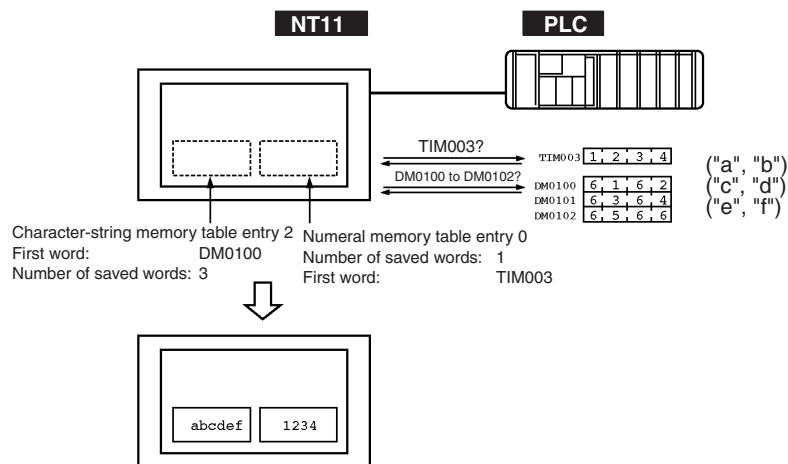

Controlling the NT11 Status by Using Allocated Bits and Words PT Status Control Area (PLC to PT)

The PT status control area (PLC to PT) is provided to control the NT11 status from the PLC. When data is written to this area in the PLC, the NT11 will read the data and operates according to the data. The PT status control area is configured as four consecutive words as shown below.

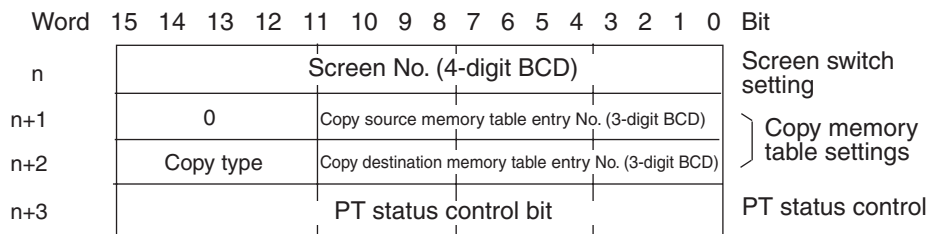

The first word (word n) of the PT status control area must be set with the support tool.

- Screen switch settings (refer to page 110)
Specify the screen No. to switch the screen displayed on the NT11.
- Copy memory table settings (refer to page 121)
Specify the memory table entry No. to copy the contents of a memory table entry internally in the NT11.
Set the copy type to match the type of memory table entry to be copied:
0: Character-string memory table
1: Numeral memory table
- PT status control bits (refer to page 129)
Set the bits ON or OFF according to the following table to control the back-lighting. For the bit configuration, refer to 5-5-1 Controllable NT11 Functions (page 129).

The PT status control area (PLC to PT) can be allocated to the following PLC areas.

Words Allocated for the PT Status Control Area

Words can be allocated for the PT status control area (host ↔ PT) in the following host (PLC) areas.

Symbol	C-series PLCs	Allocation	CV-series PLCs	Allocation	CS/CJ-series PLCs	Allocation
None	IR Area	OK	CIO Area	OK	CIO Area	OK
H	HR Area	OK	---	---	HR Area	Not for Host Link
A	AR Area	OK	Auxiliary Area	No	AR Area	OK
L	LR Area	OK	---	---	LR Area ^{*1}	Not for Host Link
T	TC Area, Timer PVs	No	Timer Area, Timer PVs	No	TC Area, Timer PVs	No
TU	---	---	---	---	TC area, Timer Completion Flags	No
C	TC Area, Counter PVs	No	Counter Area, Counter PVs	No	TC Area, Counter PVs	No
CU	---	---	---	---	TC Area, Counter Completion Flags	No
W	---	---	---	---	WR Area	Not for Host Link
TK	---	---	---	---	Task Flags	No
D	DM Area	OK	DM Area	OK	DM Area	OK

Symbol	C-series PLCs	Allocation	CV-series PLCs	Allocation	CS/CJ-series PLCs	Allocation
E	EM Area *2, current bank	OK	EM Area, current bank	Not for Host Link	EM Area, current bank	Not for Host Link
EO_ to EC_	---	---	---	---	EM Area, EM banks 0 to C	Not for Host Link

*1 LR 0000 to LR 00199 are converted to CIO 01000 to CIO 01199.

*2 The EM Area is supported only by the C200HX/HG/HE(-Z)E PLCs.

The Auxiliary Area of the CVM1 and CV-series PLCs is allocated to system functions, and cannot be used for purposes other than system use.

The range of each memory area differs according to the PLC.

Notifying the Display Elements by Using Allocated Bits and Words

The NT11 will operate as follows in the display element notification operation.

[NT11 operation]

The NT11 will write any changes in the contents of the numeral or character-string memory table entry being displayed or pressing of a system keys to the bits and words area in the PLC.

[NT11 operation example]

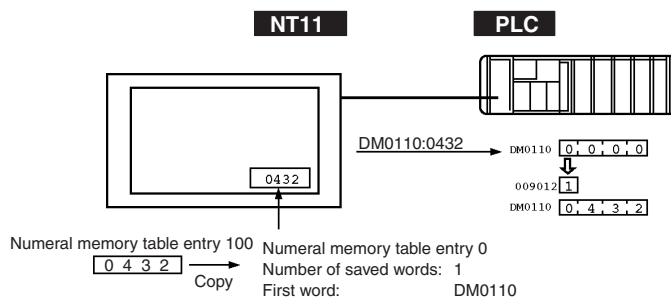

Notifying the NT11 Status by Using Allocated Bits and Words PT Status Notify Area (PT to PLC)

The PT status notify area (PT to PLC) is provided to notify the NT11 status changes to the PLC. When any NT11 status has changed, such change is written to this area in the PLC, and the PLC will read the data from this area to check the NT11 status.

The PT status notify area is configured as three consecutive words as shown below.

Word	15	14	13	12	11	10	9	8	7	6	5	4	3	2	1	0	Bit
m	Screen No. (4-digit BCD)										Screen being displayed						
m+1	0			Numeral memory table entry No. (3-digit BCD)										Content upgrade memory table entry			
m+2	PT status					0					0					PT status	

The first word (word m) of the PT status notify area must be set with the support tool.

- Currently displayed screen (refer to page 112)

The screen number displayed on the NT11 is written to this word.

Simultaneously, the PT status screen switch strobe flag is set to ON (1). After this is notified to the PLC, this flag reverts to OFF (0). Checking the status of this flag will provide a simple method of checking if the NT11 display has switched.

- Content upgrade memory table entry (refer to page 126)

The number of the numeral memory table entry is written to the word when the numeral memory table entry contents change due to the System keys operation on the NT11.

The contents of the word to which the numeral memory table entry has been allocated also change.

As the number of the numeral table entry is written, the PT status numeral setting strobe flag is simultaneously set ON (1). After this is notified to the PLC, this flag reverts to OFF (0). Checking the status of this flag will provide a simple method of checking if a number has been input from the NT11.

Note that this function is not available with the character-string memory table.

- PT status (refer to page 132)

The NT11 operation status and other information are written with the ON or OFF of the bits as shown below.

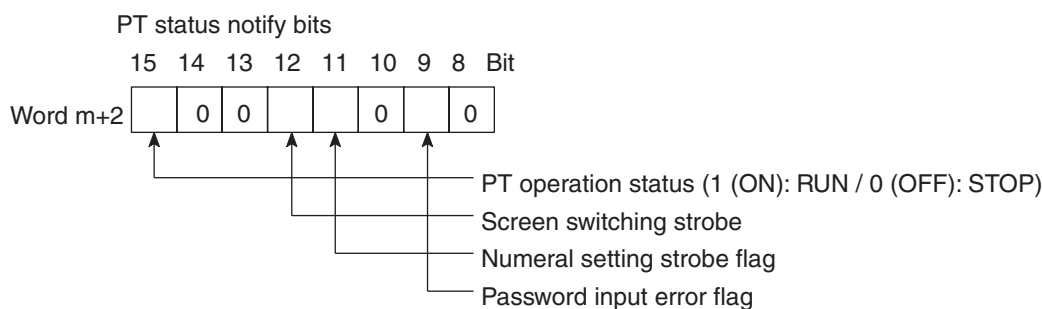

The PT status control area (PLC to PT) can be allocated to the following PLC areas.

Words Allocated of the PT Status Notify Area

Words can be allocated for the PT status notify area (PT → host) in the following host (PLC) areas.

Symbol	C-series PLCs	Allocation	CV-series PLCs	Allocation	CS/CJ-series PLCs	Allocation
None	IR Area	OK	CIO Area	OK	CIO Area	OK
H	HR Area	OK	---	---	HR Area	Not for Host Link
A	AR Area	OK	Auxiliary Area	No	AR Area	OK
L	LR Area	OK	---	---	LR Area ^{*1}	Not for Host Link
T	TC Area, Timer PVs	No	Timer Area, Timer PVs	No	TC Area, Timer PVs	No
TU	---	---	---	---	TC Area, Timer Completion Flags	No
C	TC Area, Counter PVs	No	Counter Area, Counter PVs	No	TC Area, Counter PVs	No
CU	---	---	---	---	TC Area, Counter Completion Flags	No
W	---	---	---	---	WR Area	Not for Host Link
TK	---	---	---	---	Task Flags	No
D	DM Area	OK	DM Area	OK	DM Area	OK
E	EM Area ^{*2} , current bank	OK	EM Area, current bank	Not for Host Link	EM Area, current bank	Not for Host Link
E0_ to EC_	---	---	---	---	EM Area, EM banks 0 to C	Not for Host Link

*1 LR 00000 to LR 00199 are converted to CIO 01000 to CIO 01199.

*2 The EM Area is supported only by the C200HX/HG/HE (-Z)E and CS/CJ-series PLCs.

The Auxiliary Area of the CVM1 and CV-series PLCs is allocated to system functions, and it cannot be used for purposes other than system use.

The range of each memory area differs according to the PLC. Refer to *Appendix D Making the Cable* on page 153.

 **Caution** Set so that there is no overlap between the PT status control area and PT status notify area. Otherwise the system may operate unpredictably.

4-4 Memory Tables

The NT11 has the “character-string memory table” for the character data and the “numeral memory table” for numeric data which can be written and updated by the PLC.

The contents of the memory tables can be set by using the support tool when displaying the memory tables on the screen or by editing the table.

4-4-1 Character-String Memory Table

The character-string memory table is an NT11 internal memory used to store the character data. Up to 128 character-string memory table entries can be used, and up to 20 characters (20 bytes) can be stored in one memory table entry. Character-string memory table entries at up to 8 positions can be registered in one screen.

Displaying a Character-string

The character-string memory table entries are registered with table entry numbers 0 to 127.

When creating the screen data by using the support tool, set the position on the screen to display a character-string and also set a character-string number to be displayed.

When the NT11 is operated, the screen displays the contents of the character-string memory table entry.

Characters and Figures Which can be Displayed

The power of expression of the screen can be increased by giving various attributes such as the enlarged or reverse display to the characters of a character-string memory table entry.

The character attributes can be set in the edit screen when creating the screen data by using the support tool.

The following types of characters can be displayed on the NT11:

Character Type	Dots (vertical x horizontal)	Character Set	Maximum Number of Characters Displayed in One Screen (without overwriting)
Normal height characters	8 x 16	Alphanumerics and symbols	20 characters x 4 lines (80 characters)
Marks	8 x 16	Create by using the support tool	

- Enlarged display of the characters and marks

The characters and marks can be enlarged to the following scales.

Double width scale.

- Reverse and flashing display

Reverse display: The display brightness of the character and the background is reversed comparing with the normal display.

Flashing display: Characters are displayed as they flash. The normal display alternates with no-display.

Reverse and flashing display: The reverse display alternates with the normal display.

4-4-2 Numeral Memory Table

The numeral memory table is an NT11 internal memory used to store the numeral data. Up to 128 numeral memory table entries can be used, and up to eight digits (four bytes) of numeral data (including signs) can be stored in one numeral memory table entry. Numeral memory table entries at up to 8 positions can be registered in one screen.

Displaying a Numeral

The numeral memory table entries are registered with table entry numbers 0 to 127.

When creating the screen data by using the support tool, set the position on the screen to display a numeral and also set a numeral number to be displayed.

When the NT11 is operated, the screen displays the contents of the numeral memory table entry.

Also, by relating the numeral memory table entries with the bar graphs, the bar graphs corresponding to the data of the numeral memory table entries can be displayed.

Numerals Which can be Displayed

The power of expression of the screen can be increased by giving various attributes such as the enlarged or reverse display to the numerals of the numeral memory table entry.

The numeral attributes can be set in the edit screen when creating the screen data by using the support tool.

The following types of numerals can be displayed on the NT11:

- Digits of the whole numbers: 1 to 8 digits
- Digits of the decimal fraction: 0 to 7 digits
- Character sizes: Normal
- Enlarged display: Double width
- Sign display setting
- Decimal/hexadecimal display setting
- Zero suppress setting

Reference Zero suppress setting

The numeral data are displayed in designated display areas as right-aligned. If the number of digits of a numeral data is smaller than that of the display area, number "0"s will be displayed at the vacant digits. These "0"s will not be displayed if the zero suppress setting is made for "Yes".

4-5 Bar Graphs

The contents of the numeral memory table entries of the NT11 can be displayed as bar graphs as well as numeral data.

4-5-1 Bar Graph Functions

The bar graph function displays a value in a bar graph form as a percentage to the specified value according to the contents of a numeral memory table entry. Up to 4 bar graphs can be registered in one screen.

- Reference table entry

Numeral memory table entries used as the reference for the bar graph display can be set.

Note The bar graph display cannot use hexadecimal numbers. If hexadecimal numbers are set in the reference numeral memory table entry, the bar graph cannot be displayed.

Bar Graph Attributes

The following attributes can be set with the NT11 for the bar graph display:

Use the support tool to make settings for the bar graph display when creating the screen data.

- Position and size

The display position and size (length) of a bar graph can be set.

The width of the bar graph can be set in the range of 8 dots.

- Orientation and incremental direction

The type of bar graph displayed by the NT11 has a horizontal orientation and increments to the right.



Direction: →

- Graph frame

Select whether or not the graph frame (boundary line of a graph display area) which indicates the effective display range is displayed.



← This frame is not displayed if "Graph frame: No" has been set.

- Setting the 100% value and % display

Set a value which corresponds to 100% for the "100% value". The available value range is "1 to 99999999" (max. eight digits). For the "% display", whether or not the proportion (percentage) of the reference numeral memory table value to the "100% value" is displayed in a numeral can be selected. The display value is calculated as follows:

$$\text{"\% display" value} = \text{Numeral memory table value} \div \text{"100\% value"} \times 100$$

For the font and attributes used for the numeral display, refer to "Numerals which can be displayed" (page 95).

- Display of negative values (less than 0%)

The bar graph is displayed in the range of 0% to 100%. The end of the bar graph indicates 0%. Values below 0% are indicated as 0%.

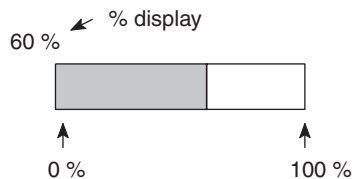

- Display method when the percentage value is in the range 100% to 999%

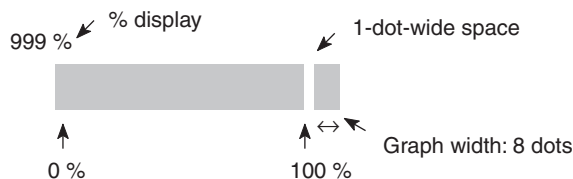

- Display method when the percentage value is 1000% or greater

The bar graph will be displayed the same as (2) above.

The percentage value is indicated by three asterisks:

***%

4-6 Numeral Setting

The NT11 features a numeral setting function which makes it easy to input numerical value on the screen.

4-6-1 The Numeral Setting Function

The numeral setting function is used to enter numerical values directly into a numeral memory table entry from the screen. Screen upgrading and PLC notification are executed simultaneously.

Numerical values are input from the screen by using the numeric keys. A maximum of 8 numeral settings can be registered for one screen.

Basic Procedure

1,2,3...

The procedure for numeral setting is as follows.

1. Input the numerical value using numeric keys.
2. The input numerical value is displayed in the numeral setting area on the screen.
3. Confirm the input numerical value (by pressing the [ENTER] key); it will be written to the numeral memory table entry, and simultaneously notified to the PLC.

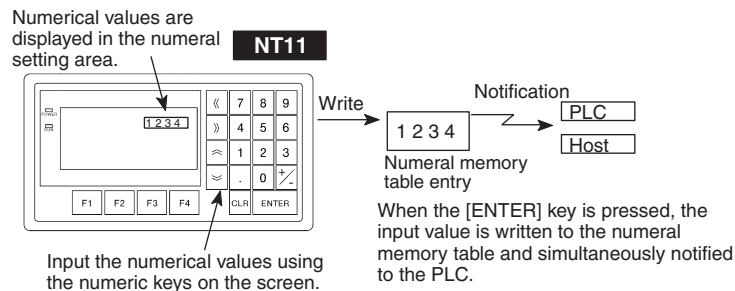

If there is more than one numeral setting area, the one in which the numerical value is to be input can be selected by using \llcorner , \lrcorner , \blacktriangledown , \blacktriangleleft or key.

If the numeral setting area is changed during numerical value input (before pressing the “ENTER” key), the numerical value being input is invalidated.

To clear a numerical value, press the [CLR] key.

Restrictions on Input

Using the numeral setting function, decimal values of up to 8 digits (7 digits if a negative value) can be input.

The number of digits and area for the numeral setting function are set using the support tool.

It is also possible to set the following attributes:

- Number of integer digits: 1 to 8
- Number of decimal fraction digits: 0 to 7
- Type of character: Half-size characters
- Character enlargement: Horizontal x2
- Sign display designation
- Zero suppress designation

The details for numeral attributes etc., are largely the same as for numeral display (refer to *Numerals Which can be Displayed* (page 95)).





Note To ensure greater safety for numeric inputs, perform upper/lower limit checks on the system.

4-6-2 Using Numeric Keys

To input numerical data at a numeral setting area during operation, first select the numeral setting at which the data is to be input, and then input the numerical value by pressing the numeric keys.

Selecting the Numeral Setting Area for Data Input

If there is more than one numeral setting area on the screen, select the one where numerical data is to be input using the arrow keys. The numeral setting area currently selected for input is indicated by a frame (cursor) displayed around the input area.

To select other numeral setting areas, use the , ,  and  arrow keys. By using these keys, the cursor can be shifted between multiple numeral setting areas (to select the one where data is to be input) in the way shown in the figure below.

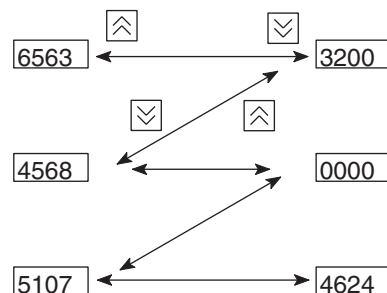

Inputting Numerical Values

Input numerical values using the following numeric keys: numerals (0 to 9), decimal point (.), sign (+, -), clear (CLR), and return ([ENTER]).

- Inputting the integer and decimal fraction parts

Input the integer and decimal fraction separately. First input the integer, then press the decimal point key (.) and input the decimal fraction.

If the integer or decimal fraction exceed their respective allowable numbers of display digits, they are shifted to the left.

4-7 Menu Screen Function

The NT11 has a function whereby screens can be switched even in the absence of a screen switching instruction from the PLC, by using numeric keys on the screen. This function is called the menu screen function.

When screen data is created with the support tool, specify “menu screen” as the screen attribute and assign switching destination screen numbers to numeric keys 1 through 4.

If one of these numeric keys is pressed during operation, the screen whose number was assigned to the key will be displayed. At the same time, the screen number of the destination screen is notified to the PLC.

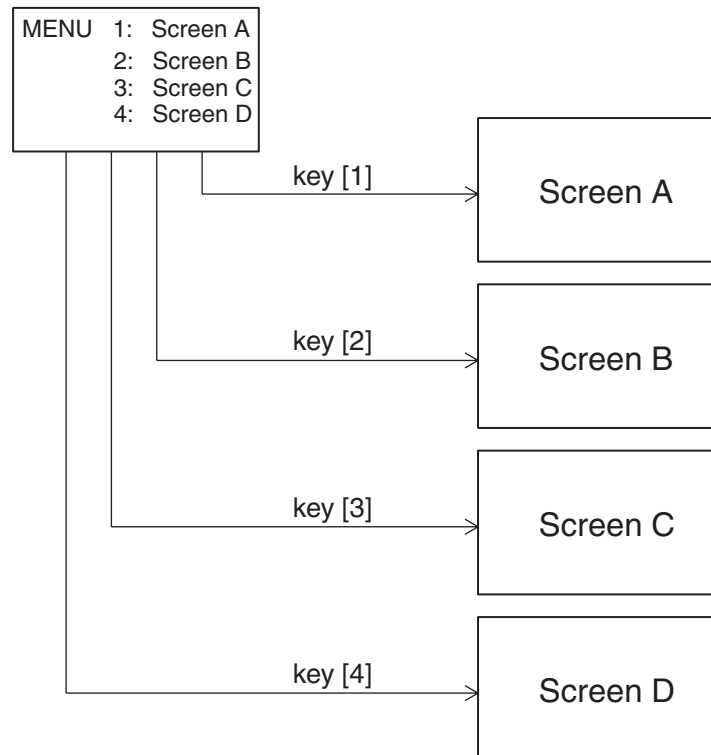

- Up to four destination screens can be registered per screen using the menu screen function. The screen numbers of the destination screens are assigned to numeric keys [1] to [4].
- For details on menu screen setting, refer to the NT11 support tool operation manual.

For the details of the menu screen setting, refer to the “NT-series Support Tool Operation Manual” (V061-E1-□).

4-8 Password Screen Display Function

For the purposes of security, the NT11 has a function that requires a password to be input before the specified screen can be displayed.

This section explains how to set and use passwords.

Screen transition in password input

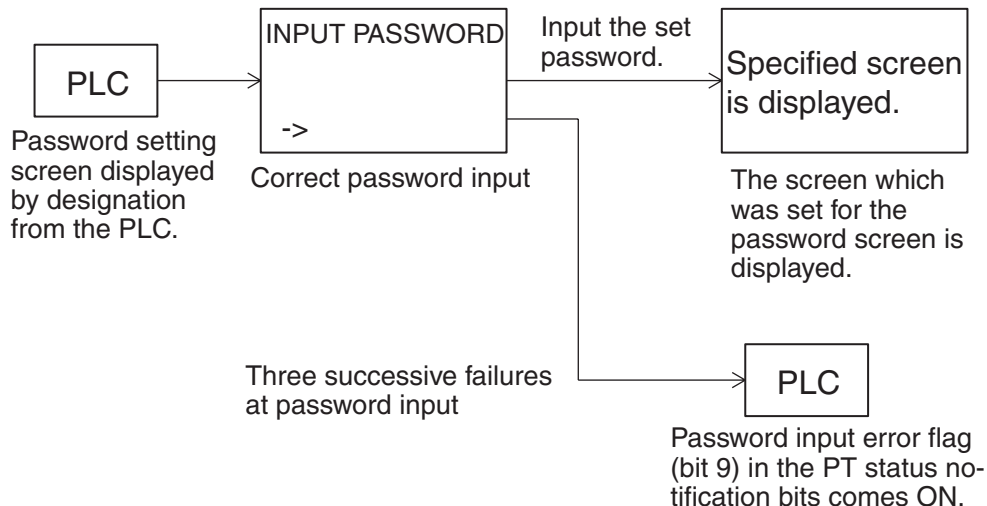

Notes on password input

- The password is set as a four-digit numerical value.
- The password for a password screen is input using the numeric keys on the panel of the NT11.
- When a password is input, it is not displayed on the screen. Only a box shaped cursor is displayed.
- The input password is checked after input of the fourth digit. There is no need to press the “ENTER” key.
- If the correct password is not input in three successive attempts, the password input error flag (bit 9) in the PT status notification bits comes ON and the specified screen is not displayed.

Password screen setting

The password and switching destination screen setting for the password screen are set using the support tool.

- Setting items
 - Number used as the password
 - Display start position
 - Switching destination screen

Procedure for displaying the password screen

Explained here is the procedure for displaying the password screen by specification from the PLC.

The password screen is displayed by writing the screen number of the screen for which the password setting was made into the screen switch setting word of the PT status control area.

[Screen switch setting word of the PT status control area]

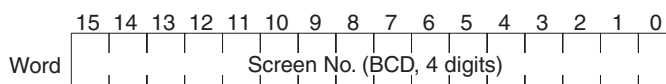

- Setting with the support tool

Make the following settings with the support tool.

PT status control area allocated word:	CIO/IR 0120
PT status notify area allocated word:	CIO/IR 0130
Password screen number:	10
Screen number displayed on password input error:	20

- PLC program (for CQM1H)

Create the following PLC ladder program.

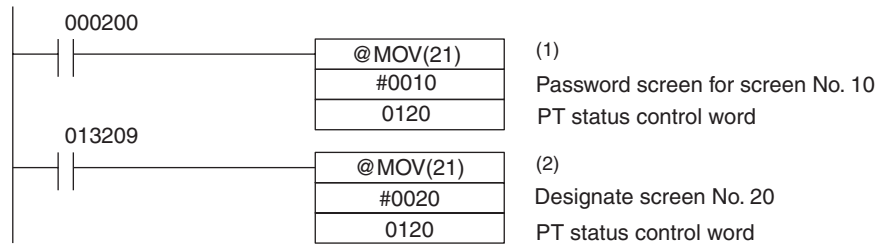

- Program operation

1,2,3...

1. When CIO/IR 000200 comes ON, “10” is set in the screen switch setting word of the PT status control area. As a result, the password screen for screen number 10 is displayed.
2. If the correct password is not input in three successive attempts, CIO/IR 013209 (the password input error flag (bit 4) in the PT status notification bits) comes ON.
On occurrence of a password input error, “20” is set in the screen switch setting word of the PT status control area and the screen whose screen number is 20 is displayed.

4-9 Display History Screen Function

The display history screen function is a function that records the display times, screen numbers, and screen comments of screens for which the display history attribute has been set using the support tool, in the order in which they were displayed.

The recorded data can be printed out by using the display history printing function.

Recording a display history

The procedure for recording a display history is presented below.

Operation

1. Set the screen attribute.

When creating screens with the support tool, set the display history attribute for those screens whose display history is to be recorded.

The display history will only be recorded for screens for which the display history attribute is set.

2. Compilation of display history records

When a screen for which the display history attribute is set is displayed during operation, this is recorded in the display history in the NT11.

- When compiling the display history, the following data relating to displayed screens is recorded in the memory:

Display time:	Time when the screen was displayed (month, day, hour, minute)
---------------	--

Screen number: Screen number of the displayed screen

Screen comment: The comment set for the displayed screen

The screen number of the screen for which the display attribute is registered is recorded in the record data area each time the screen is designated by the PLC.

A maximum of 256 records can be made in the display history (the number varies according to the memory capacity).

When the quantity of history data has reached the storage capacity, no new history data will be recorded.

The recorded data is deleted when the power is switched OFF.

If the recorded data is required, print it out before switching the power OFF.

Printing out the display history

The recorded display history can be printed out at a printer connected to the NT11. For details on how to do this, refer to *4-10 Daily Report/Display History Printing Function* (page 102).

4-10 Daily Report/Display History Printing Function

The NT11 can print daily reports and display histories in response to instructions from the PLC.

This section describes the procedure for printing daily reports and display histories.

Reference

- Printers of the following type can be connected to the NT11:
Models compatible with EPSON standard code (ESC/P)
- The history data can be backed up by a capacitor for 16 hours at 25°C. To enable backing up the history data, the setting must be changed from the System Menu. Refer to page 77 for details.

4-10-1 Printing Daily Reports

The contents of the designated word are read and printed out in accordance with a format registered in advance with the support tool.

The method used to print the daily report is described below.

Printing format

Create the printing format by using the support tool.

- The following types of characters and numerals can be printed:
 - Fixed characters
Character attribute: Normal, Reverse
Character size: Equal, Wide
 - Variable characters (characters printed after reading the contents of a designated word device)
Character attribute: Normal
Character size: Equal, Wide
 - Variable numerical values (numerical values printed after reading the contents of a designated word device)
Display sign: Yes
Zero suppression: Yes
Number of digits: 2 words (8 digits)

- Items set with the support tool
 - Printing format
 - Numerical value/character-string storage word (type of word and head word)
 - Display start position (Designate the top left position. Any line and column can be specified.)
 - Number of integral digits displayed (1 to 8)
 - Number of digits displayed after the decimal point (0 to 7)
 - Number of characters (Specified as the number of words: 1 word = 2 characters.)
- Example printout

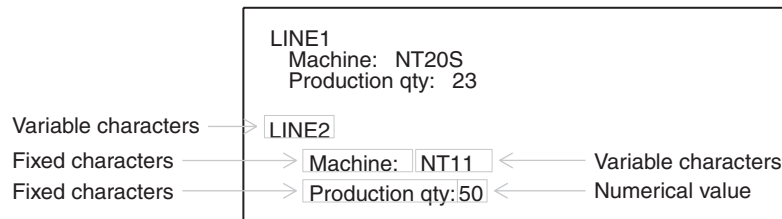

Printing procedure

Explained here is the procedure for printing a daily report in response to an instruction from the PLC.

The printing instruction from the PLC takes effect by setting the status of bit 4 (daily report printing) of the PT status control area.

To designate printing, bit 4 of the PT status control area is set to "1". One report is printed each time bit 4 is set to "1". To print the report again, the bit status must be returned to "0" and then set to "1" again.

[PT status control bits of the PT status control area]

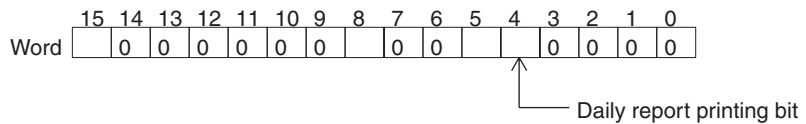

- Setting at the support tool
 - Perform the following setting with the support tool.
 - PT status control area allocated word: CIO/IR 0120
- PLC program
 - Create the following PLC ladder program for CQM1H:

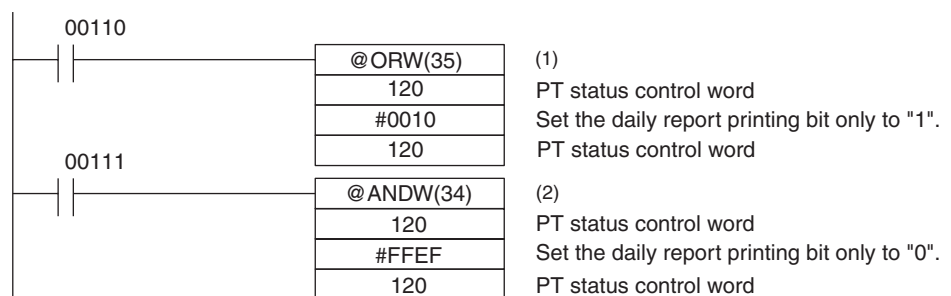

- Program operation

- 1,2,3...
1. When CIO/IR 00110 comes ON, the daily report printing bit (bit 4) of the PT status control area is set to "1". The status of bits other than bit 4 remains unchanged.
When bit 4 is set to "1", the daily report is printed.
 2. When CIO/IR 00111 comes ON, the daily report printing bit (bit 4) of the PT status control area is set to "0". The status of bits other than bit 4 remains unchanged.

4-10-2 Printing Display Histories

The data recorded by the display history screen function can be printed. This section explains the procedure for printing display histories.

Printing format

In display history printing, the display number, display time, and comment for the displayed screen are printed in a fixed format.

- Items set with the support tool
 - Attribute of the displayed screen
 - Comment for the displayed screen
- Example printout

NO.	DATA-TIME	SCREEN	COMMENT
0001	02/04-08:32	0001	LINE ERROR
0002	02/04-10:21	0005	MOTOR ERROR
0003	02/04-10:48	0019	COMPRESSER ERROR
0004	02/04-11:50	0005	MOTOR ERROR
0005	02/05-14:28	0019	COMPRESSER ERROR
0006	02/06-13:17	0040	PRESS

Reference The NT11 does not incorporate a clock.

Time data is recorded by referring to the PLC clock data.

Printing procedure

Explained here is the procedure for printing a display history in response to an instruction from the PLC.

The printing instruction from the PLC takes effect by setting the status of bit 5 (display history printing) of the PT status control area.

To designate printing, bit 5 of the PT status control area is set to "1". One report is printed each time bit 5 is set to "1". To print the report again, the bit status must be returned to "0" and then set to "1" again.

[PT status control bits of the PT status control area]

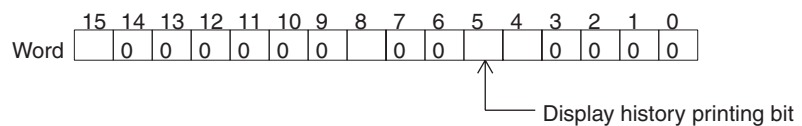

- Setting at the support tool
 - Perform the following setting with the support tool.
 - PT status control area allocated word: CIO/IR 0120
- PLC program
 - Create the following PLC ladder program:

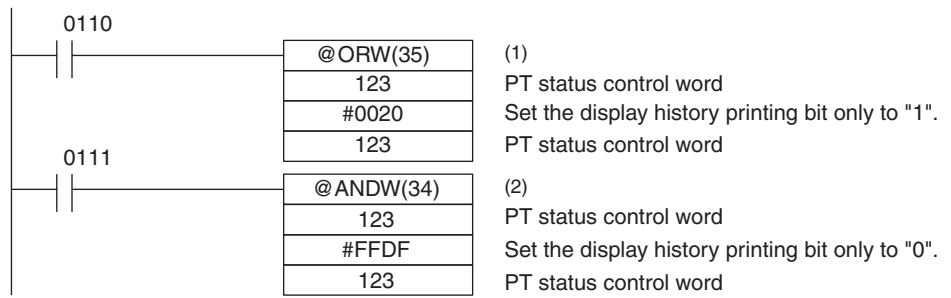

• Program operation

- 1,2,3...**
1. When CIO/IR 0110 comes ON, the display history printing bit (bit 5) of the PT status control area is set to "1". The status of bits other than bit 5 remains unchanged.
When bit 5 is set to "1", the display history is printed.
 2. When CIO/IR 0111 comes ON, the display history printing bit (bit 5) of the PT status control area is set to "0". The status of bits other than bit 5 remains unchanged.

SECTION 5

Using Host Link/NT Link

This section describes how the NT11 can be used when using the host link/NT link.

5-1	Screen Creation Procedure	108
5-2	Outline of Host Link/NT Link Operation	109
5-2-1	Equipment and Settings Used in This Chapter	109
5-2-2	Switching the Screen Display	110
5-2-3	Notifying the Display Screen to the PLC (To Display the Number of Currently Displayed Screen)	112
5-3	Memory Table Entries and Bar Graph	115
5-3-1	Allocation Words and Display of Memory Table Entries	117
5-3-2	Changing Displayed Numerals or Character Strings (Changing the Contents of Allocated Words....Direct Specification)	120
5-3-3	Copying Memory Table Entries	121
5-3-4	Upgrading Bar Graphs (Changing the Contents of Allocated Words)	125
5-4	Numeral Setting	126
5-4-1	Notification of Numbers to the PLC	126
5-5	NT11 Status Control	129
5-5-1	Controllable NT11 Functions	129
5-5-2	How to Control NT11 Functions	130
5-6	Notification of the Operating Status to the PLC (Determining the NT11 Operating Status)	132
5-6-1	Ascertainable NT11 Statuses (Notified Operating Statuses)	132
5-6-2	Reading the NT11 Operating Statuses	133

5-1 Screen Creation Procedure

Follow the procedure shown below to create screens for the NT11.

The following gives the procedure assuming that the setting for the PT has been completed. The operating procedure for a Support Tool is not given here. For the operating procedure for the Support Tool, refer to the *NT-series Support Tool Version 4.7 for Windows Operation Manual (V061-E1-□)*.

Creating a New Screen

Tool Setting (PT model)

Set the PT model as follows:

- NT11: Set NT11-V1.
- NT21: Set NT21.
- NT31: Set NT31-V2.
- NT31C: Set NT31C-V2.
- NT631: Set NT631-V2.
- NT631C: Set NT631C-V2.

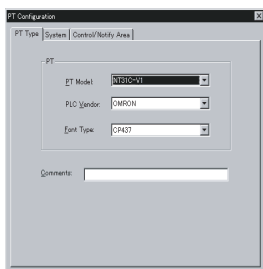

System Setting (Memory Switch Setting)

Set the memory switches that determine the basic operation of the PT. The numeral/character string/bit memory table entry settings should also be made at this stage.

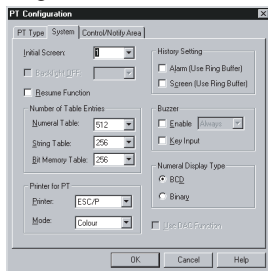

Setting for PT Status Control/Notify Area

Allocate words for the PT status control area and PT status notify area, necessary for the direct connection function, in the host.

For details, refer to *4-3 Areas for Control/Notification* (page 89).

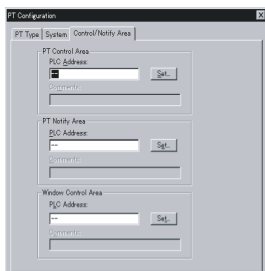

Correcting an Existing File

File Designation

Designate a work file.

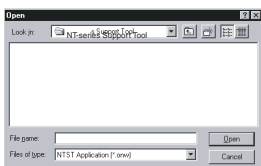

Importing DOS Version Data

File Designation

Designate the work file to be data converted.

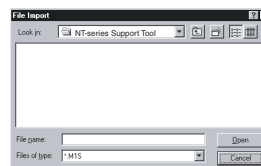

Setting the Clock Data Area (NT21 only)

Set the address of the first word to allocate as the Clock Data Area in the host so that the clock data can be read from the host.

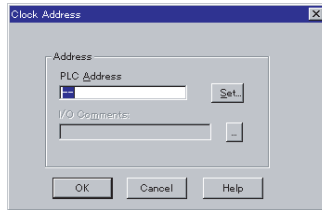

Creating and Correcting a Screen SECTION 4 NT11 Functions.

After designating a screen, set the screen properties and register elements for the screen or correct the screen. If necessary, create marks, image data, and library data, and set the initial values of memory table entries. For details of screens and elements, refer to

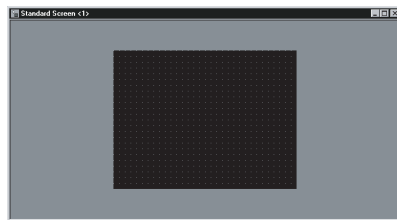

Saving a File

Save the created screen data to a file.

Transmitting the Screen Data

Transmit the created screen data to the PT. After setting the PT in the Transmit mode, execute the screen data transmission operation with the Support Tool.

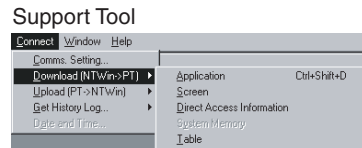
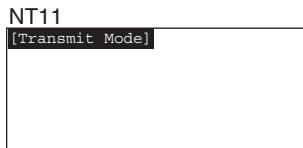

Caution Carefully check the operation of all screen data and host programs before using them. Otherwise the system may operate unpredictably.

5-2 Outline of Host Link/NT Link Operation

This section describes the basics for operating the NT11 through communications with the PLC using the host link/NT link.

5-2-1 Equipment and Settings Used in This Chapter

The following equipment and settings are used in the examples in this Chapter:

[Equipment] PT: NT11-SF121-EV1

PLC: CQM1H

Support tool: NT Support Tool for Windows Ver. 4.7

5-2-2 Switching the Screen Display

The following describes the procedure used to switch the NT11 screen display by controlling from the PLC.

Reference The display screen can be switched also by pressing a numeric key during the operation after registering a screen number to the numeric key. For this function, refer to *4-7 Menu Screen Function* (page 99).

To switch the NT11 screen display by controlling from the PLC, write a screen number at the “screen switch setting” in the PT status control area.

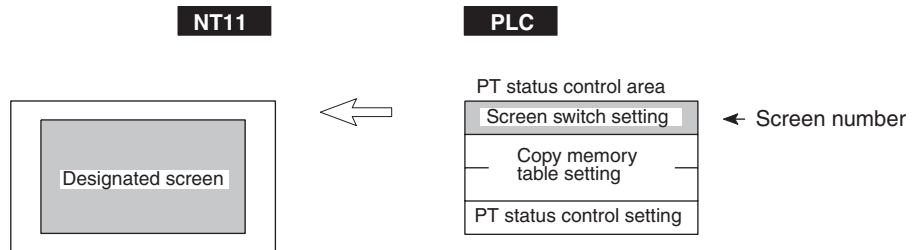

[Screen switch setting in the PT status control area]

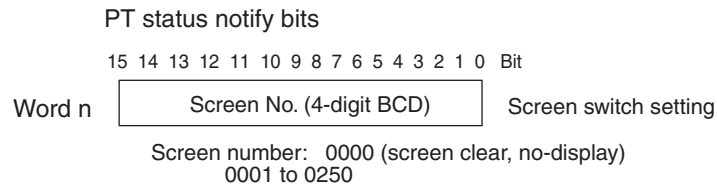

- Available allocation words

The PT status control area (PLC to PT) can be allocated to the following PLC areas.

Words Allocated for the PT Status Control Area

Words can be allocated for the PT status control area (host ↔ PT) in the following host (PLC) areas.

Symbol	C-series PLCs	Allocation	CV-series PLCs	Allocation	CS/CJ-series PLCs	Allocation
None	IR Area	OK	CIO Area	OK	CIO Area	OK
H	HR Area	OK	---	---	HR Area	Not for Host Link
A	AR Area	OK	Auxiliary Area	No	AR Area	OK
L	LR Area	OK	---	---	LR Area * ¹	Not for Host Link
T	TC Area, Timer PVs	No	Timer Area, Timer PVs	No	TC Area, Timer PVs	No
TU	---	---	---	---	TC area, Timer Completion Flags	No
C	TC Area, Counter PVs	No	Counter Area, Counter PVs	No	TC Area, Counter PVs	No
CU	---	---	---	---	TC Area, Counter Completion Flags	No
W	---	---	---	---	WR Area	Not for Host Link
TK	---	---	---	---	Task Flags	No
D	DM Area	OK	DM Area	OK	DM Area	OK
E	EM Area * ² , current bank	OK	EM Area, current bank	Not for Host Link	EM Area, current bank	Not for Host Link
EO_ to EC_	---	---	---	---	EM Area, EM banks 0 to C	Not for Host Link

*1 LR 00000 to LR 00199 are converted to CIO 01000 to CIO 01199.

*2 The EM Area is supported only by the C200HX/HG/HE(-Z)E PLCs.

The Auxiliary Area of the CVM1 and CV-series PLCs is allocated to system functions, and cannot be used for purposes other than system use.

The range of each memory area differs according to the PLC. Refer to *Appendix D Making the Cable* on page 153.

Procedure

1. Use the support tool to allocate the PT status control area (PLC to PT) to the PLC memory.
2. Create a PLC program to write the number of the displayed screen to the “screen switch setting word” in the PT status control area.

Reference

Use a 4-digit BCD (binary-coded decimal) value to set a screen number.

If a screen has been switched by operating the PT status control area (PLC to PT), the contents of the “currently displayed screen word” in the PT status notify area (PT to PLC) also change.

- Screen switching timing

The NT11 screen switches when the contents of the “screen switch setting” have changed. To re-specify the number of the currently specified screen, first write the value 0000 to clear the screen before writing the appropriate screen number.

- Use of the screen switching strobe

Create a program to read the number of the currently displayed screen and to write the number to the “screen switch setting word” at the leading edge of the “screen switching strobe” of the PT status notify area. This program enables screen switching by using the Menu screen on the NT11 and eliminates repeated setting of the same screen number. If the screen switching is not executed on the NT11, the screen switching strobe does not need to be checked.

For the screen switching strobe, refer to the “notifying the displayed screen to the PLC” mentioned below.

Example of Display Screen Switching

This example operates the PLC switch (bit) to switch the NT11 display screen.

- Support tool settings

Make the following settings with the support tool:

PT status control area: Word 0100

PT status notify area: Word 0110

Screen number to be created: Screen No. 2 and No. 3

- PLC ladder program

Create a PLC ladder program as follows:

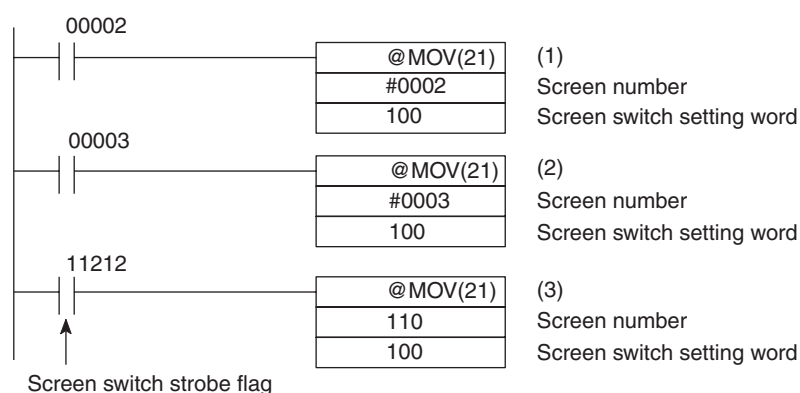

- Program operation

- 1,2,3...**
1. Screen No. 2 is displayed on the NT11 when bit 00002 turns ON.
 2. Screen No. 3 is displayed on the NT11 when bit 00003 turns ON.
 3. When the screen switch strobe flag turns ON, the number of the currently displayed screen is read and written to the currently displayed screen word in the PT status notify area. In this case, the NT11 will not write the same screen twice.

5-2-3 Notifying the Display Screen to the PLC (To Display the Number of Currently Displayed Screen)

The following describes the processing to display the number of currently displayed screen of the NT11.

This processing reads the data from the PLC status notify area.

To indicate that the screen has switched, use the screen switch strobe flag.

To display the number of the currently displayed screen, use the currently displayed screen word.

When the screen has switched, the NT11 notifies the following to PT status notify area (PT to PLC) allocated to the PLC.

Screen switch notification: Screen switch strobe flag of the PT status word
 New screen number: Currently displayed screen word
 By reading the currently displayed screen word when the screen switch strobe flag has turned ON, the number of the currently displayed screen on the NT11 is displayed.

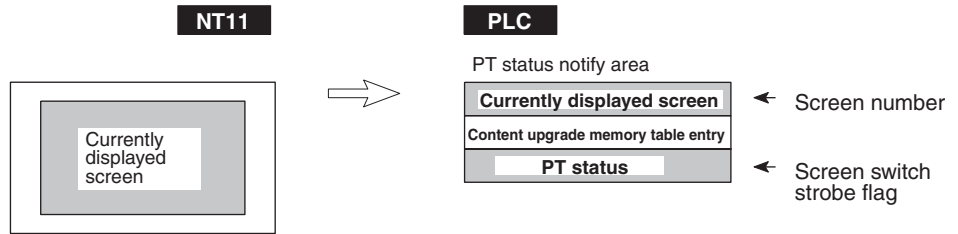

[Currently displayed screen] and [PT status] words in the PT status notify area

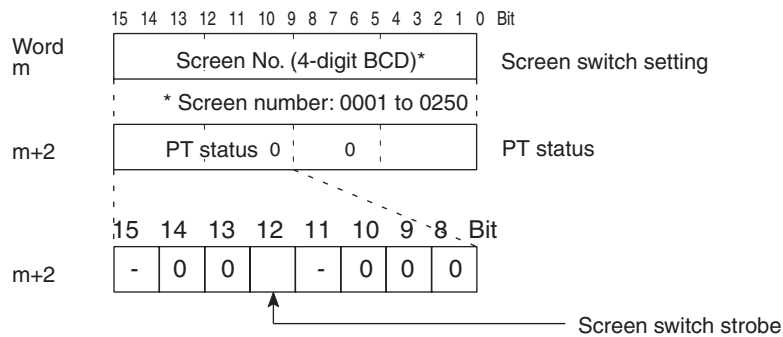

Use a 4-digit BCD (binary-coded decimal) value to set a screen number.
 The screen switch strobe bit reverts to OFF (0) after this is notified to the PLC.

- Available allocation words

The PT status notify area (PT to PLC) can be allocated to the following PLC areas.

Words Allocated of the PT Status Notify Area

Words can be allocated for the PT status notify area (PT → host) in the following host (PLC) areas.

Symbol	C-series PLCs	Allocation	CV-series PLCs	Allocation	CS/CJ-series PLCs	Allocation
None	IR Area	OK	CIO Area	OK	CIO Area	OK
H	HR Area	OK	---	---	HR Area	Not for Host Link
A	AR Area	OK	Auxiliary Area	No	AR Area	OK
L	LR Area	OK	---	---	LR Area *1	Not for Host Link
T	TC Area, Timer PVs	No	Timer Area, Timer PVs	No	TC Area, Timer PVs	No
TU	---	---	---	---	TC Area, Timer Completion Flags	No
C	TC Area, Counter PVs	No	Counter Area, Counter PVs	No	TC Area, Counter PVs	No
CU	---	---	---	---	TC Area, Counter Completion Flags	No
W	---	---	---	---	WR Area	Not for Host Link
TK	---	---	---	---	Task Flags	No
D	DM Area	OK	DM Area	OK	DM Area	OK

Symbol	C-series PLCs	Allocation	CV-series PLCs	Allocation	CS/CJ-series PLCs	Allocation
E	EM Area *2, current bank	OK	EM Area, current bank	Not for Host Link	EM Area, current bank	Not for Host Link
EO_ to EC_	---	---	---	---	EM Area, EM banks 0 to C	Not for Host Link

*1 LR 00000 to LR 00199 are converted to CIO 01000 to CIO 01199.

*2 The EM Area is supported only by the C200HX/HG/HE (-Z)E PLCs.

The Auxiliary Area of the CVM1 and CV-series PLCs is allocated to system functions, and it cannot be used for purposes other than system use.

The range of each memory area differs according to the PLC. Refer to *Appendix D Making the Cable* on page 153.

Procedure

1. Use the support tool to allocate the PT status notify area (PT to PLC) to the PLC memory.
2. Create a PLC program to read the “currently displayed screen word” in the PT status notify area when the “screen switch strobe flag” in the PT status notify area has turned ON.

Reference

- The contents of the “currently displayed screen word” are updated also by switching the screen by using the menu screen function of the NT11.
- For details on the menu screen function, refer to *4-7 Menu Screen Function* (page 99).

Example of Reading the Number of Currently Display Screen

This example gives a PLC program that reads the screen number each time the screen is switched. In this example, the number of the previous screen is also stored.

- Support tool settings
 Make the following settings with the support tool:
 PT status notify area: Word 0110
- PLC ladder program

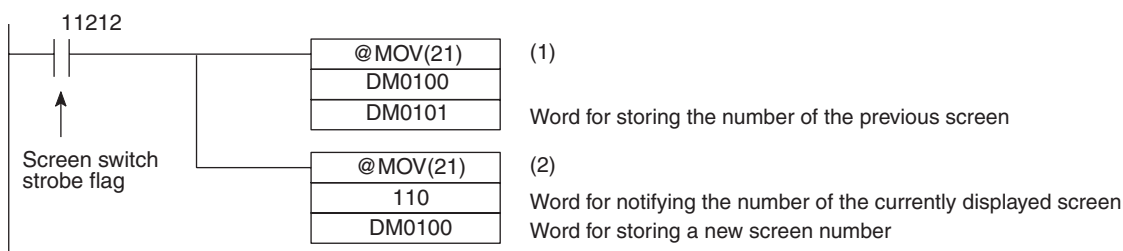

- Program operation
1. When the NT11 screen display switches and the screen switch strobe flag (bit 11212) turns ON, the contents of DM0100 are transferred to DM0101. The number of the previously displayed screen is stored in word 0101.
 2. The new screen number notified by the NT11 is read and transferred to DM0100. The number of the currently displayed screen is stored in DM0100.

5-3 Memory Table Entries and Bar Graph

This section describes allocation of the memory table entry to PLC words, and changes to the contents of words necessary to display characters, numerals, and graphs by communicating with the PLC using the host link/NT link.

For the functions relating to memory tables and bar graphs, refer to 4-3 Areas for Control/Notification (page 89) and 4-5 Bar Graphs (page 96), respectively.

Writing Words to the Character-String Memory Table Entries

Since the character-string memory table entries can be allocated to the words in the PLC, the PLC can write data to the character-string memory table entries or the initial values can be set when creating the screen data.

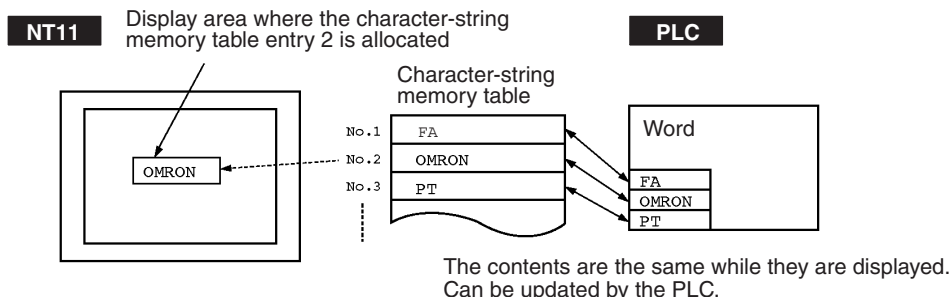

During the operation, the display contents are automatically updated so that the contents of the character-string memory table entry being displayed are the same as that of the PLC word.

Setting the Words of the Character-String Memory Table Entry

When creating the screen data by using the support tool, make the following settings for each numbered character-string:

- Initialization setting

Set whether or not the PLC words are initialized with the character-string memory table initial value registered to the screen data memory when the main power supply is turned ON or reset.
- Number of registration words

Set the number of words within 8 words required for registering the character-string data. One word can store two characters.
- Setting the words for the character-string memory table entries

The character-string memory table entries can be allocated to the following PLC words. Set the word type and the first word.

Allocated Words

One to twenty words can be allocated at the host to each character string table entry. Words can be allocated in the following host (PLC) areas.

Symbol	C-series PLCs	Allocation	CV-series PLCs	Allocation	CS/CJ-series PLCs	Allocation
None	IR Area	OK	CIO Area	OK	CIO Area	OK
H	HR Area	OK	---	---	HR Area	Not for Host Link
A	AR Area	OK	Auxiliary Area	No	AR Area	OK
L	LR Area	OK	---	---	LR Area ^{*1}	Not for Host Link
T	TC Area, Timer PVs	No	Timer Area, Timer PVs	No	TC Area, Timer PVs	No
TU	---	---	---	---	TC Area, Timer Completion Flags	No

Symbol	C-series PLCs	Allocation	CV-series PLCs	Allocation	CS/CJ-series PLCs	Allocation
C	TC Area, Counter PVs	No	Counter Area, Counter PVs	No	TC Area, Counter PVs	No
CU	---	---	---	---	TC Area, Counter Completion Flags	No
W	---	---	---	---	WR Area	Not for Host Link
TK	---	---	---	---	Task Flags	No
D	DM Area	OK	DM Area	OK	DM Area	OK
E	EM Area *2, current bank	OK	EM Area, current bank	Not for Host Link	EM Area, current bank	Not for Host Link
EO_ to EC_	---	---	---	---	EM Area, EM banks 0 to C	Not for Host Link

*1 LR 0000 to LR 00199 are converted to CIO 01000 to CIO 01199.

*2 The EM Area is supported only by the C200HX/HG/HE(-Z)E PLCs.

If the “number of registration words x 2” (“word setting window”) set with the support tool is larger than the “number of character digits” (“character-string display setting” window), the character-string may be broken halfway.

The range of respective area varies with the type of PLC. Refer to *Appendix H Special Characters* (page 163).

Writing Numerals to Numeral Memory Table Entries

Since numeral memory table entries can be allocated to PLC words, it is possible to write data into the numeral memory tables from the PLC and to set the initial values during screen data creation.

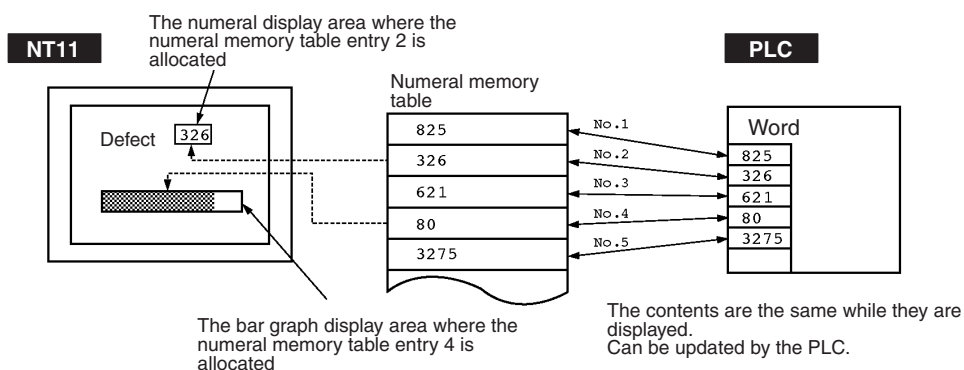

During the operation, the display contents are automatically updated so that the contents of the numeral memory table entry being displayed are the same as that of the PLC word.

Setting the Words of the Numeral Memory Table Entry

When creating the screen data by using the support tool, make the following settings for each numbered numeral:

- Initialization setting
Set whether or not the PLC words are initialized with the numeral memory table initial value registered to the screen data memory when the main power supply is turned ON or reset.
- Number of registration words
Set the number of words within 2 words required for registering the numeral data. One word can store up to 4 digits. Two words can store up to 8 digits.
- Setting the words for the numeral memory table entries

The numeral memory table entries can be allocated to the following PLC words. Set the word type and the first word.

Symbol	C-series PLCs	Allocation	CV-series PLCs	Allocation	CS/CJ-series PLCs	Allocation
None	IR Area	OK	CIO Area	OK	CIO Area	OK
H	HR Area	OK	---	---	HR Area	Not for Host Link
A	AR Area	OK	Auxiliary Area	No	AR Area	OK
L	LR Area	OK	---	---	LR Area ^{*1}	Not for Host Link
T	TC Area, Timer PVs	1-word entries only	Timer Area, Timer PVs	1-word entries only	TC Area, Timer PVs	1-word entries only
TU	---	---	---	---	TC Area, Timer Completion Flags	No
C	TC Area, Counter PVs	1-word entries only	Counter Area, Counter PVs	Not for Host Link	TC Area, Counter PVs	1-word entries only
CU	---	---	---	---	TC Area, Counter Completion Flags	No
W	---	---	---	---	WR Area	Not for Host Link
TK	---	---	---	---	Task Flags	No
D	DM Area	OK	DM Area	OK	DM Area	OK
E	EM Area ^{*2} , current bank	OK	EM Area, current bank	Not for Host Link	EM Area, current bank	Not for Host Link
EO_ to EC_	---	---	---	---	EM Area, EM banks 0 to C	Not for Host Link

*1 LR 00000 to LR 00199 are converted to CIO 01000 to CIO 01199.

*2 The EM Area is supported only by the C200HX/HG/HE(-Z)E PLCs.

The range of respective area varies with the type of PLC. Refer to *Appendix H Special Characters* (page 163).

5-3-1 Allocation Words and Display of Memory Table Entries

The character-string memory table entries and numeral memory table entries can be allocated to the following PLC words.

Set the word type and the first word. The number of words required for allocating a memory table entry and the areas to which a memory table entry can be allocated vary between the character-string memory table and the numeral memory table.

- Number of words required for the allocation

The number of words used for allocating one memory table entry is as mentioned below.

Numeral memory table entry: 1 word (max. 4 digits) or 2 words (max. 8 digits)

Character-string memory table entry: 1 to 10 words (2 to 20 characters)

- Available allocation words

The memory table entries can be allocated to the following PLC areas:

Allocated Words

Either one or two words can be allocated at the host for each numeral memory entry. Words can be allocated in the following host (PLC) areas.

Symbol	C-series PLCs	Allocation	CV-series PLCs	Allocation	CS/CJ-series PLCs	Allocation
None	IR Area	OK	CIO Area	OK	CIO Area	OK
H	HR Area	OK	---	---	HR Area	Not for Host Link
A	AR Area	OK	Auxiliary Area	No	AR Area	OK
L	LR Area	OK	---	---	LR Area ^{*1}	Not for Host Link
T	TC Area, Timer PVs	1-word entries only	Timer Area, Timer PVs	1-word entries only	TC Area, Timer PVs	1-word entries only
TU	---	---	---	---	TC Area, Timer Completion Flags	No
C	TC Area, Counter PVs	1-word entries only	Counter Area, Counter PVs	Not for Host Link	TC Area, Counter PVs	1-word entries only
CU	---	---	---	---	TC Area, Counter Completion Flags	No
W	---	---	---	---	WR Area	Not for Host Link
TK	---	---	---	---	Task Flags	No
D	DM Area	OK	DM Area	OK	DM Area	OK
E	EM Area ^{*2} , current bank	OK	EM Area, current bank	Not for Host Link	EM Area, current bank	Not for Host Link
E0_ to EC_	---	---	---	---	EM Area, EM banks 0 to C	Not for Host Link

*1 LR 00000 to LR 00199 are converted to CIO 01000 to CIO 01199.

*2 The EM Area is supported only by the C200HX/HG/HE(-Z)E PLCs.

The range of respective area varies with the type of PLC. Refer to *Appendix H Special Characters* (page 163).

- Contents of the numeral memory table entries

Numerals are stored in the allocated words as shown below.

[Stored as a single word]

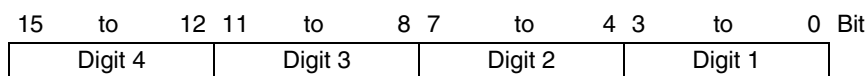

Example: 1234

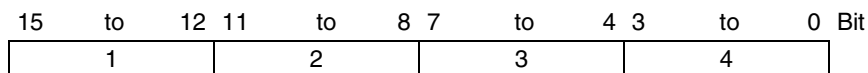

[Stored as a double words]

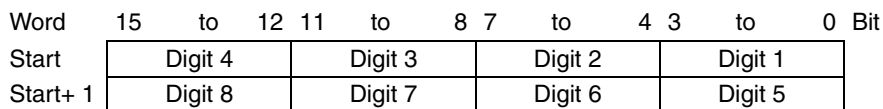

Example: 12345678

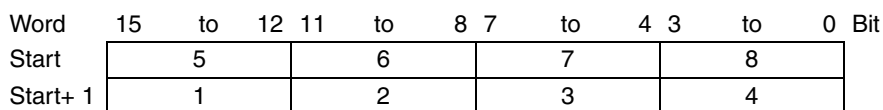

- Displaying the numeral memory table entry

Numerals can be displayed in three different ways according to the contents of the numeral memory table entry, as mentioned below.

The most significant digit (digit 4 of a single word or digit 8 of a double word) is processed in different ways.

Decimal display without signs: If the most significant digit is “F”, it is handled as “0”, and the most significant digit other than “F” and other digits are handled as stored in the allocated words.

Decimal display with signs: If the most significant digit is “F”, it is handled as “-” (minus sign), and the most significant digit other than “F” and other digits are handled as stored in the allocated words.

[Numeral memory table display examples]

- When the data are numeral data (0 to 9)

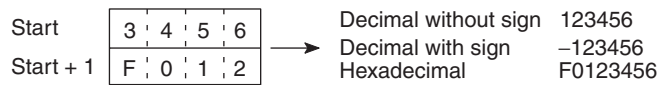

- When the data contain characters (A to F)

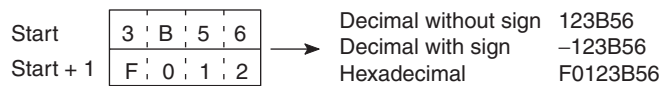

If the hexadecimal data (A to F) are stored when the decimal display has been set, the alphabets are displayed.

If the number of display digits has been set to be smaller than the maximum number of digits of the registration words (4 digits for 1 word; 8 digits for 2 words), the contents of the allocated words are not displayed and “*” symbols will be displayed at all digits.

If the most significant digit is “F” when “decimal with signs” has been set, the numeral is handled as a negative number. The maximum number of digits of the negative number becomes smaller than that of the positive number by 1 digit.

Reference

The actual display will vary according to the “zero suppress” setting and decimal fraction setting as well as the contents mentioned above. Refer to the “NT-series Support Tool Operation Manual” (V061-E1-□).

- Contents of the character-string memory table entry

A character-string is stored in the allocated words beginning with the first word in half-size characters.

Two half-size characters are stored in one word. One memory table entry can store up to 10 words (20 characters).

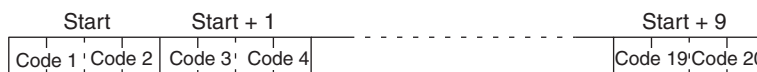

[Character-string memory table display example]

To display the characters in order, allocate the characters as follows.

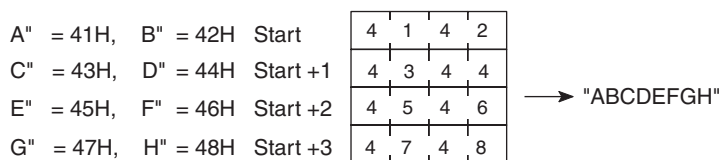

5-3-2 Changing Displayed Numerals or Character Strings (Changing the Contents of Allocated Words....Direct Specification)

The following describes the procedure to change displayed numerals or character-strings by changing the contents of the allocated words. Numerals and character-strings can be changed also by making a copy of the memory table entries. Refer to "Copying a memory table entry" explained later.

To change the numerals or character-strings displayed on the NT11, make changes with the numeral or character-string memory table entry. To make changes with the numeral or character-string memory table entry of the NT11, change the contents of words by the PLC.

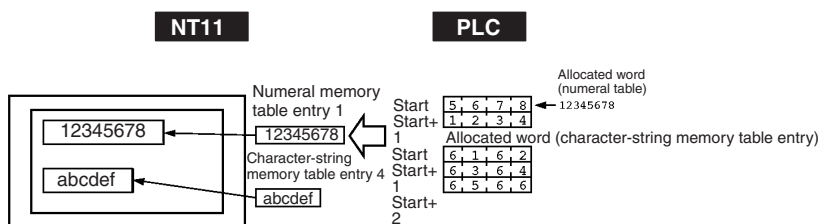

Reference When it is necessary to display changing data such as monitored data of words in the PLC, use the numeral and character-string memory tables. This must be used to change the display contents (contents of memory table entry or words).

Procedure

1. Use the support tool to allocate the numeral and character-string memory table entries to the PLC memory.
2. Register the memory table entries for the numerals and character-strings to be displayed when creating the screen data by using the support tool.
 To display a character-string, use "character display" and specify the character-string memory table entry by using the support tool.
 To display numerals, use "numeral display" and specify the numeral memory table entry by using the support tool.
3. Create a PLC program to write the contents of numerals and character-strings to be displayed on the NT11 to the PLC words.

Application Example of the Numeral Memory Table Entries Allocated to the PLC Words

This example gives the procedure to directly display the contents of the words allocated as the numeral memory table entries in the PLC memory. The NT11 screen display will change as the contents of the PLC word change.

- Support tool settings
 - Allocate the memory as shown below by using the support tool.
 - Numeral memory table entry No. 1: DM0000 (allocated words: 2 words)
 - Numeral memory table entry No. 2: DM0002 (allocated words: 1 word)
 - Screen numbers to be created: No. 1

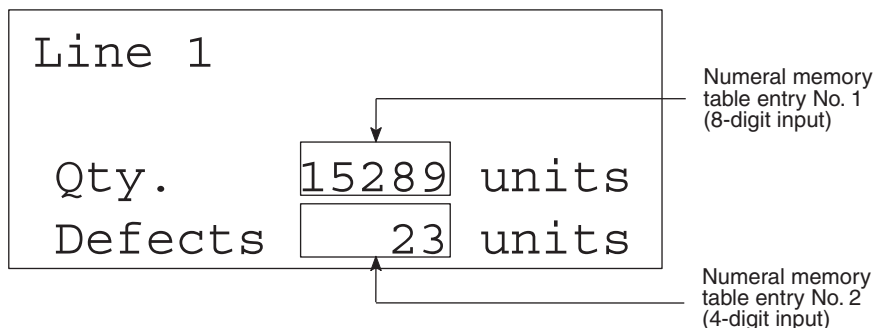

- PLC ladder program
Create a PLC ladder program as follows:

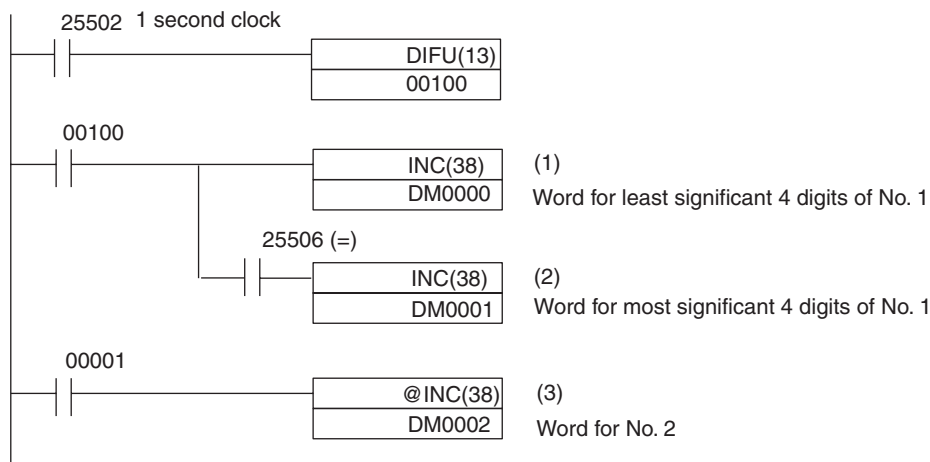

- Program operation
 1. The contents of word DM0000 are incremented by 1 each second. The value displayed on the NT11 in numeral memory table entry No. 1 increases by 1 each second.
 2. When the counter in (1) above causes an increase in the most significant digits, the contents of word DM0001 are incremented by 1 each second. The value displayed on the NT11 in numeral memory table entry No. 1 most significant digits increases by 1.
 3. When bit 00001 turns ON, the contents of DM0002 are incremented by 1. The value displayed on the NT11 in numeral memory table entry No. 2 increases by 1.

5-3-3 Copying Memory Table Entries

The following describes the procedure to change displayed numerals or character -strings by copying the contents of the memory table entry.

Numerals and character-strings can be changed also by changing the contents of the allocated words. Refer to “Changing displayed numerals or character -strings” explained before.

To change the numerals or character-strings displayed on the NT11, copy the data between the numeral or character-string memory tables by using the “copy memory table setting” of the PT status control area.

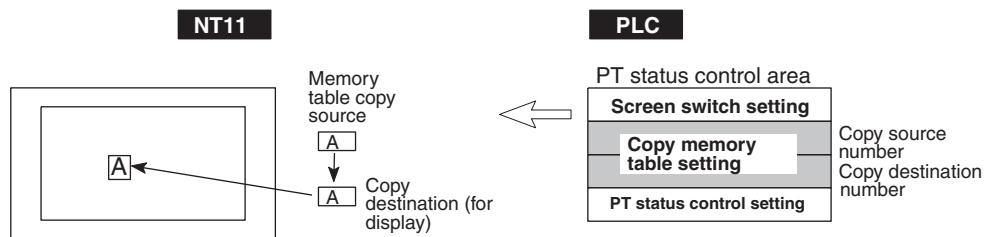

Write a memory table entry number etc. to the copy memory table setting area in the PT status control area in the PLC memory. Data will be copied between the memory table entries in the NT11 and the displayed value will change accordingly.

Reference This procedure is convenient to switch predetermined values or character-strings according to the situation. By preparing several units of contents, various contents can be displayed by switching them to suit the situation.

[“Copy memory table setting” of the PT status control area]

	15	14	13	12	11	10	9	8	7	6	5	4	3	2	1	0	Bit
Word n+1	0			Copy source memory table No. (3-digit BCD)													
n+2	Copy type			Copy destination memory table No. (3-digit BCD)													

) Copy memory table setting

Copy type:

- 0: Copy between the character-string memory table entries
- 1: Copy between the numeral memory table entries

Copy source and destination memory table entry numbers:

- Character-string memory table: 000 to 128
- Numeral memory table: 000 to 128

- Available allocation words

The PT status control area can be allocated to the following PLC areas:

Words Allocated for the PT Status Control Area

Words can be allocated for the PT status control area (host ↔ PT) in the following host (PLC) areas.

Symbol	C-series PLCs	Allocation	CV-series PLCs	Allocation	CS/CJ-series PLCs	Allocation
None	IR Area	OK	CIO Area	OK	CIO Area	OK
H	HR Area	OK	---	---	HR Area	Not for Host Link
A	AR Area	OK	Auxiliary Area	No	AR Area	OK
L	LR Area	OK	---	---	LR Area ^{*1}	Not for Host Link
T	TC Area, Timer PVs	No	Timer Area, Timer PVs	No	TC Area, Timer PVs	No
TU	---	---	---	---	TC area, Timer Completion Flags	No
C	TC Area, Counter PVs	No	Counter Area, Counter PVs	No	TC Area, Counter PVs	No
CU	---	---	---	---	TC Area, Counter Completion Flags	No
W	---	---	---	---	WR Area	Not for Host Link
TK	---	---	---	---	Task Flags	No
D	DM Area	OK	DM Area	OK	DM Area	OK

Symbol	C-series PLCs	Allocation	CV-series PLCs	Allocation	CS/CJ-series PLCs	Allocation
E	EM Area *2, current bank	OK	EM Area, current bank	Not for Host Link	EM Area, current bank	Not for Host Link
EO_ to EC_	---	---	---	---	EM Area, EM banks 0 to C	Not for Host Link

*1 LR 00000 to LR 00199 are converted to CIO 01000 to CIO 01199.

*2 The EM Area is supported only by the C200HX/HG/HE(-Z)E PLCs.

The range of respective area varies with the type of PLC. Refer to *Appendix H Special Characters* (page 163).

Reference

- Use the support tool to allocate the PT status control area (PLC to PT) to the PLC memory.
- Register the memory table entries for the numerals and character-strings to be displayed when creating the screen data by using the support tool.

To display a character-string, use “character display” and specify the character-string memory table entry by using the support tool.

To display numerals, use “numeral display” and specify the numeral memory table entry by using the support tool.
- Set the copy source data to the memory table entry when creating the screen data by using the support tool.

Use “table edit”.
- Create a PLC program to write the copy type, copy destination memory table entry number, and copy source memory table entry number to the “copy memory table entry” setting word in the PT status control area.
 - Order for writing to the PT status control area (PLC to PT)

First write the “copy destination memory table entry number”, and then, write the “copy source memory table entry number” to the PT status control area (PLC to PT).

The NT11 reads the area sometimes when the PLC is writing the settings. If the “copy source memory table entry number” has been written first and is changed, an unexpected memory table entry may possibly be changed.
 - Allocated words that the NT11 reads

The NT11 reads the allocated words in the PLC for the memory table entries which need to be displayed. If the copy source memory table entry is allocated to a PLC word, it may sometimes be used at the initialization only.
 - Use of the “copy type”

Copy will not be executed when the “copy type” is other than “0” or “1”. The memory table entry copy is executed only when the contents of the area are changed. To repeat copying of the same copy source and same copy destination, write a value other than “0” or “1” for the copy type, and then, write a correct value again.
 - Copying a numeral memory table entry

If the display method or the number of registered words include discrepancies, a numeral memory table entry may not be copied and displayed correctly.

Application Example of Copying of a Character-String Memory Table Entry

This example gives a PLC program to switch the character-string display on the screen by using the memory table entry copy operation as the allocated bit is turned ON and OFF.

- Support tool settings

Allocate the memory as shown below by using the support tool.

PT status control area allocation: Word 0100

Contents registered to the screen: Character-string memory table entry No. 4

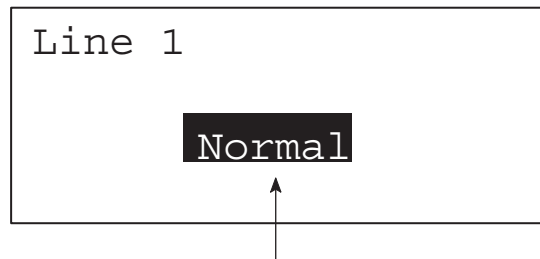

Character-string memory table entry 4

Character-string memory table entry settings

No.	Contents	Number of Character Digits
4	Normal	6 digits
10	Error	6 digits
11	Normal	6 digits

- PLC ladder program

Create a PLC ladder program as follows:

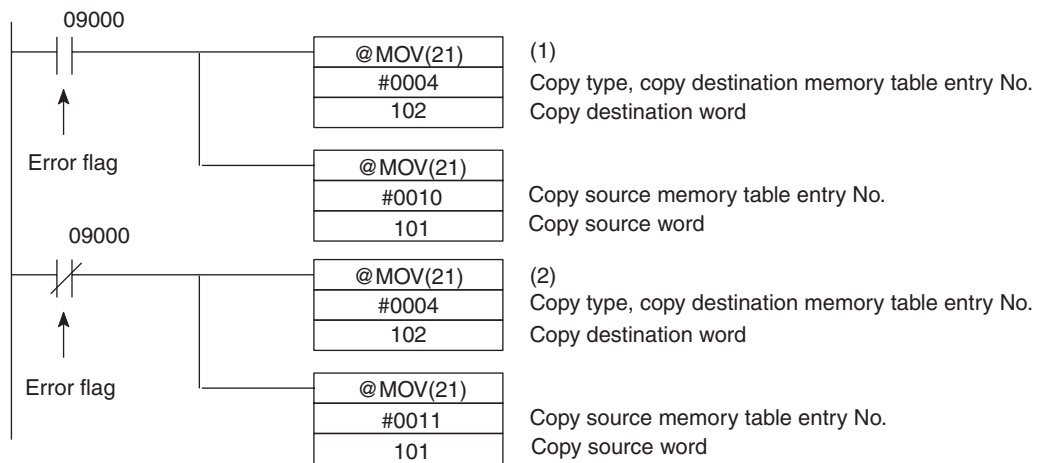

- Program operation

1. When an error occurs (bit 09000 turns ON), the NT11 displays the message "Error".
2. When the error is cleared (bit 09000 turns OFF), the NT11 display message reverts to "Normal".

5-3-4 Upgrading Bar Graphs (Changing the Contents of Allocated Words)

The following describes the procedure to upgrade the bar graph display on the NT11 by changing the contents of the allocated words.

To change the bar graph display on the NT11, change the contents of the PLC words to which the numeral memory table entries have been allocated.

- Available allocation words

The numeral memory table entries can be allocated to the following PLC areas:

Allocated Words

Either one or two words can be allocated at the host for each numeral memory entry. Words can be allocated in the following host (PLC) areas.

Symbol	C-series PLCs	Allocation	CV-series PLCs	Allocation	CS/CJ-series PLCs	Allocation
None	IR Area	OK	CIO Area	OK	CIO Area	OK
H	HR Area	OK	---	---	HR Area	Not for Host Link
A	AR Area	OK	Auxiliary Area	No	AR Area	OK
L	LR Area	OK	---	---	LR Area ^{*1}	Not for Host Link
T	TC Area, Timer PVs	1-word entries only	Timer Area, Timer PVs	1-word entries only	TC Area, Timer PVs	1-word entries only
TU	---	---	---	---	TC Area, Timer Completion Flags	No
C	TC Area, Counter PVs	1-word entries only	Counter Area, Counter PVs	Not for Host Link	TC Area, Counter PVs	1-word entries only
CU	---	---	---	---	TC Area, Counter Completion Flags	No
W	---	---	---	---	WR Area	Not for Host Link
TK	---	---	---	---	Task Flags	No
D	DM Area	OK	DM Area	OK	DM Area	OK
E	EM Area ^{*2} , current bank	OK	EM Area, current bank	Not for Host Link	EM Area, current bank	Not for Host Link
E0_ to EC_	---	---	---	---	EM Area, EM banks 0 to C	Not for Host Link

*1: LR 00000 to LR 00199 are converted to CIO 01000 to CIO 01199.

*2: The EM Area is supported only by the C200HX/HG/HE(-Z)E PLCs.

The range of respective area varies with the type of PLC. Refer to *Appendix H Special Characters* (page 163).

Reference

- The bar graph display cannot use hexadecimal numbers. If hexadecimal numbers are set, the bar graph will not be displayed.
By writing a negative number (whose most significant digit is “F”) to the allocated word of a graph set as “Sign display “No””, the graph display will become 0% and the % display will show “*** %”.
- For the procedure to write numeral values to the allocated words of the numeral memory table entries, refer to *5-3-1 Allocation Words and Display of Memory Table Entries* (page 117).

For the procedure to change the contents of the numeral memory table entry (PLC words), refer to 5-3-2 *Changing Displayed Numerals or Character Strings (Changing the Contents of Allocated Words....Direct Specification)* (page 120).

5-4 Numeral Setting

This section describes the method used to find the numeral input using the numeral setting function, when communicating with the PLC using the host link/NT link.

For details on the numeral setting function, refer to 4-6 *Numeral Setting* (page 97).

5-4-1 Notification of Numbers to the PLC

This section describes how the numerical data input at an NT11 is ascertained by the PLC.

In order to determine when numerical data has been input at the NT11, the numeral setting strobe flag in the PT status notify area is used. In order to determine the upgraded numeral memory table entry number, the “content upgrade memory table entry” in the PT status notify area is used.

When numerical data is input at the NT11, this is automatically notified to the PT status notify area (PT → PLC) allocated in the PLC memory as follows.

Notification of upgrade: PT status numeral setting strobe flag turned ON (1)

Upgraded numeral table entry number: Stored in the “content upgrade memory table entry”

When the PLC reads the “content upgrade memory table entry” at the leading edge of the numeral setting strobe flag, it determines the numeral memory table entry number in which the numerical data that was changed at the NT11 is stored.

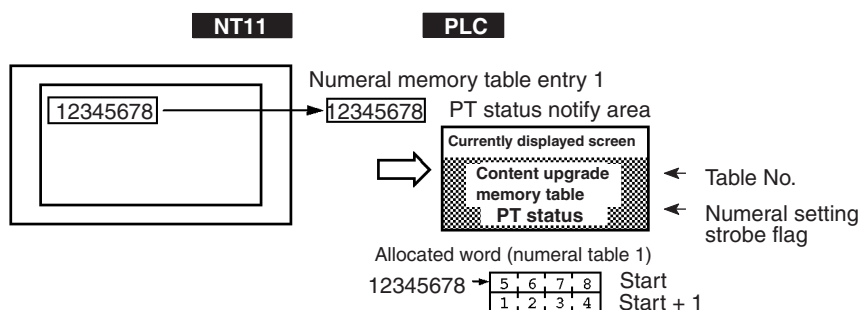

["Content upgrade memory table entry" in the PT status notify area and PT status]

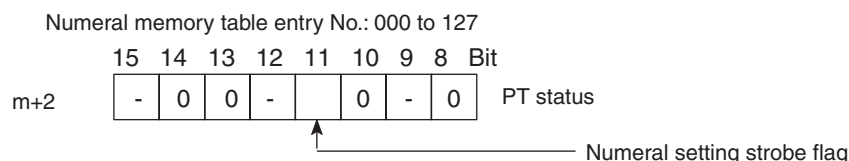
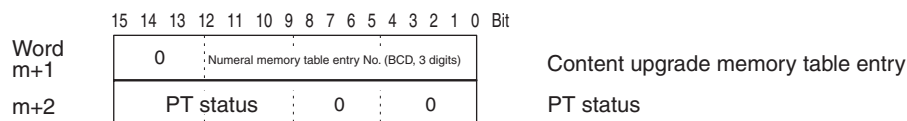

Data is written to the content upgrade memory table entry as three digits of BCD (binary coded decimal) data.

When the numeral setting strobe flag bit has been notified to the PLC it returns to the OFF (0) status.

For details on the method for storing a number in the word allocated for the numeral memory table entry, see “Allocation Words and Display of the Memory Table Entries” (page 4).

- Restrictions on allocating words

The PT status notify area can be allocated to the PLC memory areas listed in the following table.

Words Allocated of the PT Status Notify Area

Words can be allocated for the PT status notify area (PT → host) in the following host (PLC) areas.

Symbol	C-series PLCs	Allocation	CV-series PLCs	Allocation	CS/CJ-series PLCs	Allocation
None	IR Area	OK	CIO Area	OK	CIO Area	OK
H	HR Area	OK	---	---	HR Area	Not for Host Link
A	AR Area	OK	Auxiliary Area	No	AR Area	OK
L	LR Area	OK	---	---	LR Area *1	Not for Host Link
T	TC Area, Timer PVs	No	Timer Area, Timer PVs	No	TC Area, Timer PVs	No
TU	---	---	---	---	TC Area, Timer Completion Flags	No
C	TC Area, Counter PVs	No	Counter Area, Counter PVs	No	TC Area, Counter PVs	No
CU	---	---	---	---	TC Area, Counter Completion Flags	No
W	---	---	---	---	WR Area	Not for Host Link
TK	---	---	---	---	Task Flags	No
D	DM Area	OK	DM Area	OK	DM Area	OK
E	EM Area *2, current bank	OK	EM Area, current bank	Not for Host Link	EM Area, current bank	Not for Host Link
E0_ to EC_	---	---	---	---	EM Area, EM banks 0 to C	Not for Host Link

*1 LR 00000 to LR 00199 are converted to CIO 01000 to CIO 01199.

*2 The EM Area is supported only by the C200HX/HG/HE (-Z)E PLCs.

The range of each memory area differs according to *Appendix H Special Characters* (page 163) for more details.

Procedure

1. Use the support tool to allocate the PT status notify area (PT → PLC) to the PLC memory.
2. Using the support tool, create a numeral setting screen and allocate the numeral memory table entry to the PLC memory.
3. Create a PLC program for reading the “content upgrade memory table entry” in the PT status notify area when the numeral setting strobe flag in the PT status notify area comes ON (1).
4. Read the allocated word for the numeral memory table entry number read in step 3.

Application Example

This example shows the reading of the numeral memory table entry number after a value has been changed by inputting numerical data at the NT11.

• Setting at the support tool

Make the following settings using the support tool.

Allocated word for the PT status notify area: CIO/IR 0110

Numeral memory table entry No.3: DM 0005 (saved word: One)

Numeral memory table entry No.4: DM 0006 (saved word: One)

Data registered for the screens:

Numeral setting 1 ... Reference table entry “numeral memory table entry No. 3”

Numeral setting 2 ... Reference table entry “numeral memory table entry No. 4”

Numeral memory table entry number 3 (4-digit input)

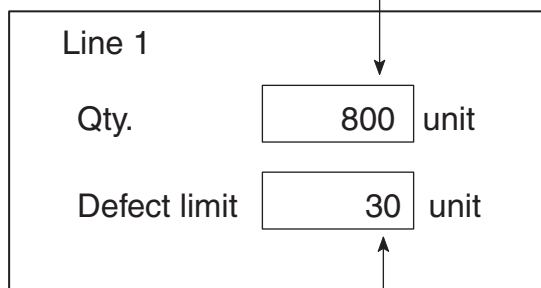

Numeral memory table entry number 4 (4-digit input)

• PLC program

Create the following PLC ladder program.

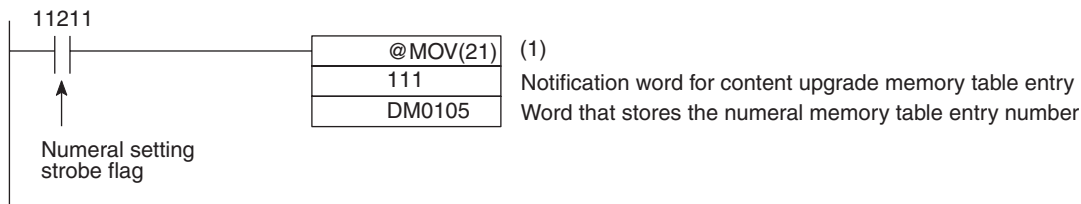

• Program operation

1. When the numeral setting strobe flag (bit 11211) comes ON (1), the contents of CIO/IR 0111 (the word where the content upgrade memory table entry is located) are transferred to DM 0105. The number of the numeral memory table entry that contains the upgraded data is stored in DM 0105 (in this case it is 003 or 004).

If the numeral memory table entry is allocated to a PLC word, the value input to it can be read easily by referring to the allocated word.

In this case, the contents of numeral memory table entry No. 3 are stored in DM 0005 and the contents of numeral memory table entry No. 4 are stored in DM 0006.

5-5 NT11 Status Control

The statuses of the NT11 can be controlled from the PLC by writing control data to the “PT status control bits” of the PT status control area allocated in the PLC memory.

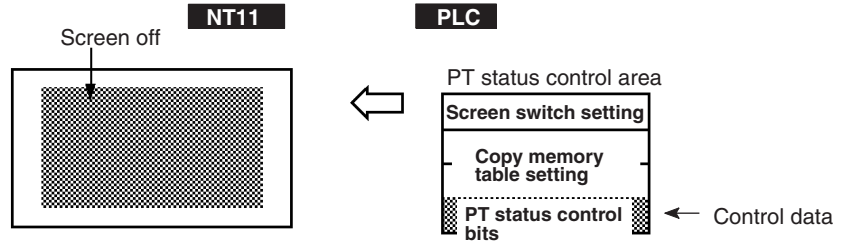

5-5-1 Controllable NT11 Functions

["PT status control bits" of the PT status control area]

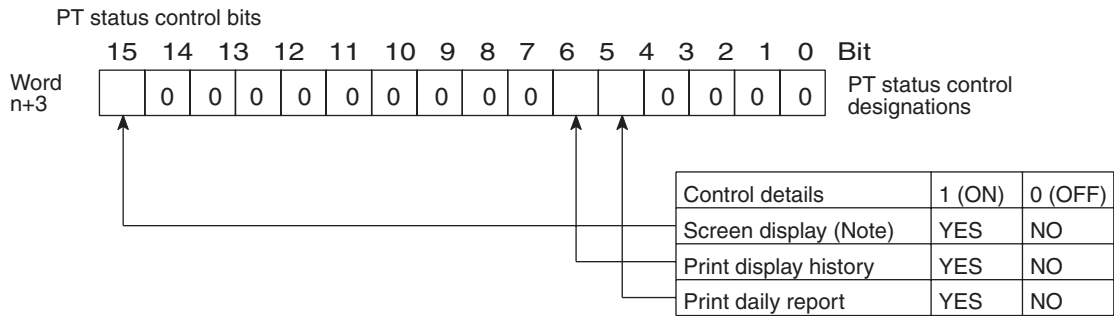

Note: When "screen display = yes" is set, the backlight is lit; when "screen display = no" is set, the backlight is off.

The NT11 functions that can be controlled from the PLC are listed below:

- Whether the screen is displayed or not
- Whether display histories are printed or not
- Whether daily reports are printed or not

Note Since the PT status control bits remain unaffected even if the NT11 status changes in accordance with the screen attribute and memory switch settings, it can happen that the status indicated by the PT status control bits does not agree with the actual status of the NT11. For example, the screen may be off although the screen display setting is “ON”. In situations like this, control the NT11 by using the PT status control bits.

- Screen display (bit 15)

The screen display bit determines whether the backlight is lit or unlit (whether the screen is displayed or not). It is used to prolong the service life of the backlight and prevent the formation of an afterimage. When bit 15 is set to OFF (0), the backlight is switched off.

Once the screen has been switched off, it can be switched back on either by switching bit 15 ON (setting it to “1”) or by pressing an NT11 key; this will cause the backlight to come back on.

Reference

1. Instead of switching bit 15 ON, a screen number can be specified to switch to that screen, in which case the screen will be displayed. For details on screen switching, refer to *5-2-2 Switching the Screen Display* (page 110).
2. By setting an NT11 memory switch, it is possible to make the backlight go off automatically after no operations have been performed for a set length of time.
 - Display history print (bit 5)
 "Display history printing" designates printing of the display history data recorded in the NT11 at a printer. When bit 5 is set ON (set to "1"), all the recorded display history data is printed out once. To print it out a second time, bit 5 must be switched OFF (set to "0") and then switched back ON (to "1").

Reference

For details on the data recorded in the display history and the printing format, refer to *4-10 Daily Report/Display History Printing Function* (page 102).

- Daily report print (bit 4)
 "Daily report print" designates printing of the contents of PLC words and set characters in accordance with a format set using the support tool.
 When bit 4 is switched ON (set to "1"), the contents of the specified words are read from the PLC and output to the printer once in the specified format.
 To output the data to the printer again, bit 4 must be switched OFF (set to "0") and then switched back ON (to "1").

Reference

Settings such as the printing format and word settings are made by using the support tool. For details on the support tool setting procedures relating to the daily report printing function, refer to *4-10 Daily Report/Display History Printing Function* (page 102).

5-5-2 How to Control NT11 Functions

This section describes how to control the functions of the NT11.

- Restrictions on allocating words
 The PT status control area (PLC → PT) can be allocated to the PLC memory areas listed in the following table.

Words Allocated for the PT Status Control Area

Words can be allocated for the PT status control area (host ↔ PT) in the following host (PLC) areas.

Symbol	C-series PLCs	Allocation	CV-series PLCs	Allocation	CS/CJ-series PLCs	Allocation
None	IR Area	OK	CIO Area	OK	CIO Area	OK
H	HR Area	OK	---	---	HR Area	Not for Host Link
A	AR Area	OK	Auxiliary Area	No	AR Area	OK
L	LR Area	OK	---	---	LR Area ^{*1}	Not for Host Link
T	TC Area, Timer PVs	No	Timer Area, Timer PVs	No	TC Area, Timer PVs	No
TU	---	---	---	---	TC area, Timer Completion Flags	No
C	TC Area, Counter PVs	No	Counter Area, Counter PVs	No	TC Area, Counter PVs	No

Symbol	C-series PLCs	Allocation	CV-series PLCs	Allocation	CS/CJ-series PLCs	Allocation
CU	---	---	---	---	TC Area, Counter Completion Flags	No
W	---	---	---	---	WR Area	Not for Host Link
TK	---	---	---	---	Task Flags	No
D	DM Area	OK	DM Area	OK	DM Area	OK
E	EM Area *2, current bank	OK	EM Area, current bank	Not for Host Link	EM Area, current bank	Not for Host Link
E0_ to EC_	---	---	---	---	EM Area, EM banks 0 to C	Not for Host Link

*1 LR 00000 to LR 00199 are converted to CIO 01000 to CIO 01199.

*2 The EM Area is supported only by the C200HX/HG/HE(-Z)E PLCs.

The range of each memory area differs according to the PLC type. *Appendix H Special Characters* (page 163) for more details.

Procedure

1. Use the support tool to allocate the PT status control area (PLC → PT) to the PLC memory.
2. Create a PLC program to write control data to the “PT status control bits” of the PT status control area.
 - Control timing of PT status control bits

The PT status control area (PLC → PT) is not read when the NT11 starts up. It is only read, and control is only executed, when the contents of the PT status control area are changed after the NT11 has been started up.

Since control of the NT11 statuses is executed after the bits corresponding to the PT status control bits have changed, to execute control again the corresponding bits must be specified again.

Example use of the PT status control bits

The example below shows how the PT status control bits are used to execute daily report printing.

- Setting at the support tool

Perform the following setting with the support tool.

PT status control area allocated word: CIO/IR 0118

- PLC program

Create the following PLC ladder program:

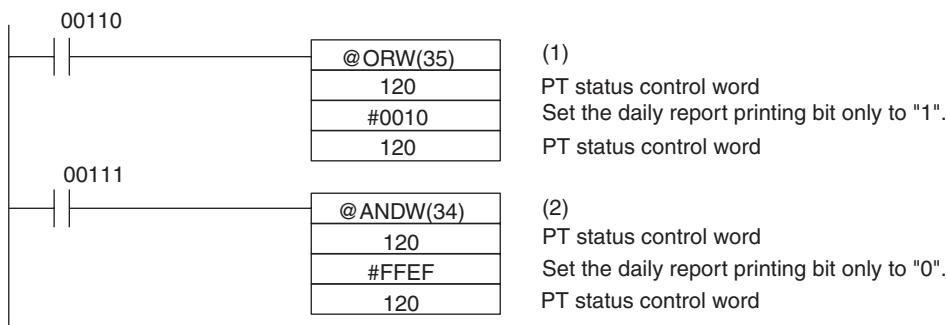

- Program operation

1. When CIO/IR 00110 comes ON, the daily report printing bit (bit 4) of the PT status control area is set to “1”. The status of bits other than bit 4 remains unchanged.
When bit 4 is set to “1”, the daily report is printed.

- When CIO/IR 00111 comes ON, the daily report printing bit (bit 4) of the PT status control area is set to "0". The status of bits other than bit 4 remains unchanged.

5-6 Notification of the Operating Status to the PLC (Determining the NT11 Operating Status)

The status (operating statuses, etc.) of the NT11 can be determined from the PLC by reading the "PT status" word in the PT status notify area allocated in the PLC memory.

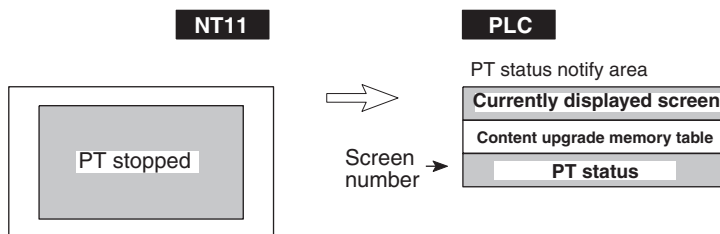

5-6-1 Ascertainable NT11 Statures (Notified Operating Statuses)

["PT status notification bits" of the PT status notify area]

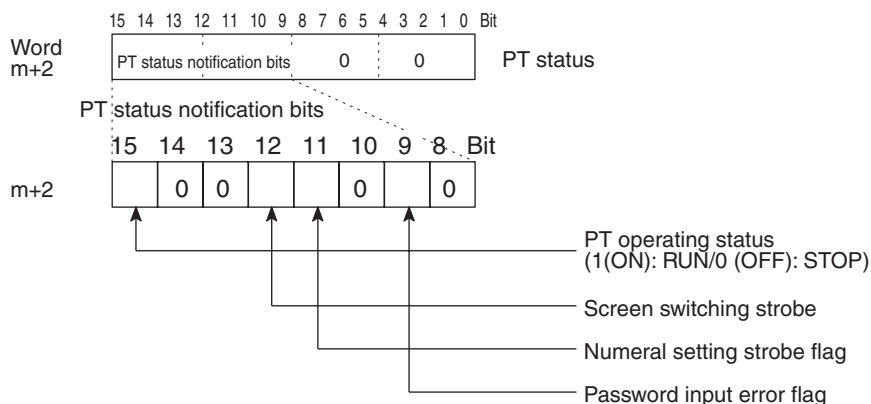

The following are the NT11 statuses that can be notified to the PLC:

RUN/STOP status of the NT11

Screen switching events

Numeral input events

Input of incorrect passwords

- PT operation status (bit 15)

When the NT11 is in the RUN mode this bit is ON ("1"). In other modes, and when the system menu is displayed, it is OFF ("0"). When it is OFF ("0"), the allocated bits and words cannot be read or written to.

- Screen switching strobe (bit 12)

When the screen displayed by the NT11 is switched by an instruction from the PLC, or by the standalone function, the screen switching strobe comes ON ("1"). On notification to the PLC, it goes OFF ("0").

- Numeral setting strobe flag (bit 11)

When a numerical value has been set in a numeral memory table entry using the numeral setting function of the NT11, the numeral setting strobe flag is ON ("1"). On notification to the PLC, it goes OFF ("0").

For details on how the numeral setting strobe flag is used, refer to “Notification of Numbers to the PLC”.

- Password input error flag (bit 9)

If a value that does not match the password registered in NT11 password setting is input in three successive attempts, the password input error flag comes ON (“1”). On notification to the PLC, it goes OFF (“0”).

For details on how the password input error flag is used, refer to *4-8 Password Screen Display Function* (page 100).

5-6-2 Reading the NT11 Operating Statuses

This section explains the actual procedures used to determine the NT11 statuses and operating statuses.

Note To ensure system safety, be sure to make a program which periodically reads the PT operating status bit in order to confirm that the PT is operating normally.

In order to ascertain the NT11 operating statuses, the PT status notification bits are used.

The NT11 automatically notifies information such as operating statuses to the PT status notification bits in the PT status notify area (PT → PLC) allocated in the PLC memory, as follows:

- Notification of operating mode: “PT operation status”
- Notification of screen switching: “Screen switching strobe”
- Notification of numerical value updates: “Numeral setting strobe flag”
- Notification of password input mistakes: “Password input error flag”

- Restrictions on allocating words

The PT status notify area (PT → PLC) can be allocated to the PLC memory areas listed in the following table.

Words Allocated of the PT Status Notify Area

Words can be allocated for the PT status notify area (PT → host) in the following host (PLC) areas.

Symbol	C-series PLCs	Allocation	CV-series PLCs	Allocation	CS/CJ-series PLCs	Allocation
None	IR Area	OK	CIO Area	OK	CIO Area	OK
H	HR Area	OK	---	---	HR Area	Not for Host Link
A	AR Area	OK	Auxiliary Area	No	AR Area	OK
L	LR Area	OK	---	---	LR Area*1	Not for Host Link
T	TC Area, Timer PVs	No	Timer Area, Timer PVs	No	TC Area, Timer PVs	No
TU	---	---	---	---	TC Area, Timer Completion Flags	No
C	TC Area, Counter PVs	No	Counter Area, Counter PVs	No	TC Area, Counter PVs	No
CU	---	---	---	---	TC Area, Counter Completion Flags	No
W	---	---	---	---	WR Area	Not for Host Link
TK	---	---	---	---	Task Flags	No
D	DM Area	OK	DM Area	OK	DM Area	OK

Symbol	C-series PLCs	Allocation	CV-series PLCs	Allocation	CS/CJ-series PLCs	Allocation
E	EM Area *2, current bank	OK	EM Area, current bank	Not for Host Link	EM Area, current bank	Not for Host Link
EO_ to EC_	---	---	---	---	EM Area, EM banks 0 to C	Not for Host Link

*1 LR 00000 to LR 00199 are converted to CIO 01000 to CIO 01199.

*2 The EM Area is supported only by the C200HX/HG/HE (-Z)E PLCs.

The range of each memory area differs according to the PLC type. *Appendix H Special Characters* (page 163) for more details.

Procedure

1. Use the support tool to allocate the PT status notify area (PT → PLC) to the PLC memory.
2. Write a PLC program to read the “PT status” word of the PT status notify area and check each bit status.
 - Report timing of PT status notification bits

The information in the PT status notify area (PT → PLC) is written to the PLC whenever there is a status change during operation of the NT11.

Example of use of the PT status notification bits

The example below shows how the PT status notification bits are used to check the NT11 status.

- Setting at the support tool

Perform the following setting with the support tool.

PT status notify area allocated word: CIO/IR 0110

PT error storage area allocated word: DM0001

- PLC program

Create the following PLC ladder program:

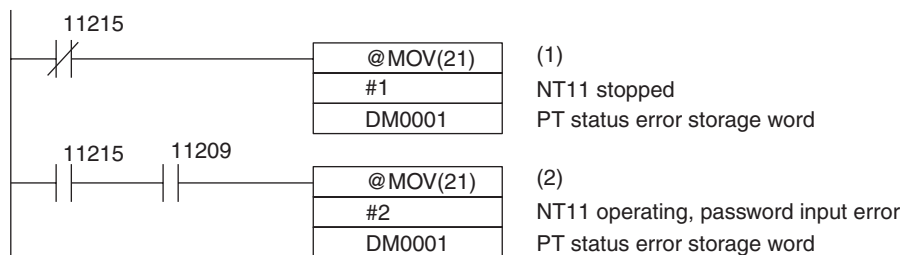

- Program operation

1. When “PT operating status” (CIO/IR 11215) goes OFF (“0”), “1” (NT11 stopped) is sent to DM0001.
2. If “password input error” (CIO/IR 11209) comes ON (“1”), while “PT operating status” (CIO/IR 11215) is ON (“1”), “2” (NT11 operating, password input error) is sent to DM0001.

SECTION 6

Troubleshooting and Maintenance

This section describes the action to take when NT11 errors occur, and how to carry out maintenance and inspections to prevent the occurrence of errors.

6-1	Troubleshooting	136
6-2	Responding to Displayed Error Messages	138
6-2-1	Errors Occurring at Start of Operation and Their Remedies	138
6-2-2	Errors Occurring during Operation and Their Remedies	139
6-2-3	Errors Occurring on Screen Data Initialization and Transmission	139
6-2-4	Errors in the System Installer Mode and Their Remedies	140
6-2-5	Communication Errors and Their Remedies	140
6-3	Inspection and Cleaning	142

6-1 Troubleshooting

When a fault relating to the operation of the NT11 occurs, find the symptoms in the table below and respond by following the corresponding *Remedy* indicated in the table.

- Note**
1. Confirm system safety before turning the power ON/OFF.
 2. Do not disassemble the PT for repair or modification. Otherwise the product may malfunction.

NT11 Symptoms	Cause	Remedy
Nothing is displayed on the screen.	Power is not being supplied.	Check the connections and make sure that power is supplied correctly. (2-2-2 Power Supply Connection, page 20)
	Power supply fuse has blown.	Contact your OMRON service center.
	Screen No. 0 has been read at the host side.	This is not an error. Change the screen number from screen number 0. (Setting the screen number to 0 turns the screen off.)
	The system startup waiting time has not elapsed yet.	This is not an error. The display will appear after the waiting time has elapsed.
Cannot communicate with the NT Support Tool.	The Transmit mode has not been established.	Display the System Menu and select the Transmit mode. (5-1 Screen Creation Procedure, page 108)
	Not connected to the NT Support Tool.	Check the installation of the connector cable. (2-3 Connecting to the NT Support Tool, page 22)
	The PT model setting and direct connection setting at the NT Support Tool do not match the NT11.	Using the PT Configuration settings of the NT Support Tool, set the PT model and direct connection settings that match the NT11.
Cannot communicate with the host. Cannot switch from the system initializing screen. Communication error message is displayed when communicating to the host.	Memory switch settings do not match.	Check the communication setting in the Memory Switch menu of the Maintenance mode, and match the communication protocol settings for the host and NT11. (3-7 Setting the Conditions of Communications with the PLC by Using the Memory Switches, page 71)
	NT11 and host are not correctly connected.	Check that the type, length, and installation of the connector cable match the specifications. (SECTION 2 Hardware Settings and Connections)
	An RS-422A/485 connection is being used and the terminator setting is incorrect.	Make the Link Adapter and PLC terminating resistance settings correctly. (SECTION 2 Hardware Settings and Connections)
	The power to the NT11, NT-AL001 or host is OFF.	Check the power supply.
The buzzer has sounded and the RUN Indicator is OFF.	Malfunction due to external noise	Carry out grounding work in accordance with the conditions by referring to 2-2-3 Wiring the Ground Wire, page 21.
	The NT11 has developed trouble.	Contact your OMRON service center.
The function key does not respond.	Malfunction due to external noise	Carry out grounding work in accordance with the conditions by referring to 2-2-3 Wiring the Ground Wire, page 21.
	The function key is broken.	Test the function key with I/O Check in the MAINTENANCE MODE menu. If there is an error, contact your OMRON service center.
The PLC mode has changed to the monitor mode.	The NT11 changes the mode when host link communication is used.	This is an NT11 specification. When using a PLC that can also be connected using the NT Link method, use an NT Link connection (there is no mode to change with the NT Link method).
The graph display does not update.	One of the percentage display settings — -100%, 0%, or 100% — is incorrect.	Set the -100%, 0%, and 100% values in the following relationship: -100% value < 0% value < 100% value

NT11 Symptoms	Cause	Remedy
The memory table display contents differ from the initial value set at the NT Support Tool.	Since the memory table entry is allocated to the host memory, the display is updated in accordance with the contents of the host memory.	When the contents of the memory table entry are set as a fixed values, do not allocate the memory table entry to the host memory.
Updating of numeric values and text is delayed.	Malfunction due to external noise	Carry out grounding work in accordance with the conditions by referring to <i>2-2-3 Wiring the Ground Wire</i> , page 21.
	There are too many numeral/text displays on the displayed screen.	Reduce the number of numeral/text displays on the screen for which updating is delayed.
	The cycle time is extended due to heavy processing at the host.	Shorten the host cycle time.
	In an RS-422A/485 connection, there is illegal branching or an erroneous terminator setting.	Wire correctly by referring to <i>SECTION 2 Hardware Settings and Connections</i> .
Some of the elements arranged on a normal screen are not displayed.	The quantity of read data exceeds the stipulated restriction.	Check the maximum number of elements. Create the screen data again and then transmit all of the screen data in a batch to the NT11.
	The total of the element coefficients for the displayed screen is greater than 1024.	
<p>The following System Menu operations are not possible.</p> <ul style="list-style-type: none"> - Establishing the Transmit mode - Displaying the memory switch setting screens - Screen data memory check - Displaying the initialization menu 	Screen Memory Protect has been set to Disabled because the PT power supply was turned OFF during deletion of screen data.	Do not turn the PT power OFF during deletion of screen data.
Cannot input numeric values.	The upper/lower (max./min.) limit check for numeric value input is in effect.	Check the screen data's upper/lower (max./min.) limit check setting for numeric value input, and correct it if necessary. Refer to <i>4-6 Numeral Setting</i> .
The display is dim.	The contrast setting is too low.	Increase the contrast with the contrast adjustment on the back of the NT11.
	Backlight defective, or its life has expired.	Contact your OMRON service center. (The backlight cannot be removed.)
The display is too faint.	The contrast setting is too high.	Reduce the contrast with the contrast adjustment on the back of the NT11.
The digits in numeral display come out as *.	The number of digits of a numeric value in a numeral memory table entry exceeds the set number.	<ul style="list-style-type: none"> • Confirm the values of the PLC words allocated to the numeral memory table entry. • Allocate one PLC word to each numeral memory table entry.

6-2 Responding to Displayed Error Messages

When the NT11 displays an error message, find the corresponding symptoms in the appropriate table below and respond by following the Remedy indicated in the table.

6-2-1 Errors Occurring at Start of Operation and Their Remedies

The table below shows the errors that can occur when the power to the NT11 is turned ON and when operation starts, and their remedies.

Message	Cause	Remedy
[No Comm. Protocol] Set the comm. Protocol by MAINTENANCE MODE.	No communication protocol has been set. Communication protocol and screen data type are mismatched	Using the memory switches, set the communication method to be used for communication with the host. (3-7 <i>Setting the Conditions of Communications with the PLC by Using the Memory Switches</i> , page 71)
[Screen Data Error] Screen Data corrupted. Initialize Screen Memory, and download Screen Data again.	- The power was switched OFF during screen data initialization, checking, or transmission. - Transmission of screen data was interrupted. - Illegal data has been written to the screen data memory.	Initialize the screen data memory by operation at the System Menu, then re-transmit the screen data. (3-4-1 <i>Initialization of the Screen Data</i> , page 64) If the problem persists, contact your OMRON service center.
[No Screen Data] No Screen Data is saved in Screen Memory. Download Screen Data using by the NT Support Tool.	No screen data is registered.	Transmit screen data from the NT Support Tool.
[No Direct Connection Info.] No Direct Connection Information is set in Screen Data. Set Direct Connecting Information in Screen Data using by the NT Support Tool. Then set the PT to the TRANSMIT MODE and download Screen Data again.	Allocated words have not been set for the PT Status Control Area and PT Status Notify Area.	Allocate words for the PT Status Control Area and PT Status Notify Area with the NT Support Tool and then transmit the direct connection information to the NT11.
[Incorrect Screen Data] Screen Data in Screen Memory do not match with the System Program. Initialize Screen Memory, and download Screen Data again.	The type of registered screen data does not match that at the NT11.	Initialize the screen data memory, then transmit the correct screen data. (3-4-1 <i>Initialization of the Screen Data</i> , page 64)
[No Starting Screen] Specified Starting Screen is not saved. Fix Screen Data using by the NT Support Tool. Then set the PT to the TRANSMIT MODE and download Screen Data again.	No data is registered for either the screen number set in the PT Status Control Area or the Initial Screen set with the NT Support Tool. Or screen numbers that do not exist are registered.	Either specify a screen number for which data is registered at the PT Status Control Area, or set the screen as the Initial Screen in the System settings under PT Configuration at the NT Support Tool.
[Memory Switch Corrupted] Because Memory Switch setting was lost. Initialized Memory Switch setting. Press Confirm to return to the SYSTEM MENU.	The memory switches have been initialized due to discovery of an error in the memory switch settings.	Set the memory switches again using the System Menu and the System settings under PT Configuration at the NT Support Tool. (SECTION 3 <i>System Menu Operation</i>) If the problem recurs, contact your OMRON service center.

6-2-2 Errors Occurring during Operation and Their Remedies

The table below shows the errors that can occur during operation of the NT11 and their remedies.

Message	Cause	Remedy
[Address Setting Error] Addressing Error exists in the Screen. Correct address setting by the NT Support Tool.	The host side allocated words and bits set with the NT Support Tool are incorrect.	Set correct words and bits after checking the area used at the host side by referring operation manual for the PLC being used.
[Memory Table No. Error] Memory table entry number is out of limit. Correct the table entry number by the NT Support Tool.	The memory table entry number set with the NT Support Tool is outside the range for the number of entries in the memory table set in the system memory.	Either increase the number of memory table entries in the System settings under PT Configuration at the NT Support Tool, or set the memory table entry number again within the established range. Then transmit all of the screen data in a batch to the NT11.

6-2-3 Errors Occurring on Screen Data Initialization and Transmission

The table below shows the errors that can occur when the NT11 data is initialized, and during data setting and transmission, and their remedies.

Message	Cause	Remedy
[Flash Memory Error] Flash Memory I/O Error. If this happens frequently, Flash Memory may be broken. Press Reset Switch to restart.	There is a hardware fault, or the flash memory (memory for storing screen data) has reached the end of its service life.	If the same message is displayed even after clearing the screen data or transmitting screen data several times, contact your OMRON service center.
[Tool Transmit Error] **** Error detected while downloading by the following case: • faulty connecting cable. • corrupted data by noise.	The connecting cable is defective.	Check the cable connection and perform a conductivity test. If there is a fault, replace the cable. (<i>Appendix D Making the Cable</i> , page 153)
	Malfunction due to external noise	Carry out grounding work in accordance with the conditions by referring to <i>2-2-3 Wiring the Ground Wire</i> , page 21.
[Tool Transmit Error] Check Sum Error occurs while downloading by the following case: • corrupted data by noise.	Malfunction due to external noise	Carry out grounding work in accordance with the conditions by referring to <i>2-2-3 Wiring the Ground Wire</i> , page 21.
[Tool Transmit Error] Time-out Error occurs while downloading by the following case: • faulty connecting cable.	The connecting cable is defective.	Check the cable connection and perform a conductivity test. If there is a fault, replace the cable.
[Tool Transmit Error] Reception was failed by Buffer Over Flow Error.	The receive buffer has overflowed.	Retransmit the data from the NT Support Tool.

6-2-4 Errors in the System Installer Mode and Their Remedies

This section describes the errors that may occur in the System Installer mode of the NT11, and the remedies for these errors.

Message	Cause	Remedy
System Program not exist or incorrect.	<ul style="list-style-type: none"> - The system program has not been installed. - The system program has been deleted due to a hardware fault, or because the flash memory (memory for storing the system program) has reached its life. 	Select Download System Program and download the system program (3-5 <i>Transferring the System Program</i> , page 66). If this does not solve the problem, contact your OMRON service center.
Unable to erase System Program.	Hardware fault, or flash memory (memory for storing the system program) has reached its life.	If the same message is displayed on repeating selection of Download System Program and attempting to delete the system program several times, contact your OMRON service center (3-5 <i>Transferring the System Program</i> , page 66).
Unable to download System Program.	<ul style="list-style-type: none"> - A communication error occurred during downloading of the system program. - Illegal data has been written into the screen data memory. - Hardware fault, or flash memory (memory for storing the system program) has reached its life. 	Select Download System Program and download the system program again (3-5 <i>Transferring the System Program</i> , page 66) and take the corrective action described for tool transmission errors. If this does not solve the problem, contact your OMRON service center.
Unable to write System Settings.	Hardware fault, or flash memory (memory for storing the system program) has reached its life.	If the same message is displayed on repeating writing of system settings several times, contact your OMRON service center. If writing is normally terminated after the error message was once displayed, the Memory Switch setting for system program may have been altered. In such a case, check and re-set the setting in the Memory Switch menu of the Maintenance mode.
Unable to erase Screen Data.	Hardware fault, or flash memory (memory for storing the system program) has reached its life.	If the same message is displayed on repeating screen data deletion several times, contact your OMRON service center.

6-2-5 Communication Errors and Their Remedies

This section describes the errors relating to communication that can occur during operation, and their remedies.

Operation When a Communication Error Occurs

When a communication error occurs, the error message is displayed at the NT11, and the buzzer sounds, provided the setting made for Buzzer Sound in the System Menu is other than OFF. An error message is displayed provided the setting for the Comm. Auto-Return memory switch is not ON (note that some error messages are displayed even if the setting is ON).

Operation When Communication Errors Occur

When an error message is displayed, press the OK touch switch displayed on the screen. The NT11 will return to the screen that was displayed before the error occurred, and operation will restart.

Display of Communication Errors

For communication errors, the name of the port at which the error occurred, the error classification (send or receive error), the details of the error, the probable cause, and the remedy, are displayed.

Receive Errors

The following errors can occur when receiving data.

- Parity error

- Framing error
- Overrun error
- FCS (sum value) error
- Time out error
- Data over flow error
- PLC unit number error (host link only)
- NAK received (in the case of the host link, the end code is also displayed)
- Undefined command error

Send Errors

The following errors can occur when receiving data.

- Time out error
- Data over flow error

Probable Causes and Remedies

The remedies to take in accordance with the displayed cause are indicated in the table below.

Error Details	Displayed Probable Cause	Remedy
Parity Error Framing Error Over-run Error	Communication parameters/ conditions set incorrectly.	Check if the settings at the host for parity bit, frame length, baud rate, stop bit length and flow control agree with those at the NT11.
	The connecting cables are not connected correctly.	Check the communication cable connection and perform a conductivity test. If there is a fault, replace the cable. For details on communication cables, refer to <i>SECTION 2 Hardware Settings and Connections</i> , and <i>2-5 Connection to a PLC by the Host Link (RS-422A Type)</i> .
	Noise caused data corruption during communication.	Carry out grounding work in accordance with the conditions by referring to <i>2-2-3 Wiring the Ground Wire</i> , page 21.
FCS (Check Sum) Error	Noise caused data corruption during communication.	Carry out grounding work in accordance with the conditions by referring to <i>2-2-3 Wiring the Ground Wire</i> , page 21.
	The PLC is transmitting incorrect data.	Check the operation at the host side.
Time-out Error	The connecting cables are not connected correctly. (Send/Receive)	Check the communication cable connection and perform a conductivity test. If there is a fault, replace the cable. For details on communication cables, refer to <i>SECTION 2 Hardware Settings and Connections</i> , and <i>2-5 Connection to a PLC by the Host Link (RS-422A Type)</i> .
	The communication service of the host is stopped. (Send/Receive)	Check that the host is capable of communicating with the NT11 (confirm that the communication settings of the host and NT11 match, and connection between the host and NT11 if flow control is set).
	Time-out Interval is too short. (Send)	Set a longer value for Time-out Interval at the host side.
NAK received	---	Check the settings for allocated words and bits. If noise is a possible factor, distance the cable from sources of noise and insert a noise filter in the power supply line. If using the equipment in a location subject to a lot of noise, use a cable with a high degree of protection against noise for the transmission route. Also make the cable as short as possible.
Undefined Command Error	The host is not supported.	Check the PLC model used for the host.
	Command level 3 is not effective.	Check that the command level setting for the host is level 1, 2, 3.

Error Details	Displayed Probable Cause	Remedy
Data Over Flow Error	Communication command from the host is too long. (With memory link)	Set flow control method in the host. Increase transmission interval.
	Command transmission to the host is not possible.	Check the communication cable. Check the control method at the PT and the host. Increase the baud rate if it is too slow.

6-3 Inspection and Cleaning

Clean and inspect the NT11 regularly to ensure that it is always used in its optimum condition.

Cleaning Method

If the display is dirty the screen is difficult to see. Clean the screen from time to time as follows.

- In daily cleaning, wipe the display with a soft dry cloth. If the soiling is particularly heavy, attempting to remove it by wiping with a dry cloth may damage the front sheet of the Unit. In this case, wipe with a damp cloth.
- If the soiling cannot be removed with a dry cloth, wet the cloth with diluted neutral detergent (2%), wring it out well and wipe the display with it.
- If rubber or vinyl products, tape, etc., are left stuck to the display for long periods they will cause staining. If such items are stuck to the display, remove them during cleaning.

Note Never use volatile solvents such as benzene or thinners, or chemical dusters. Otherwise the product may malfunction.

Inspection Method

In normal environments, inspect the NT11 at intervals of between 6 months and a year. In environments that are extremely hot and humid, or very dusty environments, shorten the inspection interval.

Items Required for the Inspection

Prepare the following items before starting the inspection.

- Screwdrivers (Phillips, flat head)
- Tester (or digital voltmeter)
- Industrial alcohol
- 100% cotton cloth
- Hygrometer (required in some cases)
- Thermometer (required in some cases)
- Synchroscope (required in some cases)
- Pen-writing oscilloscope (required in some cases)

Points inspected

Inspect the following points to determine if there is any divergence from the stated criteria. If there is, either improve the surrounding environment so that the values fall within the stated range, or adjust the NT11.

Point Inspected	Inspection Details	Criterion	Inspection Instrument
Power supply voltage	Fluctuation in power supply terminal voltage	Permissible voltage fluctuation range (24 VDC ±15%)	Tester

Point Inspected	Inspection Details	Criterion	Inspection Instrument
Ambient environmental conditions	Ambient temperature (temperature in the operation panel)	0 to 50°C	Thermometer
	Ambient humidity (humidity in the operation panel)	35% to 85%	Hygrometer
	Presence/absence of dust	Dust must not be settled	Visual inspection
Mounting conditions	Looseness of mounting brackets etc.	To be no looseness	Accessory tools
	Connector connections of connecting cable	To be fully inserted and locked, with no looseness	
	Looseness of screws in external wiring	To be no looseness	Phillips screwdriver
	Conditions of external connecting cables	Faults such as incipient disconnections.	Visual inspection
Components with limited lives	Brightness of the backlight	Must be sufficiently bright. Backlight life: 50,000 hours	Visual inspection

Cautions on replacing the NT11

When replacing the NT11 after discovering a fault during inspections, note the following points:

- Be sure to switch the power OFF before replacement.
- After replacement, check that the new NT11 is not subject to the same error.
- If a faulty unit is returned for repairs, write as detailed a description of the fault as possible and send this description together with the unit to the OMRON address indicated on the back cover of this book.

 **Caution** Do not disassemble for repairs or modification. Otherwise, the product may malfunction.

 **Caution** The disposal of the unit may be regulated by national or local authorities. Dispose of them in accordance with the laws and regulations of the relevant country and local authority.

Appendix A

Specifications

General Specifications

Item	Specification
Power supply voltage	24 VDC
Allowable power supply voltage range	20.4 to 27.6 VDC (24 VDC -15%, +15%)
Power consumption	10 W max.
Noise resistance	Conforms to IEC61000-4-4, 2K (power lines)
Vibration resistance	10 to 57 Hz with 0.075 mm amplitude and 57 to 150 Hz with 9.8 m/s ² acceleration for 30 min in each of X, Y, and Z directions
Shock resistance	147 m/s ² 3 times in each of X, Y, and Z directions
Ambient operating temperature	0 to +50°C
Ambient operating humidity	35 to 85% (with no condensation)
Operating environment	No corrosive gasses.
Storage temperature	-20 to +70°C (with no icing)
Enclosure ratings	Front panel: Equivalent to IP65, NEMA4
Weight	1.0 kg max.

Display/Panel Specifications

Note In order to improve the performance of displays, liquid crystal devices may be changed without notice.

Item	Specification
Display screen	Dot matrix of STN liquid crystal display panel • Number of dots: 160 × 64 • Effective display area: 100 × 40 mm • Life expectancy: 50,000 hours minimum • View angle (left/right direction): ±20° Backlight • LED • Life expectancy: 50,000 hours minimum • Automatic turn-off: can be set to turn off in 10 minutes or 1 hour, or to remain on.
Indicators	• POWER indicator (Green LED): Lit while power is being supplied. • RUN indicator (Green LED): Lit during operation
Switch	• 22 switches • Life expectancy: 1 million operations minimum

Display Capacity

Note In order to improve the performance of displays, liquid crystal devices may be changed without notice.

Item	Specification	
Display characters	Normal characters (8 × 16 dots): Alphanumerics and symbols Marks (8 × 16 dots): User-defined, 64 max.	
Number of characters displayed	Normal-size: 20 horizontally × 4 lines vertically max.	
Enlargement function	Double width	
Display elements	Character string displays	8 positions per screen
	Numeral displays	8 positions per screen
	Graph displays	4 positions per screen
	Numeral settings	8 positions per screen
Screen attributes	Display history	Order of frequency, 256 screens
	Password screen	Ensures security: screens for which this attribute is set can only be displayed if the correct password is input.
	Menu screen	Four items per screen
Screen types	Normal screen: Displays screen registered as normal.	
Max. number of registered screens	250	
Screen registration method	Transfer screen data created using an IBM PC/AT or compatible to the PT.	
Screen saving method	Saved to flash memory: 512 KB (downloading method)	

Special Features

Item	Specification
Printing function	Printing of display history data Printing of daily reports (printing format registered by the users)
Maintenance functions	<ul style="list-style-type: none"> • Self-test for memory, switches, etc. • Status setting confirmation for communications and other conditions. • Simple communications confirmation.

Product Configurations

Product		Specification	Model
Programmable Terminal*	Host link direct connection, NT link method	Ten-key type (frame color: beige)	NT11-SF121-EV1
		Ten-key type (frame color: black)	NT11-SF121B-EV1
Support Software		CD-ROM (for Windows 95, 98, Me, XP, NT, 2000)	NT-ZJCAT1-EV4
Function Key Sheets		10 sheets for replacement for beige	NT11-CKF01
		10 sheets for replacement for black	NT11-CKF01B

The PT body incorporated the communication interface, screen memory, and a flash ROM that downloads the system program.

Printer Port Specifications

[Printer Connector Pin Arrangement]

1	-STOROE
2	DATA 0
3	DATA 1
4	DATA 2
5	DATA 3
6	DATA 4
7	DATA 5
8	DATA 6
9	DATA 7
10	-ACK
11	BUSY
12	PAPER EMPTY
13	+SELECT

14	-AUTO FDXT
15	-ERROR
16	-INIT
17	-SLCTIN
18	GROUND
19	GROUND
20	GROUND
21	GROUND
22	GROUND
23	GROUND
24	GROUND
25	GROUND

[Signal Timing]

The NT11 executes communication with a 2-wire handshake system using the STROBE signal and the ACK signal.

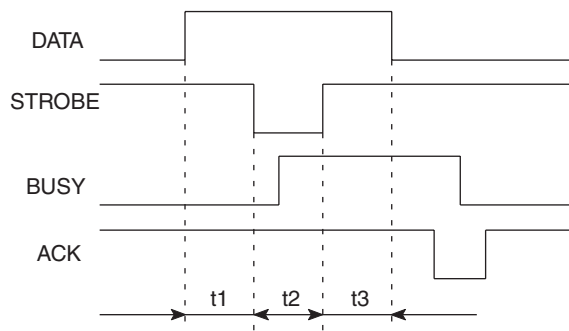

t1, t2 and t3 are each 0.5 μs or longer.

Appendix B

Dimensions

Body (NT11-SF121(B)-EV1)

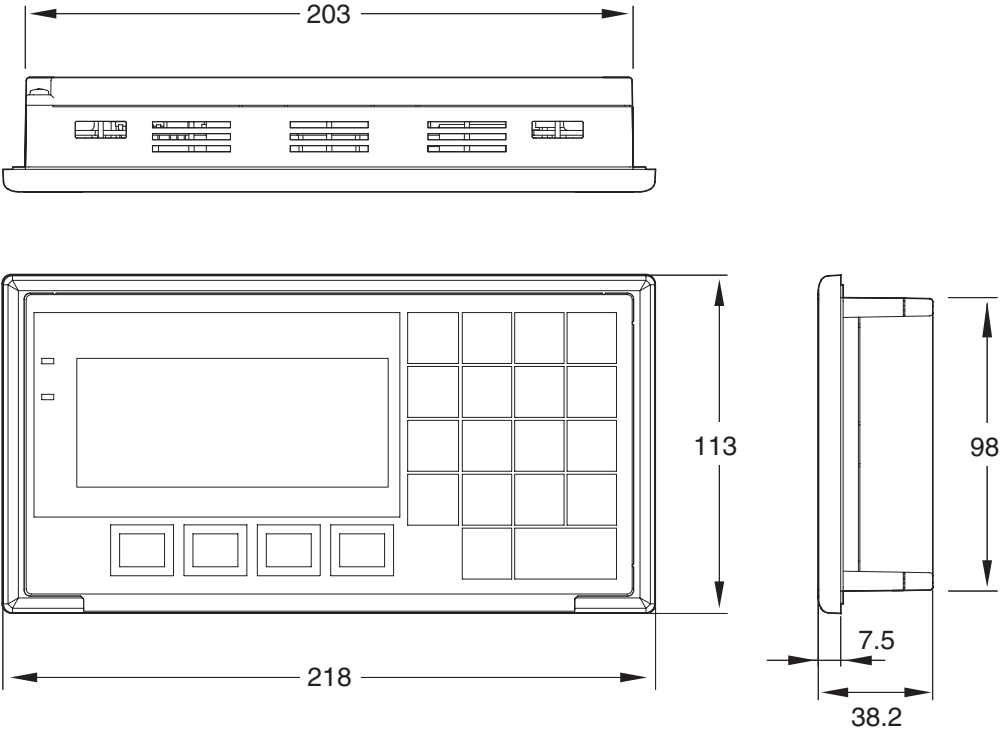

Appendix C

Transporting and Storing the NT11

- When transporting the NT11, use the packaging intended for it.
- When storing the NT11, observe the following conditions.

Storage ambient temperature: –20 to 70°C

Storage ambient humidity: 0 to 70°C: 85%

Appendix D

Making the Cable

The procedure for making up the cable is described below.

Also refer to this procedure for making a connecting cable for use with RS-422A/485 type connections.

Cable Preparation

The preparation of the cable differs according to whether or not the shielding wire is to be connected to the FG.

Cable with Shield Connected to FG

1. Cut the cable to the required length.
2. Remove the external vinyl insulation from the cable with a razor blade. Take care not to damage the shielding underneath.
3. Cut back the shielding wire with scissors.
4. Use wire strippers to strip the insulation from each wire.
5. Fold back the shielding wire.
6. Wrap aluminum foil tape around the folded-back shielding wire.

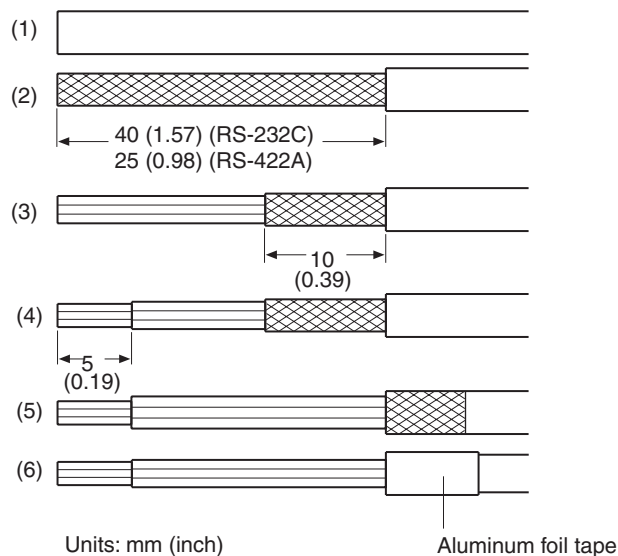

Cable with Shield Not Connected to FG

1. Cut the cable to the required length.
2. Remove the external vinyl insulation from the cable with a razor blade. Take care not to damage the shielding underneath.
3. Cut back the shielding wire with scissors.
4. Use wire strippers to strip the insulation from each wire.
5. Wrap vinyl tape over the cut off end of the shielding wire.

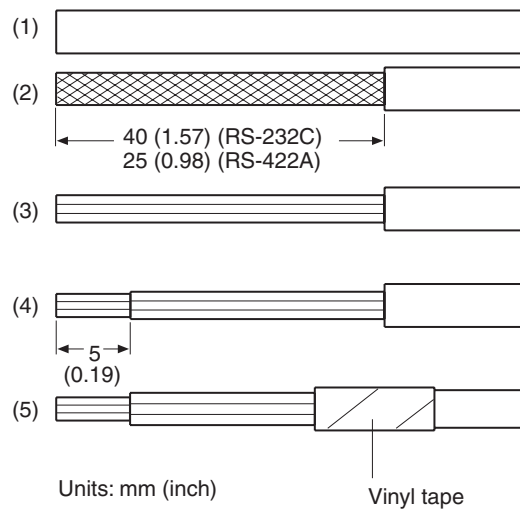

Soldering

1. Slide heat-shrink tube over each wire.
2. Pre-solder each wire and connector terminal.
3. Solder each wire to each connector terminal.

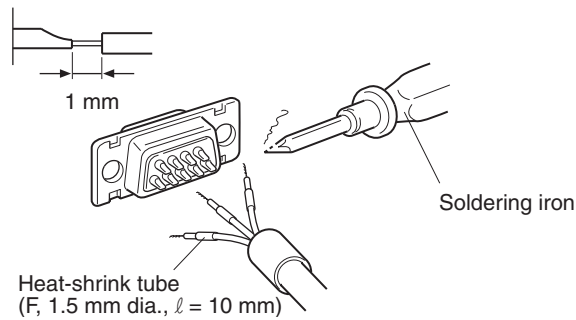

4. Push the heat shrink tube over the soldered joint and heat the tube to shrink it in place.

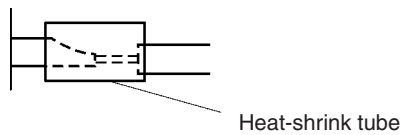

Hood Assembly

Assemble the connector hood as shown below.

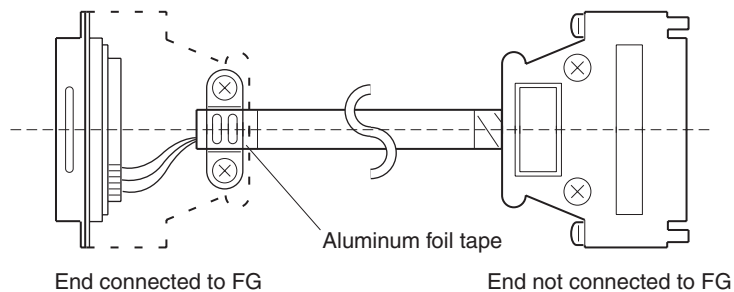

Appendix E

Making the Cable for Connecting a Personal Computer

Refer to the following when making a cable for connecting the NT Support Tool.

Assembly of Connecting Cables

Wiring should be carried out in one of the following ways, depending on the type of RS-232C connector.

25-pin Connector

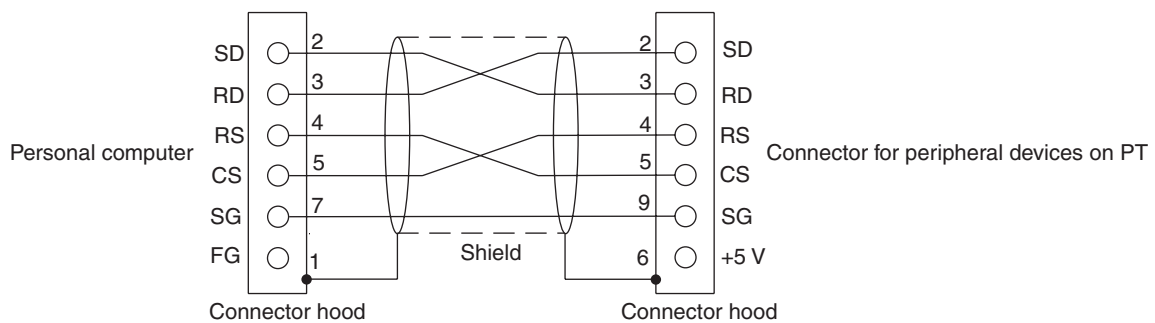

Use the following recommended products when making the connecting cable.

Name	Model	Remarks
Connector	XM2D-2501	25-pin, made by OMRON, for personal computer side
	XM2A-0901	9-pin, made by OMRON, for PT side
Connector hood	XM2S-2511	25-pin, made by OMRON, for personal computer side
	XM2S-0911	9-pin, made by OMRON, for PT side
Connector set	XM2S-0911-S003	9-pin, made by OMRON, for PT side Connector and Connector hood
Cable	AWG28×5P IFVV-SB	Multi-core shielded cable, made by Fujikura Ltd.
	CO-MA-VV-SB 5P×28AWG	Multi-core shielded cable, made by Hitachi Cable, Ltd.

9-pin Connector

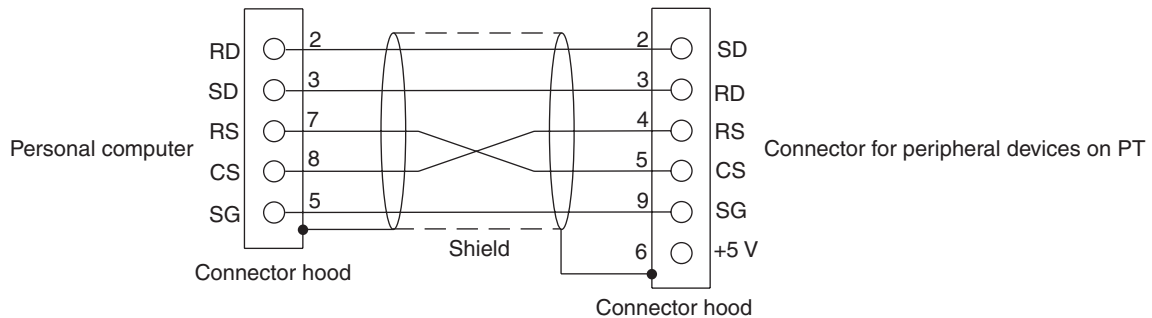

Use the following recommended products when making the connecting cable.

Name	Model	Remarks
Connector	XM2D-0901	9-pin, made by OMRON, for personal computer
	XM2A-0901	9-pin, made by OMRON, for PT
Connector hood (See note.)	XM2S-0911	9-pin, mm pitch screw, made by OMRON
	XM2S-0913	9-pin, inch pitch screw, made by OMRON
Connector set	XM2S-0911-S003	9-pin, made by OMRON, for PT side Connector and Connector hood
Cable	AWG28×5P IFVV-SB	Multi-core shielded cable, made by Fujikura Ltd.
	CO-MA-VV-SB 5P×28AWG	Multi-core shielded cable, made by Hitachi Cable, Ltd.

- Note**
- (1) One XM2S-0911 (for PT) and either one XM2S-0911 or -0913 (for your personal computer) are needed.
 - (2) Check that the current capacity of the equipment to be supplied is within 150 mA before using the +5 V output of pin No.6. Otherwise, the product may malfunction. The +5 V output of the unit delivers +5 V ±5% and 150 mA maximum.

Appendix F

NT11 Internal Processing

When host link/NT link is used, the following processing is executed inside the NT11. Processing is divided into two types: periodic processing and event processing.

Periodic Processing

When the NT11 is in the RUN mode it executes the following internal processing cyclically. The contents of all the allocated bits and words used for screen display are read from the PLC at one time, allowing high-speed processing.

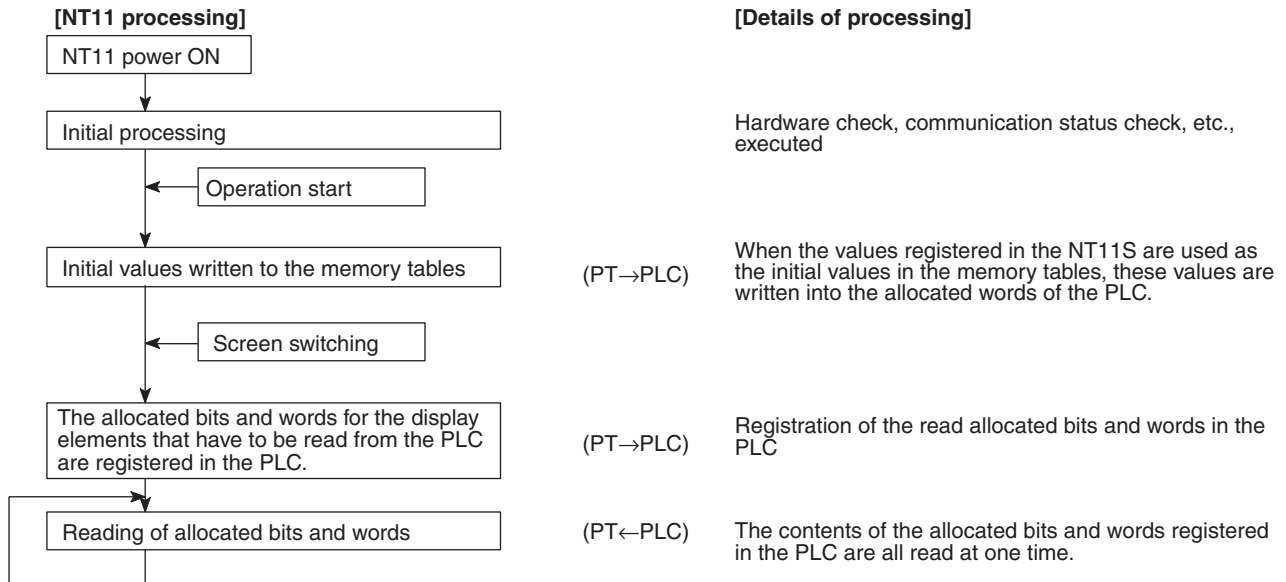

- Note**
- (1) Only the data of the PLC Status Control Area and data for currently displayed screens is read from the PLC.
Even if the contents of the PLC words allocated as memory table entry entries are changed, the data are not upgraded at the NT11 unless these memory table entries are used for screen displays.
 - (2) The maximum number of bits/words that can be read is 120 words per screen.
If the number that can be read is exceeded, the data are not upgraded.

Event Processing

When the status of the NT11 changes during operation, the processing for writing the changed data to the relevant area of the PLC memory is executed.

This kind of processing is only executed when statuses change. When changes occur simultaneously, the process is executed in accordance with the order of priority.

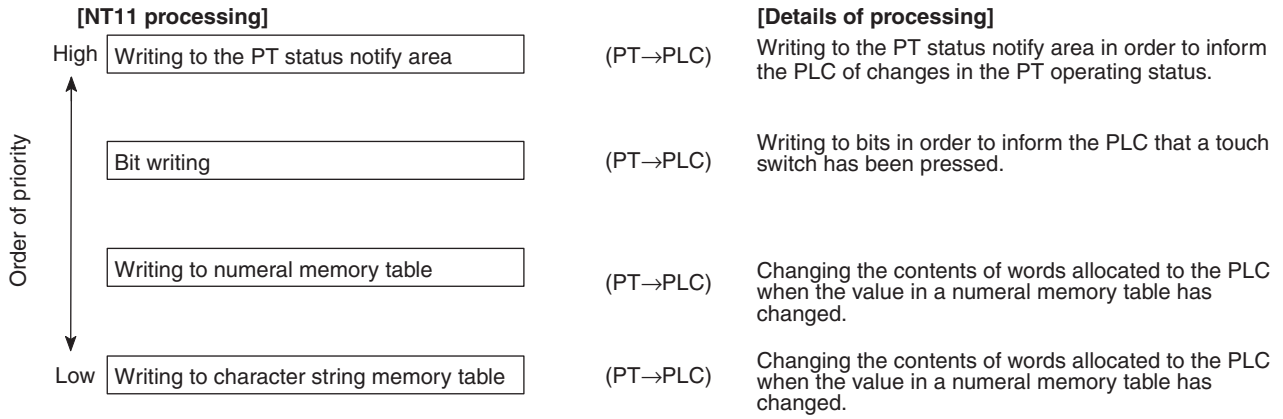

Note Data is only written to PLC bits and numeral/character string memory table entries for elements in screens currently being displayed. If the contents of numeral/character string memory table entries that are not being displayed change, the changed contents are not written to the PLC.

Appendix G

Model List

PTs

Model	Specification
NT11-SF121-EV1	Beige
NT11-SF121B-EV1	Black

Host Link Units

Model	Specification	Applicable PLC
C200H-LK201-V1	Rack-mounting Unit with RS-232C connector for C200H	C-series C200HS C200HX/HG/HE(-Z)E
C200H-LK202-V1	Rack-mounting Unit with RS-422A connector for C200H	
CV500-LK201	Features an RS-232C connector and a selectable RS-232C/ RS-422A connector Rack-mounting Unit for CVM1/CV	CVM1/CV-series CV500 CV1000 CV2000 CVM1

CompoBus/S Master Control Unit

Model	Specification	Model Name
SRM1-C02-V2	Features an RS-232C port	SRM1

Communications Unit

Model	Specification	Applicable PLC
CS1W-SCU21	RS-232C (2 ports) Rack-mounting Unit	CS-series CS1G/H, CS1G/H-H
CJ1W-SCU41	Features an RS-422A/485 port (port 1) and an RS-232C port (port 2).	CJ-series CJ1G

CPU Units for Connection via Host Link

Model	Specification	PLC Type
CPM1-10CDR-□ CPM1-20CDR-□ CPM1-30CDR-□ CPM1A-10CD□-□ CPM1A-20CD□-□ CPM1A-30CD□-□ CPM1A-40CD□-□	RS-232C adapter/RS-422A adapter connected to the peripheral port	C-series CPM1
CPM2A-30CD□□-□ CPM2A-40CD□□-□ CPM2A-60CD□□-□	Features a 9-pin connector for RS-232C connections	C-series CPM2A
CPM2C-10□□□□□□-□ CPM2C-20□□□□□□-□	The PLC's communications connector can be split into an RS-232C port and peripheral port with a CPM2C-CN111 Connecting Cable. (The CS1W-CN114/118 Connecting Cables convert the connector to a single RS-232C or peripheral port.)	C-series CPM2C

Model	Specification	PLC Type
CQM1-CPU21-E CQM1-CPU41-EV1 CQM1-CPU42-EV1 CQM1-CPU43-EV1 CQM1-CPU44-EV1 CQM1-CPU45-EV1	Features a 9-pin connector for RS-232C connections	C-series CQM1
CQM1H-CPU11 CQM1H-CPU21 CQM1H-CPU51 CQM1H-CPU61	Features a 9-pin connector for RS-232C connections (The CQM1H-CPU11-E has only a peripheral port.)	C-series CQM1H
C200HS-CPU21-E C200HS-CPU23-E C200HS-CPU31-E C200HS-CPU33-E	Features a connector for RS-232C connections (selectable/9-pin)	C-series C200HS
C200HE-CPU32-(Z)E ^(*) C200HE-CPU42-(Z)E	Features a connector for RS-232C connections (selectable/9-pin)	C-series C200HE(-Z)E
C200HG-CPU33-(Z)E ^(*) C200HG-CPU43-(Z)E C200HG-CPU53-(Z)E ^(*) C200HG-CPU63-(Z)E	Features a connector for RS-232C connections (selectable/9-pin)	C-series C200HG(-Z)E
C200HX-CPU34-(Z)E ^(*) C200HX-CPU44-(Z)E C200HX-CPU54-(Z)E ^(*) C200HX-CPU64-(Z)E C200HX-CPU65-ZE C200HX-CPU85-ZE	Features a connector for RS-232C connections (selectable/9-pin)	C-series C200HX(-Z)E
CS1G-CPU42-E(V1) CS1G-CPU43-E(V1) CS1G-CPU44-E(V1) CS1G-CPU45-E(V1)	Features a connector for RS-232C connections (9-pin)	CS-series CS1G
CS1H-CPU63-E(V1) CS1H-CPU64-E(V1) CS1H-CPU65-E(V1) CS1H-CPU66-E(V1) CS1H-CPU67-E(V1)	Features a connector for RS-232C connections (9-pin)	CS-series CS1H
CS1G-CPU42H CS1G-CPU43H CS1G-CPU44H CS1G-CPU45H	Features a connector for RS-232C connections (9-pin)	CS-series, high-speed CS1G-H
CS1H-CPU63H CS1H-CPU64H CS1H-CPU65H CS1H-CPU66H CS1H-CPU67H	Features a connector for RS-232C connections (9-pin)	CS-series, high-speed CS1H-H
CJ1G-CPU44 CJ1G-CPU45	Features a connector for RS-232C connections (9-pin)	CJ-series CJ1G
CVM1-CPU01-EV2 CVM1-CPU11-EV2 CVM1-CPU21-EV2	Features a connector for RS-232C connections (selectable/9-pin)	CVM1/CV-series CVM1

* One of the Serial Communications Boards C200HW-COM02/COM04/COM05/COM06-EV1 is required.

CPU Units for Connection via 1:1 NT Link

Model	Specification	PLC Type
CPM1-10CDR-□ CPM1-20CDR-□ CPM1-30CDR-□ CPM1A-10CD□-□ CPM1A-20CD□-□ CPM1A-30CD□-□ CPM1A-40CD□-□	RS-232C adapter connected to the peripheral port (RS-422A adapter cannot be used)	C-series CPM1
CPM2A-30CD□□-□ CPM2A-40CD□□-□ CPM2A-60CD□□-□	Features a 9-pin connector for RS-232C connections	C-series CPM2A
CPM2C-10□□□□□□-□ CPM2C-20□□□□□□-□	Connect to the RS-232C port of a CPM2C-CN111 Connecting Cable.	C-series CPM2C
CQM1-CPU41-EV1 CQM1-CPU42-EV1 CQM1-CPU43-EV1 CQM1-CPU44-EV1 CQM1-CPU45-EV1	Features a 9-pin connector for RS-232C connections	C-series CQM1
CQM1H-CPU21 CQM1H-CPU51 CQM1H-CPU61	Features a 9-pin connector for RS-232C connections	C-series CQM1H
C200HS-CPU21-E C200HS-CPU23-E C200HS-CPU31-E C200HS-CPU33-E	Features a connector for RS-232C connections (selectable/9-pin)	C-series C200HS
C200HE-CPU32-(Z)E ^(*) C200HE-CPU42-(Z)E	Features a connector for RS-232C connections (selectable/9-pin)	C-series C200HE(-Z)E
C200HG-CPU33-(Z)E ^(*) C200HG-CPU43-(Z)E C200HG-CPU53-(Z)E ^(*) C200HG-CPU63-(Z)E	Features a connector for RS-232C connections (selectable/9-pin)	C-series C200HG(-Z)E
C200HX-CPU34-(Z)E ^(*) C200HX-CPU44-(Z)E C200HX-CPU54-(Z)E ^(*) C200HX-CPU64-(Z)E C200HX-CPU65-ZE C200HX-CPU85-ZE	Features a connector for RS-232C connections (selectable/9-pin)	C-series C200HX(-Z)E
CVM1-CPU01-EV2 CVM1-CPU11-EV2 CVM1-CPU21-EV2	Features a connector for RS-232C connections (selectable/9-pin)	CVM1/CV-series CVM1

* One of the Serial Communications Boards C200HW-COM02/COM04/COM05/COM06-EV1 is required.

Use the following recommended products when making the connecting cable.

Name	Model	Remarks
Connector	XM2D-0901	9-pin, made by OMRON, for personal computer
	XM2A-0901	9-pin, made by OMRON, for PT
Connector hood*	XM2S-0911	9-pin, mm pitch screw, made by OMRON
	XM2S-0913	9-pin, inch pitch screw, made by OMRON
Connector set	XM2S-0911-S003	9-pin, made by OMRON, for PT side Connector and Connector hood
Cable	AWG28×5P IFVV-SB	Multi-core shielded cable, made by Fujikura Ltd.
	CO-MA-VV-SB 5P×28AWG	Multi-core shielded cable, made by Hitachi Cable, Ltd.

* One XM2S-0911 (for PT) and either one XM2S-0911 or -0913 (for your personal computer) are needed.

RS-232C Adapter and RS-422A Adapter

Model	Specification
CPM1-CIF01	Links the RS-232C port of an NT11 and the peripheral port of a CPM1, CPM2A, CPM2C, SRM1 (compatible with host link, and NT Link (1:1))
CPM1-CIF11	Links the RS-422A port of a Link Adapter and the peripheral port of a CPM1, CPM2A, CPM2C, SRM1 (compatible with host link)

Related Parts and Equipment for PT

Name	Model	Remark
NT Support Tool*	NT-ZJCAT1-EV4 (Ver. 4.7 or later)	Compatible with PC/AT or compatible personal computers For Windows 95, 98, NT, Me, 2000, or XP (English version) CD-ROM
Options	NT11-CKF01	10 key sheets for replacement, for NT11-SF121-EV1
	NT11-CKF01B	10 key sheets for replacement, for NT11-SF121B-EV1

* The system installer and the NT11 system program (Ver. 1) are included with the NT Support Tool.

Appendix H

Special Characters

English Character Codes

Pin 2 of SW2 must be ON to enable English language messages to use the following codes.

Example: Hex code is represented by 30, decimal code by 48, and character by 0.

30	0
48	

Code 20 and 32 in the table represents a space, as indicated by “SP”.

Hex Digits 1st → 2nd ↓	2-		3-		4-		5-		6-		7-		8-		9-	
-0	20	SP	30	0	40	@	50	P	60	'	70	p	80	Ç	90	É
	32		48		64		80		96		112		128		144	
-1	21	!	31	1	41	A	51	Q	61	a	71	q	81	ü	91	æ
	33		49		65		81		97		113		129		145	
-2	22	”	32	2	42	B	52	R	62	b	72	r	82	é	92	Æ
	34		50		66		82		98		114		130		146	
-3	23	#	33	3	43	C	53	S	63	c	73	s	83	â	93	ô
	35		51		67		83		99		115		131		147	
-4	24	\$	34	4	44	D	54	T	64	d	74	t	84	ä	94	ö
	36		52		68		84		100		116		132		148	
-5	25	%	35	5	45	E	55	U	65	e	75	u	85	à	95	ò
	37		53		69		85		101		117		133		149	
-6	26	&	36	6	46	F	56	V	66	f	76	v	86	å	96	û
	38		54		70		86		102		118		134		150	
-7	27	'	37	7	47	G	57	W	67	g	77	w	87	ç	97	ù
	39		55		71		87		103		119		135		151	
-8	28	(38	8	48	H	58	X	68	h	78	x	88	ê	98	ÿ
	40		56		72		88		104		120		136		152	
-9	29)	39	9	49	I	59	Y	69	i	79	y	89	ë	99	Ö
	41		57		73		89		105		121		137		153	
-A	2A	*	3A	:	4A	J	5A	Z	6A	j	7A	z	8A	è	9A	Ü
	42		58		74		90		106		122		138		154	
-B	2B	+	3B	;	4B	K	5B	[6B	k	7B	{	8B	ï	9B	ç
	43		59		75		91		107		123		139		155	
-C	2C	,	3C	<	4C	L	5C	\	6C	l	7C		8C	î	9C	£
	44		60		76		92		108		124		140		156	
-D	2D	-	3D	=	4D	M	5D]	6D	m	7D	}	8D	ì	9D	¥
	45		61		77		93		109		125		141		157	
-E	2E	.	3E	>	4E	N	5E	^	6E	n	7E	~	8E	Ä	9E	Pt
	46		62		78		94		110		126		142		158	
-F	2F	/	3F	?	4F	O	5F	_	6F	o	7F	△	8F	Å	9F	f
	47		63		79		95		111		127		143		159	

Hex Digits 1st → 2nd ↓	A-		B-		C-		D-		E-		F-	
-0	A0	á	B0	⋮	C0	└	D0	⊥	E0	α	F0	■
	160		176		192		208		224		240	
-1	A1	í	B1	■	C1	┘	D1	⊥	E1	β	F1	±
	161		177		193		209		225		241	
-2	A2	ó	B2	⋮	C2	┘	D2	⊥	E2	Γ	F2	≥
	162		178		194		210		226		242	
-3	A3	ú	B3		C3	┘	D3	⊥	E3	π	F3	≤
	163		179		195		211		227		243	
-4	A4	ñ	B4	┘	C4	—	D4	⊥	E4	Σ	F4	∫
	164		180		196		212		228		244	
-5	A5	Ñ	B5	⇒	C5	+	D5	⊥	E5	σ	F5	∫
	165		181		197		213		229		245	
-6	A6	a	B6	⇒	C6	⊥	D6	⊥	E6	μ	F6	÷
	166		182		198		214		230		246	
-7	A7	o	B7	⇒	C7	⊥	D7	⊥	E7	τ	F7	≈
	167		183		199		215		231		247	
-8	A8	¿	B8	⇒	C8	⊥	D8	⊥	E8	Φ	F8	°
	168		184		200		216		232		248	
-9	A9	┘	B9	⇒	C9	⊥	D9	┘	E9	Θ	F9	
	169		185		201		217		233		249	
-A	AA	┘	BA		CA	⊥	DA	┘	EA	Ω	FA	•
	170		186		202		218		234		250	
-B	AB	1/2	BB	⇒	CB	⊥	DB	■	EB	δ	FB	√
	171		187		203		219		235		251	
-C	AC	1/4	BC	┘	CC	⊥	DC	■	EC	∞	FC	n
	172		188		204		220		236		252	
-D	AD	i	BD	┘	CD	⊥	DD	■	ED	φ	FD	2
	173		189		205		221		237		253	
-E	AE	«	BE	┘	CE	⊥	DE	■	EE	ε	FE	*
	174		190		206		222		238		254	
-F	AF	»	BF	┘	CF	⊥	DF	■	EF	∩	FF	*
	175		191		207		223		239		255	

* Used as the prefix for mark data codes (2 bytes).

Index

A

arrow keys, 7
automatic restart, 75

B

backlight, 78
bar graphs, 6, 96, 115
 upgrading, 125
baud rate
 CPU Bus Units, 29
 CPU Units, 30, 35, 45, 47
 Programmable Controllers, 27, 42
Block Check Character, 42

C

cables, 40
 assembly, 155
 preparation, 153
characters, 6
 character codes, 163
cleaning, 142
communication port
 selecting, 76
Communications Units
 models, 159
CompoBus/S Master Control Units
 manual, 13
 models, 159
connections
 methods, 40
 NT11 to Programmable Controller, 54
 precautions, 24
 required parts, 40
 RS-422A, 40
Connector Cables, 24
connector hood, 40, 155, 156
 assembly, 154
connector set, 40, 155, 156
connectors, 155, 156
 25-pin, 155
CPU Bus Units
 settings, 29
CPU Units
 connections, 30, 45
 models

 host link, 159
 NT link, 161

crimp terminals, 40

D

daily report
 printing, 102
dimensions
 body, 149
DIP switches
 initializing, 65
 NT link, 53
 precautions, 18
 Programmable Controllers, 34
 Serial Communications Boards, 56
 settings, 18
 startup, 60
direct connection function, 9
display, 6
display history
 printing, 102, 104
display history screen function, 101
display screen
 notifying Programmable Controller, 112
 switching
 examples, 112
DM Area
 allocations, 30, 44, 49
 settings
 CPU Units, 37

E

error messages
 Address Setting Error, 139
 Flash Memory Error, 139
 Incorrect Screen Data, 138
 Memory Switch Corrupted, 138
 Memory Table No. Error, 139
 No Comm. Protocol, 138
 No Direct Connection Info., 138
 No Screen Data, 138
 No Starting Screen, 138
 Screen Data Error, 138
 Tool Transmit Error, 139
errors
 communication, 140
 during operation, 139

operation start, 138
screen data initialization/transmission, 139
System Installer mode, 140
event processing, 158

F

features, 4
Function Key Sheet, 147
function keys, 7
functional ground (FG) terminal, 21

H

history data
 selecting, 77
Host I/F Unit, 4
host link, 9
 baud rate, 74
 compatible Host Units, 38
 compatible Programmable Controllers, 38
 connecting to PLC, 22, 38
 data exchange, 89
 internal processing, 157
 operation overview, 109
 selecting, 73
Host Link Units
 connections, 28, 42, 43
 manual, 13
 models, 159
 wiring, 25

I

initializing
 using DIP switch, 65
 using System Menu, 64
inspection, 142
installation
 methods, 19
 precautions, 2, 19

K

key input check, 82

L

LCD check, 81
LED check, 80

M

maintenance, 80, 147
maintenance mode
 key operations, 63
marks, 6
memory switches, 60, 71
 auto-restart, 75
 history data, 77
memory tables, 115
 allocations, 117
 character-string, 94, 115
 changing, 120
 copying, 121
 example, 124
 displaying, 117
 numeral, 95, 116
 bar graphs, 96
 changing, 120
menu screen function, 99
messages, 3
models
 accessories, 162
 Communications Units, 159
 CompoBus/S Master Control Units, 159
 CPU Units
 host link, 159
 NT link, 161
 Programmable Terminals, 159
 RS-232C/RS-422A Adapters, 162

N

normal screens, 87
NT link, 9
 compatible Host Units, 50
 compatible Programmable Controllers, 50
 connecting to Programmable Controllers, 50, 55
 data exchange, 89
 internal processing, 157
 one-to-one, 50
 PLC Setup, 52
 operation overview, 109
 selecting, 73

NT Support Tool, 8
 cable connections, 155
 checking communications, 83
 connecting, 22
 manual, 13
 models, 162
 transmitting screen data, 70
NT11S, 6
numeral setting function, 97, 126
numeric keys, 7, 98
numeric values, 6

O

operating status
 notifying Programmable Controller, 132
 reading, 133
operation modes, 61

P

panel switch functions, 3
password screen display function, 100
periodic processing, 157
peripheral devices, 8
PLC Setup, 30, 32, 35, 52, 56
 CPU Units, 45, 47
power supply, 20
 precautions, 20
precautions
 cleaning, 2
 connections, 24
 DIP switch, 18
 general, xii
 installation, 2, 19
 operating, 2
 power supply, 20
 replacing NT11, 143
 safety, xii
 startup, 13
 storing, 151
 system keys, 7
 transporting, 151
printer
 connections, 57
printer port
 connector pin arrangement, 148
 signal timing, 148
printing, 147

 daily report, 102
 display history, 104
production line status, 2
Programmable Controllers, 23
 connections
 NT link, 55
 switch settings, 27, 42
Programmable Terminals, 147
 models, 159
Programming Tools
 manuals, 13
PT settings, 84
PT status control area, 11, 89, 91
 allocations, 111, 130
PT status control bits, 129
 application example, 131
PT status notification bits
 application example, 134
PT status notify area, 11, 90, 92
 allocations, 113, 133

R

receiving data, 3
RS-232C Adapters
 models, 162
 setting switches, 54
 switch settings, 35
RS-422A Adapters
 models, 162
 setting switches, 49
RUN mode, 78

S

safety precautions, xii
screen data
 creating, 60
 initializing, 64
 memory, 4
 registering, 69
 transferring, 60
screens, 3
 attributes, 88
 composition, 86
 creating, 108
 display, 86, 87
 switching, 110
 display history, 88

- management, 86
- menu screen, 88
- normal screens, 87
- numeral settings, 88
- password, 88
- system screen, 87
- sending data, 3
- Serial Communications Boards
 - connections, 37, 49
 - manuals, 13
 - setting switches, 48
- Serial Communications Units
 - connections, 44
- signal timing, 148
- specifications
 - connectors, 41
 - display/panel, 146
 - general, 145
 - printer port, 148
 - product configurations, 147
 - special features, 147
- startup, 60
 - procedure, 12
- status control, 129
- storing, 151
- Support Software, 147
- switch settings
 - Programmable Controllers, 27, 42
 - See also* DIP switches.
- system configuration, 8
- System Installer, 8
 - errors, 140
 - manual, 13
- system keys, 7
 - precautions, 7
- System Menu, 60, 61
 - displaying, 62
 - functions, 62
 - initializing, 64
- system program
 - erasing, 68
 - transfer ROM, 4
 - transferring, 60, 66, 67
- system screen, 87
- system settings
 - changing, 61
- system transfer tool, 67

T

- transporting, 151
- troubleshooting, 136

W

- wiring, 21
 - connectors, 41
 - Host Link Units, 25

Revision History

A manual revision code appears as a suffix to the catalog number on the front cover of the manual.

Cat. No. V084-E1-01



Revision code

The following table outlines the changes made to the manual during each revision. Page numbers refer to the previous version.

Revision code	Date	Revised content
01	January 2004	Original production

Revision History

OMRON CORPORATION

FA Systems Division H.Q.
66 Matsumoto
Mishima-city, Shizuoka 411-8511
Japan
Tel: (81)55-977-9181/Fax: (81)55-977-9045

Regional Headquarters

OMRON EUROPE B.V.

Wegalaan 67-69, NL-2132 JD Hoofddorp
The Netherlands
Tel: (31)2356-81-300/Fax: (31)2356-81-388

OMRON ELECTRONICS LLC

1 East Commerce Drive, Schaumburg, IL 60173
U.S.A.
Tel: (1)847-843-7900/Fax: (1)847-843-8568

OMRON ASIA PACIFIC PTE. LTD.

83 Clemenceau Avenue,
#11-01, UE Square,
Singapore 239920
Tel: (65)6835-3011/Fax: (65)6835-2711

OMRON

Authorized Distributor:

Cat. No. V084-E1-01

NT11 Programmable Terminal

USER'S MANUAL

OMRON