

Safety Light Curtain / Multi-Beam Safety Sensor

F3SN-A/F3SH-A

- Type 4 sensor complying with IEC and EN standards (IEC61496-1, -2, EN61496-1). Complies with EU machine directives (certified by BG/DEMKO).
- Detection height = Sensor length meets the user's requirements
- Detection height 189 to 1822 mm. Sensing distance 7 and 10 m.
- Various functions can be set by means of setting console.
- Equipped with a LED bar for easy adjustment of the optical axis and quick detection of failures.



Features

Select the optimum safety sensor for the application. Omron provides two safety types, the "Safety Light Curtain" and the "Multi-Beam Safety Sensor".

Finger protection

Safety light curtain

F3SN-A□□□□P14(H)

Sensing distance : 7 m

- Minimum detectable object: 14 mm dia. (9 mm optical axis pitch)
- Detection height: 189 to 1611 mm

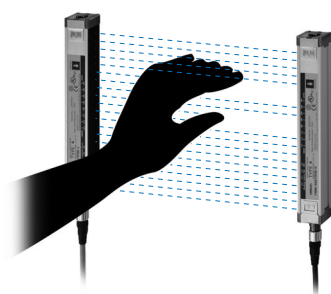

For presence inspection with a horizontal installation, types with minimum detectable object sizes of 40 mm (optical axis pitch: 30 mm) and 70 mm (optical axis pitch: 60 mm) can also be manufactured. (Please contact your OMRON Representative.)

Body protection

Multi-beam safety curtain

F3SH-A09P03

Sensing distance : 10 m

- Number of optical axes: 4 beams (300 mm optical axis pitch)

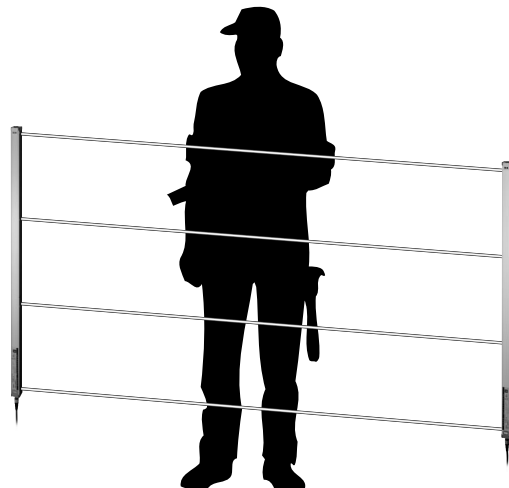

Hand protection

Safety light curtain

F3SN-A□□□□P25

Sensing distance : 10 m

- Minimum detectable object: 25 mm dia. (15 mm optical axis pitch)
- Detection height: 217 to 1822 mm

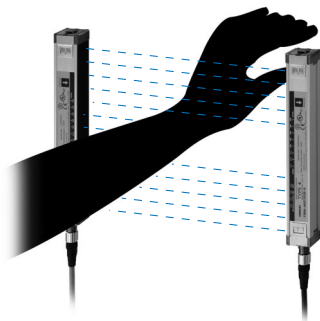

F3SN-A/F3SH-A

Features

A superior standard of safety design prevents machine accidents.

Wide-range implementation of fail-safe design.

Self-failure diagnosis triggers output shut off.

Safe design for F3SN-A

Emitter

- Light source breakage
- Light circuit breakage
- CPU runs out of control
- Cable disconnection or short-circuit

The sensor itself is always checking to the internal circuit of a floor sensor, or code disconnection and unusual ON light.

Even if a failure occurs, the same OFF signal as the normal break is output, and machine is stopped safely.

Receiver

- Power supply or circuit breakage
- Light receiving breakage
- Light receiving circuit breakage
- CPU runs out of control
- Incident external light interference
- Output drive circuit breakage
- Output circuit breakage
- Cable disconnection or short-circuit

In addition, an external relay monitor function is also equipped.

Technology-supported safety design

Safety is top priority based on the maximum standards of safety design and FMEA analysis.

Fail-safe design based on dual CPUs for mutual checking and duplex signal processing and output circuits. Relentless pursuit of safety based FMEA analysis * to prove safe operation.

* FMEA: Failure Mode and Effects Analysis

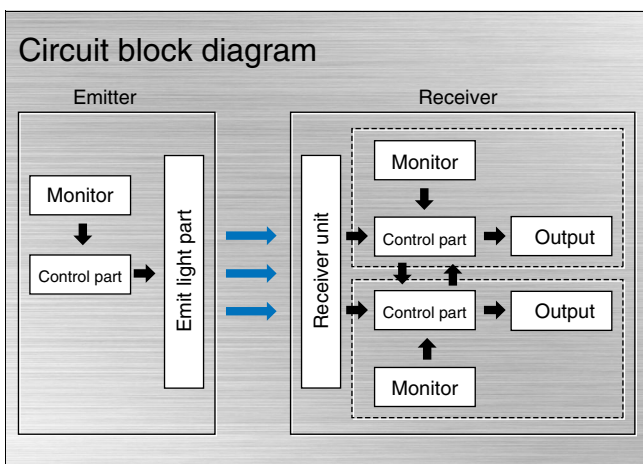

Meets global safety standards for safety sensors.

Type 4 sensors complying with IEC and EN standards

Complies with international standards IEC61496-1 and IEC61496-2, and EN standard EN61496-1, which are state-of-the-art "musts" for safety sensors.

Complies with EU directives

Certification of compliance with EC testing and EMC directives received from DEMKO and BG.

Received UL certification for models for the U.S. and Canada.

(Can be used in machines subject to OSHA rules and ANSI standards.)

Received UL listing and UL listing for Canadian safety standards based on UL508 and IEC61496-1/2. Can be used in machines subject to OSHA directives (29 CFR 1910.212), which are directives related to labor safety in the U.S. Meets also the requirements of ANSI/RIA R15.06-1999, a U.S. standard for industrial robots.



Features

We provide the perfect size for use in hazardous areas.

A new concept that perfectly fits the needs of the user.

The detection height equals to the sensor length.

Excess space has been minimized.

Up to 3 sets can be connected in series. Mutual interference can be prevented.

A standard type and a link-up type with a connector can be combined to connect up to 3 sets in series.

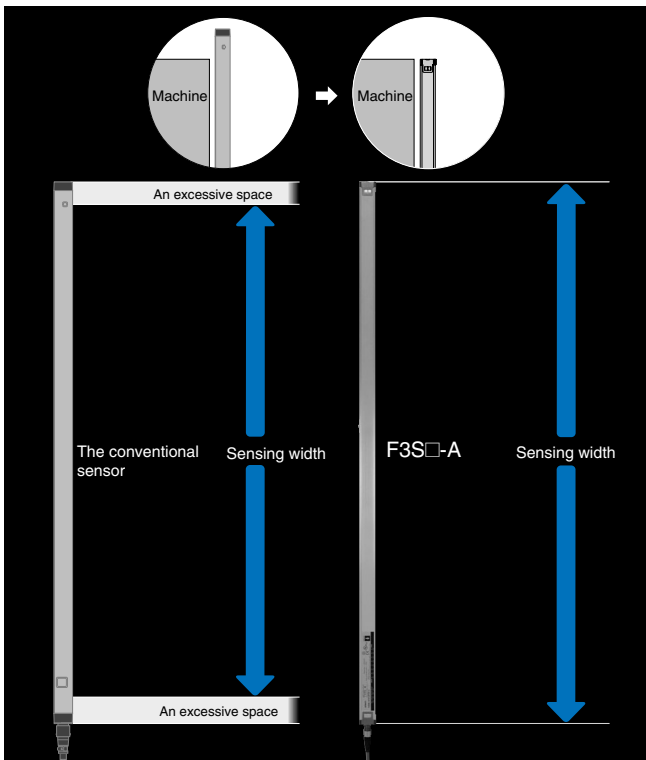

Note: When you order for a series connection type, please place an order with model-code F3SN-A□□□□P□□-01.

Select the optimum length

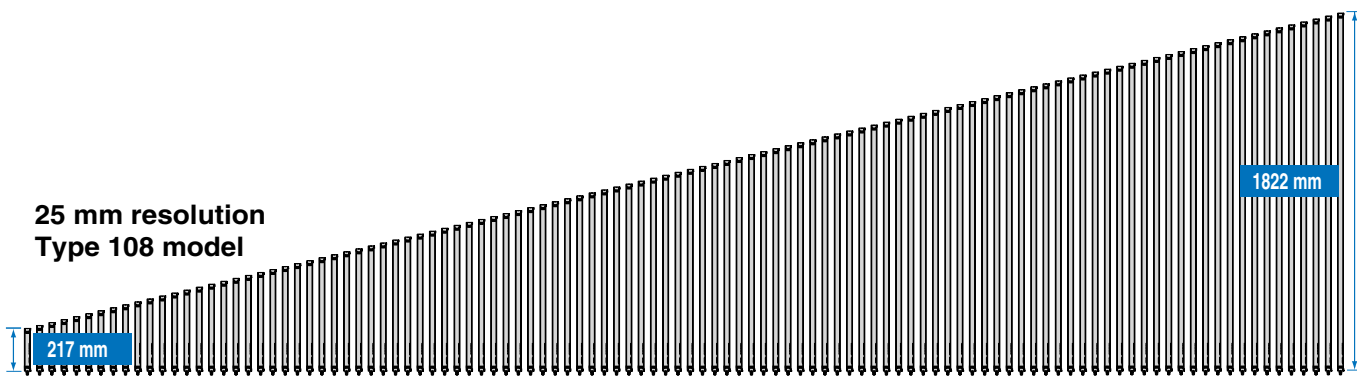

F3SN-A/F3SH-A

Features

The setting console--the first in the industry--allows you an easy and safe setting of various functions.

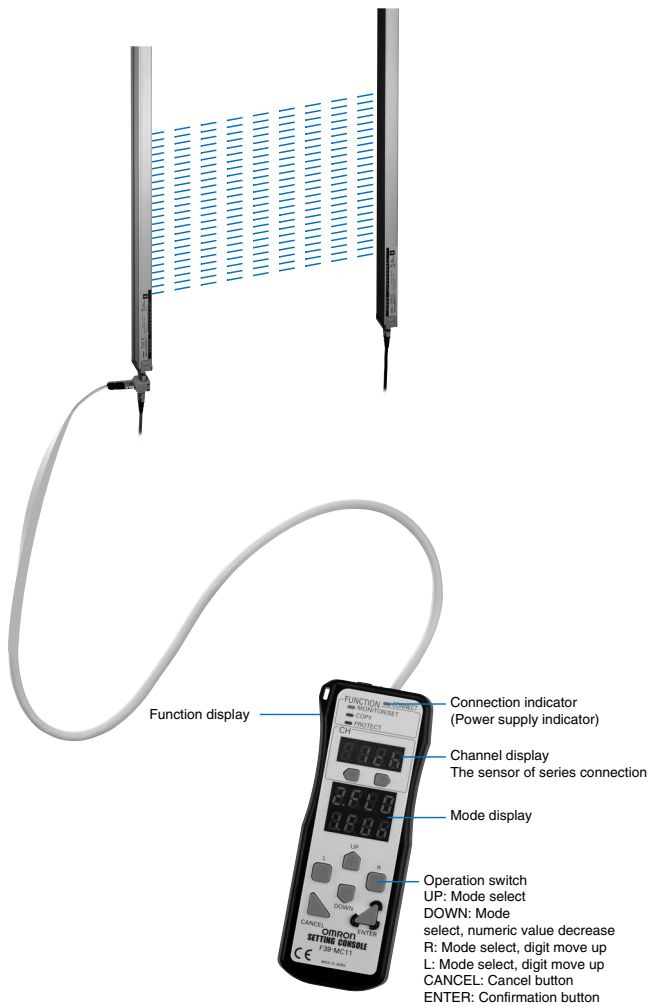

Includes two types of blanking functions

Blanking function for changing the detection pattern of the safety light curtain.

Basic pattern 1: Floating blanking function

This function allows you to disable an unspecified 1, 2, or 3 optical axes. If more than the set optical axes is interrupted, the output shuts off.

(Example of floating blanking function)

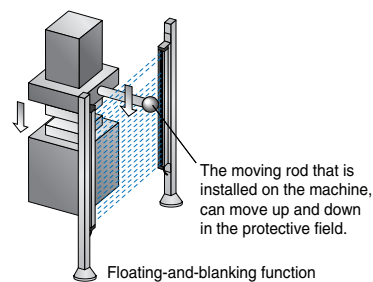

Basic pattern 2: Fixed blanking function

Specific optical axes are masked by teaching and disabled.

(Example of fixed blanking function)

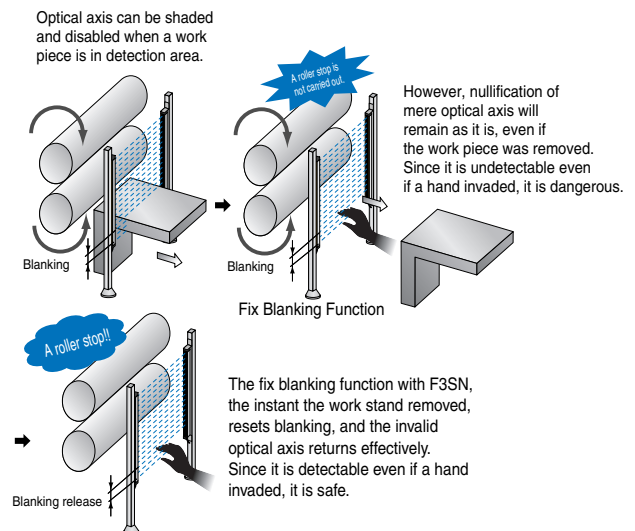

Other functions to be set with the setting console

- Auxiliary outputs: Outputs such as ON at Dark, ON at Light, light intensity diagnosis, and lockout can be selected.
- Large indicator lamp outputs: large indicator lamp outputs can be selected from ON at Dark, ON at Light, light intensity diagnosis, and lockout.
- External device monitoring function: Allows you to monitor the feedback of external devices.
- Interlock function: Interlocks can be set at power-on and restart.
- Setting copy function: Allows you to copy the settings of one sensor to another sensor.
- Protect function: Changing of sensor settings can be prohibited and restricted.

F3SH-A Multi-beam safety sensor

Recommended dimensions of EN standard for F3SH-A (4-optical axis multi-beam) Human body detection achieved 4 optical axes at a 300 mm pitch. Detects break by entire body.

In EN Standard EN999 (machine safety: positioning of protective devices in relation to the approach speed of human body parts), the values in the following table are recommended as the most effective regarding the height from the reference surface (floor, etc.) of each optical axis of the 4 optical axis multi-beam sensor.

The optical axis pitch of the F3SH-A matches the recommended pitch, and, thus, in the installation shown in the following diagram, every type of intrusion is detected, including intrusion by passing under the lowest optical axis and intrusion by passing over the highest optical axis.

(Installation example based on EN999 recommended dimensions for multi-beam safety sensors)

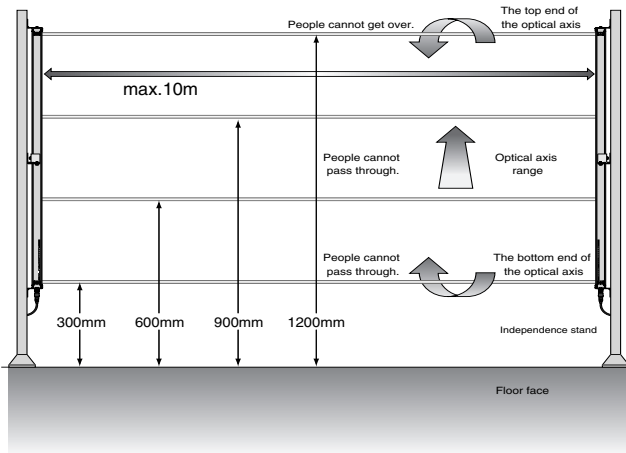

The number of optical axis	Height from datum plane (floor etc.) (mm)
4	300, 600, 900, 1200

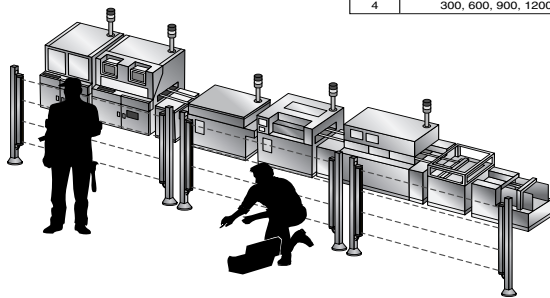

Easy safety application

Various safety functions are implemented. Can be adapted to various safety circuit system configurations.

- Interlock function
- Auto reset / manual reset can be selected
- External device monitoring function

Equipped with LED bar for easy use.

Easy optical axis adjustment using LED displays. Enables certain installation.

- Optical axis adjustment indicator (green only)

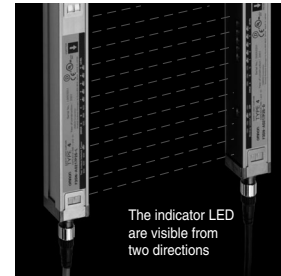
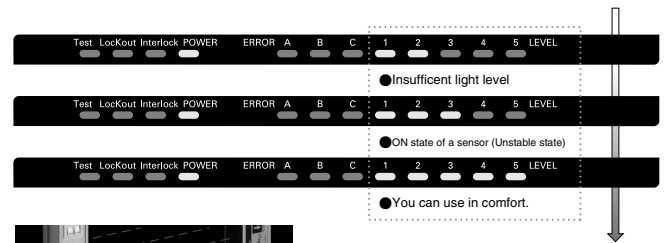

Error modes can be clearly indicated to provide a safety backup.

Error display example (red only)

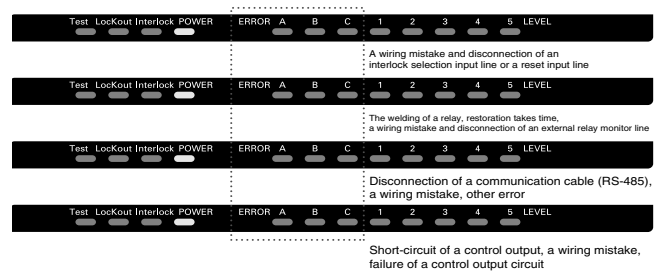

Full lineup of accessories (optional)

- Large-sized display indicator F39-A



When connecting, a series connection model (model end number -01) is required. The setting console can select the kind of signal.

- Reflecting mirror F39-MDG

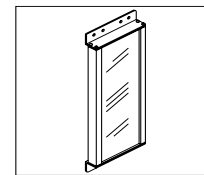

When the optical axis from an emitter is reflected at the angle of 90 degrees with using a mirror, the 2nd plane and the 3rd plane can be protected by one set of sensors. Sensing distance is lowered 15% per mirror.

- Spatter protection cover F39-HN

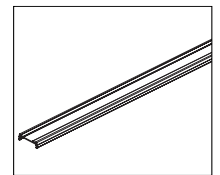





- Protective tube
- Slit cover
- Free location brackets
- Muting controller
- PSDI controller

Ordering information

Sensors

Safety light curtain

 Infrared ray



Minimum detection object	Optical axis pitch	Shape	Sensing distance		Number of optical axes	Detection width	Series connection, connector	Model*1
14 mm dia. (Finger protection)	9 mm			0.2 to 7m	21 to 179 (odd numbers only)	189 to 1,611 mm (18 mm each)	No	F3SN-A□□□□P14 F3SN-A□□□□P14H
							Yes	F3SN-A□□□□P14-01*2 F3SN-A□□□□P14H-01
25 mm dia. (Hand protection)	15 mm			0.2 to 10m	13 to 120	217 to 1,822 mm (25 mm each)	No	F3SN-A□□□□P25
							Yes	F3SN-A□□□□P25-01
40 mm dia. (for presence protection)	30 mm		0.2 to 10m	7 to 60	217 to 1,807 mm	No	F3SN-A□□□□P40	
						Yes	F3SN-A□□□□P40-01	
70 mm dia. (for presence detection)	60 mm		0.2 to 10m	5 to 30	277 to 1,777 mm	No	F3SN-A□□□□P70	
						Yes	F3SN-A□□□□P70-01	

*1. □□□□ in the model name indicates the detection width (mm).

*2. F3SN-A□□□□P14-01 is a customized model. For order placement, please contact your OMRON representative.

Multi-beam safety sensor

 Infrared ray

Optical axis pitch	Shape	Sensing distance		Number of optical axes	Distance between optical axes at each end	Series connection, connector	Model
Body protection			0.2 to 10m	4	900 mm	No	F3SH-A09P03
						Yes	F3SH-A09P03-01

Accessories (Order Separately)

Control Unit

Appearance	Output	Model	Remarks
	Relay, 3NO + 1NC	F3SP-B1P	For connection with the F3SN-A, and F3SH-A, use F39-JC□B cables fitted with connectors at both ends.

Safety Relay Unit

Appearance	Output	Model	Remarks
	Relay, 3NO	G9SA-300-SC	For connection with the F3SN-A, and F3SH-A, use F39-JC□C cables fitted with connectors at both ends.

Muting Controller

Appearance	Model	Remarks
	F3SP-U2P-TGR F3SP-U4P-TGR	For connection with the F3SN-A, and F3SH-A, use F39-JC□A cables fitted with connectors at single end.

Setting Console

Appearance	Model	Accessories
	F39-MC11	One branching connector, one connector cap, 2-m cable, instruction manual

Branching Connector

Appearance	Model	Remarks
	F39-CN1	Purchase this connector when needed additionally for installing the F39-MC11.

Single-ended Connector Cable (For Emitter and Receiver Set)

Appearance	Cable length	Specification	Model
	3 m	M 12 connector (8 pin)	F39-JC3A
	7 m		F39-JC7A
	10 m		F39-JC10A
	15 m		F39-JC15A

Double-ended Connector Cable (For Emitter and Receiver Set)

Appearance	Cable length	Specification	Model	Application	
	0.2 m	M12 connector (8 pins)	F39-JCR2B	Series connection or connection with F3SP-B1P	
	0.5 m		F39-JCR5B		
	3 m		F39-JC3B		
	5 m		F39-JC5B		
	7 m		F39-JC7B		
	10 m		F39-JC10B		
	15 m	F39-JC15B	Connection with F3SP-B1P (see note 1)		
	20 m	F39-JC20B			
	0.2 m	M12 connector (8 pins)		F39-JCR2C	Connection with G9SA-300-SC (see notes 1 and 2)
	1 m			F39-JC1C	
	3 m			F39-JC3C	
	7 m			F39-JC7C	
	10 m			F39-JC10C	
	15 m			F39-JC15C	

- Note: 1. Cannot be used for series-connection purpose.
 2. When two or more cables have to be used for connection with the G9SA-300-SC, connect the necessary number of F39-JC□B cables to one F39-JC□C cable.
 (Example) When a 35 m long cable is required, connect two F39-JC□B cables to one F39-JC□C.

F3SN-A/F3SH-A

External Indicators (Separate Models for Emitters and Receivers)

Appearance	Specification	Indicator	Type	Model
	M12 connector for PNP output	Red	Emitter	F39-A01PR-L
			Receiver	F39-A01PR-D
		Green	Emitter	F39-A01PG-L
			Receiver	F39-A01PG-D

Note: These indicators are used for connecting with series-connection type emitters/receivers (models ending in -01). The desired turn-ON timing (type of signal) can be selected on setting console.

Spatter protection covers (1 set of 2 covers for both Emitter and receiver)

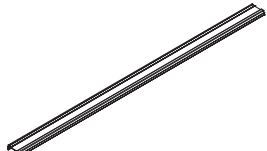
Shape	Applicable models	Model
	F3SN-A□□□□P14	F39-HN□□□□-14
	F3SN-A□□□□P25 F3SN-A□□□□P25-01	F39-HN□□□□-25
	F3SH-A09P03	F39-HH09-03

Note: □□□□ in the model name indicates the 4-digit sensor detection width (in sensor models).

Reflection mirror (15% sensing distance attenuation)

Mirror material	Width (mm)	Thickness (mm)	Length (mm)	Model
Glass mirror	125	31	310	F39-MDG0310
			460	F39-MDG0460
			607	F39-MDG0607
			750	F39-MDG0750
			907	F39-MDG0907
			1,057	F39-MDG1057
			1,207	F39-MDG1207
			1,357	F39-MDG1357
			1,500	F39-MDG1500
			1,657	F39-MDG1657

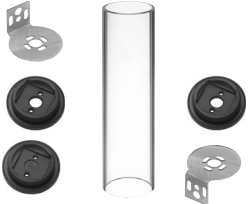

Note: Other sizes are available upon request

IP67 environment-resistant Enclosure (A Package of tube, Gasket, and Bracket; see note)

Appearance	Applicable sensor	Model
	F3SN-A□□□□P14(-01)	F39-HP□□□□-14
	F3SN-A□□□□P25(-01) F3SN-A□□□□P40(-01) F3SN-A□□□□P70(-01)	F39-HP□□□□-25
	F3SH-A09P03(-01)	F39-HPH09-03

Note: Purchase 2 sets when using both an emitter and a receiver.

Mounting Bracket for Sensor (Optional)

Appearance	Specification	Model	Remarks
	Wall mounting bracket Material: Iron (zinc plating) (see note)	F39-L18	For emitter: 2 pcs. For receiver: 2 pcs. Total: 4pcs./set
	Free-location bracket Materials: Zinc die-cast (zinc plating) Note: Not provided with an angle deflection mechanism for beam control.	F39-L19	Minimum order quantity: 1 pc.
	Free-location bracket Materials Sensor fixing element: Zinc die-cast (zinc plating) Mounting bracket: Iron (zinc plating) Note: Provided with an angle deflection mechanism for beam control	F39-L20	Minimum order quantity: 1 pc.

Note: Use these brackets for sensors having an operating range where no intermediate bracket is required (with an operating range of less than 640 mm)

List of Safety Light Curtains

F3SN-A□□□□P14, F3SN-A□□□□P14-01, F3SN-A□□□□P14H-01

Model	Detection height	Number of optical axes
F3SN-A0189P14 (-01)	189	21
F3SN-A0207P14 (-01)	207	23
F3SN-A0225P14 (-01)	225	25
F3SN-A0243P14 (-01)	243	27
F3SN-A0261P14 (-01)	261	29
F3SN-A0279P14 (-01)	279	31
F3SN-A0297P14 (-01)	297	33
F3SN-A0315P14 (-01)	315	35
F3SN-A0333P14 (-01)	333	37
F3SN-A0351P14 (-01)	351	39
F3SN-A0369P14 (-01)	369	41
F3SN-A0387P14 (-01)	387	43
F3SN-A0405P14 (-01)	405	45
F3SN-A0423P14 (-01)	423	47
F3SN-A0441P14 (-01)	441	49
F3SN-A0459P14 (-01)	459	51
F3SN-A0477P14 (-01)	477	53
F3SN-A0495P14 (-01)	495	55
F3SN-A0513P14 (-01)	513	57
F3SN-A0531P14 (-01)	531	59
F3SN-A0549P14 (-01)	549	61
F3SN-A0567P14 (-01)	567	63
F3SN-A0585P14 (-01)	585	65
F3SN-A0603P14 (-01)	603	67
F3SN-A0621P14 (-01)	621	69
F3SN-A0639P14 (-01)	639	71
F3SN-A0657P14 (-01)	657	73

Model	Detection height	Number of optical axes
F3SN-A0675P14 (-01)	675	75
F3SN-A0693P14 (-01)	693	77
F3SN-A0711P14 (-01)	711	79
F3SN-A0729P14 (-01)	729	81
F3SN-A0747P14 (-01)	747	83
F3SN-A0765P14 (-01)	765	85
F3SN-A0783P14 (-01)	783	87
F3SN-A0801P14 (-01)	801	89
F3SN-A0819P14 (-01)	819	91
F3SN-A0837P14 (-01)	837	93
F3SN-A0855P14 (-01)	855	95
F3SN-A0873P14 (-01)	873	97
F3SN-A0891P14 (-01)	891	99
F3SN-A0909P14 (-01)	909	101
F3SN-A0927P14 (-01)	927	103
F3SN-A0945P14 (-01)	945	105
F3SN-A0963P14 (-01)	963	107
F3SN-A0981P14 (-01)	981	109
F3SN-A0999P14 (-01)	999	111
F3SN-A1017P14 (-01)	1,017	113
F3SN-A1035P14 (-01)	1,035	115
F3SN-A1053P14 (-01)	1,053	117
F3SN-A1071P14 (-01)	1,071	119
F3SN-A1089P14 (-01)	1,089	121
F3SN-A1107P14 (-01)	1,107	123
F3SN-A1125P14 (-01)	1,125	125

Model	Detection height	Number of optical axes
F3SN-A1143P14H(-01)	1143	127
F3SN-A1161P14H(-01)	1161	129
F3SN-A1179P14H(-01)	1179	131
F3SN-A1197P14H(-01)	1197	133
F3SN-A1215P14H(-01)	1215	135
F3SN-A1233P14H(-01)	1233	137
F3SN-A1251P14H(-01)	1251	139
F3SN-A1269P14H(-01)	1269	141
F3SN-A1287P14H(-01)	1287	143
F3SN-A1305P14H(-01)	1305	145
F3SN-A1323P14H(-01)	1323	147
F3SN-A1341P14H(-01)	1341	149
F3SN-A1359P14H(-01)	1359	151
F3SN-A1377P14H(-01)	1377	153
F3SN-A1395P14H(-01)	1395	155
F3SN-A1413P14H(-01)	1413	157
F3SN-A1431P14H(-01)	1431	159
F3SN-A1449P14H(-01)	1449	161
F3SN-A1467P14H(-01)	1467	163
F3SN-A1485P14H(-01)	1485	165
F3SN-A1503P14H(-01)	1503	167
F3SN-A1521P14H(-01)	1521	169
F3SN-A1539P14H(-01)	1539	171
F3SN-A1557P14H(-01)	1557	173
F3SN-A1575P14H(-01)	1575	175
F3SN-A1593P14H(-01)	1593	177
F3SN-A1611P14H(-01)	1611	179

Highlighted products are preferred stock types

F3SN-A□□□□P25, F3SN-A□□□□P25-01

Model	Detection height	Number of optical axes
F3SN-A0217P25 (-01)	217	13
F3SN-A0232P25 (-01)	232	14
F3SN-A0247P25 (-01)	247	15
F3SN-A0262P25 (-01)	262	16
F3SN-A0277P25 (-01)	277	17
F3SN-A0292P25 (-01)	292	18
F3SN-A0307P25 (-01)	307	19
F3SN-A0322P25 (-01)	322	20
F3SN-A0337P25 (-01)	337	21
F3SN-A0352P25 (-01)	352	22
F3SN-A0367P25 (-01)	367	23
F3SN-A0382P25 (-01)	382	24
F3SN-A0397P25 (-01)	397	25
F3SN-A0412P25 (-01)	412	26
F3SN-A0427P25 (-01)	427	27
F3SN-A0442P25 (-01)	442	28
F3SN-A0457P25 (-01)	457	29
F3SN-A0472P25 (-01)	472	30
F3SN-A0487P25 (-01)	487	31
F3SN-A0502P25 (-01)	502	32
F3SN-A0517P25 (-01)	517	33
F3SN-A0532P25 (-01)	532	34
F3SN-A0547P25 (-01)	547	35
F3SN-A0562P25 (-01)	562	36
F3SN-A0577P25 (-01)	577	37
F3SN-A0592P25 (-01)	592	38
F3SN-A0607P25 (-01)	607	39
F3SN-A0622P25 (-01)	622	40
F3SN-A0637P25 (-01)	637	41
F3SN-A0652P25 (-01)	652	42
F3SN-A0667P25 (-01)	667	43
F3SN-A0682P25 (-01)	682	44
F3SN-A0697P25 (-01)	697	45
F3SN-A0712P25 (-01)	712	46
F3SN-A0727P25 (-01)	727	47
F3SN-A0742P25 (-01)	742	48

Model	Detection height	Number of optical axes
F3SN-A0757P25 (-01)	757	49
F3SN-A0772P25 (-01)	772	50
F3SN-A0787P25 (-01)	787	51
F3SN-A0802P25 (-01)	802	52
F3SN-A0817P25 (-01)	817	53
F3SN-A0832P25 (-01)	832	54
F3SN-A0847P25 (-01)	847	55
F3SN-A0862P25 (-01)	862	56
F3SN-A0877P25 (-01)	877	57
F3SN-A0892P25 (-01)	892	58
F3SN-A0907P25 (-01)	907	59
F3SN-A0922P25 (-01)	922	60
F3SN-A0937P25 (-01)	937	61
F3SN-A0952P25 (-01)	952	62
F3SN-A0967P25 (-01)	967	63
F3SN-A0982P25 (-01)	982	64
F3SN-A0997P25 (-01)	997	65
F3SN-A1012P25 (-01)	1,012	66
F3SN-A1027P25 (-01)	1,027	67
F3SN-A1042P25 (-01)	1,042	68
F3SN-A1057P25 (-01)	1,057	69
F3SN-A1072P25 (-01)	1,072	70
F3SN-A1087P25 (-01)	1,087	71
F3SN-A1102P25 (-01)	1,102	72
F3SN-A1117P25 (-01)	1,117	73
F3SN-A1132P25 (-01)	1,132	74
F3SN-A1147P25 (-01)	1,147	75
F3SN-A1162P25 (-01)	1,162	76
F3SN-A1177P25 (-01)	1,177	77
F3SN-A1192P25 (-01)	1,192	78
F3SN-A1207P25 (-01)	1,207	79
F3SN-A1222P25 (-01)	1,222	80
F3SN-A1237P25 (-01)	1,237	81
F3SN-A1252P25 (-01)	1,252	82
F3SN-A1267P25 (-01)	1,267	83
F3SN-A1282P25 (-01)	1,282	84

Model	Detection height	Number of optical axes
F3SN-A1297P25 (-01)	1,297	85
F3SN-A1312P25 (-01)	1,312	86
F3SN-A1327P25 (-01)	1,327	87
F3SN-A1342P25 (-01)	1,342	88
F3SN-A1357P25 (-01)	1,357	89
F3SN-A1372P25 (-01)	1,372	90
F3SN-A1387P25 (-01)	1,387	91
F3SN-A1402P25 (-01)	1,402	92
F3SN-A1417P25 (-01)	1,417	93
F3SN-A1432P25 (-01)	1,432	94
F3SN-A1447P25 (-01)	1,447	95
F3SN-A1462P25 (-01)	1,462	96
F3SN-A1477P25 (-01)	1,477	97
F3SN-A1492P25 (-01)	1,492	98
F3SN-A1507P25 (-01)	1,507	99
F3SN-A1522P25 (-01)	1,522	100
F3SN-A1537P25 (-01)	1,537	101
F3SN-A1552P25 (-01)	1,552	102
F3SN-A1567P25 (-01)	1,567	103
F3SN-A1582P25 (-01)	1,582	104
F3SN-A1597P25 (-01)	1,597	105
F3SN-A1612P25 (-01)	1,612	106
F3SN-A1627P25 (-01)	1,627	107
F3SN-A1642P25 (-01)	1,642	108
F3SN-A1657P25 (-01)	1,657	109
F3SN-A1672P25 (-01)	1,672	110
F3SN-A1687P25 (-01)	1,687	111
F3SN-A1702P25 (-01)	1,702	112
F3SN-A1717P25 (-01)	1,717	113
F3SN-A1732P25 (-01)	1,732	114
F3SN-A1747P25 (-01)	1,747	115
F3SN-A1762P25 (-01)	1,762	116
F3SN-A1777P25 (-01)	1,777	117
F3SN-A1792P25 (-01)	1,792	118
F3SN-A1807P25 (-01)	1,807	119
F3SN-A1822P25 (-01)	1,822	120

Highlighted products are preferred stock types

F3SN-A□□□□P40, F3SN-A□□□□P40-01

Model	Detection height	Number of optical axes
F3SN-A0217P40(-01)	217	7
F3SN-A0247P40(-01)	247	8
F3SN-A0277P40(-01)	277	9
F3SN-A0307P40(-01)	307	10
F3SN-A0337P40(-01)	337	11
F3SN-A0367P40(-01)	367	12
F3SN-A0397P40(-01)	397	13
F3SN-A0427P40(-01)	427	14
F3SN-A0457P40(-01)	457	15
F3SN-A0487P40(-01)	487	16
F3SN-A0517P40(-01)	517	17
F3SN-A0547P40(-01)	547	18
F3SN-A0577P40(-01)	577	19
F3SN-A0607P40(-01)	607	20
F3SN-A0637P40(-01)	637	21
F3SN-A0667P40(-01)	667	22
F3SN-A0697P40(-01)	697	23
F3SN-A0727P40(-01)	727	24

Model	Detection height	Number of optical axes
F3SN-A0757P40(-01)	757	25
F3SN-A0787P40(-01)	787	26
F3SN-A0817P40(-01)	817	27
F3SN-A0847P40(-01)	847	28
F3SN-A0877P40(-01)	877	29
F3SN-A0907P40(-01)	907	30
F3SN-A0937P40(-01)	937	31
F3SN-A0967P40(-01)	967	32
F3SN-A0997P40(-01)	997	33
F3SN-A1027P40(-01)	1027	34
F3SN-A1057P40(-01)	1057	35
F3SN-A1087P40(-01)	1087	36
F3SN-A1117P40(-01)	1117	37
F3SN-A1147P40(-01)	1147	38
F3SN-A1177P40(-01)	1177	39
F3SN-A1207P40(-01)	1207	40
F3SN-A1237P40(-01)	1237	41
F3SN-A1267P40(-01)	1267	42

Model	Detection height	Number of optical axes
F3SN-A1297P40(-01)	1297	43
F3SN-A1327P40(-01)	1327	44
F3SN-A1357P40(-01)	1357	45
F3SN-A1387P40(-01)	1387	46
F3SN-A1417P40(-01)	1417	47
F3SN-A1447P40(-01)	1447	48
F3SN-A1477P40(-01)	1477	49
F3SN-A1507P40(-01)	1507	50
F3SN-A1537P40(-01)	1537	51
F3SN-A1567P40(-01)	1567	52
F3SN-A1597P40(-01)	1597	53
F3SN-A1627P40(-01)	1627	54
F3SN-A1657P40(-01)	1657	55
F3SN-A1687P40(-01)	1687	56
F3SN-A1717P40(-01)	1717	57
F3SN-A1747P40(-01)	1747	58
F3SN-A1777P40(-01)	1777	59
F3SN-A1807P40(-01)	1807	60

F3SN-A/F3SH-A

F3SN-A□□□□P70, F3SN-A□□□□P70-01

Model	Detection height	Number of optical axes
F3SN-A0277P70(-01)	277	5
F3SN-A0337P70(-01)	337	6
F3SN-A0397P70(-01)	397	7
F3SN-A0457P70(-01)	457	8
F3SN-A0517P70(-01)	517	9
F3SN-A0577P70(-01)	577	10
F3SN-A0637P70(-01)	637	11
F3SN-A0697P70(-01)	697	12
F3SN-A0757P70(-01)	757	13
F3SN-A0817P70(-01)	817	14

Model	Detection height	Number of optical axes
F3SN-A0877P70(-01)	877	15
F3SN-A0937P70(-01)	937	16
F3SN-A0997P70(-01)	997	17
F3SN-A1057P70(-01)	1057	18
F3SN-A1117P70(-01)	1117	19
F3SN-A1177P70(-01)	1177	20
F3SN-A1237P70(-01)	1237	21
F3SN-A1297P70(-01)	1297	22
F3SN-A1357P70(-01)	1357	23
F3SN-A1417P70(-01)	1417	24

Model	Detection height	Number of optical axes
F3SN-A1477P70(-01)	1477	25
F3SN-A1537P70(-01)	1537	26
F3SN-A1597P70(-01)	1597	27
F3SN-A1657P70(-01)	1657	28
F3SN-A1717P70(-01)	1717	29
F3SN-A1777P70(-01)	1777	30
F3SN-A1657P70(-01)	1657	28
F3SN-A1717P70(-01)	1717	29
F3SN-A1777P70(-01)	1777	30

Rating/Performance (see the operation manual for details)

Sensors

F3SN-A/F3SH-A

Model	Stand-alone	F3SN-A□□□□P14 (see notes 1 and 8)	F3SN-A□□□□P25 (see note 1)	F3SN-A□□□□P40 (see note 1)	F3SN-A□□□□P70 (see note 1)	F3SH-A09P03
Item	Series connection	F3SN-A□□□□P14-01 (see notes 1, 2 and 8)	F3SN-A□□□□P25-01 (see note 1)	F3SN-A□□□□P40-01 (see note 1)	F3SN-A□□□□P70-01 (see note 1)	F3SH-A09P03-01
Sensor type	Type 4 Safety Light Curtain					
Applicable safety category	4, 3, 2, 1, B					
Operating range	0.2 to 7 m		0.2 to 10 m			
Beam pitch (P)	9 mm		15 mm		30 mm	
Number of beams (n)	21 to 179 (odd numbers only)		13 to 120		7 to 60	
Protective height (PH)	189 to 1611 mm PH = n × P		217 to 1822 mm PH = (n - 1) × P + 37		217 to 1807 mm PH = (n - 1) × P + 37	
Outermost beam gap	—					900 mm
Detection capability	Non-transparent: 14 mm in diameter		Non-transparent: 25 mm in diameter		Non-transparent: 40 mm in diameter	
Effective aperture angle (EAA)	Within ±2.5° for the emitter and receiver at a detection distance of at least 3 m according to IEC 61496-2					
Light source (luminous wavelength)	Infrared LED (870 nm)					
Supply voltage (Vs)	24 VDC ±10% (ripple p-p 10% max.)					
Current consumption (under no-load conditions)	Emitter	Up to 50 beams: 140 mA max., 51 to 85 beams: 155 mA max., 86 beams and more: 170 mA max., 210 mA max. for 179 beams				140 mA max.
	Receiver	Up to 50 beams: 100 mA max., 51 to 85 beams: 110 mA max., 86 beams and more: 120 mA max., 140 mA max. for 179 beams				100 mA max.
OSSD	Two PNP transistor outputs, load current 300 mA max., residual voltage 2 V max. (except for voltage drop due to cable extension)					
Auxiliary output (non-safety output)	One PNP transistor output, load current 50 mA max., residual voltage 2 V max. (except for voltage drop due to cable extension)					
External indicator output (non-safety output) (see note 3)	One PNP transistor output, load current 40 mA max., residual voltage 2 V max. (except for voltage drop due to cable extension)					
Output operation mode	OSSD output: Light-ON Auxiliary output: Dark-ON (can be changed by the F39-MC11) External indicator output: Light-ON (can be changed by the F39-MC11) (see note 3)					
Input voltage	For test input, interlock selection input, reset input, and external relay monitor input voltages; ON voltage: 9 to 24 V (with a sink current of 3 mA max.), OFF voltage: 0 to 1.5 V or open					
Test functions	Self-test (after power ON, and during operation, one cycle during response time) External test (light emission stop function by test input)					
Mutual interference prevention function (see note 3)	Time-shared beam projection system by series connection Number of series connected light curtains: Up to 3 sets Number of beams: Up to 240 beams Length of the series connection cable: 3 m max.					
Safety-related functions	Auto reset/manual reset (interlock) (see note 4) EDM (External Device Monitoring) Fixed blanking (see note 5) Floating blanking (see note 5)					Auto reset mode/manual reset mode (interlock) (see note 4) EDM (External Device Monitoring)
Protection	Output short-circuit protection, reverse polarity protection					
Response time (under stable light incident condition)	ON to OFF: 10 to 15.5 ms max., 19.5 ms max. for 179 beams OFF to ON: 40 to 78 ms max.					ON to OFF: 10 ms max. OFF to ON: 40 ms max.
Startup waiting time	1 s max.					
Ambient light intensity	Incandescent lamp: 3000 lx max. (light intensity on the receiver surface) Sunlight: 10000 lx max. (light intensity on the receiver surface)					
Ambient temperature	Operating: -10 to +55 °C, storage: -30 to +70 °C (with no icing or condensation)					
Ambient humidity	Operating/storage: 35 to 95% RH (with no condensation)					
Insulation resistance	20 MΩ min. (at 500 VDC)					
Dielectric strength voltage	1000 VAC 50/60 Hz 1 min.					
Vibration resistance (malfunction)	10 to 55 Hz, double amplitude: 0.7 mm, X, Y and Z directions: 20 sweeps					
Shock resistance (malfunction)	100 m/s ² , X, Y and Z directions: 1000 times					
Degree of protection	IP65 (IEC60529)					
Connection method	M12 connector (8 pins)					
Weight (in packaging)	Calculate with the following equation: Weight of light curtain with protective height of 189 mm to 738 mm: (g) = (Protective height + 100) × 2 + 1300 Weight of light curtain with protective height of 747 mm to 1402 mm: (g) = (Protective height + 100) × 2 + 1700 Weight of light curtain with protective height of 1417 mm to 1822 mm: (g) = (Protective height + 100) × 2 + 2100					
Materials	Case: Aluminum, cap: Zinc die-cast, optical cover: PMMA (acrylic resin)					
Accessories	Test rod (see note 6), instruction manual, error mode label, mounting brackets (top and bottom), mounting brackets (intermediate) (see note 7)					

Model	Stand-alone	F3SN-A□□□□P14 (see notes 1 and 8)	F3SN-A□□□□P25 (see note 1)	F3SN-A□□□□P40 (see note 1)	F3SN-A□□□□P70 (see note 1)	F3SH-A09P03
Item	Series connection	F3SN-A□□□□P14-01 (see notes 1, 2 and 8)	F3SN-A□□□□P25-01 (see note 1)	F3SN-A□□□□P40-01 (see note 1)	F3SN-A□□□□P70-01 (see note 1)	F3SH-A09P03-01
Applicable standard		IEC61496-1, EN61496-1 Type 4 ESPE (Electro-Sensitive Protective Equipment) IEC61496-2 Type 4 AOPD (Active Opto-electronic Protective Devices)				

- Note: 1. The 4 digits in □□□□ in the model number represent the protective height. Use the formula given in the information on protective height specifications to calculate the height.
For example, if the beam gap is 9 mm, and the No. of beams is 21, the protective height will be 9 × 21 = 189 mm. The model with this protective height is F3SN-A0189P14.
2. F3SN-A□□□□P14-01 is a customized model. Consult with your OMRON representative when ordering this model.
3. Models ending in -01 only.
4. For the factory setting, the manual reset mode is set to the "start/restart" interlock.
Using the F39-MC11 can select either the start interlock or the restart interlock.
5. For the factory setting, the function is not set. It can be enabled with the F39-MC11.
6. Not provided with the F3SN-A□□□□P70 and F3SH-A.
7. The intermediate mounting bracket is supplied with the following types:
Types which have the total length of the light curtain from 640 mm to 1280 mm: 1 set for each of emitter and receiver.
Types which have the total length of the light curtain over 1280 mm: 2 sets for each of emitter and receiver.
8. For sizes above 1,125 mm add „H“ after P14, e.g. F3SN-A1143P14H. Ask for supplemental manual.

Accessories

Control unit

Item	Model	F3SP-B1P	G9SA-300-SC (See note)
Applicable sensor	F3SN-A, F3SH-A		
Supply voltage	24 VDC ±10%		
Power consumption	1.7 W DC max. (does not include the sensor's current consumption)		24 VDC: 0.7 WDC max. (does not include the sensor's current consumption)
Operating time	100 ms max. (does not include the sensor's response time)		300 ms max. (does not include the sensor's response time and bouncetime)
Response time	10 ms max. (does not include the sensor's response time)		10 ms max. (does not include the sensor's response time and bouncetime)
Relay output	No. of contact	3 NO + 1 NC	3 NO
	Rated load	25 VAC, 5 A (cos diameter = 1), 30 VDC, 5 A L/R = 0 ms	250 VAC, 5 A
	Rated carry voltage	5 A	
Connection method	Between sensor's	M12 connector (8 pins)	
	Other	Terminal block	
Weight (in packaging)	Approx. 280 g		Approx. 300 g
Accessory	Instruction manual		

Note: 1. For further details on the G9SA-300-SC, refer to the G9SA catalogue.

Setting console

Item	Model	F39-MC11
Applicable sensor	F3SN-A, F3SH-A	
Supply voltage	24 V DC ±10% (supplied from sensor)	
Connection method	Special cable (accessory)	
Weight (Packed state)	360 g	
Accessories	Branch connector (1), special cable (2 m), connector cap (1), operation manual	

For details on the setting console, see the manual included with the product.

Large indicator lamps

	Model	F39-A01PR-L (for emitter) F39-A01PR-D (for light receiver)	F39-A01PG-L (for emitter) F39-A01PG-D (for light receiver)
Item		F3SN-A□□□□P□□-01	F3SH-A09P03-01
Applicable sensor	F3SN-A□□□□P□□-01 F3SH-A09P03-01		
Light source	Red LED		Green LED
Supply voltage	24 V DC ±10% (supplied by sensor)		
Current consumption	40 mA or less (supplied by sensor)		
Connection method	M12 connector (8-pin)		
Weight (Packed state)	80 g		

Environment-resistant Enclosure

Item	Model	F39-HP□□□□-14	F39-HP□□□□-25 F39-HPH09-03
Applicable sensor	F3SN-A□□□□P14(-01)		F3SN-A□□□□P25(-01)/P40(-01)/P70(-01), F3SH-A09P03(-01)
Operating range characteristics	0.2 to 6 m		0.2 to 10 m
Degree of protection (see note)	IP67 (IEC60529)		
Materials	Case: Acrylic resin, rubber: NBR60, mounting bracket: SUS316L, screw: SUS316L		

Note: To conform to IP67, tighten the screws according to the "Cautions for Use" as described in the manual packaged together with the product.

Connection

Using a manual reset function and an external device monitoring function

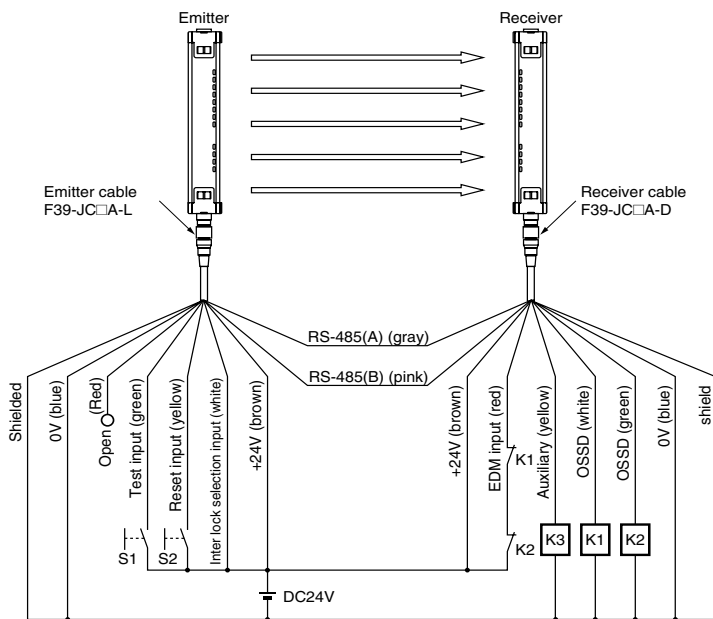

When using an auto reset function

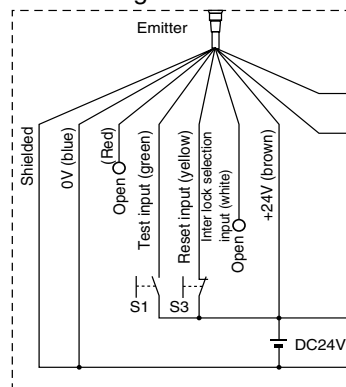

- S1: External test switch
- S2: Interlock/lockout reset switch
- S3: Lock-out reset switch (if the switch is not needed, connect to 24 V DC)
- K1, K2: Relays for control of dangerous parts of machine.
- K3: Load, PLC, etc. (for monitor)

Note: If you do not intend to use the external relay monitor, connect the auxiliary output that is set for dark: ON operation to the external relay monitor input, or use F39-MC11 to disable the external relay monitor function.

Correct Usage

This catalog is intended as a guide for product selection. Be sure to use the instruction manual provided with the product for actual operation.

Regulations and Standards

1. "Type Approval" specified in the Chapter 44. 2 of the Industrial Safety and Health Law in Japan does not apply to independent units of the F3SN-A/F3SH-A sensors. This law applies to systems incorporated with the sensor's. When using the F3SN-A/F3SH-A sensor in Japan as "safety devices for presses or shearing machines" as specified in the Chapter 42 of the same law, apply for approval as a system.
2. (1) The F3SN-A/F3SH-A is electro-sensitive protective equipment (ESPE) in accordance with European Union (EU) Machinery Directive Annex IV, B, Safety Components, Item 1.
- (2) The F3SN-A/F3SH-A complies with the following regulations and standards:
 1. EU Regulations
 - Machinery Directive: Directive 98/37/EC
 - EMC Directive: Directive 89/336/EEC
 2. European standards: EN61496-1 (TYPE 4 ESPE), prEN61496-2 (TYPE 4 AOPD)
 3. International standards: IEC61496-1 (TYPE 4 ESPE), IEC61496-2 (TYPE 4 AOPD)
 4. American standards: UL61496-1 (type 4 ESPE), UL61496-2 (type 4 AOPD), UL508, UL1998, CAN/CSA22.2 No. 14, CAN/CSA22.2 No. 0.8
 5. JIS standards: JIS B9704-1 (type 4 ESPE), JIS B9704-2 (type 4 AOPD)
- (3) The F3SN-A/F3SH-A received the following approvals from the EU accredited body DEMKO A/S:
 - EC Type-Examination in accordance with the EU Machinery Directive (TYPE 4 ESPE)
 - Certificate of a competent body for EMC
 - DEMKO Type Approval
 - Type 4 ESPE (EN61496-1)
 - Type 4 AOPD (prEN61496-2)
- (4) The F3SN-A/F3SH-A received the following approvals from the Third Party Assessment Body UL:
 - Certificate of UL listing for US and Canadian safety standards
 - Both of which are: TYPE 4 ESPE (UL61496-1), TYPE 4 AOPD (UL61496-2)
- (5) The F3SN-A/F3SH-A received the following approvals from BG-PRUFZERT of Germany:
 - BG test and approval mark
 - License
 - Type 4 ESPE (EN61496-1)
 - Type 4 AOPD (prEN61496-2)
3. The F3SN-A/F3SH-A is designed according to the following standards. To make sure that the F3SN-A/F3SH-A complies with the following standards and regulations, you are asked to design and use it as provided by any other related standards, laws, and regulations. (Underlined regulations are applicable to the F3SN-A only.) Consult UL or other standardization bodies if you have any questions.
 - EN415-4, prEN691, EN692, prEN693 (European standards)
 - OSHA 29 CFR 1910. 212 (US Industrial Safety and Health Regulation)
 - OSHA 29 CFR 1910. 217 (US Industrial Safety and Health Regulation)
 - ANSI B11. 1 - B11. 19 (US standard)
 - ANSI/RIA 15. 06 (US standard)

Detection zone and intrusion path

F3SN-A Safety Light Curtain

Install protective structures around the machine so that you must pass through the detection zone of the F3SN-A to reach a hazardous part of the machine.

Install the F3SN-A so that some part of the operator's body remains in the detection zone at all times when the operator works in a hazardous area. Failure to do so may result in serious injury.

Correct Installation

A hazardous part of a machine can be reached only by passing through the sensor detection zone.

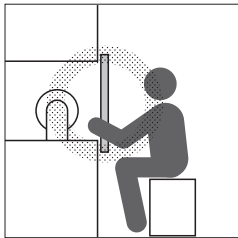

Some part of the operator's body remains in the detection zone while they are working.

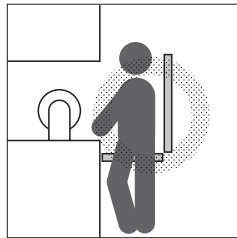

Incorrect Installation

A hazardous part of a machine can be reached without passing through the sensor detection zone.

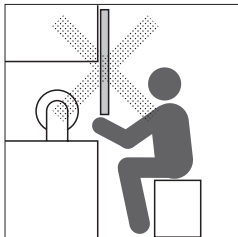

A worker is between the sensor detection zone and a hazardous part of a machine.

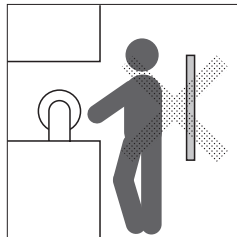

F3SH-A Multi-beam Safety Sensor

Install protective structures around the machine so that you must pass through the detection zone of the F3SH-A to reach a hazardous part of the machine.

If it is possible for an operator to get between the sensor's detection zone and the hazardous part of the machine, design the system so that machinery cannot start up automatically. Make sure that machinery cannot restart while the operator is in the hazardous area. Position the switch for restarting machinery in a location from which the status of the hazardous area can be seen clearly. The switch position location must be a place where the switch cannot be operated from within the hazardous area.

Failure to do so may result in serious injury.

Use of the fixed blanking function

After setting the fixed blanking, check that the F3SN-A detects a test rod at any position in the detection zone through which a person can reach the hazardous part of the machine. If any positions are found by check above, install protective structures to prevent intrusion, which the F3SN-A can not detect.

Failure to do so may result in serious injury.

Distances from reflective surfaces

Be sure to install the F3SN-A/F3SH-A to minimize the effects of reflection from nearby surfaces.

Failure to do so may cause detection to fail and may result in serious injury.

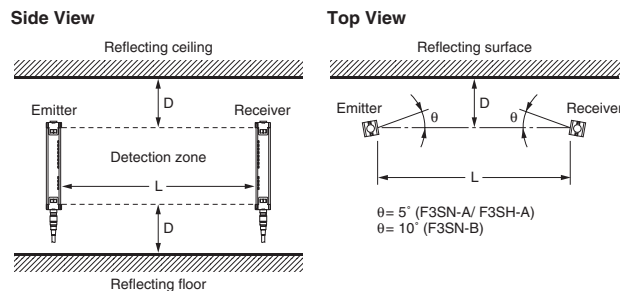

Install the F3SN-A/F3SH-A with minimum Distance D shown above from reflective surfaces (highly reflective surfaces) such as metal walls, floors, ceilings, and work pieces.

Distance between emitter and receiver (Operating range L)	Minimum installation distance D
	F3SN-A/ F3SH-A
0. 2 to 3 m	0.13 m
over 3 m	$L/2 \times \tan 2.5^\circ = L \times 0.044$ (m)

Safety distance

Always maintain a safe distance (S) between the light curtain and a hazardous part of a machine.

Failure to do so causes the machine to fail to stop before an operator reaches the dangerous area and may result in serious injury.

Use of the floating blanking increases the size of the detection capability. To calculate a safety distance, be sure to use the increased size of the detection capability.

Failure to do so causes the machine to fail to stop before an operator reaches the dangerous area and may result in serious injury.

The "safety distance" is the minimum distance that must be maintained between the F3SN-A/F3SH-A and a hazardous part of a machine in order to stop the machine before someone or something reaches it. The safety distance is calculated based on the following equation when a person moves perpendicular to the detection zone of a light curtain.

$$\text{Safety distance (S)} = \text{Intrusion speed into the detection zone (K)} \times \text{Total response time for the machine and light curtain (T)} + \text{Additional distance calculated based on the detection capability of the light curtain (C)} \dots\dots\dots (1)$$

The safety distance varies with national standards and individual machine standards. The equation is also different if the direction of intrusion is not perpendicular to the detection zone of the light curtain. Be sure to refer to related standards.

F3SN-A Safety Light Curtain

Reference

Method for calculating safety distance as provided by European Norm EN999 (for intrusion perpendicular to the detection zone)

Detection capability: 40mm or less

Substitute $K = 2000$ mm/s and $C = 8$ (d - 14 mm) in equation (1) and calculate as shown below.

$$S = 2000 \text{ mm/s} \times (T_m + T_s) + 8 (d - 14 \text{ mm}) \dots\dots\dots (2)$$

Where: S = Safety distance (mm)

T_m = Machine response time (s) (See note 1)

T_s = Light curtain response time (s) (See note 2)

d = Detection capability of the light curtain (mm)

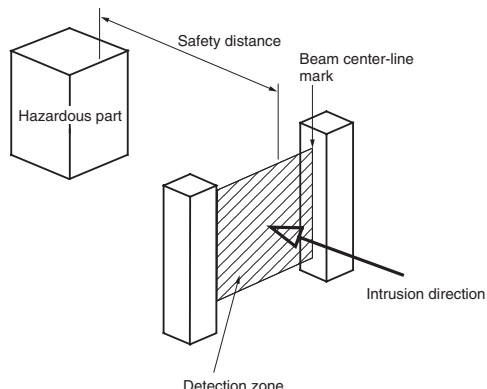

e. g.:
 $T_m = 0.05 \text{ s}$, $T_s = 0.01 \text{ s}$, $d = 14 \text{ mm}$:
 $S = 2000 \text{ mm/s} \times (0.05 \text{ s} + 0.01 \text{ s}) + 8 (14 \text{ mm} - 14 \text{ mm}) = 120 \text{ mm}$

Use $S = 100 \text{ mm}$ if the result of equation (2) is less than 100 mm. Recalculate using the following equation with $K = 1600 \text{ mm/s}$ if the result is over 500 mm.

$$S = 1600 \text{ mm/s} \times (T_m + T_s) + 8 (d - 14 \text{ mm}) \dots\dots\dots(3)$$

Use $S = 500 \text{ mm}$ if the result from equation (3) is less than 500 mm.

Detection capability: over 40mm

Substitute $K = 1600 \text{ mm/s}$ and $C = 850 \text{ mm}$ in equation (1) and calculate as shown below.

$$S = 1600 \text{ mm/s} \times (T_m + T_s) + 850$$

Where: $S =$ Safety distance (mm)
 $T_m =$ Machine response time (s) (See note 1)
 $T_s =$ Light curtain response time (s) (See note 2)

e. g.:
 $T_m = 0.05 \text{ s}$, $T_s = 0.01 \text{ s}$:
 $S = 1600 \text{ mm/s} \times (0.05 \text{ s} + 0.01 \text{ s}) + 850 \text{ mm} = 946 \text{ mm}$
 Note: 1. The machine response time refers to the maximum time from the moment the machine receives a stop signal to the moment the hazardous part of the machine stops. The machine response time should be measured on actual machines. The machine response time should be measured and confirmed periodically.

Response Time Table

Model	Protective height (mm)	Number of beams	Response time	
			ON to OFF	OFF to ON
F3SNA□□□□ P14(-01)	180 to 450	20 to 50	10.0 ms	40 ms
	459 to 765	51 to 85	12.5 ms	50 ms
	774 to 1080	86 to 120	15.0 ms	60 ms
	1089 to 1125	121 to 125	15.5 ms	62 ms

Model	Protective height (mm)	Number of beams	Response time	
			ON to OFF	OFF to ON
F3SN-A□□□□ P25(-01)	217 to 772	13 to 50	10.0 ms	40 ms
	787 to 1297	51 to 85	12.5 ms	50 ms
	1312 to 1822	86 to 120	15.0 ms	60 ms

Model	Protective height (mm)	Number of beams	Response time	
			ON to OFF	OFF to ON
F3SN-A□□□□ P40(-01)	217 to 757	7 to 25	10.0 ms	40 ms
	787 to 1297	26 to 43	12.5 ms	50 ms
	1327 to 1807	44 to 60	15.0 ms	60 ms

Model	Protective height (mm)	Number of beams	Response time	
			ON to OFF	OFF to ON
F3SN-A□□□□ P70(-01)	277 to 757	5 to 13	10.0 ms	40 ms
	817 to 1297	14 to 22	12.5 ms	50 ms
	1357 to 1777	23 to 30	15.0 ms	60 ms

• Response time for series connected types is calculated as follows: (F3SN-A)

For 2 sets:

Response time (ON to OFF): Response time of Light curtain 1 + Response time of Light curtain 2 + 3 ms

Response time (ON to OFF): Response time of Light curtain 1 + Response time of Light curtain 2 + 12 ms

For 3 sets:

Response time (ON to OFF): Response time of Light curtain 1 + Response time of Light curtain 2 + Response time of Light curtain 3 + 4 ms

Response time (ON to OFF): Response time of Light curtain 1 + Response time of Light curtain 2 + Response time of Light curtain 3 + 16 ms

• Response time of F3SP-B1P is 10 ms, operation time is 100 ms.

1. The light curtain response time refers to the time required for output to change from ON to OFF.
2. When using the F3SP-B1P, determine the safety distance by adding the response time of the F3SP-B1P to that of the F3SN given in the table above.

Reference

Method for calculating the safety distance as provided by ANSI B11. 19 (US)

Safety distance (S) = Intrusion speed into the detection zone (K)

Response time ($T_s + T_c + T_r + T_{bm}$) + Additional distance (Dpf)

Where:

$K =$ Intrusion speed (Recommended value in OSHA standards is 1600 mm/s)

ANSI B11. 19. does not define Intrusion speed (K). When determining K, consider possible factors including physical ability of operators.

$T_s =$ Time required for machine to stop (s)

$T_r =$ Light curtain response time (s) (See note)

$T_c =$ Maximum response time required for machine control circuit to apply brake (s)

$T_{bm} =$ Additional time (s)

If the machine is provided with a brake monitor, $T_{bm} =$ brake monitor setting time - ($T_s + T_c$). If not provided with a brake monitor, it is recommended to determine a value more than 20% of ($T_s + T_c$) as the additional time.

Dpf = Additional distance.

Dpf is calculated as follows based on ANSI standards:

$$Dpf = 3.4 \times (d - 7.0) \text{ where } d \text{ is the detection capability of the light curtain (mm).}$$

e. g.:

Assume that: $K = 1600 \text{ mm/s}$, $T_s + T_c = 0.06 \text{ s}$,
 Brake monitor setting time = 0.1s, $T_r = 0.01\text{s}$, $d = 14 \text{ mm}$.

Then:

$$T_{bm} = 0.1 - 0.06 = 0.04 \text{ s}$$

$$Dpf = 3.4 - (14 - 7.0) = 23.8 \text{ mm}$$

$$S = 1600 \times (0.06 + 0.01 - 0.04) + 23.8 = 199.8 \text{ mm}$$

Note: The light curtain response time refers to the time required for output to change from ON to OFF.

Reference

Method for calculating the safety distance as provided by ANSI/RIA R15.06 (US) (for intrusion perpendicular to the detection zone)

Safety distance (D_s) = $K \times (T_s + T_c + T_r) + Dpf$

Where:

K = Intrusion speed: 1600 mm/s min.
 Ts = Maximum stop time of machine/equipment (s)
 Tc = Maximum stop time of control system (s)
 Tr = Light curtain response time (s)
 Os = Diameter of the smallest detectable object (mm)
 Dpf = Additional distance (mm)

Assume that the sensor is installed with the lowest beam height above the floor at 300 mm and the highest beam height above the floor at 1200 mm, with the diameter of the smallest detectable object being 64 mm or less. Then, Dpf is determined from:

$$Dpf = 3.4 \times (Os - 6.875 \text{ mm}).$$

If the diameter of the smallest detectable object is more than 64 mm, Dpf is calculated to be 900 mm.

e. g.:

- F3SN-A□□□□P40 Safety Light Curtain

Assume that K = 1600 mm/s, Ts + Tc = 0.06 s, Tr = 0.01 s, and Os = 40 mm.

Then:

$$\begin{aligned} S &= 1600 \times (0.06 + 0.01) + Dpf \\ &= 1600 \times (0.06 + 0.01) + 3.4 (40 - 6.875) \\ &= 225 \text{ mm} \end{aligned}$$

- F3SN-A□□□□P70 Safety Light Curtain

Assume that K = 1600 mm/s, Ts + Tc = 0.06 s, Tr = 0.01 s, and Dpf = 900 mm.

Then:

$$\begin{aligned} S &= 1600 \times (0.06 + 0.01) + 900 \\ &= 1012 \text{ mm} \end{aligned}$$

Note: The light curtain response time refers to the time required for output to change from ON to OFF.

F3SH-A Multi-beam Safety Sensor

Reference

Method for calculating safety distance as provided by European Norm EN999 (for intrusion perpendicular to the detection zone)

Substitute K = 1600 mm/s and C = 850 mm in equation (1) and calculate as shown below.

$$S = 1600 \text{ mm/s} \times (Tm + Ts) + 850$$

Where:

S = Safety distance (mm)

Tm = Machine response time (s) (See note 1)

Ts = Sensor response time (s) (See note 2)

e. g.:

Tm = 0.05 s, Ts = 0.01 s:

$$S = 1600 \text{ mm/s} \times (0.05 \text{ s} + 0.01 \text{ s}) + 850 \text{ mm} = 946 \text{ mm}$$

Note: 1. The machine response time refers to the maximum time from the moment the machine receives a stop signal to the moment the hazardous part of the machine stops. The machine response time should be measured on actual machines. The machine response time should be measured and confirmed periodically.

2. The sensor response time refers to the time required for output to change from ON to OFF.

Installation

How to prevent mutual interference

The emitter and the receiver to be set facing each other should be a pair of the same set. Erroneous combination may create a zone where objects cannot be detected.

Do not use the sensors for a system where the beam is reflected, or object detection may be disabled. In such an application, use a beam path diversion mirror to prevent the beam reflected from an object from entering the receiver.

When installing two or more pairs of the F3SN-A/F3SN-B/F3SH-A, take necessary measures to prevent mutual interference. Examples of such measures include electrical interconnection and the use of baffle plates.

Correct Use

Installation

How to prevent mutual interference

Series connection (Up to 3 sets, 240 beams, sensor models ending in -01, -03, -04, and -05 are required for series connection)

Two or more pairs of the F3SN-A can be connected in series. When connected in series, the F3SN-A sensors generate beams in a time-sharing manner. Thus, they prevent mutual interference and ensure safety.

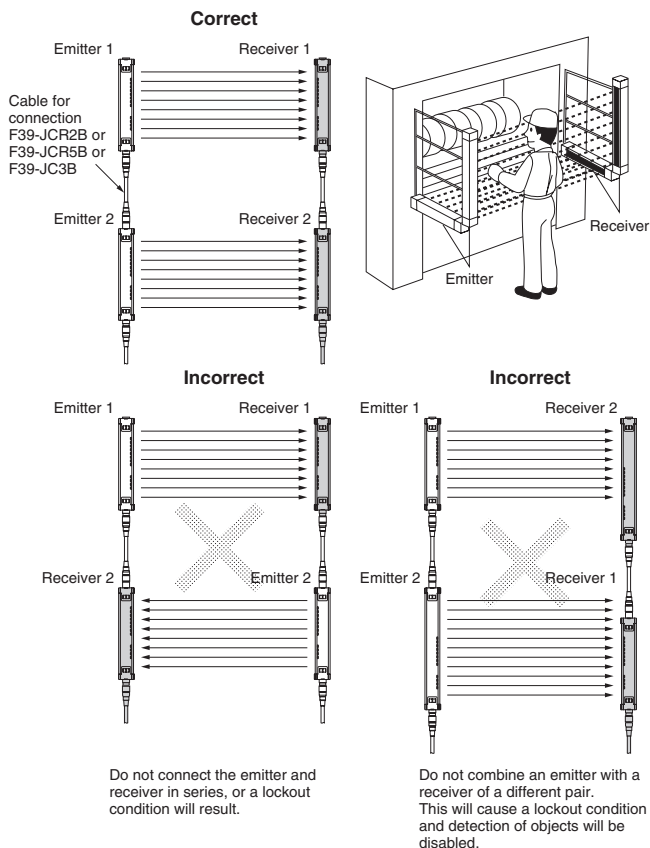

When not connected

When installing two or more pairs of light curtains independently from each other due to inconvenience of wiring or other reason, take proper measures to prevent mutual interference. If mutual interference occurs, a lockout condition will result for the F3SN-A/F3SH-A.

Installation which may cause mutual interference

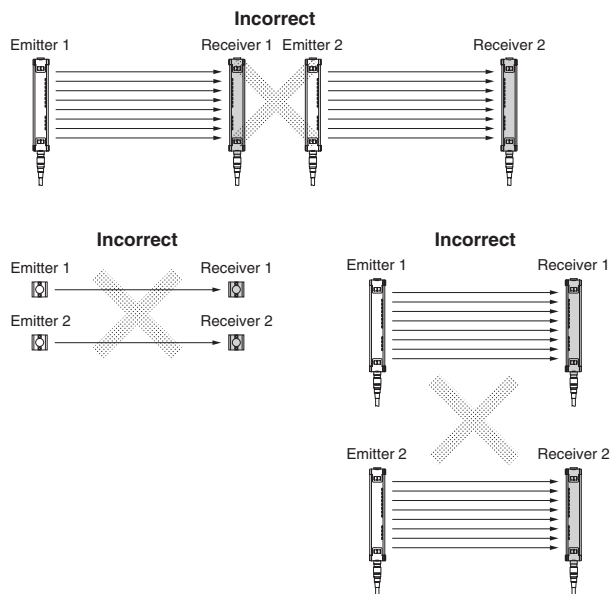

Installation to prevent mutual interference

(1) Install so that the two light curtains emit in the opposite directions (staggered).

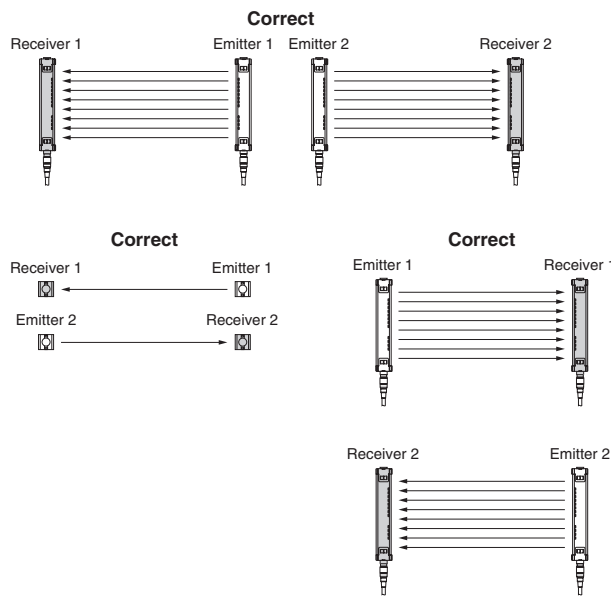

(2) Install a light interrupting wall in between sensors.

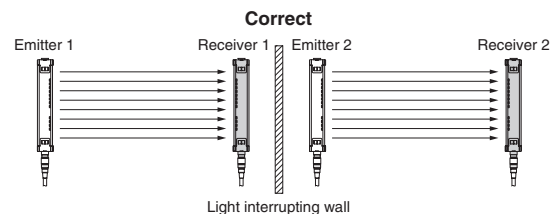

F3SN-A/F3SH-A

(3) Install the light curtains facing away from the one another to eliminate mutual interference.

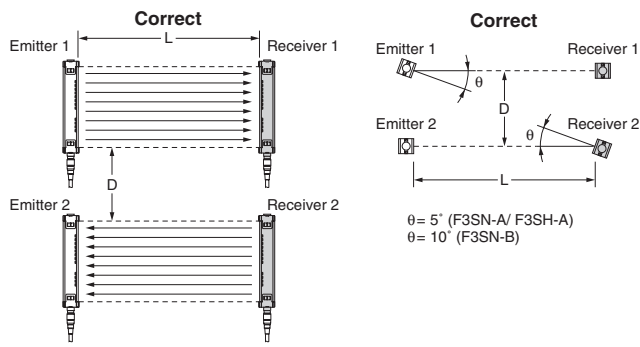

Distance between emitter and receiver (Operating range L)	Minimum installation distance D
	F3SN-A/ F3SH-A
0.2 to 3 m	0.26 m
over 3 m	$L \times \tan 5^\circ = L \times 0.088$ (m)

(4) Use a F39-HS spatter protection slit cover.

Operating range

If the distance between the emitter and the receiver is less than 0.2 m, there is a possibility of chattering. Be sure to use the sensors within the rated operating range.

Names and Functions of Parts

Emitter (F3SN-A/ F3SH-A)

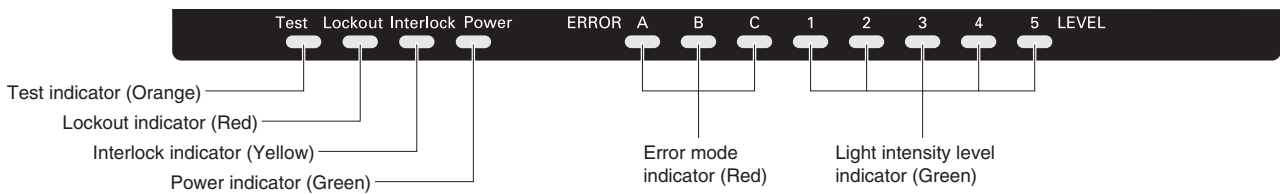

Receiver (F3SN-A)

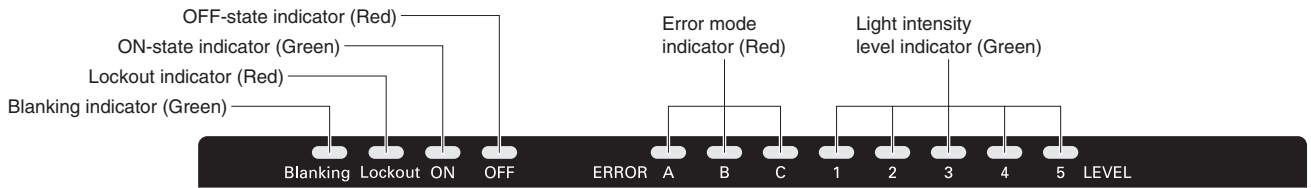

Receiver (F3SH-A)

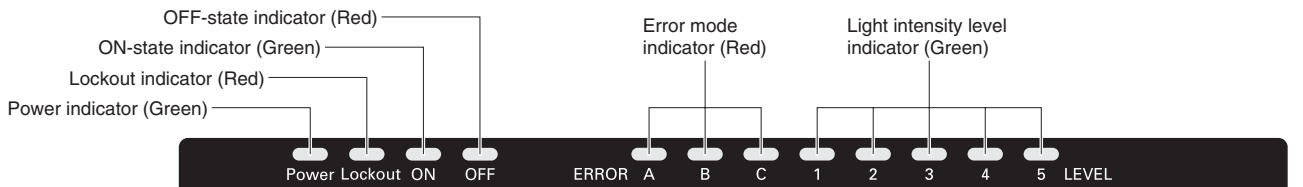

Function

Power indicator	Lit when power is supplied (always lit) F3SN-A, F3SH-A Emitter Lit when power is supplied, flashing when the F39-MC11 is connected F3SH-A Receiver (see note)
Interlock indicator	Lit during interlock condition
Lockout indicator	Flashing during lockout condition
Test indicator	Lit during external test (see note)
ON-state indicator	Lit when OSSD outputs are in ON-state
OFF-state indicator	Lit when OSSD outputs are in OFF-state
Blanking indicator (F3SN-A only)	Lit when blanking is set, flashing when the F39-MC11 is connected (see note)

Note: As a preventive maintenance feature, these indicators will flash after a lapse of 30000 hours.

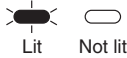
	1	2	3	4	5	Light intensity level
Light intensity level indicator 						200% and above of ON threshold level
						150 to 200% of ON threshold level
						100 to 150% of ON threshold level
						75 to 100% of ON threshold level
						50 to 75% of ON threshold level
						Less than 50% of ON threshold level

	A	B	C	Cause of error
Error mode indicator 				The Interlock selection input line or the reset input line is not wired correctly or became open.
				Relay contact is welded. Releasing time of the relay takes too long. The EDM input line is not wired correctly or became open.
				Communication line (RS-485) is not wired correctly, became open, or causes other errors.
				One of the OSSD outputs is shorted or is not wired correctly. Other failure in OSSD outputs.
				Mutual interference. Interference light is received.
				Types of the receiver and emitter are not the same. Numbers of the receiver and emitter connected in series are not the same.
				External noise. Internal hardware failure of the receiver or the emitter.

Installation

How to attach mounting bracket (F39-L19/L20)

To fully utilize the performance of sensors, locate the F39-L19/L20 mounting brackets in the number satisfying the dimensions "A" and "B" in the sensor longitudinal direction.

- For the F39-L19 Spacing "A": 670 mm max.
- For the F39-L20 Spacing "B": 400 mm max.

Note: When installing sensors at locations susceptible to vibration and shock, increase the number of mounting brackets.

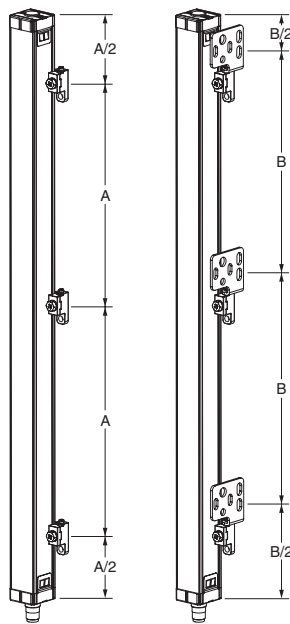

Mounting bracket	Screw × length (mm)	Tightening torque
F39-L19	M5 × 12 screw	2.0 N·m
F39-L20	M4 × 8 screw	1.2 N·m

F39-L19

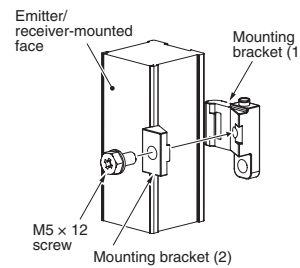

Brackets and screws included in one set

- Mounting bracket (1)1
- Mounting bracket (2)1
- M5 × 12 screw1

F39-L20

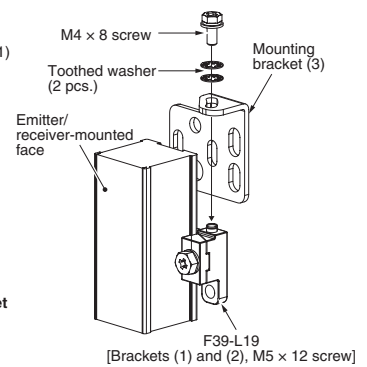

Brackets and screws included in one set

- Mounting bracket (1)1
- Mounting bracket (2)1
- M5 × 12 screw1
- Mounting bracket (3)1
- M4 × 8 screw1
- Toothed washer2

Main unit

F3SN-A□□□□P□□
F3SN-A□□□□P□□-01

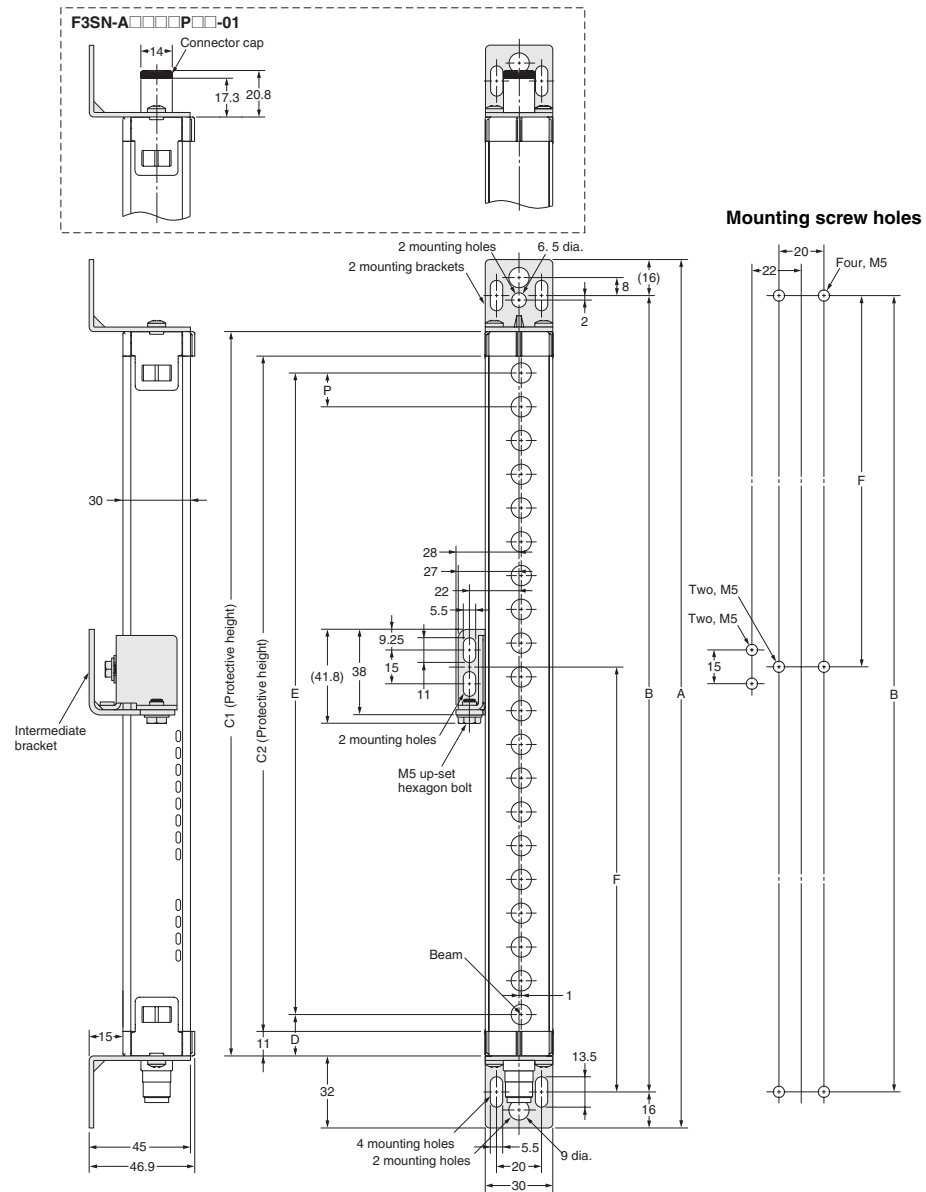

Dimensions according to the model can be calculated by using the following equations.

• F3SN-A□□□□P14(-01)

- Dimension C2 (protective height): 4 digits in the model name
- Dimension A = C2 + 86
- Dimension B = C2 + 54
- Dimension D = 15.5
- Dimension E = C2 - 9
- Dimension F: See the table below.
- Dimension P = 9

C2 (protective height)	Number of intermediate mounting bracket	Dimension F (see note)
to 0620	0	—
0621 to 1125	1	F = B/2

Note: If value F obtained from the above equation is not used, set F to 670 mm or less.

• F3SN-A□□□□P25(-01)/P40(-01)/P70(-01), F3SN-B□□□□P25/P40/P70

- Dimension C1 (protective height): 4 digits in the model name
- Dimension A = C1 + 64
- Dimension B = C1 + 32
- Dimension D = 18.5
- Dimension E = C1 - 37
- Dimension F: See the table below.

C1 (protective height)	Number of intermediate mounting bracket	Dimension F (see note)
to 0640	0	—
0641 to 1280	1	F = B/2
1281 to 1822	2	F = B/3

Dimension P: See the table below

Detection capability	Dimension P
25	15
40	30
70	60

F3SH-A09P03
F3SH-A09P03-01

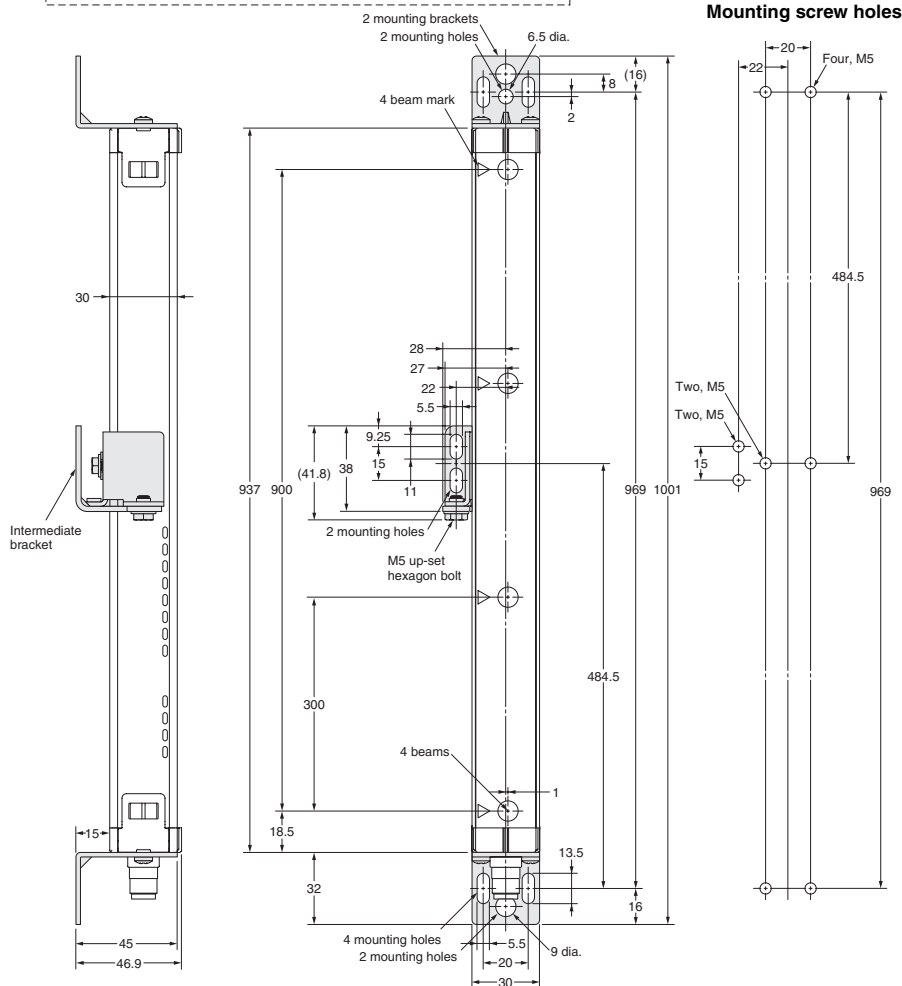
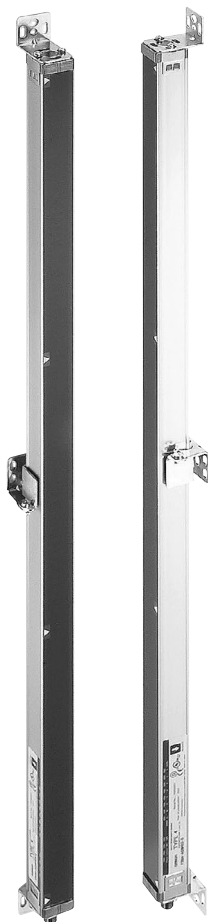
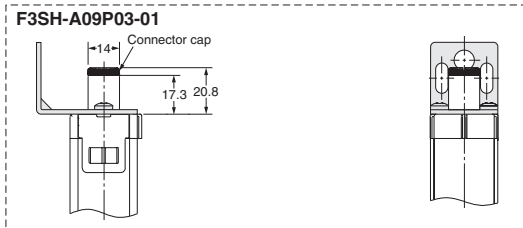

Mounting Precautions

- Note: 1. The mounting bracket (3) (see Mounting brackets (intermediate)) is shown on the left-hand side of the sensor as an example. If the mounting bracket (3) is on the right-hand side of the sensor then the mounting holes must also be on the right-hand side.
2. When using with the cable bent, allow at least the dimensions shown on the right.
(Minimum bending radius of cable: R36 mm.)

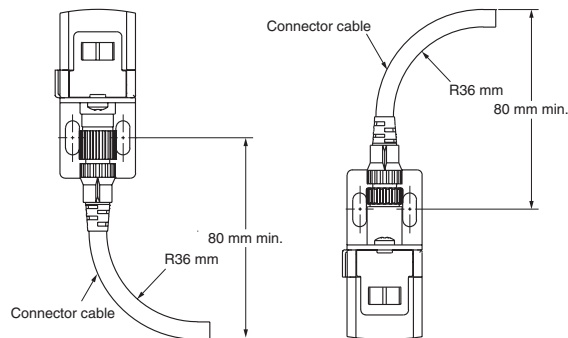

F3SN-A/F3SH-A

Accessories

Mounting bracket (top and bottom)

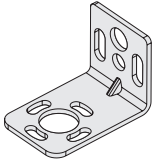

Material: Iron (zinc plating)

Note: Provided with the product.

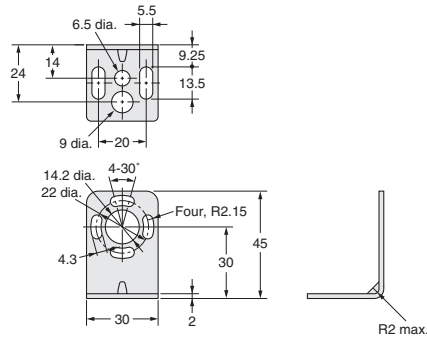

Mounting brackets (intermediate)

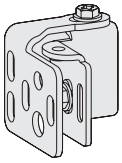

Material: Iron (zinc plating)

Note: Provided with the product.
The number of brackets required depends on the total length of the Sensor.

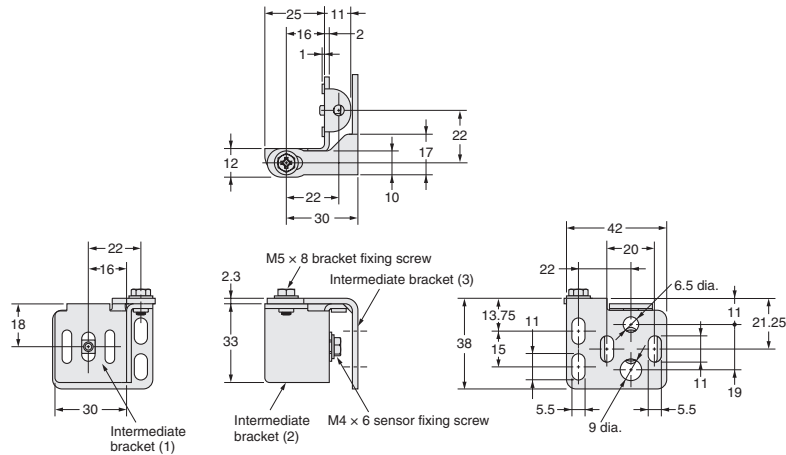

Accessories (Optional)

Single-ended connector cable

- F39-JC3A (L = 3 m)
- F39-JC7A (L = 7 m)
- F39-JC10A (L = 10 m)
- F39-JC15A (L = 15 m)



Color: Emitter (gray)
Receiver (black)

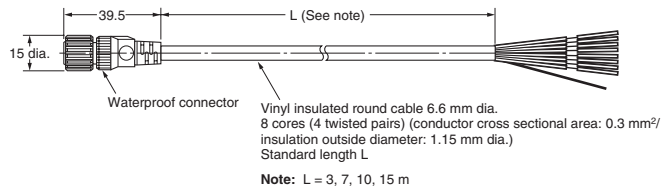

Double-ended connector cable

- F39-JCR2B (L = 0.2 m)
- F39-JCR5B (L = 0.5 m)
- F39-JCR3B (L = 3 m)
- F39-JC5B (L = 5 m)
- F39-JC7B (L = 7 m)
- F39-JC10B (L = 10 m)
- F39-JC15B (L = 15 m)
- F39-JC20B (L = 20 m)
- F39-JCR2C (L = 0.2 m)
- F39-JC1C (L = 1 m)
- F39-JC3C (L = 3 m)
- F39-JC7C (L = 7 m)
- F39-JC10C (L = 10 m)
- F39-JC15C (L = 15 m)



Color: Emitter (gray)
Receiver (black)

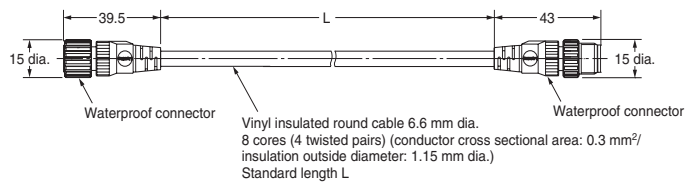

Control unit
F3SP-B1P

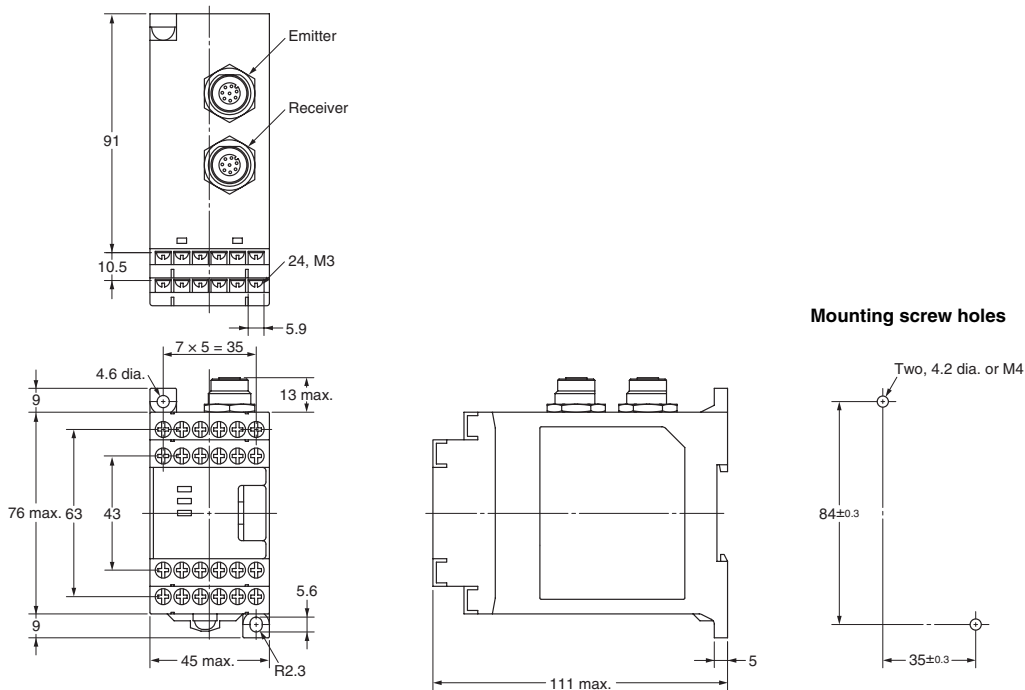

Safety relay unit
G9SA-300-SC

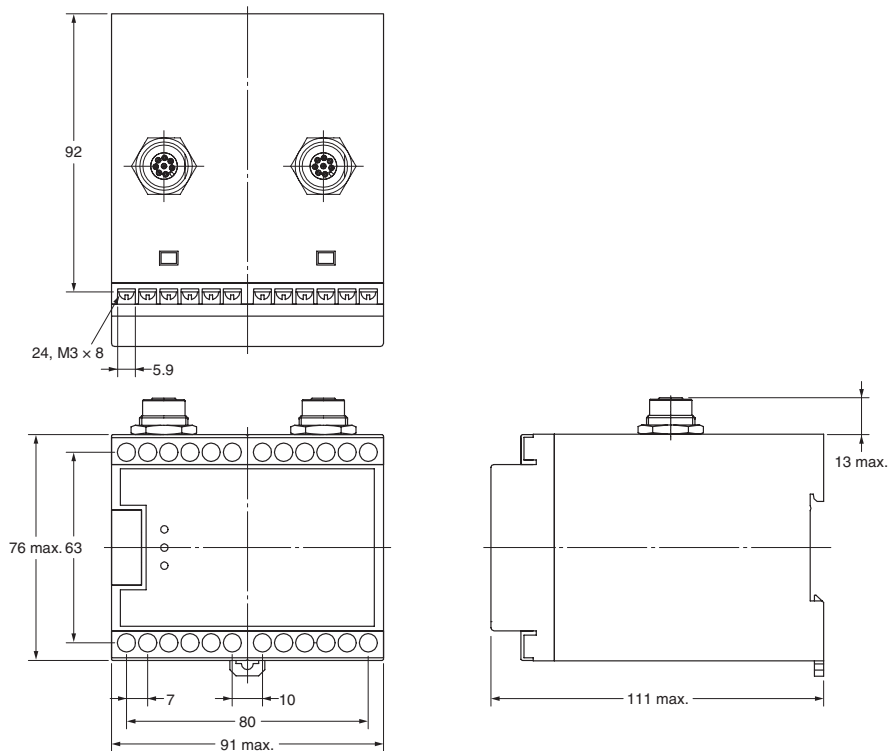

F3SN-A/F3SH-A

Setting console

F39-MC11

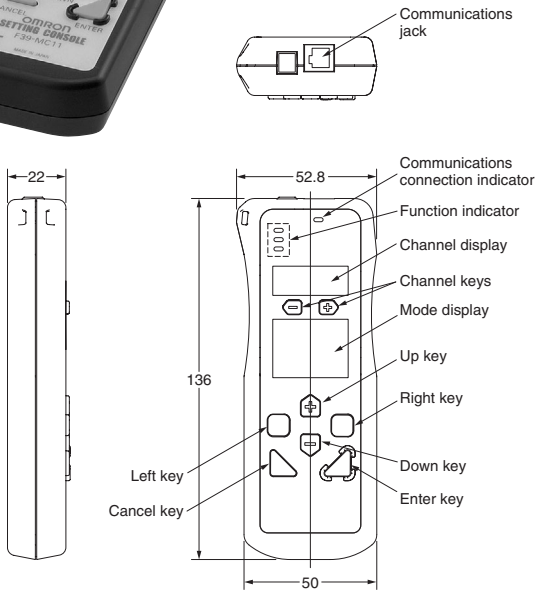

Branching connector
(supplied with F39-MC11)

F39-CN1

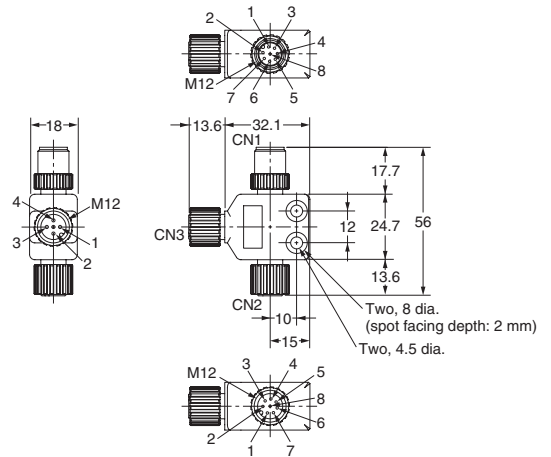

CN1	Connector cable
CN2	Sensor
CN3	Setting console

External indicator

F39-A01PR-L/-D

F39-A01PG-L/-D

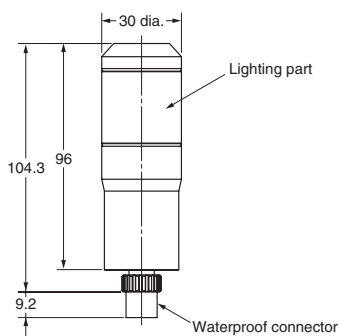

Spatter protection cover

- F39-HN□□□□-14
- F39-HN□□□□-25
- F39-HH09-03

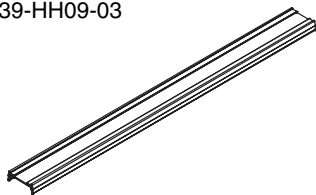

Protection cover

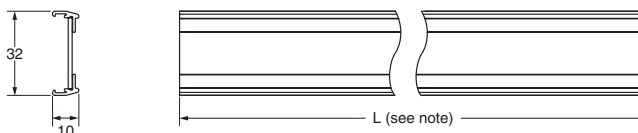

Note: L is as follows.

F39-HN□□□□-14	L = □□□□ mm
F39-HN□□□□-25	L = □□□□ - 22 mm
F39-HH09-03	L = 915 mm

Materials: PC (transparent area)
ABS (non-transparent area)

Mounting dimensions

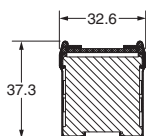

Fixing bracket

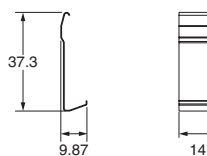

Materials: SUS

Environment-resistant enclosure

- F39-HP□□□□-14
- F39-HP□□□□-25
- F39-HPH09-03

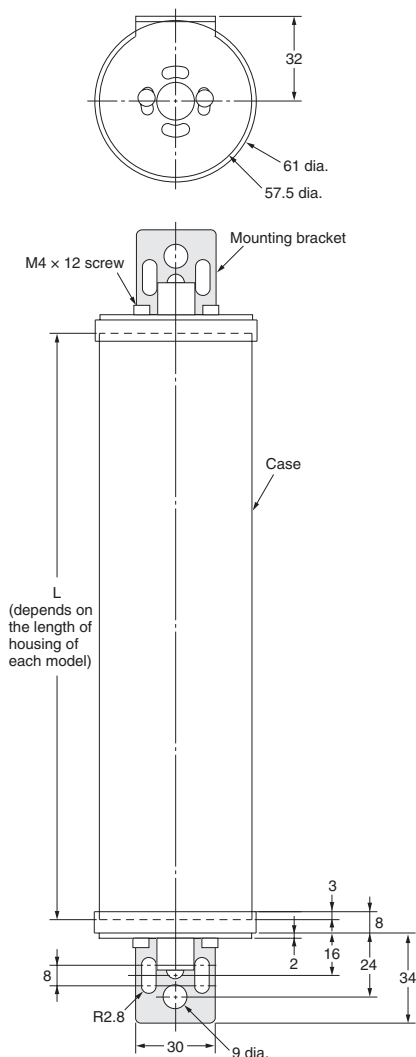

F3SN-A/F3SH-A

Wall mounting bracket

F39-L18

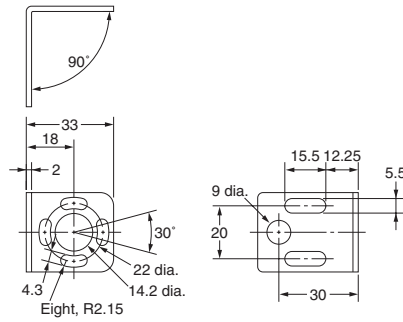

Free-location bracket

F39-L19

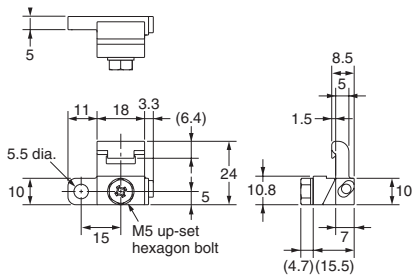

Mounting

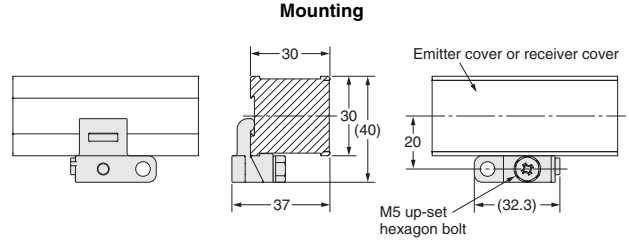

Free-location bracket

F39-L20

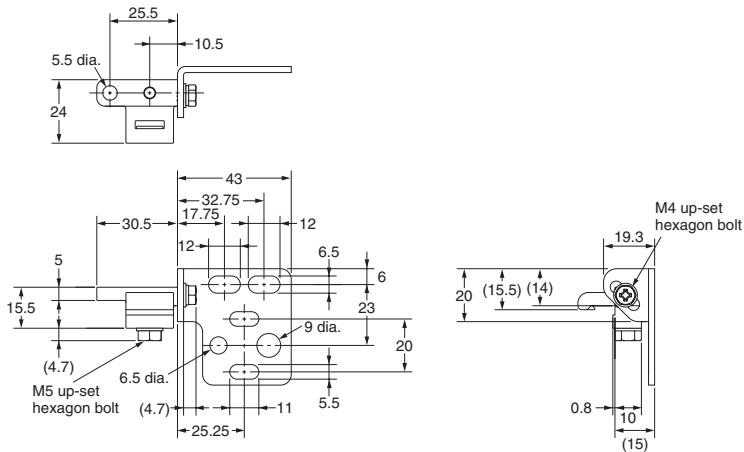

Side mounting

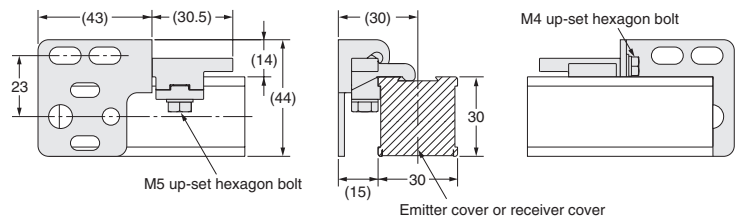

Back mounting

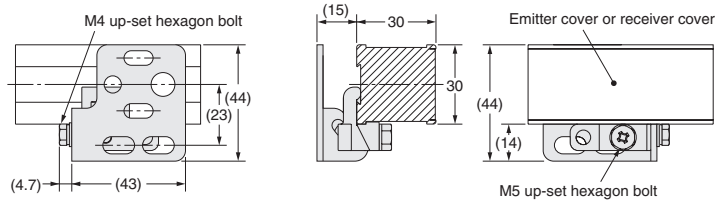

ALL DIMENSIONS SHOWN ARE IN MILLIMETERS.
To convert millimeters into inches, multiply by 0.03937. To convert grams into ounces, multiply by 0.03527.