

# SECTION 1

## Communications Control

This section provides general information on communications and checks.

1-1	Communications and Checks .....	2
-----	---------------------------------	---

# 1-1 Communications and Checks

## Communications Control Procedure

The communications procedure of the E5ZE is a special conversation type. In each E5ZE system, all communications are initiated by the host computer of the system by sending a character string called command block to an E5ZE of the system. The E5ZE then sends a character string called response block back to the host computer, i.e., each time a block is transmitted, the transmission right is also transferred. Each block begins with a start character, @, and the unit number of the E5ZE and ends with an FCS and a terminator. The E5ZE sends a response block back to the host computer whenever the host computer sends a command block to the E5ZE. The response block is processed by the host computer.

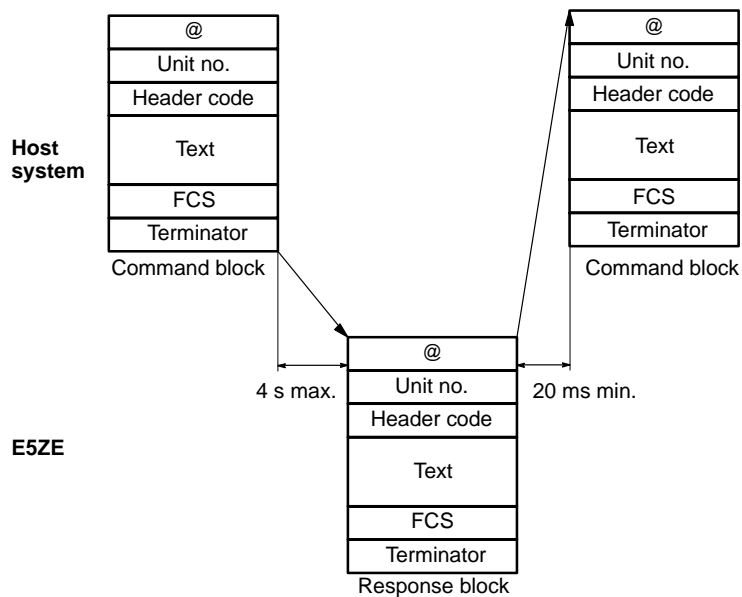

**Note** Command Block: A block sent from the host system. (Character string)  
 Response Block: A block sent from the E5ZE. (Character string)



The host computer must be set up to read the responses sent by the E5ZE. If the host computer does not read any response, the reception buffer of the host computer may overflow.

- Communications after E5ZE Turned OFF and ON  
 The host computer can send a command block to the E5ZE at least 4 s after the E5ZE is turned ON.  
 When the E5ZE is turned OFF and ON, do not fail to initialize the reception buffer of the host computer before sending a command from the host computer.
- The E5ZE requires a maximum of 4 s to process a command block, which must be taken into consideration when writing programs for the E5ZE.
- An interval of 20 ms minimum is required for the host computer to send a command block after receiving a response block. If an interval less than 20 ms is set on the host computer, communications may not be possible.

**Block Format**

The following format is used for the command and response blocks used in E5ZE systems.

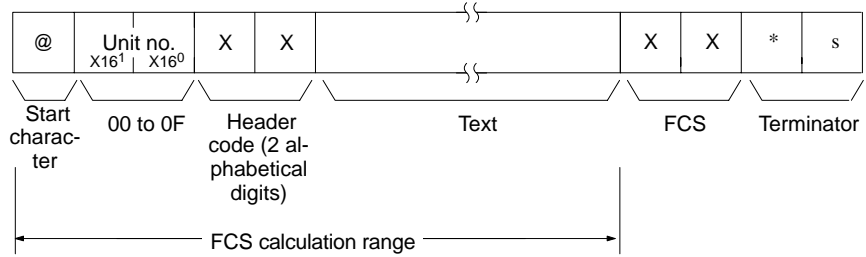

**Start Character:** Each block begins with a start character, @ (40H).

**Unit Number:** The unit number of the E5ZE is required so that the host computer can identify the E5ZE.

**Header Code:** The header code consists of two letters identifying the type of command being sent.

**Text:** The text consists of command or response data in detail.

**FCS:** The FCS is calculated as the exclusive OR of all characters from the start character through the final data character. The resulting 8-bit data is converted to two ASCII characters for transmission as an FCS.

**Terminator:** Each block ends with a terminator consisting of \* (2AH) and a carriage return s (0DH).



If the host computer is connected to more than one E5ZE for RS-422 or RS-485 communications, each of the E5ZE must have a unique unit number, otherwise communications will not be possible.

**FCS Calculations**

Write a program for the host computer so that the host computer can calculate the FCS in each command block and each response block to ensure problem-free communications.

**Calculation Example**

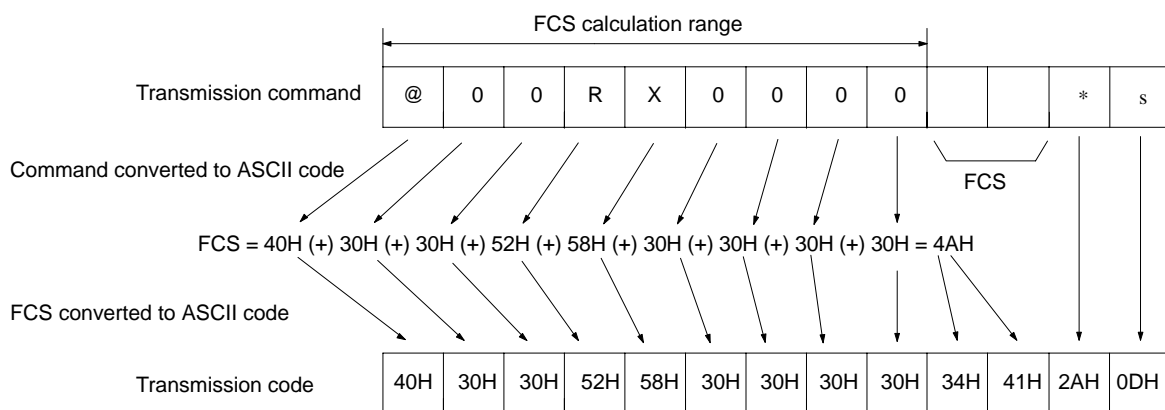

The result "4A" is transmitted as the FCS of the transmission command.

\* Symbols

H: Hexadecimal code

(+): Exclusive OR

**Checks**

All communications errors and recovery from these communication errors must be processed at the host computer. The E5ZE has the following communications error detection functions.

**Character Check**

**Vertical Parity Check**

The E5ZE in vertical parity check operation checks the exclusive OR of each character.

**Framing Check**

The E5ZE determines that there is an error while the E5ZE is communicating with the host computer if the E5ZE detects a stop bit of 0.

**Overrun Check**

The E5ZE determines that there is an error while the E5ZE is communicating with the host computer if the E5ZE processing a character receives the next character.

**Block Check**

**Format Check**

The E5ZE in format check operation checks each command format that the E5ZE receives.

**Numeric Data Check**

The E5ZE in numeric data check operation checks the control point numbers and set values of the E5ZE.

**FCS (Frame Check Sequence)**

The E5ZE in FCS operation checks the start character @ to the exclusive OR of the last character in each block.



If there is a communications error which appears to be caused by noise, execute communications approximately 10 times and check if the communications error disappears. If communications errors occur frequently, change the communication speed between the E5ZE and the host computer or use an optical interface for the transmission path between the E5ZE and host computer.

**Error Processing**

If an error occurs in a command block or response block, refer to the following table to take necessary countermeasures.

Error	Remedy
The end code is not 00.	Check the contents of the end code.
An error code is read.	Check the contents of the error code.
The contents of the response block are abnormal.	Execute communications again.
No response block returns.	Make sure that the communications conditions of the host computer and E5ZE, connections between the host computer the E5ZE, the program used by the host computer connected to the E5ZE, and the settings of the E5ZE and host computer are correct.

# SECTION 2

## Commands and Responses

This section provides a list of commands, end codes, and error codes. Information on writing and reading data sets are also provided.

2-1	Commands .....	6
2-2	Writing Sets of Data .....	12
2-3	Reading Sets of Data .....	14
2-4	End Codes .....	16
2-5	Error Codes .....	19

## 2-1 Commands

### Operational Status and Commands

The following provides a list of commands that can be used with the E5ZE.

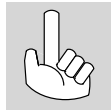

If the following are designated when sending a command, a set of data can be written or read.

Memory bank no. and control point no.: A

Data code: AA

Refer to 2-2 *Writing Data Sets* and 2-3 *Reading Data Sets* for details.

@	Unit	Header code	MB	Control point	Data code			))	Data	((		FCS	*	s
---	------	-------------	----	---------------	-----------	--	--	----	------	----	--	-----	---	---

MB: Memory bank

#### Basic Commands for Temperature Control

OK: Valid

NO: Invalid

Command	Header code	Memory bank	Control point	Data code	Operation status			
					Operation stopped	Operating	Auto-tuning	
Set Point	Write	WS	0 to 7	0 to 7	00	OK	OK	NO
				A	00			
			A	0 to 7	00			
				A	00			
	Read	RS	0 to 7	0 to 7	00	OK	OK	OK
				A	00			
A			0 to 7	00				
Measured Temperature	Read	RX	0	0 to 7	00	OK	OK	OK
				A	00			
Output Value	Read	RO	0	0 to 7	00	OK	OK	OK
					01			
					AA (see note)			
				A	00			
					01			
Proportional Band	Write	WB	0 to 7	0 to 7	00	OK	OK	NO
				A	00			
			A	0 to 7	00			
				A	00			
	Read	RB	0 to 7	0 to 7	00	OK	OK	OK
				A	00			
A				0 to 7	00			
Integral Time	Write	WN	0 to 7	0 to 7	00	OK	OK	NO
				A	00			
			A	0 to 7	00			
				A	00			
	Read	RN	0 to 7	0 to 7	00	OK	OK	OK
				A	00			
A				0 to 7	00			

Command	Header code	Memory bank	Control point	Data code	Operation status			
					Operation stopped	Operating	Auto-tuning	
Derivative Time	Write	WV	0 to 7	0 to 7	00	OK	OK	NO
				A	00			
			A	0 to 7	00			
				A	00			
	Read	RV	0 to 7	0 to 7	00	OK	OK	OK
				A	00			
Control Period	Write	WT	0 to 7	0 to 7	00	OK	OK	NO
					01			
					AA			
				A	00			
					01			
					AA			
			A	0 to 7	00			
					01			
				A	00			
					01			
	Read	RT	0 to 7	0 to 7	00	OK	OK	OK
					01			
				A	00			
					01			
A	0 to 7	00						
		01						
Output Operation	Write	WU	0	0	00	OK	NO	NO
	Read	RU	0	0	00	OK	OK	OK
Alarm Mode	Write	W#	0	0 to 7	00	OK	NO	NO
					01			
					AA			
				A	00			
					01			
					AA			
	Read	R#	0	0 to 7	00	OK	OK	OK
					01			
A	00	01						

Command	Header code	Memory bank	Control point	Data code	Operation status			
					Operation stopped	Operating	Auto-tuning	
Alarm Temperature	Write	W%	0 to 7	0 to 7	00	OK	OK	OK
					01			
					AA			
			A	0 to 7	00			
					01			
					AA			
			A	0 to 7	00			
					01			
					AA			
	A	0 to 7	00					
			01					
			AA					
Read	R%	0 to 7	0 to 7	0 to 7	00	OK	OK	OK
					01			
					AA			
			A	0 to 7	00			
					01			
					AA			
			A	0 to 7	00			
					01			
					AA			
Memory Bank Designation	Write	WM	0	0 to 7	00	OK	OK	NO
				A	00			
	Read	RM	0	0 to 7	00	OK	OK	OK
				A	00			
Hysteresis	Write	WH	0 to 7	0 to 7	00	OK	OK	NO
					01			
					AA			
			A	0 to 7	00			
					01			
					AA			
			A	0 to 7	00			
					01			
					AA			
	A	0 to 7	00					
			01					
			AA					
Read	RH	0 to 7	0 to 7	0 to 7	00	OK	OK	OK
					01			
					AA			
			A	0 to 7	00			
					01			
					AA			
			A	0 to 7	00			
					01			
					AA			
Status	Read	RX	0	0 to 7	02	OK	OK	OK
				A	02			
Error	Read	RU	0	0	03	OK	OK	OK



**Note** The contents of data codes will be read in numerical order if Output Value Read (RO) is used with the data code set to AA. Ignore the contents of data code 02 because the contents of data code 02 are not defined.

**Commands Used According to Application**      OK: Valid  
 NO: Invalid

Command		Header code	Memory bank	Control point	Data code	Operation status		
						Operation stopped	Operating	Auto-tuning
Auto-tuning	Start	AS	0	0 to 7	00	NO	OK	NO
				A	00			
				01				
	Stop	AP	0	0	00	OK	OK	OK
Setting Unit	Write	Wt	0	0	00	OK	OK	OK
	Read	Rt	0	0	00	OK	OK	OK
Input Shift	Write	WI (see note 1)	0 to 7	0 to 7	00	OK	OK	NO
				A	00			
			A	0 to 7	00			
			A	00				
	Read	RI (see note 1)	0 to 7	0 to 7	00	OK	OK	OK
				A	00			
A				0 to 7	00			
Manual Reset Value	Write	WK	0 to 7	0 to 7	00	OK	OK	NO
				A	00			
			A	0 to 7	00			
			A	00				
	Read	RK	0 to 7	0 to 7	00	OK	OK	OK
				A	00			
A				0 to 7	00			
Ramp Value	Write	WR	0 to 7	0 to 7	00	OK	OK	OK
				A	00			
			A	0 to 7	00			
			A	00				
	Read	RR	0 to 7	0 to 7	00	OK	OK	OK
				A	00			
A				0 to 7	00			
Present Set Point	Read	Rs	0	0 to 7	00	OK	OK	OK
				A	00			
Manual Output Value	Write	WO	0	0 to 7	00	NO	OK (see note 2)	NO
				A	00			
					01			

Command	Header code	Memory bank	Control point	Data code	Operation status			
					Operation stopped	Operating	Auto-tuning	
Output Variable Limit Value	Write	WL	0 to 7	0 to 7	00	OK	OK	NO
					01			
				A	00			
				01				
			A	0 to 7	00			
					01			
				A	00			
					01			
	Read	RL	0 to 7	0 to 7	00	OK	OK	OK
					01			
A				00				
				01				
A			0 to 7	00				
				01				
Output Variable Change Rate Limit Value	Write	WG	0 to 7	0 to 7	00	OK	OK	NO
					A			
			A	0 to 7	00			
					A			
Read	RG	0 to 7	0 to 7	00	OK	OK	OK	
				A				00
			A	0 to 7				00
								00
Memory Write	WE	A	A	00	OK	OK	OK	
Initialize Setting Data	MC	—	—	—	OK	NO	NO	
Communication Test	TS	—	—	—	OK	OK	OK	

- Note**
1. Upper-case I (“ai”).
  2. Manual Output (WO) is valid if it is used for the E5ZE in manual operation and invalid if it is used for the E5ZE for advanced PID control.

**Heater Burnout and SSR Failure Detection**

OK: Valid  
NO: Invalid

Command	Header code	Memory bank	Control point	Data code	Operation status			
					Operation stopped	Operating	Auto-tuning	
HB Alarm and HS Alarm Point	Write	WU	0	0	02	OK	NO	NO
	Read	RU	0	0	02	OK	OK	OK
Heater Burnout and SSR Failure Detection Current Value	Write	WW	0	0 to 7	00	OK	OK	OK
					01			
				A	00			
					01			
	Read	RW	0	0 to 7	00	OK	OK	OK
					01			
A	00							
	01							
Heater Current Value and SSR Leakage Current Value	Read	RZ	0	0 to 7	00	OK	OK	OK
					01			
				A	00			
					01			

Heating and Cooling Control

OK: Valid  
NO: Invalid

Command	Header code	Memory bank	Control point	Data code	Operation status			
					Operation stopped	Operating	Auto-tuning	
Dead Band and Overlap Band	Write	WD	0 to 7	0 to 7	00	OK	OK	NO
				A	00			
			A	0 to 7	00			
				A	00			
	Read	RD	0 to 7	0 to 7	00	OK	OK	OK
				A	00			
Cooling Coefficient	Write	WC	0 to 7	0 to 7	00	OK	OK	NO
				A	00			
			A	0 to 7	00			
				A	00			
	Read	RC	0 to 7	0 to 7	00	OK	OK	OK
				A	00			
A	0 to 7	00						

Fuzzy Control

OK: Valid  
NO: Invalid

Command	Header code	Memory bank	Control point	Data code	Operation status			
					Operation stopped	Operating	Auto-tuning	
Fuzzy Strength	Write	Wj	0 to 7	0 to 7	00	OK	OK	NO
				A	00			
			A	0 to 7	00			
				A	00			
	Read	Rj	0 to 7	0 to 7	00	OK	OK	OK
				A	00			
A	0 to 7	00						
Fuzzy Scale 1	Write	Wk	0 to 7	0 to 7	00	OK	OK	NO
				A	00			
			A	0 to 7	00			
				A	00			
	Read	Rk	0 to 7	0 to 7	00	OK	OK	OK
				A	00			
A	0 to 7	00						
Fuzzy Scale 2	Write	WI (see note)	0 to 7	0 to 7	00	OK	OK	NO
				A	00			
			A	0 to 7	00			
				A	00			
	Read	RI (see note)	0 to 7	0 to 7	00	OK	OK	OK
				A	00			
A	0 to 7	00						

**Note** Lower-case l (“el”).

Control Operation Start and Stop OK: Valid  
NO: Invalid

Command		Header code	Memory bank	Control point	Data code	Operation status		
						Operation stopped	Operating	Auto-tuning
Operation	Start	OS	0	0 to 7	00	OK	OK	NO
				A	00			
	Stop	OP	0	0 to 7	00	OK	OK	OK
				A	00			
Manual Operation	Start	OM	0	0 to 7	00	OK	OK	NO
				A	00			



Status Read (RX) can be used with a data code to read a variety of data as shown in the following table.

Header code	Memory bank	Control point	Data code	Data to be read
RX	0	0 to 7 or A	00	Process value
			01	Output value
			02	Status
			03	Heater current value
			04	Present set point
			AA	The contents of data codes 00 to 02 in sequence
			BB	The contents of data codes 00 to 04 in sequence

## 2-2 Writing Sets of Data

### Function

A single command block can enable all the memory banks or control points to share the same data or set the contents of all the data codes used by the E5ZE.

### Commands

Use the following command format so that all the memory banks can share the same data and data code.

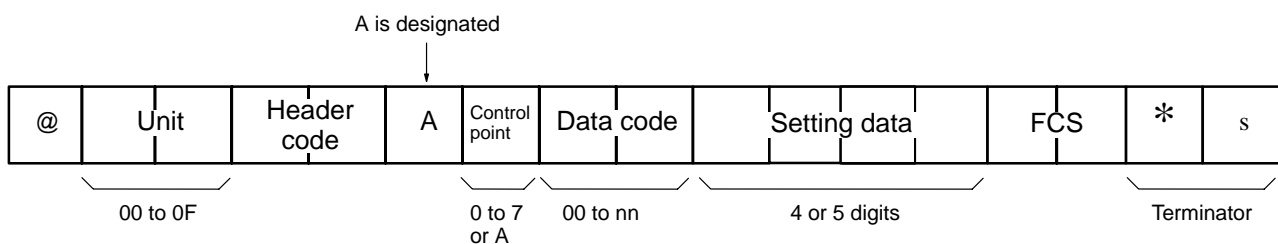

Use the following command format so that all the control points share the same data and data code.

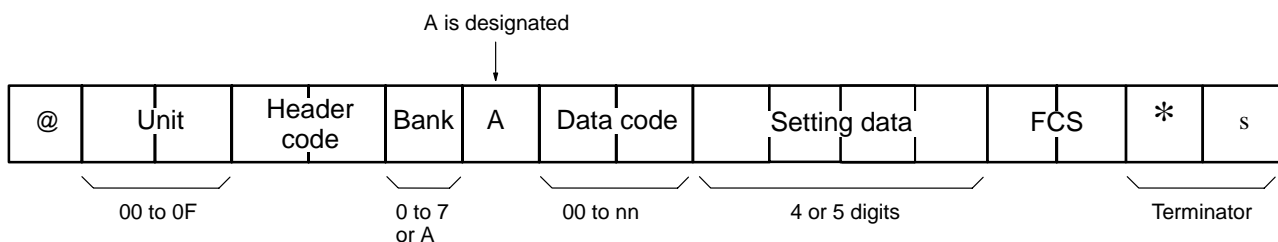

Use the following command format so that the contents of all data codes can be set.

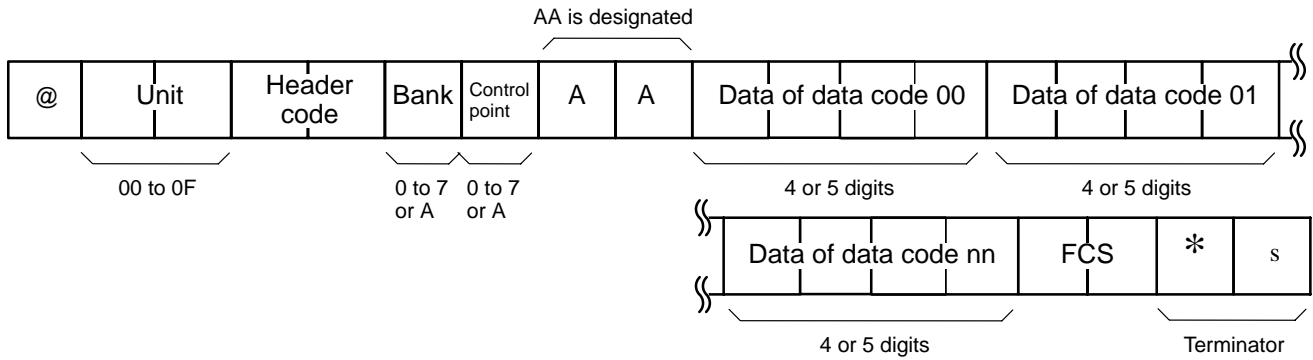

**Response**

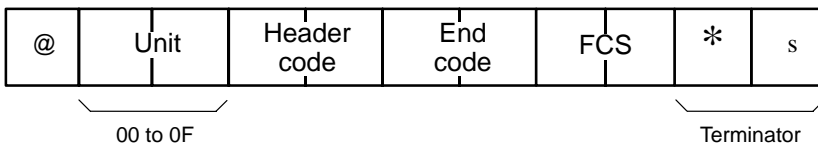

**Communications Example**

In this example, the following unit number, memory bank number, and set point of all the control points are set.

- Unit no.: 1
- Memory bank no: 2
- Set point: 500°C

**Command**

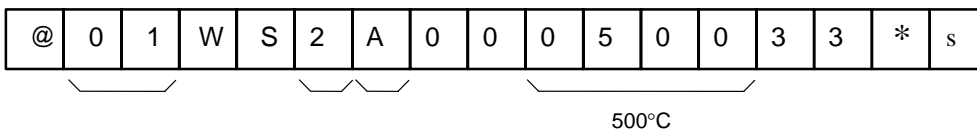

**Response**

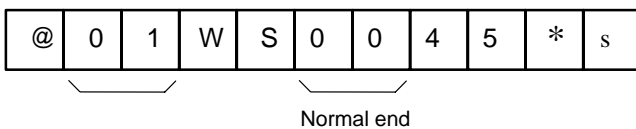

## 2-3 Reading Sets of Data

### Function

A single command block can make it possible to read the contents of all the memory banks or control points, or the contents of all data codes.

### Command

Designate A or AA for the set of memory bank data, control point data, or data code of the command block to read the set of data. A or AA can be used only once in the command block.

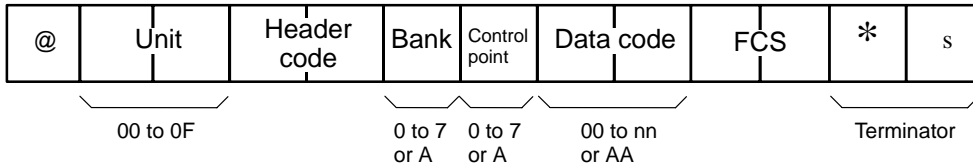

It is possible to use A or AA only once in a command block (e.g., if A is used for the memory bank data, it cannot be used for the control point data and AA cannot be used for the data code).

### Response

Use the following command format so that the contents of all the memory banks can be read.

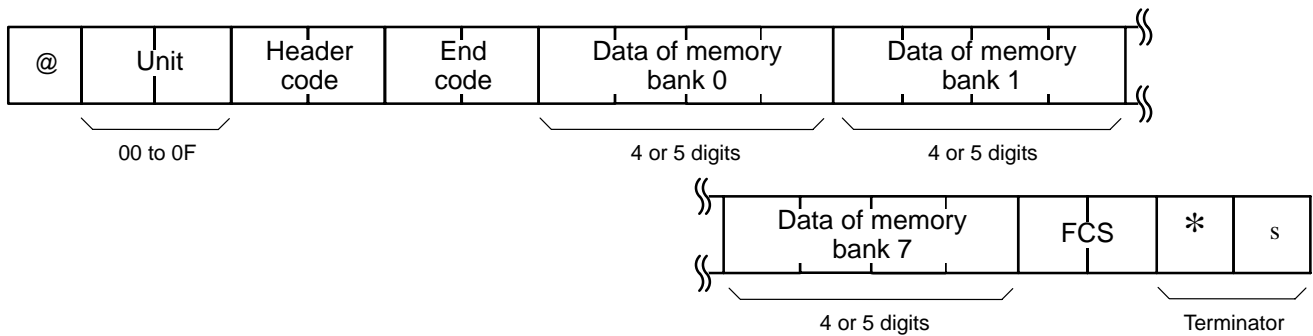

Use the following command format so that the contents of all the control points can be read.

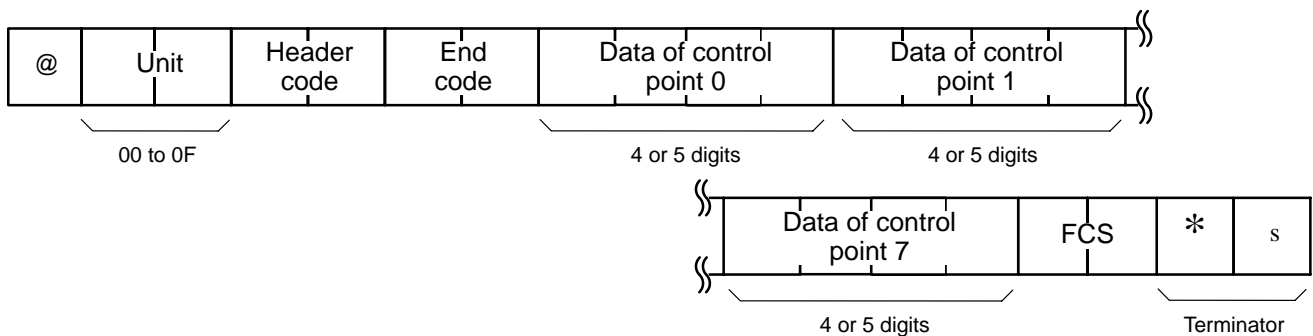

Use the following command format so that the contents of all data codes can be read.

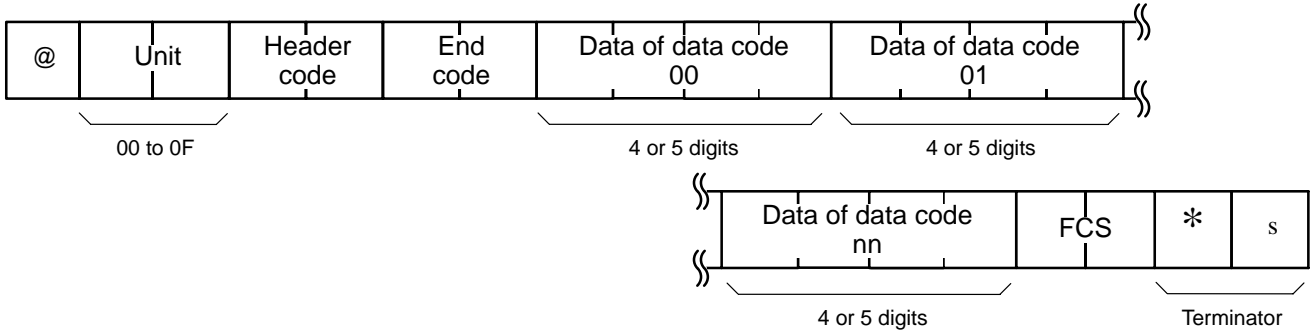

**Communications Example**

In this example, the following unit number, memory bank number, and set point of all the control points are set.

Unit no.: 1  
 Memory bank no.: 2  
 Set point: 500°C

**Command**

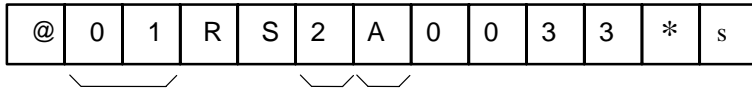

**Response**

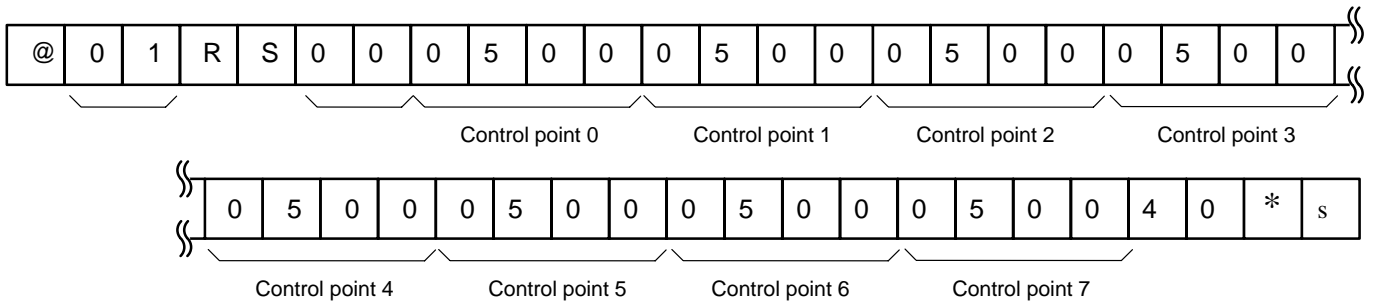

## 2-4 End Codes

### List of End Codes

End code	Name	Command	Cause	Remedy
00	Normal End	---	---	---
01	Prohibited Command	WB, WN, WV, WI*, WS, WT, WH, WK, WL, WG, Wj, Wk, WI**, WD, WC, OS, OM	The designated control point is being auto-tuned.	Send the command after interrupting the auto-tuning of the control point.
		W#, MC	The E5ZE is in control operation or manual operation at the designated control point.	Send the command after interrupting the control operation or manual operation at the control point.
		WM	The memory bank designation method has been set to contact input designation.	Set the memory bank designation method to communications designation. Refer to the <i>E5ZE Operation Manual</i> for details.
			The designated control point is being auto-tuned.	Send the command after interrupting the auto-tuning of the control point.
		AS	The control operation at the designated control point is stopped.	Execute the auto-tuning after the E5ZE starts temperature control at the control point.
			The designated control point is already being auto-tuned.	Correct the program because the control point being auto-tuned does not accept Auto-tuning Start (AS).
		WO	The E5ZE was not in manual operation at the designated control point.	Send the command after sending Manual Operation Start (OM) to the E5ZE to start the manual operation.
		WU	The E5ZE is in temperature control operation or manual operation at the designated control point.	Send the command after interrupting the temperature control operation or manual operation at the control point.
			HB Alarm and HS Alarm Point Write (WU) with data code 02 was sent to an E5ZE model without HB or HS alarm function.	This command cannot be sent to any E5ZE model without HB or HS alarm function.
		WW, RW	These commands were sent to an E5ZE model without HB or HS alarm function.	These commands cannot be sent to any E5ZE model without HB or HS alarm function.
The HB or HS alarm function of the designated control point was not valid.	Before sending these commands, send HB Alarm and HS Alarm Point Write (WU) to the designated control point so that the HB and HS alarms of the designated control point will be valid.			
RZ	The E54-E8CT CT Input Unit is not connected to the E5ZE.	Connect the E54-E8CT CT Input Unit to the E5ZE.		
04	Invalid Address	---	A nonexistent control point, memory bank, or data code was designated.	Designate the control point, memory bank, and data code correctly.
		---	A was designated for the control point and memory bank and AA was designated for the data code simultaneously.	A or AA can be used only once in each command block.



End code	Name	Cause	Remedy
10	Parity Error	The data sent was not even parity.	Set the host system data to even parity.
		The parity was not detected correctly.	It is possible that E5ZE communications suffered noise interference. Separate the communication cable from other wires.
11	Framing Error	The stop bit was not detected.	It is possible that E5ZE communications suffered noise interference. Separate the communication cable from other wires.
12	Overrun Error	The reception buffer overflowed.	It is possible that E5ZE communications suffered noise interference. Separate the communication cable from other wires.
			Reduce the communications speed used for the communications between the E5ZE and host computer because the communications speed is too high for the E5ZE.
13	FCS Error	The FCS was calculated incorrectly.	Refer to <i>1-1 Communications and Checks</i> and make sure that the calculation of the FCS is correct.
		The FCS was not detected correctly.	It is possible that E5ZE communications suffered noise interference. Separate the communication cable from other wires.
14	Format Error	The format of the command block was incorrect.	Check the format of the command block. Make sure that the format of the command block is correct, especially whether the number of digits of the set temperature is four or five.
15	Numeric Error	The set data for the command was not within the setting range of the command.	Send data within the setting range.
		The negative (-) symbol was not added to the leftmost set value while the set data was a negative value.	Add the negative (-) symbol to the leftmost set data on the left.
18	Frame Length Error	The command block exceeded 510 characters.	Check the contents of the command block.
19	Invalid Command due to Error Status	The present alarm temperature set value is not within the alarm range set with Alarm Mode Write (W#).	Change the alarm temperature set value within the alarm range before setting the alarm mode.

End code	Name	Cause	Remedy
21	Invalid Command Due to Error Status	There is a temperature controller error.	<p>Check the type of temperature controller error with Output Operation Read (RU). Take the following countermeasures according to the kind of temperature controller error.</p> <p><u>Memory Error</u></p> <p>Turn the power OFF and ON. If a memory error occurs again, send Initialize Setting Data (MC) and Memory Write (WE) in this order and turn the power OFF and ON again. If a memory error still occurs, the memory needs repairs.</p> <p><u>Cold Junction Compensation Error</u></p> <p>The ambient operating temperature is <math>-15^{\circ}\text{C}</math> or less, or <math>60^{\circ}\text{C}</math> or more. Use the E5ZE at an ambient operating temperature of <math>-15^{\circ}</math> to <math>60^{\circ}\text{C}</math>.</p> <p><u>Set Data Error</u></p> <p>The set point at some control points or in some memory banks are not within the setting range. Initialize Setting Data (MC) must be sent to initialize all the data items and reset the data items within the setting range.</p> <p><u>Other Errors</u></p> <p>Turn the power OFF and ON. If the same errors occur, the E5ZE needs repairs.</p>

- Note**
1. \*Upper-case I ("ai").
  2. \*\*Lower-case l ("el")

### End Code Priority

If multiple end codes are generated by execution of a single command, only the end code with the highest priority will be returned with the response. End code priority, from highest to lowest, is as follows:

1. Framing errors
2. Parity errors
3. Overrun errors
4. Frame length errors
5. FCS errors
6. Command undefined errors
7. Invalid address
8. Format errors
9. Error status
10. Prohibited command
11. Numeric errors
12. Invalid commands due to error status

## 2-5 Error Codes

### Command Undefined Error

The E5ZE will send back the following response block if the E5ZE cannot recognize the header code. In such cases, check the header code of the command block.

#### Response

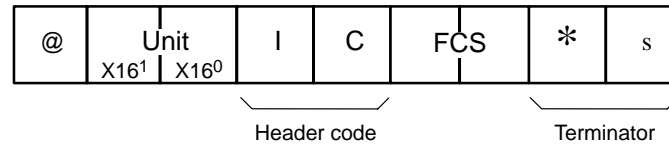

### List of Error Codes

Error code	Name	Command	Cause	Remedy
E001	Memory Error	RX	The memory contents were destroyed.	Turn the power OFF and ON. If a memory error occurs again, send Initialize Setting Data (MC) and Memory Write (WE) in this order and turn the power OFF and ON again. If a memory error still occurs, the memory needs repairs.
E002	Sensor Input AD Error	RX	The sensor AD converter circuitry failed.	Turn the power OFF and ON. If a sensor input AD error occurs again, the sensor AD converter circuitry needs repairs.
E003	Cold Junction Compensation Error	RX	The ambient operating temperature is $-15^{\circ}\text{C}$ or less, or $60^{\circ}\text{C}$ or more.	Use the E5ZE at an ambient operating temperature of $-15^{\circ}$ to $60^{\circ}\text{C}$ .
E004	CT Input AD Error	RZ	The CT input AD converter circuitry failed.	Turn the power OFF and ON. If a CT input AD error occurs again, the CT input AD converter circuitry needs repairs.
E011	Sensor Error	RX	The wires of a temperature sensor connected to the E5ZE are burnout, shorted, or incorrectly wired.	Make sure that the wires of the temperature sensor are not burnout, shorted, or incorrectly wired.
E012	Upper Limit Error	RX	The process value at the designated control point was $20^{\circ}\text{C}/40^{\circ}\text{F}$ or more than the set point upper limit value.	Use the E5ZE so that the process value will not exceed the upper limit.
E013	Lower Limit Error	RX	The process value at the designated control point was $20^{\circ}\text{C}/40^{\circ}\text{F}$ or less than the set point lower limit value.	Use the E5ZE so that the process value will not be less than the lower limit.
E022	Heater Current Upper Limit Error	RZ	The process heater current value at the designated control point was 55.0 A or more.	The E5ZE cannot measure a heater current value of 55.0 A or more.
M001	Temperature Control Interrupted	Rs	The temperature control operation of the designated control point is stopped.	The ramp function does not operate and reading is not possible while operational control is stopped.

## SECTION 3

# Basic Temperature Control Commands

This section describes the basic temperature control commands.

3-1	Set Point Write: WS	22
3-2	Set Point Read: RS	23
3-3	Measured Temperature Read: RX	24
3-4	Output Value Read: RO	26
3-5	Proportional Band Write: WB	27
3-6	Proportional Band Read: RB	28
3-7	Integral Time Write: WN	28
3-8	Integral Time Read: RN	29
3-9	Derivative Time Write: WV	30
3-10	Derivative Time Read: RV	31
3-11	Control Period Write: WT	32
3-12	Control Period Read: RT	33
3-13	Output Operation (Normal/Reverse) Write: WU	34
3-14	Output Operation (Normal/Reverse) Read: RU	35
3-15	Alarm Mode Write: W#	36
3-16	Alarm Mode Read: R#	38
3-17	Alarm Temperature Write: W%	39
3-18	Alarm Temperature Read: R%	40
3-19	Memory Bank Designation Write: WM	41
3-20	Memory Bank Designation Read: RM	42
3-21	Hysteresis Write: WH	43
3-22	Hysteresis Read: RH	44
3-23	Status Read: RX	45
3-24	Error Read: RU	48

### 3-1 Set Point Write: WS

#### Function

This command is used to write the set point required for temperature control to a control point.

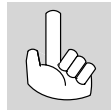

1. Setting Unit Write (Wt) must be used to set the temperature setting unit of a control point to 1 or 0.1.
2. Set Point Write (WS) cannot be used at the designated control point being auto-tuned.
3. The possible setting data range will be -1,999 to 9,999 if the E5ZD-SDL Setting Display Unit is used with the E5ZE after pin number 4 of the FUNCTION switch is set to ON and the temperature setting unit is set to 0.1.

#### Setting Data Range

Setting unit		1		0.1	
°C or °F		°C	°F	°C	°F
Default		0000		00000	
Setting Data	K	-200 to 1300	-300 to 2300	-2000 to 13000	-3000 to 23000
	J	-100 to 0850	-100 to 1500	-1000 to 08500	-1000 to 15000
	R	0000 to 1700	0000 to 3000	00000 to 17000	00000 to 30000
	S	0000 to 1700	0000 to 3000	00000 to 17000	00000 to 30000
	T	-200 to 0400	-300 to 0700	-2000 to 04000	-3000 to 07000
	E	0000 to 0600	0000 to 1100	00000 to 06000	00000 to 11000
	B	0100 to 1800	0300 to 3000	01000 to 18000	03000 to 30000
	N	0000 to 1300	0000 to 2300	00000 to 13000	00000 to 23000
	L	-100 to 0850	-100 to 1500	-1000 to 08500	-1000 to 15000
	U	-200 to 0400	-300 to 0700	-2000 to 04000	-3000 to 07000
	W/Re5-26	0000 to 2300	0032 to 4100	00000 to 23000	00320 to 41000
	PL-II	0000 to 1300	0000 to 2300	00000 to 13000	00000 to 23000
	Pt100	-100 to 0500	-100 to 0900	-1000 to 05000	-1000 to 09000
JPt100	-100 to 0500	-100 to 0900	-1000 to 05000	-1000 to 09000	

#### Command

When Setting Unit is 1

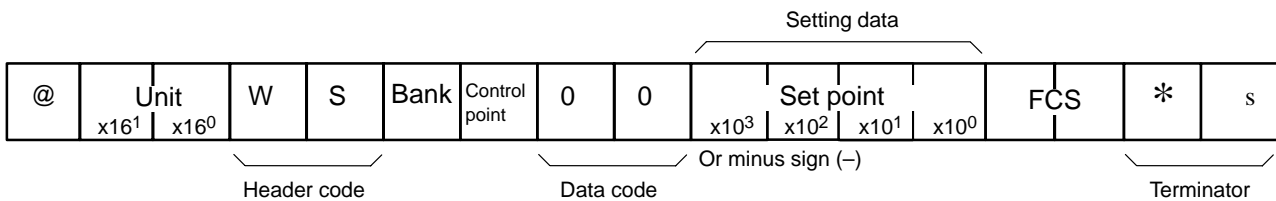

When Setting Unit is 0.1

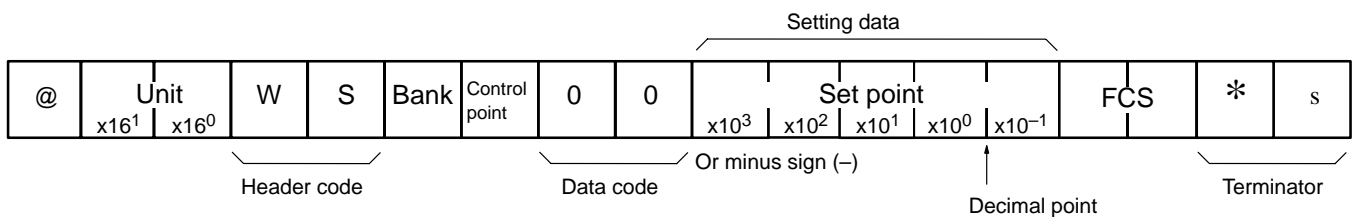

**Response**

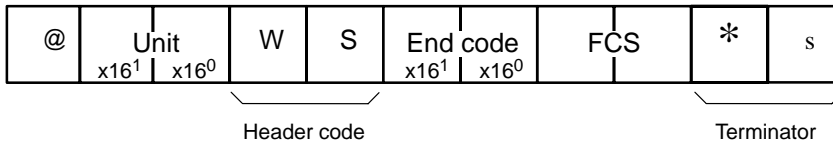

**Communications Example**

In this example, the E5ZE is operated with Set Point Write (WS) under the following conditions.

- Unit no.: 1
- Memory Bank no.: 2
- Control Point: 3
- Setting Unit: 0.1
- Set Point: -100.0°C

**Command**

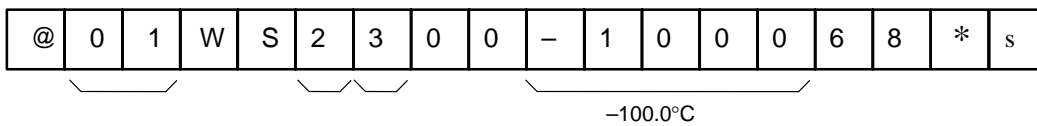

**Response**

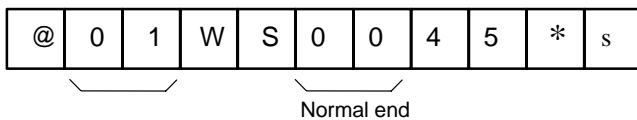

**3-2 Set Point Read: RS**

**Function**

This command is used to read the set points that have been set at a control point.

**Command**

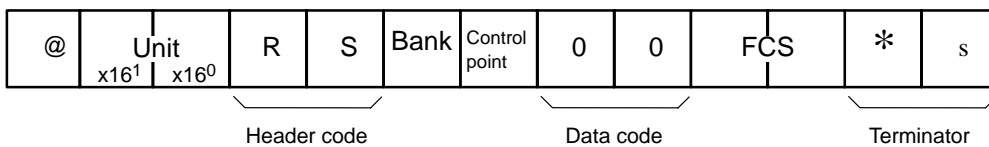

**Response**

When Setting Unit is 1

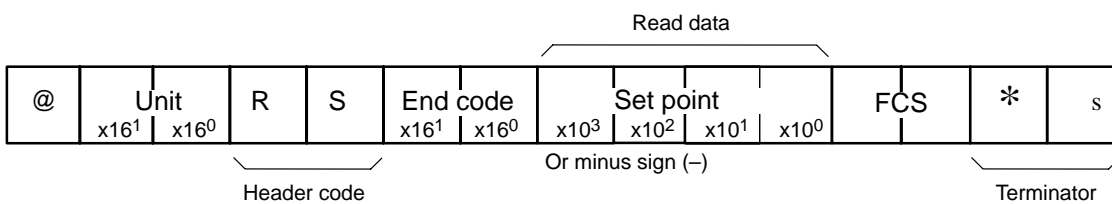

When Setting Unit is 0.1

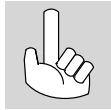
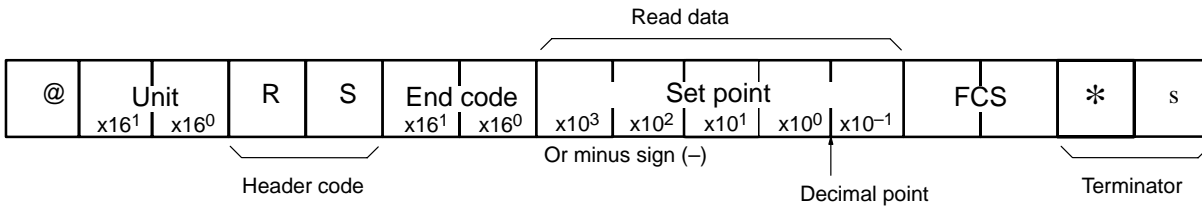

1. The response block for Set Point Read (RS) does not include read data if the end code of the response block is other than 00.
2. Refer to 2-4 End Codes.

**Communications Example**

In this example, the E5ZE is operated with Set Point Read (RS) under the following conditions.

Unit no.: 1  
 Memory Bank no.: 2  
 Control Point: 3  
 Setting Unit: 0.1  
 Set Point: -100.0°C

**Command**



**Response**

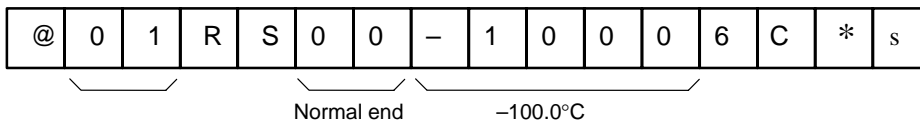

### 3-3 Measured Temperature Read: RX

**Function**

This command is used to read the temperature being measured at a control point.

**Command**

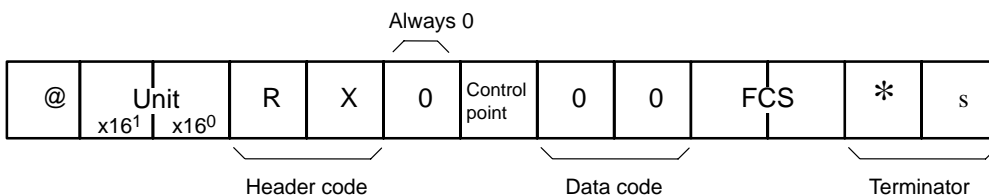

**Response**

When Process Value Unit is 1

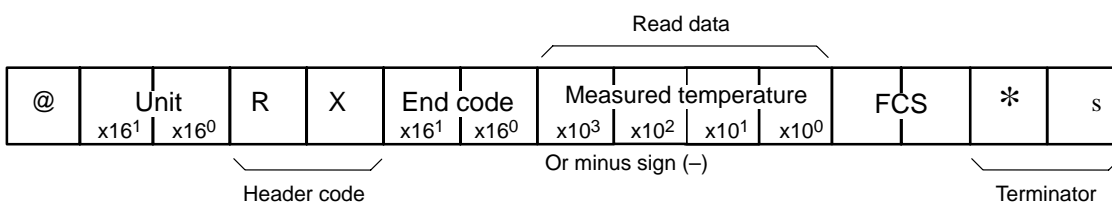

When Process Value Unit Set is 0.1

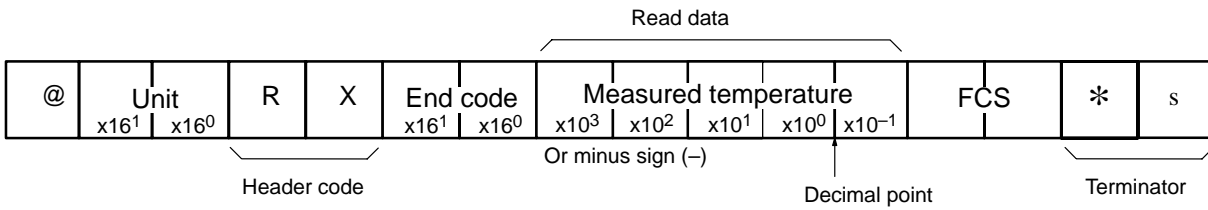

Response Block with Error Detected

The response block for Measured Temperature Read (RS) will include an error code if an error is detected by the E5ZE while the E5ZE is processing the command.

When Process Value Unit is 1

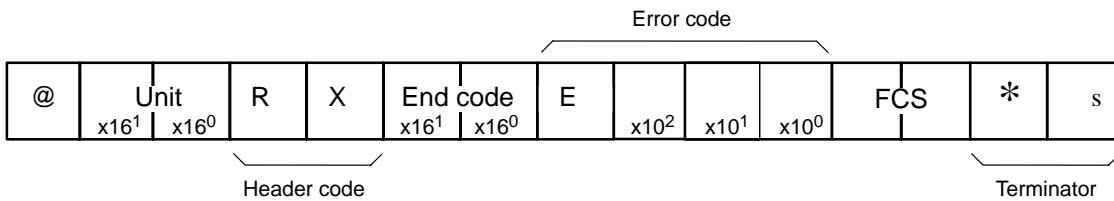

When Process Value Unit Set is 0.1

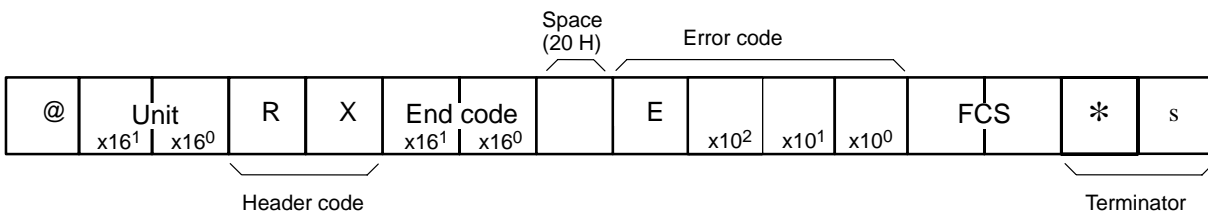

1. The response block for Measured Temperature Read (RX) does not include read data or an error code if the end code of the response block is other than 00.
2. Refer to 2-4 End Codes.
3. Refer to 2-5 Error Codes.

Communications Example

In this example, the E5ZE is operated with Measured Temperature Read (RX) under the following conditions.

Unit no.: 1  
 Control Point: 3  
 Process Value Unit: 1  
 Measured Temperature: 500°C

Command

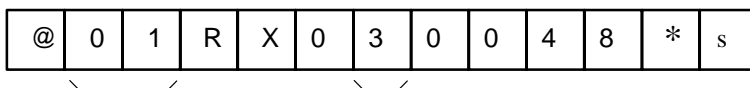

Response

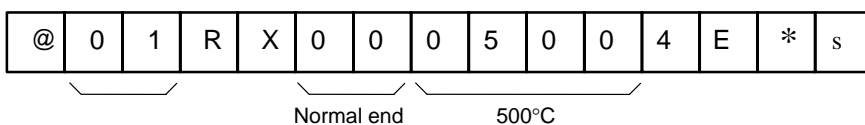



### 3-4 Output Value Read: RO

#### Function

This command is used to read the percentage of control output that has been set at a control point.

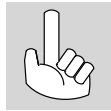

The percentage of the cooling-side output that has been set at a control point can be read provided that the E5ZE is a heating and cooling control model.

#### Command

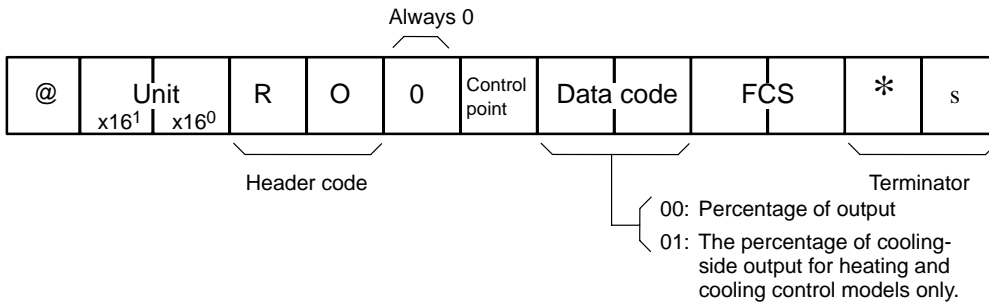

#### Response

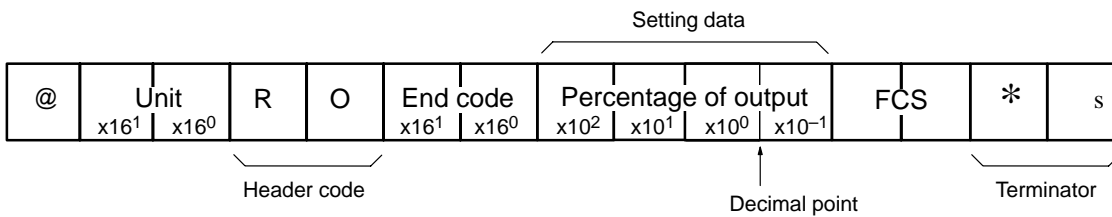

1. The response block for Output Value Read (RO) does not include read data if the end code of the response block is other than 00.
2. Refer to 2-4 End Codes.

#### Communications Example

In this example, the E5ZE is operated with Output Value Read (RO) under the following conditions.

Unit no.: 1  
 Control point: 3  
 Percentage of output: 50.0%

#### Command

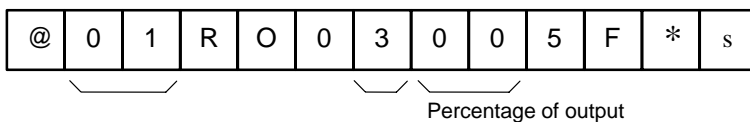

#### Response

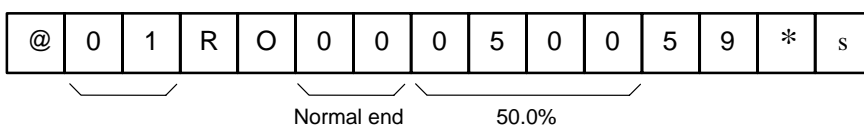

### 3-5 Proportional Band Write: WB

#### Function

This command is used to write proportional bands to a control point.

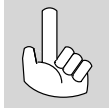

Proportional Band Write (WB) cannot be used at a control point being auto-tuned.

#### Setting Data Range

Setting unit	0.1	
°C or °F	°C	°F
Default	0000	
Setting data	0000 to 9999	



If the constant P of a control point set to 0000 is used for temperature control with the E5ZE, the E5ZE will be in ON/OFF control operation at the control point.

#### Command

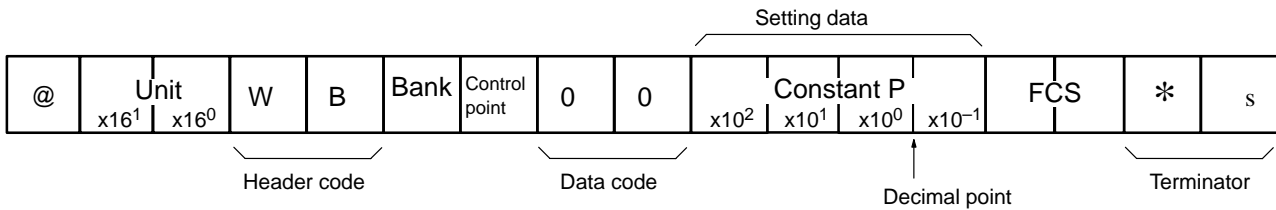

#### Response

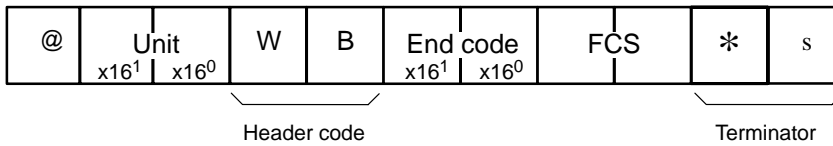

#### Communications Example

In this example, the E5ZE is operated with Proportional Band Write (WB) under the following conditions.

- Unit no.: 1
- Memory Bank no.: 2
- Control Point: 3
- Proportional Band: 40.0°C

#### Command

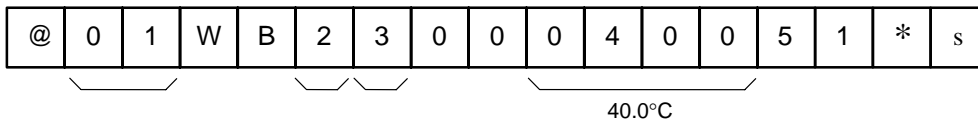

#### Response

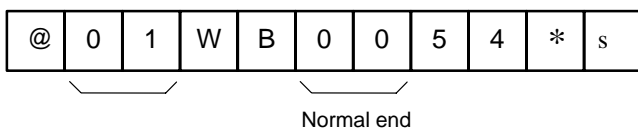

### 3-6 Proportional Band Read: RB

**Function**

This command is used to read the proportional bands that have been set at a control point.

**Command**

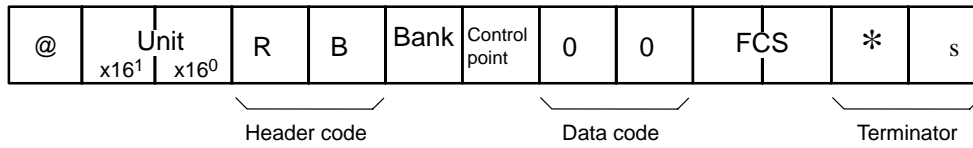

**Response**

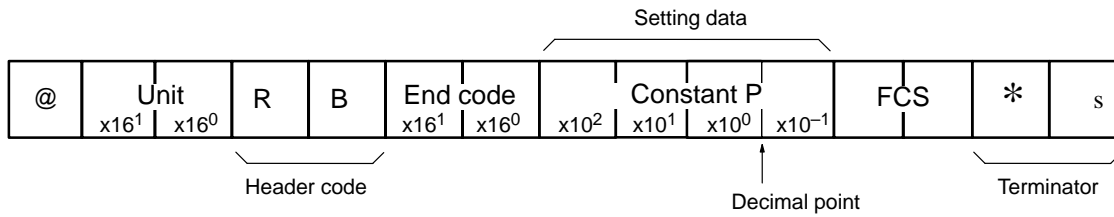

1. The response block for Proportional Band Read (RB) does not include read data if the end code of the response block is other than 00.
2. Refer to 2-4 End Codes.

**Communications Example**

In this example, the E5ZE is operated with Proportional Band Read (RB) under the following conditions.

Unit no.: 1  
 Memory Bank no.: 2  
 Control Point: 3  
 Proportional Band: 40.0°C

**Command**

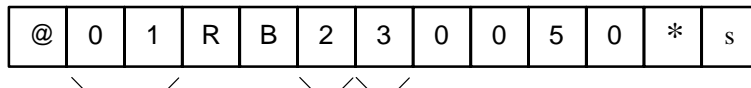

**Response**

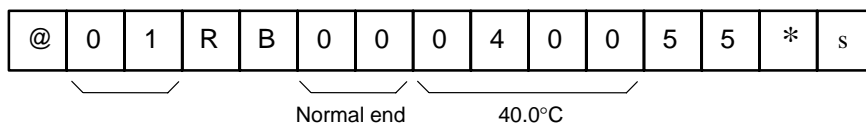

### 3-7 Integral Time Write: WN

**Function**

This command is used to write the integral time to a control point.

Integral Time Write (WN) cannot be used at a control point being auto-tuned.



**Setting Data Range**

Setting unit	1
Setting time unit	s
Default	0000
Setting data	0000 to 3999



If the constant I of a control point set to 0000 is used for temperature control with the E5ZE, the E5ZE will not be in integral operation at the control point.

**Command**

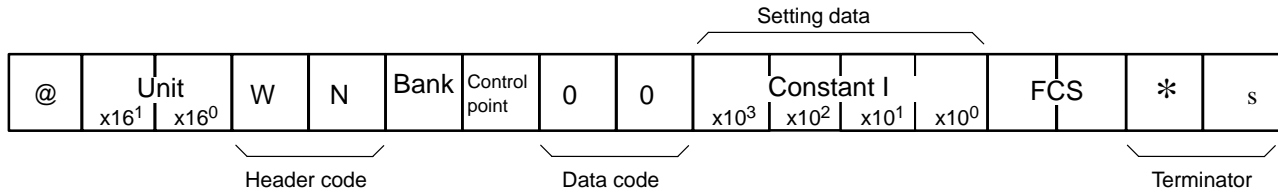

**Response**

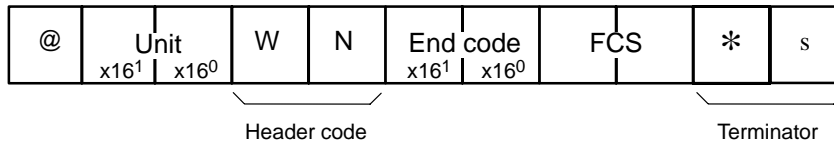

**Communications Example**

In this example, the E5ZE is operated with Integral Time Write (WN) under the following conditions.

- Unit no.: 1
- Memory Bank no.: 2
- Control Point: 3
- Integral Time: 50 s

**Command**

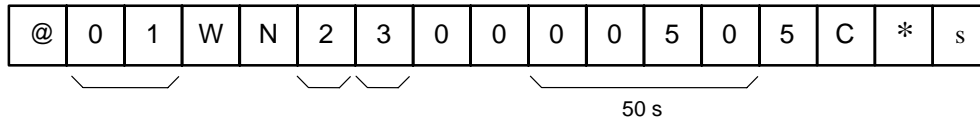

**Response**

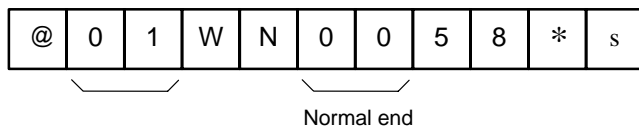

**3-8 Integral Time Read: RN**

**Function**

This command is used to read the integral time that have been set at a control point.

**Command**

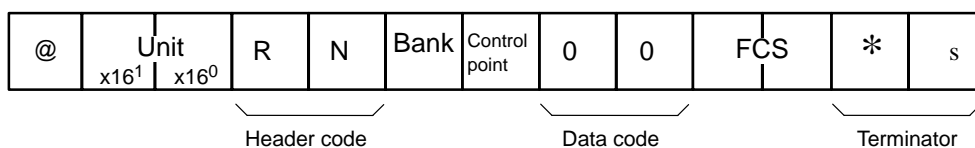

**Response**

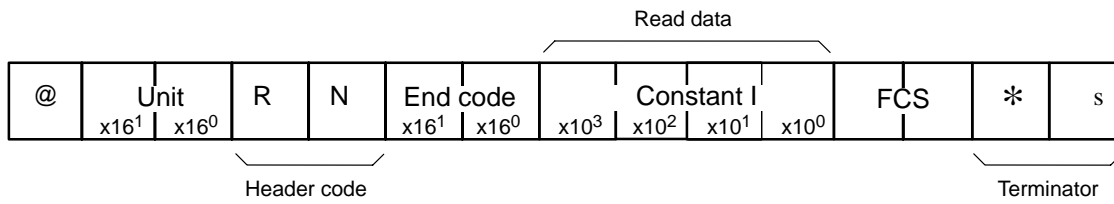

1. The response block for Integral Time Read (RN) does not include read data if the end code of the response block is other than 00.
2. Refer to 2-4 End Codes.

**Communications Example**

In this example, the E5ZE is operated with Integral Time Read (RN) under the following conditions.

Unit no.: 1  
 Memory Bank no.: 2  
 Control Point: 3  
 Integral Time: 50 s

**Command**

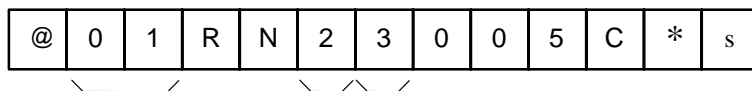

**Response**

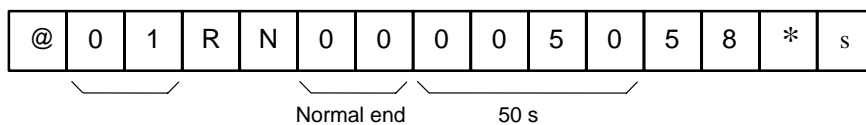

**3-9 Derivative Time Write: WV**

**Function**

This command is used to write the derivative time to a control point.

Derivative Time Write (WV) cannot be used at a control point being auto-tuned.



**Setting Data Range**

Setting unit	1
Setting time unit	s
Default	0000
Setting data	0000 to 3999



If the constant D of a control point set to 0000 is used for temperature control with the E5ZE, the E5ZE will not be in derivative operation at the control point.

**Command**

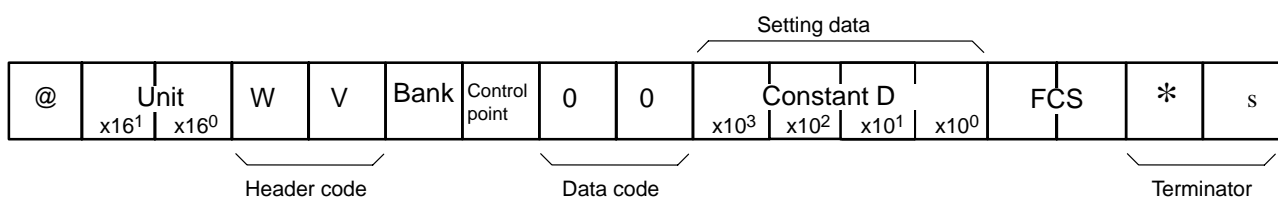

**Response**

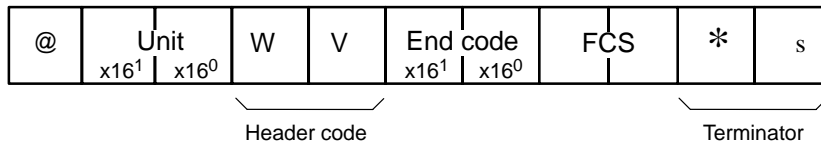

**Communications Example**

In this example, the E5ZE is operated with Derivative Time Write (WV) under the following conditions.

Unit no.: 1  
 Memory Bank no.: 2  
 Control Point: 3  
 Derivative Time: 10 s

**Command**

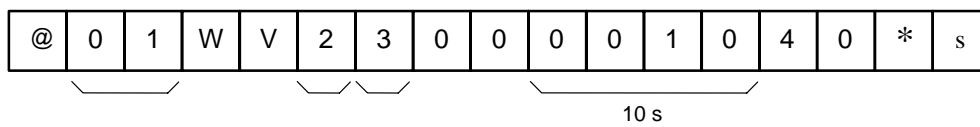

**Response**

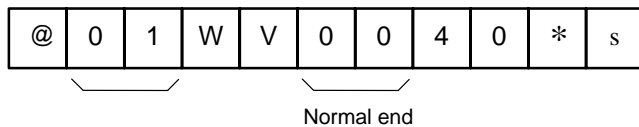

**3-10 Derivative Time Read: RV**

**Function**

This command is used to read the derivative time that have been set at a control point.

**Command**

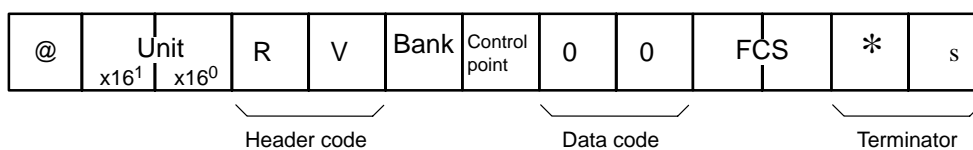

**Response**

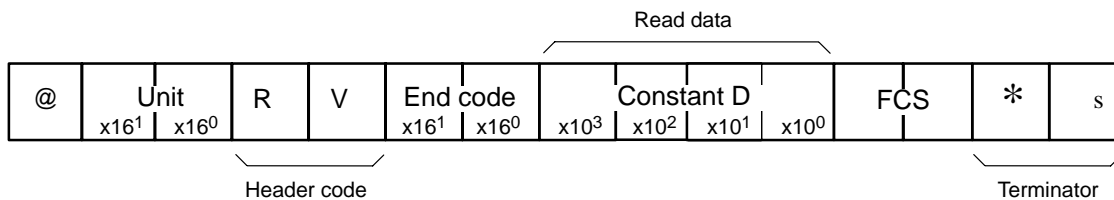

1. The response block for Derivative Time Read (RV) does not include read data if the end code of the response block is other than 00.
2. Refer to 2-4 End Codes.

**Communications Example**

In this example, the E5ZE is operated with Derivative Time Read (RV) under the following conditions.

Unit no.: 1  
 Memory Bank no.: 2  
 Control Point: 3  
 Derivative Time: 10 s

**Command**

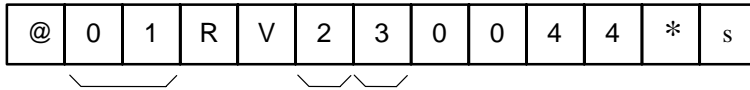

**Response**

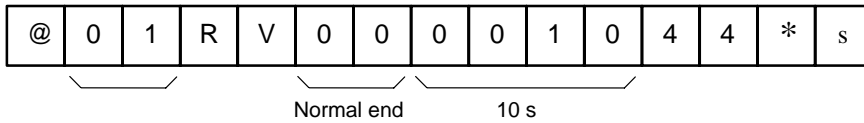

**3-11 Control Period Write: WT**

**Function**

This command is used to write the control period to a control point.



The Control Period Write (WT) cannot be used at a control point being auto-tuned.

Cooling-side control period can be written to a control point provided that the E5ZE is a heating and cooling control model.

**Setting Data Range**

<b>Setting unit</b>	1
<b>Setting time unit</b>	s
<b>Default</b>	0002
<b>Setting data</b>	0001 to 0099

**Command**

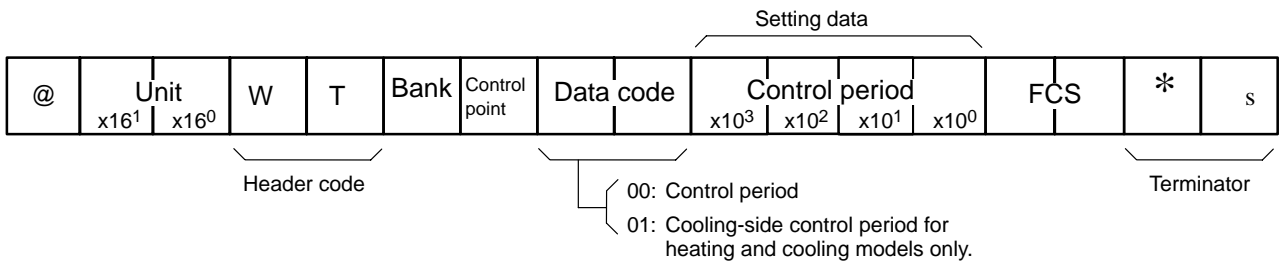

**Response**

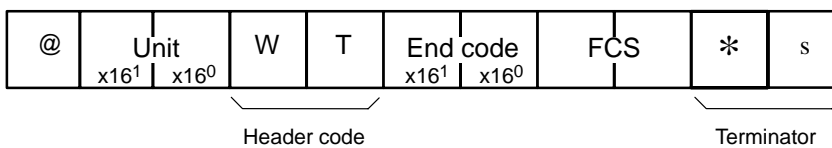

**Communications Example**

In this example, the E5ZE is operated with Control Period Write (WT) under the following conditions.

Unit no.: 1  
 Memory Bank no.: 2  
 Control Point: 3  
 Control Period: 5 s

**Command**

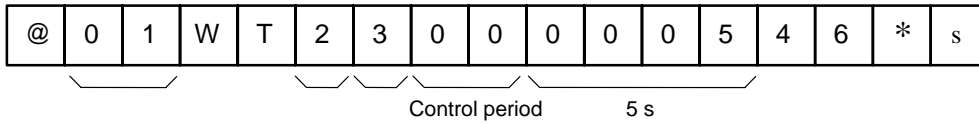

**Response**

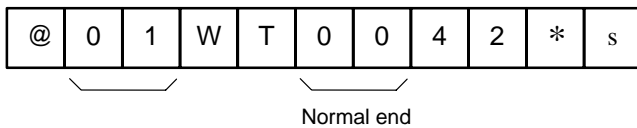

## 3-12 Control Period Read: RT

**Function**

This command is used to read the control period that have been set at a control point.



The cooling-side control period that have been set at a control point can be read provided that the E5ZE is a heating and cooling control model.

**Command**

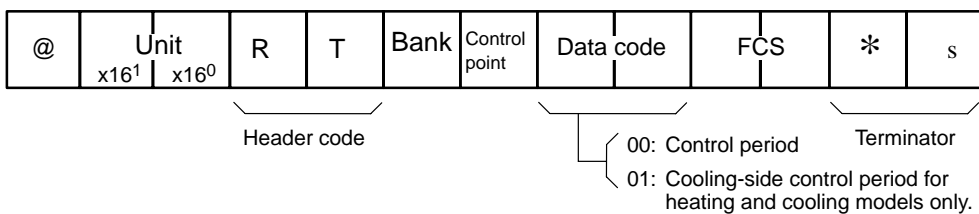

**Response**

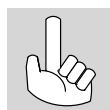
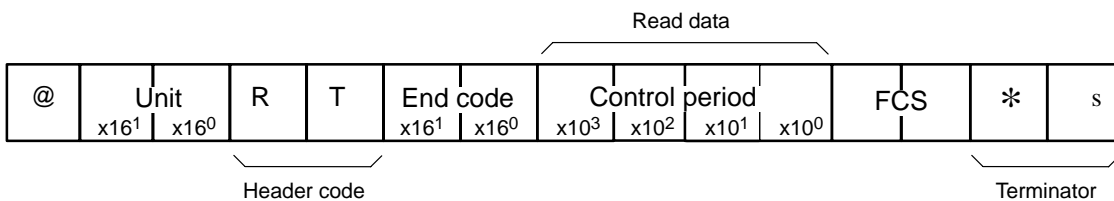

1. The response block for Control Period Read (RT) does not include read data if the end code of the response block is other than 00.
2. Refer to 2-4 End Codes.



**Communications Example**

In this example, the E5ZE is operated with Control Period Read (RT) under the following conditions.

Unit no.: 1  
 Memory Bank no.: 2  
 Control Point: 3  
 Control Period: 5 s

**Command**

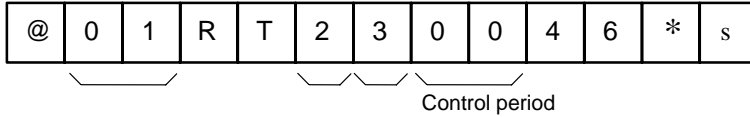

**Response**

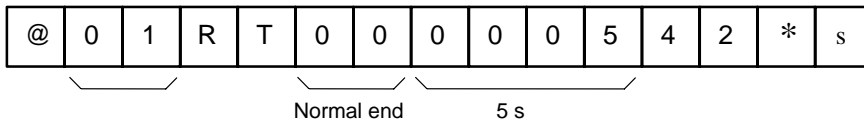

### 3-13 Output Operation (Normal/Reverse) Write: WU

**Function**

This command is used to designate the normal or reverse operation of a control point.



1. Output Operation Write (WU) enables the E5ZE in heating and cooling control operation to change its heating-side control to cooling-side control and vice versa at a control point simultaneously.
2. Output Operation Write (WU) cannot be used at a control point in manual operation, control operation or auto-tuning operation.

**Setting Data Range**

<b>Default</b>	0000 (All control points in reverse operation)
<b>Setting code</b>	00 to FF

**Command**

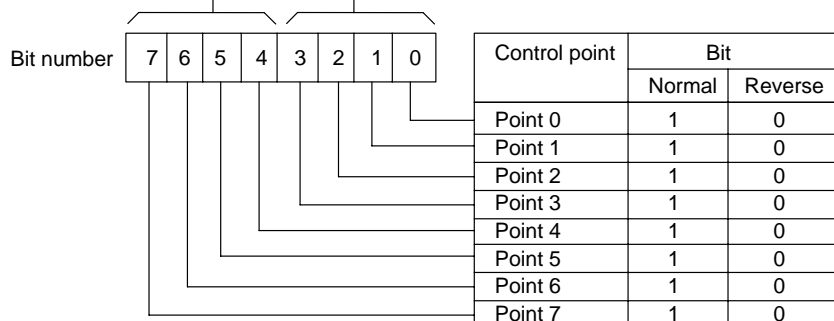
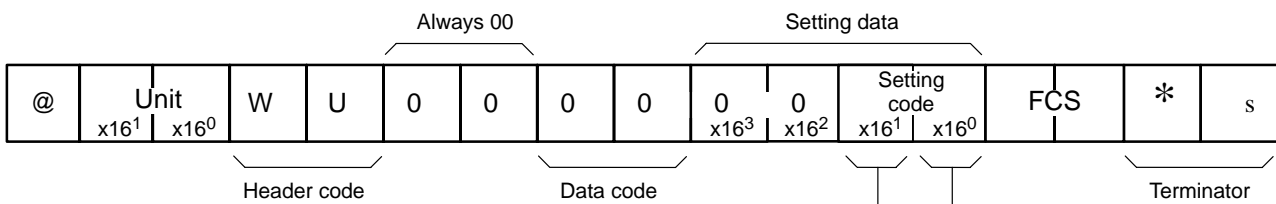

**Response**

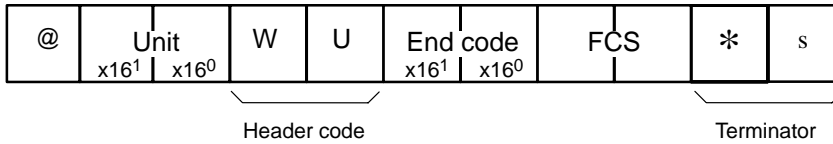

**Communications Example**

In this example, the E5ZE is operated with Output Operation Write (WU) under the following conditions.

- Unit no.: 1
- Control Points 0, 2, 4, and 6: Normal operation
- Control Points 1, 3, 5, and 7: Reverse operation

**Command**

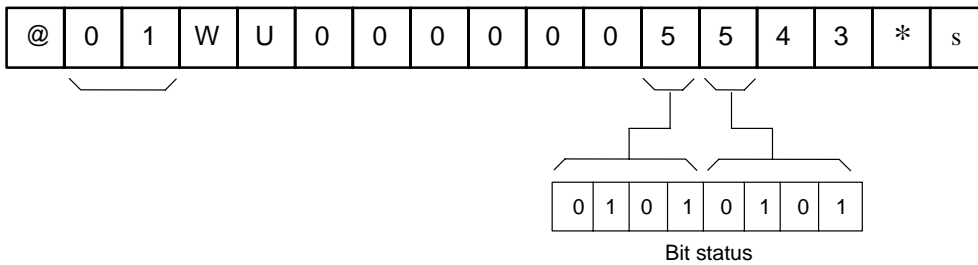

**Response**

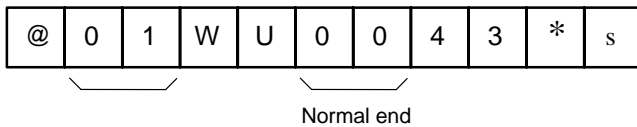

### 3-14 Output Operation (Normal/Reverse) Read: RU

**Function**

This command is used to read the output operation that has been set at a control point.

**Command**

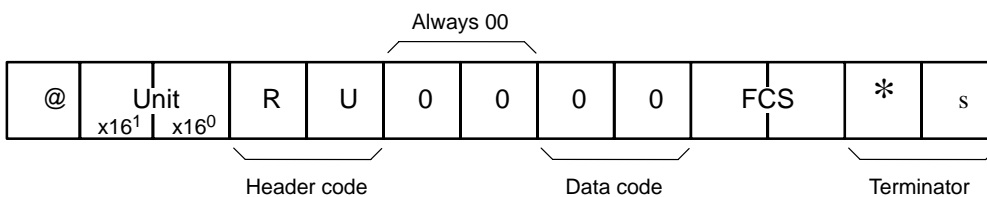

**Response**

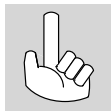
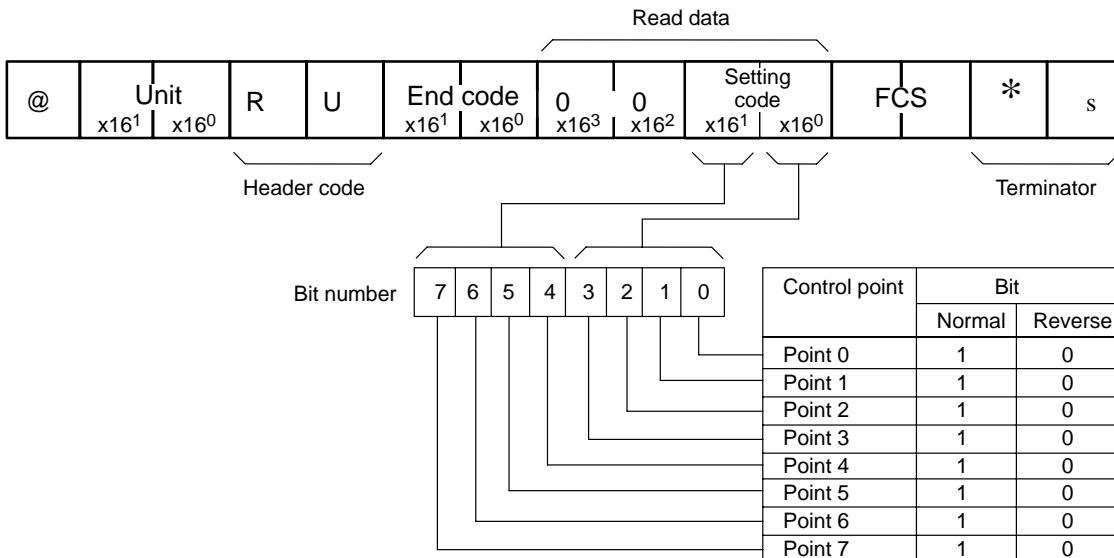

1. The response block for Output Operation Read (RU) does not include read data if the end code of the response block is other than 00.
2. Refer to 2-4 End Codes.

**Communications Example**

In this example, the E5ZE is operated with Output Operation Read (RU) under the following conditions

- Unit no.: 1
- Control Points 0, 2, 4, and 6: Normal operation
- Control Points 1, 3, 5, and 7: Reverse operation.

**Command**

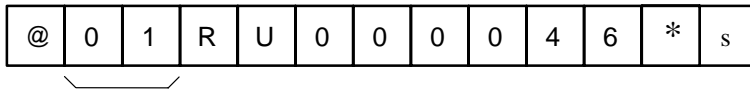

**Response**

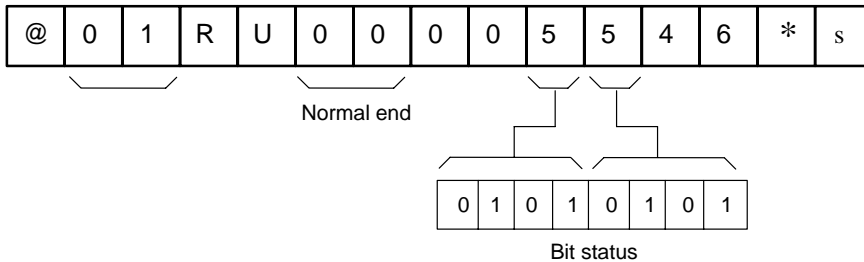

**3-15 Alarm Mode Write: W#**

**Function**

This command is used to designate the alarm mode of alarm 1 or 2 of a control point.

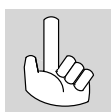

1. Alarm Mode Write (W#) cannot be used at a control point in manual operation, control operation or auto-tuning operation.
2. If the temperature control or manual operation at a control point is interrupted, all the alarm output of the control point will be OFF.

**Setting Data Range**

Alarm		Alarm 1	Alarm 2
Default		00	
Setting code	Alarm OFF	00	
	Upper- and lower-limit alarm	01	
	Upper-limit alarm	02	
	Lower-limit alarm	03	
	Upper- and lower-limit range alarm	04	
	Upper- and lower-limit alarm with standby sequence	05	
	Upper-limit alarm with standby sequence	06	
	Lower-limit alarm with standby sequence	07	
	Absolute-value upper-limit alarm	08	
	Absolute-value lower-limit alarm	09	
	Absolute-value upper-limit alarm with standby sequence	0A	
	Absolute-value lower-limit alarm with standby sequence	0B	
	HB and HS alarm	0C	

**Command**

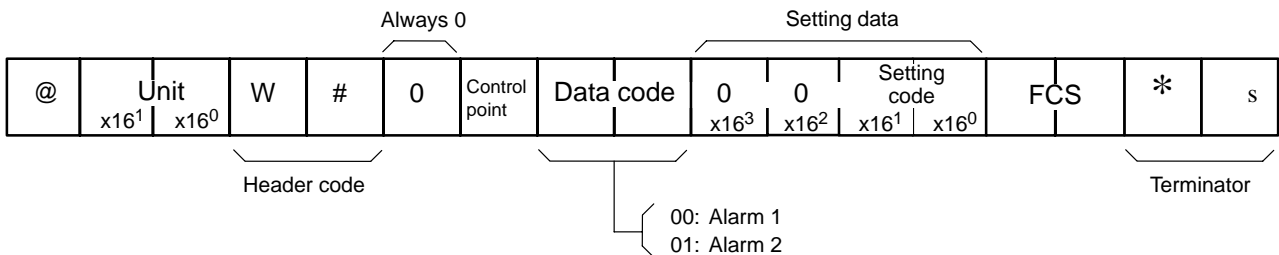

**Response**

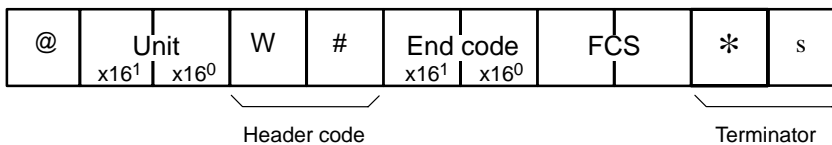

**Communications Example**

In this example, the E5ZE is operated with Alarm Mode Write (W#) under the following conditions.

- Unit no.: 1
- Control Point: 3
- Alarm 1 Mode: Upper-limit alarm

**Command**

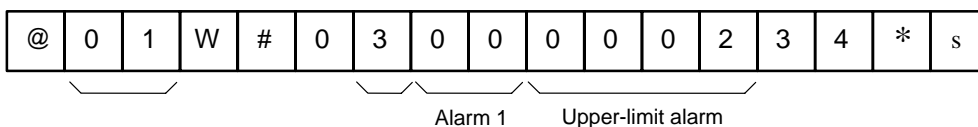

**Response**

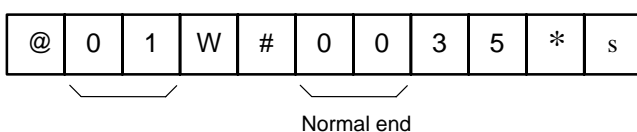

### 3-16 Alarm Mode Read: R#

**Function**

This command is used to read the alarm mode that has been set at a control point.

**Command**

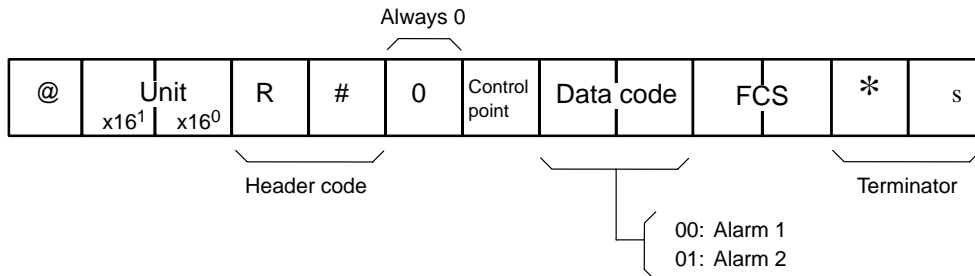

**Response**

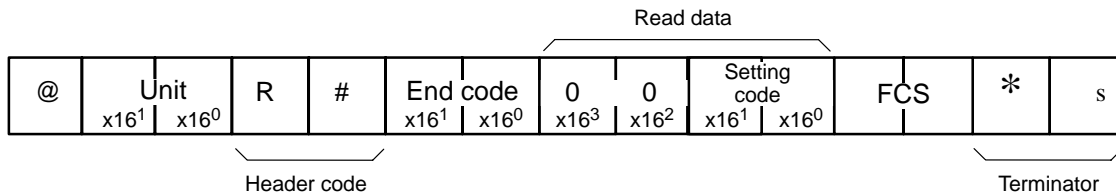

1. Refer to 3-15 Alarm Mode Write: W# for the setting code range of the response format.
2. The response block for Alarm Mode Read (R#) does not include read data if the end code of the response block is other than 00.
3. Refer to 2-4 End Codes.

**Communications Example**

In this example, the E5ZE is operated with Alarm Mode Read (R#) under the following conditions.

Unit no.: 1  
 Control Point: 3  
 Alarm 1 Mode: Upper-limit alarm

**Command**

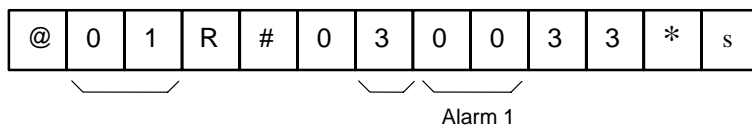

**Response**

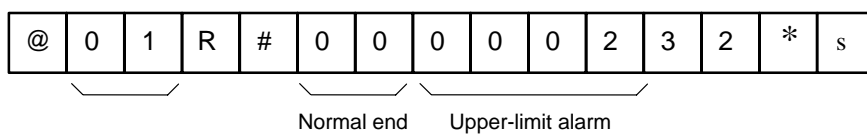

### 3-17 Alarm Temperature Write: W%

#### Function

This command is used to set the alarm temperatures for alarm 1 or 2 of a control point.

#### Setting Data Range

Setting unit		1		0.1	
°C or °F		°C	°F	°C	°F
Default		0000		00000	
Parameters	Alarm OFF	-999 to 9999		-9999 to 99999	
	Upper- and lower-limit alarm	0000 to 9999		00000 to 99999	
	Upper-limit alarm	-999 to 9999		-9999 to 99999	
	Lower-limit alarm	-999 to 9999		-9999 to 99999	
	Upper- and lower-limit range alarm	0000 to 9999		00000 to 99999	
	Upper- and lower-limit alarm with standby sequence	0000 to 9999		00000 to 99999	
	Upper-limit alarm with standby sequence	-999 to 9999		-9999 to 99999	
	Lower-limit alarm with standby sequence	-999 to 9999		-9999 to 99999	
	Absolute-value upper-limit alarm	-999 to 9999		-9999 to 99999	
	Absolute-value lower-limit alarm	-999 to 9999		-9999 to 99999	
	Absolute-value upper-limit alarm with standby sequence	-999 to 9999		-9999 to 99999	
	Absolute-value lower-limit alarm with standby sequence	-999 to 9999		-9999 to 99999	
	HB and HS alarm	---		---	



1. Setting Unit Write (Wt) must be used to set the temperature setting unit of a control point to 1 or 0.1.
2. It is unnecessary to set an alarm temperature if HB and HS alarm data is used as the parameters for Alarm Temperature Write (W%).

#### Command

##### When Setting Unit is 1

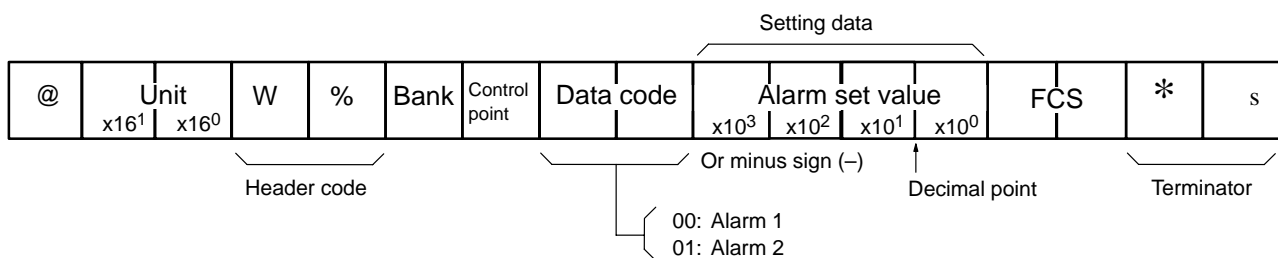

##### When Setting Unit is 0.1

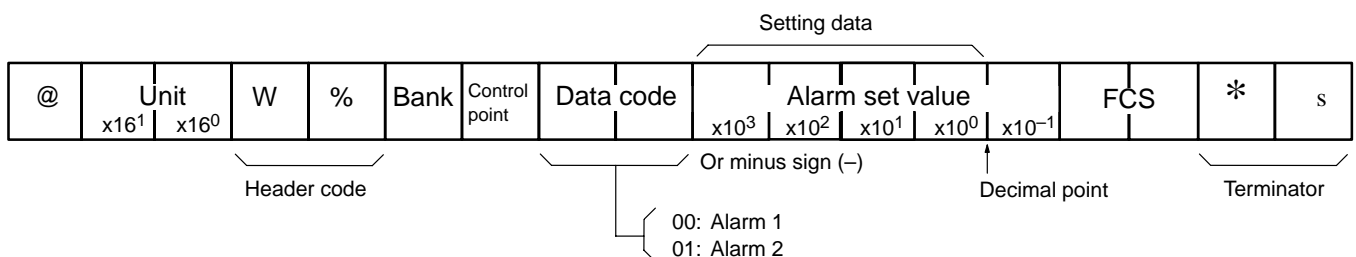

**Response**

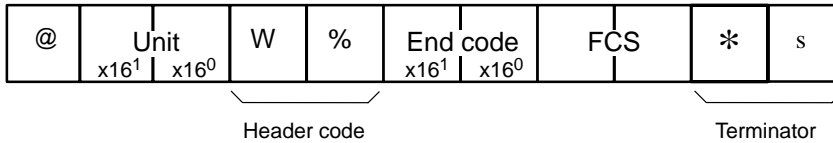

**Communications Example**

In this example, the E5ZE is operated with Alarm Temperature Write (W%) under the following conditions.

- Unit no.: 1
- Memory Bank no.: 2
- Control Point: 3
- Setting Unit: 1
- Alarm 1 Temperature: 50°C

**Command**

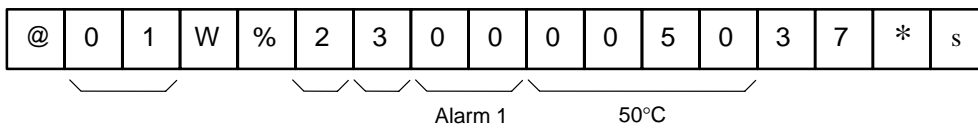

**Response**

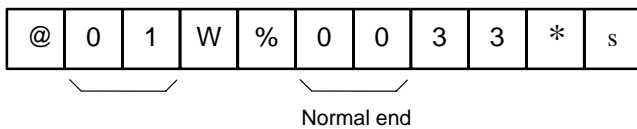

### 3-18 Alarm Temperature Read: R%

**Function**

This command is used to read the alarm temperatures that have been set at a control point.

**Command**

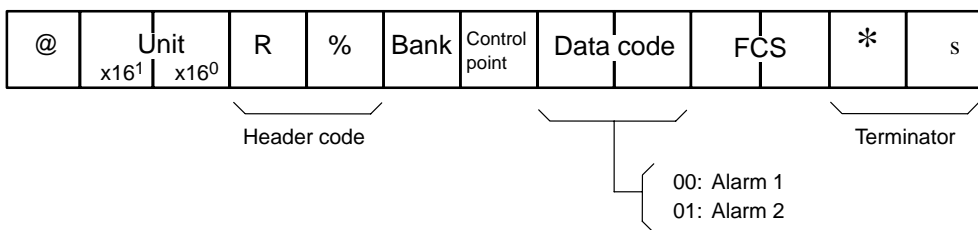

**Response**

When Setting Unit is 1

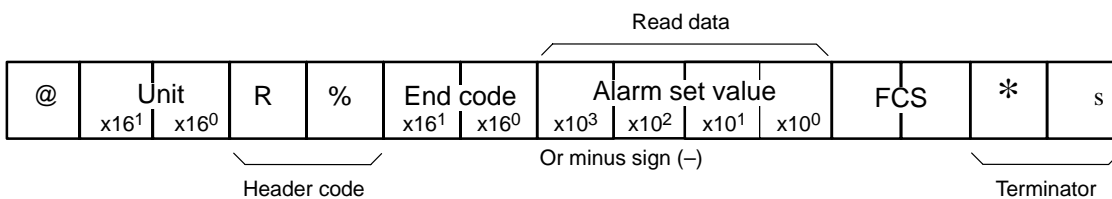

When Setting Unit is 0.1

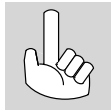
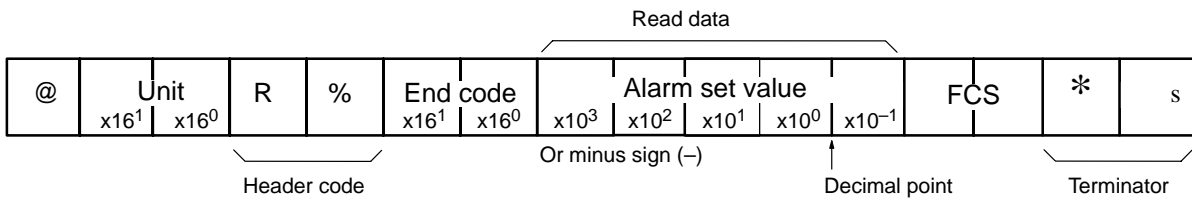

1. The response block for Alarm Temperature Read (R%) does not include read data if the end code of the response block is other than 00.
2. Refer to 2-4 End Codes.

Communications Example

In this example, the E5ZE is operated with Alarm Temperature Read (R%) under the following conditions.

- Unit no.: 1
- Memory Bank no.: 2
- Control Point: 3
- Setting Unit: 1
- Alarm 1 Temperature: 50°C

Command

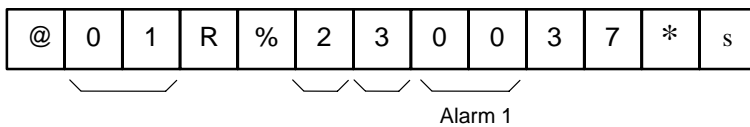

Response

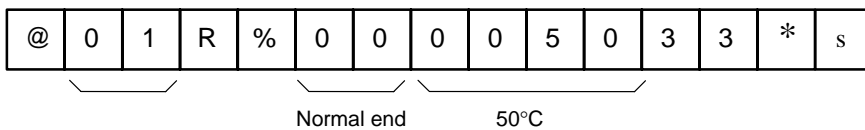

### 3-19 Memory Bank Designation Write: WM

Function

This command is used to designate the memory banks at a control point that are used for temperature control.



1. Memory Bank Designation Write (WM) cannot be used if the memory bank designation method is set to contact input designation.
2. Memory Bank Designation Write (WM) cannot be used at a control point being auto-tuned.
3. When the E5ZE is turned ON, the memory bank numbers previously selected through communications will be effective.

Setting Data Range

Default	0000 for all control points
Setting data	0000 to 0007

Command

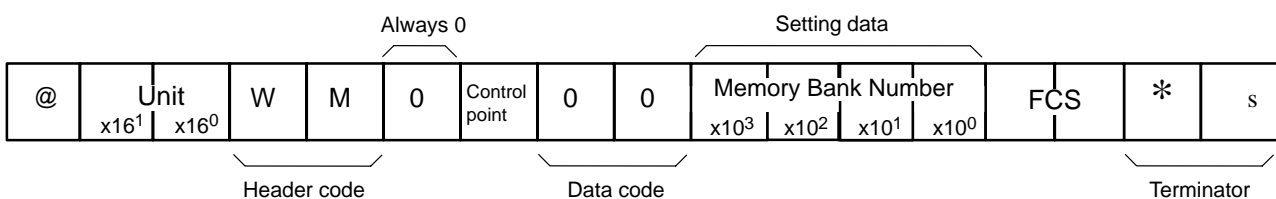



**Response**

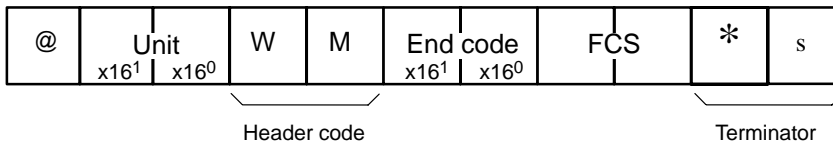

**Communications Example**

In this example, the E5ZE is operated with Memory Bank Designation Write (WM) under the following conditions.

Unit no.: 1  
Control Point: 3  
Memory Bank no.: 2

**Command**

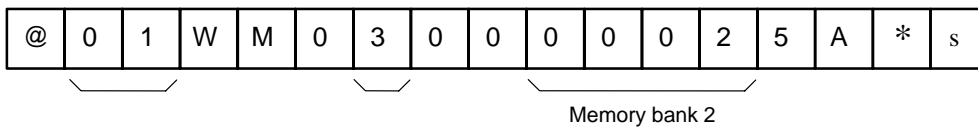

**Response**

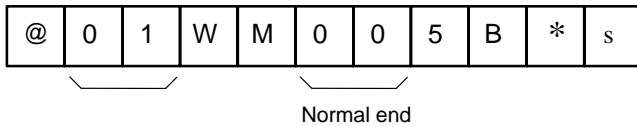

## 3-20 Memory Bank Designation Read: RM

**Function**

This command is used to read the memory banks that have been set at a control point.

**Command**

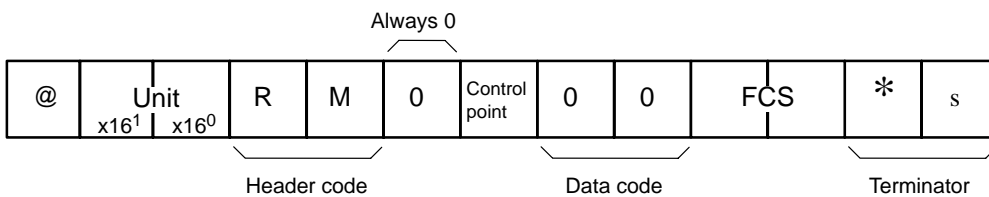

**Response**

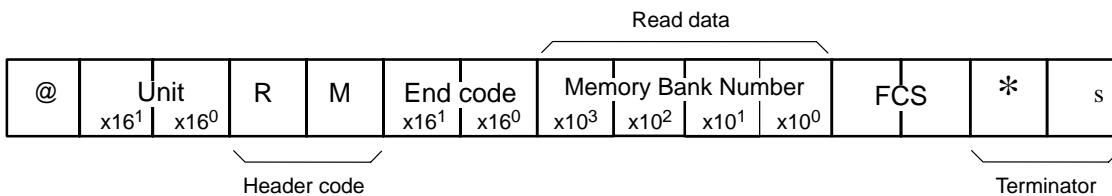

1. The response block for Memory Bank Designation Read (RM) does not include read data if the end code of the response block is other than 00.
2. Refer to 2-4 End Codes.

**Communications Example**

In this example, the E5ZE is operated with Memory Bank Designation Read (RM) under the following conditions.

Unit no.: 1  
 Control Point: 3  
 Memory Bank no.: 2

**Command**

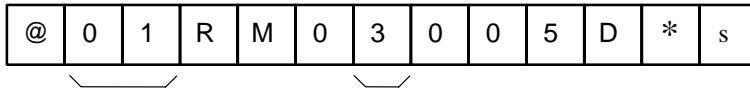

**Response**

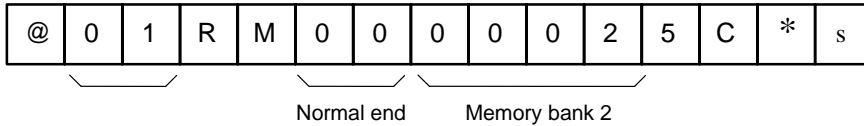

**3-21 Hysteresis Write: WH**

**Function**

This command is used to set the hysteresis of control outputs of a control point in ON/OFF operation.



1. Hysteresis Write (WH) cannot be used at a control point being auto-tuned.
2. Hysteresis Write (WH) is invalid if it is used for the E5ZE for advanced PID control.
3. The hysteresis of the cooling-side control outputs can be set provided that the E5ZE is a heating and cooling control model.

**Setting Data Range**

<b>Setting unit</b>	0.1	
<b>°C or °F</b>	°C	°F
<b>Default</b>	0008	0015
<b>Setting data</b>	0000 to 0999	

**Command**

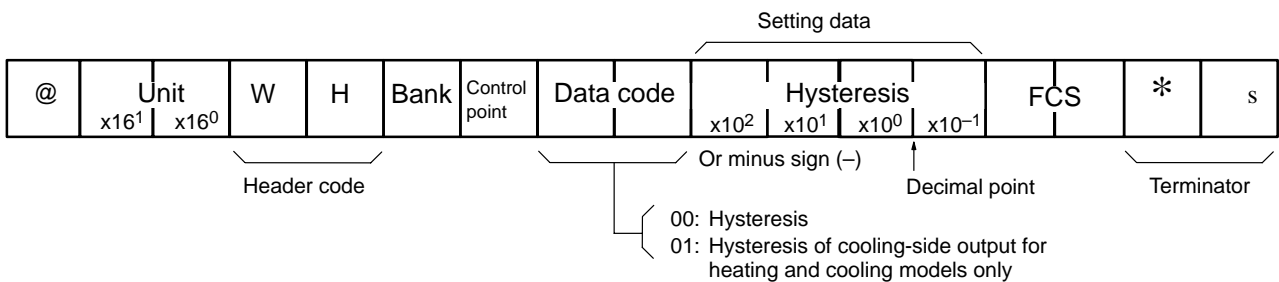

**Response**

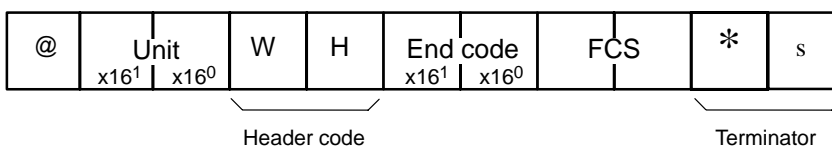

**Communications Example**

In this example, the E5ZE is operated with Hysteresis Write (WH) under the following conditions.

Unit no.: 1  
 Memory Bank no.: 2  
 Control Point: 3  
 Hysteresis: 1.5°C

**Command**

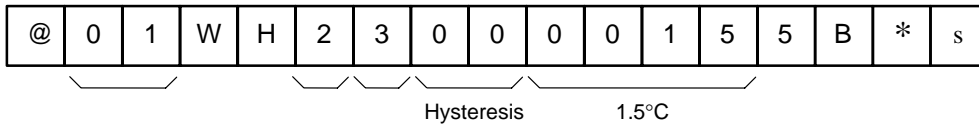

**Response**

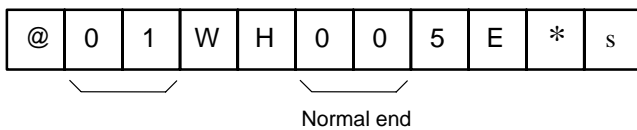

### 3-22 Hysteresis Read: RH

**Function**

This command is used to read the hysteresis of control outputs that have been set at a control point.



The hysteresis of the cooling-side control outputs can be read provided that the E5ZE is a heating and cooling control model.

**Command**

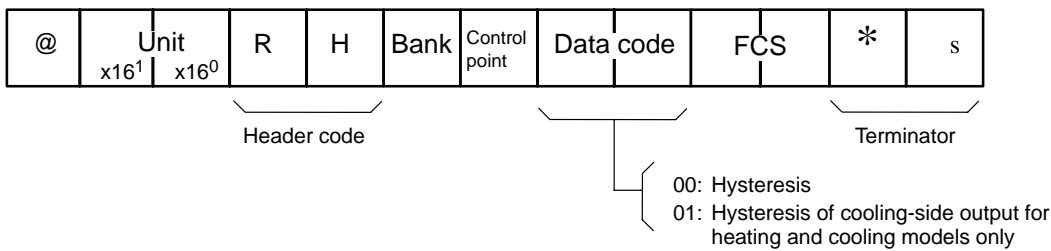

**Response**

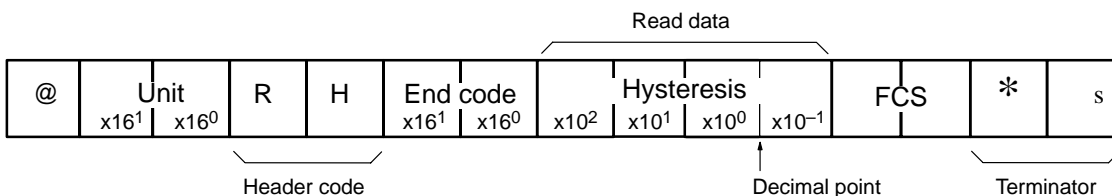

1. The response block for Hysteresis Read (RH) does not include read data if the end code of the response block is other than 00.
2. Refer to 2-4 End Codes.

**Communications Example**

In this example, the E5ZE is operated with Hysteresis Read (RH) under the following conditions.

- Unit no.: 1
- Memory Bank no.: 2
- Control Point: 3
- Hysteresis: 1.5°C

**Command**

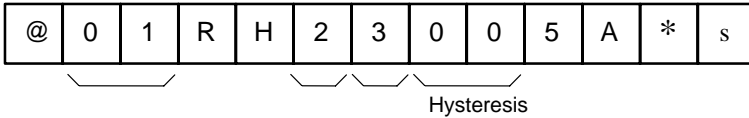

**Response**

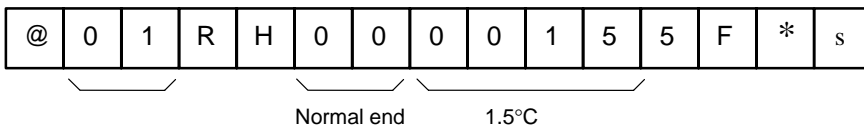

**3-23 Status Read: RX**

**Function**

This command is used to read the operating status.

**Command**

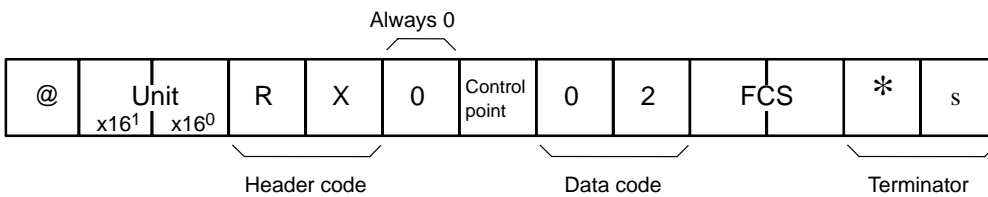

**Response**

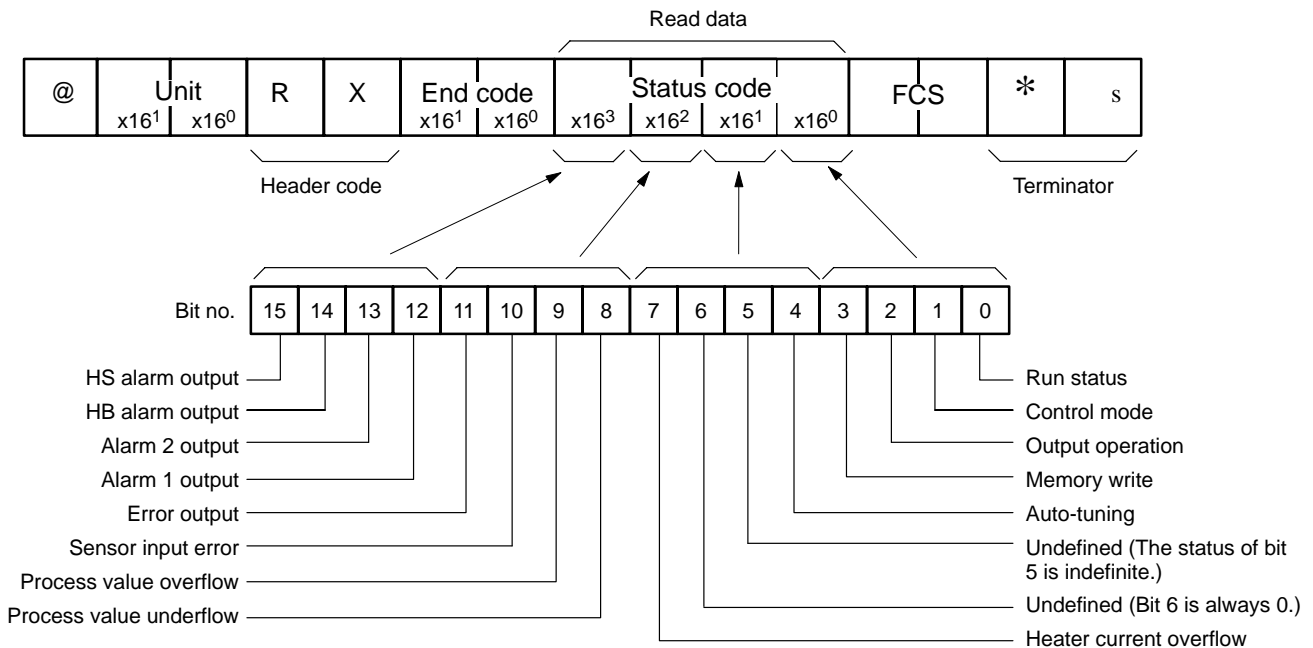

Bit no.	Function	Bit status		Bit no.	Function	Bit status	
		1	0			1	0
0	RUN Status	E5ZE is operating.	E5ZE is OFF.	8	Process Value Underflow	Process value is too low.	Process value is OK.
1	Control Mode	PID	Manual	9	Process Value Overflow	Process value is too high.	Process value is OK.
2	Output Operation	Normal operation	Reverse operation	10	Sensor Input Error	Sensor error.	Sensor is OK.
3	Memory Write	Not written	Written	11	Error Output	ON	OFF
4	Auto-tuning	Auto-tuning.	Not auto-tuning.	12	Alarm 1 Output	ON	OFF
5	Undefined (The status of bit 5 is indefinite.)	---	---	13	Alarm 2 Output	ON	OFF
6	Undefined (Bit 6 is always 0.)	---	0	14	HB Alarm Output	ON	OFF
7	Heater Current Overflow	Current is too large.	Current is normal.	15	HS Alarm Output	ON	OFF



1. The response block for Status Read (RX) does not include read data if the end code of the response block is other than 00.
2. Refer to 2-4 End Codes.
3. The contents of temperature controller errors detected with Status Read (RX) can be checked with Error Read (RU). Refer to 3-24 Error Read: RU.

**Communications Example**

In this example, the E5ZE is operated with Status Read (RX) under the following conditions.

Unit no.: 1  
Control Point: 3

RUN Status: ON (E5ZE is operating)  
 Control Mode: Advanced PID control  
 Output Operation: Reverse operation  
 Parameters: Written to memory  
 Auto-tuning: Not auto-tuning  
 Heater Current Overflow: Normal current  
 Process Value: OK  
 Sensor Input Error: Sensor is OK  
 Error Output: OFF  
 Alarm 1 Output: ON  
 Alarm 2 Output: OFF  
 HB Alarm Output: OFF  
 HS Alarm Output: OFF

**Command**

@	0	1	R	X	0	3	0	2	4	A	*	s
---	---	---	---	---	---	---	---	---	---	---	---	---

Response

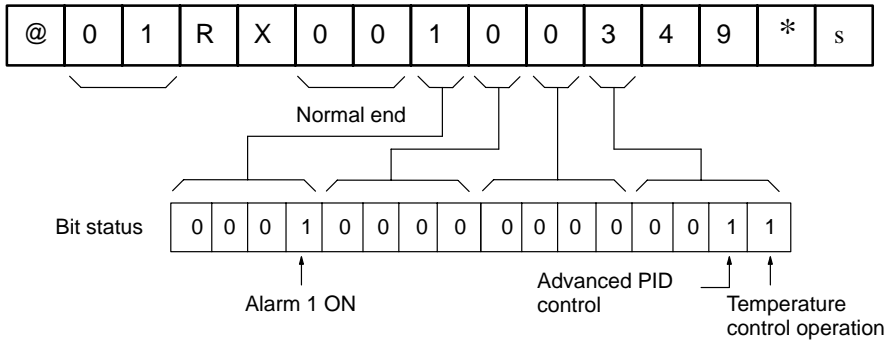

**Bit Meanings in Detail**

Meanings of other bits have been described previously.

**Bit 0: RUN Status**

Indicates the following operation control status of the E5ZE.

- Temperature control or manual operation
- OFF

**Bit 1: Control Mode**

Indicates the control mode of the E5ZE.

- Advanced PID control mode (with ON/OFF control)
- Manual operation mode

**Bit 2: Output Operation**

Indicates the control output operation of the E5ZE.

- Normal operation
- Reverse operation

**Bit 3: Memory Write**

Indicates the existence or nonexistence of the setting data of the E5ZE.

- Not written
- Written

**Bit 4: Auto-tuning**

Indicates the auto-tuning status of the E5ZE.

- Auto-tuning
- Not auto-tuning.

**Bit 7: Heater Current Overflow**

This flag turns ON to indicate that the measured heater current has exceeded 55.0 A. The E5ZE continues temperature control even when this flag turns ON.

**Bit 8: Process Value Underflow**

This flag turns ON to indicate that the process value at a control point has dropped below the set point range by 20°C or 40°F or more. The E5ZE continues temperature control even when this flag turns ON.

**Bit 9: Process Value Overflow**

This flag turns ON to indicate that the process value at a control point has exceeded the set point range by 20°C or 40°F. The E5ZE continues temperature control even when this flag turns ON.

**Bit 10: Sensor Input Error**

This flag turns ON to indicate that the sensor connected to a control point has been incorrectly wired, that the sensor circuit is burnout, or that a temperature input from the sensor has exceeded the set point range. Although the E5ZE continues temperature control even when this flag turns ON, the control output of the control point will be OFF until this flag turns OFF.

### 3-24 Error Read: RU

#### Function

This command is used to obtain information on errors that exist in the E5ZE.

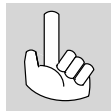

If an error exists in the E5ZE, the control output of a control point will be OFF and the E5ZE will turn an error output ON until the error is eliminated.

#### Command

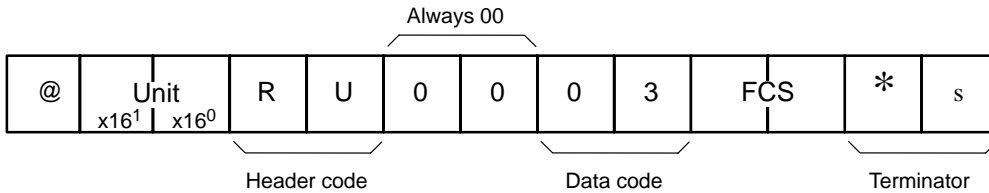

#### Response

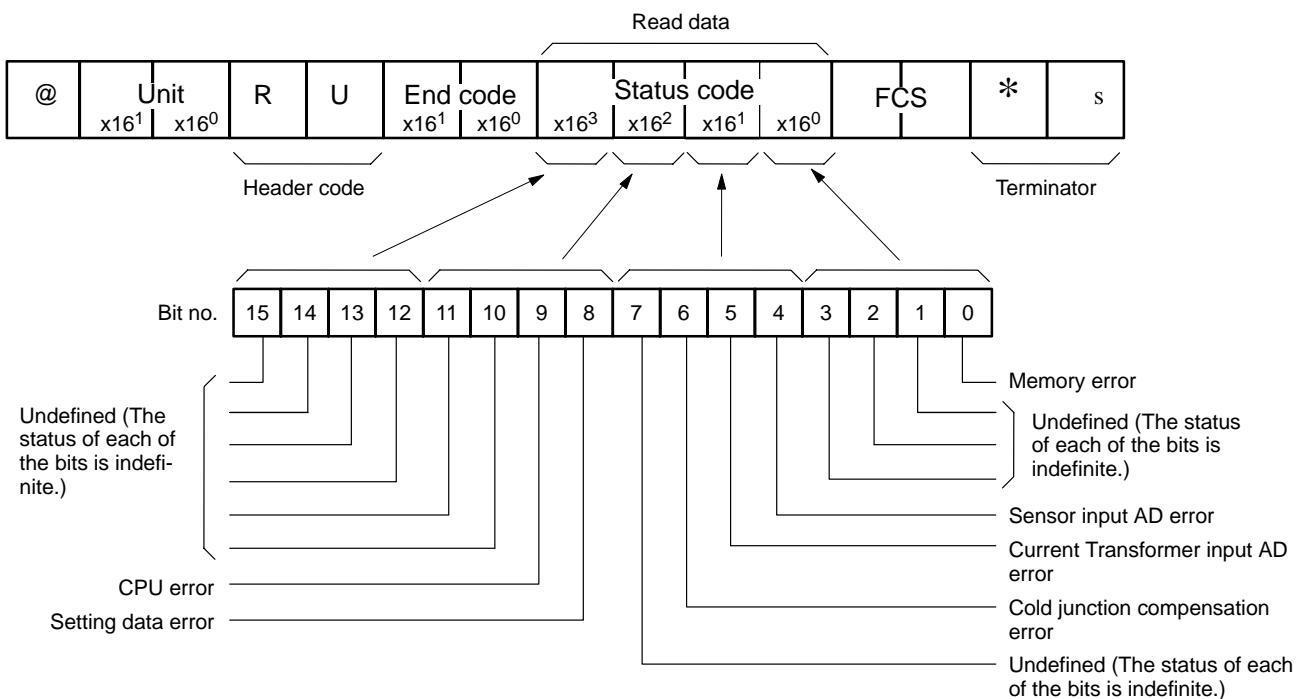

1. The response block for Error Read (RU) does not include read data if the end code of the response block is other than 00.
2. Refer to 2-4 End Codes.

#### Communications Example

In this example, the memory error occurs, the unit number of which has been set to 1, is read by the Error Read (RU).

#### Command

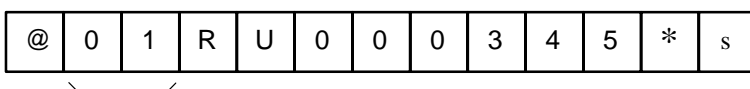

Response

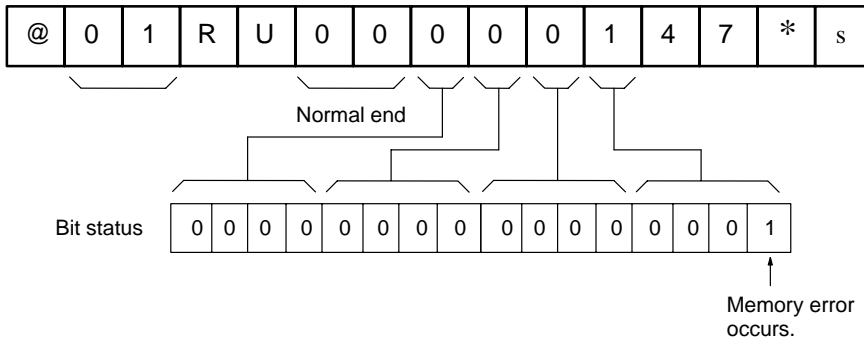

**Readable Errors**

Refer to the following for the kinds of errors and their meanings.

**Memory Error**

This error occurs in the following cases.

- The contents of the Memory are destroyed.
- The E5ZE is turned OFF before the E5ZE returns a response to Memory Write (WE) to the host computer.
- The CPU goes out of control.

The calibration data may be destroyed in the following case.

- A memory error occurs after the setting data are set to the factory-set default parameters with Initialize Setting Data (MC) and these parameters are written to the Memory with Memory Write (WE). In such cases, turn the E5ZE OFF and ON. If a memory error occurs again, the E5ZE needs calibration.

**Sensor Input AD Error**

This error occurs if the IC that converts sensor input values to the E5ZE to digital values fails or a peripheral circuit of the IC fails.

**Current Transformer Input AD Error**

This error occurs if the IC that converts CT input values to the E5ZE to digital values fails or a peripheral circuit of the IC fails.

**Cold Junction Compensation Error**

This error occurs in the following cases if the E5ZE is a thermocouple input model.

- The Cold Junction Compensator is not connected to the terminal block correctly.
- The terminals screws of the Cold Junction Compensator is loosened.
- The Cold Junction Compensator is broken.
- The ambient temperature drops below  $-15^{\circ}\text{C}$  or exceeds  $60^{\circ}\text{C}$ .

**Setting Data Error**

This error occurs in the following cases. If a setting data error occurs, initialize the parameters with Initialize Setting Data (MC) within the permissible parameter setting ranges of the E5ZE.

- Setting data in the memory are destroyed.
- A set point of a control point is not within the allowable set point range.

**CPU Error**

This error occurs if the CPU or its peripheral circuitry is broken.



Reset the set point in the following cases.

- $^{\circ}\text{C}$  is changed to  $^{\circ}\text{F}$  or vice versa with the FUNCTION switch.
- The input type connected to a control point is changed with the INPUT selector.



# SECTION 4

## Commands According to Application

This section describes the commands that are used according to the application.

4-1	Auto-tuning Start: AS	52
4-2	Auto-tuning Stop: AP	53
4-3	Setting Unit Write: Wt	53
4-4	Setting Unit Read: Rt	55
4-5	Input Shift Write: WI	55
4-6	Input Shift Read: RI	56
4-7	Manual Reset Value Write: WK	57
4-8	Manual Reset Value Read: RK	58
4-9	Ramp Value Write: WR	59
4-10	Ramp Value Read: RR	60
4-11	Present Set Point Read: Rs	61
4-12	Manual Output Value Write: WO	62
4-13	Output Variable Limit Value Write: WL	63
4-14	Output Variable Limit Value Read: RL	65
4-15	Output Variable Change Rate Limit Value Write: WG	66
4-16	Output Variable Change Rate Limit Value Read: RG	67
4-17	Memory Write: WE	67
4-18	Initialize Setting Data: MC	68
4-19	Communication Test: TS	69

# 4-1 Auto-tuning Start: AS

## Function

This command is used to auto-tune a control point.

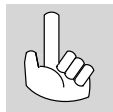

Auto-tuning Start (AS) is not accepted by a control point if the control point is already being auto-tuned or the operation of the control point has been interrupted.



The HB or HS alarm of a control point will not work if the control point is being auto-tuned.

## Commands

### With Control Point Designated

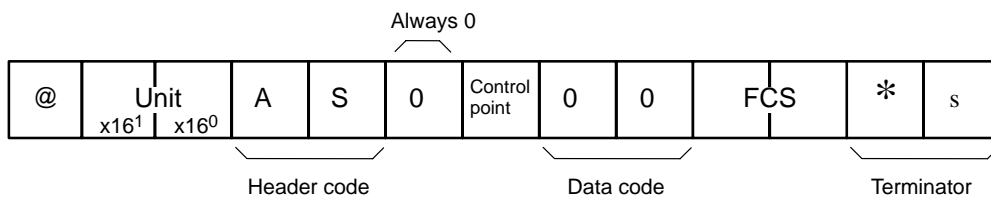

### Auto-tuning of All Control Points

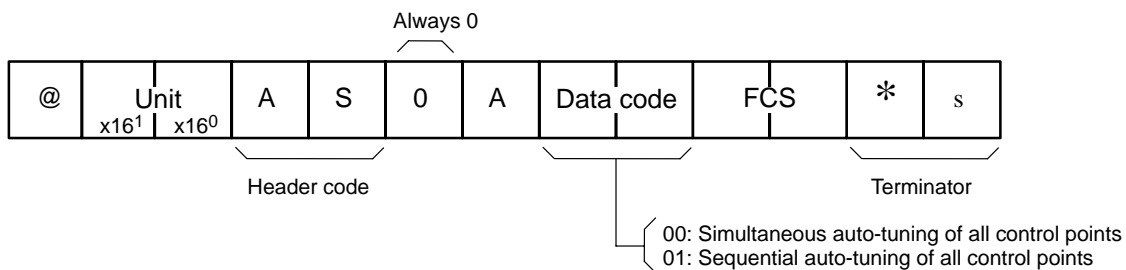

If the control point data of the command block is set to A and the data code of the command block is set to 00, all the control points will be auto-tuned simultaneously. If the control point data of the command block is set to A and the data code of the command block is set to 01, all the control points will be auto-tuned in sequence.

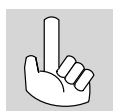

Sequential Auto-tuning of All Control Points:

If the data code of the command block is set to 01, all the control points will be auto-tuned in numerical order.

## Response

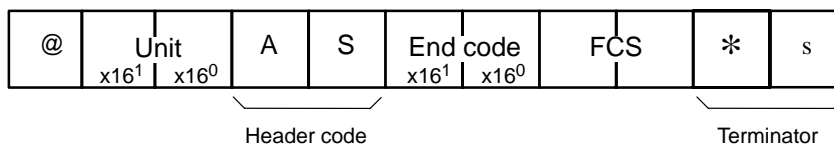

## Communications Example

In this example, control point 3, the unit number of which has been set to 1, is auto-tuned with Auto-tuning Start (AS).

### Command

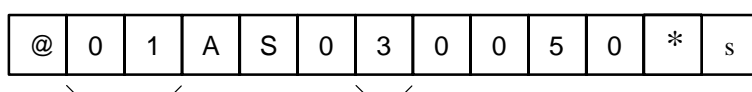

**Response**

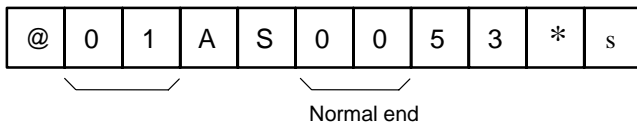

## 4-2 Auto-tuning Stop: AP

**Function**

This command is used to stop the auto-tuning of all the control points.

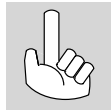

Auto-tuning Stop (AP) cannot be used to stop the auto-tuning of a particular control point individually.

**Command**

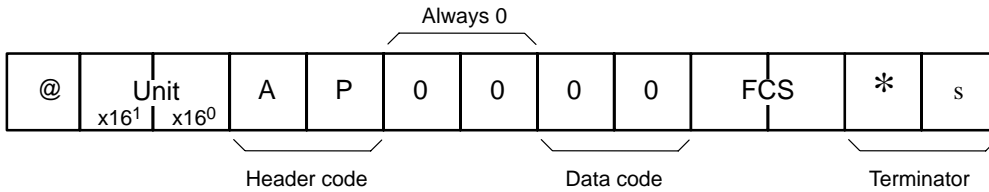

**Response**

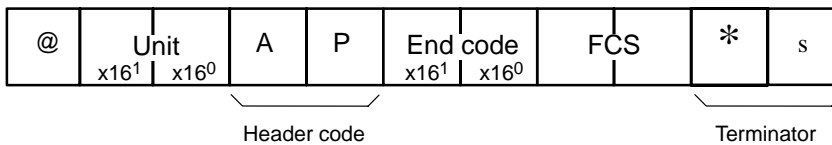

**Communications Example**

In this example, the auto-tuning of the control points, the unit number of which has been set to 1, is stopped.

**Command**

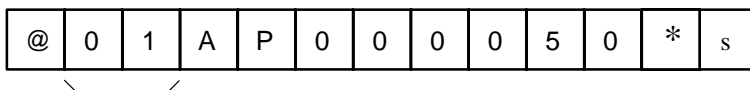

**Response**

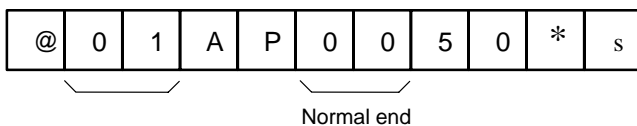

## 4-3 Setting Unit Write: Wt

**Function**



This command is used to set the temperature setting unit to 1 or 0.1.

1. The default temperature setting unit varies with the type of input type to be used with the E5ZE as described below.
 

Thermocouple:	1 (default value)
Platinum resistance thermometer:	0.1 (default value)
2. The digits of a setting data set with the E5ZE vary with the temperature setting unit if the E5ZE is operated with any of the following commands.
  - Set Point Write (WS) and Set Point Read (RS)
  - Process Value Temperature Read (RX)
  - Alarm Temperature Write (W%) and Alarm Temperature Read (R%)
  - Present Set Point Read (Rs)

3. Setting Data Set before Changing Temperature Setting Unit:

- The temperature setting unit of a setting data set for a control point will remain unchanged after the temperature setting unit of the control point is changed.
- When the E5ZE is operated with Setting Unit Read (Rt), the following parameters will be read.

If the temperature setting unit has been changed to 1 from 0.1:  
Parameters will be rounded off (e.g., 1234.5 will be read as 1235).

If the temperature setting unit has been changed to 0.1 from 1:  
Parameters with .0 added (e.g., 1234 will be read as 1234.0).

**Setting Data Range**

Input type	Thermocouple		Platinum resistance thermometer	
°C or °F	°C	°F	°C	°F
Default	0000 (Temperature setting unit: 1)		0001 (Temperature setting unit: 0.1)	
Setting code	0000 to 0001			

**Command**

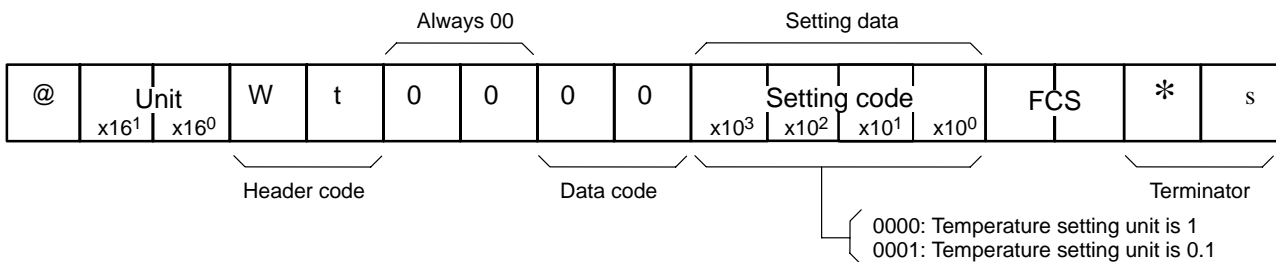

**Response**

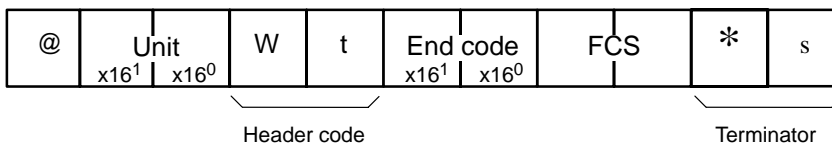

**Communications Example**

In this example, the E5ZE is operated with Setting Unit Write (Wt) under the following conditions.

Unit no.: 1  
Temperature Setting Unit: 1

**Command**

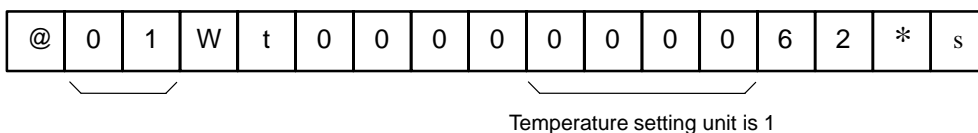

**Response**

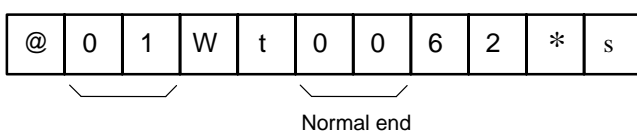

## 4-4 Setting Unit Read: Rt

### Function

This command is used to read the setting unit that has been set with the E5ZE.

### Command

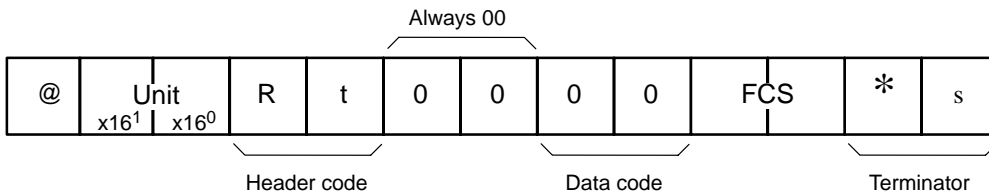

### Response

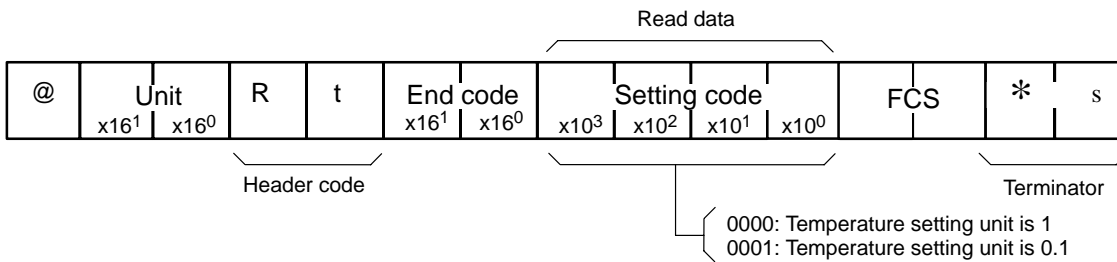

1. The response block for Setting Unit Read (Rt) does not include read data if the end code of the response block is other than 00.
2. Refer to 2-4 End Codes.

### Communications Example

In this example, the E5ZE is operated with Setting Unit Read (Rt) under the following conditions.

Unit no.: 1

Temperature Setting Unit: 1

#### Command

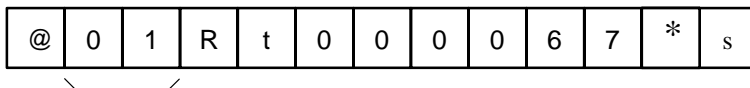

#### Response

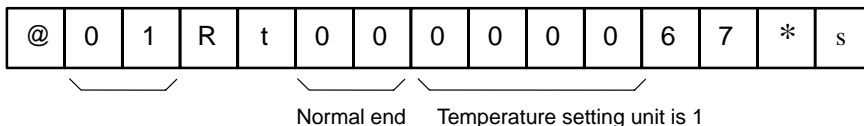

## 4-5 Input Shift Write: WI

### Function

This command is used to write input shift values to shift the measured temperature.



Input Shift Write (WI) cannot be used at a control point being auto-tuned.

### Setting Data Range

Setting unit	0.1	
°C or °F	°C	°F
Default	0000	
Setting data	-999 to 0999	

**Command**

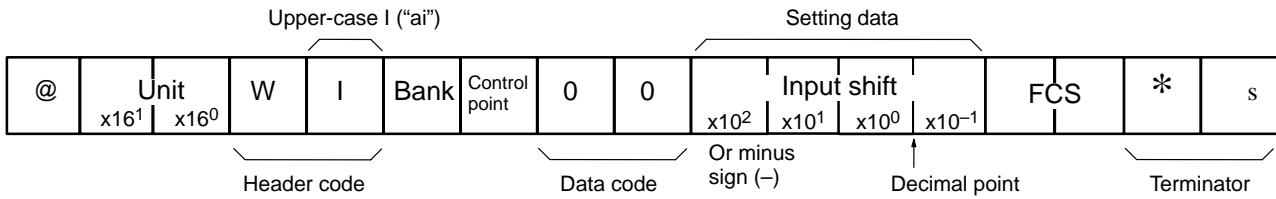

**Response**

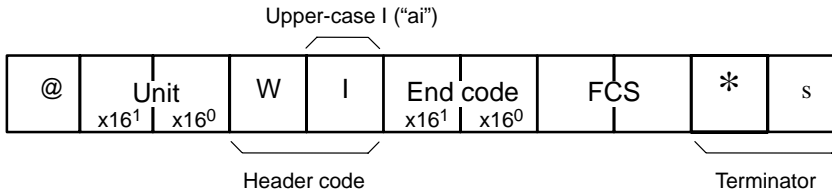

**Communications Example**

In this example, the E5ZE is operated with Input Shift Write (WI) under the following conditions.

- Unit no: 1
- Memory Bank no.: 2
- Control Point: 3
- Input Shift Value: -12.3°C

**Command**

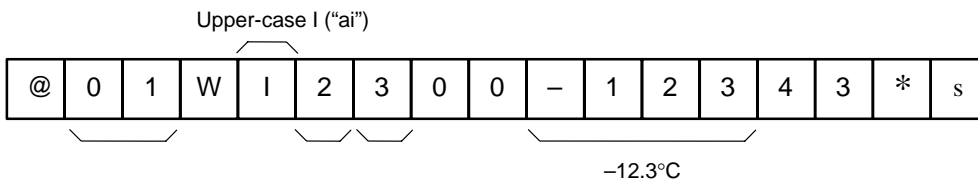

**Response**

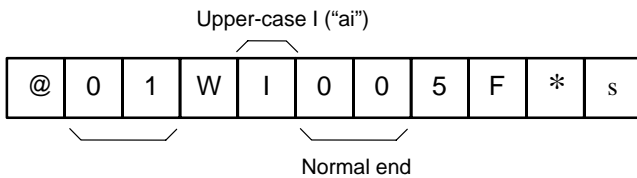

If the sensor input is 100°C, the measured temperature will be 87.7°C (i.e., 100 – 12.3 = 87.7). The temperature read with Measured Temperature Read (RX) will be thus 87.7°C.

**4-6 Input Shift Read: RI**

**Function**

This command is used to read the input shift values that have been set at a control point.

**Command**

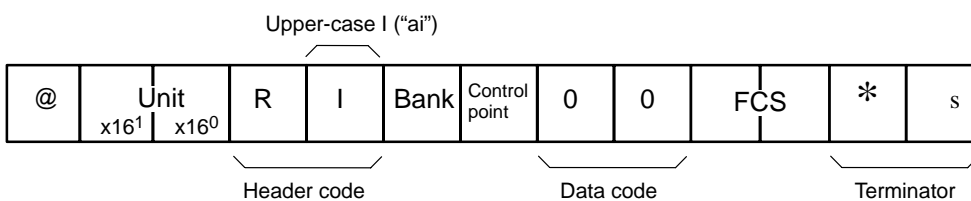

**Response**

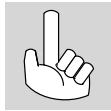
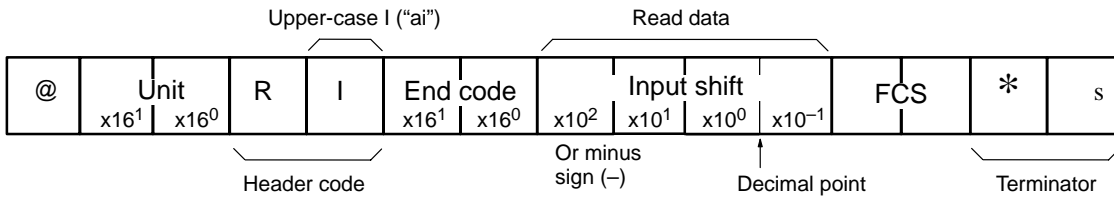

1. The response block for Input Shift Read (RI) does not include read data if the end code of the response block is other than 00.
2. Refer to 2-4 End Codes.

**Communications Example**

In this example, the E5ZE is operated with Input Shift Read (RI) under the following conditions.

Unit no.: 1  
 Memory Bank no.: 2  
 Control Point: 3  
 Input Shift Value: -12.3°C

**Command**

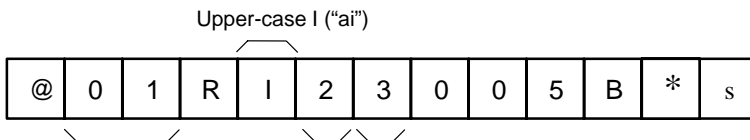

**Response**

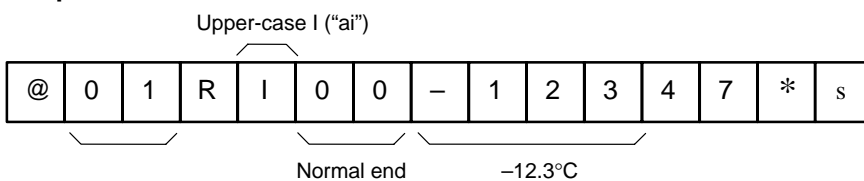

**4-7 Manual Reset Value Write: WK**

**Function**

This command is used to write the percentages of manual reset value to a control point when there are offset at the control point in P or PD control operation.



1. The offset at the control point can be corrected by adjusting the manual reset value written to the control point.
2. Manual Reset Value Write (WK) cannot be used at a control point being auto-tuned.

**Setting Data Range**

Setting unit	0.1
Manual reset value unit	%
Default	0500
Setting data	0000 to 1000

**Command**

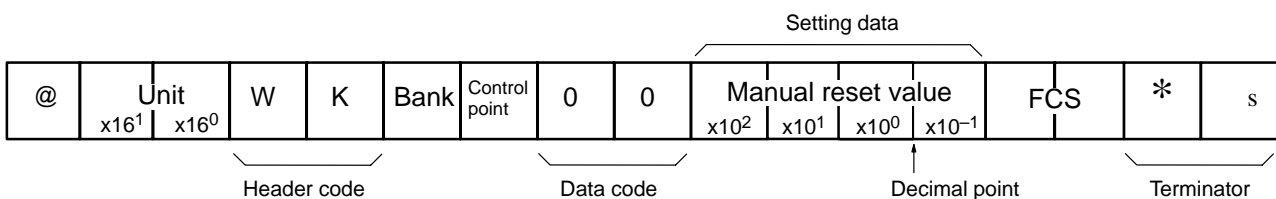

**Response**

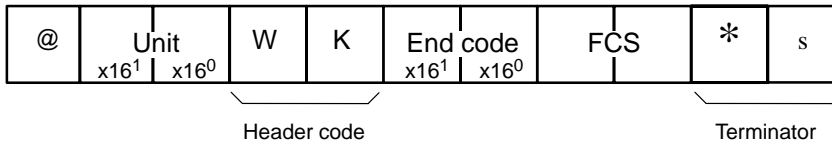

**Communications Example**

In this example, the E5ZE is operated with Manual Reset Value Write (WK) under the following conditions.

Unit no.: 1  
 Memory Bank no.: 2  
 Control Point: 3  
 Manual Reset Value: 70.0%

**Command**

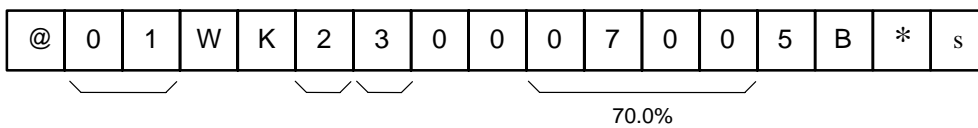

**Response**

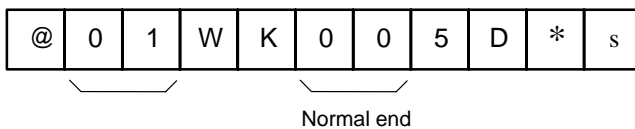

## 4-8 Manual Reset Value Read: RK

**Function**

This command is used to read the percentages of manual reset value that have been set at a control point.

**Command**

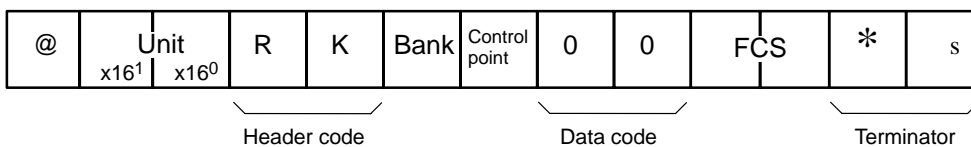

**Response**

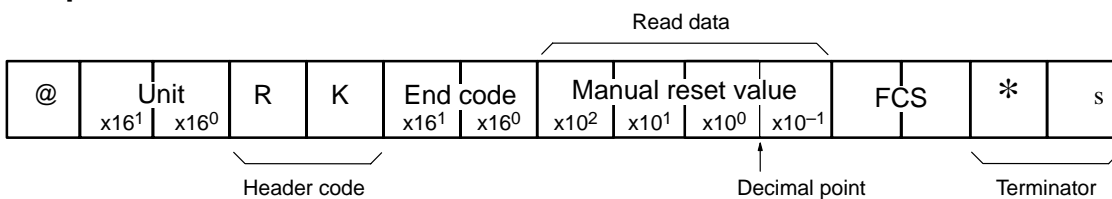

1. The response block for Manual Reset Value Read (RK) does not include read data if the end code of the response block is other than 00.
2. Refer to 2-4 End Codes.

**Communications Example**

In this example, the E5ZE is operated with Manual Reset Value Read (RK) under the following conditions.

Unit no.: 1  
 Memory Bank no.: 2  
 Control Point: 3  
 Manual Reset Value: 70.0%



**Command**

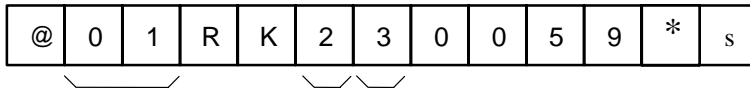

**Response**

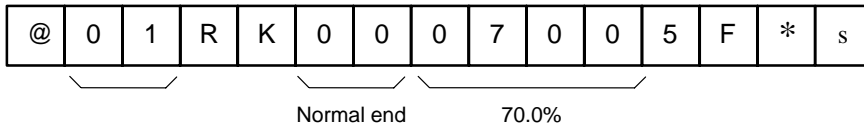

## 4-9 Ramp Value Write: WR

**Function**

This command is used to write ramp values to a control point to change the set point of the control point constantly.

**Setting Data Range**

<b>Time</b>	Second	Minute	Hour
<b>Symbol</b>	S	M	H
<b>Setting unit</b>	0.1		
<b>Temperature unit</b>	°C/s	°F/s	°C/min   °F/min   °C/h   °F/h
<b>Default</b>	000		
<b>Setting data</b>	000 to 999		

**Command**

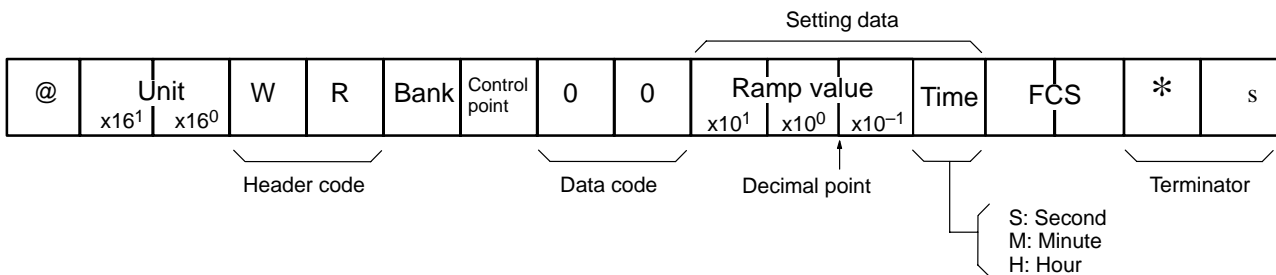

**Response**

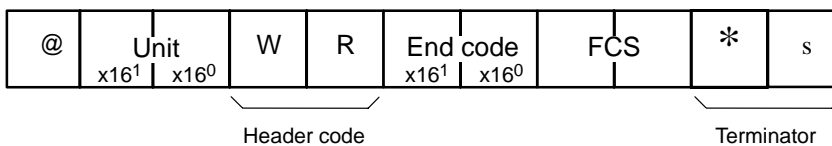

**Communications Example**

In this example, the E5ZE is operated with Ramp Value Write (WR) under the following conditions.

- Unit no.: 1
- Memory Bank no.: 2
- Control Point: 3
- Ramp Value: 10.0 min

**Command**

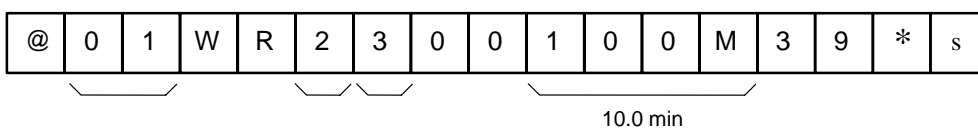

**Response**

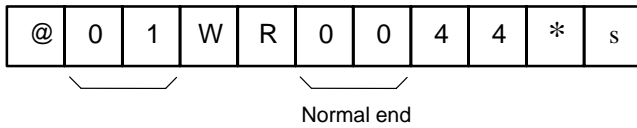

## 4-10 Ramp Value Read: RR

**Function**

This command is used to read the ramp values that have been set at a control point.

**Command**

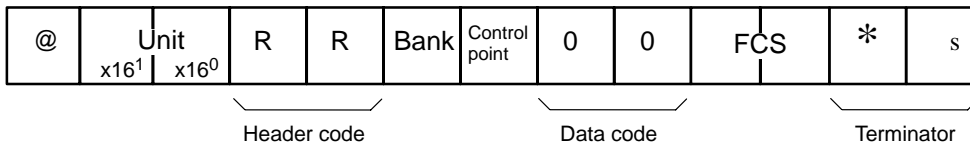

**Response**

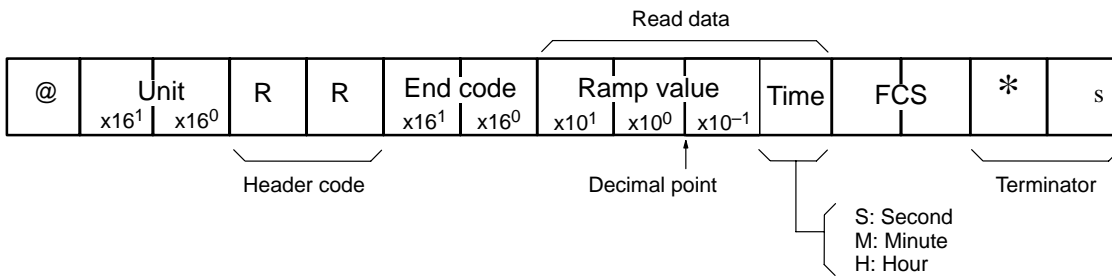

1. The response block for Ramp Value Read (RR) does not include read data if the end code of the response block is other than 00.
2. Refer to 2-4 End Codes.

**Communications Example**

In this example, the E5ZE is operated with Ramp Value Read (RR) under the following conditions.

Unit no.: 1  
 Memory Bank no.: 2  
 Control Point: 3  
 Ramp Value: 10.0 min

**Command**

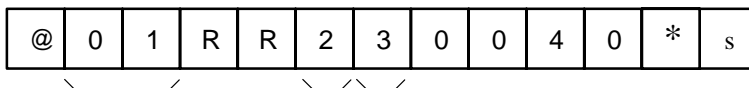

**Response**

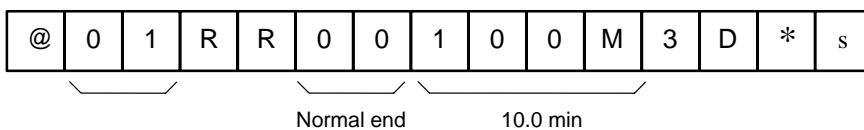

# 4-11 Present Set Point Read: Rs

## Function

This command is used to read the present set point of a control point in ramp operation.

## Command

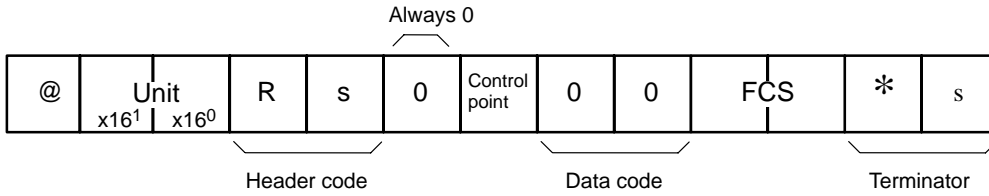

## Response Formats of E5ZE in Temperature Control Operation

### When Setting Unit is 1

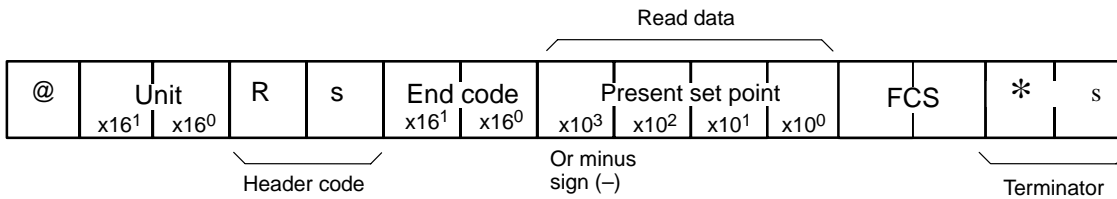

### When Setting Unit is 0.1

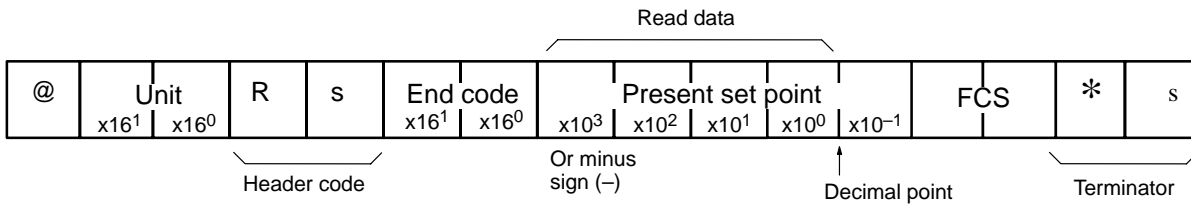

## Response Formats of E5ZE not in Temperature Control Operation

Present Set Point Read (Rs) enables the E5ZE to read error codes when the E5ZE is not in temperature control operation.

### When Setting Unit is 1

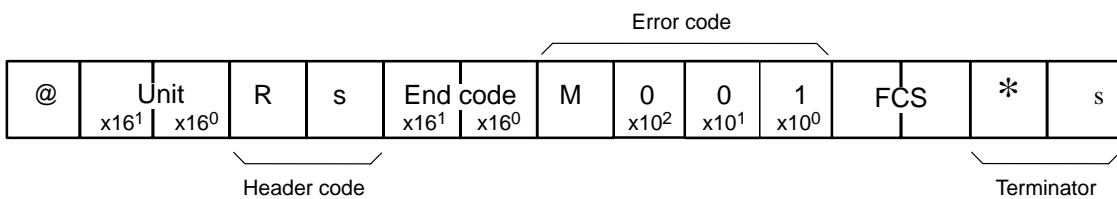

### When Setting Unit is 0.1

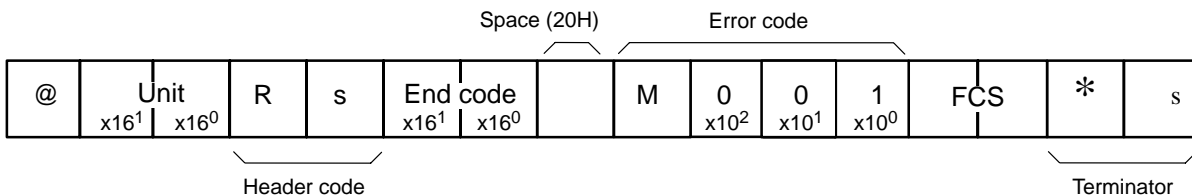

1. The response block for Present Set Point Read (Rs) does not include read data or an error code if the end code of the response block is other than 00.
2. Refer to 2-4 End Codes and 2-5 Error Codes.

**Communications Example**

In this example, the E5ZE is operated with Present Set Point Read (Rs) under the following conditions.

Unit no.: 1  
 Control Point: 3  
 Setting Unit: 1  
 Present Set Point: 200°C

**Command**

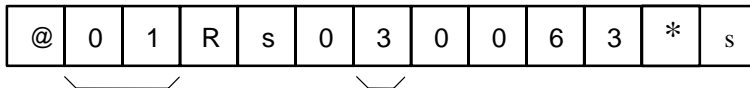

**Response**

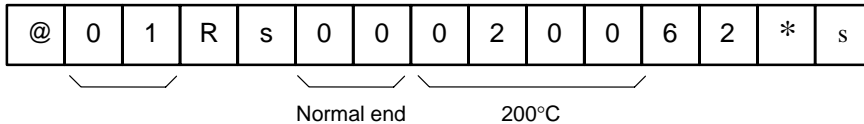

**4-12 Manual Output Value Write: WO**

**Function**

This command is used to write the percentage of manual output value to a control point.



1. Manual Output Value Write (WO) is used with the E5ZE only when the E5ZE is in manual operation.
2. The percentage of cooling-side output value can be written to a control point only if the E5ZE is a heating and cooling control model.
3. The E5ZE operates manually even if the E5ZE detects a sensor input error. Manual Output Value Write (WO), however, cannot be used with the E5ZE if the E5ZE detects a sensor input error.
4. If the E5ZE has an error, the E5ZE cannot operate manually and Manual Output Value Write (WO) cannot be used with the E5ZE.

**Setting Data Range**

Setting unit	0.1
Manual output value unit	%
Setting data	0000 to 1000

**Command**

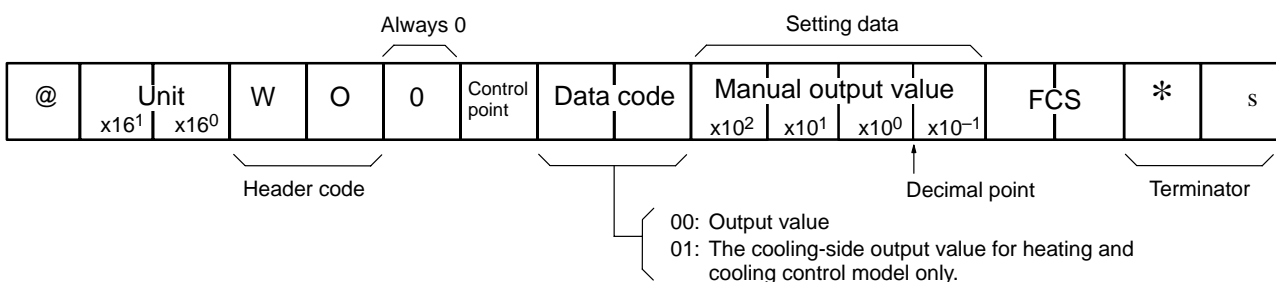

**Response**

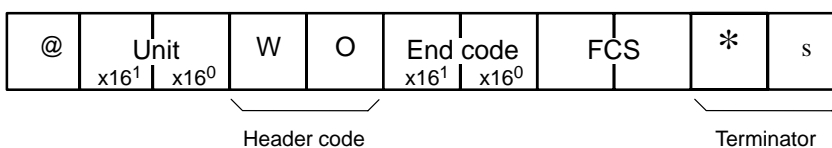

**Communications Example**

In this example, the E5ZE is operated with Manual Output Value Write (WO) under the following conditions.

Unit no.: 1  
 Control Point: 3  
 Manual Output Value: 50.0%

**Command**

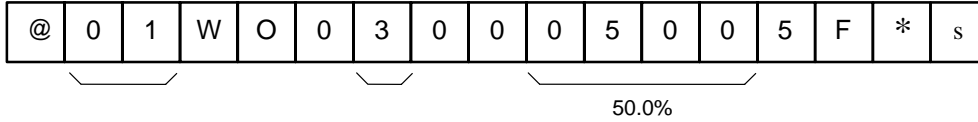

**Response**

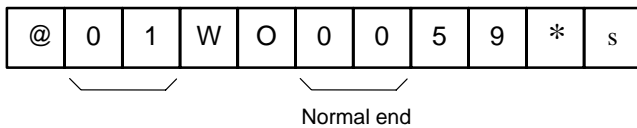

## 4-13 Output Variable Limit Value Write: WL

**Function**

This command is used to write control output variable limit values to a control point.



1. Output Variable Limit Value Write (WL) cannot be used at a control point being auto-tuned.
2. Cooling-side output variable limit values can be written to a control point provided that the E5ZE is a heating and cooling control model.



The output variable limit function will not work at a control point in the following cases.

- The E5ZE is in manual operation.
- The E5ZE has an error.
- The E5ZE detects a sensor input error.
- The E5ZE is stopped.

**Setting Data Range**

<b>Setting item</b>	Lower limit	Upper limit
<b>Setting unit</b>	0.1	
<b>Output variable limit value unit</b>	%	
<b>Default</b>	0000	1000
<b>Setting data</b>	0000 to 1000	



1. The output variable lower-limit value set at a control point must not be larger than the upper output variable limit value.
2. If the output variable lower-limit value set at a control point is 1000, the output value will be always 100.0%.
3. If the output variable upper-limit value set at a control point is 1000, the output value will be always 0.0%.
4. If an output variable limit value is set at a control point as both output variable lower-limit value and upper-limit value, the output value will be the output variable limit value.

**Command**

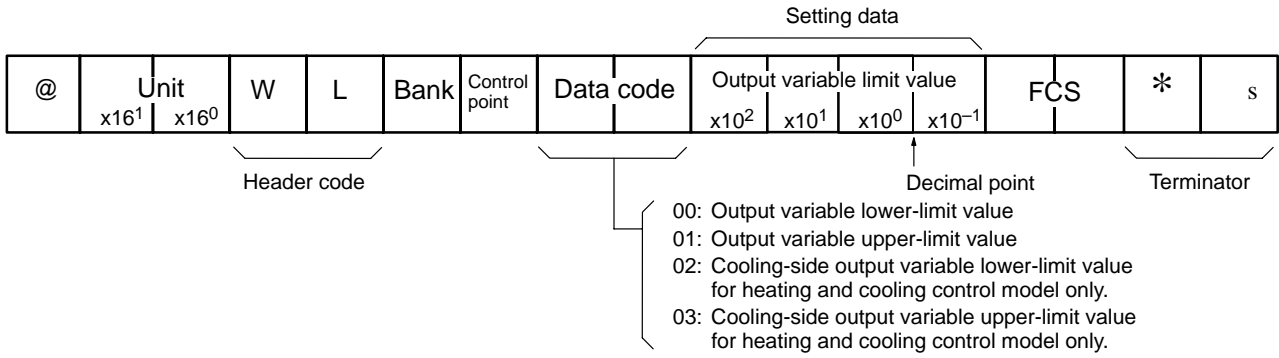

**Response**

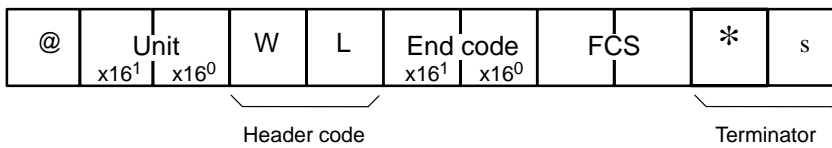

**Communications Example**

In this example, the E5ZE is operated with Output Variable Limit Value Write (WL) under the following conditions.

- Unit no.: 1
- Memory Bank no.: 2
- Control Point: 3
- Output Variable Lower-limit Value: 20.0%

**Command**

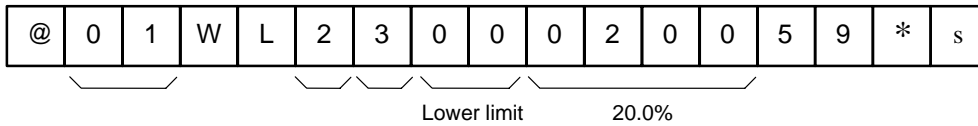

**Response**

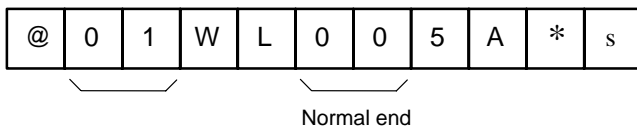

# 4-14 Output Variable Limit Value Read: RL

## Function

This command is used to read the output variable limit values that have been set at a control point.

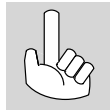

The cooling-side output variable limit values that have been set at a control point can be read provided that the E5ZE is a heating and cooling control model.

## Command

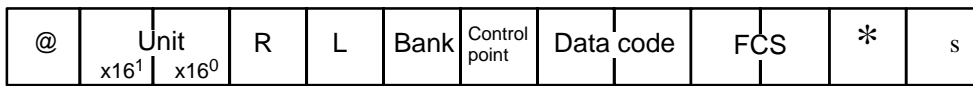

Header code

Terminator

- 00: Output variable lower-limit value
- 01: Output variable upper-limit value
- 02: Cooling-side output variable lower-limit value for heating and cooling control model only.
- 03: Cooling-side output variable upper-limit value for heating and cooling control model only.

## Response

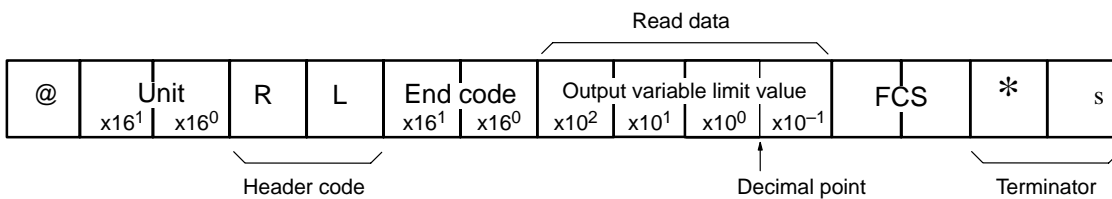

Header code

Decimal point

Terminator



1. The response block for Output Variable Limit Value Read (RL) does not include read data if the end code of the response block is other than 00.
2. Refer to 2-4 End Codes.

## Communications Example

In this example, the E5ZE is operated with Output Variable Limit Value Read (RL) under the following conditions.

- Unit no.: 1
- Memory Bank no.: 2
- Control Point: 3
- Output Variable Lower-limit Value: 20.0%

## Command

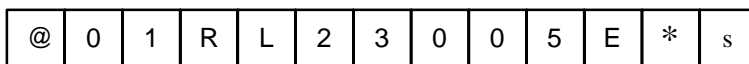

Lower limit

## Response

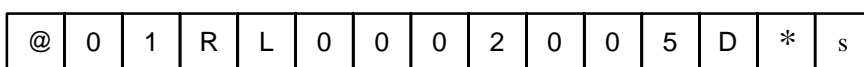

Normal end

20.0%

# 4-15 Output Variable Change Rate Limit Value Write: WG

## Function

This command is used to write control output variable change rate limit values to a control point.

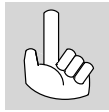

1. Output Variable Change Rate Limit Value Write (WG) cannot be used at a control point being auto-tuned.
2. The output variable change rate limit function will not work at a control point in the following cases.
  - An output variable change rate limit value of 0000 is used for the E5ZE.
  - The control point is being auto-tuned.
  - The E5ZE is in manual operation.
  - The E5ZE has an error.

## Setting Data Range

Setting unit	0.1
Change rate unit	%/(Sampling period)
Default	0000
Setting data	0000 to 1000



The percentage of output per sampling period of a control point must be set as the output variable change rate limit value.

## Command

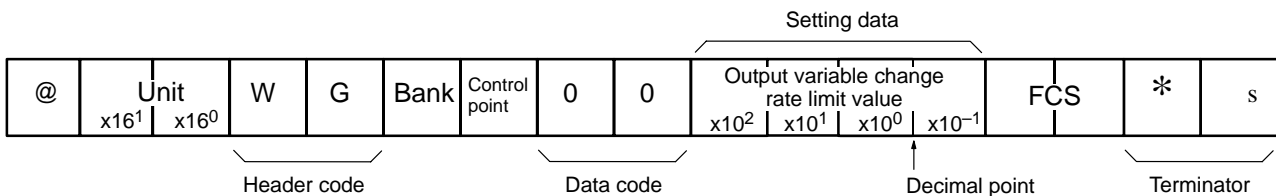

## Response

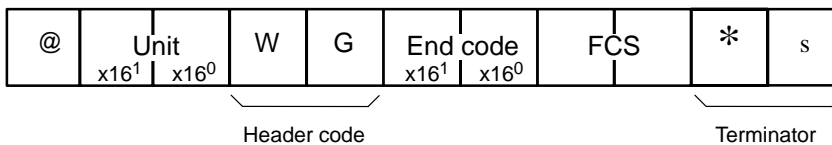

## Communications Example

In this example, the E5ZE is operated with Output Variable Change Rate Limit Value Write (WG) under the following conditions.

- Unit no.: 1
- Memory Bank no.: 2
- Control Point: 3
- Output Variable Change Rate Limit Value: 60.0% per sampling period

### Command

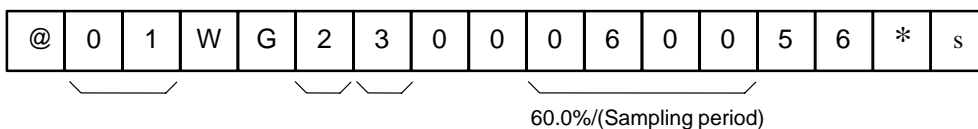

### Response

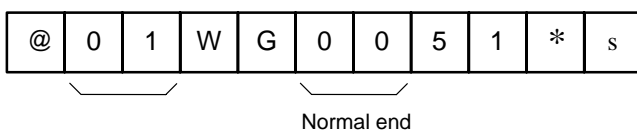



## 4-16 Output Variable Change Rate Limit Value Read: RG

### Function

This command is used to read the output variable change rate limit values that have been set at a control point.

### Command

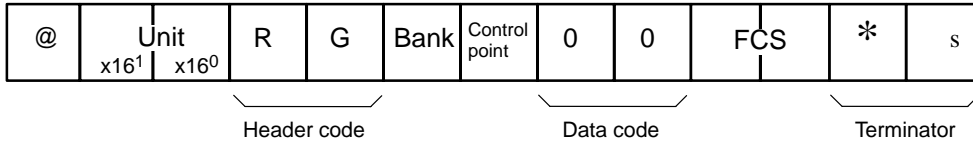

### Response

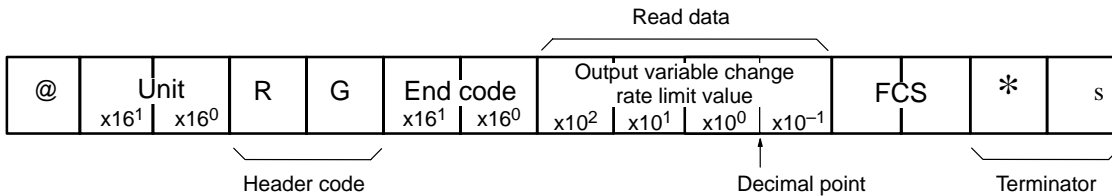

1. The response block for Output Variable Change Rate Limit Value Read (RG) does not include read data if the end code of the response block is other than 00.
2. Refer to 2-4 End Codes.

### Communications Example

In this example, the E5ZE is operated with Output Variable Change Rate Limit Value Read (RG) under the following conditions.

Unit no.: 1  
 Memory Bank no.: 2  
 Control Point: 3  
 Output Variable Change Rate Limit Value: 60.0% per sampling period

### Command

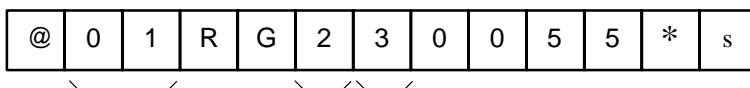

### Response

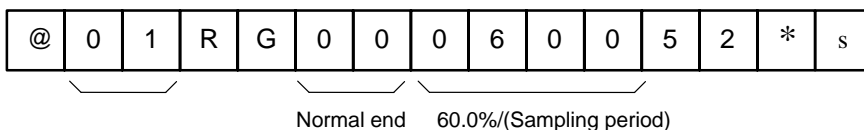

## 4-17 Memory Write: WE

### Function

This command is used to write the setting data set with the E5ZE to the memory.



When the E5ZE is turned ON, the setting data stored in the memory will be read by the E5ZE automatically for temperature control use.



If the E5ZE is turned OFF before the E5ZE returns a response to Memory Write (WE) to the host computer connected to the E5ZE, the setting data set with the E5ZE may not be written to the memory, in which case a memory error will occur.

**Command**

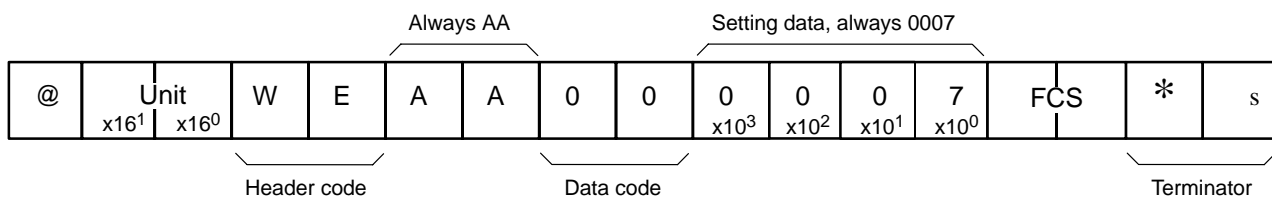

**Response**

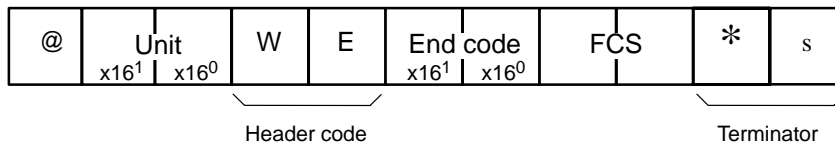

**Communications Example**

In this example, setting data, the unit number of which has been set to 1, are written to the memory with Memory Write (WE).

**Command**

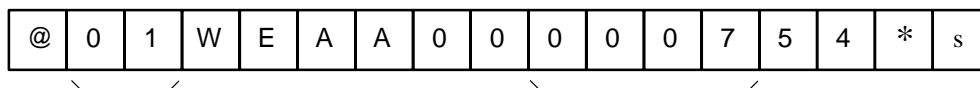

**Response**

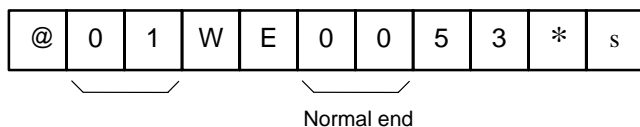

## 4-18 Initialize Setting Data: MC

**Function**

This command is used to set the memory to the factory-set default setting data.



1. Initialize Setting Data (MC) can be used only when the E5ZE is stopped.
2. Initialize Setting Data (MC) cannot be used to reset a particular control point or memory bank individually.
3. Initialize Setting Data (MC) does not affect the contents of the memory and saved calibration values. To initialize the stored set data of the E5ZE, send this command and then Memory Write (WE) with the factory-set setting data.



If the temperature unit is changed from °C to °F or vice versa or the input type connected to the E5ZE is changed at a control point, set the RAM to the factory-set default setting data and reset data with the E5ZE.

**Command**

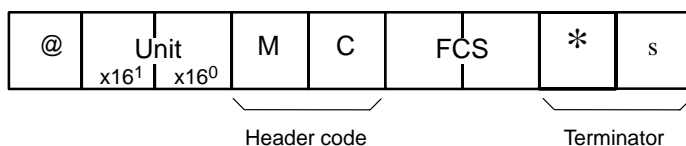

**Response**

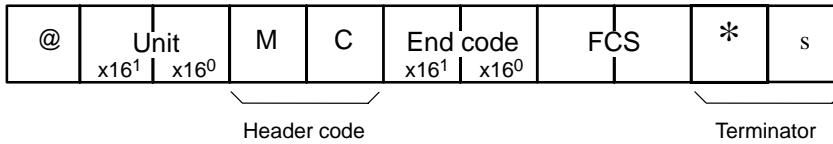

**Communications Example**

In this example, setting data, the unit number of which has been set to 1, are reset to the factory-set default setting data with Initialize Setting Data (MC).

**Command**

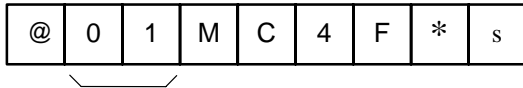

**Response**

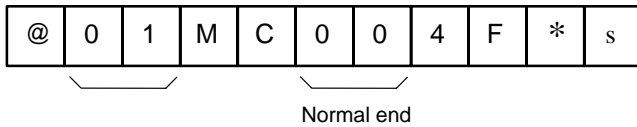

**4-19 Communication Test: TS**

**Function**

This command is used to enable a control point to send back to the host system connected to the E5ZE the character strings received at the control point from the host system.



Character strings can contain all characters except the following characters.

- @: (40H)
- s: (carriage return) (0DH)

**Command**

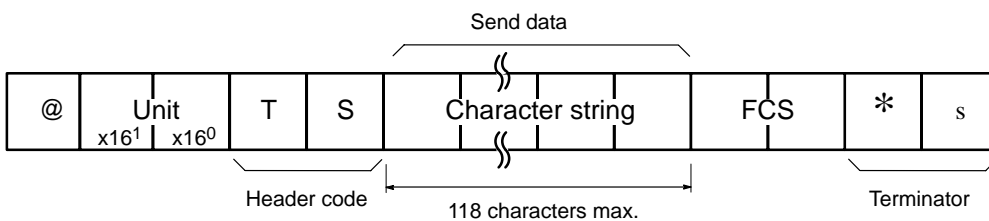

**Response**

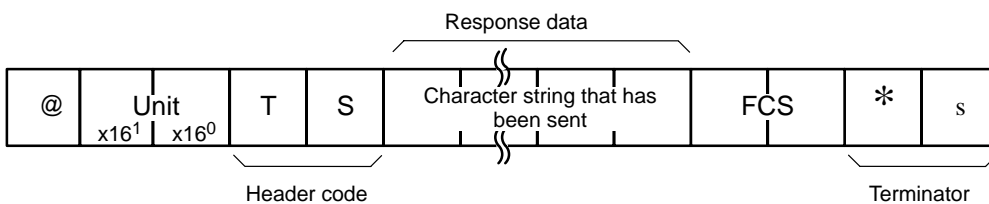

**Response Block with Error Detected**

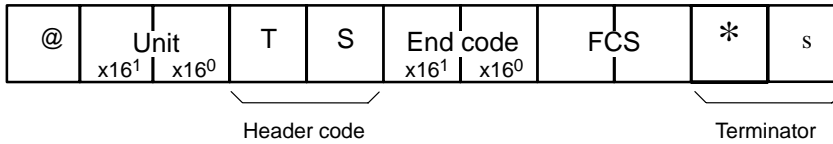

1. The contents of the error will be indicated by the end code in the response block.
2. Refer to 2-4 End Codes.

**Communications Example**

In this example, character string ABC123 is sent to the E5ZE, the unit number of which has been set to 1, with the Communication Test (TS).

**Command**

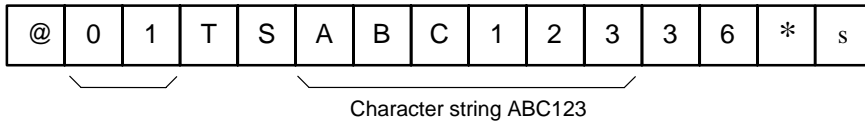

**Response**

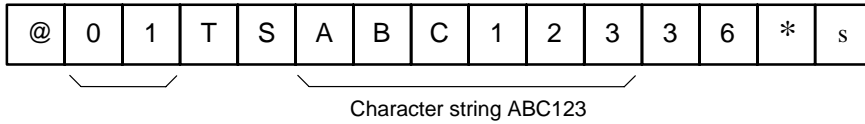

# SECTION 5

## Heater Burnout and SSR Failure Detection Commands

This section describes the commands used for heater burnout and SSR failure detection.

5-1	HB Alarm and HS Alarm Point Write: WU .....	72
5-2	HB Alarm and HS Alarm Point Read: RU .....	73
5-3	Heater Burnout and SSR Failure Detection Current Value Write: WW .....	74
5-4	Heater Burnout and SSR Failure Detection Current Value Read: RW .....	75
5-5	Heater Current Value and SSR Leakage Current Value Read: RZ .....	76

# 5-1 HB Alarm and HS Alarm Point Write: WU

## Function

This command is used to designate the control points that are to have HB and HS alarms so that the control points can detect heater burnout and SSR failures.

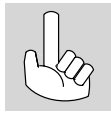

1. The control points designated by HB Alarm and HS Alarm Point Write (WU) will have both HB and HS alarms.
2. HB Alarm and HS Alarm Point Write (WU) cannot be used if a control point is being auto-tuned.

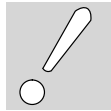

The HB or HS alarm of a control point will not work if the control point is being auto-tuned.

## Setting Data Range

<b>Default</b>	00 (None of the control points have HB or HS alarm.)
<b>Setting code</b>	00 to FF

## Command

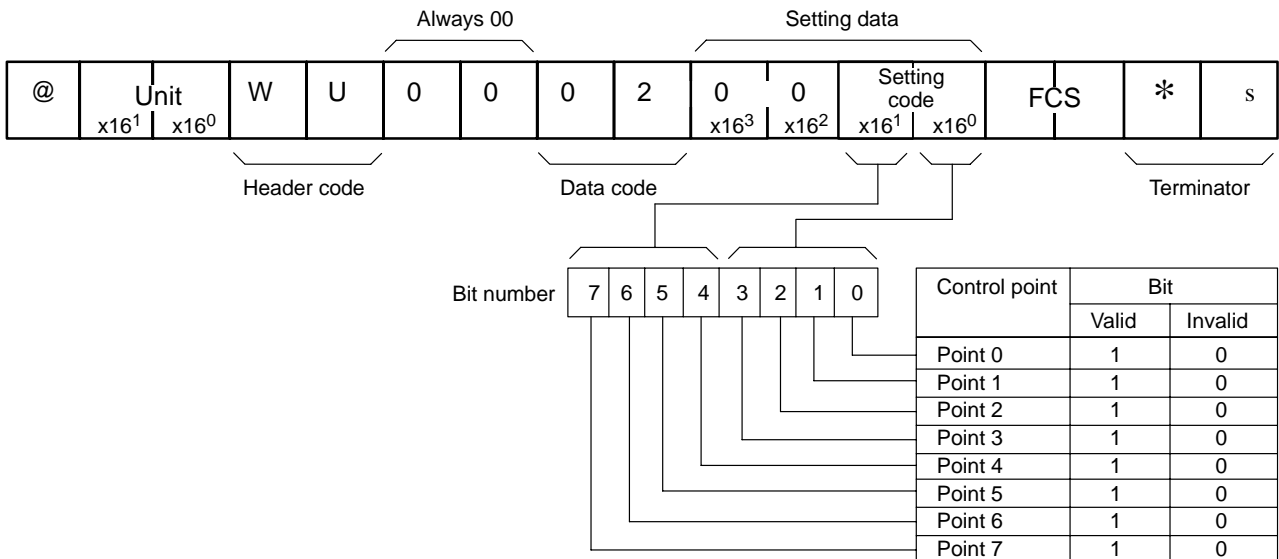

## Response

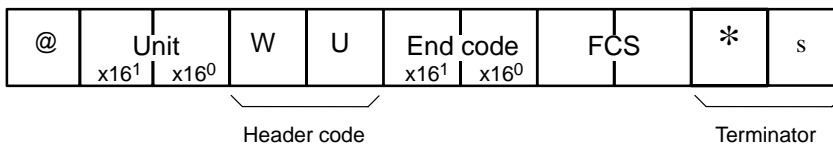

**Communications Example**

In this example, the E5ZE is operated with HB Alarm and HS Alarm Point Write (WU) under the following conditions.

Unit no.: 1

Control Points 0, 2, 4, and 6: Invalid

Control Points 1, 3, 5, and 7: Valid

**Command**

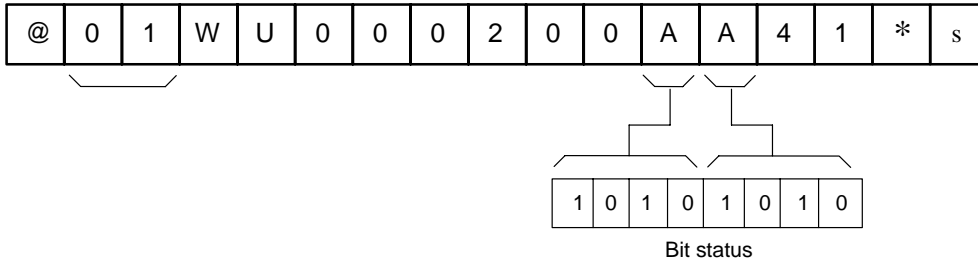

**Response**

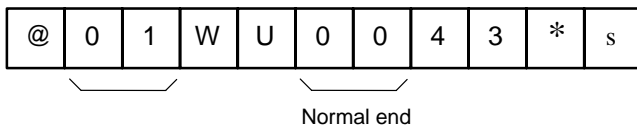

**5-2 HB Alarm and HS Alarm Point Read: RU**

**Function**

This command is used to read which control points have been set for HS and HB alarms.

**Command**

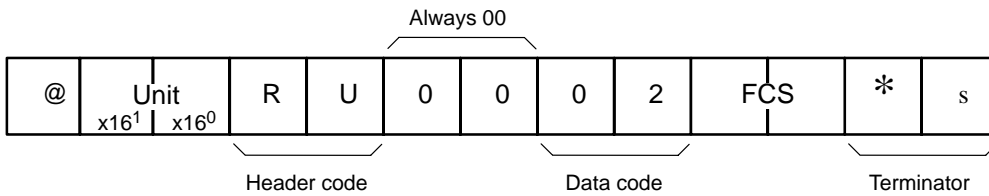

**Response**

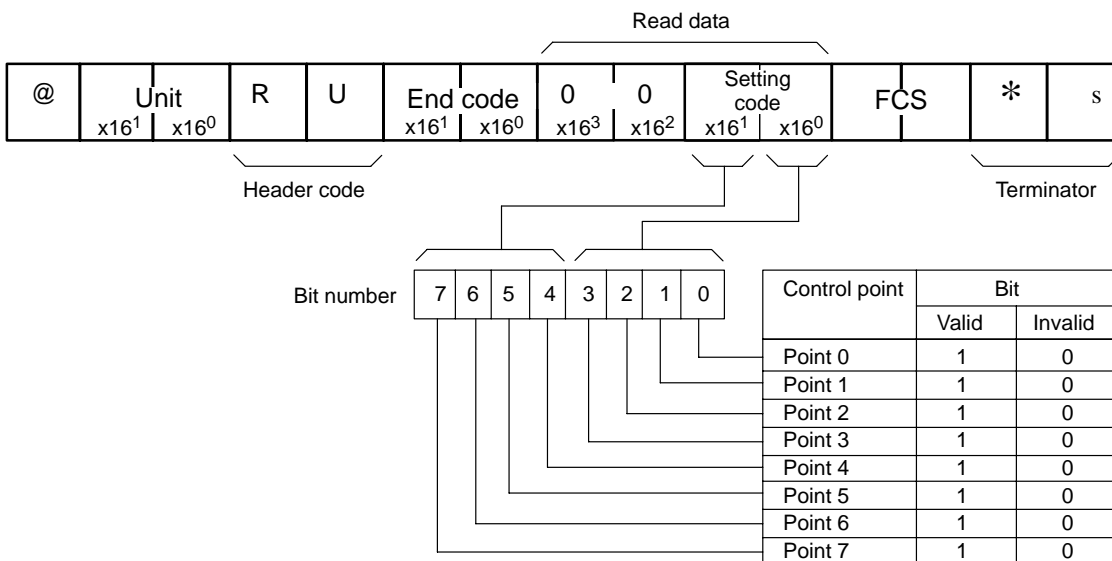

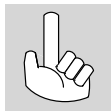

1. The response block for HB Alarm and HS Alarm Point Read (RU) does not include read data if the end code of the response block is other than 00.
2. Refer to 2-4 End Codes.

**Communications Example**

In this example, the E5ZE is operated with HB Alarm and HS Alarm Point Read (RU) under the following conditions.

Unit no.: 1  
 Control Points 0, 2, 4, and 6: Invalid  
 Control Points 1, 3, 5, and 7: Valid

**Command**

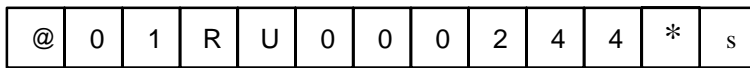

**Response**

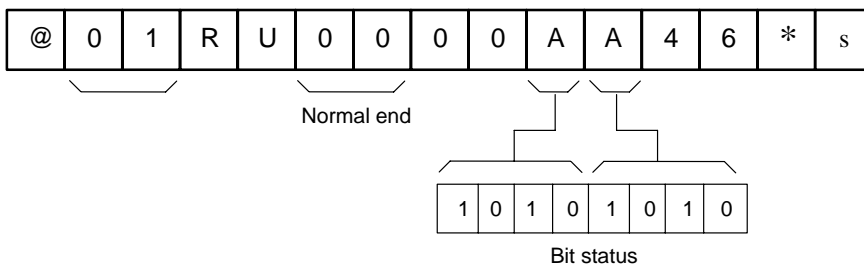

## 5-3 Heater Burnout and SSR Failure Detection Current Value Write: WW

**Function**

This command is used to set the current value at a control point to be used by the E5ZE to detect heater burnout or SSR failures at the control point.

**Setting Data Range**

<b>Function</b>	Heater burnout detection	SSR failure detection
<b>Setting unit</b>	0.1	
<b>Current unit</b>	A	
<b>Default</b>	0000	0005
<b>Setting data</b>	0000 to 0500	



Refer to the following to turn the HB alarm of a control point OFF or ON.

If the detection current value are set to 0000, the HB alarm will be always OFF.

If the detection current value are set to 0500, the HB alarm will be always ON.

**Command**

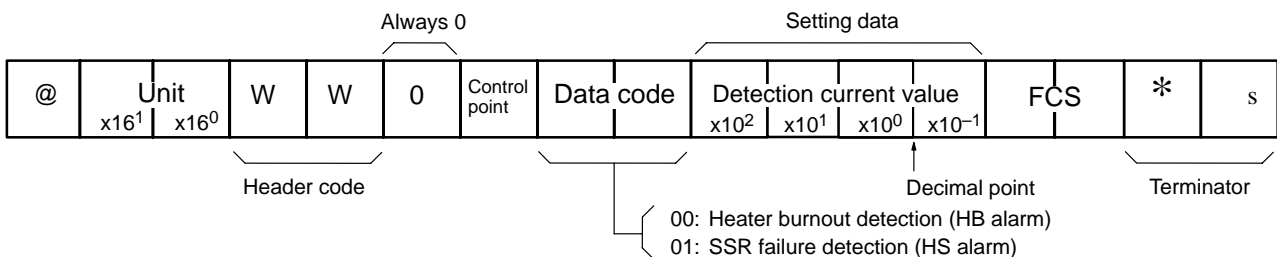



**Response**

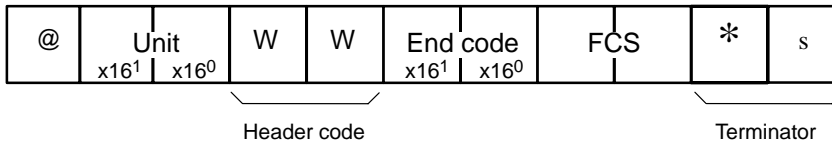

**Communications Example**

In this example, the E5ZE is operated with Heater Burnout and SSR Failure Detection Current Value Write (WW) under the following conditions.

Unit no.: 1

Control Point: 3

Heater Burnout Detection Current Value: 25.0 A

**Command**

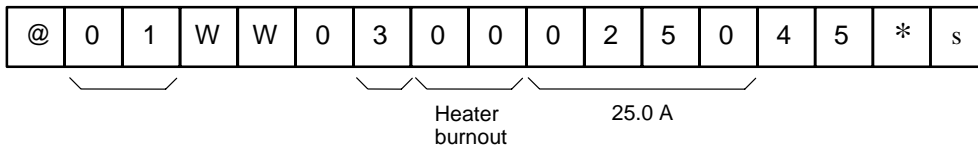

**Response**

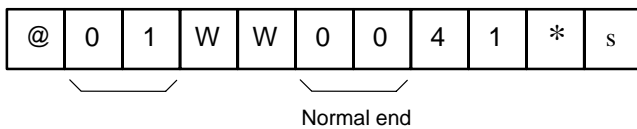

## 5-4 Heater Burnout and SSR Failure Detection Current Value Read: RW

**Function**

This command is used to read the current value set at a control point to be used by the E5ZE to detect heater burnout or SSR failures.

**Command**

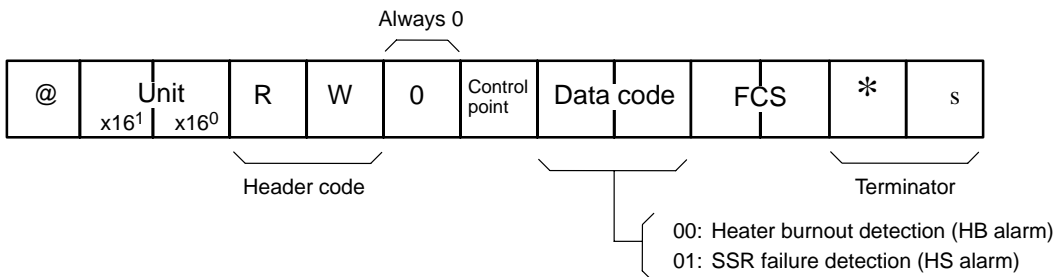

**Response**

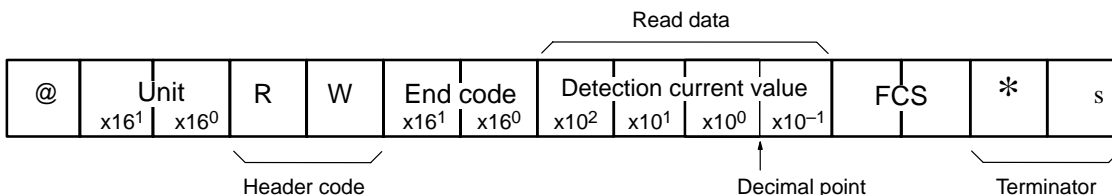

1. The response block for Heater Burnout and SSR Failure Detection Current Value Read (RW) does not include read data if the end code of the response block is other than 00.
2. Refer to 2-4 End Codes.

**Communications Example**

In this example, the E5ZE is operated with Heater Burnout and SSR Failure Detection Current Value Read (RW) under the following conditions.

Unit no.: 1

Control Point: 3

Heater Burnout Detection Current Value: 25.0 A

**Command**

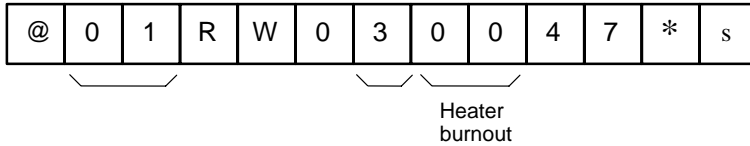

**Response**

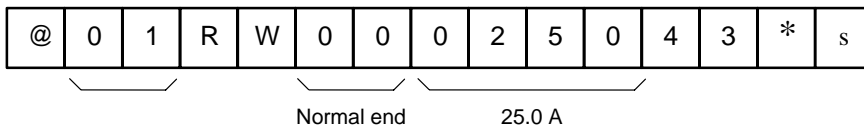

## 5-5 Heater Current Value and SSR Leakage Current Value Read: RZ

**Function**

This command is used so that the E5ZE can read the current value of the heater or the leakage current value of the SSR connected to a control point via the Current Transformer.



1. Heater Current Value: The current value of the heater measured at the control point with its control output turned ON.
2. SSR Leakage Current Value: The leakage current value of the SSR measured at the control point with its control output turned OFF.

**Command**

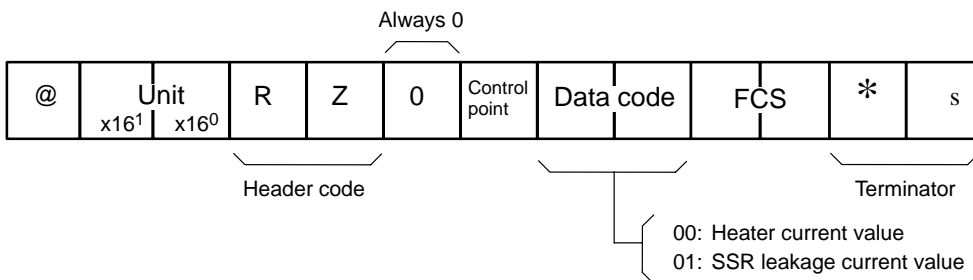

**Response**

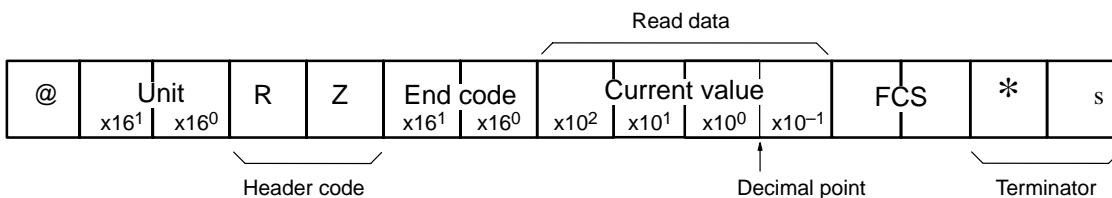

The current data of the response block for Heater Current Value and SSR Leakage Current Value Read (RZ) will be 0000 in the following cases.

The HB or HS alarm is not valid for the control point that has been designated.

The operation of the control point that has been designated is stopped.

**Response Block with Error Detected**

The response block for Heater Current Value and SSR Leakage Current Value Read (RZ) will include an error code if an error is detected by the E5ZE while the E5ZE is processing the command.

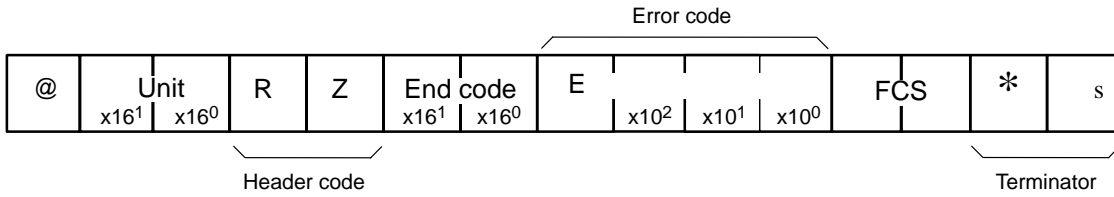

1. The response block for Heater Current Value and SSR Leakage Current Value Read (RZ) does not include read data or an error code if the end code of the response block is other than 00.
2. Refer to 2-4 End Codes and 2-5 Error Codes.

**Communications Example**

In this example, the E5ZE is operated with Heater Current Value and SSR Leakage Current Value Read (RZ) under the following conditions.

Unit no.: 1  
 Control Point: 3  
 Heater Current Value: 25.6 A

**Command**

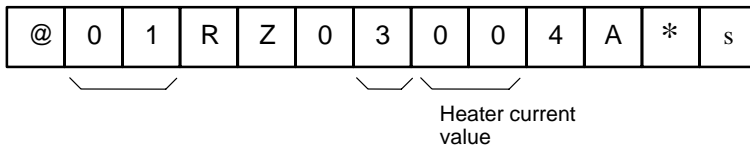

**Response**

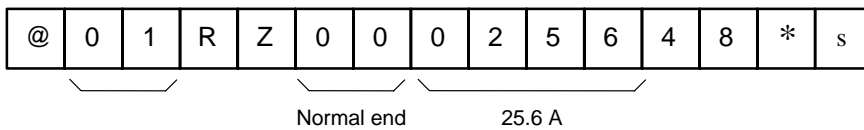

# SECTION 6

## Heating and Cooling Control Commands

This section describes the commands used for heating and cooling control.

6-1	Dead Band and Overlap Band Write: WD .....	80
6-2	Dead Band and Overlap Band Read: RD .....	81
6-3	Cooling Coefficient Write: WC .....	81
6-4	Cooling Coefficient Read: RC .....	82

## 6-1 Dead Band and Overlap Band Write: WD

### Function

This command is used to write the dead band or overlap band of a control output in heating and cooling control operation.



1. Refer to the following for the designation of the dead band or overlap band of a control output.
  - If positive parameters are set with Dead Band and Overlap Band Write (WD), the dead band of the control output will be designated.
  - If negative parameters are set with Dead Band and Overlap Band Write (WD), the overlap band of the control output will be designated.
2. Dead Band and Overlap Band Write (WD) cannot be used at a control point being auto-tuned.

### Setting Data Range

Setting unit	1	
°C or °F	°C	°F
Default	0000	
Setting data	-999 to 0999	

### Command

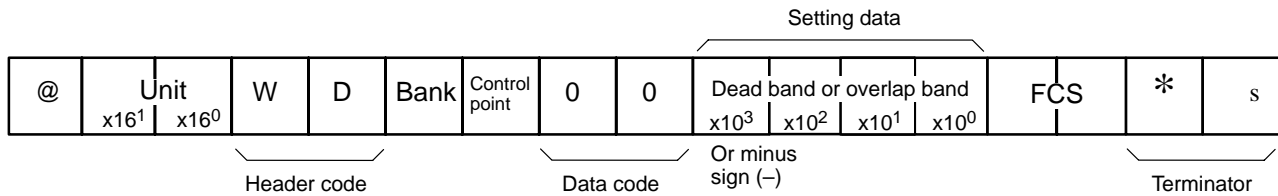

### Response

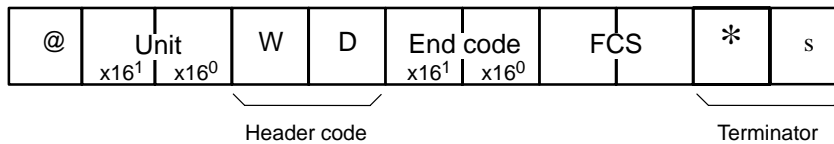

### Communications Example

In this example, the E5ZE is operated with Dead Band and Overlap Band Write (WD) under the following conditions.

Unit no.: 1  
 Memory Bank no.: 2  
 Control Point: 3  
 Overlap Band: 5°C

#### Command

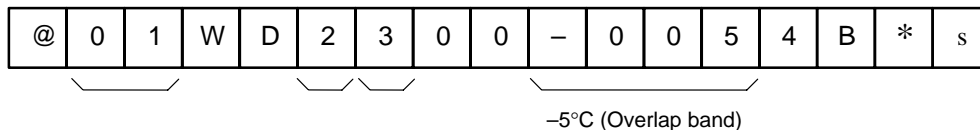

#### Response

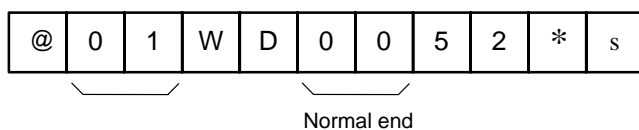

## 6-2 Dead Band and Overlap Band Read: RD

### Function

This command is used to read the dead bands or overlap bands that have been set at a control point.

### Command

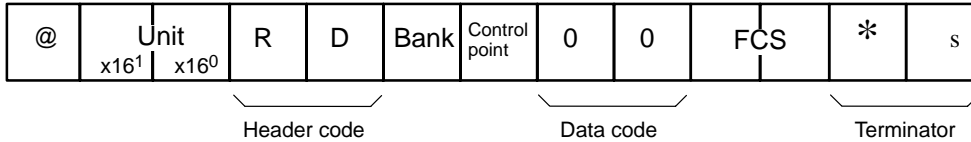

### Response

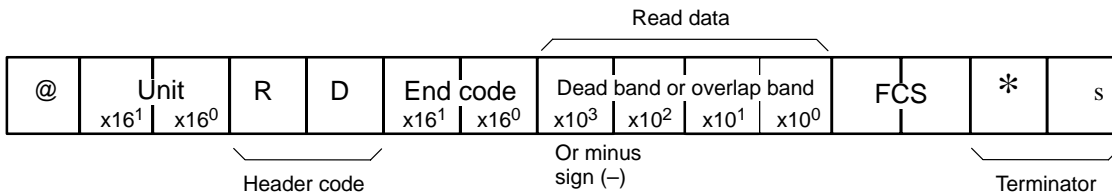

1. The response block for Dead Band and Overlap Band Read (RD) does not include read data if the end code of the response block is other than 00.
2. Refer to 2-4 End Codes.

### Communications Example

In this example, the E5ZE is operated with Dead Band and Overlap Band Read (RD) under the following conditions.

Unit no.: 1  
Memory Bank no.: 2  
Control Point: 3  
Overlap Band: 5°C

#### Command

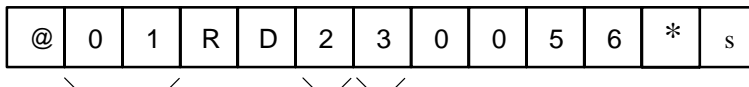

#### Response

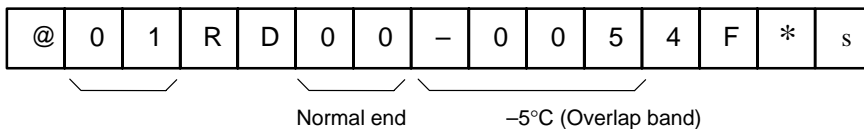

## 6-3 Cooling Coefficient Write: WC

### Function

This command is used to write cooling coefficients that designate cooling-side proportional bands to a control point in heating and cooling control operation.



1. The cooling-side proportional band to be set a control point is calculated according to the cooling coefficient and proportional band. Refer to the following formula.  
Cooling-side proportional band = Cooling coefficient x Proportional band
2. Cooling Coefficient Write (WC) cannot be used at a control point being auto-tuned.

**Setting Data Range**

Setting unit	0.1
Default	0010
Setting data	0000 to 0100



If the cooling coefficient of a control point set to 0000 is used for temperature control with the E5ZE, the percentage of the cooling-side control output will be always 0.

**Command**

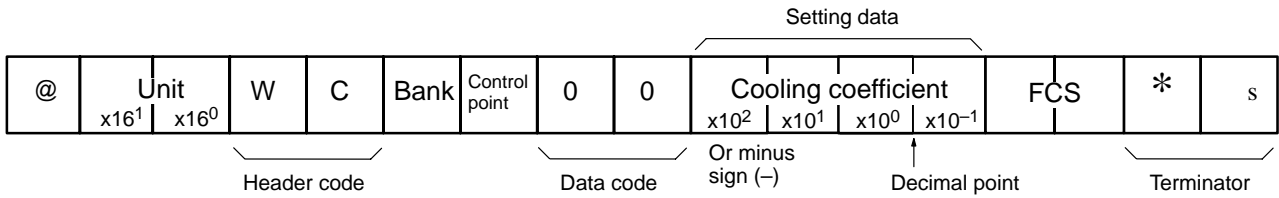

**Response**

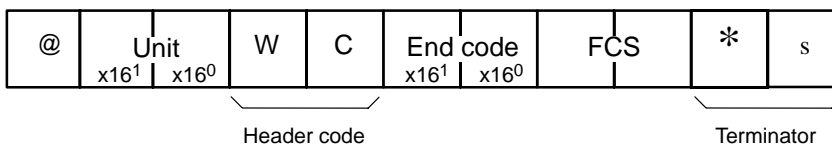

**Communications Example**

In this example, the E5ZE is operated with Cooling Coefficient Write (WC) under the following conditions.

- Unit no.: 1
- Memory Bank no.: 2
- Control Point: 3
- Cooling Coefficient: 1.5

**Command**

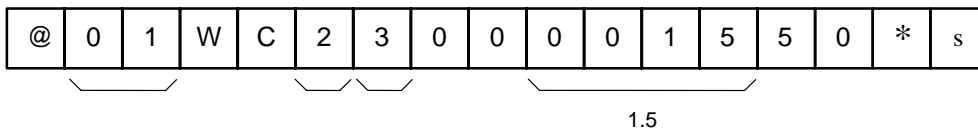

**Response**

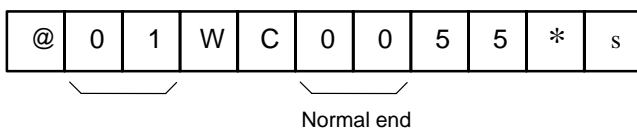

**6-4 Cooling Coefficient Read: RC**

**Function**

This command is used to read the cooling coefficients that have been set at a control point.

**Command**

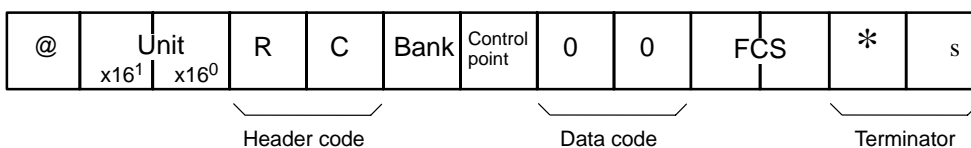

**Response**

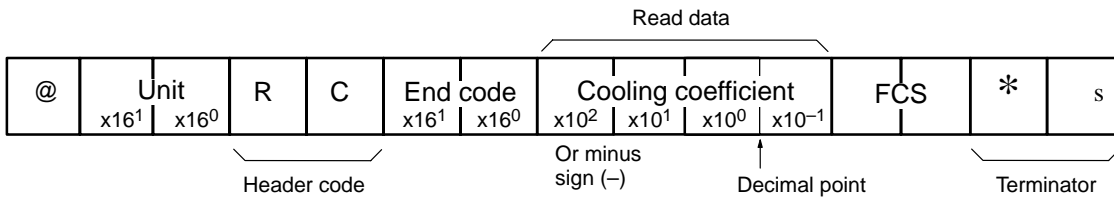

1. The response block for Cooling Coefficient Read (RC) does not include read data if the end code of the response block is other than 00.
2. Refer to 2-4 End Codes.

**Communications Example**

In this example, the E5ZE is operated with Cooling Coefficient Read (RC) under the following conditions.

- Unit no.: 1
- Memory Bank no.: 2
- Control Point: 3
- Cooling Coefficient: 1.5

**Command**



**Response**

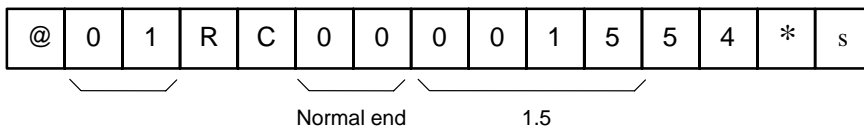



# SECTION 7

## Fuzzy Control Commands

This section describes the commands used for fuzzy control.

7-1	Fuzzy Strength Write: Wj .....	86
7-2	Fuzzy Strength Read: Rj .....	87
7-3	Fuzzy Scale 1 Write: Wk .....	87
7-4	Fuzzy Scale 1 Read: Rk .....	88
7-5	Fuzzy Scale 2 Write: Wl .....	89
7-6	Fuzzy Scale 2 Read: Rl .....	90

# 7-1 Fuzzy Strength Write: Wj

## Function

This command is used to write fuzzy strength to a control point.



Fuzzy Strength Write (Wj) cannot be used at a control point being auto-tuned.

## Setting Data Range

Setting unit	1
Fuzzy strength unit	%
Default	0050
Setting data	0000 to 0099



If the fuzzy strength of a control point set to 0000 is used for temperature control with the E5ZE, the E5ZE will not be in fuzzy control operation.

## Command

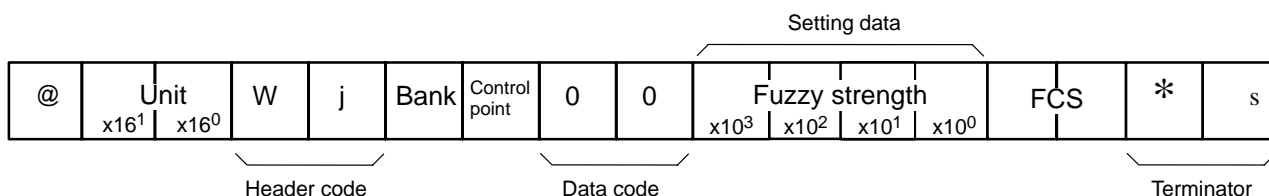

## Response

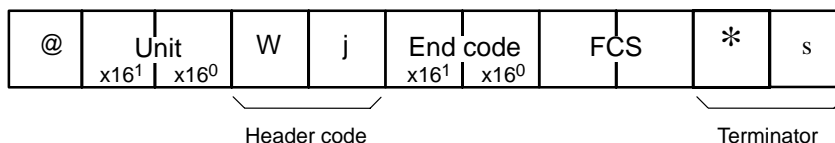

## Communications Example

In this example, the E5ZE is operated with Fuzzy Strength Write (Wj) under the following conditions.

- Unit no.: 1
- Memory bank no.: 2
- Control point: 3
- Fuzzy strength: 45%

### Command

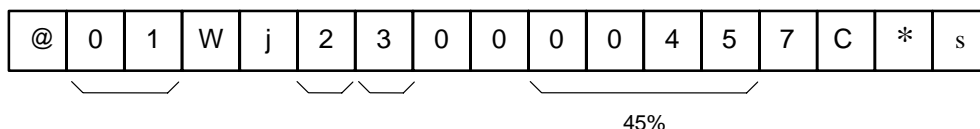

### Response

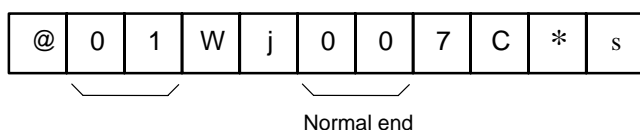

## 7-2 Fuzzy Strength Read: Rj

### Function

This command is used to read the fuzzy strength that have been set at a control point.

### Command

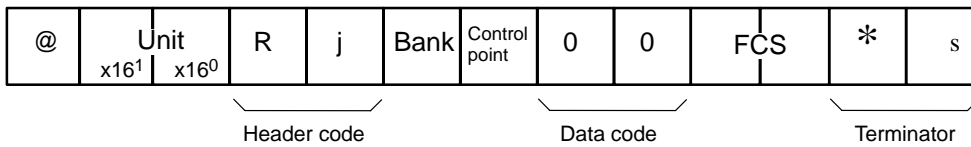

### Response

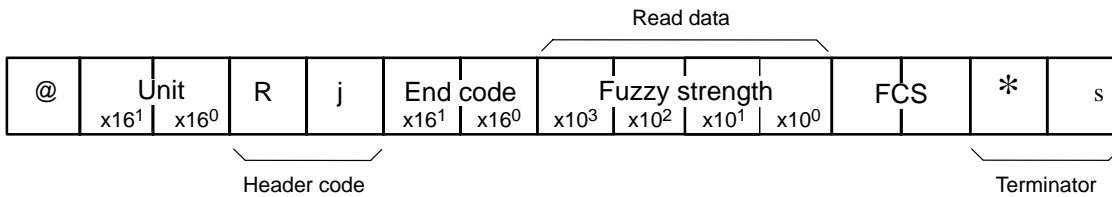

1. The response block for Fuzzy Strength Read (Rj) does not include read data if the end code of the response block is other than 00.
2. Refer to 2-4 End Codes.

### Communications Example

In this example, the E5ZE is operated with Fuzzy Strength Read (Rj) under the following conditions.

Unit no.: 1  
 Memory bank no.: 2  
 Control point: 3  
 Fuzzy strength: 45%

### Command

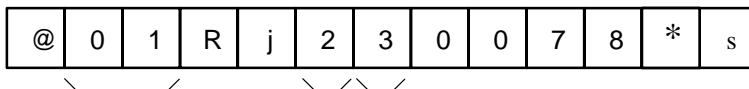

### Response

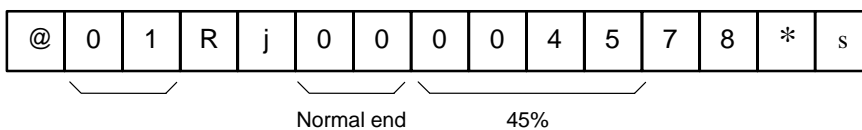

## 7-3 Fuzzy Scale 1 Write: Wk

### Function

This command is used to write fuzzy scale 1 values to a control point for the E5ZE to determine external disturbance scales.



1. Fuzzy Scale 1 Write (Wk) cannot be used at a control point being auto-tuned.
2. Fuzzy scale 1 values for a control point being auto-tuned will be set automatically when the auto-tuning of the control point finishes.
3. The fuzzy scale 1 value of a control point will be automatically adjusted according to the PID constants. The fuzzy scale 1 value can be changed manually after PID constants are set for the bank.

**Setting Data Range**

Setting unit	0.1	
°C or °F	°C	°F
Default	9999	
Setting data	0002 to 9999	

**Command**

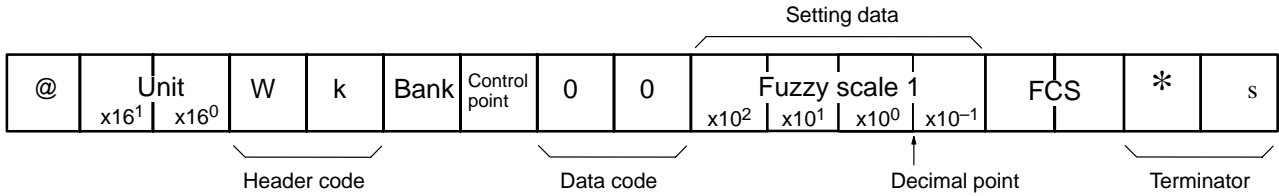

**Response**

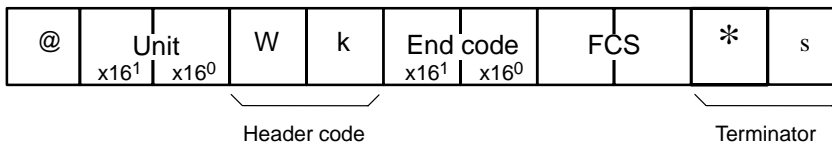

**Communications Example**

In this example, the E5ZE is operated with Fuzzy Scale 1 Write (Wk) under the following conditions.

- Unit no.: 1
- Memory bank no.: 2
- Control point: 3
- Fuzzy scale 1: 40.0°C

**Command**

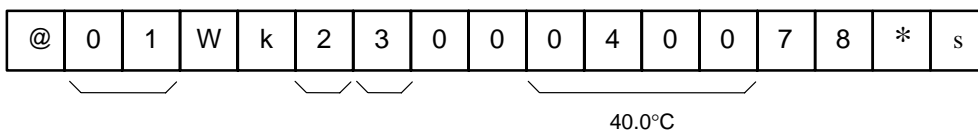

**Response**

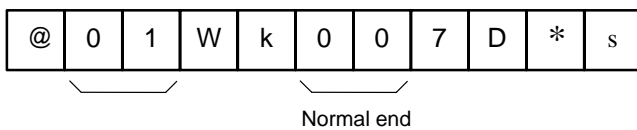

**7-4 Fuzzy Scale 1 Read: Rk**

**Function**

This command is used to read the fuzzy scale 1 values that have been set at a control point.

**Command**

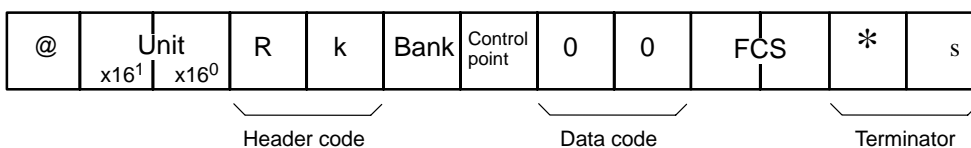

**Response**

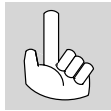
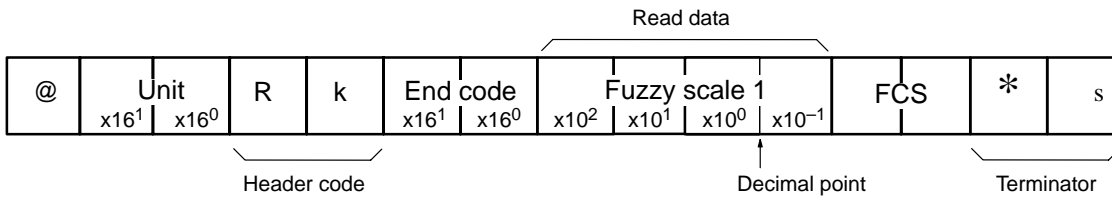

1. The response block for Fuzzy Scale 1 Read (Rk) does not include read data if the end code of the response block is other than 00.
2. Refer to 2-4 End Codes.

**Communications Example**

In this example, the E5ZE is operated with Fuzzy Scale 1 Read (Rk) under the following conditions.

Unit no.: 1  
 Memory bank no.: 2  
 Control point: 3  
 Fuzzy scale 1: 40.0°C

**Command**

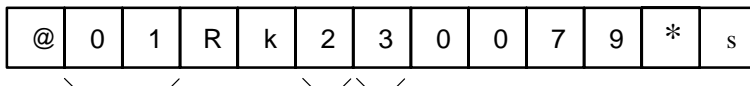

**Response**

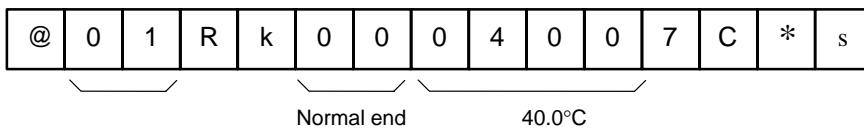

**7-5 Fuzzy Scale 2 Write: Wl**

**Function**

This command is used to write fuzzy scale 2 values to a control point for the E5ZE to determine the speeds of temperature changes due to external disturbance.



1. Fuzzy Scale 2 Write (Wl) cannot be used at a control point being auto-tuned.
2. Fuzzy scale 2 values for a control point being auto-tuned will be set automatically when the auto-tuning of the control point finishes.
3. The fuzzy scale 2 value of a control point will be automatically adjusted according to the PID constants. The fuzzy scale 2 value can be changed manually after PID constants are set for the bank.

**Setting Data Range**

<b>Setting unit</b>	0.01	
<b>°C or °F</b>	°C/s	°F/s
<b>Default</b>	9999	
<b>Setting data</b>	0020 to 9999	

**Command**

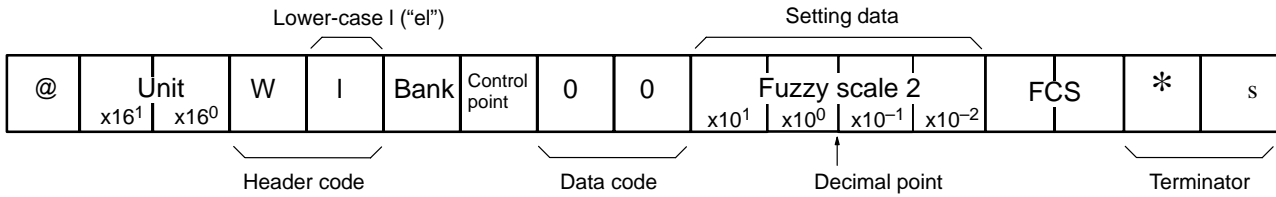

**Response**

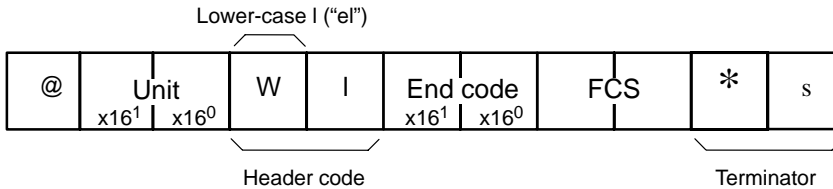

**Communications Example**

In this example, the E5ZE is operated with Fuzzy Scale 2 Write (WI) under the following conditions.

- Unit no.: 1
- Memory bank no.: 2
- Control point: 3
- Fuzzy scale 2: 3.00°C/s

**Command**

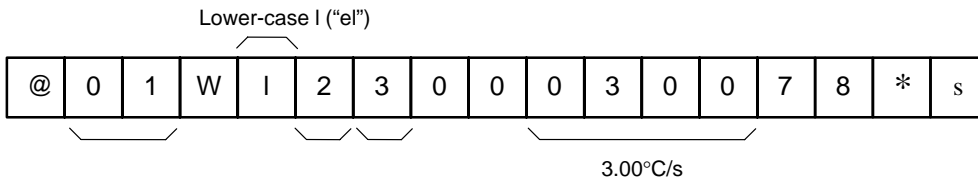

**Response**

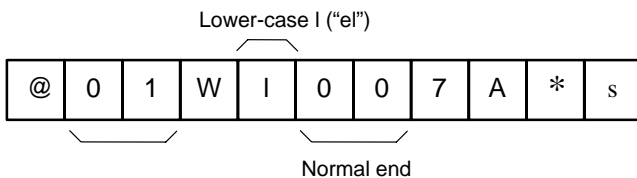

**7-6 Fuzzy Scale 2 Read: RI**

**Function**

This command is used to read the fuzzy scale 2 values that have been set at a control point.

**Command**

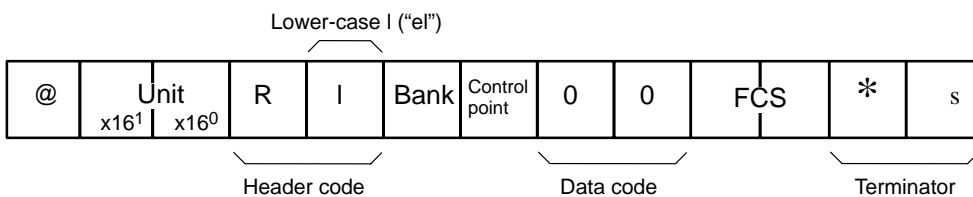

**Response**

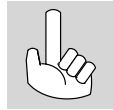
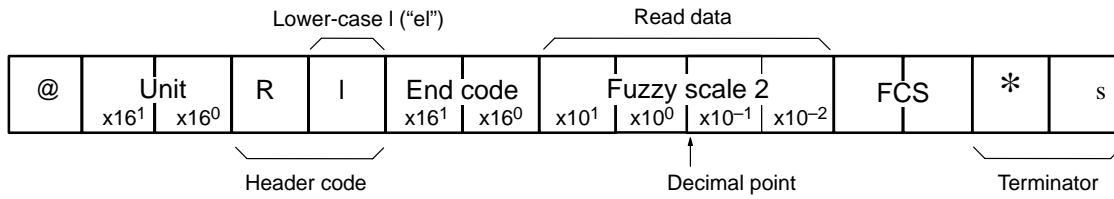

1. The response block for Fuzzy Scale 2 Read (RI) does not include read data if the end code of the response block is other than 00.
2. Refer to 2-4 End Codes.

**Communications Example**

In this example, the E5ZE is operated with Fuzzy Scale 2 Read (RI) under the following conditions.

- Unit no.: 1
- Memory bank no.: 2
- Control point: 3
- Fuzzy scale 2: 3.00°C/s

**Command**

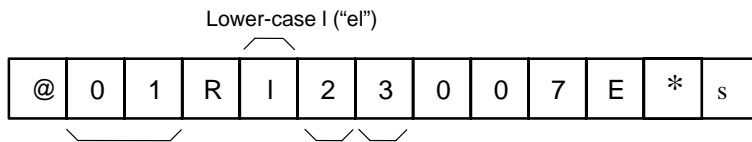

**Response**

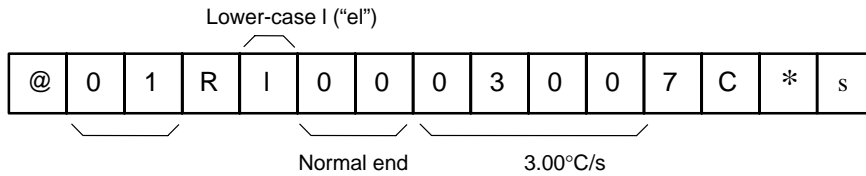

# SECTION 8

## Control Operation Start and Stop Commands

This section describes the commands used for starting and stopping operation.

8-1	Operation Start: OS .....	94
8-2	Operation Stop: OP .....	94
8-3	Manual Operation Start: OM .....	95



## 8-1 Operation Start: OS

### Function

This command is used to designate a control point to start temperature control.

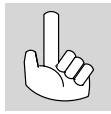

1. Operation Start (OS) cannot be used at a control point being auto-tuned.
2. Operation Start (OS) will be ignored by a control point in control operation.

### Command

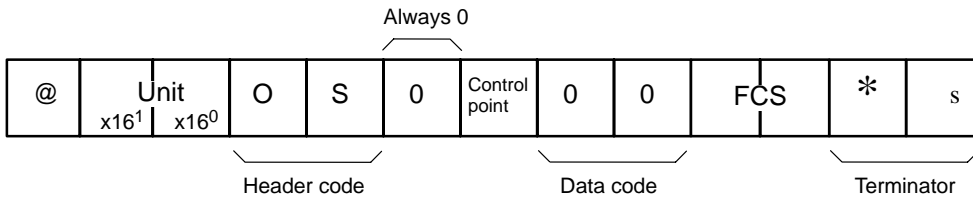

### Response

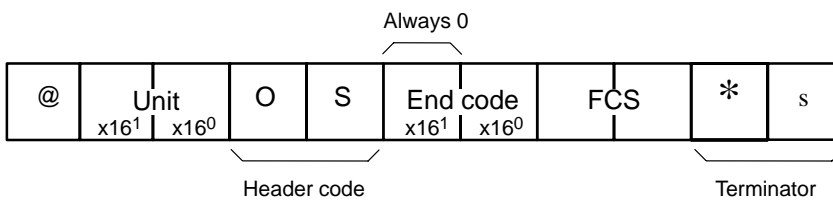

### Communications Example

In this example, control point 3, the unit number of which has been set to 1, starts temperature control with Operation Start (OS).

#### Command

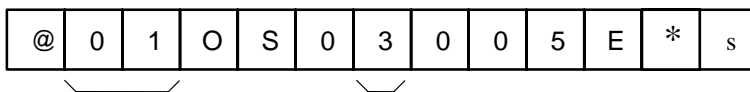

#### Response

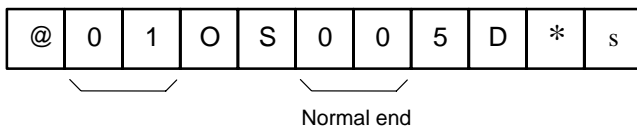

## 8-2 Operation Stop: OP

### Function

This command is used to designate a control point to stop temperature control or manual operation.



If a control point is stopped, all alarm output of the control point will be OFF.

### Command

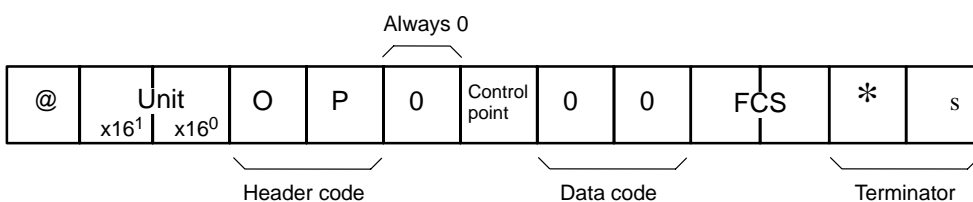

**Response**

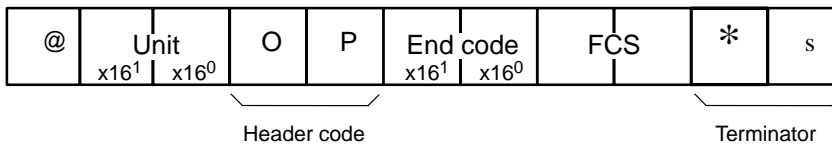

**Communications Example**

In this example, control point 3, the unit number of which has been set to 1, stops temperature control with Operation Stop (OP).

**Command**

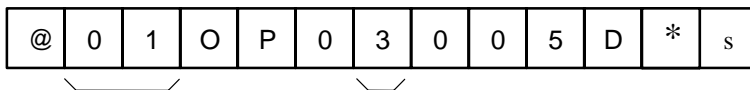

**Response**

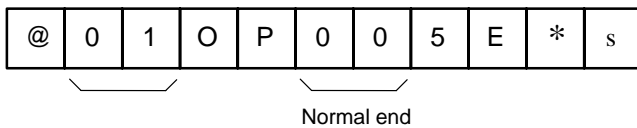

## 8-3 Manual Operation Start: OM

**Function**

This command is used to designate a control point to start manual operation with the output value that has been preset.



1. Manual Operation Start (OM) cannot be used at a control point being auto-tuned.
2. Manual Operation Start (OM) will be ignored by a control point in manual operation.

**Command**

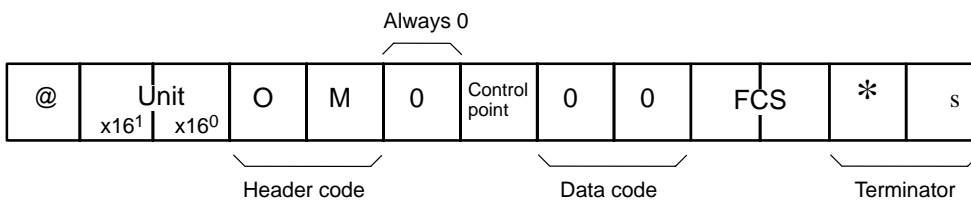

**Response**

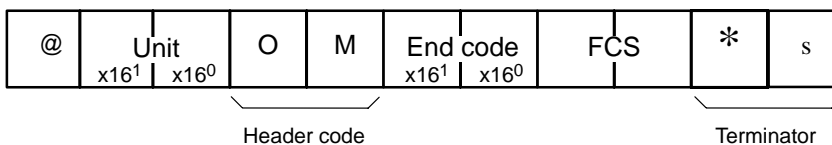

**Communications Example**

In this example, control point 3, the unit number of which has been set to 1, starts manual operation with Manual Operation Start (OM).

**Command**

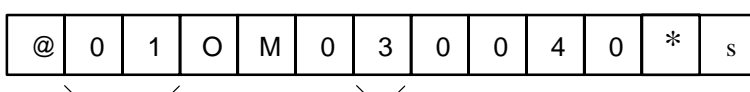

Response

@	0	1	O	M	0	0	4	3	*	s
---	---	---	---	---	---	---	---	---	---	---

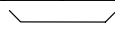
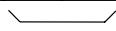

Normal end

# Appendix A

## Communication Program Example

This appendix describes a communication program example for the host computer connected to the E5ZE.

### Use

The program in BASIC on the following pages can be used to test if the E5ZE can communicate trouble-free with the host computer.

The transmission command must include the start character, @, and the last character of the text.

When the carriage return key is pressed, the FCS will be calculated and the command will be transmitted to the E5ZE with a terminator.



This program is written so that the host computer will not try to resend a command when a communications error occurs. A mass-production program must be written so that the host computer will try to resend a command at least 10 times or more when the host computer has trouble communicating with the E5ZE.

### Application Examples

The underlined characters and figures must be input.

#### Example 1

In this example, the E5ZE is operated with Set Point Write (WS) under the following conditions.

Unit no.: 0  
Memory Bank no.: 0  
Control Point: 0  
Set Point: 100°C

The program is executed.

SEND=-?-@00WS00000100s Set the set point to 100°C.  
RECV=---@00WS0044\*s The set temperature has been set to 100°C.

#### Example 2

In this example, the E5ZE is operated with Measured Temperature Read (RX) under the following conditions.

Unit no.: 0  
Memory Bank no.: 0  
Control Point: 0  
Measured Temperature: 50°C

The program is executed.

SEND=-?-@00RX0000s Read the measured temperature.  
RECV=---@00RX0000504F\*s A measured temperature of 50°C has been read.

## Program

The following program was operated in quick BASIC on an IBM PC compatible machine.

```
1000 '-----
1010 '   program      : E5ZE RS232-C COMMUNICATIONS PROGRAM
1020 '                                     for IBM PC COMPATIBLE MACHINE
1030 '   file        : E5ZE_CMD.BAS
1040 '   version     : 1.00
1050 '   Copyright (C) 1995 OMRON Corporation All Rights Reserved.
1060 '-----
1070 ' Below shows the program example using test command with RS232-C, RS422
1080 ' and RS485.
1090 ' If the program is not executed correctly, check the DIP switch settings
1100 ' and communication cable connection.
1110 '-----
1120 '
1130 CLS
1140 '
1150 '-----RS232-C SPEED:9600BPS, PALITY:EVEN, DATA:7, STOP:2-----
1160 '
1170 OPEN "COM1:9600,E,7,2,CDO,CSO,DSO,RB256,RS" FOR RANDOM AS #1 LEN = 256
1180 '
1190 REPEAT:
1200 '
1210 '-----MAKE COMMAND-----
1220 '
1230 PRINT "SEND= ";
1240 INPUT SEND$
1250 '
1260 '-----FRAME CHECK SEQUENCE CALCULATION-----
1270 '
1280 FCS% = 0
1290 FOR 1% = 1 TO LEN(SEND$)
1300   FCS% = FCS% XOR ASC(MID$(SEND$, 1%, 1))
1310 NEXT 1%
1320 FCS$ = RIGHT$("0" + HEX$(FCS%), 2)
1330 '
1340 '-----SEND COMMAND-----
1350 '
1360 PRINT #1, SEND$ + FCS$ + "*"
1370 '
1380 '-----WAIT FOR RESPONSE-----
1390 '
1400 RESWAIT! = 0!
1410 RESFLAG% = 0
1420 WHILE (RESWAIT! < 1000! AND RESFLAG% = 0)
1430   RESWAIT! = RESWAIT! + .1
1440   IF LOC(1) > 0 THEN RESFLAG% = 1
1450 WEND
1460 '
1470 '-----READ RESPONSE-----
1480 '
1490 IF RESFLAG% = 0 THEN
```

```
1500 PRINT "NO RESPONSE !!"
1510 ELSE
1520 LINE INPUT #1, RESPONSE$: PRINT "RECV= "; RESPONSE$
1530 END IF
1540 '
1550 '-----REPEAT TO MAKE COMMAND-----
1560 '
1570 GOTO REPEAT
1580 '
1590 '-----END-----
1600 CLOSE #1
1610 END
```

## Appendix B ASCII Code List

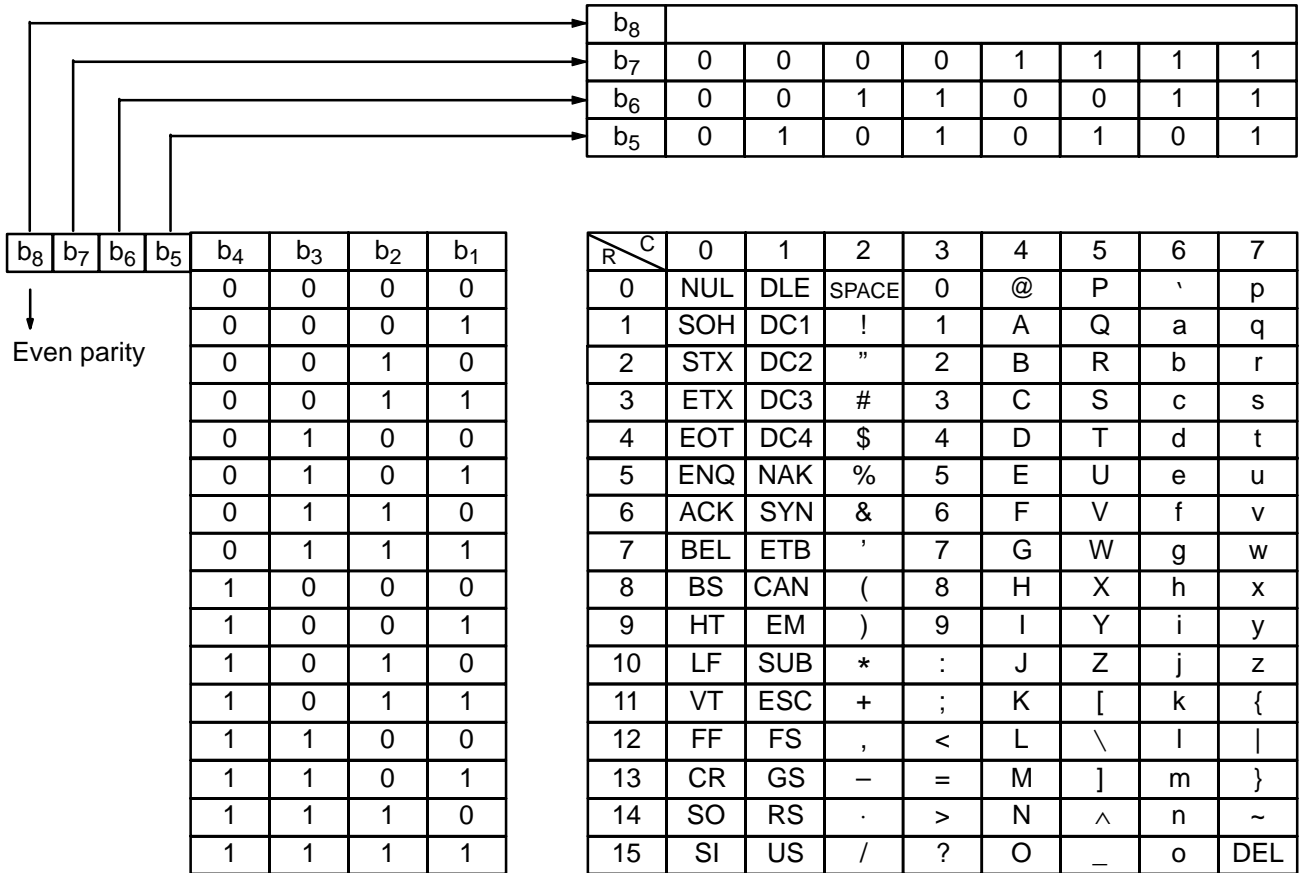

# Index

## A–B

Alarm Mode Read: R#, 7, 38  
Alarm Mode Write: W#, 7, 36  
Alarm Temperature Read: R%, 8, 40  
Alarm Temperature Write: W%, 8, 39  
AP, 9, 53  
AS, 9, 52  
ASCII, code list, 101  
Auto-tuning Bit, 47  
Auto-tuning Start: AS, 9, 52  
Auto-tuning Stop: AP, 9, 53  
block format, 3

## C

character check, 4  
Cold Junction Compensation Error, 49  
command block, 2  
commands  
  according to application, 51  
  list, 9  
  control operation start and stop, 93  
  list, 12  
  fuzzy control, 85  
  list, 11  
  heater burnout and SSR failure detection, 71  
  list, 10  
  heating and cooling control, 79  
  list, 11  
  list, 6  
  temperature control, 21  
  list, 6  
communication program, 97  
  example, 97  
Communication Test: TS, 10, 69  
communications  
  errors, 4  
  procedure, 2  
Control Mode Bit, 47  
control output, read, percentage, 6, 26  
Control Period Read: RT, 7, 33  
Control Period Write: WT, 7, 32  
Cooling Coefficient Read: RC, 11, 82  
Cooling Coefficient Write: WC, 11, 81  
CPU Error, 49  
Current Transformer Input AD Error, 49

## D

Dead Band and Overlap Band Read: RD, 11, 81  
Dead Band and Overlap Band Write: WD, 11, 80  
Derivative Time Read: RV, 7, 31  
Derivative Time Write: WV, 7, 30

## E

end codes  
  list, 16  
  priority, 18  
error  
  cold junction compensation, 49  
  CPU, 49  
  current transformer input AD, 49  
  detection, 4  
  memory, 49  
  processing, 4  
  sensor input AD, 49  
  setting data, 49  
error codes, list, 19  
Error Read: RU, 8, 48  
errors, undefined, 19

## F

FCS, 3, 4  
  calculations, 3  
format check, 4  
Frame Check Sequence. *See* FCS  
framing check, 4  
Fuzzy Scale 1 Read: Rk, 11, 88  
Fuzzy Scale 1 Write: Wk, 11, 87  
Fuzzy Scale 2 Read: Rl, 11, 90  
Fuzzy Scale 2 Write: Wl, 11, 89  
Fuzzy Strength Read: Rj, 11, 87  
Fuzzy Strength Write: Wj, 11, 86

## H

HB Alarm and HS Alarm Point Read: RU, 10, 73  
HB Alarm and HS Alarm Point Write: WU, 10, 72  
header code, 3  
Heater Burnout and SSR Failure Detection Current Value Read:  
  RW, 10, 75  
Heater Burnout and SSR Failure Detection Current Value  
  Write: WW, 10, 74



Heater Current Overflow Bit, 47

Heater Current Value and SSR Leakage Current Value Read:  
RZ, 10, 76

Hysteresis Read: RH, 8, 44

Hysteresis Write: WH, 8, 43

## I

Initialize Setting Data: MC, 10, 68

Input Shift Read: RI, 9, 56

Input Shift Write: WI, 9, 55

Integral Time Read: RN, 6, 29

Integral Time Write: WN, 6, 28

## M–N

Manual Operation Start: OM, 12, 95

Manual Output Value Write: WO, 9, 62

Manual Reset Value Read: RK, 9, 58

Manual Reset Value Write: WK, 9, 57

MC, 10, 68

Measured Temperature Read: RX, 6, 24

Memory Bank Designation Read: RM, 8, 42

Memory Bank Designation Write: WM, 8, 41

Memory Error, 49

Memory Write Bit, 47

Memory Write: WE, 10, 67

numeric value check, 4

## O

OM, 12, 95

OP, 12, 94

Operation Start: OS, 12, 94

Operation Stop: OP, 12, 94

OS, 12, 94

Output Operation (Normal/Reverse) Read: RU, 7, 35

Output Operation (Normal/Reverse) Write: WU, 7, 34

Output Operation Bit, 47

Output Value Read: RO, 6, 26

Output Variable Change Rate Limit Value Read: RG, 10, 67

Output Variable Change Rate Limit Value Write: WG, 10, 66

Output Variable Limit Value Read: RL, 10, 65

Output Variable Limit Value Write: WL, 10, 63

overrun check, 4

## P

Present Set Point Read: Rs, 9, 61

process value, read, 6

Process Value Overflow Bit, 47

Process Value Underflow Bit, 47

Proportional Band Read: RB, 6, 28

Proportional Band Write: WB, 6, 27

## R

R#, 7, 38

R%, 8, 40

Ramp Value Read: RR, 9, 60

Ramp Value Write: WR, 9, 59

RB, 6, 28

RC, 11, 82

RD, 11, 81

reading data, 14

reception buffer, 2

response block, 2

RG, 10, 67

RH, 8, 44

RI, 9, 56

Rj, 11, 87

RK, 9, 58

Rk, 11, 88

RL, 10, 65

RI, 11, 90

RM, 8, 42

RN, 6, 29

RO, 6, 26

RR, 9, 60

RS, 6, 23

Rs, 9, 61

RT, 7, 33

Rt, 9, 55

RU, 7, 8, 10, 35, 48, 73

RUN Status Bit, 47

RV, 7, 31

RW, 10, 75

RX, 6, 8, 24, 45

RZ, 10, 76

**S**

Sensor Input AD Error, 49  
Sensor Input Error Bit, 47  
Set Point Read: RS, 6, 23  
Set Point Write: WS, 6, 22  
Setting Data Error, 49  
setting unit, temperature  
  read, 9, 55  
  write, 9, 53  
Setting Unit Read: Rt, 9, 55  
Setting Unit Write: Wt, 9, 53  
start character, 3  
Status Read: RX, 8, 45

**T–V**

terminator, 3  
text, 3  
TS, 10, 69  
unit number, 3  
vertical parity check, 4

**W**

W#, 7, 36  
W%, 8, 39  
WB, 6, 27  
WC, 11, 81  
WD, 11, 80  
WE, 10, 67  
WG, 10, 66  
WH, 8, 43  
WI, 9, 55  
Wj, 11, 86  
WK, 9, 57  
Wk, 11, 87  
WL, 10, 63  
Wl, 11, 89  
WM, 8, 41  
WN, 6, 28  
WO, 9, 62  
WR, 9, 59  
writing data, 12  
WS, 6, 22  
WT, 7, 32  
Wt, 9, 53  
WU, 7, 10, 34, 72  
WV, 7, 30  
WW, 10, 74

## Revision History

A manual revision code appears as a suffix to the catalog number on the front cover of the manual.

Cat. No. H77-E1-1

↑  
— Revision code

The following table outlines the changes made to the manual during each revision. Page numbers refer to the previous version.

Revision code	Date	Revised content
1	April 1997	Original production

**E5ZE**  
**Multipoint Temperature Controller**  
**Communications Manual**

*Produced April 1997*



## Notice:

OMRON products are manufactured for use according to proper procedures by a qualified operator and only for the purposes described in this manual.

The following conventions are used to indicate and classify precautions in this manual. Always heed the information provided with them. Failure to heed precautions can result in injury to people or damage to the product.



### **DANGER**

Indicates information that, if not heeded, is likely to result in loss of life or serious injury.



### **WARNING**

Indicates information that, if not heeded, could possibly result in loss of life or serious injury.



### **Caution**

Indicates information that, if not heeded, could result in relatively serious or minor injury, damage to the product, or faulty operation.

## OMRON Product References

All OMRON products are capitalized in this manual. The word "Unit" is also capitalized when it refers to an OMRON product, regardless of whether or not it appears in the proper name of the product.

The abbreviation "Ch," which appears in some displays and on some OMRON products, often means "word" and is abbreviated "Wd" in documentation in this sense.

The abbreviation "PC" means Programmable Controller and is not used as an abbreviation for anything else.

## Visual Aids

The following headings and icons appear in the left column of the manual to help you locate different types of information.

### **1, 2, 3...**

1. Indicates lists of one sort or another, such as procedures, checklists, etc.



Indicates information of particular interest for efficient and convenient operation of the product.



Indicates that extra, useful information follows, such as supplementary explanations and how to apply functions.

## © OMRON, 1997

All rights reserved. No part of this publication may be reproduced, stored in a retrieval system, or transmitted, in any form, or by any means, mechanical, electronic, photocopying, recording, or otherwise, without the prior written permission of OMRON.

No patent liability is assumed with respect to the use of the information contained herein. Moreover, because OMRON is constantly striving to improve its high-quality products, the information contained in this manual is subject to change without notice. Every precaution has been taken in the preparation of this manual. Nevertheless, OMRON assumes no responsibility for errors or omissions. Neither is any liability assumed for damages resulting from the use of the information contained in this publication.



# TABLE OF CONTENTS

## SECTION 1

<b>Communications Control</b> .....	<b>1</b>
1-1 Communications and Checks .....	2

## SECTION 2

<b>Commands and Responses</b> .....	<b>5</b>
2-1 Commands .....	6
2-2 Writing Sets of Data .....	12
2-3 Reading Sets of Data .....	14
2-4 End Codes .....	16
2-5 Error Codes .....	19

## SECTION 3

<b>Basic Temperature Control Commands</b> .....	<b>21</b>
3-1 Set Point Write: WS .....	22
3-2 Set Point Read: RS .....	23
3-3 Measured Temperature Read: RX .....	24
3-4 Output Value Read: RO .....	26
3-5 Proportional Band Write: WB .....	27
3-6 Proportional Band Read: RB .....	28
3-7 Integral Time Write: WN .....	28
3-8 Integral Time Read: RN .....	29
3-9 Derivative Time Write: WV .....	30
3-10 Derivative Time Read: RV .....	31
3-11 Control Period Write: WT .....	32
3-12 Control Period Read: RT .....	33
3-13 Output Operation (Normal/Reverse) Write: WU .....	34
3-14 Output Operation (Normal/Reverse) Read: RU .....	35
3-15 Alarm Mode Write: W# .....	36
3-16 Alarm Mode Read: R# .....	38
3-17 Alarm Temperature Write: W% .....	39
3-18 Alarm Temperature Read: R% .....	40
3-19 Memory Bank Designation Write: WM .....	41
3-20 Memory Bank Designation Read: RM .....	42
3-21 Hysteresis Write: WH .....	43
3-22 Hysteresis Read: RH .....	44
3-23 Status Read: RX .....	45
3-24 Error Read: RU .....	48

## SECTION 4

<b>Commands According to Application</b> .....	<b>51</b>
4-1 Auto-tuning Start: AS .....	52
4-2 Auto-tuning Stop: AP .....	53
4-3 Setting Unit Write: Wt .....	53
4-4 Setting Unit Read: Rt .....	55
4-5 Input Shift Write: WI .....	55
4-6 Input Shift Read: RI .....	56
4-7 Manual Reset Value Write: WK .....	57
4-8 Manual Reset Value Read: RK .....	58
4-9 Ramp Value Write: WR .....	59
4-10 Ramp Value Read: RR .....	60
4-11 Present Set Point Read: Rs .....	61



# TABLE OF CONTENTS

4-12	Manual Output Value Write: WO	62
4-13	Output Variable Limit Value Write: WL	63
4-14	Output Variable Limit Value Read: RL	65
4-15	Output Variable Change Rate Limit Value Write: WG	66
4-16	Output Variable Change Rate Limit Value Read: RG	67
4-17	Memory Write: WE	67
4-18	Initialize Setting Data: MC	68
4-19	Communication Test: TS	69
<b>SECTION 5</b>		
<b>Heater Burnout and SSR Failure Detection Commands</b>		<b>71</b>
5-1	HB Alarm and HS Alarm Point Write: WU	72
5-2	HB Alarm and HS Alarm Point Read: RU	73
5-3	Heater Burnout and SSR Failure Detection Current Value Write: WW	74
5-4	Heater Burnout and SSR Failure Detection Current Value Read: RW	75
5-5	Heater Current Value and SSR Leakage Current Value Read: RZ	76
<b>SECTION 6</b>		
<b>Heating and Cooling Control Commands</b>		<b>79</b>
6-1	Dead Band and Overlap Band Write: WD	80
6-2	Dead Band and Overlap Band Read: RD	81
6-3	Cooling Coefficient Write: WC	81
6-4	Cooling Coefficient Read: RC	82
<b>SECTION 7</b>		
<b>Fuzzy Control Commands</b>		<b>85</b>
7-1	Fuzzy Strength Write: Wj	86
7-2	Fuzzy Strength Read: Rj	87
7-3	Fuzzy Scale 1 Write: Wk	87
7-4	Fuzzy Scale 1 Read: Rk	88
7-5	Fuzzy Scale 2 Write: Wl	89
7-6	Fuzzy Scale 2 Read: Rl	90
<b>SECTION 8</b>		
<b>Control Operation Start and Stop Commands</b>		<b>93</b>
8-1	Operation Start: OS	94
8-2	Operation Stop: OP	94
8-3	Manual Operation Start: OM	95
<b>Appendices</b>		
	A Communication Program Example	97
	B ASCII Code List	101
<b>Index</b>		<b>103</b>
<b>Revision History</b>		<b>107</b>

## About this Manual:

This manual provides information on E5ZE Multipoint Temperature Controller communications and includes the sections described below.

In addition, a total of two manuals are provided for the E5ZE Multipoint Temperature Controller as follows:

When using the general features of the E5ZE Multipoint Temperature Controller:

*E5ZE Multipoint Temperature Controller Operation Manual (Cat. No. H76-E1-1)*

When using the communications features:

*E5ZE Multipoint Temperature Controller Communications Manual (Cat. No. H77-E1-1)*

Please read this manual carefully and be sure you understand the information provided before attempting to operate the E5ZE Multipoint Temperature Controller.

**Section 1** provides general information on communications and checks.

**Section 2** provides a list of commands, end codes, and error codes. Information on writing and reading data sets are also provided.

**Section 3** describes the basic temperature control commands.

**Section 4** describes the commands that are used according to the application.

**Section 5** describes the commands used for heater burnout and SSR failure detection.

**Section 6** describes the commands used for heating and cooling control.

**Section 7** describes the commands used for fuzzy control.

**Section 8** describes the commands used for starting and stopping operation.

The **Appendices** provide a communications program example and an ASCII code list.



**WARNING** Failure to read and understand the information provided in this manual may result in personal injury or death, damage to the product, or product failure. Please read each section in its entirety and be sure you understand the information provided in the section and related sections before attempting any of the procedures or operations given.