

**MS2800E**

# **Safety Light Curtain Type 2**

# **OPERATION MANUAL**

**OMRON**

# **MS2800E**

## **Safety Light Curtain Type 2**

### **Installation and Operating Manual**

*January 2008*



**Omron Europe B.V.**  
Wegalaan 67-69  
NL-2132 JD, Hoofddorp  
Pays-Bas  
Tel.: +31 (0) 23 568 13 00  
Fax: +31 (0) 23 568 13 88  
[www.industrial.omron.eu](http://www.industrial.omron.eu)



## Notice:

OMRON products are manufactured for use according to proper procedures by a qualified operator and only for the purposes described in this manual.

The following conventions are used to indicate and classify precautions in this manual. Always heed the information provided with them. Failure to heed precautions can result in injury to people or damage to property.

-  **DANGER** Indicates an imminently hazardous situation which, if not avoided, will result in death or serious injury.
-  **WARNING** Indicates a potentially hazardous situation which, if not avoided, could result in death or serious injury.
-  **Caution** Indicates a potentially hazardous situation which, if not avoided, may result in minor or moderate injury, or property damage.

## OMRON Product References

All OMRON products are capitalized in this manual. The word “Unit” is also capitalized when it refers to an OMRON product, regardless of whether or not it appears in the proper name of the product.

## Visual Aids

The following headings appear in the left column of the manual to help you locate different types of information.

**Note** Indicates information of particular interest for efficient and convenient operation of the product.

**1,2,3...** 1. Indicates lists of one sort or another, such as procedures, checklists, etc.

## © OMRON, 2008

All rights reserved. No part of this publication may be reproduced, stored in a retrieval system, or transmitted, in any form, or by any means, mechanical, electronic, photocopying, recording, or otherwise, without the prior written permission of OMRON.

No patent liability is assumed with respect to the use of the information contained herein. Moreover, because OMRON is constantly striving to improve its high-quality products, the information contained in this manual is subject to change without notice. Every precaution has been taken in the preparation of this manual. Nevertheless, OMRON assumes no responsibility for errors or omissions. Neither is any liability assumed for damages resulting from the use of the information contained in this publication.



# TABLE OF CONTENTS

<b>PRECAUTIONS</b> .....	<b>xiii</b>
1    Precautions on Safety .....	xiii
2    Alert Statements in this manual .....	xiii
3    Precautions for Safe Use .....	xvii
4    Precautions for Correct Use .....	xviii
<b>SECTION 1</b>	
<b>Important Safety Warnings</b> .....	<b>1</b>
<b>SECTION 2</b>	
<b>Product features</b> .....	<b>3</b>
<b>SECTION 3</b>	
<b>System Components and Indicators</b> .....	<b>4</b>
<b>SECTION 4</b>	
<b>System Operation</b> .....	<b>5</b>
4-1    Operating States .....	5
4-2    Operating Modes .....	6
4-3    MS2800FS Cascaded Series .....	6
<b>SECTION 5</b>	
<b>Detection Options</b> .....	<b>9</b>
5-1    Fixed Blanking .....	9
5-2    Floating Blanking .....	13
5-3    Fixed Blanking with Floating Blanking .....	14
5-4    Optical Synchronization .....	15
<b>SECTION 6</b>	
<b>Diagnostic and Test Features</b> .....	<b>17</b>
6-1    Individual Sector Indicators (ISI) .....	17
6-2    External Device Monitoring (EDM) .....	17
6-3    Machine test signal (MTS) .....	17
6-4    Range selection .....	17
6-5    Start/Restart Input .....	18

<b>SECTION 7</b>	
<b>Using selector switches to set features. . . . .</b>	<b>19</b>
7-1 Access to the selector switches . . . . .	19
7-2 Operating mode selection . . . . .	20
7-3 Selecting and programming Fixed Blanking . . . . .	20
7-4 Selecting and programming Floating Blanking. . . . .	20
7-5 Selecting External Device Monitoring (EDM) . . . . .	20
7-6 Selecting Machine Test Signal (MTS). . . . .	20
7-7 Selecting Scan Codes. . . . .	21
<b>SECTION 8</b>	
<b>Outputs . . . . .</b>	<b>23</b>
8-1 Safety Outputs (OSSDs) . . . . .	23
8-2 Auxiliary Output . . . . .	23
<b>SECTION 9</b>	
<b>Safe Mounting Distances . . . . .</b>	<b>25</b>
9-1 Safety distance for safeguarding danger points. . . . .	25
9-2 Safety distance for safeguarding danger areas. . . . .	27
9-3 Safety distance and beam heights in access guarding . . . . .	28
<b>SECTION 10</b>	
<b>Installation. . . . .</b>	<b>29</b>
10-1 Reflective Surface Interference . . . . .	29
10-2 Cross Talk Mitigation . . . . .	30
10-3 General Mounting Considerations. . . . .	31
<b>SECTION 11</b>	
<b>Connection to the Machine Control Circuit. . . . .</b>	<b>35</b>
11-1 Interconnect cables for cascaded MS2800FS system . . . . .	35
11-2 Connection to two forcibly guided relays . . . . .	36
11-3 Connection to a safety relay unit . . . . .	36
<b>SECTION 12</b>	
<b>Muting . . . . .</b>	<b>37</b>
12-1 Muting Controller RM-6 . . . . .	37
<b>SECTION 13</b>	
<b>Checkout and test procedure . . . . .</b>	<b>39</b>
13-1 Checkout Procedure. . . . .	39
13-2 Test Procedure . . . . .	39
13-3 Using the test object. . . . .	39

<b>SECTION 14</b>	
<b>Cleaning</b> .....	<b>41</b>
<b>SECTION 15</b>	
<b>Specifications and additional information</b> .....	<b>43</b>
15-1 System Specification .....	43
15-2 MS2800 system Dimensional Drawing .....	46
15-3 MS2800 system data with 14 mm resolution .....	47
15-4 MS2800 system data with 30 mm resolution .....	48
15-5 MS2800FS system Dimensional Drawing .....	50
15-6 MS2800FS system data with 14 mm resolution .....	51
15-7 MS2800FS system data with 30 mm resolution .....	52
15-8 List of models .....	55
15-9 Accessories .....	65
<b>SECTION 16</b>	
<b>Glossary</b> .....	<b>69</b>
<b>SECTION 17</b>	
<b>Diagnostics and Troubleshooting</b> .....	<b>71</b>
17-1 Transmitter Diagnostic information and troubleshooting .....	71
17-2 Receiver Diagnostic Information .....	71
17-3 Receiver Endcap Indicator Lights .....	71
17-4 Receiver Troubleshooting .....	72
17-5 Receiver Error Codes .....	72
<b>SECTION 18</b>	
<b>Appendix</b> .....	<b>75</b>
18-1 Appendix A .....	75
18-2 Appendix B .....	76
<b>Revision History</b> .....	<b>77</b>



# Introduction

Thank you for purchasing the MS2800 series Safety Light Curtain. This is the instruction manual describing the use of the MS2800 system.

## Important notice

This manual provides installation and operating information on the following models:

	<b>Basic</b>	<b>Advanced</b>
Resolution 14 mm, standalone	MS2800S-EB-014	MS2800S-EA-014
Resolution 14 mm, cascadable	MS2800FS-EB-014	MS2800FS-EA-014
Resolution 30 mm, standalone	MS2800S-EB-030	MS2800S-EA-030
Resolution 30 mm, cascadable	MS2800FS-EB-030	MS2800FS-EA-030

Where information is common on all models the term "MS2800 system" will be used. Where information is given for a specific model the model number will be used.

Always heed the following points when using the MS2800 system:

1. Be sure to have MS2800 system handled by a "Responsible Person" who is well aware of and familiar with the machine to be installed.
2. The term "Responsible Person" used in this Instruction manual means the person qualified, authorized and responsible to secure "safety" in each process of the design, installation, operation, maintenance services and disposition of the machine.
3. It is assumed that MS2800 system will be used properly according to the installation environment, performance and function of the machine. Responsible Person should conduct risk assessment on the machine and determine the suitability of this product before installation.
4. Read this Manual thoroughly to understand and make good use of the descriptions before installing and operating the product.
5. Keep this Manual at the place where the operator can refer to whenever necessary.

# ***Read and understand this document***

Please read and understand this document before using the products. Please consult your OMRON representative if you have any questions or comments.

## **WARRANTY**

OMRON's exclusive warranty is that the products are free from defects in materials and workmanship for a period of one year (or other period if specified) from date of sale by OMRON.

OMRON MAKES NO WARRANTY OR REPRESENTATION, EXPRESS OR IMPLIED, REGARDING NON-INFRINGEMENT, MERCHANTABILITY, OR FITNESS FOR PARTICULAR PURPOSE OF THE PRODUCTS, ANY BUYER OR USER ACKNOWLEDGES THAT THE BUYER OR USER ALONE HAS DETERMINED THAT THE PRODUCTS WILL SUITABLY MEET THE REQUIREMENTS OR THEIR INTENDED USE. OMRON DISCLAIMS ALL OTHER WARRANTIES, EXPRESS OR IMPLIED.

## **LIMITATIONS OF LIABILITY**

OMRON SHALL NOT BE RESPONSIBLE FOR SPECIAL, INDIRECT, OR CONSEQUENTIAL DAMAGES, LOSS OF PROFITS OR COMMERCIAL LOSS IN ANY WAY CONNECTED WITH THE PRODUCTS, WHETHER SUCH CLAIM IS BASED ON CONTRACT, WARRANTY, NEGLIGENCE, OR STRICT LIABILITY.

In no event shall responsibility of OMRON for any act exceed the individual price of the product on which liability asserted.

IN NO EVENT SHALL OMRON BE RESPONSIBLE FOR WARRANTY, REPAIR, OR OTHER CLAIMS REGARDING THE PRODUCTS UNLESS OMRON'S ANALYSIS CONFIRMS THAT THE PRODUCTS WERE PROPERLY HANDLED, STORED, INSTALLED, AND MAINTAINED AND NOT SUBJECT TO CONTAMINATION, ABUSE, MISUSE, OR INAPPROPRIATE MODIFICATION OR REPAIR.

## **SUITABILITY FOR USE**

OMRON shall not be responsible for conformity with any standards, codes, or regulations that apply to the combination of products in the customer's application or use of the product.

At the customer's request, OMRON will provide applicable third party certification documents identifying ratings and limitations of use that apply to the products. This information by itself is not sufficient for a complete determination of the suitability of the products in combination with the end product, machine, system, or other application or use.

The following are some examples of applications for which particular attention must be given. This is not intended to be an exhaustive list of all possible uses of the products, nor is it intended to imply that the uses listed may be suitable for the products:

- Outdoor use, uses involving potential chemical contamination or electrical interference, or conditions or uses not described in this document.
- Nuclear energy control systems, combustion systems, railroad systems, aviation systems, medical equipment, amusement machines, vehicles, and installations subject to separate industry or government regulations.
- Systems, machines, and equipment that could present a risk to life or property.

Please know and observe all prohibitions of use applicable to the products.

NEVER USE THE PRODUCTS FOR AN APPLICATION INVOLVING SERIOUS RISK TO LIFE OR PROPERTY WITHOUT ENSURING THAT THE SYSTEM AS A WHOLE HAS BEEN DESIGNED TO ADDRESS THE RISKS, AND THAT THE OMRON PRODUCT IS PROPERLY RATED AND INSTALLED FOR THE INTENDED USE WITHIN THE OVERALL EQUIPMENT OR SYSTEM.

## **PERFORMANCE DATA**

Performance data given in this document is provided as a guide for the user in determining suitability and does not constitute a warranty. It may represent the result of OMRON's test conditions, and the users must correlate it to actual application requirements. Actual performance is subject to the OMRON Warranty and Limitations of Liability.

### **CHANGE IN SPECIFICATIONS**

Product specifications and accessories may be changed at any time based on improvements and other reasons.

It is our practice to change model numbers when published ratings or features are changed, or when significant construction changes are made. However, some specifications of the product may be changed without any notice. When in doubt, special model numbers may be assigned to fix or establish key specifications for your application on your request. Please consult with your OMRON representative at any time to confirm actual specifications of purchased products.

### **DIMENSIONS AND WEIGHTS**

Dimensions and weights are nominal and are not to be used for manufacturing purposes, even when tolerances are shown.

### **ERRORS AND OMISSIONS**

The information in this document has been carefully checked and is believed to be accurate; however, no responsibility is assumed for clerical, typographical, or proofreading errors, or omissions.

### **PROGRAMMABLE PRODUCTS**

OMRON shall not be responsible for the user's programming of a programmable product, or any consequence thereof.

### **COPYRIGHT AND COPY PERMISSION**

This document shall not be copied for sales or promotions without permission.

This document is protected by copyright and is intended solely for use in conjunction with the product. Please notify us before copying or reproducing this document in any manner, for any other purpose. If copying or transmitting this document to another, please copy or transmit it in its entirety.

# PRECAUTIONS

## 1 Precautions on Safety

In order to use the MS2800 system safely, the precautions listed in this manual indicated by alert symbols and descriptions must be followed. Failure to follow all precautions and alerts may result in an unsafe use or operation.

The following indications and symbols are used for the application:

-  **WARNING** This sign indicates a potentially hazardous situation which, if not avoided, will result in minor or moderate injury, or may result in serious injury or death. Additionally there may be significant property damage.

## 2 Alert Statements in this manual

### 2-1 For users

-  **WARNING** The MS2800 system must be installed, configured, and incorporated into a machine control system by a sufficiently trained and qualified person. An unqualified person may not be able to perform these operations properly, which may cause a person to go undetected, resulting in serious injury.

-  **WARNING** When changes are made to each function using the selector switches, the administrator must manage the detail of the changes and perform the changes. Accidental functional setting change may cause failure of human body detection, resulting in a serious injury.

### 2-2 For machines

-  **WARNING** Do not use this sensor for machines that cannot be stopped by electrical control. For example, do not use it for a pressing machine that uses full-rotation clutch. Otherwise, the machine may not stop before a person reaches the hazardous part, resulting in serious injury.













-  **WARNING** Do not use the auxiliary output or external indicator output for safety applications. Human body may not be detected when MS2800 system fails, resulting in serious injury.









### 2-3 For installations

-  **WARNING** After unpacking and before installing the MS2800 system please check the mechanical condition of the system carefully. Do not install a mechanically damaged product. Return this to your OMRON service for inspection or repair. Failure to do so may result in serious injury.





-  **WARNING** Do not drop the products. Dropping the products may lead to internal or external damage. Please return a MS2800 system that was dropped on the floor to your OMRON service for inspection or repair. Failure to do so may result in serious injury.

-  **WARNING** Make sure to test the operation of the MS2800 system after installation to verify that the MS2800 system operates as intended. Make sure to stop the machine until the test is complete. Unintended function settings may cause a person to go undetected, resulting in serious injury.

-  **WARNING** Make sure to install the MS2800 system at the safe distance from the hazardous part of the equipment. Otherwise, the machine may not stop before a person reaches the hazardous part, resulting in serious injury.
-  **WARNING** Install a protective structure so that the hazardous part of a machine can only be reached by passing through the sensor's detection zone. Install the sensors so that part of the person is always present in the detection zone when working in a machine's hazardous areas. If a person is able to step into the hazardous area of a machine and remain behind the MS2800 system's detection zone, configure the system with an interlock function that prevents the machine from being restarted. Failure to do so may result in serious injury.
-  **WARNING** Install the interlock reset switch in a location that provides a clear view of the entire hazardous area and where it cannot be activated from within the hazardous area.
-  **WARNING** The MS2800 system cannot protect a person from a projectile exiting the hazardous zone. Install protective cover(s) or fence(s).
-  **WARNING** To prevent personnel approach to dangerous part of the machine through a zone disabled by the fixed blanking function, you must install a protective structure to cover the whole disabled zone. Failure to do so may cause failure of human body detection, resulting in a serious injury.
-  **WARNING** You must ensure that a test rod is detected for all detection zones except where fixed or floating blanking function is used. Failure to do so may cause failure of human body detection, resulting in a serious injury.
-  **WARNING** Detection capability gets larger if fixed or floating blanking function is used. You must use the detection capability for fixed and floating blanking functions. Failure to do so may cause failure of machine stop before reaching the machine's dangerous part, resulting in a serious injury.
-  **WARNING** The muting and override functions disable the safety functions of the device. You must ensure safety using other method when these functions are operating.
-  **WARNING** Install muting sensors so that they can distinguish between the object that is being allowed to pass through the detection zone and a person. If the muting function is activated by the detection of a person, it may result in serious injury.
-  **WARNING** Muting lamps (external indicators) that indicate the state of the muting and override functions must be installed where they are clearly visible to workers from all the operating positions.
-  **WARNING** Muting related time must be properly configured for its application by a sufficiently trained and qualified person, and the person must have responsibility for settings, especially when setting the muting time limit to infinite.
-  **WARNING** Use independent 2 input devices for muting inputs.
-  **WARNING** You must install MS2800 system muting sensor, and physical barrier, and configure time settings for muting so that an operator should not enter hazardous zone.

-  **WARNING** Install the switch that activates the override in a location that provides a clear view of the entire hazardous area and where it cannot be activated from within the hazardous area. Make sure that nobody is in the hazardous area before activating the override function.
-  **WARNING** Do not place fluorescent lights within the effective aperture angle of the receiver, as it may influence the MS2800 system under certain circumstances.
-  **WARNING** Install the sensor system so that it is not affected by any reflective surfaces. Failure to do so may hinder detection, resulting in serious injury.
-  **WARNING** When using more than 1 set of MS2800 system, install them so that mutual interference does not occur, such as by configuring series connections or using physical barriers between adjacent sets.
-  **WARNING** Make sure that the MS2800 system is securely mounted and its cables and connectors are properly connected.
-  **WARNING** Make sure that foreign objects such as water, oil, or dust do not enter the inside of the MS2800 system while the cover for the selector switches is open and tighten the screws of the cover firmly after changing the settings.
-  **WARNING** Do not use the sensor system with mirrors in a retro-reflective configuration. Doing so may hinder detection. It is possible to use mirrors to "bend" the detection zone to a 90° angle.
-  **WARNING** Perform an inspection for all MS2800 systems as described in the chapter "Checkout and test procedure". When using series connections, perform inspections for every connected MS2800 system.

## 2-4 For wiring

-  **WARNING** Connect the load between the output and 0V line (PNP output). Connecting the load between the output and +24 V line will result in a dangerous condition because operation is reversed to "ON when blocked".
-  **WARNING** Do not short-circuit the output line to the +24 V line. Otherwise, the output is always ON. Also, the 0 V of the power supply must be grounded so that output does not turn ON due to grounding of the output line.
-  **WARNING** Configure the system by using the optimal number of safety outputs that satisfy the requirements of the necessary safety category.
-  **WARNING** Do not connect each line of MS2800 system to a DC power supply of more than 24 VDC+20%. Also, do not connect to an AC power supply. Failure to do so may result in electric shock.

 **WARNING** For the MS2800 system to comply with IEC 61496-1 and UL 508, the DC power supply unit must satisfy all of the following conditions:

- Must be within the rated power voltage (24 V DC  $\pm$  20%)
- Must have tolerance against the total rated current of devices if it is connected to multiple devices
- Must comply with EMC directives (industrial environment)
- Double or reinforced insulation must be applied between the primary and secondary circuits
- Automatic recovery of overcurrent protection characteristics
- Output holding time must be 20 ms or longer
- Must satisfy output characteristic requirements for class 2 circuit or limited voltage current circuit defined by UL508
- Must comply with laws and regulations, regarding EMC and electrical equipment safety, of the country or region where the MS2800 system is used (Ex: In EU, the power supply must comply with the EMC Directive and the Low Voltage Directive.)

 **WARNING** Double or reinforced insulation from hazardous voltage must be applied to all input and output lines. Failure to do so may result in electric shock.

 **WARNING** Extension of the cable must be within a specified length. If it isn't, safety function may not work properly, resulting in danger.

## 2-5 Other

 **WARNING** To use the MS2800 system in PSDI mode (Re-initiation of cyclic operation by the protective equipment), you must configure an appropriate circuit between the MS2800 system and the machine. For details about PSDI, refer to IEC61496-1, and other relevant standards and regulations.

 **WARNING** Do not try to disassemble, repair, or modify this product. Doing so may cause the safety functions to stop working properly.

 **WARNING** Do not use the MS2800 system in environments where flammable or explosive gases are present. Doing so may result in explosion.

 **WARNING** Perform daily and 6-month inspections for the MS2800 system. Otherwise, the system may fail to work properly, resulting in serious injury.

 **WARNING** If the MS2800 system is used in an environment where foreign materials such as spatter may adhere to the product use a cover to protect the MS2800 system or inspect and clean the MS2800 system periodically.

 **WARNING** Do not use the MS2800 system in an atmosphere containing oil mist or corrosive gas. Failure to do so may result in damage of the product.

 **WARNING** When scrapping the MS2800 system, please make sure to comply with the waste treatment regulations of the country where the product has been used.

### **3 Precautions for Safe Use**

Make sure to observe the following precautions that are necessary for ensuring safe use of the product.

- Thoroughly read this manual and understand the installation procedures, operation check procedures, and maintenance procedures before using the product.
- Loads must satisfy both of the following conditions:
  - Not short-circuited
  - Not used with a current that is higher than the rating
- Do not drop the product
- Dispose of the product in accordance with the relevant rules and regulations of the country or area where the product is used.



## **4 Precautions for Correct Use**

Observe the precautions described below to prevent operation failure, malfunctions, or undesirable effects on product performance.

### **4-1 Installation environment**

Do not install the MS2800 system in the following types of environments:

- Areas exposed to intense interference light, such as direct sunlight
- Areas with high humidity where condensation is likely to occur
- Areas where corrosive gases are present
- Areas exposed to vibration or shock levels higher than in the specification provisions
- Areas where the product may come into contact with water
- Areas where the product may get wet with oil that can solve adhesive

Do not use radio equipment such as cellular phones, walkie-talkies, or transceivers near the MS2800 system.

### **4-2 Wiring and installation**

- Make sure to perform wiring while the power supply is OFF. Otherwise, the MS2800 system may fail to operate due to the diagnosis function.
- When replacing the cable connectors with other types of connectors, use connectors that provide a proper grade of protection.
- Properly perform the wiring after confirming the signal names of all the terminals.
- Do not operate the control system until 2 seconds or more (2,2 seconds or more in case of series connection) after turning ON the power of the MS2800 system.
- Be sure to route the MS2800 system cable separate from high-potential power lines or through an exclusive conduit.
- When using a commercially available switching regulator power supply, make sure to ground the FG terminal (frame ground terminal).
- Install the emitter and receiver so that their vertical direction should match.

### **4-3 Cleaning**

Do not use thinner, benzene, or acetone for cleaning, they affect the product's resin parts and paint on the case.

### **4-4 Object detection**

The MS2800 system cannot detect transparent and/or translucent objects.

# SECTION 1

## Important Safety Warnings

 **WARNING** Read and understand this section prior to installing an MS2800 system.

An MS2800 system is a general purpose sensing device designed to guard personnel working around moving machinery.

Whether a specific machine application and MS2800 system installation complies with safety regulations depends on the proper application, installation, maintenance and operation of the MS2800 system. These items are the responsibility of the purchaser, installer and employer.

The employer is responsible for the selection and training of personnel to properly install, operate and maintain the machine and its safeguarding systems. An MS2800 system should only be installed verified and maintained by a qualified person. A qualified person is defined as "an individual who understands, is trained on, and demonstrates competence with the construction, operation or maintenance of the machinery and the hazards involved."

To use the MS2800 system the following requirements must be met:

- The national/international rules and regulations apply to the installation, use and periodic technical inspections of the safety light curtain, in particular:
  - Machine Directive (98/37/EC)
  - Equipment Usage Directive (89/655/EC)
  - The work safety regulations/safety rules
  - Other relevant health and safety regulations
- Observe the instructions in this manual regarding test regulations (e.g. on use, mounting, installation or integration into the existing machine control system) carefully.
- The tests must be carried out by specialist personnel or specially qualified and authorized personnel and must be recorded and documented to ensure that the tests can be reconstructed and retraced at any time.
- Check the effectiveness of the protective device after every change because a change may degrade the safety function.
- The operating instructions must be made available to the operator of the machine where the MS2800 system is installed.
- The machine operator is to be instructed in the use of the device by specialist personnel and must be instructed to read the operating instructions.
- The guarded machine must not present a hazard from flying parts.
- The guarded machine must have a consistent stopping time and adequate control mechanisms.
- Additional guarding may be required for access to dangerous areas not covered by the MS2800 system.

Protection of the environment

This product has been designed to minimize environmental impact. For this reason please note that disposal of irreparable/unserviceable devices has to be in compliance with your local/national rules and regulations. Please contact your local OMRON sales representative for assistance.



## SECTION 2

### Product features

The MS2800 safety light curtain family is available in two versions. These versions are identified as the MS2800-EA and EB versions. Configuration of the safety light curtains can be changed through selector switches located under an access cover.

MS2800 series feature comparison

Feature	MS2800-EB	MS2800-EA
Flex Bus, Multi segmented Head Configurations	X	X
Scan Code for Cross-Talk-Mitigation	X	X
EDM External Device Monitoring	X	X
Adjustable Mounting Brackets and T-Slots	X	X
Non-shielded Main Cables	X	X
Two PNP safety outputs	X	X
Auxiliary outputs (PNP only)	X	X
Muting through RM6 Muting Module		X
Floating Blanking		X
Fixed Blanking		X
Range Selection	X	X

# SECTION 3

## System Components and Indicators

Chart		Chart	
1	Receiver	7	Transmitter
2	Individual sector Indicators (one with the uppermost and one with the lowest beam) - Red LED	8	Detection Zone
3	Blanking Active - Amber LED	9	Flip door, Access to configuration switches (on transmitter and receiver)
4	INTERLOCK or ALARM indicator - Yellow LED	10	
5	MACHINE RUN/STOP indicator - Green/Red LED	11	Status Indicator - Yellow LED
6	RECEIVER connections M12 (Male)	12	Slide Mounting T-Slot
	1   +24 V DC - Brown	13	Transmitter connections M12 (Male)
	2   0 V DC - Blue		1   0 V DC - Blue
	3   Earth - Green		2   +24 V DC - Brown
	4   OSSD 2 - White		3   MTS - White
	5   Start or EDM (Mode Select) - Yellow		4   MTS return - Black
	6   EDM - Red		5   Earth - Green
	7   Auxiliary Out - Pink		
	8   OSSD 1 - Black		

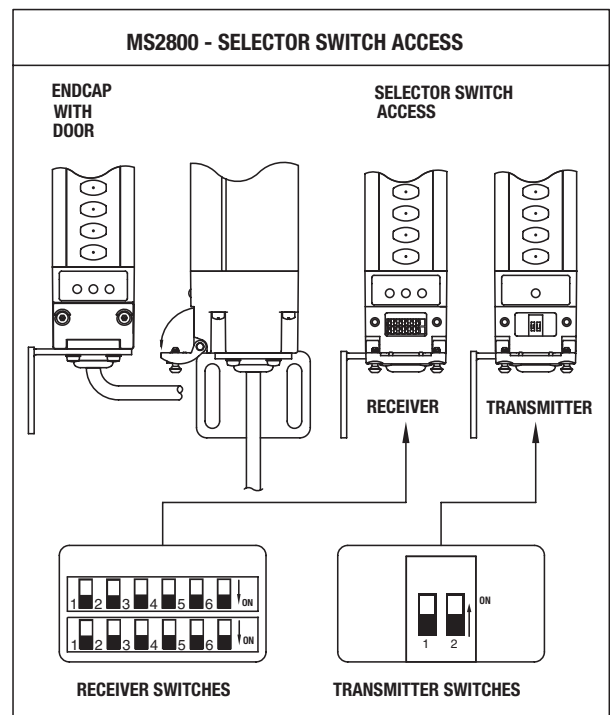
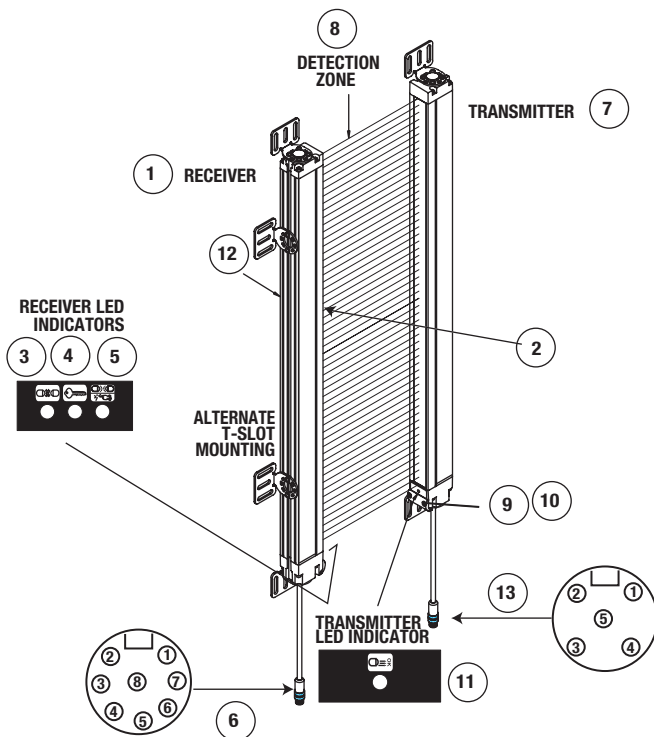

## SECTION 4

# System Operation

The MS2800 system is a microprocessor-controlled, infrared, transmitted-beam safety light curtain. The system consists of a receiver assembly and a transmitter assembly. The receiver and transmitter assemblies are not physically interconnected.

It complies with a Type 2 according to EN/IEC 61496 and category 2 according to EN954-1.

An MS2800 system is used where personnel protection is required. Typical applications include packaging machines, back side protection of presses and textile machinery.

### 4-1 Operating States

The operating condition of an MS2800 system is described in terms of states. The following operating states exist for an MS2800 system.

#### 4-1-1 Machine Run

The two receiver safety outputs are in the ON state, the green MACHINE RUN indicator is lit, and the auxiliary output is in a state consistent with its configuration. The protected machine is allowed to operate. Pressing and releasing the start button has no effect.

#### 4-1-2 Machine Stop

The two receiver safety outputs are in the OFF state the red MACHINE STOP indicator is lit, and the auxiliary output is in a state consistent with its configuration. The protected machine is not allowed to operate.

#### 4-1-3 Interlock

The two receiver safety outputs are in the OFF state, the red MACHINE STOP indicator and yellow INTERLOCK indicator are lit. The auxiliary output is in a state consistent with its configuration. The INTERLOCK state does not allow the protected machine to operate until the detection zone is clear of obstructions and the start button is pressed and released.

#### 4-1-4 Alarm

The two receiver safety outputs are in the OFF state, the red MACHINE STOP indicator is lit, the yellow INTERLOCK indicator is flashing and the auxiliary output is in the OFF state. The alarm state does not allow the protected machine to operate. The primary difference between ALARM and INTERLOCK is that the MS2800 system will remain in the alarm state until the alarm is corrected, and then applying a power cycling or an external start button press and release.

## 4-2 Operating Modes

System operating modes determine the start-up and operating behavior of an MS2800 system. Operating modes definitions rely on the operating states presented above. Operating mode selection may be performed via the configuration switches on the MS2800 transmitter and receiver.

**Note** If internal alarms are detected by the system during power-up or operation, it will enter the Alarm state with its safety outputs in the OFF state.

### 4-2-1 Automatic start

The MS2800 will power-up with its safety and auxiliary outputs OFF, and if the detection zone is not obstructed, enters the MACHINE RUN state. In this state, when an object is sensed entering the detection zone, the MS2800 system will change from MACHINE RUN to MACHINE STOP and remain in this state until the obstruction is removed. Once the detection zone is clear, the MS2800 system will automatically change from MACHINE STOP to MACHINE RUN.

### 4-2-2 Start/Restart Interlock

The MS2800 will power-up with its safety outputs off and enter the INTERLOCK state if the detection zone is clear (or the fixed blanking pattern is satisfied) and no alarms are detected. To initially enter the MACHINE RUN state the operator must press and release the Start button. Once in the MACHINE RUN state, when an object is sensed entering the detection zone, the system will change to the MACHINE STOP state. When the detection zone is cleared, the system will not automatically change to MACHINE RUN but enter the INTERLOCK state instead. The operator must always press and release the Start button to enter MACHINE RUN. If the detection zone is not clear the Start button will have no effect.

**Note** The definitions above mention a start button. See *SECTION 11 Connection to the Machine Control Circuit* for wiring of the start button.

## 4-3 MS2800FS Cascaded Series

The MS2800 series safety light curtain is available in a "cascaded" version, referred to as the MS2800FS series. The MS2800FS series allows multiple transmitters/receivers to be "daisy-chained" in series. This type of arrangement permits the MS2800FS to guard multiple areas of a machine.

### 4-3-1 MS2800FS Requirements

The MS2800FS is offered in protective heights ranging from 280 mm to 1800 mm for 14 mm resolution and 280 mm to 2120 mm for 30 mm resolution.

- An MS2800FS system has a maximum size limitation based on the number of beams. A master (first) segment cannot exceed 180 beams and the total of the combined segments cannot exceed 256 beams.
- A cascaded slave segment cannot exceed 128 beams.
- An MS2800FS system may have up to four daisy-chained segments. As long as the total number of beams does not exceed 256.
- The interconnect cable length limitation between any two segments is 10 meters.

- It is possible to mix segments with different resolutions within an MS2800FS system.

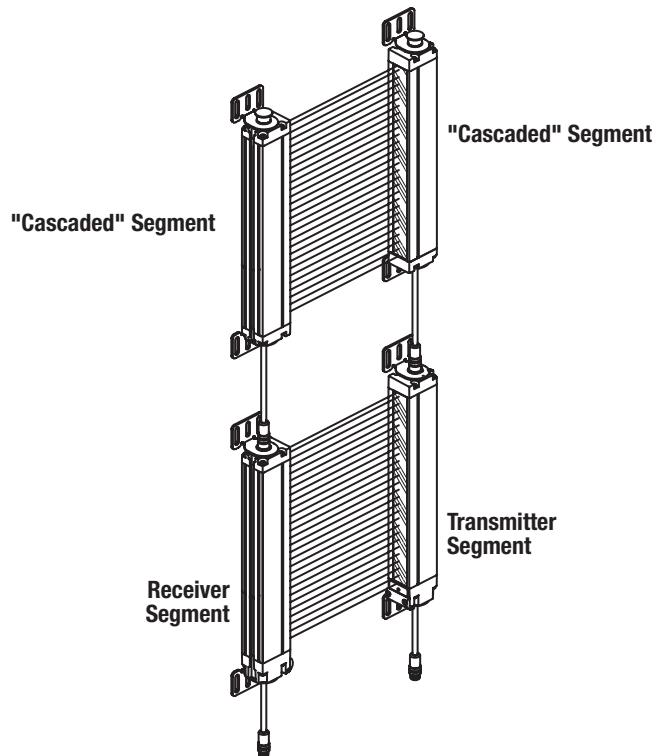

#### 4-3-2 MS2800FS Segment Reduction Restart Procedure

**⚠ WARNING** Do not remove cascaded segments from your installation without making sure that the accessible areas are protected by other measures. Failure to do so may result in serious injury.

When you reduce the number of cascaded segments you cause a flex bus fault. The MS2800FS will enter a fault condition, indicated by error code "95" on the indicators in the bottom part of the device. This fault code indicates that there was a reduction in the number of cascaded segments. If the number of segments is reduced while power is off, the light curtain will power on with fault code "100".

There is one possibility to clear this fault and restore operation on the reduced size MS2800FS. The start switch needs to be pressed while the power is applied. The three indicator LEDs (red, yellow, amber) will flash for approximately three seconds. The start switch must be released while the LEDs are flashing to clear fault code "100". Since the MS2800FS has a configurable start input, care must be taken to ensure that the correct contact configuration is used and that it is wired properly.

The transmitter will not fault if the number of segments is reduced. However, to operate normally the transmitter must always match the receiver in the number of segments and beams.





# SECTION 5 Detection Options

**⚠ WARNING** Use of Fixed Blanking and Floating Blanking will make an MS2800 system less sensitive to objects in the detection zone. Improper use of these features can result in severe injury to personnel. Fixed Blanking may require a hard barrier guard. Fixed Blanking and Floating Blanking may require an increase in the safety distance. Read the following section carefully.

## 5-1 Fixed Blanking

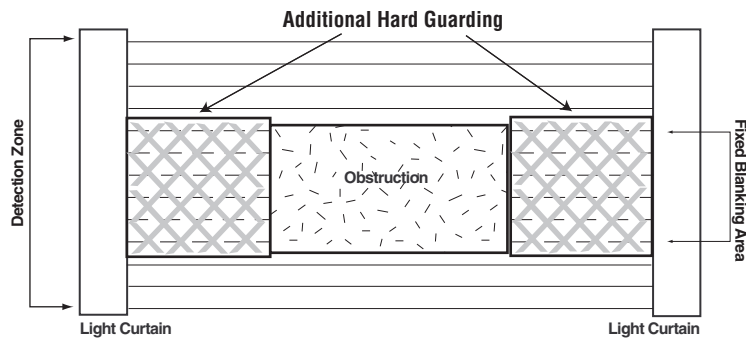

Fixed Blanking allows a system to blank optical beams and record the exact pattern. A system can record and store a single pattern. The protected zone's object detection is then based on the stored pattern. All obstructed optical beams recorded during the selection must remain blocked and all clear beams recorded during the selection must remain clear for the system to enter or remain in the MACHINE RUN state.

A Fixed Blanking pattern may consist of more than one Fixed Blanked area. Individual Fixed Blanked areas must be separated by at least one beam that is always clear. A Fixed Blanking area may not crossover between "flexible" segment boundaries.

Each Fixed Blanked area has a size and positional tolerance of  $\pm 1$  beam to allow for slight position variance and only the two beams on the edges of the blanked area are allowed to vary. Because of this position tolerance, a reduction of the optical resolution takes place on the border area of Fixed Blanking patterns. This reduction comprises two beams.

### Tolerance effect of Fixed Blanked area on Resolution

Standard Resolution	Effective Resolution at Ends of Fixed Blanked Areas
14 mm	34 mm
30 mm	60 mm

**Note** The tolerance does not reduce the resolution of the entire light curtain, only the ends of Fixed Blanked Areas. The user must consider the increased resolution of the two beams at the ends of each Fixed Blanked Area.

The effect of this tolerance also allows the number of blocked beams to vary  $\pm 1$ . For example, a Fixed Blanked area of 8 blanked beams is allowed to increase to 9 beams or decrease to 7 beams and the light curtain will remain in MACHINE RUN.

No Fixed Blanking	Fixed Blanking Enabled	Fixed Blanking Enabled	Fixed Blanking Enabled	Fixed Blanking Enabled	Fixed Blanking Enabled
○	○	○	○	⊗	○
○	⊗	○	○	⊗	⊗
○	⊗	○	●	⊗	●
●	⊗	⊗	⊗	⊗	⊗
○	○	○	⊗	○	○
<b>MACHINE STOP</b>	<b>MACHINE RUN</b>	<b>MACHINE RUN</b>	<b>MACHINE RUN</b>	<b>MACHINE STOP</b>	<b>MACHINE STOP</b>

○ Clear Optical Channel      ● Blocked Optical Channel      ⊗ Optical Channel Selected by Fixed Blanking

There is an exception when there is only one clear beam separating Fixed Blanked areas. For only this case, there is no positional tolerance allowed on that side of the clear beam for the object closest to the entry endcap so that clear beam can only be used by the object further away from the entry endcap. See the following table:

Opposite to entry endcap end		
Fixed blanking enabled	Fixed blanking enabled	Fixed blanking enabled
○	○	●
⊗	⊗	⊗
⊗	⊗	⊗
○	●	●
⊗	⊗	⊗
⊗	⊗	⊗
○	●	○
<b>MACHINE RUN</b>	<b>MACHINE RUN</b>	<b>MACHINE STOP</b>
Entry endcap end		

The minimum number of beams in a Fixed Blanking area is one. If only one beam is blanked, the number of blocked beams has a size tolerance of  $+1/-0$  meaning the number of blocked beams can increase to two but the area cannot be completely eliminated.

The Fixed Blanking pattern must not prevent the light curtain from synchronizing. This means that the size of the blanked object can not exceed certain limits as long as synchronization is maintained.

Fixed Blanking is allowed during all modes of operation (automatic start, start and start/restart interlock).

### 5-1-1 Selecting Fixed Blanking with selector switches

To use Fixed Blanking, the operator enables the option using the selector switches. A new Fixed Blanking pattern is recorded when the MS2800 receiver is in MACHINE STOP, the blanking function is active and the Program function is activated. If the Fixed Blanking feature is disabled, the stored protected zone patterns are cleared.

1. The obstruction is placed within the detection zone and the receiver goes to MACHINE STOP state. An authorized user then sets the selector switches in the receiver endcap to select Fixed Blanking Enable. The MS2800 enters a fault state and power is cycled or the Start switch is activated to clear the fault. When the receiver powers up it will be in Fixed Blanking mode with the red and amber LEDs lit.

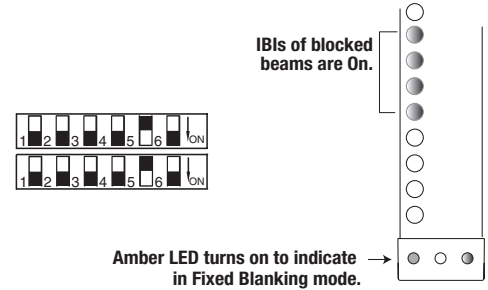

2. The authorized user then enables the Program switch by setting both Fixed Blanking switches to the off position and then both to the on position. When the first Fixed Blanking switch is flipped, the red LED begins flashing at a rate of 3 Hz. When the final Fixed Blanking switch is flipped, both the red and amber LEDs and the IBIs (Individual Sector Indicators) of the blocked beams start flashing to indicate the Program switch is enabled. The authorized user has 10 minutes to complete the programming of a pattern.

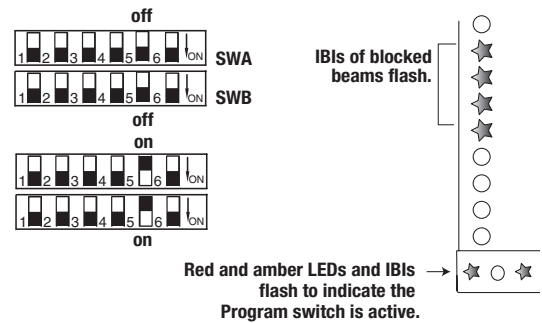

3. To program a pattern, the authorized user must flip (off/on or on/off) the Program switch once. Once pattern is programmed the yellow LED (INTERLOCK) turns on. During 10 minute period, the user may program as many times as needed, allowing for adjustment in the placement of the obstruction.

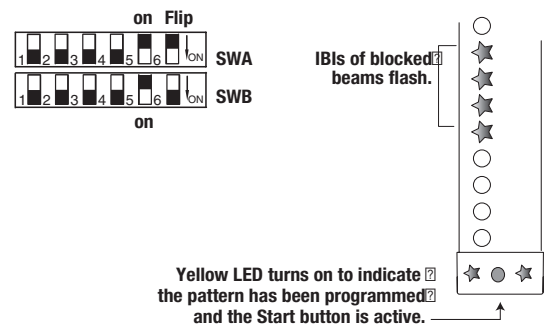

- The user must then press and release the Start button or perform a power cycle. The MS2800 receiver then resets. If no faults are detected and the state of the optical beams matches the recorded Fixed Blanking pattern, the receiver will enter the INTERLOCK or MACHINE RUN condition depending upon the selected Start Mode. The amber receiver Blanking Active LED will be on.

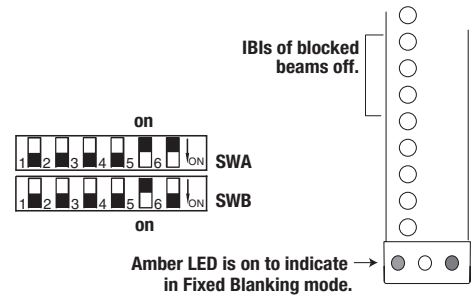

- If the 10 minutes period expires, the amber LED and ISIs (Individual Sector Indicators) quit flashing and the yellow LED (INTERLOCK) goes on. The user can start another programming sequence by setting both Fixed Blanking switches off and then on. The user may start normal operation by a press and release of the start button or by performing a power cycle.

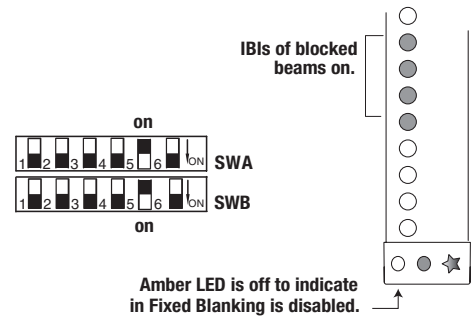

- To exit Fixed Blanking the user sets both selector switches to the off position, then either presses and releases the Start button or performs a power cycle. The receiver will power up with the amber LED off.

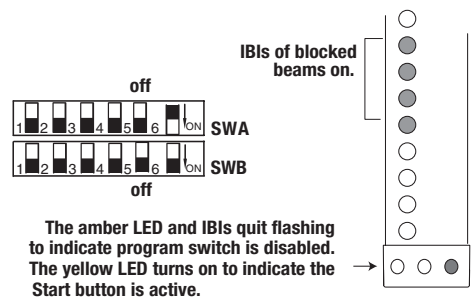

## 5-2 Floating Blanking

**⚠ WARNING** Use of Fixed Blanking and Floating Blanking will make the MS2800 system less sensitive to objects in the detection zone. Improper use of these features can result in severe injury to personnel. Fixed Blanking may require a hard barrier. Fixed Blanking and Floating Blanking may require an increase in the safety distance. Read the following section carefully.

One channel can be obstructed at any location in the detection zone as long as the optical synchronization is maintained. Please refer to chapter 5-4 *Optical Synchronization* for further details.

This means that an object can freely float from one end of the protective field to the other without the MS2800 system entering the MACHINE STOP state. The obstructed channels are not fixed at a single location but "float" through the detection zone.

	Floating Blanking Inactive	1 Channel Floating Blanking Active	1 Channel Floating Blanking Active	1 Channel Floating Blanking Active	1 Channel Floating Blanking Active
Channel 1	○	○	○	○	○
Channel 2	○	○	○	⊗	⊗
Channel 3	⊗	○	⊗	⊗	○
Channel 4	○	○	○	○	⊗
Channel 5	○	○	○	○	○
System Response	1 Exception MACHINE STOP	0 Exceptions Machine Run	1 Exception Machine Run	2 Exceptions MACHINE STOP	2 Exceptions MACHINE STOP

○ Clear Optical Channel      ⊗ Optical Channel is obstructed

### 5-2-1 Selecting Floating Blanking with selector switches

Using the selector switches an authorized user can activate the Floating Blanking function. This allows the system to operate with one obstructed optical beam anywhere within the protected zone. This obstruction is permitted anywhere within the protected zone and is permitted to move over time. After setting the appropriate selector switches, the receiver enters the Power-On Self Test state and if no faults are detected the receiver shall enter the INTERLOCK or MACHINE RUN condition depending upon the selected operating mode.

**⚠ WARNING** Two-Beam Floating Blanking is not available on the MS2800 system.

Floating Blanking Effects on Minimum Object Resolution	
Standard Minimum Object Resolution (No Floating Blanking)	Minimum Object Resolution with 1 Beam Blanking
14 mm	24 mm
30 mm	50 mm

## 5-3 Fixed Blanking with Floating Blanking

**⚠ WARNING** Use of Fixed Blanking and Floating Blanking will make MS2800 system less sensitive to objects in the detection zone. Improper use of these features can result in severe injury to personnel. Fixed Blanking may require a hard barrier guard. Fixed Blanking and Floating Blanking may require an increase in the safety distance. Read the following section carefully.

Possible combinations:

Function	Fixed Blanking	Floating Blanking
Fixed Blanking	N/A	Yes
Floating Blanking	Yes	N/A

When both Fixed Blanking and Floating Blanking are selected, the floating channels are allowed to occur anywhere within the detection zone except the area selected by Fixed Blanking.

### 5-3-1 The effect of Fixed or Floating Blanking on minimum object resolution

When fixed Blanking and/or Floating are active, the safe mounting distance is affected. Fixed and Floating Blanking desensitize the light curtain and increase the size of the minimum detectable object. The increase is equal to the beam spacing distance for each beam that is disabled.

If the size of the object detected by the system increases the minimum safe distance must also be increased. Use the minimum object sensitivity given in the following tables to determine the new figure to use when computing the safety distance.

MS2800 system - 14 mm resolution

Total number of Beams Disabled by Fixed and/or Floating Blanking	Effective Resolution
None	14 mm
1 Beam	24 mm
2 Beams	34 mm
3 Beams	44 mm
4 Beams	54 mm
5 Beams	64 mm
	> 64 mm

MS2800 system - 30 mm resolution

Total number of Beams Disabled by Fixed and/or Floating Blanking	Effective Resolution
None	30 mm
1 Beam	50 mm
	> 64mm

## 5-4 Optical Synchronization

The synchronization between the MS2800 system transmitter and receiver is optical, so the system does not use one specific beam. To establish synchronization the system needs to have a certain number of consecutive clear beams (see following table) within the first master segment. If they are not satisfied, the system will enter a MACHINE STOP state and every other Individual Beam Indicator will light. When the beams are cleared, the system will re-synchronize itself and enter a state consistent with its operating mode. Once the synchronization is established, it can be maintained as long as the required number of consecutive clear beams can be satisfied anywhere in the system (including flex segments).

Light Curtain Beam Count	Synchronization Beam Requirement
12 - 16 beams	6 consecutive clear beams
17 - 32 beams	7 consecutive clear beams
33 - 64 beams	8 consecutive clear beams
65 - 128 beams	9 consecutive clear beams
129 - 256 beams	10 consecutive clear beams

Because of these restrictions, when programming a fixed blanking object(s), the size of the fixed or monitored blanking object(s) must comply with the number of consecutive clear beams stated in the previous table within the first master segment.

In addition to that, any fixed or monitored blanking programming must be done with at least one (1) clear beam on each flex segment.





## SECTION 6

# Diagnostic and Test Features

### 6-1 Individual Sector Indicators (ISI)

All MS2800 systems have two visible, red LEDs on the receiver close to the lowest and the uppermost beam for easy alignment of the devices. Every LED represents one half of the protected area. If one optical beam in one half is interrupted, the referring LED will light. When synchronization fails, both LEDs will light.

Additionally, error codes are displayed using a set of red LEDs close to the connector endcap. The Individual Sector Indicators are not a safety critical component. A failure of the ISI will not cause an alarm condition and the system will continue to operate.

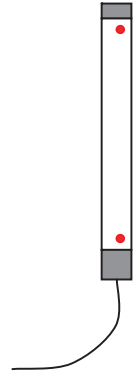

### 6-2 External Device Monitoring (EDM)

EDM is an important safety function. It monitors the MS2800 system interface to the guarded machine, checks to ensure that the control elements are responding correctly to the light curtain and detects any inconsistency between the two external control devices. This is necessary to detect a malfunction within the interface which prevents a stop signal from reaching the machine controller. The connection for the EDM is made at the receiver. On power-up, the MS2800 system looks for a closed to 0 VDC condition. If this is found, it will enter a state consistent with the selected operating mode. When the MS2800 system enables its safety outputs, it monitors the external devices for a closed to open transition. This transition must occur within 300 ms or the MS2800 system will then enter an alarm state. Additionally, if the EDM connections are incorrectly wired, the system will enter an alarm state.

**Note** For proper operation of the MS2800 system when EDM is not active, the EDM input must be wired to the MS2800 system 0 VDC line.

The EDM function can be activated and deactivated using the selector switches on the receiver unit.

### 6-3 Machine test signal (MTS)

Some applications require that the machine guarding system be tested by the machine controller during a non-hazardous portion of the machine cycle to verify that the guarding system is functioning properly. The MTS option on the transmitter provides this capability. The MTS is provided by placing a normally-closed switch across the MTS and MTS Return lines of the transmitter. When the transmitter recognizes a close-to-open transition on this switch a beam block state will be simulated on the transmitter and the receiver will enter the MACHINE STOP state. MTS is active as long as the switch is held open.

### 6-4 Range selection

The MS2800 offers operating range selection: short range is 3 m and long range is 7 m for the 14 mm models. For the 30mm models the short range is 8 m and long range is 20 m. This function is useful when there are many light

curtains operating within a small space and the possibility of cross-talk is likely.

## 6-5 Start/Restart Input

The characteristic of the Start/Restart Input is shown in the following schematic:



# SECTION 7

## Using selector switches to set features

**⚠ WARNING** Make sure that foreign objects such as water, oil, or dust do not enter the inside of the MS2800 system while the cover for the selector switches is open.

### 7-1 Access to the selector switches

The switches are located behind a flip door on both the transmitter and receiver. The flip up doors are opened by loosening two retaining screws (see illustration below).

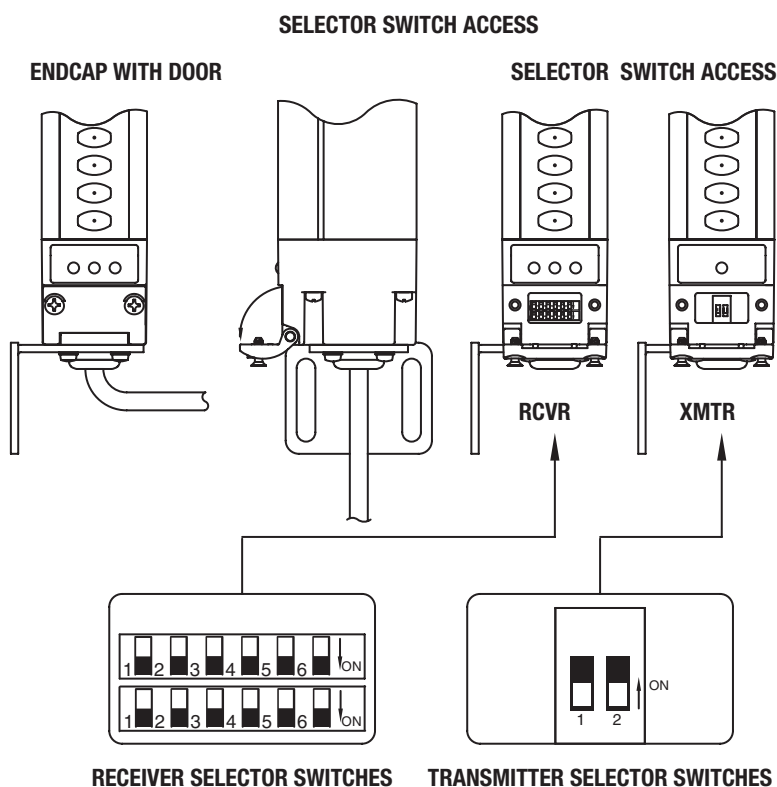

#### 7-1-1 Transmitter selector switch settings

Switch Position	Function	Factory default
1	SCAN CODE	SCAN CODE A
2	MTS	MTS OFF

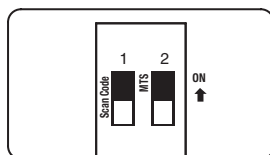

**Scan Code**  
 Frequency A 1 = Off  
 Frequency B 1 = On

**MTS**  
 Disabled 2 = Off  
 Enabled 2 = On

**TRANSMITTER SELECTOR SWITCHES**  
 (Shown in factory default positions)

### 7-1-2 Receiver selector switch settings

Switch A Position	Function	Switch B Position	Function	Factory Default
1	Auto Start or Start/Restart Interlock	1	Auto Start or Start/Restart Interlock	Auto Start (OFF)
2	EDM	2	EDM	Disabled (OFF)
3	Scan Code	3	Scan Code	Scan Code A (OFF)
4	Floating Blanking 1	4	Floating Blanking 1	Disabled (OFF)
5	Fixed Blanking	5	Fixed Blanking	Disabled (OFF)
6	Program (Non-safety)	6	Range (Non-safety)	Program (toggle) Long Range (ON)

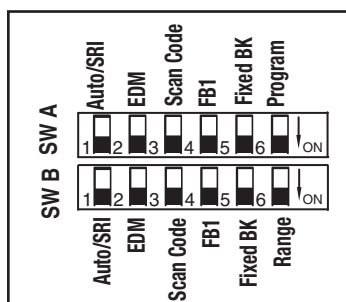

RECEIVER SELECTOR SWITCHES  
(Shown in factory default positions)

Operating Mode	SW A	SW B
Automatic Start	1 = Off	1 = Off
Start/Restart Int	1 = On	1 = On
EDM Disabled	2 = Off	2 = Off
EDM Enabled	2 = On	2 = On
Scan Code A	3 = Off	3 = Off
Scan Code B	3 = On	3 = On
FB1 Disabled	4 = Off	4 = Off
FB1 Enabled	4 = On	4 = On
Fixed Blanking		
Disabled	5 = Off	5 = Off
Enabled	5 = On	5 = On
Program	6 = Toggle	
Operating Range		
Short Range		6 = Off
Long Range		6 = On

## 7-2 Operating mode selection

The operating mode is selected by setting position 1 of switches A and B, located on the receiver. Any mismatch between the settings of switches A and B will result in an alarm condition. The available operating modes are automatic start and Start/Restart Interlock.

## 7-3 Selecting and programming Fixed Blanking

Refer to section 5-1 Fixed Blanking for details on selecting and programming Fixed Blanking function.

## 7-4 Selecting and programming Floating Blanking

Floating Blanking is activated by setting position 4 of Switches A and B located on the receiver.

**Note** When Floating Blanking is active, the amber LED will illuminate to indicate that the system is operating in a less sensitive state.

## 7-5 Selecting External Device Monitoring (EDM)

EDM is activated by setting position 2 of Switches A and B located on the receiver. Any mismatch between the settings of Switches A and B will result in an alarm condition.

## 7-6 Selecting Machine Test Signal (MTS)

MTS is activated by setting position 2 located on the transmitter end cap.

## 7-7 Selecting Scan Codes

The MS2800 receiver and transmitter offer scan code selection to minimize cross talk. On the transmitter this is activated by setting position 1. On the receiver this is activated by setting position 3 of switch A and switch B.

**Note** Both receiver and transmitter must be set to the same code.

Example:

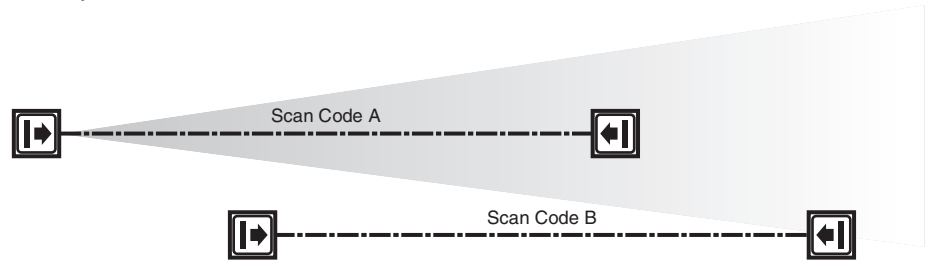



## SECTION 8 Outputs

### 8-1 Safety Outputs (OSSDs)

 **WARNING** This product is designed for use on a 24 VDC, negative ground (protective earth) electrical system only. Never connect the MS2800 system to a positive ground (protective earth) system. With a positive ground (protective earth) wiring scheme, certain simultaneous shorts of both safety outputs may not be detected and the guarded machine may not stop, resulting in severe operator injury.

The MS2800 system receiver supplies two independent PNP type safety outputs to provide run/stop signals to the guarded machine. In the MACHINE RUN state, the safety outputs are electrically conducting and source 625 mA of current at 24 VDC. In the MACHINE STOP state, the outputs are not electrically conducting.

### 8-2 Auxiliary Output

 **WARNING** Do not use the auxiliary output or external indicator output for safety applications. Human body may not be detected when MS2800 system fails, resulting in serious injury.

This is not a safety output. The MS2800 system supplies one auxiliary output. The configuration of this output is "PNP follow". So the signal on the auxiliary output is similar to the status of the OSSD outputs. It will source up to 100 mA at 24 VDC.





## SECTION 9 Safe Mounting Distances

**⚠ WARNING** Never install an MS2800 system without regard to the safety distance. If the MS2800 system is mounted too close to the point of operation hazard, the machine may not stop in time to prevent an operator injury.

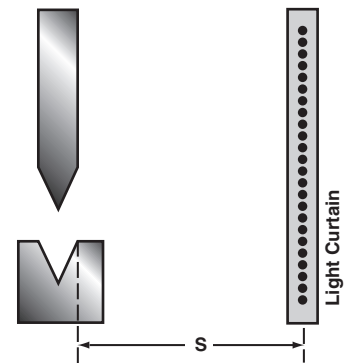

An MS2800 system must be mounted far enough from the machine danger zone so the machine will stop before a hand or other body part reaches the hazardous area. This distance is called the safety distance. It is a calculated number based on a formula.

The safety distance "S" is the minimum safe distance between the safety light curtain and the point of operation (pinch point).

Calculation of the safety distance "S" is based on the European standard EN999 and applies to safety light curtains that are used in industrial environments.

### 9-1 Safety distance for safeguarding danger points

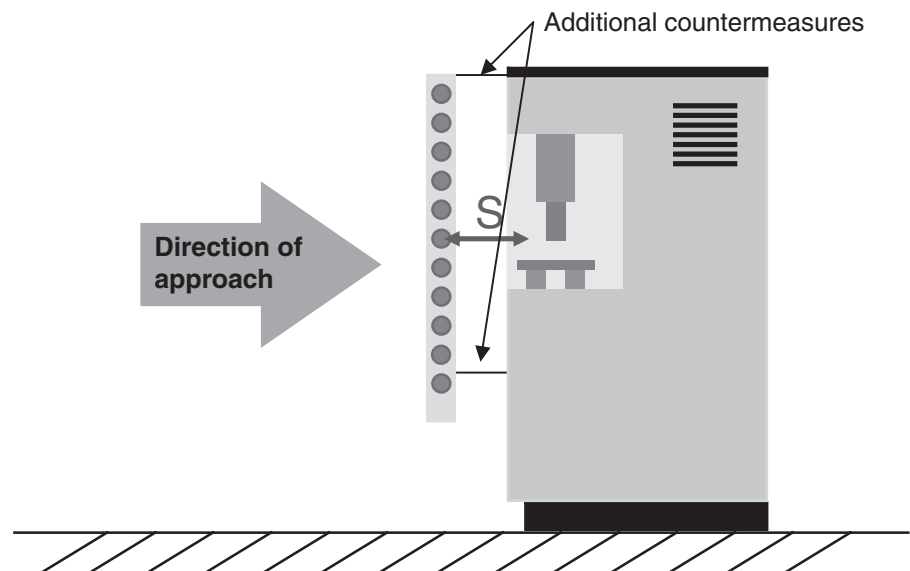

**⚠ WARNING** Additional countermeasures may be necessary to prevent access to the dangerous area from above, below, the sides or the rear of the machine.

**9-1-1 Calculation example for systems with a resolution of <40 mm**

Formula according to EN999:  $S = (K \times T) + C$

Where  $S$  = minimum distance in millimeters from the danger zone to the detection point, line, plane or zone. If the result of the calculation is less than 100 mm, a distance of at least 100 mm must still be maintained.

$K$  = Approach speed in mm/s. In the close area of 500 mm, the speed is calculated at 2000 mm/s. If the distance is greater than 500 mm,  $K$  can be calculated as 1600 mm/s. In this case, however, a minimum of 500 mm applies for the safety distance.

$T$  = the overall system stopping performance in seconds

$$T = t_1 + t_2 + t_3$$

$t_1$  = response time of the safety light curtain in seconds, given in the table in chapter 16.

$t_2$  = response time of the safety interface  $t_{si}$ , if any.

$t_3$  = maximum stopping time of the machine  $t_m$  in seconds.

Please refer to the technical information of the safety Interface and the machine for the response time and stopping time details.

$C$  =  $8 \times (d-14 \text{ mm})$ , but not less than zero.

$d$  = minimum object resolution of the MS2800 system in millimeters, therefore:

**$S = (2000 \text{ mm/s} \times T) + 8 \times (d-14 \text{ mm})$**

This formula applies for all minimum distances of  $S$  up to and including 500 mm. The minimum value of  $S$  shall not be less than 100 mm.

If  $S$  is found to be greater than 500 mm using the formula above, then the formula below can be used. In this case the minimum value of  $S$  shall not be less than 500 mm.

**$S = (1600 \text{ mm/s} \times T) + 8 \times (d-14 \text{ mm})$**

## 9-2 Safety distance for safeguarding danger areas

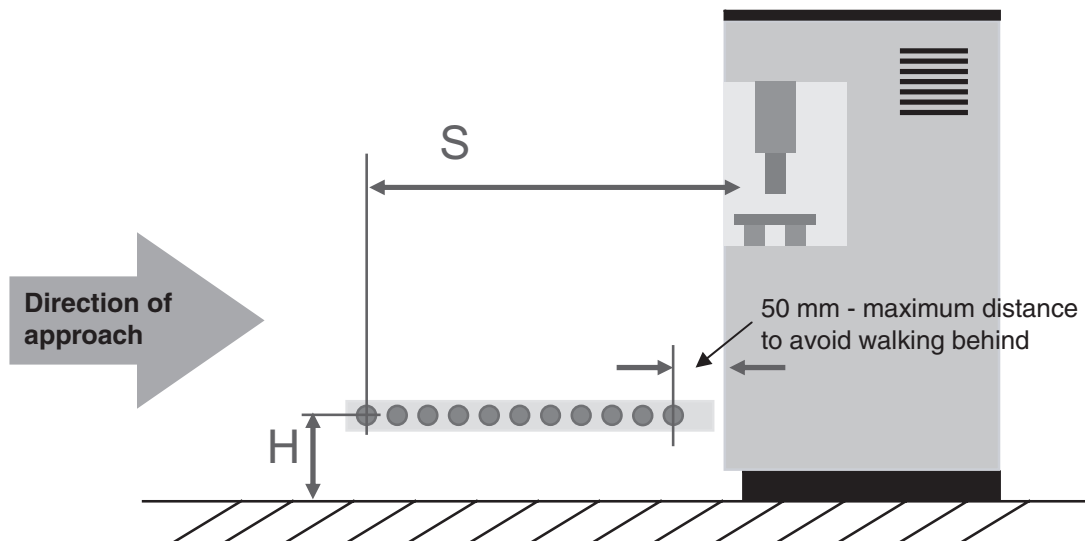

**⚠ WARNING** Additional countermeasures may be necessary to prevent access to the dangerous area from above, below, the sides or the rear of the machine.

The height of the protective field "H" above the reference plane and the resolution "d" of the MS2800 system have the following relationship:

$$H_{\min} = 15 \times (d - 50) \quad \text{or} \quad d = (H_{\min} / 15) + 50$$

$H_{\min}$  = Height of the protective field above the reference plane, maximum height = 1000 mm.

It is considered that if height is equal or less than 300 mm, adults can not crawl under.

$d$  = resolution of the MS2800 system

$S$  =  $(K \times T) + C$

For K and T please refer to the previous chapter

$C$  =  $(1200 \text{ mm} - 0,4 \times H)$  but not less than 850 mm (arm length)

$H$  = Height of protective field above the floor

**$S$  =  $(1600 \text{ mm} \times T) + (1200 - 0,4 \times H)$**

### 9-3 Safety distance and beam heights in access guarding

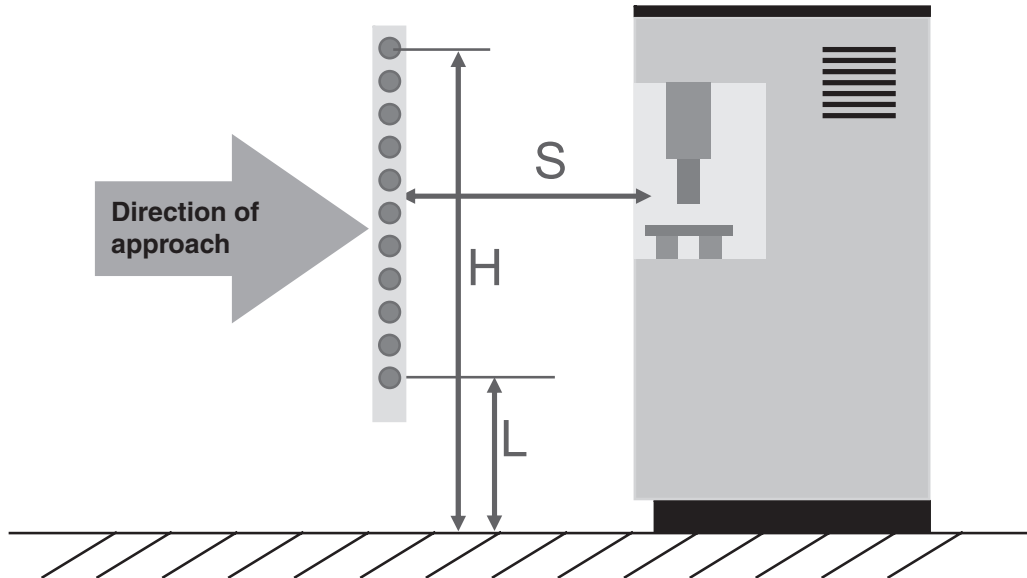

**⚠ WARNING** Additional countermeasures may be necessary to prevent access to the dangerous area from above, below, the sides or the rear of the machine.

According to EN999 and EN294:

Resolution	Lowest beam above reference plane	Highest beam above reference plane	Additional amount C (see formula)
14 mm	In accordance with EN 294	In accordance with EN 294	0 mm
30 mm	In accordance with EN 294	In accordance with EN 294	128 mm

The height of the protective field "H" above the reference plane and the resolution "d" of the MS2800 system have the following relationship:

$$S = (K \times T) + C$$

For K and T please refer to the previous chapter

$$C = 8 \times (d - 14)$$

d = resolution of the MS2800 system

$$S = (2000 \text{ mm} \times T) + 8 \times (d - 14)$$

# SECTION 10 Installation

**⚠ WARNING** Install the sensor system so that it is not affected by reflective surfaces. Failure to do so may hinder detection, resulting in serious injury.

## 10-1 Reflective Surface Interference

A reflective surface adjacent to the detection zone can deflect the optical beam and may cause an obstruction in the zone not to be detected. The reflective surface may be part of the machine, mechanical guard or work-piece. Therefore, a minimum distance ( $d$ ) must exist between the reflective object and the center line of the detection zone. The Test procedure (Appendix B) must be used to test for this condition.

In this picture, the interruption is clearly detected. The reflective object is outside of the beam angle

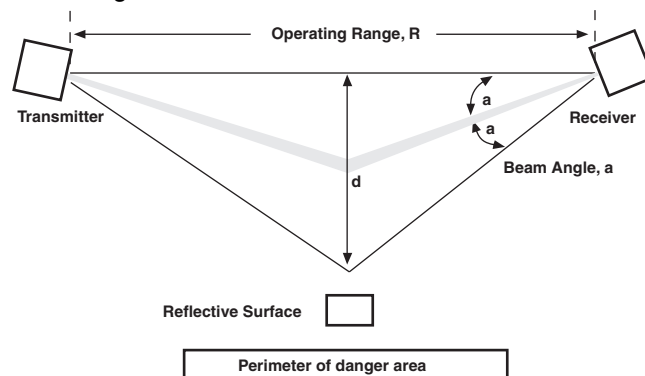

The following pictures show the scenario if the reflective surface is too close to the beam angle.

In this case, the interruption is not detected because the reflective object is inside the beam angle.

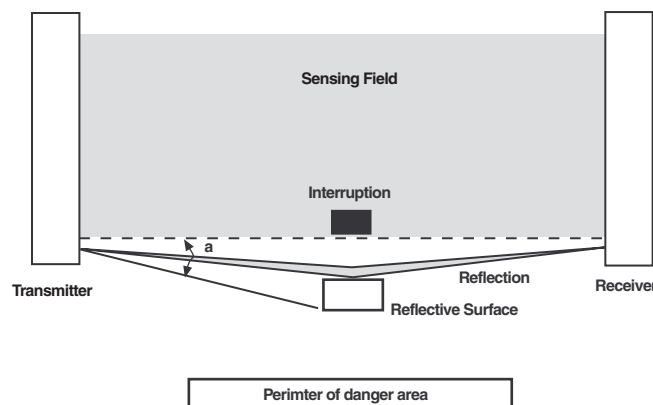

The interruption is not detected because of the reflection. Reflective surface interference may also appear above and below the sensing field.

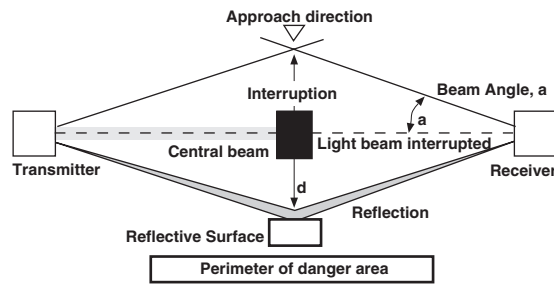

Worst case alignment example

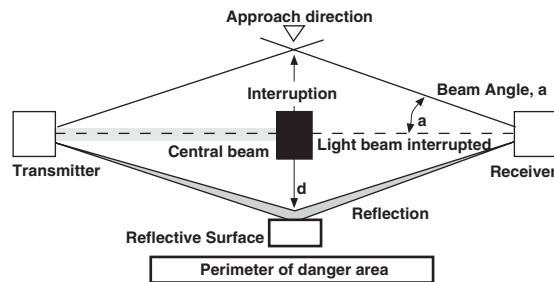

This example shows the minimum distance from the reflective surface,  $d$ , to one side of the beam center line

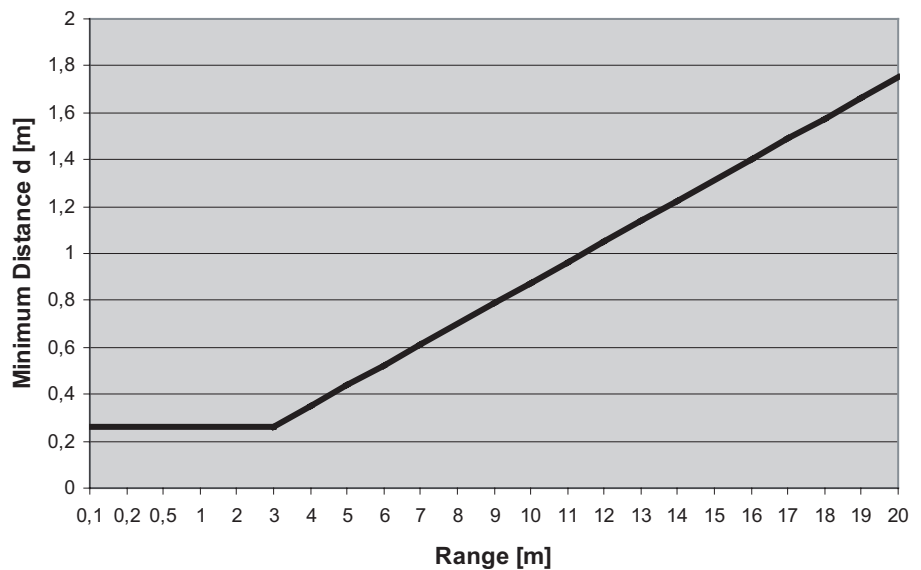

## 10-2 Cross Talk Mitigation

To mitigate interference from other light curtains, the MS2800 system has two possible scan codes, A and B. The transmitter and receiver units must be set to the same scan code for the receiver to enter the MACHINE RUN state.

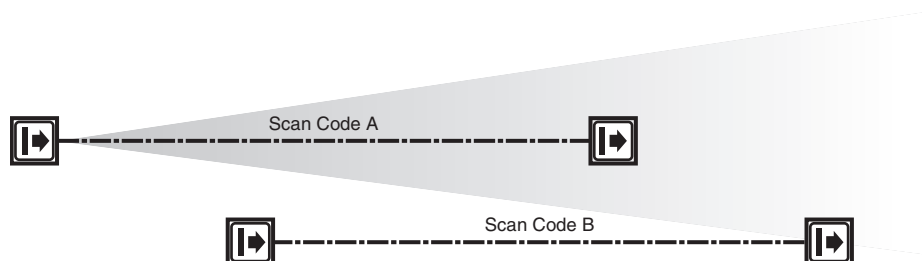

### 10-3 General Mounting Considerations

#### 10-3-1 Additional Guarding

Areas of access to the point of hazardous operation not guarded by the MS2800 system must be protected by suitable means such as a fixed barrier guard, an interlocked guard or a safety mat system.

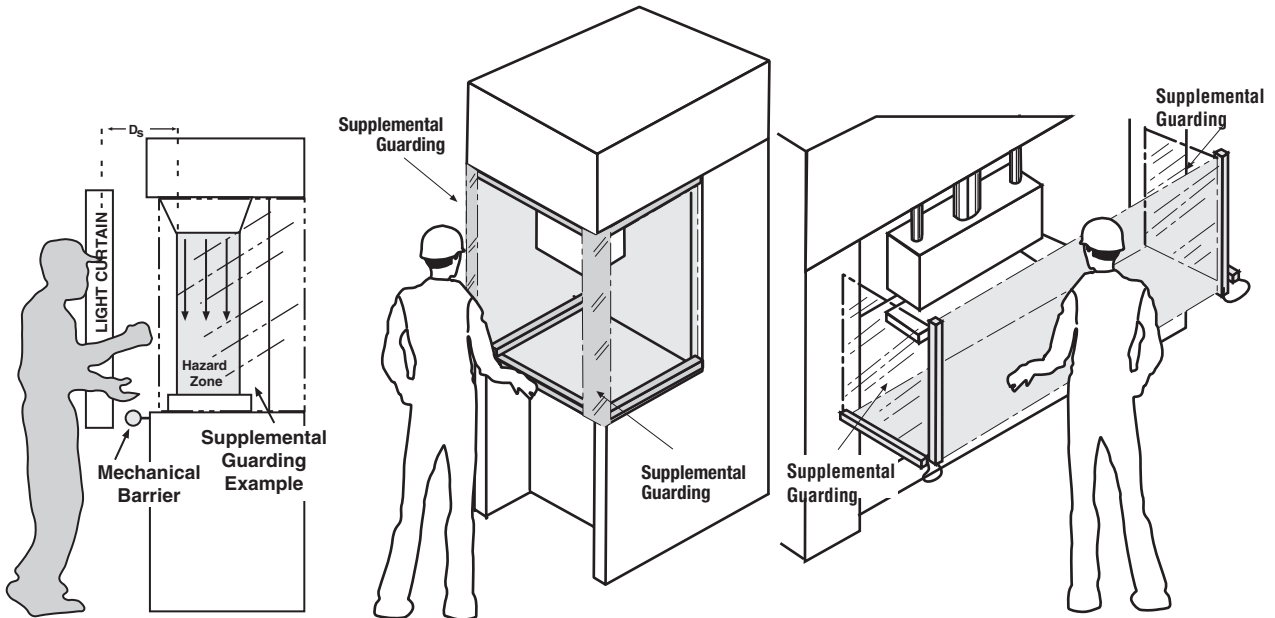

MS2800 point of operation guarding

MS2800FS 3-sided guarding

MS2800FS 2-Axis guarding

#### 10-3-2 Added Mounting Rigidity

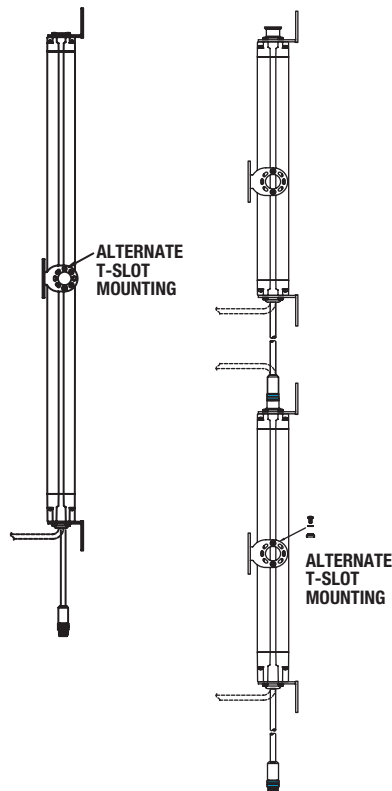

It is recommended that when installing a MS2800 larger than 1000 mm in length, you use an additional mounting bracket. This is to be installed using the T-slot on the backside of the transmitter and receiver.



### 10-3-3 Installation of Multiple Systems

When two or more MS2800 systems with the same scan code are mounted in close proximity and in alignment with each other, precautions should be taken to avoid one system interfering with another. This can be corrected by mounting the transmitters and receivers back-to-back or stacked.

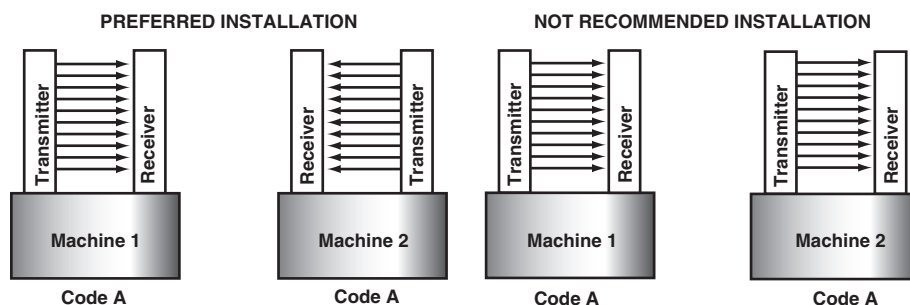

The scan code feature of the MS2800 system allows for placement of systems in close proximity and in line with each other. The distinctive coding of the beams provide for unique operation of a system while in view of another system with a different scan code. Two unique codes are available on the MS2800.

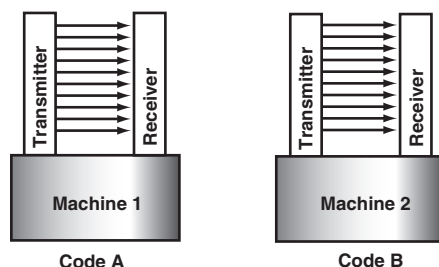

### 10-3-4 Detection Zone

The system detection zone is delineated by the inside edge of the transmitter and receiver endcaps. The area outside these marks is not protected. Position the system so that it is only possible to access the danger point through the detection zone.

### 10-3-5 Alignment

Physical alignment of the transmitter and receiver is easiest when the system is in the automatic start operating mode with Fixed Blanking inactive. The units should be in the same plane and at equal height.

The Individual Sector Indicators will light when a part of the Safety Light Curtain is out of alignment.

### 10-3-6 Input Power Requirements

The system operates directly from 24 VDC  $\pm 20\%$ . Power to the system must come from a power supply which meets the requirements of EN/IEC60204-1 and EN/IEC 61496-1.

The power supply must guarantee safe insulation from the mains voltage in accordance with IEC60742 and be able to cover a drop of supply voltage of at least 20 ms. Omron offers suitable power supplies. The power supply must not supply any other parts of the machine with power other than the safety components connected. Transmitters and receivers must be supplied from a shared power supply and must be fused against overcurrent.

### 10-3-7 Requirements for Perimeter Guarding

In perimeter guarding applications the MS2800 system detection zone is placed around the outside perimeter of a guarded machine. This placement leaves space for personnel to stand between the detection zone and the hazardous machine.

In this case, the guarded machine must only be restarted using a switch located outside and with a full view of the area of hazardous motion. Operation of the MS2800 system In the Start/Restart Interlock operating mode is suitable for perimeter guarding.

### 10-3-8 Marking Minimum Object Resolution

Serial number labels on the transmitter and receiver indicate possible minimum object resolutions. During installation, use a permanent marker to obscure the object resolution not set and add information about the effective resolution. This will depend on whether no floating blanking or 1-beam floating blanking is set.

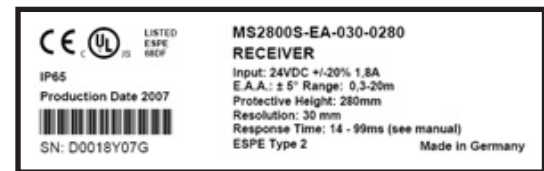
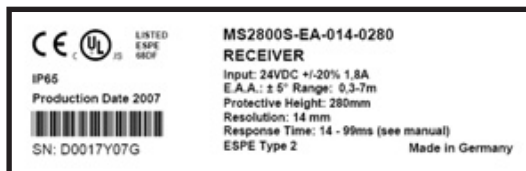



# SECTION 11

## Connection to the Machine Control Circuit

**⚠ WARNING** This product is designed for use on a 24 VDC, negative ground (protective earth) electrical system only. Never connect the MS2800 system to a positive ground (protective earth) system. With a positive ground (protective earth) wiring scheme, certain simultaneous shorts of both safety outputs may not be detected and the guarded machine may not stop, resulting in severe operator injury.

**⚠ WARNING** Never use only a single safety output to control the machine. Should this single output fail, the machine may not stop, resulting in severe operator injury. The machine must be connected using both safety outputs.

The table below references Pin Numbers, Wire colors and signal names being used with the MS2800 system.

		<b>Receiver cable</b>	
Pin No. 1	Input power	Brown	+24VDC
Pin No. 2	Input power	Blue	GND
Pin No. 3	Input power	Green	Functional Earth
Pin No. 4	Output signal	White	OSSD2
Pin No. 5	Input signal	Yellow	Start
Pin No. 6	Input signal	Red	EDM
Pin No. 7	Output signal	Pink	Aux
Pin No. 8	Output signal	Black	OSSD1
		<b>Transmitter cable</b>	
Pin No. 1	Input power	Blue	GND
Pin No. 2	Input power	Brown	+24VDC
Pin No. 3	Input test	White	MTS
Pin No. 4	Input test	Black	MTS Return
Pin No. 5	Input power	Green	Functional Earth

The primary cables for the MS2800 system are industry standard non-shielded cables with an M12 female connector. The receiver and transmitter incorporate a 0,3 m pigtail with an M12 male connector.

We recommend to use the F39-JMR and F39-JMT cables to connect the MS2800 system to the machine control system.

### 11-1 Interconnect cables for cascaded MS2800FS system

The segment-to-segment cable has a 4 contact M12 connector on each end. The maximum cable length is 10 meters between segments.

The extension cables are available in lengths of 0.3 m, 0.5 m, 1 m, 2 m, 5 m and 10 m. A MS2800FS system does not require an extension cable; it has a 150 mm integrated cable (pigtail).

MS2800FS systems are designed with internal circuit protection to protect from damage when they are connected and disconnected (hot-swap) during normal operation.

### 11-2 Connection to two forcibly guided relays

G7S and G7SA series relays provide forcibly guided relay outputs for machine control. Please refer to the next drawing for details:

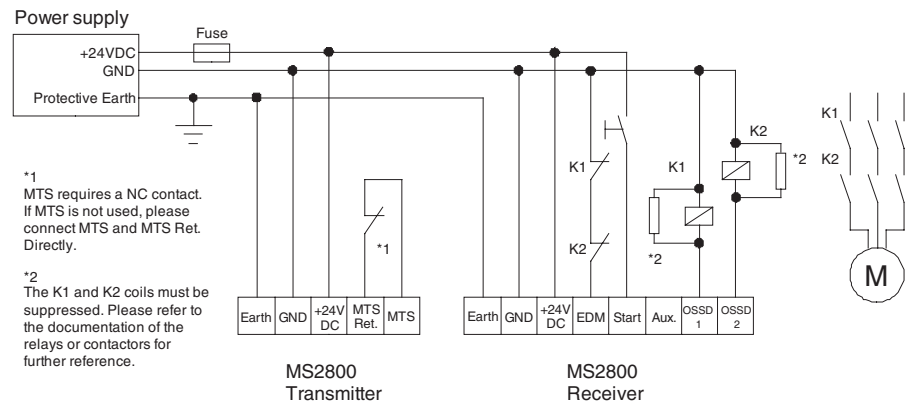





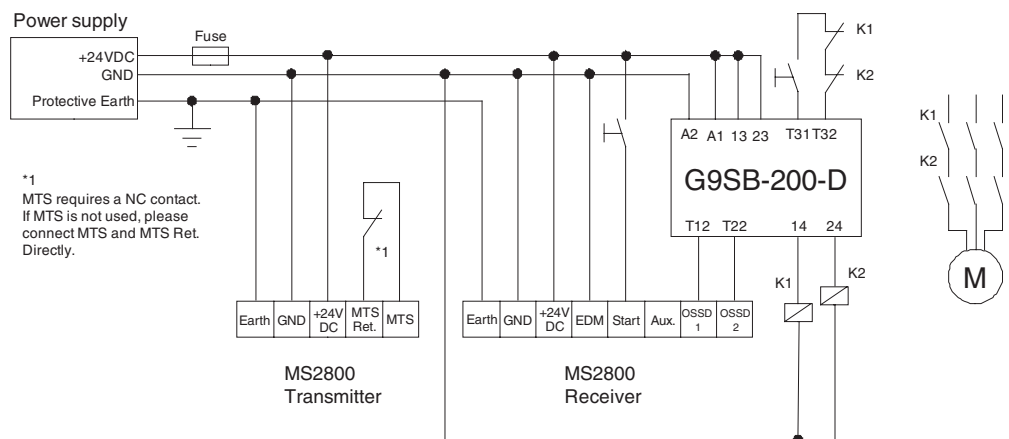

### 11-3 Connection to a safety relay unit

The following example shows a MS2800 system in combination with a G9SB safety relay unit from Omron. The G9SB safety relay unit provides forcibly guided relay contacts for the machine control system.



## SECTION 12

### Muting

-  **WARNING** The muting and override functions disable the safety functions of the device. You must ensure safety using other method when these functions are operating.
-  **WARNING** Install muting sensors so that they can distinguish between the object that is being allowed to pass through the detection zone and a person. If the muting function is activated by the detection of a person, it may result in serious injury.
-  **WARNING** Muting lamps (external indicators) that indicate the state of the muting and override functions must be installed where they are clearly visible to workers from all the operating positions.
-  **WARNING** Muting related time must be properly configured for its application by a sufficiently trained and qualified person, and the person must have responsibility for settings, especially when setting the muting time limit to infinite.
-  **WARNING** Use independent 2 input devices for muting inputs.
-  **WARNING** You must install MS2800 system muting sensor, and physical barrier, and configure time settings for muting so that an operator should not enter hazardous zone.
-  **WARNING** Install the switch that activates the override in a location that provides a clear view of the entire hazardous area and where it cannot be activated from within the hazardous area. Make sure that nobody is in the hazardous area before activating the override function.

### 12-1 Muting Controller RM-6

Muting with the MS2800 system is available together with the Muting Controller RM-6.

The MS2800 and an RM-6 offer a limited set of muting functions. The following list describes the muting functions that can be achieved with the MS2800:

- 2 Sensor muting
- 50 ms sensor input filtering
- Mute bypass allowed (configurable using sensor 4 input, +24 VDC = Enabled, 0 V or unconnected = Disabled)
- Mute timeout limit (configurable using sensor 3 input, +24 VDC = No Limit, 0 V or unconnected = 2 minute time option)

The MS2800 system requires a specific sequence to activate the muting function after the RM-6 is connected. Once the RM-6 is connected the system will not operate until either the mute module is removed or the following sequence is followed:

- The MS2800 will fault "71", (mute module enable and configuration required)
- With the power OFF, the start button must be pressed and remain pressed while the power is applied
- The three LEDs on the receiver end-cap will start flashing after 3 seconds
- The start button must be released within 5 seconds after the LEDs start flashing

When this sequence is properly completed, the system will enable muting.

For further information please check the user manual of the RM-6.

# SECTION 13

## Checkout and test procedure

### 13-1 Checkout Procedure

Once the MS2800 system has been configured, mounted, aligned and properly connected to the machine control system, the initial Checkout Procedure detailed in Appendix A **must** be performed by qualified personnel. A copy of the checkout results should be kept with the machine records.

### 13-2 Test Procedure

**⚠ WARNING** The tests outlined in the Test Procedure in Appendix B must be performed at installation, according to the employer's regular inspection program and after any maintenance, tooling change set up, adjustment or modification to the MS2800 system or the guarded machine. Where a guarded machine is used by multiple operators or shifts, it is suggested that the test procedure be performed at each shift or operator change. Testing ensures that the light curtain and the machine control system work properly to stop the machine. Failure to test properly could result in serious injury to personnel.

The test procedure must be performed by qualified personnel. To test the MS2800 system with fixed blanking and floating blanking disabled, use the OMRON STI supplied test object. For applications where fixed blanking or floating blanking is enabled, see Table in chapter 5-3-1 *The effect of Fixed or Floating Blanking on minimum object resolution* to determine the proper size of the test object.

When using a MS2800 system set for Automatic Start Mode operation, in conjunction with an OMRON safety relay module, it is necessary to verify that the outputs of the safety relay unit can properly change state by causing an intentional beam break at least every change of shift or 24 hours of operation.

### 13-3 Using the test object

When using the test object, guide it through the detection zone as shown:

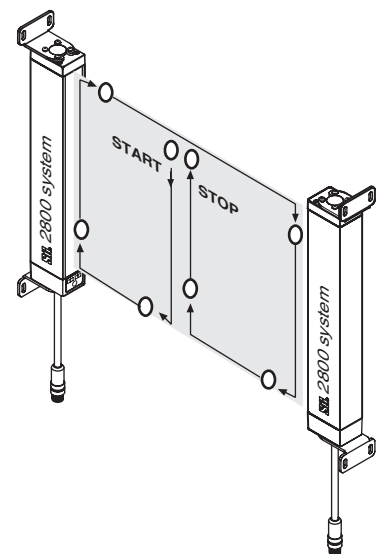





## **SECTION 14**

### **Cleaning**

Accumulation of oil, dirt and grease on the front window of the MS2800 transmitter and receiver can effect the system operation. Clean the window with a mild detergent or glass cleaner. Use a clean, soft, lint-free cloth. Painted MS2800 surfaces may be cleaned with a mild de-greasing cleaner or detergent.



## SECTION 15

### Specifications and additional information

#### 15-1 System Specification

<b>Performance</b>	
Protective height	240 mm - 1800 mm (14 mm resolution) 280 mm - 2120 mm (30 mm resolution)
Object Resolution	14 mm and 30 mm
Operating Range	0.3 m - 7 m (14 mm resolution), default 0.3 m - 3 m (14 mm resolution), DIP SW 6 option 0.3 m - 20 m (30 mm resolution), default 0.3 m - 8 m (30 mm resolution), DIP SW 6 option
Effective Aperture Angle	±5° maximum, transmitter and receiver according to IEC61496-2 (2006)
Safety Output (OSSDs)	Two PNP safety outputs, each output sourcing 625 mA @ 24 VDC. Short circuit protection
Response Time	Maximum: 59 ms See table below for more details
Auxiliary Output (non safety)	One PNP output sourcing 100 mA @ 24 VDC. This output follows the OSSDs.
EDM - Monitor Input	50 mA @ 24 VDC
Start/Restart Input	10 mA @ 24 VDC, Normally open input
Light Source	Infrared Emitting LEDs, Wavelength 880 nm Power Dissipation: 180 mW Class 1 per EN60825-1
Transmitter Indicator Lights	ACTIVE (Yellow)
Receiver Indicator Lights	MACHINE RUN/STOP (Green/Red) INTERLOCK/ALARM (Yellow) BLANKING (Amber)

<b>Mechanical</b>	
Housing Material	Polyurethane powder painted aluminum
Front Window Material	Acrylic, Red
End Cap Material	Polycarbonate
Mounting Bracket Material	Cold rolled Steel
Wiring connections	M12-connectors; 8-pin receiver and 5-pin transmitter
Weight	See table for more details

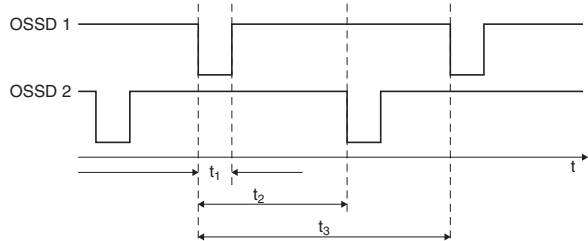
Electrical	
Power Input Transmitter	24 VDC ±20%, maximum current 285 mA
MTS Input	24 VDC ±20%, 20 mA typ.
Power Input Receiver	24 VDC ±20%, maximum current 1835 mA Receiver 485 mA + AUX 100 mA + OSSD1 625 mA + OSSD2 625 mA
Leakage current	< 1mA
Capacitive Load	< 4.7µF for OSSD output
Inductive Load	Please contact your Omron representative for further information.
Test pulse data	 <p>t1: Test pulse ≤ 600 µs t2: 4 ms ≤ Test interval ≤ 40 ms t3: Repetition ≤ 5 min</p>
Muting Option	24 VDC ±20%, 30 mA max.
Power Supply	Must meet the requirements of EN/IEC 60204-1 and EN/IEC 61496-1, and must guarantee safe insulation from the mains voltage in accordance with IEC 60742 and be able to cover a drop of supply voltage of at least 20 ms.
Protection class (IEC 536 or VDE 106)	III

Environmental	
Enclosure Rating	IP65
Operating Temperature	-10°C ... +55°C
Storage Temperature	-25°C ... +70°C
Relative Humidity	95% maximum, non-condensing
Vibration (IEC 60068-2-6)	10 - 55 Hz, 10g, maximum on all 3 axes
Shock (IEC 60086-2-29)	10g for 16 ms, 1000 shocks on all 3axes

Connections	
Cable length MS2800 Transmitter	Unshielded cables: Max. 50 m, @ 0.32 mm <sup>2</sup> <b>We recommend to use the F39-JMT cables to connect the MS2800 system to the machine control system.</b>
Cable length MS2800 Receiver	Unshielded cables, length is depending on the maximum current consumption: OSSD 1&2-load 625 mA: 12 m @ 0.5 mm <sup>2</sup> OSSD 1&2-load 300 mA: 45 m @ 0.5 mm <sup>2</sup> <b>We recommend to use the F39-JMR cables to connect the MS2800 system to the machine control system.</b>
Cable length MS2800FS system	Shielded cables, M12 connector 4-pin, these cables are available as accessories. Maximum length is 10 m between segments

Response time of MS2800 system					
One segment system			Two segment system		
Minimum number of beams	Maximum number of beams	Response Time	Minimum number of beams	Maximum number of beams	Response Time
0	16	14 ms	0	65	23 ms
17	71	23 ms	66	120	32 ms
72	126	32 ms	121	174	41 ms
127	180	41 ms	175	229	50 ms
181	235	50 ms	230	256	59 ms
236	256	59 ms			
Three segment system			Four segment system		
Minimum number of beams	Maximum number of beams	Response Time	Minimum number of beams	Maximum number of beams	Response Time
0	59	23 ms	0	53	23 ms
60	114	32 ms	54	108	32 ms
115	168	41 ms	109	162	41 ms
169	223	50 ms	163	217	50 ms
224	256	59 ms	218	256	59 ms

Conformity	
AOPD(ESPE)	Type 2 acc. to EN/IEC 61496-1 (2004) And EN/IEC 61496-2 (2006)
Safety category	MS2800E system is suitable for safety control systems up to Category 2 acc. EN954-1 (1996)
Safety Integrity Level	MS2800E system is suitable for up to SIL 3 per IEC 61508
PFH	$3,5 * 10^{-08}$
Proof test interval	Every 2 years (based on max. number of channels in a 4 segment system including muting system).

### 15-2 MS2800 system Dimensional Drawing

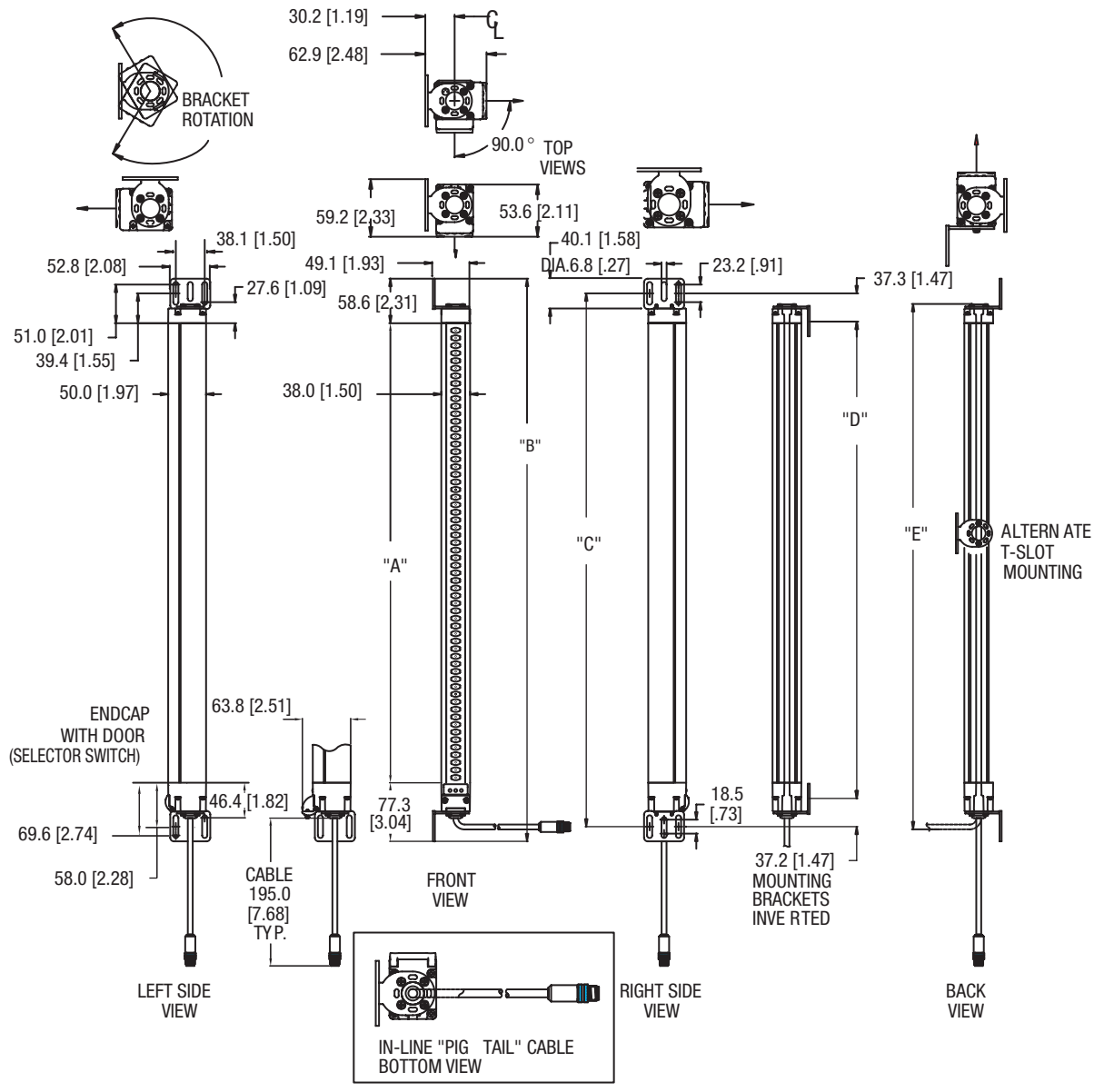

### 15-3 MS2800 system data with 14 mm resolution

	280 mm	320 mm	360 mm	400 mm	440 mm	480 mm
A	284,4	324,8	364,5	404,2	443,9	484,3
B	420,4	460,8	500,5	540,2	579,9	620,3
C	381,7	422,1	461,8	501,5	541,2	581,6
D	307,3	347,7	387,4	427,1	466,8	507,2
E	371,3	411,7	451,4	491,1	530,8	571,2
Weight	1,68 kg	1,81 kg	1,95 kg	2,13 kg	2,40 kg	2,49 kg
Number of Beams	28	32	36	40	44	48

	520 mm	560 mm	600 mm	640 mm	680 mm	720 mm
A	523,4	563,7	604,1	643,9	683,6	724,0
B	659,4	699,7	740,1	779,9	819,6	860,0
C	620,7	661,0	701,4	741,2	780,9	821,3
D	546,3	586,6	627,0	666,8	706,5	746,9
E	610,3	650,6	691,0	730,8	770,5	810,9
Weight	2,63 kg	2,81 kg	2,99 kg	3,18 kg	3,36 kg	3,54 kg
Number of Beams	52	56	60	64	68	72

	760 mm	800 mm	840 mm	880 mm	920 mm	960 mm
A	762,0	803,5	843,4	882,8	923,8	963,6
B	898,0	939,5	979,8	1018,8	1059,8	1099,6
C	859,3	900,8	941,1	980,1	1021,1	1060,9
D	784,9	826,4	866,7	905,7	946,7	986,5
E	848,9	890,4	930,7	969,7	1010,7	1050,5
Weight	3,76 kg	3,9 kg	4,08 kg	4,26 kg	4,45 kg	4,63 kg
Number of Beams	76	80	84	88	92	96

	1000 mm	1040 mm	1080 mm	1120 mm	1160 mm	1200 mm
A	1002,6	1042,9	1083,9	1122,3	1162,7	1203,8
B	1138,6	1178,9	1219,9	1258,3	1298,7	1339,8
C	1099,9	1140,2	1181,2	1219,6	1260,0	1301,1
D	1025,5	1065,8	1106,8	1145,2	1185,6	1226,7
E	1089,5	1129,8	1170,8	1209,2	1249,6	1290,7
Weight	4,81 kg	4,99 kg	5,17 kg	5,35 kg	5,53 kg	5,72 kg
Number of Beams	100	104	108	112	116	120

	1240 mm	1280 mm	1320 mm	1360 mm	1400 mm	1440 mm
A	1242,1	1281,8	1323,6	1361,0	1401,7	1443,4
B	1378,1	1417,8	1459,6	1497,0	1537,7	1579,4
C	1339,4	1379,1	1420,9	1458,3	1499,0	1540,7
D	1265,0	1304,7	1346,5	1383,9	1424,6	1466,3
E	1329,0	1368,7	1410,5	1447,9	1488,6	1530,3
Weight	5,94kg	6,08kg	6,26kg	6,44kg	6,62kg	6,80kg
Number of Beams	124	128	132	136	140	144



	1480 mm	1520 mm	1560 mm	1600 mm	1640 mm	1680 mm
A	1481,8	1521,5	1563,3	1600,9	1641,3	1681,3
B	1617,8	1657,5	1699,3	1736,9	1777,3	1817,3
C	1579,1	1618,8	1660,6	1698,2	1738,6	1778,6
D	1504,7	1544,4	1586,2	1623,8	1664,2	1740,2
E	1568,7	1608,4	1650,2	1687,8	1728,2	1768,2
Weight	6,99 kg	7,17 kg	7,35 kg	7,53 kg	7,71 kg	7,89 kg
Number of Beams	148	152	156	160	164	168

	1720 mm	1760 mm	1800 mm
A	1720,8	1760,5	1802,9
B	1856,8	1896,5	1938,9
C	1818,8	1857,8	1900,2
D	1743,7	1783,4	1825,8
E	1807,7	1847,4	1889,8
Weight	8,07kg	8,26kg	8,44kg
Number of Beams	172	176	180

## 15-4 MS2800 system data with 30 mm resolution

	240 mm	280 mm	320 mm	360 mm	400 mm	440 mm
A	244,6	284,4	324,8	364,5	404,2	443,9
B	380,6	420,4	460,8	500,5	540,2	579,9
C	341,9	381,7	422,1	461,8	501,5	541,2
D	267,5	307,3	347,7	387,4	427,1	466,8
E	331,5	371,3	411,7	451,4	491,1	530,8
Weight	1,55 kg	1,68 kg	1,81 kg	1,95 kg	2,13 kg	2,40 kg
Number of Beams	12	14	16	18	20	22

	480 mm	520 mm	560 mm	600 mm	640 mm	680 mm
A	484,3	523,4	563,7	604,1	643,9	683,6
B	620,3	659,4	699,7	740,1	779,9	819,6
C	581,6	620,7	661,0	701,4	741,2	780,9
D	507,2	546,3	586,6	627,0	666,8	706,5
E	571,2	610,3	650,6	691,0	730,8	770,5
Weight	2,49 kg	2,63 kg	2,81 kg	2,99 kg	3,18 kg	3,36 kg
Number of Beams	24	26	28	30	32	34

	720 mm	760 mm	800 mm	840 mm	880 mm	920 mm
A	724,0	762,0	803,5	843,4	882,8	923,8
B	860,0	898,0	939,5	979,8	1018,8	1059,8
C	821,3	859,3	900,8	941,1	980,1	1021,1
D	746,9	784,9	826,4	866,7	905,7	946,7
E	810,9	848,9	890,4	930,7	969,7	1010,7
Weight	3,54 kg	3,76 kg	3,90 kg	4,08 kg	4,26 kg	4,45 kg
Number of Beams	36	38	40	42	44	46

	960 mm	1000 mm	1040 mm	1080 mm	1120 mm	1160 mm
A	963,6	1002,6	1042,9	1083,9	1122,3	1162,7
B	1099,6	1138,6	1178,9	1219,9	1258,3	1298,7
C	1060,9	1099,9	1140,2	1181,2	1219,6	1260,0
D	986,5	1025,5	1065,8	1106,8	1145,2	1185,6
E	1050,5	1089,5	1129,8	1170,8	1209,2	1249,6
Weight	4,63 kg	4,81 kg	4,99 kg	5,17 kg	5,35 kg	5,53 kg
Number of Beams	48	50	52	54	56	58

	1200 mm	1240 mm	1280 mm	1320 mm	1360 mm	1400 mm
A	1203,8	1242,1	1281,8	1323,6	1361,0	1401,7
B	1339,8	1378,1	1417,8	1459,6	1497,0	1537,7
C	1301,1	1339,4	1379,1	1420,9	1458,3	1499,0
D	1226,7	1265,0	1304,7	1346,5	1383,9	1424,6
E	1290,7	1329,0	1368,7	1410,5	1447,9	1488,6
Weight	5,72 kg	5,94 kg	6,08 kg	6,26 kg	6,44 kg	6,62 kg
Number of Beams	60	62	64	66	68	70

	1440 mm	1480 mm	1520 mm	1560 mm	1600 mm	1640 mm
A	1443,4	1481,8	1521,5	1563,3	1600,9	1641,3
B	1579,4	1617,8	1657,5	1699,3	1736,9	1777,3
C	1540,7	1579,1	1618,8	1660,6	1698,2	1738,6
D	1466,3	1504,7	1544,4	1586,2	1623,8	1664,2
E	1530,3	1568,7	1608,4	1650,2	1687,8	1728,2
Weight	6,80kg	6,99kg	7,17kg	7,35kg	7,53kg	7,71kg
Number of Beams	72	74	76	78	80	82

	1680 mm	1720 mm	1760 mm	1800 mm	1840 mm	1880 mm
A	1681,3	1720,8	1764,5	1802,9	1840,6	1880,3
B	1817,3	1856,8	1896,5	1938,9	1976,6	2016,3
C	1778,6	1818,8	1857,8	1900,2	1937,9	1977,6
D	1740,2	1743,7	1783,4	1825,8	1863,5	1903,2
E	1768,2	1807,7	1847,4	1889,8	1927,5	1967,2
Weight	7,89 kg	8,07 kg	8,26 kg	8,44 kg	8,62 kg	8,80 kg
Number of Beams	84	86	88	90	92	94

	1920 mm	1960 mm	2000 mm	2040 mm	2080 mm	2120 mm
A	1922,8	1960,4	2000,1	2042,6	2079,6	2117,7
B	2058,8	2096,4	2136,1	2178,6	2215,6	2253,7
C	2020,1	2057,7	2097,4	2139,9	2176,9	2215,0
D	1945,7	1983,3	2023,0	2065,5	2102,5	2140,6
E	2009,7	2047,3	2087,0	2129,5	2166,5	2204,6
Weight	8,98 kg	9,16 kg	9,34 kg	9,53 kg	9,71 kg	9,89 kg
Number of Beams	96	98	100	102	104	106

# 15-5 MS2800FS system Dimensional Drawing

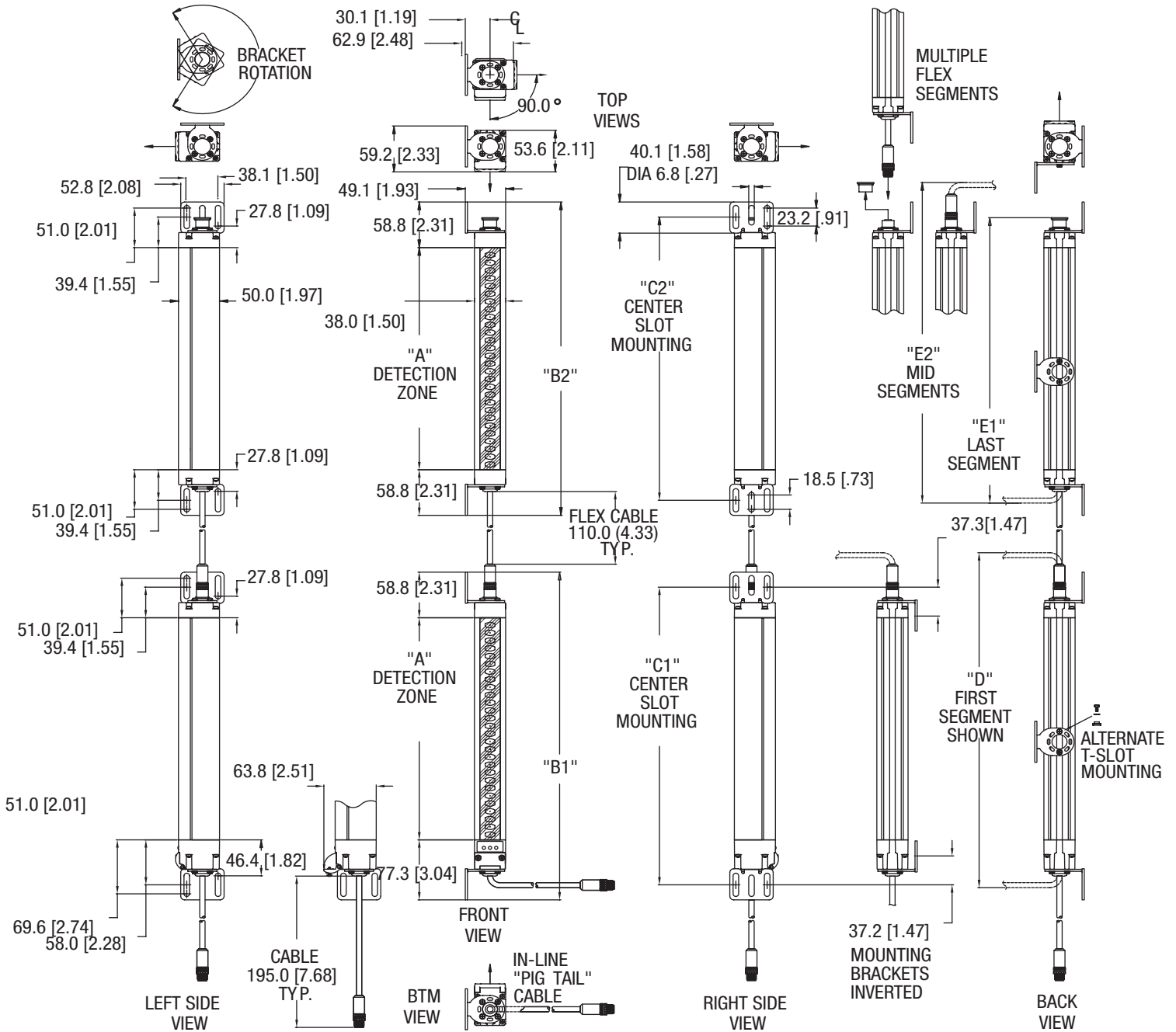

## 15-6 MS2800FS system data with 14 mm resolution

	240 mm	280 mm	320 mm	360 mm	400 mm	440 mm
A	244,6	284,4	324,8	364,5	404,2	443,9
B1	380,6	420,4	460,8	500,5	540,2	579,9
B2	362,1	401,9	442,3	482,0	521,7	561,4
C1	341,9	381,7	422,1	461,8	501,5	541,2
C2	323,3	363,1	403,5	443,2	482,9	522,6
D	389,8	429,6	470,0	509,7	549,4	589,1
E1	326,0	365,8	401,4	445,9	481,4	525,3
E2	371,3	411,1	451,5	491,2	530,9	570,6
Weight	1,55 kg	1,68 kg	1,81 kg	1,95 kg	2,13 kg	2,40 kg
Number of Beams	24	28	32	36	40	44

	480 mm	520 mm	560 mm	600 mm	640 mm	680 mm
A	484,3	523,4	563,7	604,1	643,9	683,6
B1	620,3	659,4	699,7	740,1	779,9	819,6
B2	601,8	640,9	681,2	721,6	761,4	801,1
C1	581,6	620,7	661,0	701,4	741,2	780,9
C2	563,0	602,1	642,4	682,8	722,6	762,3
D	629,5	668,6	708,9	749,3	789,1	828,8
E1	561,2	604,8	641,4	685,5	725,3	761,2
E2	611,0	650,1	690,4	730,8	770,6	810,3
Weight	2,49 kg	2,63 kg	2,81 kg	2,99 kg	3,18 kg	3,36 kg
Number of Beams	48	52	56	60	64	68

	720 mm	760 mm	800 mm	840 mm	880 mm	920 mm
A	724,0	762,0	803,5	843,4	882,8	923,8
B1	860,0	898,0	939,5	979,8	1018,8	1059,8
B2	841,5	879,5	921,0	961,3	1000,3	1041,3
C1	821,3	859,3	900,8	941,1	980,1	1021,1
C2	802,7	840,7	882,2	922,5	961,5	1002,5
D	869,2	907,1	948,7	989,0	1028,0	1069,0
E1	805,4	841,4	884,9	921,4	964,2	1005,2
E2	850,7	888,7	930,2	970,5	1009,6	1050,5
Weight	3,54kg	3,76kg	3,90kg	4,08kg	4,26kg	4,45kg
Number of Beams	72	76	80	84	88	92

	960 mm	1000 mm	1040 mm	1080 mm	1120 mm	1160 mm
A	963,6	1002,6	1042,9	1083,9	1122,3	1162,7
B1	1099,6	1138,6	1178,9	1219,9	1258,3	1298,7
B2	1081,1	1120,1	1160,4	1201,4	1239,8	1280,2
C1	1060,9	1099,9	1140,2	1181,2	1219,6	1260,0
C2	1042,3	1081,3	1121,6	1162,6	1201,0	1241,4
D	1108,8	1147,8	1188,1	1229,1	1267,5	1307,9
E1	1045,0	1084,0	1124,3	1165,3	1203,7	1244,1
E2	1090,3	1129,3	1169,6	1210,6	1249,0	1289,5
Weight	4,63 kg	4,81 kg	4,99 kg	5,17 kg	5,35 kg	5,53 kg
Number of Beams	96	100	104	108	112	116

	1200 mm	1240 mm	1280 mm	1320 mm	1360 mm	1400 mm
A	1203,8	1242,1	1281,8	1323,6	1361,0	1401,7
B1	1339,8	1378,1	1417,8	1459,6	1497,0	1537,7
B2	1321,3	1359,6	1399,3	1441,1	1478,5	1519,2
C1	1301,1	1339,4	1379,1	1420,9	1458,3	1499,0
C2	1282,5	1320,8	1360,5	1402,3	1439,7	1480,4
D	1349,0	1387,3	1427,0	1468,8	1506,2	1546,9
E1	1285,2	1323,5	1363,2	1405,0	1442,4	1483,1
E2	1330,5	1368,8	1408,5	1450,3	1487,7	1528,4
Weight	5,72 kg	5,94 kg	6,08 kg	6,26 kg	6,44 kg	6,62 kg
Number of Beams	120	124	128	132	136	140

	1440 mm	1480 mm	1520 mm	1560 mm	1600 mm	1640 mm
A	1443,4	1481,8	1521,5	1563,3	1600,9	1641,3
B1	1579,4	1617,8	1657,5	1699,3	1736,9	1777,3
B2	1560,9	1599,3	1639,0	1680,8	1718,4	1758,8
C1	1540,7	1579,1	1618,8	1660,6	1698,2	1738,6
C2	1522,1	1560,5	1600,2	1642,0	1679,6	1720,0
D	1588,6	1627,0	1666,7	1708,5	1746,1	1786,5
E1	1524,8	1563,2	1602,9	1644,7	1682,3	1722,7
E2	1570,1	1608,5	1648,2	1690,0	1727,6	1768,0
Weight	6,80 kg	6,99 kg	7,17 kg	7,35 kg	7,53 kg	7,71 kg
Number of Beams	144	148	152	156	160	164

	1680 mm	1720 mm	1760 mm	1800 mm
A	1681,3	1720,8	1764,5	1802,9
B1	1817,3	1856,8	1896,5	1938,9
B2	1789,8	1838,3	1878,0	1920,4
C1	1778,6	1818,8	1857,8	1900,2
C2	1760,0	1799,5	1839,2	1881,6
D	1826,5	1866,0	1905,7	1948,1
E1	1762,7	1802,2	1841,9	1884,3
E2	1808,0	1847,5	1887,2	1929,6
Weight	7,89 kg	8,07 kg	8,26 kg	8,44 kg
Number of Beams	168	172	176	180

## 15-7 MS2800FS system data with 30 mm resolution

	240 mm	280 mm	320 mm	360 mm	400 mm	440 mm
A	244,6	284,4	324,8	364,5	404,2	443,9
B1	380,6	420,4	460,8	500,5	540,2	579,9
B2	362,1	401,9	442,3	482,0	521,7	561,4
C1	341,9	381,7	422,1	461,8	501,5	541,2
C2	323,3	363,1	403,5	443,2	482,9	522,6
D	389,8	429,6	470,0	509,7	549,4	589,1
E1	326,0	365,8	401,4	445,9	481,4	525,3
E2	371,3	411,1	451,5	491,2	530,9	570,6
Weight	1,55 kg	1,68 kg	1,81 kg	1,95 kg	2,13 kg	2,40 kg
Number of Beams	12	14	16	18	20	22

	480 mm	520 mm	560 mm	600 mm	640 mm	680 mm
A	484,3	523,4	563,7	604,1	643,9	683,6
B1	620,3	659,4	699,7	740,1	779,9	819,6
B2	601,8	640,9	681,2	721,6	761,4	801,1
C1	581,6	620,7	661,0	701,4	741,2	780,9
C2	563,0	602,1	642,4	682,8	722,6	762,3
D	629,5	668,6	708,9	749,3	789,1	828,8
E1	561,2	604,8	641,4	685,5	725,3	761,2
E2	611,0	650,1	690,4	730,8	770,6	810,3
Weight	2,49 kg	2,63 kg	2,81 kg	2,99 kg	3,18 kg	3,36 kg
Number of Beams	24	26	28	30	32	34

	720 mm	760 mm	800 mm	840 mm	880 mm	920 mm
A	724,0	762,0	803,5	843,4	882,8	923,8
B1	860,0	898,0	939,5	979,8	1018,8	1059,8
B2	841,5	879,5	921,0	961,3	1000,3	1041,3
C1	821,3	859,3	900,8	941,1	980,1	1021,1
C2	802,7	840,7	882,2	922,5	961,5	1002,5
D	869,2	907,1	948,7	989,0	1028,0	1069,0
E1	805,4	841,4	884,9	921,4	964,2	1005,2
E2	850,7	888,7	930,2	970,5	1009,6	1050,5
Weight	3,54 kg	3,76 kg	3,90 kg	4,08 kg	4,26 kg	4,45 kg
Number of Beams	36	38	40	42	44	46

	960 mm	1000 mm	1040 mm	1080 mm	1120 mm	1160 mm
A	963,6	1002,6	1042,9	1083,9	1122,3	1162,7
B1	1099,6	1138,6	1178,9	1219,9	1258,3	1298,7
B2	1081,1	1120,1	1160,4	1201,4	1239,8	1280,2
C1	1060,9	1099,9	1140,2	1181,2	1219,6	1260,0
C2	1042,3	1081,3	1121,6	1162,6	1201,0	1241,4
D	1108,8	1147,8	1188,1	1229,1	1267,5	1307,9
E1	1045,0	1084,0	1124,3	1165,3	1203,7	1244,1
E2	1090,3	1129,3	1169,6	1210,6	1249,0	1289,5
Weight	4,63 kg	4,81 kg	4,99 kg	5,17 kg	5,35 kg	5,53 kg
Number of Beams	48	50	52	54	56	58

	1200 mm	1240 mm	1280 mm	1320 mm	1360 mm	1400 mm
A	1203,8	1242,1	1281,8	1323,6	1361,0	1401,7
B1	1339,8	1378,1	1417,8	1459,6	1497,0	1537,7
B2	1321,3	1359,6	1399,3	1441,1	1478,5	1519,2
C1	1301,1	1339,4	1379,1	1420,9	1458,3	1499,0
C2	1282,5	1320,8	1360,5	1402,3	1439,7	1480,4
D	1349,0	1387,3	1427,0	1468,8	1506,2	1546,9
E1	1285,2	1323,5	1363,2	1405,0	1442,4	1483,1
E2	1330,5	1368,8	1408,5	1450,3	1487,7	1528,4
Weight	5,72 kg	5,94 kg	6,08 kg	6,26 kg	6,44 kg	6,62 kg
Number of Beams	60	62	64	66	68	70

	1440 mm	1480 mm	1520 mm	1560 mm	1600 mm	1640 mm
A	1443,4	1481,8	1521,5	1563,3	1600,9	1641,3
B1	1579,4	1617,8	1657,5	1699,3	1736,9	1777,3
B2	1560,9	1599,3	1639,0	1680,8	1718,4	1758,8
C1	1540,7	1579,1	1618,8	1660,6	1698,2	1738,6
C2	1522,1	1560,5	1600,2	1642,0	1679,6	1720,0
D	1588,6	1627,0	1666,7	1708,5	1746,1	1786,5
E1	1524,8	1563,2	1602,9	1644,7	1682,3	1722,7
E2	1570,1	1608,5	1648,2	1690,0	1727,6	1768,0
Weight	6,80 kg	6,99 kg	7,17 kg	7,35 kg	7,53 kg	7,71 kg
Number of Beams	72	74	76	78	80	82

	1680 mm	1720 mm	1760 mm	1800 mm	1840 mm	1880 mm
A	1681,3	1720,8	1764,5	1802,9	1840,6	1880,3
B1	1817,3	1856,8	1896,5	1938,9	1976,6	2016,3
B2	1789,8	1838,3	1878,0	1920,4	1958,1	1997,8
C1	1778,6	1818,8	1857,8	1900,2	1937,9	1977,6
C2	1760,0	1799,5	1839,2	1881,6	1919,3	1959,0
D	1826,5	1866,0	1905,7	1948,1	1958,8	2025,5
E1	1762,7	1802,2	1841,9	1884,3	1922,0	1961,7
E2	1808,0	1847,5	1887,2	1929,6	1967,3	2007,0
Weight	7,89 kg	8,07 kg	8,26 kg	8,44 kg	8,62 kg	8,80 kg
Number of Beams	84	86	88	90	92	94

	1920 mm	1960 mm	2000 mm	2040 mm	2080 mm	2120 mm
A	1922,8	1960,4	2000,1	2042,6	2079,6	2117,7
B1	2058,8	2096,4	2136,1	2178,6	2215,6	2253,7
B2	2040,3	2077,9	2117,6	2160,1	2197,1	2235,2
C1	2020,1	2057,7	2097,4	2139,9	2176,9	2215,0
C2	2001,5	2039,1	2078,8	221,3	2158,3	1^96,4
D	2068,0	2105,6	2145,3	2187,8	2224,8	2262,9
E1	2004,2	2041,8	2081,5	2124,0	2161,0	2199,1
E2	2049,5	2087,1	2126,8	2169,3	2206,3	2244,4
Weight	8,98 kg	9,16 kg	9,34 kg	9,53 kg	9,71 kg	9,89 kg
Number of Beams	96	98	100	102	104	106

## 15-8 List of models

Basic version, 14 mm resolution, Standalone units without Flex connection

Type Name	Version	Resolution [mm]	Length [mm]	Operation
<b>MS2800S-EB-014-0280</b>	<b>Basic</b>	<b>14 mm</b>	<b>280</b>	<b>Standalone</b>
<b>MS2800S-EB-014-0320</b>	<b>Basic</b>	<b>14 mm</b>	<b>320</b>	<b>Standalone</b>
MS2800S-EB-014-0360	Basic	14 mm	360	Standalone
MS2800S-EB-014-0400	Basic	14 mm	400	Standalone
<b>MS2800S-EB-014-0440</b>	<b>Basic</b>	<b>14 mm</b>	<b>440</b>	<b>Standalone</b>
MS2800S-EB-014-0480	Basic	14 mm	480	Standalone
MS2800S-EB-014-0520	Basic	14 mm	520	Standalone
MS2800S-EB-014-0560	Basic	14 mm	560	Standalone
<b>MS2800S-EB-014-0600</b>	<b>Basic</b>	<b>14 mm</b>	<b>600</b>	<b>Standalone</b>
MS2800S-EB-014-0640	Basic	14 mm	640	Standalone
MS2800S-EB-014-0680	Basic	14 mm	680	Standalone
<b>MS2800S-EB-014-0720</b>	<b>Basic</b>	<b>14 mm</b>	<b>720</b>	<b>Standalone</b>
<b>MS2800S-EB-014-0760</b>	<b>Basic</b>	<b>14 mm</b>	<b>760</b>	<b>Standalone</b>
MS2800S-EB-014-0800	Basic	14 mm	800	Standalone
MS2800S-EB-014-0840	Basic	14 mm	840	Standalone
<b>MS2800S-EB-014-0880</b>	<b>Basic</b>	<b>14 mm</b>	<b>880</b>	<b>Standalone</b>
<b>MS2800S-EB-014-0920</b>	<b>Basic</b>	<b>14 mm</b>	<b>920</b>	<b>Standalone</b>
MS2800S-EB-014-0960	Basic	14 mm	960	Standalone
MS2800S-EB-014-1000	Basic	14 mm	1000	Standalone
<b>MS2800S-EB-014-1040</b>	<b>Basic</b>	<b>14 mm</b>	<b>1040</b>	<b>Standalone</b>
MS2800S-EB-014-1080	Basic	14 mm	1080	Standalone
MS2800S-EB-014-1120	Basic	14 mm	1120	Standalone
MS2800S-EB-014-1160	Basic	14 mm	1160	Standalone
<b>MS2800S-EB-014-1200</b>	<b>Basic</b>	<b>14 mm</b>	<b>1200</b>	<b>Standalone</b>
MS2800S-EB-014-1240	Basic	14 mm	1240	Standalone
MS2800S-EB-014-1280	Basic	14 mm	1280	Standalone
<b>MS2800S-EB-014-1320</b>	<b>Basic</b>	<b>14 mm</b>	<b>1320</b>	<b>Standalone</b>
<b>MS2800S-EB-014-1360</b>	<b>Basic</b>	<b>14 mm</b>	<b>1360</b>	<b>Standalone</b>
MS2800S-EB-014-1400	Basic	14 mm	1400	Standalone
MS2800S-EB-014-1440	Basic	14 mm	1440	Standalone
<b>MS2800S-EB-014-1480</b>	<b>Basic</b>	<b>14 mm</b>	<b>1480</b>	<b>Standalone</b>
<b>MS2800S-EB-014-1520</b>	<b>Basic</b>	<b>14 mm</b>	<b>1520</b>	<b>Standalone</b>
MS2800S-EB-014-1560	Basic	14 mm	1560	Standalone
MS2800S-EB-014-1600	Basic	14 mm	1600	Standalone
<b>MS2800S-EB-014-1640</b>	<b>Basic</b>	<b>14 mm</b>	<b>1640</b>	<b>Standalone</b>
MS2800S-EB-014-1680	Basic	14 mm	1680	Standalone
MS2800S-EB-014-1720	Basic	14 mm	1720	Standalone
MS2800S-EB-014-1760	Basic	14 mm	1760	Standalone
<b>MS2800S-EB-014-1800</b>	<b>Basic</b>	<b>14 mm</b>	<b>1800</b>	<b>Standalone</b>



Advanced version, 14 mm resolution, Standalone unit without Flex connection

Type Name	Version	Resolution [mm]	Length [mm]	Operation
<b>MS2800S-EA-014-0280</b>	<b>Advanced</b>	<b>14 mm</b>	<b>280</b>	<b>Standalone</b>
<b>MS2800S-EA-014-0320</b>	<b>Advanced</b>	<b>14 mm</b>	<b>320</b>	<b>Standalone</b>
<b>MS2800S-EA-014-0360</b>	<b>Advanced</b>	<b>14 mm</b>	<b>360</b>	<b>Standalone</b>
MS2800S-EA-014-0400	Advanced	14 mm	400	Standalone
<b>MS2800S-EA-014-0440</b>	<b>Advanced</b>	<b>14 mm</b>	<b>440</b>	<b>Standalone</b>
MS2800S-EA-014-0480	Advanced	14 mm	480	Standalone
<b>MS2800S-EA-014-0520</b>	<b>Advanced</b>	<b>14 mm</b>	<b>520</b>	<b>Standalone</b>
MS2800S-EA-014-0560	Advanced	14 mm	560	Standalone
<b>MS2800S-EA-014-0600</b>	<b>Advanced</b>	<b>14 mm</b>	<b>600</b>	<b>Standalone</b>
MS2800S-EA-014-0640	Advanced	14 mm	640	Standalone
MS2800S-EA-014-0680	Advanced	14 mm	680	Standalone
<b>MS2800S-EA-014-0720</b>	<b>Advanced</b>	<b>14 mm</b>	<b>720</b>	<b>Standalone</b>
<b>MS2800S-EA-014-0760</b>	<b>Advanced</b>	<b>14 mm</b>	<b>760</b>	<b>Standalone</b>
<b>MS2800S-EA-014-0800</b>	<b>Advanced</b>	<b>14 mm</b>	<b>800</b>	<b>Standalone</b>
MS2800S-EA-014-0840	Advanced	14 mm	840	Standalone
<b>MS2800S-EA-014-0880</b>	<b>Advanced</b>	<b>14 mm</b>	<b>880</b>	<b>Standalone</b>
<b>MS2800S-EA-014-0920</b>	<b>Advanced</b>	<b>14 mm</b>	<b>920</b>	<b>Standalone</b>
<b>MS2800S-EA-014-0960</b>	<b>Advanced</b>	<b>14 mm</b>	<b>960</b>	<b>Standalone</b>
MS2800S-EA-014-1000	Advanced	14 mm	1000	Standalone
<b>MS2800S-EA-014-1040</b>	<b>Advanced</b>	<b>14 mm</b>	<b>1040</b>	<b>Standalone</b>
MS2800S-EA-014-1080	Advanced	14 mm	1080	Standalone
MS2800S-EA-014-1120	Advanced	14 mm	1120	Standalone
<b>MS2800S-EA-014-1160</b>	<b>Advanced</b>	<b>14 mm</b>	<b>1160</b>	<b>Standalone</b>
<b>MS2800S-EA-014-1200</b>	<b>Advanced</b>	<b>14 mm</b>	<b>1200</b>	<b>Standalone</b>
<b>MS2800S-EA-014-1240</b>	<b>Advanced</b>	<b>14 mm</b>	<b>1240</b>	<b>Standalone</b>
MS2800S-EA-014-1280	Advanced	14 mm	1280	Standalone
<b>MS2800S-EA-014-1320</b>	<b>Advanced</b>	<b>14 mm</b>	<b>1320</b>	<b>Standalone</b>
<b>MS2800S-EA-014-1360</b>	<b>Advanced</b>	<b>14 mm</b>	<b>1360</b>	<b>Standalone</b>
<b>MS2800S-EA-014-1400</b>	<b>Advanced</b>	<b>14 mm</b>	<b>1400</b>	<b>Standalone</b>
MS2800S-EA-014-1440	Advanced	14 mm	1440	Standalone
<b>MS2800S-EA-014-1480</b>	<b>Advanced</b>	<b>14 mm</b>	<b>1480</b>	<b>Standalone</b>
<b>MS2800S-EA-014-1520</b>	<b>Advanced</b>	<b>14 mm</b>	<b>1520</b>	<b>Standalone</b>
<b>MS2800S-EA-014-1560</b>	<b>Advanced</b>	<b>14 mm</b>	<b>1560</b>	<b>Standalone</b>
MS2800S-EA-014-1600	Advanced	14 mm	1600	Standalone
<b>MS2800S-EA-014-1640</b>	<b>Advanced</b>	<b>14 mm</b>	<b>1640</b>	<b>Standalone</b>
MS2800S-EA-014-1680	Advanced	14 mm	1680	Standalone
<b>MS2800S-EA-014-1720</b>	<b>Advanced</b>	<b>14 mm</b>	<b>1720</b>	<b>Standalone</b>
MS2800S-EA-014-1760	Advanced	14 mm	1760	Standalone
<b>MS2800S-EA-014-1800</b>	<b>Advanced</b>	<b>14 mm</b>	<b>1800</b>	<b>Standalone</b>

Basic version, 30 mm resolution, Standalone unit without Flex connection

Type Name	Version	Resolution [mm]	Length [mm]	Operation
<b>MS2800S-EB-030-0280</b>	<b>Basic</b>	<b>30 mm</b>	<b>280</b>	<b>Standalone</b>
<b>MS2800S-EB-030-0320</b>	<b>Basic</b>	<b>30 mm</b>	<b>320</b>	<b>Standalone</b>
MS2800S-EB-030-0360	Basic	30 mm	360	Standalone
MS2800S-EB-030-0400	Basic	30 mm	400	Standalone
<b>MS2800S-EB-030-0440</b>	<b>Basic</b>	<b>30 mm</b>	<b>440</b>	<b>Standalone</b>
MS2800S-EB-030-0480	Basic	30 mm	480	Standalone
MS2800S-EB-030-0520	Basic	30 mm	520	Standalone
MS2800S-EB-030-0560	Basic	30 mm	560	Standalone
<b>MS2800S-EB-030-0600</b>	<b>Basic</b>	<b>30 mm</b>	<b>600</b>	<b>Standalone</b>
MS2800S-EB-030-0640	Basic	30 mm	640	Standalone
MS2800S-EB-030-0680	Basic	30 mm	680	Standalone
<b>MS2800S-EB-030-0720</b>	<b>Basic</b>	<b>30 mm</b>	<b>720</b>	<b>Standalone</b>
<b>MS2800S-EB-030-0760</b>	<b>Basic</b>	<b>30 mm</b>	<b>760</b>	<b>Standalone</b>
MS2800S-EB-030-0800	Basic	30 mm	800	Standalone
MS2800S-EB-030-0840	Basic	30 mm	840	Standalone
<b>MS2800S-EB-030-0880</b>	<b>Basic</b>	<b>30 mm</b>	<b>880</b>	<b>Standalone</b>
<b>MS2800S-EB-030-0920</b>	<b>Basic</b>	<b>30 mm</b>	<b>920</b>	<b>Standalone</b>
MS2800S-EB-030-0960	Basic	30 mm	960	Standalone
MS2800S-EB-030-1000	Basic	30 mm	1000	Standalone
<b>MS2800S-EB-030-1040</b>	<b>Basic</b>	<b>30 mm</b>	<b>1040</b>	<b>Standalone</b>
MS2800S-EB-030-1080	Basic	30 mm	1080	Standalone
MS2800S-EB-030-1120	Basic	30 mm	1120	Standalone
MS2800S-EB-030-1160	Basic	30 mm	1160	Standalone
<b>MS2800S-EB-030-1200</b>	<b>Basic</b>	<b>30 mm</b>	<b>1200</b>	<b>Standalone</b>
MS2800S-EB-030-1240	Basic	30 mm	1240	Standalone
MS2800S-EB-030-1280	Basic	30 mm	1280	Standalone
<b>MS2800S-EB-030-1320</b>	<b>Basic</b>	<b>30 mm</b>	<b>1320</b>	<b>Standalone</b>
<b>MS2800S-EB-030-1360</b>	<b>Basic</b>	<b>30 mm</b>	<b>1360</b>	<b>Standalone</b>
MS2800S-EB-030-1400	Basic	30 mm	1400	Standalone
MS2800S-EB-030-1440	Basic	30 mm	1440	Standalone
<b>MS2800S-EB-030-1480</b>	<b>Basic</b>	<b>30 mm</b>	<b>1480</b>	<b>Standalone</b>
<b>MS2800S-EB-030-1520</b>	<b>Basic</b>	<b>30 mm</b>	<b>1520</b>	<b>Standalone</b>
MS2800S-EB-030-1560	Basic	30 mm	1560	Standalone
MS2800S-EB-030-1600	Basic	30 mm	1600	Standalone
<b>MS2800S-EB-030-1640</b>	<b>Basic</b>	<b>30 mm</b>	<b>1640</b>	<b>Standalone</b>
MS2800S-EB-030-1680	Basic	30 mm	1680	Standalone
MS2800S-EB-030-1720	Basic	30 mm	1720	Standalone
MS2800S-EB-030-1760	Basic	30 mm	1760	Standalone
<b>MS2800S-EB-030-1800</b>	<b>Basic</b>	<b>30 mm</b>	<b>1800</b>	<b>Standalone</b>
MS2800S-EB-030-1840	Basic	30 mm	1840	Standalone
MS2800S-EB-030-1880	Basic	30 mm	1880	Standalone
<b>MS2800S-EB-030-1920</b>	<b>Basic</b>	<b>30 mm</b>	<b>1920</b>	<b>Standalone</b>
<b>MS2800S-EB-030-1960</b>	<b>Basic</b>	<b>30 mm</b>	<b>1960</b>	<b>Standalone</b>
MS2800S-EB-030-2000	Basic	30 mm	2000	Standalone
MS2800S-EB-030-2040	Basic	30 mm	2040	Standalone
<b>MS2800S-EB-030-2080</b>	<b>Basic</b>	<b>30 mm</b>	<b>2080</b>	<b>Standalone</b>
<b>MS2800S-EB-030-2120</b>	<b>Basic</b>	<b>30 mm</b>	<b>2120</b>	<b>Standalone</b>

Advanced version, 30 mm resolution, Standalone unit without Flex connection

Type Name	Version	Resolution [mm]	Length [mm]	Operation
<b>MS2800S-EA-030-0280</b>	<b>Advanced</b>	<b>30 mm</b>	<b>280</b>	<b>Standalone</b>
<b>MS2800S-EA-030-0320</b>	<b>Advanced</b>	<b>30 mm</b>	<b>320</b>	<b>Standalone</b>
<b>MS2800S-EA-030-0360</b>	<b>Advanced</b>	<b>30 mm</b>	<b>360</b>	<b>Standalone</b>
MS2800S-EA-030-0400	Advanced	30 mm	400	Standalone
<b>MS2800S-EA-030-0440</b>	<b>Advanced</b>	<b>30 mm</b>	<b>440</b>	<b>Standalone</b>
MS2800S-EA-030-0480	Advanced	30 mm	480	Standalone
<b>MS2800S-EA-030-0520</b>	<b>Advanced</b>	<b>30 mm</b>	<b>520</b>	<b>Standalone</b>
MS2800S-EA-030-0560	Advanced	30 mm	560	Standalone
<b>MS2800S-EA-030-0600</b>	<b>Advanced</b>	<b>30 mm</b>	<b>600</b>	<b>Standalone</b>
MS2800S-EA-030-0640	Advanced	30 mm	640	Standalone
MS2800S-EA-030-0680	Advanced	30 mm	680	Standalone
<b>MS2800S-EA-030-0720</b>	<b>Advanced</b>	<b>30 mm</b>	<b>720</b>	<b>Standalone</b>
<b>MS2800S-EA-030-0760</b>	<b>Advanced</b>	<b>30 mm</b>	<b>760</b>	<b>Standalone</b>
MS2800S-EA-030-0800	Advanced	30 mm	800	Standalone
MS2800S-EA-030-0840	Advanced	30 mm	840	Standalone
<b>MS2800S-EA-030-0880</b>	<b>Advanced</b>	<b>30 mm</b>	<b>880</b>	<b>Standalone</b>
<b>MS2800S-EA-030-0920</b>	<b>Advanced</b>	<b>30 mm</b>	<b>920</b>	<b>Standalone</b>
MS2800S-EA-030-0960	Advanced	30 mm	960	Standalone
MS2800S-EA-030-1000	Advanced	30 mm	1000	Standalone
<b>MS2800S-EA-030-1040</b>	<b>Advanced</b>	<b>30 mm</b>	<b>1040</b>	<b>Standalone</b>
MS2800S-EA-030-1080	Advanced	30 mm	1080	Standalone
MS2800S-EA-030-1120	Advanced	30 mm	1120	Standalone
MS2800S-EA-030-1160	Advanced	30 mm	1160	Standalone
<b>MS2800S-EA-030-1200</b>	<b>Advanced</b>	<b>30 mm</b>	<b>1200</b>	<b>Standalone</b>
<b>MS2800S-EA-030-1240</b>	<b>Advanced</b>	<b>30 mm</b>	<b>1240</b>	<b>Standalone</b>
MS2800S-EA-030-1280	Advanced	30 mm	1280	Standalone
<b>MS2800S-EA-030-1320</b>	<b>Advanced</b>	<b>30 mm</b>	<b>1320</b>	<b>Standalone</b>
<b>MS2800S-EA-030-1360</b>	<b>Advanced</b>	<b>30 mm</b>	<b>1360</b>	<b>Standalone</b>
MS2800S-EA-030-1400	Advanced	30 mm	1400	Standalone
MS2800S-EA-030-1440	Advanced	30 mm	1440	Standalone
<b>MS2800S-EA-030-1480</b>	<b>Advanced</b>	<b>30 mm</b>	<b>1480</b>	<b>Standalone</b>
<b>MS2800S-EA-030-1520</b>	<b>Advanced</b>	<b>30 mm</b>	<b>1520</b>	<b>Standalone</b>
MS2800S-EA-030-1560	Advanced	30 mm	1560	Standalone
<b>MS2800S-EA-030-1600</b>	<b>Advanced</b>	<b>30 mm</b>	<b>1600</b>	<b>Standalone</b>
<b>MS2800S-EA-030-1640</b>	<b>Advanced</b>	<b>30 mm</b>	<b>1640</b>	<b>Standalone</b>
MS2800S-EA-030-1680	Advanced	30 mm	1680	Standalone
MS2800S-EA-030-1720	Advanced	30 mm	1720	Standalone
<b>MS2800S-EA-030-1760</b>	<b>Advanced</b>	<b>30 mm</b>	<b>1760</b>	<b>Standalone</b>
<b>MS2800S-EA-030-1800</b>	<b>Advanced</b>	<b>30 mm</b>	<b>1800</b>	<b>Standalone</b>
MS2800S-EA-030-1840	Advanced	30 mm	1840	Standalone
MS2800S-EA-030-1880	Advanced	30 mm	1880	Standalone
<b>MS2800S-EA-030-1920</b>	<b>Advanced</b>	<b>30 mm</b>	<b>1920</b>	<b>Standalone</b>
<b>MS2800S-EA-030-1960</b>	<b>Advanced</b>	<b>30 mm</b>	<b>1960</b>	<b>Standalone</b>
MS2800S-EA-030-2000	Advanced	30 mm	2000	Standalone
MS2800S-EA-030-2040	Advanced	30 mm	2040	Standalone
<b>MS2800S-EA-030-2080</b>	<b>Advanced</b>	<b>30 mm</b>	<b>2080</b>	<b>Standalone</b>
<b>MS2800S-EA-030-2120</b>	<b>Advanced</b>	<b>30 mm</b>	<b>2120</b>	<b>Standalone</b>

Basic version, 14 mm resolution, Cascadable, Master unit

Type Name	Version	Resolution [mm]	Length [mm]	Operation
<b>MS2800FS-EB-014-0280</b>	<b>Basic</b>	<b>14 mm</b>	<b>280</b>	<b>Master</b>
<b>MS2800FS-EB-014-0320</b>	<b>Basic</b>	<b>14 mm</b>	<b>320</b>	<b>Master</b>
MS2800FS-EB-014-0360	Basic	14 mm	360	Master
MS2800FS-EB-014-0400	Basic	14 mm	400	Master
<b>MS2800FS-EB-014-0440</b>	<b>Basic</b>	<b>14 mm</b>	<b>440</b>	<b>Master</b>
MS2800FS-EB-014-0480	Basic	14 mm	480	Master
MS2800FS-EB-014-0520	Basic	14 mm	520	Master
MS2800FS-EB-014-0560	Basic	14 mm	560	Master
<b>MS2800FS-EB-014-0600</b>	<b>Basic</b>	<b>14 mm</b>	<b>600</b>	<b>Master</b>
MS2800FS-EB-014-0640	Basic	14 mm	640	Master
MS2800FS-EB-014-0680	Basic	14 mm	680	Master
<b>MS2800FS-EB-014-0720</b>	<b>Basic</b>	<b>14 mm</b>	<b>720</b>	<b>Master</b>
<b>MS2800FS-EB-014-0760</b>	<b>Basic</b>	<b>14 mm</b>	<b>760</b>	<b>Master</b>
MS2800FS-EB-014-0800	Basic	14 mm	800	Master
MS2800FS-EB-014-0840	Basic	14 mm	840	Master
<b>MS2800FS-EB-014-0880</b>	<b>Basic</b>	<b>14 mm</b>	<b>880</b>	<b>Master</b>
<b>MS2800FS-EB-014-0920</b>	<b>Basic</b>	<b>14 mm</b>	<b>920</b>	<b>Master</b>
MS2800FS-EB-014-0960	Basic	14 mm	960	Master
MS2800FS-EB-014-1000	Basic	14 mm	1000	Master
<b>MS2800FS-EB-014-1040</b>	<b>Basic</b>	<b>14 mm</b>	<b>1040</b>	<b>Master</b>
MS2800FS-EB-014-1080	Basic	14 mm	1080	Master
MS2800FS-EB-014-1120	Basic	14 mm	1120	Master
MS2800FS-EB-014-1160	Basic	14 mm	1160	Master
<b>MS2800FS-EB-014-1200</b>	<b>Basic</b>	<b>14 mm</b>	<b>1200</b>	<b>Master</b>
MS2800FS-EB-014-1240	Basic	14 mm	1240	Master
MS2800FS-EB-014-1280	Basic	14 mm	1280	Master
<b>MS2800FS-EB-014-1320</b>	<b>Basic</b>	<b>14 mm</b>	<b>1320</b>	<b>Master</b>
<b>MS2800FS-EB-014-1360</b>	<b>Basic</b>	<b>14 mm</b>	<b>1360</b>	<b>Master</b>
MS2800FS-EB-014-1400	Basic	14 mm	1400	Master
MS2800FS-EB-014-1440	Basic	14 mm	1440	Master
<b>MS2800FS-EB-014-1480</b>	<b>Basic</b>	<b>14 mm</b>	<b>1480</b>	<b>Master</b>
<b>MS2800FS-EB-014-1520</b>	<b>Basic</b>	<b>14 mm</b>	<b>1520</b>	<b>Master</b>
MS2800FS-EB-014-1560	Basic	14 mm	1560	Master
MS2800FS-EB-014-1600	Basic	14 mm	1600	Master
<b>MS2800FS-EB-014-1640</b>	<b>Basic</b>	<b>14 mm</b>	<b>1640</b>	<b>Master</b>
MS2800FS-EB-014-1680	Basic	14 mm	1680	Master
MS2800FS-EB-014-1720	Basic	14 mm	1720	Master
MS2800FS-EB-014-1760	Basic	14 mm	1760	Master
<b>MS2800FS-EB-014-1800</b>	<b>Basic</b>	<b>14 mm</b>	<b>1800</b>	<b>Master</b>

Advanced version, 14 mm resolution, Cascadable, Master unit

Type Name	Version	Resolution [mm]	Length [mm]	Operation
<b>MS2800FS-EA-014-0280</b>	<b>Advanced</b>	<b>14 mm</b>	<b>280</b>	<b>Master</b>
<b>MS2800FS-EA-014-0320</b>	<b>Advanced</b>	<b>14 mm</b>	<b>320</b>	<b>Master</b>
<b>MS2800FS-EA-014-0360</b>	<b>Advanced</b>	<b>14 mm</b>	<b>360</b>	<b>Master</b>
MS2800FS-EA-014-0400	Advanced	14 mm	400	Master
<b>MS2800FS-EA-014-0440</b>	<b>Advanced</b>	<b>14 mm</b>	<b>440</b>	<b>Master</b>
MS2800FS-EA-014-0480	Advanced	14 mm	480	Master
<b>MS2800FS-EA-014-0520</b>	<b>Advanced</b>	<b>14 mm</b>	<b>520</b>	<b>Master</b>
MS2800FS-EA-014-0560	Advanced	14 mm	560	Master
<b>MS2800FS-EA-014-0600</b>	<b>Advanced</b>	<b>14 mm</b>	<b>600</b>	<b>Master</b>
MS2800FS-EA-014-0640	Advanced	14 mm	640	Master
MS2800FS-EA-014-0680	Advanced	14 mm	680	Master
<b>MS2800FS-EA-014-0720</b>	<b>Advanced</b>	<b>14 mm</b>	<b>720</b>	<b>Master</b>
<b>MS2800FS-EA-014-0760</b>	<b>Advanced</b>	<b>14 mm</b>	<b>760</b>	<b>Master</b>
<b>MS2800FS-EA-014-0800</b>	<b>Advanced</b>	<b>14 mm</b>	<b>800</b>	<b>Master</b>
MS2800FS-EA-014-0840	Advanced	14 mm	840	Master
<b>MS2800FS-EA-014-0880</b>	<b>Advanced</b>	<b>14 mm</b>	<b>880</b>	<b>Master</b>
<b>MS2800FS-EA-014-0920</b>	<b>Advanced</b>	<b>14 mm</b>	<b>920</b>	<b>Master</b>
<b>MS2800FS-EA-014-0960</b>	<b>Advanced</b>	<b>14 mm</b>	<b>960</b>	<b>Master</b>
MS2800FS-EA-014-1000	Advanced	14 mm	1000	Master
<b>MS2800FS-EA-014-1040</b>	<b>Advanced</b>	<b>14 mm</b>	<b>1040</b>	<b>Master</b>
MS2800FS-EA-014-1080	Advanced	14 mm	1080	Master
MS2800FS-EA-014-1120	Advanced	14 mm	1120	Master
<b>MS2800FS-EA-014-1160</b>	<b>Advanced</b>	<b>14 mm</b>	<b>1160</b>	<b>Master</b>
<b>MS2800FS-EA-014-1200</b>	<b>Advanced</b>	<b>14 mm</b>	<b>1200</b>	<b>Master</b>
<b>MS2800FS-EA-014-1240</b>	<b>Advanced</b>	<b>14 mm</b>	<b>1240</b>	<b>Master</b>
MS2800FS-EA-014-1280	Advanced	14 mm	1280	Master
<b>MS2800FS-EA-014-1320</b>	<b>Advanced</b>	<b>14 mm</b>	<b>1320</b>	<b>Master</b>
<b>MS2800FS-EA-014-1360</b>	<b>Advanced</b>	<b>14 mm</b>	<b>1360</b>	<b>Master</b>
<b>MS2800FS-EA-014-1400</b>	<b>Advanced</b>	<b>14 mm</b>	<b>1400</b>	<b>Master</b>
MS2800FS-EA-014-1440	Advanced	14 mm	1440	Master
<b>MS2800FS-EA-014-1480</b>	<b>Advanced</b>	<b>14 mm</b>	<b>1480</b>	<b>Master</b>
<b>MS2800FS-EA-014-1520</b>	<b>Advanced</b>	<b>14 mm</b>	<b>1520</b>	<b>Master</b>
<b>MS2800FS-EA-014-1560</b>	<b>Advanced</b>	<b>14 mm</b>	<b>1560</b>	<b>Master</b>
MS2800FS-EA-014-1600	Advanced	14 mm	1600	Master
<b>MS2800FS-EA-014-1640</b>	<b>Advanced</b>	<b>14 mm</b>	<b>1640</b>	<b>Master</b>
MS2800FS-EA-014-1680	Advanced	14 mm	1680	Master
<b>MS2800FS-EA-014-1720</b>	<b>Advanced</b>	<b>14 mm</b>	<b>1720</b>	<b>Master</b>
MS2800FS-EA-014-1760	Advanced	14 mm	1760	Master
<b>MS2800FS-EA-014-1800</b>	<b>Advanced</b>	<b>14 mm</b>	<b>1800</b>	<b>Master</b>

Slave operation model, 14 mm resolution, Cascadable, Slave unit

Type Name	Version	Resolution [mm]	Length [mm]	Operation
<b>MS2800F-E-014-0240</b>	n.a.	<b>14 mm</b>	<b>240</b>	<b>Slave</b>
<b>MS2800F-E-014-0280</b>	n.a.	<b>14 mm</b>	<b>280</b>	<b>Slave</b>
<b>MS2800F-E-014-0320</b>	n.a.	<b>14 mm</b>	<b>320</b>	<b>Slave</b>
<b>MS2800F-E-014-0360</b>	n.a.	<b>14 mm</b>	<b>360</b>	<b>Slave</b>
MS2800F-E-014-0400	n.a.	14 mm	400	Slave
<b>MS2800F-E-014-0440</b>	n.a.	<b>14 mm</b>	<b>440</b>	<b>Slave</b>
MS2800F-E-014-0480	n.a.	14 mm	480	Slave
<b>MS2800F-E-014-0520</b>	n.a.	<b>14 mm</b>	<b>520</b>	<b>Slave</b>
MS2800F-E-014-0560	n.a.	14 mm	560	Slave
<b>MS2800F-E-014-0600</b>	n.a.	<b>14 mm</b>	<b>600</b>	<b>Slave</b>
MS2800F-E-014-0640	n.a.	14 mm	640	Slave
MS2800F-E-014-0680	n.a.	14 mm	680	Slave
<b>MS2800F-E-014-0720</b>	n.a.	<b>14 mm</b>	<b>720</b>	<b>Slave</b>
<b>MS2800F-E-014-0760</b>	n.a.	<b>14 mm</b>	<b>760</b>	<b>Slave</b>
<b>MS2800F-E-014-0800</b>	n.a.	<b>14 mm</b>	<b>800</b>	<b>Slave</b>
MS2800F-E-014-0840	n.a.	14 mm	840	Slave
<b>MS2800F-E-014-0880</b>	n.a.	<b>14 mm</b>	<b>880</b>	<b>Slave</b>
<b>MS2800F-E-014-0920</b>	n.a.	<b>14 mm</b>	<b>920</b>	<b>Slave</b>
<b>MS2800F-E-014-0960</b>	n.a.	<b>14 mm</b>	<b>960</b>	<b>Slave</b>
MS2800F-E-014-1000	n.a.	14 mm	1000	Slave
<b>MS2800F-E-014-1040</b>	n.a.	<b>14 mm</b>	<b>1040</b>	<b>Slave</b>
MS2800F-E-014-1080	n.a.	14 mm	1080	Slave
MS2800F-E-014-1120	n.a.	14 mm	1120	Slave
<b>MS2800F-E-014-1160</b>	n.a.	<b>14 mm</b>	<b>1160</b>	<b>Slave</b>
<b>MS2800F-E-014-1200</b>	n.a.	<b>14 mm</b>	<b>1200</b>	<b>Slave</b>
<b>MS2800F-E-014-1240</b>	n.a.	<b>14 mm</b>	<b>1240</b>	<b>Slave</b>
<b>MS2800F-E-014-1280</b>	n.a.	<b>14 mm</b>	<b>1280</b>	<b>Slave</b>

Basic version, 30 mm resolution, Cascadable, Master unit

Type Name	Version	Resolution [mm]	Length [mm]	Operation
<b>MS2800FS-EB-030-0280</b>	<b>Basic</b>	<b>30 mm</b>	<b>280</b>	<b>Master</b>
<b>MS2800FS-EB-030-0320</b>	<b>Basic</b>	<b>30 mm</b>	<b>320</b>	<b>Master</b>
MS2800FS-EB-030-0360	Basic	30 mm	360	Master
MS2800FS-EB-030-0400	Basic	30 mm	400	Master
<b>MS2800FS-EB-030-0440</b>	<b>Basic</b>	<b>30 mm</b>	<b>440</b>	<b>Master</b>
MS2800FS-EB-030-0480	Basic	30 mm	480	Master
MS2800FS-EB-030-0520	Basic	30 mm	520	Master
MS2800FS-EB-030-0560	Basic	30 mm	560	Master
<b>MS2800FS-EB-030-0600</b>	<b>Basic</b>	<b>30 mm</b>	<b>600</b>	<b>Master</b>
MS2800FS-EB-030-0640	Basic	30 mm	640	Master
MS2800FS-EB-030-0680	Basic	30 mm	680	Master
<b>MS2800FS-EB-030-0720</b>	<b>Basic</b>	<b>30 mm</b>	<b>720</b>	<b>Master</b>
<b>MS2800FS-EB-030-0760</b>	<b>Basic</b>	<b>30 mm</b>	<b>760</b>	<b>Master</b>
MS2800FS-EB-030-0800	Basic	30 mm	800	Master
MS2800FS-EB-030-0840	Basic	30 mm	840	Master
<b>MS2800FS-EB-030-0880</b>	<b>Basic</b>	<b>30 mm</b>	<b>880</b>	<b>Master</b>
<b>MS2800FS-EB-030-0920</b>	<b>Basic</b>	<b>30 mm</b>	<b>920</b>	<b>Master</b>
MS2800FS-EB-030-0960	Basic	30 mm	960	Master
MS2800FS-EB-030-1000	Basic	30 mm	1000	Master
<b>MS2800FS-EB-030-1040</b>	<b>Basic</b>	<b>30 mm</b>	<b>1040</b>	<b>Master</b>
MS2800FS-EB-030-1080	Basic	30 mm	1080	Master
MS2800FS-EB-030-1120	Basic	30 mm	1120	Master
MS2800FS-EB-030-1160	Basic	30 mm	1160	Master
<b>MS2800FS-EB-030-1200</b>	<b>Basic</b>	<b>30 mm</b>	<b>1200</b>	<b>Master</b>
MS2800FS-EB-030-1240	Basic	30 mm	1240	Master
MS2800FS-EB-030-1280	Basic	30 mm	1280	Master
<b>MS2800FS-EB-030-1320</b>	<b>Basic</b>	<b>30 mm</b>	<b>1320</b>	<b>Master</b>
<b>MS2800FS-EB-030-1360</b>	<b>Basic</b>	<b>30 mm</b>	<b>1360</b>	<b>Master</b>
MS2800FS-EB-030-1400	Basic	30 mm	1400	Master
MS2800FS-EB-030-1440	Basic	30 mm	1440	Master
<b>MS2800FS-EB-030-1480</b>	<b>Basic</b>	<b>30 mm</b>	<b>1480</b>	<b>Master</b>
<b>MS2800FS-EB-030-1520</b>	<b>Basic</b>	<b>30 mm</b>	<b>1520</b>	<b>Master</b>
MS2800FS-EB-030-1560	Basic	30 mm	1560	Master
MS2800FS-EB-030-1600	Basic	30 mm	1600	Master
<b>MS2800FS-EB-030-1640</b>	<b>Basic</b>	<b>30 mm</b>	<b>1640</b>	<b>Master</b>
MS2800FS-EB-030-1680	Basic	30 mm	1680	Master
MS2800FS-EB-030-1720	Basic	30 mm	1720	Master
MS2800FS-EB-030-1760	Basic	30 mm	1760	Master
<b>MS2800FS-EB-030-1800</b>	<b>Basic</b>	<b>30 mm</b>	<b>1800</b>	<b>Master</b>
MS2800FS-EB-030-1840	Basic	30 mm	1840	Master
MS2800FS-EB-030-1880	Basic	30 mm	1880	Master
<b>MS2800FS-EB-030-1920</b>	<b>Basic</b>	<b>30 mm</b>	<b>1920</b>	<b>Master</b>
<b>MS2800FS-EB-030-1960</b>	<b>Basic</b>	<b>30 mm</b>	<b>1960</b>	<b>Master</b>
MS2800FS-EB-030-2000	Basic	30 mm	2000	Master
MS2800FS-EB-030-2040	Basic	30 mm	2040	Master
<b>MS2800FS-EB-030-2080</b>	<b>Basic</b>	<b>30 mm</b>	<b>2080</b>	<b>Master</b>
<b>MS2800FS-EB-030-2120</b>	<b>Basic</b>	<b>30 mm</b>	<b>2120</b>	<b>Master</b>

Advanced version, 30 mm resolution, Cascadable, Master unit

Type Name	Version	Resolution [mm]	Length [mm]	Operation
<b>MS2800FS-EA-030-0280</b>	<b>Advanced</b>	<b>30 mm</b>	<b>280</b>	<b>Master</b>
<b>MS2800FS-EA-030-0320</b>	<b>Advanced</b>	<b>30 mm</b>	<b>320</b>	<b>Master</b>
MS2800FS-EA-030-0360	Advanced	30 mm	360	Master
MS2800FS-EA-030-0400	Advanced	30 mm	400	Master
<b>MS2800FS-EA-030-0440</b>	<b>Advanced</b>	<b>30 mm</b>	<b>440</b>	<b>Master</b>
MS2800FS-EA-030-0480	Advanced	30 mm	480	Master
MS2800FS-EA-030-0520	Advanced	30 mm	520	Master
MS2800FS-EA-030-0560	Advanced	30 mm	560	Master
<b>MS2800FS-EA-030-0600</b>	<b>Advanced</b>	<b>30 mm</b>	<b>600</b>	<b>Master</b>
MS2800FS-EA-030-0640	Advanced	30 mm	640	Master
MS2800FS-EA-030-0680	Advanced	30 mm	680	Master
<b>MS2800FS-EA-030-0720</b>	<b>Advanced</b>	<b>30 mm</b>	<b>720</b>	<b>Master</b>
<b>MS2800FS-EA-030-0760</b>	<b>Advanced</b>	<b>30 mm</b>	<b>760</b>	<b>Master</b>
MS2800FS-EA-030-0800	Advanced	30 mm	800	Master
MS2800FS-EA-030-0840	Advanced	30 mm	840	Master
<b>MS2800FS-EA-030-0880</b>	<b>Advanced</b>	<b>30 mm</b>	<b>880</b>	<b>Master</b>
<b>MS2800FS-EA-030-0920</b>	<b>Advanced</b>	<b>30 mm</b>	<b>920</b>	<b>Master</b>
MS2800FS-EA-030-0960	Advanced	30 mm	960	Master
MS2800FS-EA-030-1000	Advanced	30 mm	1000	Master
<b>MS2800FS-EA-030-1040</b>	<b>Advanced</b>	<b>30 mm</b>	<b>1040</b>	<b>Master</b>
MS2800FS-EA-030-1080	Advanced	30 mm	1080	Master
MS2800FS-EA-030-1120	Advanced	30 mm	1120	Master
MS2800FS-EA-030-1160	Advanced	30 mm	1160	Master
<b>MS2800FS-EA-030-1200</b>	<b>Advanced</b>	<b>30 mm</b>	<b>1200</b>	<b>Master</b>
<b>MS2800FS-EA-030-1240</b>	<b>Advanced</b>	<b>30 mm</b>	<b>1240</b>	<b>Master</b>
MS2800FS-EA-030-1280	Advanced	30 mm	1280	Master
<b>MS2800FS-EA-030-1320</b>	<b>Advanced</b>	<b>30 mm</b>	<b>1320</b>	<b>Master</b>
<b>MS2800FS-EA-030-1360</b>	<b>Advanced</b>	<b>30 mm</b>	<b>1360</b>	<b>Master</b>
MS2800FS-EA-030-1400	Advanced	30 mm	1400	Master
MS2800FS-EA-030-1440	Advanced	30 mm	1440	Master
<b>MS2800FS-EA-030-1480</b>	<b>Advanced</b>	<b>30 mm</b>	<b>1480</b>	<b>Master</b>
<b>MS2800FS-EA-030-1520</b>	<b>Advanced</b>	<b>30 mm</b>	<b>1520</b>	<b>Master</b>
MS2800FS-EA-030-1560	Advanced	30 mm	1560	Master
<b>MS2800FS-EA-030-1600</b>	<b>Advanced</b>	<b>30 mm</b>	<b>1600</b>	<b>Master</b>
<b>MS2800FS-EA-030-1640</b>	<b>Advanced</b>	<b>30 mm</b>	<b>1640</b>	<b>Master</b>
MS2800FS-EA-030-1680	Advanced	30 mm	1680	Master
MS2800FS-EA-030-1720	Advanced	30 mm	1720	Master
<b>MS2800FS-EA-030-1760</b>	<b>Advanced</b>	<b>30 mm</b>	<b>1760</b>	<b>Master</b>
<b>MS2800FS-EA-030-1800</b>	<b>Advanced</b>	<b>30 mm</b>	<b>1800</b>	<b>Master</b>
MS2800FS-EA-030-1840	Advanced	30 mm	1840	Master
MS2800FS-EA-030-1880	Advanced	30 mm	1880	Master
<b>MS2800FS-EA-030-1920</b>	<b>Advanced</b>	<b>30 mm</b>	<b>1920</b>	<b>Master</b>
<b>MS2800FS-EA-030-1960</b>	<b>Advanced</b>	<b>30 mm</b>	<b>1960</b>	<b>Master</b>
MS2800FS-EA-030-2000	Advanced	30 mm	2000	Master
MS2800FS-EA-030-2040	Advanced	30 mm	2040	Master
<b>MS2800FS-EA-030-2080</b>	<b>Advanced</b>	<b>30 mm</b>	<b>2080</b>	<b>Master</b>
<b>MS2800FS-EA-030-2120</b>	<b>Advanced</b>	<b>30 mm</b>	<b>2120</b>	<b>Master</b>



Slave operation model, 30 mm resolution, Cascadable, Slave unit

Type Name	Version	Resolution [mm]	Length [mm]	Operation
<b>MS2800F-E-030-0280</b>	n.a.	<b>30 mm</b>	<b>280</b>	<b>Slave</b>
<b>MS2800F-E-030-0320</b>	n.a.	<b>30 mm</b>	<b>320</b>	<b>Slave</b>
MS2800F-E-030-0360	n.a.	30 mm	360	Slave
MS2800F-E-030-0400	n.a.	30 mm	400	Slave
<b>MS2800F-E-030-0440</b>	n.a.	<b>30 mm</b>	<b>440</b>	<b>Slave</b>
MS2800F-E-030-0480	n.a.	30 mm	480	Slave
MS2800F-E-030-0520	n.a.	30 mm	520	Slave
MS2800F-E-030-0560	n.a.	30 mm	560	Slave
<b>MS2800F-E-030-0600</b>	n.a.	<b>30 mm</b>	<b>600</b>	<b>Slave</b>
MS2800F-E-030-0640	n.a.	30 mm	640	Slave
MS2800F-E-030-0680	n.a.	30 mm	680	Slave
<b>MS2800F-E-030-0720</b>	n.a.	<b>30 mm</b>	<b>720</b>	<b>Slave</b>
<b>MS2800F-E-030-0760</b>	n.a.	<b>30 mm</b>	<b>760</b>	<b>Slave</b>
MS2800F-E-030-0800	n.a.	30 mm	800	Slave
MS2800F-E-030-0840	n.a.	30 mm	840	Slave
<b>MS2800F-E-030-0880</b>	n.a.	<b>30 mm</b>	<b>880</b>	<b>Slave</b>
<b>MS2800F-E-030-0920</b>	n.a.	<b>30 mm</b>	<b>920</b>	<b>Slave</b>
MS2800F-E-030-0960	n.a.	30 mm	960	Slave
MS2800F-E-030-1000	n.a.	30 mm	1000	Slave
<b>MS2800F-E-030-1040</b>	n.a.	<b>30 mm</b>	<b>1040</b>	<b>Slave</b>
MS2800F-E-030-1080	n.a.	30 mm	1080	Slave
MS2800F-E-030-1120	n.a.	30 mm	1120	Slave
MS2800F-E-030-1160	n.a.	30 mm	1160	Slave
<b>MS2800F-E-030-1200</b>	n.a.	<b>30 mm</b>	<b>1200</b>	<b>Slave</b>
<b>MS2800F-E-030-1240</b>	n.a.	<b>30 mm</b>	<b>1240</b>	<b>Slave</b>
MS2800F-E-030-1280	n.a.	30 mm	1280	Slave
<b>MS2800F-E-030-1320</b>	n.a.	<b>30 mm</b>	<b>1320</b>	<b>Slave</b>
<b>MS2800F-E-030-1360</b>	n.a.	<b>30 mm</b>	<b>1360</b>	<b>Slave</b>
MS2800F-E-030-1400	n.a.	30 mm	1400	Slave
MS2800F-E-030-1440	n.a.	30 mm	1440	Slave
<b>MS2800F-E-030-1480</b>	n.a.	<b>30 mm</b>	<b>1480</b>	<b>Slave</b>
<b>MS2800F-E-030-1520</b>	n.a.	<b>30 mm</b>	<b>1520</b>	<b>Slave</b>
MS2800F-E-030-1560	n.a.	30 mm	1560	Slave
<b>MS2800F-E-030-1600</b>	n.a.	<b>30 mm</b>	<b>1600</b>	<b>Slave</b>
<b>MS2800F-E-030-1640</b>	n.a.	<b>30 mm</b>	<b>1640</b>	<b>Slave</b>
MS2800F-E-030-1680	n.a.	30 mm	1680	Slave
MS2800F-E-030-1720	n.a.	30 mm	1720	Slave
<b>MS2800F-E-030-1760</b>	n.a.	<b>30 mm</b>	<b>1760</b>	<b>Slave</b>
<b>MS2800F-E-030-1800</b>	n.a.	<b>30 mm</b>	<b>1800</b>	<b>Slave</b>
MS2800F-E-030-1840	n.a.	30 mm	1840	Slave
MS2800F-E-030-1880	n.a.	30 mm	1880	Slave
<b>MS2800F-E-030-1920</b>	n.a.	<b>30 mm</b>	<b>1920</b>	<b>Slave</b>
<b>MS2800F-E-030-1960</b>	n.a.	<b>30 mm</b>	<b>1960</b>	<b>Slave</b>
MS2800F-E-030-2000	n.a.	30 mm	2000	Slave
MS2800F-E-030-2040	n.a.	30 mm	2040	Slave
<b>MS2800F-E-030-2080</b>	n.a.	<b>30 mm</b>	<b>2080</b>	<b>Slave</b>
<b>MS2800F-E-030-2120</b>	n.a.	<b>30 mm</b>	<b>2120</b>	<b>Slave</b>

## 15-9 Accessories

### 15-9-1 Muting controller RM-6

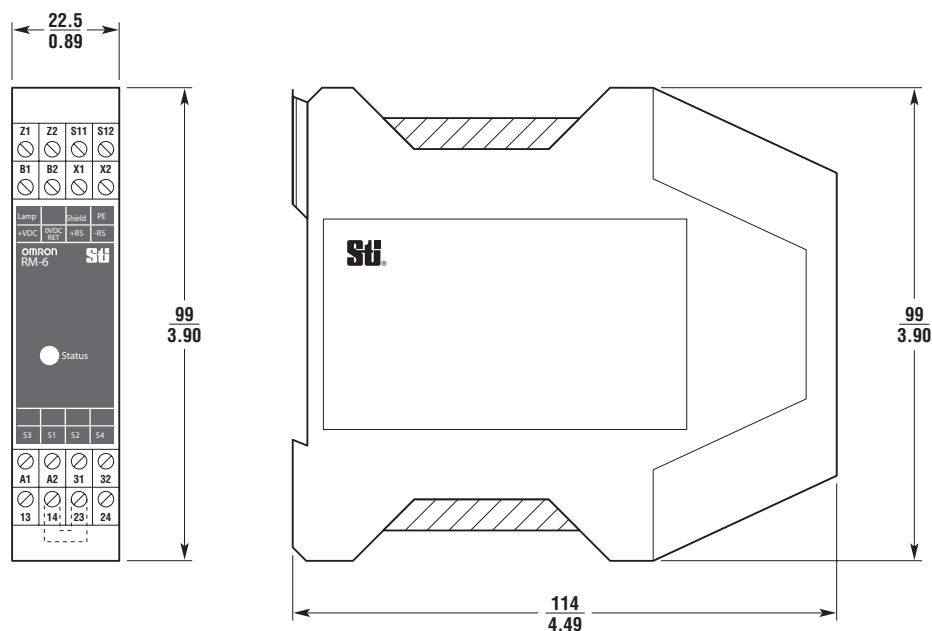

### 15-9-2 Safety Relay Units

Family	Type Name	Configuration
G9SB	G9SB-200-D	DPST-NO
	G9SB-301-D	3PST-NO
G9SA	G9SA-301	3PST-NO
	G9SA-501	5PST-NO
	G9SA-321-T075	3PST-NO, Time del. 7,5 s
	G9SA-321-T15	3PST-NO, Time del. 15 s
	G9SA-321-T30	3PST-NO, Time del. 30 s
G9SX	G9SX-BC202-RT	2 Safe Outputs
	G9SX-BC202-RC	2 Safe Outputs
	G9SX-AD322-T15-RT	3 Safe Outputs, Time del. 15 s
	G9SX-AD322-T15-RC	3 Safe Outputs, Time del. 15 s
	G9SX-AD322-T150-RT	3 Safe Outputs, Time del. 150 s
	G9SX-AD322-T150-RC	3 Safe Outputs, Time del. 150 s
	G9SX-ADA222-T15-RT	2 Safe Outputs, Time del. 15 s
	G9SX-ADA222-T15-RC	2 Safe Outputs, Time del. 15 s
	G9SX-ADA222-T150-RT	2 Safe Outputs, Time del. 150 s
	G9SX-ADA222-T150-RC	2 Safe Outputs, Time del. 150 s
DeviceNetSafety	NE1A-SCPU01	16 In, 8 Out, Safety Master
	NE1A-SCPU02	40 In, 8 Out, Safety Master
Safety Controller	NE1A-SCPU01L	16 In, 8 Out
	NE1A-SCPU02L	40 In, 8 Out

**15-9-3 Standard Cables**

Receiver Cables	
F39-JMR-10M	Receiver Cable, 10 m length
F39-JMR-15M	Receiver Cable, 15 m length
F39-JMR-30M	Receiver Cable, 30 m length

Transmitter Cables	
F39-JMT-10M	Transmitter Cable, 10 m length
F39-JMT-15M	Transmitter Cable, 15 m length
F39-JMT-30M	Transmitter Cable, 30 m length

**15-9-4 Interconnect Cables**

Receiver Cables	
F39-JMCR-03M	Receiver Interconnect Cable, 0,3 m length
F39-JMCR-05M	Receiver Interconnect Cable, 0,5 m length
F39-JMCR-1M	Receiver Interconnect Cable, 1,0 m length
F39-JMCR-2M	Receiver Interconnect Cable, 2,0 m length
F39-JMCR-3M	Receiver Interconnect Cable, 3,0 m length
F39-JMCR-5M	Receiver Interconnect Cable, 5,0 m length
F39-JMCR-10M	Receiver Interconnect Cable, 10 m length

Transmitter Cables	
F39-JMCT-03M	Transmitter Interconnect Cable, 0,3 m length
F39-JMCT-05M	Transmitter Interconnect Cable, 0,5 m length
F39-JMCT-1M	Transmitter Interconnect Cable, 1,0 m length
F39-JMCT-2M	Transmitter Interconnect Cable, 2,0 m length
F39-JMCT-3M	Transmitter Interconnect Cable, 3,0 m length
F39-JMCT-5M	Transmitter Interconnect Cable, 5,0 m length
F39-JMCT-10M	Transmitter Interconnect Cable, 10 m length

**15-9-5 Explosion proof enclosure**

F39-EXPF-AX300	Explosion proof housing for MS2800-014-0320 MS2800-030-0320
F39-EXPF-AX600	Explosion proof housing for MS2800-030-0640
F39-EXPF-AX900	Explosion proof housing for MS2800-030-0960
F39-EXPF-AX1200	Explosion proof housing for MS2800-030-1240

System complies: EN50014 (1997) incl. A1-A2 (1997)  
 EN50018 (2000) incl. A1 (2002)  
 EN50281-1-1 (1998) incl. A1 (2002)  
 UL certificate with US and Canadian directives

**15-9-6 IP67-Enclosure for MS2800 (standalone)**

Please use the following coding to order the IP67-enclosures:

**F39-EM67-XXXX** where XXXX is the length of the protection field.

**15-9-7 IP67-Enclosure for MS2800FS (cascaded)**

Please use the following coding to order the IP67-enclosures:

**F39-EM67FS-XXXX** where XXXX is the length of the protection field.

**15-9-8 Welding protection shield (Sputter protection)**

Please use the following coding to order the welding protection shield (Lexan front window):

**F39-EMWS-XXXX** where XXXX is the length of the protection field.



## SECTION 16

### Glossary

Automatic Start	Upon completion of power-up, the ESPE will enter the MACHINE RUN state as soon as the detection zone is clear of opaque objects of the specified size.
Detection Zone	The IR light sensing area of the ESPE. When a specified test piece enters this area then the ESPE must detect its presence and set its safety outputs to the OFF-state.
Electro-Sensitive Protective Equipment (ESPE)	An assembly of devices and/or components working together for protective tripping or presence sensing purposes and comprising as a minimum: <ul style="list-style-type: none"> <li>• a sensing device</li> <li>• controlling/monitoring devices</li> <li>• output signal switching devices</li> </ul>
LOCKOUT condition	When the ESPE detects a fault, it transitions to this state. The OSSD will be held to the OFF-state and the ESPE will not attempt to leave this state without performing a comprehensive power up self-test. A power-up self test will be initiated by either cycling the ESPE power or by a Start signal transition.
MACHINE RUN	When the ESPE is in this state, the two OSSD are both active. In this state the Green MACHINE RUN LED is on, the red MACHINE STOP LED is off and the Yellow INTERLOCK LED is off.
MACHINE STOP	When the ESPE is in this state, the two OSSD are both inactive. In this state the Green MACHINE RUN LED is off, the Red MACHINE STOP LED is on.
OFF-STATE	The state in which the output circuit is interrupted and does not permit the flow of current.
ON-STATE	The state in which the output circuit is completed and permits the flow of current.
Output Signal Switching Device (OSSD)	The safety output of the ESPE that is used to enable and disable the guarded machine.
Response Time	The maximum amount of time required for the ESPE to set its OSSD outputs to the OFF-state once the detection zone is blocked by an opaque object of the specified size.
Start INTERLOCK	Upon completion of power-up, the ESPE must go to the "INTERLOCK" state. A Start signal transition must occur before going to MACHINE RUN for the first time. Once the first Start condition has been met, the ESPE will operate in the Automatic Start mode.
Start/Restart INTERLOCK	The ESPE will go into the INTERLOCK state upon completion of power-up and during zone violations which causes a transition to the MACHINE STOP state. A Start signal transition must occur before returning to MACHINE RUN following any transition to MACHINE STOP.



## SECTION 17

# Diagnostics and Troubleshooting

### 17-1 Transmitter Diagnostic information and troubleshooting

The transmitter has one Yellow LED to show the operational status.

If the yellow LED is off:

1. Verify the cable is connected.
2. Verify the power supply is within limits (+24 V  $\pm$ 20%)
3. If this does not solve the problem, please contact your local Omron distributor or the European Repair Center.

If the yellow LED is blinking:

1. Verify the power supply is within limits (+24 V  $\pm$ 20%)
2. If this does not solve the problem, please contact your local Omron distributor or the European Repair Center.

### 17-2 Receiver Diagnostic Information

The receiver first segment has a set of LEDs to indicate diagnostic codes. The LEDs will only indicate fault codes, when in the Fault state. In this state the yellow INTERLOCK LED will be flashing and a row of 10 LEDs will display the fault code.

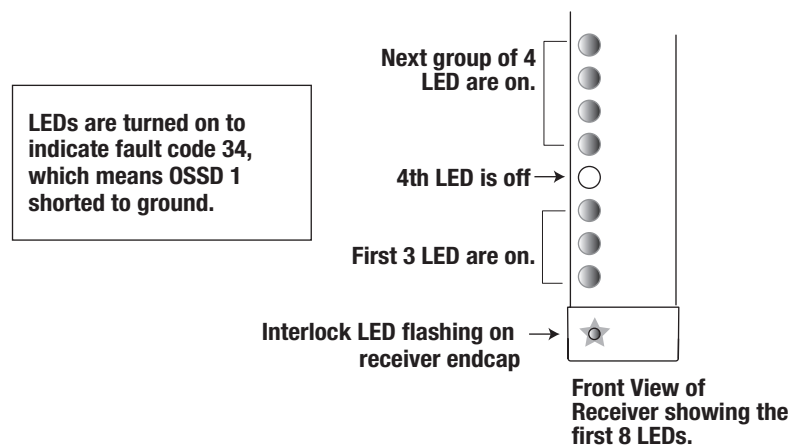

### 17-3 Receiver Endcap Indicator Lights

LED Color	Information shown
GREEN	The MS2800 is in the MACHINE RUN state.
RED	The MS2800 is in the MACHINE STOP state.
YELLOW INTERLOCK	The light curtain is waiting for the start button to be pushed. If the LED is blinking, the light curtain is in an alarm condition.
AMBER	The light curtain is operating in a Floating Blanking or Fixed Blanking mode.



## 17-4 Receiver Troubleshooting

If the yellow INTERLOCK LED is blinking:

1. Check the configuration for External Device Monitoring. If EDM is inactive (via receiver dip switch), the input (pink wire) must be connected to system ground. If EDM is active, the input must be connected to the normally closed contacts of the control relays of the guarded machine or the monitor terminal of the safety relay unit. Please refer to *SECTION 11 Connection to the Machine Control Circuit* for an example.
2. Make sure both selector switches in the receiver endcap have been set properly and identically. Please refer to chapter 7-2 *Operating mode selection* for further information.
3. Verify the power supply is within the specified limits (+24V  $\pm$ 20%).
4. Verify the light curtain is properly connected to the control relays of the guarded machine. If the light curtain is not intended to be connected to control relays, see *SECTION 12 Muting* for further information.
5. Verify the control relays are within operating limits of the safety outputs.
6. Verify the cable lengths from the light curtain to the control relays are within specified limits.
7. If this does not solve the problem, please contact your local Omron distributor or the European Repair Center.

## 17-5 Receiver Error Codes

Code Group	Error Code	Description of Error Code	Corrective Action Needed
Configuration Switch Faults	21	Invalid mode selection setting	Verify switch setting, see user manual
	22	Configuration switch settings changed during operation	Verify switch setting, see user manual
	23	Configuration switch settings do not match	Verify switch setting, see user manual
	24	Corrupted EEPROM configuration	Reset the system configuration to factory defaults
	26	Invalid scan code setting	Verify switch setting, see user manual
Safety Output (OSSD) Faults	31	Safety outputs 1&2 are shorted together	Check and correct wiring of safety outputs 1 and 2
	32	Safety output 1 is shorted to power	Check and correct wiring of safety outputs 1
	33	Safety output 2 is shorted to power	Check and correct wiring of safety outputs 2
	34	Safety output 1 is shorted to ground	Check and correct wiring of safety outputs 1
	35	Safety output 2 is shorted to ground	Check and correct wiring of safety outputs 2
EDM Faults	41	EDM circuit did not open before transition to MACHINE RUN state	Check and correct EDM wiring
	42	EDM circuit did not open after transition to MACHINE RUN state	Check and correct EDM wiring
	43	EDM circuit was in wrong state during power-up	Check and correct EDM wiring
	44	EDM fault at power-up	Check start input wire or EDM function selection
Controller Fault	50	Control logic fault	Please contact your local Omron distributor or the European Repair Center
Setup Error	60	Possible crosstalk	Check and correct scan code setting
Muting Faults	70	General muting fault	Check wiring of unused mute sensors
	71	Mute module enable and configuration required:	Check mounting of mute sensors for correct sequence
	74	Mute lamp burned out or not connected	Check status of mute lamp

Code Group	Error Code	Description of Error Code	Corrective Action Needed
Cascaded System Fault	80	Configuration Error	Please contact your local Omron distributor or the European Repair Center
	81	Second segment or mute module error	Check all cable connections. Please contact your local Omron distributor or the European Repair Center
	82	Third segment or mute module error	Check all cable connections. Please contact your local Omron distributor or the European Repair Center
	83	Fourth segment or mute module error	Check all cable connections. Please contact your local Omron distributor or the European Repair Center
	84	Mute module error	Check all cable connections to mute module. Please contact your local Omron distributor or the European Repair Center
	85	Configuration error	Please contact your local Omron distributor or the European Repair Center
	86	Second segment or mute module firmware not compatible with first segment	Replace with compatible component or return system to Omron distributor or European Repair Center
	87	Third segment or mute module firmware not compatible with first segment	Replace with compatible component or return system to Omron distributor or European Repair Center
	88	Fourth segment or mute module firmware not compatible with first segment	Replace with compatible component or return system to Omron distributor or European Repair Center
	89	Mute module firmware not compatible with first segment	Replace with compatible component or return system to Omron distributor or European Repair Center
	90	Incorrect segment type in position two, three or four	Confirm that all segments are of the same type; either all transmitters or receivers
	91	Segment 2 type does not match segment 1 type	Confirm that segment 2 is the same type (transmitter or receiver) as segment 1
	92	Segment 3 type does not match segment 1 type	Confirm that segment 3 is the same type (transmitter or receiver) as segment 1
	93	Segment 4 type does not match segment 1 type	Confirm that segment 4 is the same type (transmitter or receiver) as segment 1
	95	Error in flex segment or muting module during operation	Check all flex connections, segments and muting modules
	96	Error in segment 2 during operation	Check connections to segment 2. Replace segment 2 with known good segment 2. Please contact your local Omron distributor or the European Repair Center
	97	Error in segment 3 during operation	Check connections to segment 3. Replace segment 3 with known good segment 3. Please contact your local Omron distributor or the European Repair Center
	98	Error in segment 4 during operation	Check connections to segment 4. Replace segment 4 with known good segment 4. Please contact your local Omron distributor or the European Repair Center
100	Number of segments in system has been reduced (changed)	Segment count is less than original configuration. Add required segment(s) or program system for current configuration	
101	Too many flex nodes or muting modules in the flex bus	Make sure of total of 4 segments with only one muting module.	



# SECTION 18

## Appendix

### 18-1 Appendix A

#### Checkout procedure log

The following checkout procedure must be performed by qualified personnel during initial MS2800 system installation and at least every three months or more frequently depending on machine usage and company guidelines.

Machine identification \_\_\_\_\_ Date \_\_\_\_\_

Item	Condition	Comments
Verify that the guarded machine is compatible with the type of machine which may be used with the MS2800 system. See the chapter - "Precautions on Safety" for further information.	<input type="checkbox"/> Pass <input type="checkbox"/> Fail	
Verify that the mounting distance of the MS2800 system is equal to or greater than the minimum safe distance from the danger point. See the chapter "Safe mounting distance" for further information.	<input type="checkbox"/> Pass <input type="checkbox"/> Fail	
Determine that all access to the danger point not protected by the MS2800 system is guarded by other means, such as gates, fencing or other approved methods. Verify that all additional guarding devices are installed and operating properly.	<input type="checkbox"/> Pass <input type="checkbox"/> Fail	
Make sure the operator is not able to stand between the MS2800 system detection zone and the machine danger point. Verify that the light curtain can only be reset from a position outside and within view of the hazardous machine area.	<input type="checkbox"/> Pass <input type="checkbox"/> Fail	
Inspect the electrical connections between the guarded machine's control system and the MS2800 system. Verify that they are properly connected to the machine such that a stop signal from the MS2800 system results in an immediate halt of the machine's cycle. See the chapter "Connecting to the machine control circuit" for further information.	<input type="checkbox"/> Pass <input type="checkbox"/> Fail	
If the EDM monitoring feature is not used, proceed to the next step. To test the EDM feature, verify that the feature has been enabled. Turn the machine power on. Cycle the machine. Place a temporary jumper wire between the EDM connections. The MS2800 should enter an alarm condition. Remove the temporary jumper. Press and release the start button.	<input type="checkbox"/> Pass <input type="checkbox"/> Fail	
Record the test results in the machine log, then perform the test procedure.	<input type="checkbox"/> Pass <input type="checkbox"/> Fail	

Technician Signature \_\_\_\_\_

## 18-2 Appendix B

### Test procedure log

The following test procedure must be performed by qualified personnel during initial MS2800 system installation, according to the employer's regular inspection program and after any maintenance, adjustment or modification to the MS2800 system or the guarded machine. Testing ensures that the light curtain, safety system, and machine control system work together to properly stop the machine. Failure to test properly could result in serious injury to personnel. To test the MS2800 system, use the correct size test object.

Machine identification \_\_\_\_\_ Date \_\_\_\_\_

Item	Condition	Comments
Disable the guarded machine. Apply power to the MS2800 system.	<input type="checkbox"/> Pass <input type="checkbox"/> Fail	
Visually inspect the machine to ensure that access to the danger point is only through the MS2800 detection zone. If not, additional guarding, including mechanical barriers may be required. Verify that all additional guarding devices and barriers are installed and operating properly.	<input type="checkbox"/> Pass <input type="checkbox"/> Fail	
Verify that the mounting distance of the MS2800 system is equal to or greater than the calculated minimum safety distance from the danger point. See the chapter "Safe mounting distance" for further information. Ensure that the operator is not able to stand between the MS2800 detection zone and the danger point.	<input type="checkbox"/> Pass <input type="checkbox"/> Fail	
Check for signs of external damage to the MS2800 system, the machine and the electrical cables and wiring. If damage is found, lock the machine off and report to the supervisor.	<input type="checkbox"/> Pass <input type="checkbox"/> Fail	
Interrupt the MS2800 system detection zone with the proper size test object. Move the test object inside the perimeter (along the top, sides and bottom) of the detection zone and up and down through the center. At least one individual sector indicator must be lit while the test object is anywhere in the detection zone. If in automatic start mode, verify that the red MACHINE STOP light is lit. If in start/restart INTERLOCK mode, verify that the red MACHINE STOP and yellow INTERLOCK lights are on. Press and release start button before proceeding to next step.	<input type="checkbox"/> Pass <input type="checkbox"/> Fail	
Start the machine. While the machine is in motion, interrupt the detection zone with the test object. The machine should stop immediately. Never insert the test object into the dangerous parts of the machine. With the machine at rest, interrupt the detection zone with the test object. Verify that the machine will not start with the test object in the detection zone.	<input type="checkbox"/> Pass <input type="checkbox"/> Fail	
Verify that the braking system is working properly. If the machine does not stop fast enough, adjust the braking system or increase the distance from the detection zone to the danger point.	<input type="checkbox"/> Pass <input type="checkbox"/> Fail	
If the safety devices or the machine fails any of these tests, do not run the machine. Immediately tag or LOCKOUT the machine to prevent its use and notify the supervisor.	<input type="checkbox"/> Pass <input type="checkbox"/> Fail	

Technician Signature \_\_\_\_\_

## Revision History

A manual revision code appears as a suffix to the catalog number on the front cover of the manual.

Cat. No. F03E-EN-01

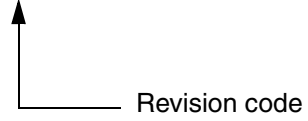

The following table outlines the changes made to the manual during each revision. Page numbers refer to the previous version.

Revision code	Date	Revised content
01	January 2008	Original production

