

NX1□

NX1 series machine controller

Compact in size, powerful in functionality

The NX1 completes the NX/NJ machine controllers family offering same functionality in a compact design. The NX1 provides synchronized control of all machine devices such as motion, I/O, safety and vision under one Integrated Development Environment.

- Fastest cycle time: 2 ms
- Functions: Logic sequence and Motion control
- Up to 8 axes (4 synchronized axes)
- Built-in I/O: 40 or 24 I/O points
- Up to 8 local NX I/O units
- Built-in EtherCAT and EtherNet/IP ports
- Up to 16 EtherCAT slaves
- Up to 2 option boards can be connected to add serial communications or analog I/O functionality



System configuration

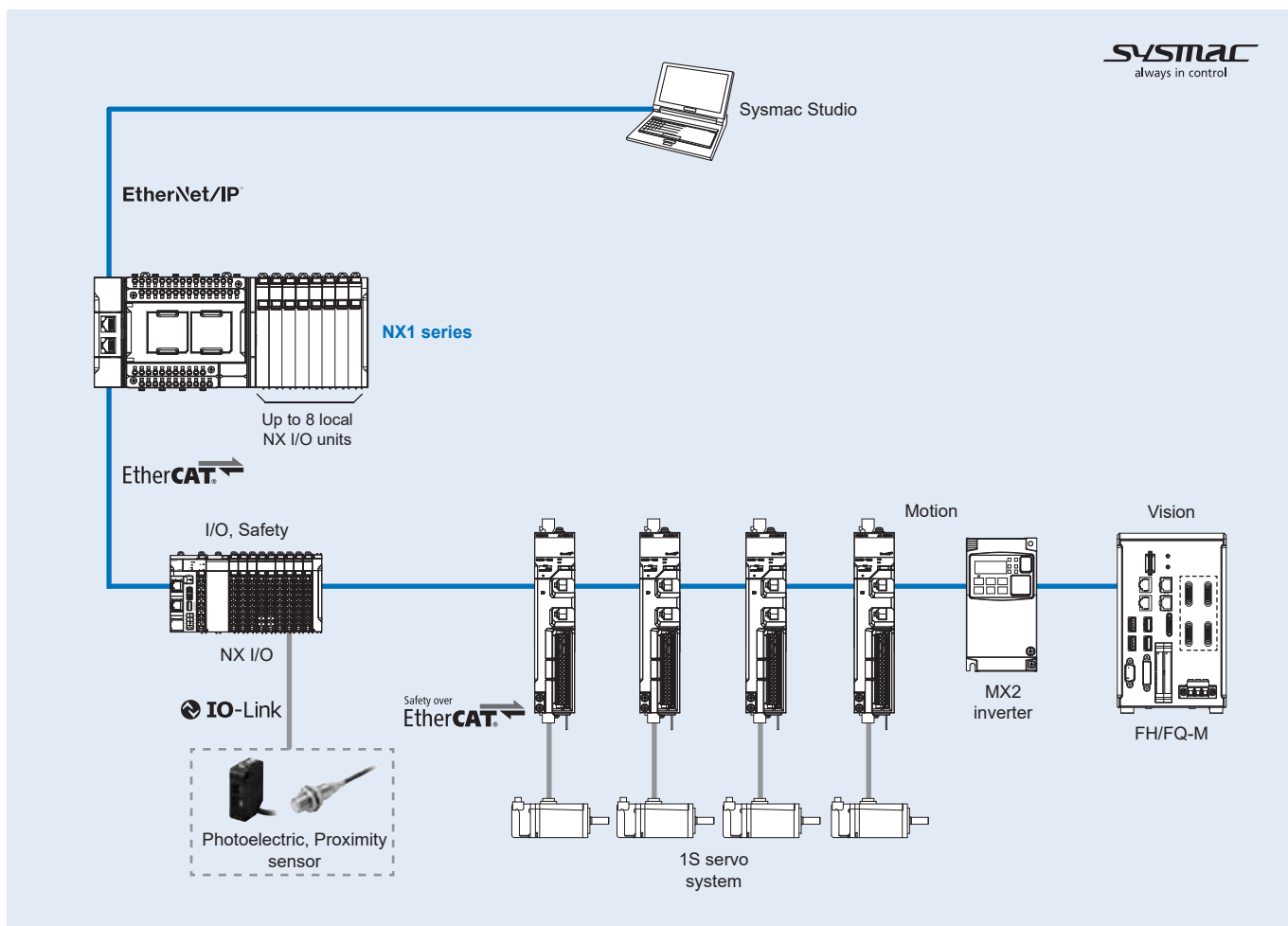

Specifications

General specifications

Item	NX1□ CPU Unit	
Enclosure	Mounted in a panel	
Grounding	Less than 100 Ω	
Operation environment	Ambient operating temperature	0 to 55°C
	Ambient operating humidity	10% to 95% (with non condensation)
	Atmosphere	Must be free from corrosive gases
	Ambient storage temperature	-25 to 70°C (excluding battery)
	Altitude	2,000 m or less
	Pollution degree	2 or less: Conforms to JIS B3502 and IEC 61131-2.
	Noise immunity	2 kV on power supply line (conforms to IEC 61000-4-4.)
	Overvoltage category	Category II: Conforms to JIS B3502 and IEC 61131-2
	EMC immunity level	Zone B
	Vibration resistance	Conforms to IEC 60068-2-6 5 to 8.4 Hz with 3.5 mm amplitude, 8.4 to 150 Hz. Acceleration of 9.8 m/s ² for 100 min in X, Y and Z directions (10 sweeps of 10 min each = 100 min total)
Shock resistance	Conforms to IEC 60068-2-27 147 m/s ² , 3 times in X, Y and Z directions	
Battery	Life	5 years at 25°C
	Model	CJ1W-BAT01 (sold separately)
Applicable standards	EU Directives	EN 61131-2
	cULus	Listed UL 61010-2-201 and ANSI/ISA 12.12.01
	Others	KC

Electrical and mechanical specifications

Item	NX1P2-1□40DT□	NX1P2-9024DT□
CPU unit dimensions (H × D × W)	100 mm × 71 mm × 154 mm	100 mm × 71 mm × 130 mm
Weight	660 g (including end cover)	590 g (including end cover)
CPU unit power supply	Power supply voltage	24 VDC (20.4 to 28.8 VDC)
	Unit power consumption	NX1P2-1□40DT: 7.05 W NX1P2-1□40DT1: 6.85 W
	Inrush current ^{*1}	For cold start at room temperature: 10 A max./0.1 ms max. and 2.5 A max./150 ms max.
	Current capacity of power supply terminal ^{*2}	4 A max.
	Isolation method	No isolation between the unit power supply terminal and internal circuit
NX unit power supply	Capacity	10 W max.
	Efficiency	80%
	Isolation method	No isolation between the unit power supply terminal and NX unit power supply
I/O power supply to NX units	Not provided ^{*3}	
External connection terminals	Communications connector	RJ45 for EtherNet/IP communications x 1 RJ45 for EtherCAT communications x 1
	Screwless push-in terminal block	For unit power supply input, grounding and input signal x 1 (removable) For output signal x 1 (removable)
	Output terminal (service supply)	Not provided
	Run output terminal	Not provided
	NX bus connector	8 NX I/O units can be connected
	No. of option board slots	2

*1. The inrush current may vary depending on the operating conditions and other conditions. Therefore, select fuses, breakers and external power supply devices that have enough margin in characteristic and capacity, considering the condition under which the devices are used.

*2. The amount of current that can be passed constantly through the terminal. Do not exceed this current value when you use a through-wiring for the unit power supply.

*3. When the type of the I/O power supply to NX units you use is the supply from NX bus, an additional I/O power supply unit is required. The maximum I/O power supply current from an additional I/O power supply unit is 4 A.

Performance specifications

Item		NX1P2-1140DT□	NX1P2-1040DT□	NX1P2-9024DT□	
Processing time	Instruction execution time	LD instruction	3.3 ns		
		Math instructions (for long real data)	70 ns or more		
Programming	Program capacity*1	Size	1.5 MB		
		POU definitions	450		
		POU instances	1,800		
	Memory capacity for variables*2	No retain attribute	Size: 2 MB Number of variables: 90,000		
		Retain attribute	Size: 32 KB Number of variables: 5,000		
	Data type	Number	1,000		
	Memory for CJ-Series units (can be specified with AT specifications for variables.)	CIO area	0 to 6,144 channel (0 to 6,143) ³		
		Work area	0 to 512 channel (W0 to W511) ³		
Holding area		0 to 1,536 channel (H0 to H1,535) ⁴			
DM area		0 to 16,000 channel (D0 to F15,999) ⁴			
EM area		-			
Unit configuration	Maximum number of connectable units	Maximum number of NX I/O units that can be mounted to the NX1 CPU unit	8 units		
		Maximum number of NX I/O units for entire controller	24 units (8 units on CPU rack + 16 units on EtherCAT slave terminals)		
	Power supply	Model	A non-isolated power supply for DC input is built into the CPU unit		
Motion control	Number of controlled axes	Number of controlled axes	12 axes (8 motion control axes + 4 single-axis position control axes)	10 axes (6 motion control axes + 4 single-axis position control axes)	4 axes (4 single-axis position control axes)
		Number of used real axes	8 axes (4 motion control servo axes + 4 single-axis position control servo axes)	6 axes (2 motion control servo axes + 4 single-axis position control servo axes)	4 axes (4 single-axis position control servo axes)
		Linear interpolation control	4 axes max. per axes group		
		Circular interpolation control	2 axes per axes group		
	Number of axes groups		8 groups max.		
	Position units		Pulses, millimeters, micrometers, nanometers, degrees or inches		
	Override factors		0.00% or 0.01% to 500.00%		
	Motion control period		Same as the period for primary periodic task		
	Cams	Number of cam data points	65,535 points max. per cam table / 262,140 points max. for all cam tables		-
		Number of cam tables	80 tables max.		-
	Communications	Built-in EtherNet/IP port	Number of ports	1	
			Physical layer	10BASE-T, 100BASE-TX	
			Frame length	1,514 bytes max.	
Media access method			CSMA/CD		
Modulation			Baseband		
Topology			Star		
Baud rate			100 Mbps (100BASE-TX)		
Transmission media			STP (shielded, twisted-pair) cable of Ethernet category 5, 5e or higher		
Transmission distance			100 m max. (distance between Ethernet switch and node)		
Cascade connections number			There are no restrictions if an switching hub is used		
CIP service: Tag data links (cyclic communications)			Number of connections	32	
			Packet Interval ⁵	2 to 10,000 ms in 1-ms increments Can be set for each connection.	
			Permissible communications band	3,000 pps ⁶ (including heartbeat)	
			Number of tag sets	32 max.	
		Tag types	Network variables, CIO/WR/HR/DM		
		Number of tags per connection (i.e., per tag set)	8 (7 tags if controller status is included in the tag set.)		
		Number of tags	256 max.		
		Link data size per node (total size for all tags)	19,200 bytes max.		
		Data size per connection	600 bytes max.		
		Number of registrable tag sets	32 max. (1 connection = 1 tag set)		
Tag set size		600 bytes max. (two bytes are used if controller status is included in the tag set.)			
Multi-cast packet filter ⁷		Supported.			
CIP message service: Explicit messages		Class 3 (number of connections)	32 (clients plus server)		
	UCMM (non-connection type)	Number of clients that can communicate at one time: 32 max. Number of servers that can communicate at one time: 32 max.			
Number of TCP socket service		30 max.			

Item		NX1P2-1140DT□	NX1P2-1040DT□	NX1P2-9024DT□
Communications	Built-in EtherCAT port	Communications standard	IEC 61158, Type 12	
		EtherCAT master specifications	Class B (feature pack motion control compliant)	
		Physical layer	100BASE-TX	
		Modulation	Baseband	
		Baud rate	100 Mbps (100BASE-TX)	
		Duplex mode	Automatic	
		Topology	Line, daisy chain and branching	
		Transmission media	Twisted-pair cable of category 5 or higher (double-shielded straight cable with aluminum tape and braiding)	
		Transmission distance	Distance between nodes: 100 m max.	
		Number of slaves	16 max.	
		Range of node addresses	1 to 192	
		Process data size	Inputs/Outputs: 1,434 bytes max. (However, the maximum number of process data frames is 1)	
		Process data size per slave	Inputs/Outputs: 1,434 bytes max.	
		Communications cycle	2,000 μs to 8,000 μs in 250-μs increments	
	Sync jitter	1 μs max.		
	Serial communications ⁸	Communications method	Half duplex	
Synchronization		Start-stop		
Baud rate		1.2/2.4/4.8/9.6/19.2/38.4/57.6/115.2 kbps		
Transmission distance		Depends on the option board		
	Supported protocol	Host link, Modbus-RTU master and no-protocol		
Option board	Number of slots	2		1
Built-in I/O	Input	Number of inputs	24	14
		Output	Number of outputs	16
		Load short-circuit protection	NPN models: Not provided PNP models: Provided	
Internal clock	Accuracy	At ambient temperature of 55°C: -3.5 to +0.5 min error per month At ambient temperature of 25°C: -1.5 to +1.5 min error per month At ambient temperature of 0°C: -3 to +1 min error per month		
	Retention time of built-in capacitor	At ambient temperature of 40°C: 10 days		

- *1. This is the capacity for the execution objects and variable tables (including variable names).
- *2. Memory used for CJ series units is included.
- *3. The value can be set in 1 ch increments. The value is included in the total size of variables without a retain attribute.
- *4. The value can be set in 1 ch increments. The value is included in the total size of variables with a retain attribute.
- *5. Data will be refreshed at the set interval, regardless of the number of nodes.
- *6. Means packets per second, i.e., the number of communication packets that can be sent or received in one second.
- *7. As the EtherNet/IP port implements the IGMP client, unnecessary multi-cast packets can be filtered by using an Ethernet switch that supports IGMP Snooping.
- *8. Supported only with the Serial communications option board.

Serial communications option board specifications

Item	NX1W-CIF01	NX1W-CIF11	NX1W-CIF12
Communications port	1 x RS-232C	1 x RS-422A/485	1 x RS-422A/485 (isolated)
Communications method	Half-duplex		
Synchronization method	Start-stop synchronization		
Baud rate	1.2/2.4/4.8/9.6/19.2/38.4/57.6/115.2 kbps		
Transmission distance	15 m	50 m	500 m
Supported protocol	Host link, Modbus-RTU master and no-protocol		
Terminal block type	Screwless push-in terminals 9 terminals	Screwless push-in terminals 5 terminals	
Applicable wire size	AWG28 to 20	AWG24 to 20	
Dimensions (H x D x W)	35.9 mm x 13.5 mm x 35.9 mm		
Weight	16 g	13 g	14 g
Power consumption	The option board power consumption is included in the CPU unit power consumption.		
Isolation method	No isolation		Isolation ^{*1}

*1. The terminals are isolated from the internal circuits of the CPU unit.

Analog I/O option board specifications

Item		NX1W-ADB21	NX1W-DAB21V	NX1W-MAB221
I/O	Type	Analog input	Analog output	Analog I/O
	Voltage/current input	0 to 10 V 0 to 20 mA 2 words total	-	0 to 10 V 0 to 20 mA 2 words total
	Voltage output	-	0 to 10 V 2 words	0 to 10 V 2 words
Terminal block type	Screwless push-in terminals 5 terminals	Screwless push-in terminals 3 terminals	Screwless push-in terminals 8 terminals	
Applicable wire size	AWG24 to 20			
Dimensions (H x D x W)	35.9 mm x 28.2 mm x 35.9 mm			
Weight	24 g			26 g
Power consumption	The option board power consumption is included in the CPU unit power consumption.			
Isolation method	No isolation			

Function specifications

Item			NX1□ CPU Unit	
Tasks	Function	Function	I/O refreshing and the user program are executed in units that are called tasks. Tasks are used to specify execution conditions and execution priority.	
		Periodically executed tasks	Maximum number of primary periodic tasks: 1 Maximum number of periodic tasks: 2	
		Conditionally executed tasks	Maximum number of even tasks: 32 When active even task instruction is executed or when condition expression for variable is met.	
	Setup	System service monitoring settings	Not supported	
Programming	POUs (program organization units)	Programs	POUs that are assigned to tasks.	
		Function blocks	POUs that are used to create objects with specific conditions.	
		Functions	POUs that are used to create an object that determine unique outputs for the inputs, such as for data processing.	
	Programming languages	Types	Ladder diagrams ¹ and structured text (ST).	
	Namespaces		A concept that is used to group identifiers for POU definitions.	
	Variables	External access of variables	Network variables (the function which allows access from the HMI, host computers or other controllers)	
	Data types	Basic data types		BOOL, BYTE, WORD, DWORD, LWORD, INT, SINT, DINT, LINT, UINT, USINT, UDINT, ULINT, REAL, LREAL, TIME (durations), DATE, TIME_OF_DAY, DATE_AND_TIME and STRING (text strings)
			Derivative data types	Structures, unions, enumerations
		Structures	Function	A derivative data type that groups together data with different variable types. Number of members: 2,048 max. Nesting levels: 8 max.
			Member data types	Basic data types, structures, unions, enumerations, array variables
			Specifying member offsets	You can use member offsets to place structure members at any memory locations.
		Unions	Function	A derivative data type that groups together data with different variable types. Number of members: 4 max.
			Member data types	BOOL, BYTE, WORD, DWORD and LWORD.
		Enumerations	Function	A derivative data type that uses text strings called enumerators to express variable values.
	Data type attributes	Array specifications	Function	An array is a group of elements with the same data type. You specify the number (subscript) of the element from the first element to specify the element. Number of dimensions: 3 max. Number of elements: 65,535 max.
			Array specifications for FB instances	Supported.
		Range specifications		You can specify a range for a data type in advance. The data type can take only values that are in the specified range.
		Libraries		User libraries.
		Control modes		Position control, velocity control, torque control
	Axis types		Servo axes, virtual servo axes, encoder axes and virtual encoder axes	
Positions that can be managed		Command positions and actual positions		
Single-axis	Single-axis position control	Absolute positioning	Positioning is performed for a target position that is specified with an absolute value.	
		Relative positioning	Positioning is performed for a specified travel distance from the command current position.	
		Interrupt feeding	Positioning is performed for a specified travel distance from the position where an interrupt input was received from an external input.	
		Cyclic synchronous absolute positioning	A positioning command is output each control period in the position control mode.	
	Single-axis velocity control	Velocity control	Velocity control is performed in position control mode.	
		Cyclic synchronous velocity control	A velocity command is output each control period in the velocity control mode.	
	Single-axis torque control	Torque control	The torque of the motor is controlled.	
	Single-axis synchronized control	Starting cam operation	A cam motion is performed using the specified cam table.	
		Ending cam operation	The cam motion for the axis that is specified with the input parameter is ended.	
		Starting gear operation	A gear motion with the specified gear ratio is performed between a master axis and slave axis.	
		Positioning gear operation	A gear motion with the specified gear ratio and sync position is performed between a master axis and slave axis.	
		Ending gear operation	The specified gear motion or positioning gear motion is ended.	
		Synchronous positioning	Positioning is performed in sync with a specified master axis.	
		Master axis phase shift	The phase of a master axis in synchronized control is shifted.	
	Combining axes	The command positions of two axes are added or subtracted and the result is output as the command position.		
	Single-axis manual operation	Powering the servo	The servo in the servo drive is turned ON to enable axis motion.	
		Jogging	An axis is jogged at a specified target velocity.	

Item			NX1□ CPU Unit			
Motion control ²	Single-axis	Auxiliary functions for single-axis control	Resetting axis errors	Axes errors are cleared.		
			Homing	A motor is operated and the limit signals, home proximity signal, and home signal are used to define home.		
			Homing with parameters	The parameters are specified, the motor is operated and the limit signals, home proximity signal and home signal are used to define home.		
			High-speed homing	Positioning is performed for an absolute target position of 0 to return to home.		
			Stopping	An axis is decelerated to a stop at the specified rate.		
			Immediately stopping	An axis is stopped immediately.		
			Override factors	The target velocity of an axis can be changed.		
			Changing the current position	The command current position or actual current position of an axis can be changed to any position.		
			Enabling external latches	The position of an axis is recorded when a trigger occurs.		
			Disabling external latches	The current latch is disabled.		
			Zone monitoring	You can monitor the command position or actual position of an axis to see when it is within a specified range (zone).		
			Enabling digital cam switches	You can turn a digital output ON and OFF according to the position of an axis.		
			Monitoring axis following error	You can monitor whether the difference between the command positions or actual positions of two specified axes exceeds a threshold value.		
			Resetting the following error	The error between the command current position and actual current position is set to 0.		
			Torque limit	The torque control function of the servo drive can be enabled or disabled and the torque limits can be set to control the output torque.		
			Position compensation	The function which compensate the position for the axis in operation.		
			Start velocity	You can set the initial velocity when axis motion starts.		
			Axes groups	Multi-axes coordinated control	Absolute linear interpolation	Linear interpolation is performed to a specified absolute position.
					Relative linear interpolation	Linear interpolation is performed to a specified relative position.
	Circular 2D interpolation	Circular interpolation is performed for two axes.				
	Axes group cyclic synchronous absolute positioning	A positioning command is output each control period in Position control mode.				
	Auxiliary functions for multi-axes coordinated control	Resetting axes group errors		Axes group errors and axis errors are cleared.		
		Enabling axes groups		Motion of an axes group is enabled.		
		Disabling axes groups		Motion of an axes group is disabled.		
		Stopping axes groups		All axes in interpolated motion are decelerated to a stop.		
		Immediately stopping axes groups		All axes in interpolated motion are stopped immediately.		
		Setting axes group override factors		The blended target velocity is changed during interpolated motion.		
		Reading axes group positions		The command current positions and actual current positions of an axes group can be read.		
		Changing the axes in a group		The composition axes parameter in the axes group parameters can be overwritten temporarily.		
	Common items	Cams	Setting cam table properties	The end point index of the cam table that is specified in the input parameter is changed.		
			Saving cam tables	The cam table that is specified with the input parameter is saved in non-volatile memory in the CPU unit.		
			Generating cam tables	The cam table that is specified with the input parameter is generated from the cam property and cam mode.		
		Parameters	Writing MC settings	Some of the axis parameters or axes group parameters are overwritten temporarily.		
			Changing axis parameters	You can access and change the axis parameters from the user program.		
	Auxiliary functions	Count modes	You can select either linear mode (finite length) or rotary mode (infinite length).			
		Unit conversions	You can set the display unit for each axis according to the machine.			
		Acceleration/deceleration control	Automatic acceleration/deceleration control	Jerk is set for the acceleration/deceleration curve for an axis motion or axes group motion.		
			Changing the acceleration and deceleration rates	You can change the acceleration or deceleration rate even during acceleration or deceleration.		
		In-position check	You can set an in-position range and in-position check time to confirm when positioning is completed.			
		Stop method	You can set the stop method to the immediate stop input signal or limit input signal.			

Item			NX1□ CPU Unit	
Motion control ²	Auxiliary functions	Re-execution of motion control instructions	You can change the input variables for a motion control instruction during execution and execute the instruction again to change the target values during operation.	
		Multi-execution of motion control instructions (buffer mode)	You can specify when to start execution and how to connect the velocities between operations when another motion control instruction is executed during operation.	
		Continuous axes group motions (transition mode)	You can specify the transition mode for multi-execution of instructions for axes group operation.	
		Monitoring functions	Software limits	Software limits are set for each axis.
			Following error	The error between the command current value and the actual current value is monitored for an axis.
			Velocity, acceleration/deceleration rate, torque, interpolation velocity and interpolation acceleration/deceleration rate	You can set and monitor warning values for each axis and each axes group.
		Absolute encoder support	You can use an OMRON 1S series servomotor or Accurax-G5 series servomotor with an absolute encoder to eliminate the need to perform homing at startup.	
Input signal logic inversion	You can invert the logic of immediate stop input signal, positive limit input signal, negative limit input signal or home proximity input signal.			
External interface signals		The servo drive input signals listed below are used: Home signal, home proximity signal, positive limit signal, negative limit signal, immediate stop signal and interrupt input signal.		
Unit (I/O) management	EtherCAT slaves	Number of slaves	16 max.	
	CJ-series units	Number of units	Not supported	
Communications	EtherNet/IP port	Communication protocol	TCP/IP, UDP/IP	
		CIP communications service	Tag data links	Programless cyclic data exchange is performed with the devices on the EtherNet/IP network.
			Message communications	CIP commands are sent to or received from the devices on the EtherNet/IP network.
		TCP/IP applications	Socket services	Data is sent to and received from any node on Ethernet using the UDP or TCP protocol. Socket communications instructions are used.
			FTP client	Files are transferred via FTP from the CPU unit to computers or controllers at other Ethernet nodes. FTP client communications instructions are used.
			FTP server	Files can be read from or written to the SD memory card in the CPU unit from computers at other Ethernet nodes.
		Automatic clock adjustment	Clock information is read from the NTP server at the specified time or at specified interval after the power supply to the CPU unit is turned ON. The internal clock time in the CPU unit is updated with the read time.	
	SNMP agent	Built-in EtherNet/IP port internal status information is provided to network management software that uses an SNMP manager.		
	EtherCAT port	Supported services	Process data communications	A communication method to exchange control information in cyclic communications between the EtherCAT master and slaves. This communications method is defined by CoE.
			SDO communications	A communication method to exchange control information in noncyclic event communications between the EtherCAT master and slaves. This communications method is defined by CoE.
		Network scanning	Information is read from connected slave devices and the slave configuration is automatically generated.	
		DC (distributed clock)	Time is synchronized by sharing the EtherCAT system time between all EtherCAT devices (including the master).	
		Packet monitoring	The frames that are sent by the master and the frames that are received by the master can be saved. The data that is saved can be viewed with WireShark or other applications.	
		Enable/disable settings for slaves	The slaves can be enabled or disabled as communications targets.	
		Disconnecting/connecting slaves	Temporarily disconnects a slave from the EtherCAT network for maintenance, such as for replacement of the slave and then connects the slave again.	
		Supported application protocol	CoE	SDO messages of the CAN application can be sent to slaves via EtherCAT.
	Serial communication	Protocol	Host link (FINS), no-protocol and Modbus-RTU master (when connected to the Serial communications option board)	
Communications instructions		The following instructions are supported: FTP client instructions, CIP communications instructions, socket communications instructions, SDO message instructions, no-protocol communications instructions and Modbus RTU protocol instructions.		
Operation management	RUN output contacts		Not supported.	
System management	Event logs	Function	Events are recorded in the logs.	
		Number of events per event log	System event log: 576 max. ³ Access event log: 528 max. ⁴ User-defined event log: 512 max.	
Debugging	Online editing		Programs, function blocks, functions and global variables can be changed online. More than one operator can change POU's individually via network.	
	Forced refreshing	Forced refreshing		The user can force specific variables to TRUE or FALSE.
		Number of forced variables	For EtherCAT slaves	64 max.
			For CJ-series	Not supported.
	MC test Run		Motor operation and wiring can be checked from the Sysmac Studio.	
	Synchronization		The project file in the Sysmac Studio and the data in the CPU unit can be made the same when online.	
Differentiation monitoring	Differentiation monitoring		You can monitor when a variable changes to TRUE or changes to FALSE.	
	Number of contacts		8 max.	

Item			NX1□ CPU Unit		
Debugging	Data tracing	Types	Single triggered trace	When the trigger condition is met, the specified number of samples are taken and then tracing stops automatically.	
			Continuous trace	Data tracing is executed continuously and the trace data is collected by the Sysmac Studio.	
		Number of simultaneous data trace		2 max.	
		Number of records		10,000 max.	
		Sampling	Number of sampled variables	48 variables max.	
		Timing of sampling		Sampling is performed for the specified task period, at the specified time or when a sampling instruction is executed.	
		Triggered traces	Triggered traces		Trigger conditions are set to record data before and after an event.
			Trigger conditions		When BOOL variable changes to TRUE or FALSE. Comparison of non-BOOL variable with a constant. Comparison method: Equals (=), greater than (>), greater than or equals (≥), less than (<), less than or equals (≤), not equal (≠).
			Delay		Trigger position setting: A slider is used to set the percentage of sampling before and after the trigger condition is met.
		Simulation			The operation of the CPU unit is emulated in the Sysmac Studio.
Reliability	Self-diagnosis	Controller errors	Levels	Major faults, partial faults, minor faults, observation and information.	
			Number of message languages	9 max. (Sysmac Studio) 2 max. (NS-series PT)	
		User-defined errors	Function	User-defined errors are registered in advance and then records are created by executing instructions.	
			Levels	8 levels	
			Number of message languages	9 max.	
Security	Protecting software assets and preventing operating mistakes	CPU unit names and serial IDs		When going online to a CPU unit from the Sysmac Studio, the CPU unit name in the project is compared to the name of the CPU unit being connected to.	
		Protection	User program transfer with no restoration information	You can prevent reading data in the CPU unit from the Sysmac Studio.	
			CPU unit write protection	You can prevent writing data to the CPU unit from the Sysmac Studio or SD memory card.	
			Overall project file protection	You can use passwords to protect .smc files from unauthorized opening on the Sysmac Studio.	
			Data protection	You can use passwords to protect POUs on the Sysmac Studio.	
		Verification of operation authority	Verification of operation authority	Online operations can be restricted by operation rights to prevent damage to equipment or injuries that may be caused by operating mistakes.	
			Number of groups	5	
		Verification of user program execution ID		The user program cannot be executed without entering a user program execution ID from the Sysmac Studio for the specific hardware (CPU unit).	
SD memory card	Storage type		SD memory card, SDHC memory card		
	Application	Automatic transfer from SD memory card	When the power supply to the controller is turned ON, the data that is stored in the autoload directory of the SD memory card is transferred to the controller.		
		Program transfer from SD memory card	With the specification of the system-defined variable, you can transfer a program that is stored in the SD memory card to the controller.		
		SD memory card operation instructions	You can access SD memory cards from instructions in the user program.		
		File operations from the Sysmac Studio	You can perform file operations for Controller files in the SD memory card and read/write standard document files on the computer.		
		SD memory card life expiration detection	Notification of the expiration of the life of the SD memory card is provided in a system-defined variable and event log.		
Backup	SD memory card backup	Operating methods	CPU unit front panel DIP switch	Backup, verification and restoration operations are performed by manipulating the front-panel DIP switch on the CPU unit.	
			Specification with system-defined variables	Backup and verification operations are performed by manipulating system-defined variables.	
			SD memory card Window in Sysmac Studio	Backup and verification operations are performed from the SD memory card Window of the Sysmac Studio.	
			Special instruction	The special instruction is used to backup data.	
		Protection	Disabling backups to SD memory cards	Backing up data to a SD memory card is prohibited.	
		Sysmac Studio controller backups		The Sysmac Studio is used to backup, restore and verify controller data.	

*1. Inline ST is supported (Inline ST is ST that is written as an element in a ladder diagram).
 *2. The NX1P2-9□ CPU unit doesn't support motion control.
 *3. This is the total of 512 events for the CPU unit and 64 events for the NX unit.
 *4. This is the total of 512 events for the CPU unit and 16 events for the NX unit.

Terminal block

Input terminal block

NX1P2-1□40DT□

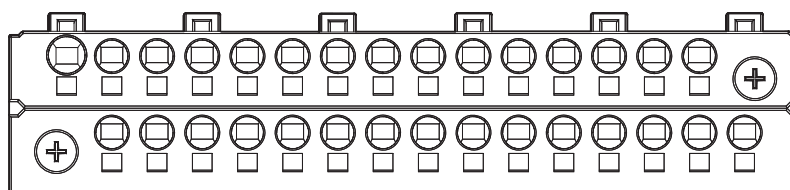

⏏	+	-	COM	01	03	05	07	09	11	13	15	17	19	21	
	+	-	00	02	04	06	08	10	12	14	16	18	20	22	23

Symbol	Name	Description
⏏	Functional ground terminal	Connect the ground wire to the terminal
+/-	Unit power supply terminals	These terminals are connected to the unit power supply The + and - terminals are internally connected to each other
COM	Common terminal	Common terminal for the input circuits
00 to 15	Input terminals	General-purpose input A
16 to 23		General-purpose input B

NX1P2-9024DT□

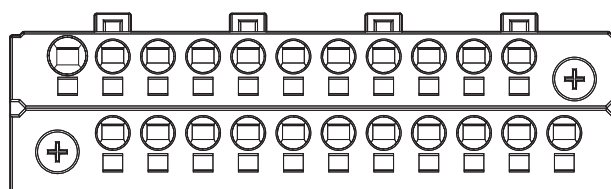

⏏	+	-	COM	01	03	05	07	09	11	13	
	+	-	00	02	04	06	08	10	12	NC	NC

Symbol	Name	Description
⏏	Functional ground terminal	Connect the ground wire to the terminal
+/-	Unit power supply terminals	These terminals are connected to the unit power supply The + and - terminals are internally connected to each other
COM	Common terminal	Common terminal for the input circuits
00 to 13	Input terminals	General-purpose input A
NC	NC	Do not connect anything

Input specifications

Item	General-purpose input A NX1P2-1□40DT□: 00 to 15 NX1P2-9024DT□: 00 to 13	General-purpose input B NX1P2-1□40DT□: 16 to 23
Internal I/O common	For both NPN/PNP	
Input voltage	24 VDC (15 to 28.8 VDC)	
Input current	5.8 mA typical	5.3 mA typical
Input impedance	4.0 kΩ	4.3 kΩ
Connected sensor	Two-wire or three-wire sensors	
ON voltage	15 VDC min.	
OFF voltage/current	5 VDC max./1 mA max.	
ON/OFF response time ^{*1}	2.5 μs max.	1 ms max.
ON/OFF filter time ^{*2}	No filter, 0.25 ms, 0.5 ms, 1 ms (default), 2 ms, 4 ms, 8 ms, 16 ms, 32 ms, 64 ms, 128 ms, 256 ms	
Circuit configuration		

*1. These values are the fixed response time needed by the hardware. A value from 0 to 32 ms (default: 1 ms) that is set on the Support Software is added to these values.

*2. Set the filter time for every 4 points.

Output terminal block

The appearance of the terminal block is the same for all the NX1 CPU models.

NX1P2-1□40DT

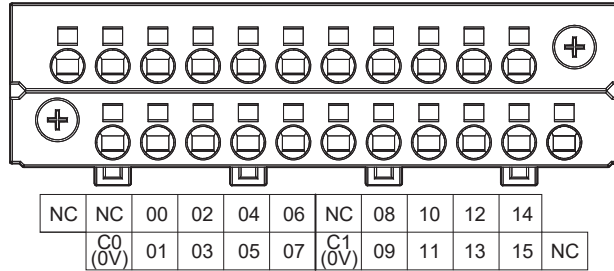

Symbol	Name	Description
C0 (0 V), C1 (0 V)	Common terminal	Connected to the 0 V side of the I/O power supply C0 (0 V) and C1 (0 V) are independent from each other inside the CPU unit
00 to 15	Output terminals	NPN (sinking) type output
NC	NC	Do not connect anything

NX1P2-1□40DT1

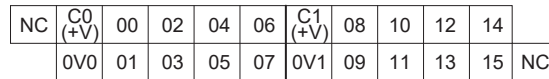

Symbol	Name	Description
C0 (+V), C1 (+V)	Common terminal	Connected to the 24 V side of the I/O power supply C0 (+V) and C1 (+V) are independent from each other inside the CPU unit
0V0, 0V1	0 V terminal	Supplies 0 V for the internal circuits for driving 0V0 and 0V1 are independent from each other inside the CPU unit
00 to 15	Output terminals	PNP (sourcing) type output with the load short-circuit protection function
NC	NC	Do not connect anything

NX1P2-9024DT

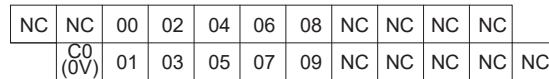

Symbol	Name	Description
C0 (0 V)	Common terminal	Connected to the 0 V side of the I/O power supply
00 to 09	Output terminals	NPN (sinking) type output
NC	NC	Do not connect anything

NX1P2-9024DT1

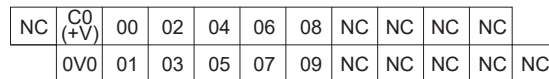

Symbol	Name	Description
C0 (+V)	Common terminal	Connected to the 24 V side of the I/O power supply
0V0	0 V terminal	Supplies 0 V for the internal circuits for driving
00 to 09	Output terminals	PNP (sourcing) type output with the load short-circuit protection function
NC	NC	Do not connect anything

Output specifications

Item	NX1P2-□□□□DT	NX1P2-□□□□DT1
Internal I/O common	NPN (sinking)	PNP (sourcing)
Maximum switching capacity	12 to 24 VDC (10.2 to 28.8 VDC), 300 mA per point NX1P2-1□40DT□: 1.8 A/common (3.6 A/unit) NX1P2-9024DT□: 2.4 A/common (2.4 A/unit)	24 VDC (15 to 28.8 VDC), 300 mA per point
Minimum switching capacity	12 to 24 VDC (10.2 to 28.8 VDC), 1 mA	24 VDC (15 to 28.8 VDC), 1 mA
Leakage current	0.1 mA max.	
Residual voltage	1.5 V max.	
ON response time	0.1 ms max.	0.5 ms max.
OFF response time	0.8 ms max.	1.0 ms max.
Current consumption from I/O power supply ^{*1}	-	NX1P2-1□40DT1: 40 mA/common NX1P2-9024DT1: 50 mA/common
Load short-circuit protection	Not provided	Provided ^{*2}
Circuit configuration	<p>NX1P2-1□40DT</p> <p>NX1P2-9024DT</p>	<p>NX1P2-1□40DT1</p> <p>NX1P2-9024DT1</p>

*1. The internally consumed current from I/O power supply. The current flows from the common terminal Cn (+V) to the 0Vn terminal. The current consumption of any external load is excluded.

*2. The load short-circuit protection is provided for each point of the PNP (sourcing) type output terminal. It protects the output circuits when a load short circuit occurs.

Nomenclature

NX1 CPU unit

NX1P2-1□40DT□

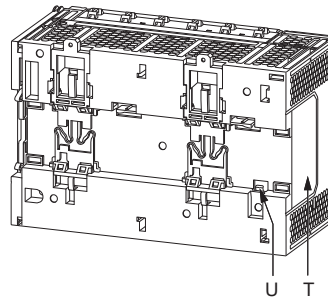
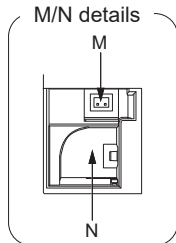
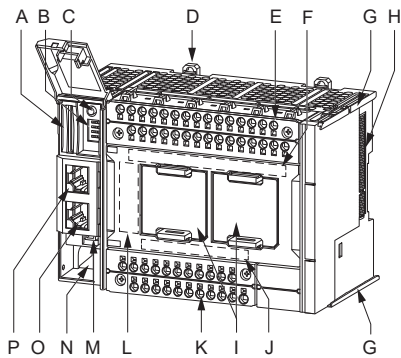

NX1P2-9024DT□

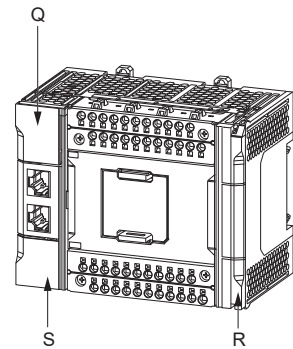

Symbol	Name	Description
A	SD memory card connector	Connects the SD memory card to the CPU unit.
B	DIP switch	Use in Safe Mode ^{*1} or when backing up data. Normally, turn OFF all the pins.
C	SD memory card power supply switch	Turns OFF the power supply so that you can remove the SD memory card.
D	DIN track mounting hook	These hooks are used to mount the unit to a DIN track.
E	Input terminal block	This terminal block is used for wiring for the unit power supply, grounding and built-in input.
F	Input indicator	Shows the operation status of the built-in input.
G	Unit hookup guides	These guides are used to mount an NX unit or End cover.
H	NX bus connector	This connector is used to connect the CPU unit to the NX unit on the right of the CPU unit.
I	Option board slot 1 (left) Option board slot 2 (right)	Remove the covers of the slots and mount option boards. For the models with 24 built-in I/O points, only one slot is provided. Keep the removed covers in a safe place.
J	Output indicator	Shows the operation status of the built-in output.
K	Output terminal block	This terminal block is used to wire the built-in output.
L	CPU unit operation status indicator	Shows the operation status of the CPU unit.
M	Battery connector	Connector to mount the backup battery that is sold separately.
N	Battery slot	Used to mount the backup battery that is sold separately.
O	Built-in EtherCAT port	Connects the built-in EtherCAT with an Ethernet cable.
P	Built-in EtherNet/IP port	Connects the built-in EtherNet/IP with an Ethernet cable.
Q	SD memory card cover	Cover for the SD memory card and DIP switch. The cover swings upward.
R	End cover	Cover to protect the CPU unit and NX I/O units.
S	Battery cover	Cover for battery slot. Remove this cover when you mount/remove the battery.
T	ID information indication	Shows the ID information of the CPU unit.
U	DIN track contact plate	This plate is connected internally to the functional ground terminal on the terminal block.

*1. To use Safe Mode, set the DIP switch as shown in the below picture and then turn ON the power supply to the controller. If the power supply to the controller is turned ON with the CPU unit in Safe Mode, the CPU unit will start in PROGRAM mode. Use the Safe Mode if you do not want to execute the user program when the power supply is turned ON or if it is difficult to connect the Sysmac Studio.

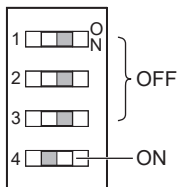

Dimensions

NX1 CPU unit (NX1P2-1□40DT□)

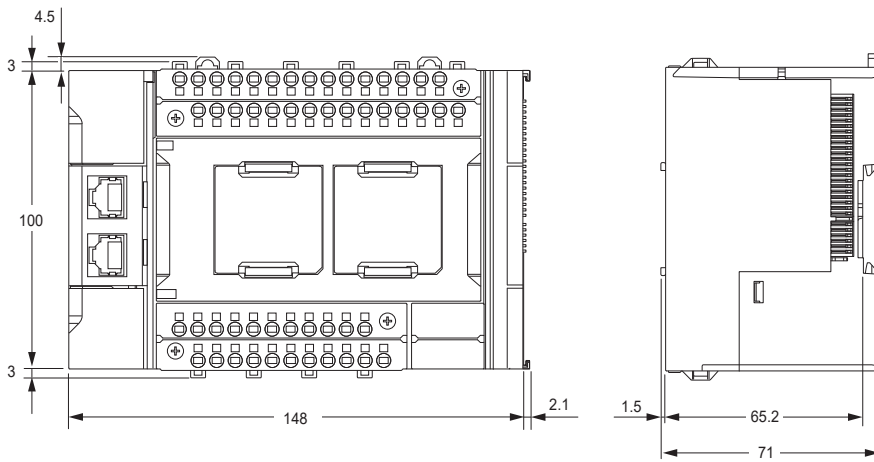

NX1 CPU unit (NX1P2-9024DT□)

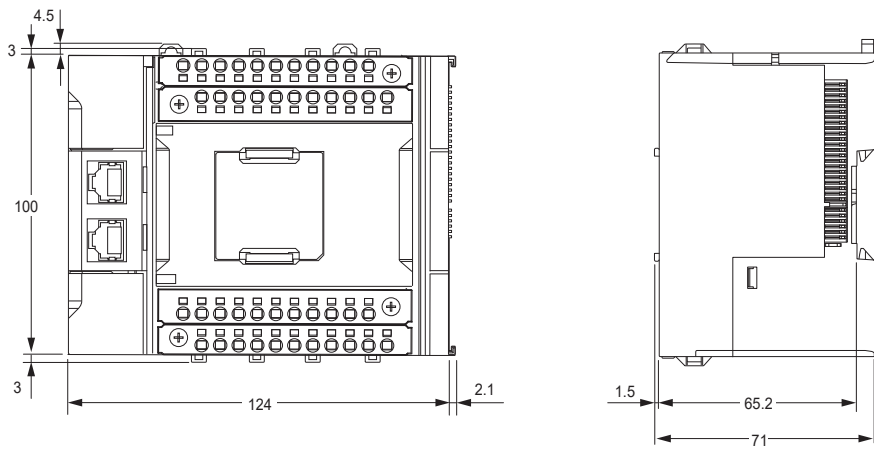

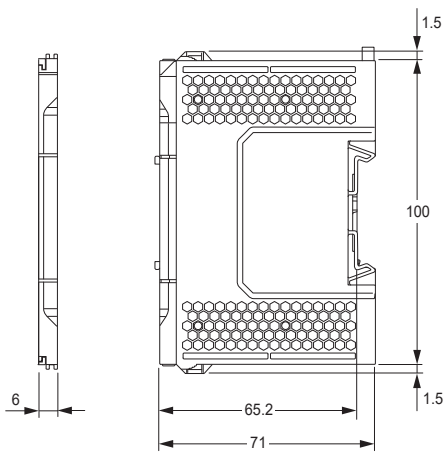

End cover (NX-END02)



Ordering information







NX1 series CPU units

Type	Program capacity	Memory capacity for variables	Number of axes			Built-in I/O points			Model	Appearance
			Real axes	Motion control servo axes	Single-axis position control servo axes	I/O points	Input points	Output points		
NX1	1.5 MB	32 KB (retained during power interruptions) or 2 MB (not retained during power interruptions)	8 axes	4 axes	4 axes	40 points	24 points	16 points NPN transistor	NX1P2-1140DT	
			6 axes	2 axes	16 points PNP transistor*1			NX1P2-1140DT1		
								16 points NPN transistor	NX1P2-1040DT	
								16 points PNP transistor*1	NX1P2-1040DT1	
			4 axes	0 axes	24 points	14 points	10 points NPN transistor	NX1P2-9024DT		
		10 points PNP transistor*1	NX1P2-9024DT1							

*1. With the load short-circuit protection.

Note: The end cover unit NX-END02 is included with the CPU unit.

Option boards

Type	Specifications	Supported protocol	Model	Appearance
Serial communications	1 x RS-232C port Transmission distance: 15 m Connection type: Screwless push-in terminal block (9 terminals)	Host link, Modbus-RTU master and no-protocol	NX1W-CIF01	
	1 x RS-422A/485 port Transmission distance: 50 m Connection type: Screwless push-in terminal block (5 terminals)		NX1W-CIF11	
	1 x RS-422A/485 port (isolated) Transmission distance: 500 m Connection type: Screwless push-in terminal block (5 terminals)		NX1W-CIF12	
Analog I/O	2 x Analog input Voltage input: 0 to 10 V (Resolution: 1/4,000) Current input: 0 to 20 mA (1/2,000) Connection type: Screwless push-in terminal block (5 terminals)		NX1W-ADB21	
	2 x Analog output Voltage output: 0 to 10 V (Resolution: 1/4,000) Connection type: Screwless push-in terminal block (3 terminals)		NX1W-DAB21V	
	2 x Analog input / 2 x Analog output Voltage input: 0 to 10 V (Resolution: 1/4,000) Current input: 0 to 20 mA (1/2,000) Voltage output: 0 to 10 V (Resolution: 1/4,000) Connection type: Screwless push-in terminal block (8 terminals)		NX1W-MAB221	

NX I/O units (local and remote I/O)

Up to 8 local NX I/O units can be connected to an NX1 CPU unit. The NX-Safety units must be used in combination with the EtherCAT communication coupler unit.

EtherCAT communication coupler

Type	Protocol	Communications cycle in DC mode*1	Specifications	Connection	I/O power supply	Width	Model
Communication coupler	EtherCAT slave	125 to 10,000 μs	Up to 63 I/O units Max. 1024 bytes in + 1024 bytes out Supports distributed clock	2 RJ45 ports (in + out)	10.0 A max.	46 mm	NX-ECC203

*1. This depends on the specifications of the EtherCAT master and the unit configuration.

IO-Link master

Type	No. of ports	I/O refresh method	Connection type*1	Width	Model
IO-Link master	4	Free run	Screwless push-in (NX-TBA162)	12 mm	NX-ILM400

*1. Units with Screwless push-in connections are supplied with the appropriate terminal connector.

Digital I/O

Type	Channels, signal type	Performance ¹ , I/O refresh method	Connection type ²	Width	Model	NPN type ³
DC digital input	4 inputs, 3-wire connection	High-speed synchronous time stamp	Screwless push-in (NX-TBA122)	12 mm	NX-ID3444	NX-ID3344
		High-speed synchronous/free run	Screwless push-in (NX-TBA122)	12 mm	NX-ID3443	NX-ID3343
		Synchronous/free run	Screwless push-in (NX-TBA122)	12 mm	NX-ID3417	NX-ID3317
	Screwless push-in (NX-TBA162)		12 mm	NX-ID4442	NX-ID4342	
	Screwless push-in (NX-TBA162)		12 mm	NX-ID5442	NX-ID5342	
	M3 screw terminal block		30 mm	NX-ID5142-1	NX-ID5142-1	
	8 inputs, 2-wire connection	Synchronous/free run	1 x 20-pin MIL connector	30 mm	NX-ID5142-5	NX-ID5142-5
			1 x 40-pin MIL connector	30 mm	NX-ID6142-5	NX-ID6142-5
			1 x 40-pin Fujitsu connector	30 mm	NX-ID6142-6	NX-ID6142-6
	16 inputs, 1-wire connection	Synchronous/free run	1 x 40-pin Fujitsu connector	30 mm	NX-ID6142-6	NX-ID6142-6
1 x 40-pin Fujitsu connector			30 mm	NX-ID6142-6	NX-ID6142-6	
32 inputs, 1-wire connection	Synchronous/free run	1 x 40-pin Fujitsu connector	30 mm	NX-ID6142-6	NX-ID6142-6	
		1 x 40-pin Fujitsu connector	30 mm	NX-ID6142-6	NX-ID6142-6	
AC digital input	4 inputs, 200-240 VAC, 50/60 Hz	Free run	Screwless push-in (NX-TBA082)	12 mm	NX-IA3117	-
DC digital output	2 outputs 0.5 A, 3-wire connection	High-speed synchronous time stamp	Screwless push-in (NX-TBA082)	12 mm	NX-OD2258	NX-OD2154
		High-speed synchronous/free run	Screwless push-in (NX-TBA122)	12 mm	NX-OD3257	NX-OD3153
	4 outputs 0.5 A, 3-wire connection	Synchronous/free run	Screwless push-in (NX-TBA122)	12 mm	NX-OD3256	NX-OD3121
			Screwless push-in (NX-TBA162)	12 mm	NX-OD3268	-
			Screwless push-in (NX-TBA162)	12 mm	NX-OD4256	NX-OD4121
	8 outputs 0.5 A, 2-wire connection	Synchronous/free run	Screwless push-in (NX-TBA162)	12 mm	NX-OD5256	NX-OD5121
			Screwless push-in (NX-TBA162)	12 mm	NX-OD5256	NX-OD5121
	16 outputs 0.5 A, 1-wire connection	Synchronous/free run	M3 screw terminal block	30 mm	NX-OD5256-1	NX-OD5121-1
			1 x 20-pin MIL connector	30 mm	NX-OD5256-5	NX-OD5121-5
			1 x 40-pin MIL connector	30 mm	NX-OD6256-5	NX-OD6121-5
32 outputs 0.5 A, 1-wire connection	Synchronous/free run	1 x 40-pin Fujitsu connector	30 mm	-	NX-OD6121-6	
		1 x 40-pin Fujitsu connector	30 mm	-	NX-OD6121-6	
Relay digital output	2 outputs, N.O., 2.0 A	Free run	Screwless push-in (NX-TBA082)	12 mm	NX-OC2633	-
	2 outputs, N.O. + N.C., 2.0 A		Screwless push-in (NX-TBA082)	12 mm	NX-OC2733	-
	8 outputs, N.O., 2.0 A		Screwless push-in (NX-TBA082 x 2)	24 mm	NX-OC4633	-
DC Digital I/O	16 inputs + 16 outputs, 1-wire connection + common	Synchronous/free run	2 x 20-pin MIL connector	30 mm	NX-MD6256-5	NX-MD6121-5
			2 x 24-pin Fujitsu connector	30 mm	-	NX-MD6121-6

¹. Digital I/O performance, ON/OFF delay:
High speed PNP/NPN input: 100 ns/100 ns
Standard PNP/NPN input: 0.02 ms/0.4 ms
AC input: 10 ms/40 ms
High speed PNP/NPN output: 300 ns/300 ns
Standard PNP output: 0.5 ms/1.0 ms
Standard NPN output: 0.1 ms/0.8 ms
Relay output: 15 ms/15 ms

². Units with Screwless push-in connections are supplied with the appropriate terminal connector. Units with MIL connectors are supplied without matching plugs.

³. Model codes are for PNP type signals (positive switching, 0 V common). Most models are also available as NPN type (negative switching, 24 V common). Inputs of MIL connector versions can be used as NPN or PNP.

Analog I/O

Type	Signal type	Performance, I/O refresh method	Channels	Connection type ¹	Width	Model		
Analog input	4 to 20 mA single ended	1/8,000 resolution, 250 μs/channel Free run	2	Screwless push-in (NX-TBA082)	12 mm	NX-AD2203		
			4	Screwless push-in (NX-TBA122)	12 mm	NX-AD3203		
			8	Screwless push-in (NX-TBA162)	12 mm	NX-AD4203		
	4 to 20 mA differential	1/8,000 resolution, 250 μs/channel Free run	1/8,000 resolution, 250 μs/channel Free run	2	Screwless push-in (NX-TBA082)	12 mm	NX-AD2204	
				4	Screwless push-in (NX-TBA122)	12 mm	NX-AD3204	
				8	Screwless push-in (NX-TBA162)	12 mm	NX-AD4204	
			1/30,000 resolution, 10 μs/channel Synchronous/free run	2	Screwless push-in (NX-TBA082)	12 mm	NX-AD2208	
				4	Screwless push-in (NX-TBA122)	12 mm	NX-AD3208	
				8	Screwless push-in (NX-TBA162)	12 mm	NX-AD4208	
	±10 V single ended	1/8,000 resolution, 250 μs/channel Free run	1/8,000 resolution, 250 μs/channel Free run	2	Screwless push-in (NX-TBA082)	12 mm	NX-AD2603	
				4	Screwless push-in (NX-TBA122)	12 mm	NX-AD3603	
				8	Screwless push-in (NX-TBA162)	12 mm	NX-AD4603	
	±10 V differential	1/8,000 resolution, 250 μs/channel Free run	1/8,000 resolution, 250 μs/channel Free run	2	Screwless push-in (NX-TBA082)	12 mm	NX-AD2604	
				4	Screwless push-in (NX-TBA122)	12 mm	NX-AD3604	
				8	Screwless push-in (NX-TBA162)	12 mm	NX-AD4604	
			1/30,000 resolution, 10 μs/channel Synchronous/free run	2	Screwless push-in (NX-TBA082)	12 mm	NX-AD2608	
4				Screwless push-in (NX-TBA122)	12 mm	NX-AD3608		
8				Screwless push-in (NX-TBA162)	12 mm	NX-AD4608		
Analog output	4 to 20 mA	1/8,000 resolution, 250 μs/channel Free run	1/8,000 resolution, 250 μs/channel Free run	2	Screwless push-in (NX-TBA082)	12 mm	NX-DA2203	
				4	Screwless push-in (NX-TBA122)	12 mm	NX-DA3203	
				8	Screwless push-in (NX-TBA162)	12 mm	NX-DA4203	
			1/30,000 resolution, 10 μs/channel Synchronous/free run	2	Screwless push-in (NX-TBA082)	12 mm	NX-DA2205	
				4	Screwless push-in (NX-TBA122)	12 mm	NX-DA3205	
				8	Screwless push-in (NX-TBA162)	12 mm	NX-DA4205	
	±10 V	1/8,000 resolution, 250 μs/channel Free run	1/8,000 resolution, 250 μs/channel Free run	2	Screwless push-in (NX-TBA082)	12 mm	NX-DA2603	
				4	Screwless push-in (NX-TBA122)	12 mm	NX-DA3603	
				1/30,000 resolution, 10 μs/channel Synchronous/free run	2	Screwless push-in (NX-TBA082)	12 mm	NX-DA2605
					4	Screwless push-in (NX-TBA122)	12 mm	NX-DA3605

¹. Units with Screwless push-in connections are supplied with the appropriate terminal connector.

Temperature input

Type	Signal type	Performance, I/O refresh method	Channels	Connection type ¹	Width	Model		
Temperature sensor input	Thermocouple type B/E/J/K/L/N/R/S/T/U/WRe5-26/PLII	0.1°C resolution, 200 ms/unit Free run	2	Screwless push-in terminal block(s), with cold junction sensor, calibrated individually at the factory	12 mm	NX-TS2101		
			4		24 mm	NX-TS3101		
		0.01°C resolution, 10 ms/unit Free run	2		12 mm	NX-TS2102		
			4		24 mm	NX-TS3102		
		0.001°C resolution, 60 ms/unit Free run	2		12 mm	NX-TS2104		
			4		24 mm	NX-TS3104		
		RTD type Pt100 (3wire)/Pt1000/Ni508.4	0.1°C resolution, 200 ms/unit Free run		2	Screwless push-in (NX-TBA162)	12 mm	NX-TS2201
					4	Screwless push-in (NX-TBA162 + NX-TBB162)	24 mm	NX-TS3201
	0.01°C resolution, 10 ms/unit Free run		2	Screwless push-in (NX-TBA162)	12 mm	NX-TS2202		
			4	Screwless push-in (NX-TBA162 + NX-TBB162)	24 mm	NX-TS3202		
	0.001°C resolution, 60 ms/unit Free run	2	Screwless push-in (NX-TBA162)	12 mm	NX-TS2204			
		4	Screwless push-in (NX-TBA162 + NX-TBB162)	24 mm	NX-TS3204			

¹: Units with Screwless push-in connections are supplied with the appropriate terminal connector.

Heater burnout detection

Type	Channels, signal type	Control output	I/O refresh method	Connection type ¹	Width	Model
Heater burnout detection	4 CT inputs 4 control outputs	NPN, 12 to 24 VDC 0.1 A/point, 0.4 A/unit	Free run	Screwless push-in (NX-TBA162)	12 mm	NX-HB3101
		PNP, 24 VDC 0.1 A/point, 0.4 A/unit		Screwless push-in (NX-TBA162)		NX-HB3201

¹: Units with Screwless push-in connections are supplied with the appropriate terminal connector.

Position interface

Type	Channels, signal type	I/O refresh method	Connection type ¹	Width	Model	NPN type ²
Encoder input	1 SSI encoder, 2 MHz	Synchronous/free run	Screwless push-in (NX-TBA122)	12 mm	NX-ECS112	-
	2 SSI encoders, 2 MHz		Screwless push-in (NX-TBA122)	12 mm	NX-ECS212	-
	1 incremental encoder line driver 4 MHz + 3 digital inputs (1 μs)		Screwless push-in (NX-TBA122 + NX-TBB122)	24 mm	NX-EC0142	NX-EC0132
	1 incremental encoder open collector 500 kHz + 3 digital inputs (1 μs)		Screwless push-in (NX-TBA162)	12 mm	NX-EC0122	NX-EC0112
	2 incremental encoders open collector 500 kHz		Screwless push-in (NX-TBA122)	12 mm	NX-EC0222	NX-EC0212
Pulse output	1 pulse open collector 500 kHz + 2 digital inputs + 1 digital output	Synchronous	Screwless push-in (NX-TBA162)	12 mm	NX-PG0122	NX-PG0112
	2 pulse line driver 4 MHz + 5 digital inputs per channel + 3 digital out- puts per channel		1 x 34-pin MIL connector	30 mm	NX-PG0242-5	NX-PG0232-5
	4 pulse line driver 4 MHz + 5 digital inputs per channel + 3 digital out- puts per channel		2 x 34-pin MIL connector	30 mm	NX-PG0342-5	NX-PG0332-5

¹: Units with Screwless push-in connections are supplied with the appropriate terminal connector. Units with MIL connectors are supplied without matching plugs.

²: Model codes are for PNP type signals (positive switching, 0 V common). Most models are also available as NPN type (negative switching, 24 V common). Inputs of MIL connector versions can be used as NPN or PNP.

Load cell input

Type	Specifications	I/O refresh method	Excitation voltage/Input range	Connection type ¹	Width	Model
Load cell input	1 load cell input, 125 μs conversion cycle	Synchronous/free run	5 VDC ±10%/-5 to 5 mV/V	Screwless push-in (NX-TBC162)	12 mm	NX-RS1201

¹: Units with Screwless push-in connections are supplied with the appropriate terminal connector.

Safety (the NX-Safety units must be used in combination with the EtherCAT communication coupler)

Type	Specifications	Performance, I/O refresh method	Connection type ¹	Width	Model
Safety controller	FSOE protocol	For up to 1,024 safety I/O points	128 safety connections	30 mm	NX-SL3500
		For up to 256 safety I/O points	32 safety connections	30 mm	NX-SL3300
Safety input	4 inputs + 2 test outputs	Free run	Screwless push-in (NX-TBA082)	12 mm	NX-SIH400
	8 inputs + 2 test outputs		Screwless push-in (NX-TBA162)	12 mm	NX-SID800
Safety output	2 outputs, 2.0 A		Screwless push-in (NX-TBA082)	12 mm	NX-SOH200
	4 outputs, 0.5 A		Screwless push-in (NX-TBA082)	12 mm	NX-SOD400

¹: Units with Screwless push-in connections are supplied with the appropriate terminal connector.

Communication interface

Type	Serial interface	No. of serial ports	Connection type ¹	Width	Model
Communication interface	RS-232C	1	Screwless push-in (NX-TBC162)	12 mm	NX-CIF101
		2	D-Sub 9pin connector	30 mm	NX-CIF210
	RS-422A/485	1	Screwless push-in (NX-TBC162)	12 mm	NX-CIF105

¹: Units with Screwless push-in connections are supplied with the appropriate terminal connector.

Power/System

Type	Description	Connection type ¹	Width	Model
NX bus power supply unit	24 VDC input, non-isolated	Screwless push-in (NX-TBC082)	12 mm	NX-PD1000
I/O power feed unit	For separation of groups, up to 4 A	Screwless push-in (NX-TBA082)	12 mm	NX-PF0630
I/O power supply connection unit	For separation of groups, up to 10 A	Screwless push-in (NX-TBA082)	12 mm	NX-PF0730
	16 × IOV	Screwless push-in (NX-TBA162)	12 mm	NX-PC0020
	16 × IOG	Screwless push-in (NX-TBA162)	12 mm	NX-PC0010
Shield connection unit	8 × IOV + 8 × IOG	Screwless push-in (NX-TBA162)	12 mm	NX-PC0030
	Grounding terminal, 16 points	Screwless push-in (NX-TBC162)	12 mm	NX-TBX01

¹: Units with Screwless push-in connections are supplied with the appropriate terminal connector.

Recommended EtherCAT and EtherNet/IP communication cables

Refer to “Recommended EtherCAT and EtherNet/IP communication cables” in the NJ-series machine controller datasheet Cat. No. I180E-EN (www.industrial.omron.eu/en/products/downloads) for the recommended cables.

Accessories

Specifications	Model	Appearance	
EtherCAT junction slaves	3 ports Power supply voltage: 20.4 to 28.8 VDC (24 VDC –15 to 20%) Current consumption: 0.08 A	GX-JC03	
	6 ports Power supply voltage: 20.4 to 28.8 VDC (24 VDC –15 to 20%) Current consumption: 0.17 A	GX-JC06	
Industrial switching hubs (for EtherNet/IP and Ethernet)	Quality of Service (QoS): EtherNet/IP control data priority. Failure detection: Broadcast storm and LSI error detection 10/100 BASE-TX, Auto-Negotiation Current consumption: 0.22 A	3 ports Power supply connector included	W4S1-03B
		5 ports Power supply connector included	W4S1-05B
		5 ports Power supply connector and connector for informing error included	W4S1-05C
SD memory card	2 GB	HMC-SD291	
	4 GB	HMC-SD491	
DIN track	Length: 0.5 m; height: 7.3 mm	PFP-50N	
	Length: 1 m; height: 7.3 mm	PFP-100N	
	Length: 1 m; height: 16 mm	PFP-100N2	
End plate to secure the units on the DIN rail		PFP-M (2 pcs)	
Battery for NX/NJ CPU unit		CJ1W-BAT01	
End cover	End cover for NX1 CPU unit (Provided with the CPU unit)	NX-END02	
	End cover for EtherCAT communication coupler unit (Provided with the EtherCAT communication coupler unit)	NX-END01	

Computer software

Specifications	Model
Sysmac Studio Lite Edition ¹ version 1.17 or higher	SYSMAC-LE□□□□ ²

¹: Same functionality and supported devices than Sysmac Studio Standard Edition except for controller. The Lite Edition only supports the NJ1 and NX1 machine controllers.

²: Refer to the Sysmac Studio datasheet (Cat. No. SysCat_I181E) for detailed information or contact your OMRON representative.

ALL DIMENSIONS SHOWN ARE IN MILLIMETERS.
To convert millimeters into inches, multiply by 0.03937. To convert grams into ounces, multiply by 0.03527.

Cat. No. SysCat_I179E-EN-01B In the interest of product improvement, specifications are subject to change without notice.