

Standard Flat Inductive Proximity Sensors

TL-W

- Front and side facing surface
- IP67
- DC 2-wire and DC 3-wire models



Ordering Information

DC 2-wire Models

Shape	Sensing distance			Model	
				Output and operating status	
				NO	NC
	5mm			TL-W5MD1^{*1}	TL-W5MD2^{*1}

*1. Models with different response frequency are available. These model numbers take the form TL-W5MD□5 (e.g., TL-W5MD15)

DC 3-wire Models

Shape	Sensing distance			Output specifications	Model			
					Output and operating status			
					PNP-NO	PNP-NC	NPN-NO	NPN-NC
	1.5mm			DC 3-wire	TL-W1R5MB1	---	TL-W1R5MC1^{*1}	---
	3mm				TL-W3MB1	TL-W3MB2	TL-W3MC1^{*1}	TL-W3MC2
	5mm				TL-W5MB1	TL-W5MB2	TL-W5MC1^{*1}	TL-W5MC2
	20mm				---	---	TL-W20ME1^{*1}	TL-W20ME2^{*1}
Shielded 	5mm			DC 3-wire	TL-W5F1	TL-W5F2	TL-W5E1	TL-W5E2

*1. Models with different response frequency are available. These model numbers take the form TL-W5MD□5 (e.g., TL-W5MD15)

Rating/Performance

DC 2-wire Models

Item	Model	TL-W5MD□
Sensing distance		5 mm ±10%
Setting distance		0 to 4 mm
Differential distance		10% max.
Sensing object		Ferrous metal(Sensitivity decreases with non-ferrous metals)
Standard sensing object		Iron, 18 x 18 x 1 mm
Response frequency		0.5 kHz
Rated supply voltage (operating voltage)		12 to 24 VDC (10 to 30 VDC), ripple (p-p): 10% max.
Leakage current		0.8 mA max.
Control output	Switching capacity	3 to 100 mA
	Residual voltage	3.3 V max. (under load current of 100 mA with cable length of 2 m)
Indicator lamp		D1 models: Operation indicator (Red LED), Operation set indicator (Green LED) D2 models: Operation indicator (Red LED)
Operating status (with sensing object approaching)		D1 models: NO D2 models: NC
Protective circuits		Surge absorber, short-circuit protection
Ambient temperature		Operating/Storage: -25°C to 70°C (with no icing or condensation)
Ambient humidity		Operating/Storage: 35% to 95%RH (with no condensation)
Temperature influence		±10% max. of sensing distance at 23°C within a temperature range of -25°C and 70°C
Voltage influence		±2.5% max. of Sensing distance within a rated voltage range ±15%.
Insulation resistance		50 M min. (at 500 VDC) between energized parts and case
Dielectric strength		1,000 VAC for 1 min between energized parts and case
Vibration resistance		10 to 55 Hz, 1.5 mm double amplitude for 2 hours each in X, Y, and Z directions
Shock resistance		Destruction: 500 m/s ² for 3 times each in X, Y, and Z directions
Protective structure		IEC60529 IP67
Connection method		Pre-wired models (standard length: 2 m)
Weight (Packed state)		Approx. 45 g
Material	Case	Heat-resistant ABS resin
	Sensing surface	
Accessories		Instruction manual

* The response frequencies for DC switching are average values measured under the condition that the distance between each sensing object is twice as large as the size of the sensing object and the sensing distance set is half of the maximum sensing distance.

DC 3-wire Models

Model		TL-W1R5M□1	TL-W3M□□	TL-W5M□□	TL-W5E□/F□	TL-W20ME□
Sensing distance		1.5 mm ±10%	3 mm ±10%	5 mm ±10%		20 mm ±10%
Setting distance		0 to 1.2 mm	0 to 2.4 mm	0 to 4 mm		0 to 16 mm
Differential distance		10% max.				1% to 15% of sensing distance
Sensing object		Ferrous metal (refer to Engineering Data for non-ferrous metal on page E-55)				
Standard sensing object		Iron, 8 x 8 x 1 mm	Iron, 12 x 12 x 1 mm	Iron, 18 x 18 x 1 mm		Iron, 50 x 50 x 1 mm
Response frequency		1 kHz min.	600 Hz min.	500 Hz min.	300 Hz min.	40 Hz min.
Power supply (Operating voltage range)		12 to 24 VDC (10 to 30 VDC) ripple (p-p): 10% max.			10 to 30 VDC with a ripple (p-p) of 20% max.	12 to 24 VDC (10 to 30 VDC) ripple (p-p): 10% max.
Current consumption		15 mA max. at 24 VDC (no-load)		10 mA max.	15mA max. at 24 VDC (no-load)	8 mA at 12 VDC, 15 mA at 24 VDC
Control output	Switching capacity	NPN open collector 100 mA max. (30 VDC max.)		NPN open collector 12 VDC 50 mA max. (30 VDC max.) 24 VDC 100 mA max. (30 VDC max.)	200 mA	12 VDC 100mA max., 24 VDC 200 mA max.
	Residual voltage	1 V max. (under load current of 100 mA with cable length of 2 m)		1 V max. (under load current of 50 mA with cable length of 2 m)	2 V max. (under load current of 200 mA with cable length of 2 m)	1 V max. (under load current of 200 mA with cable length of 2 m)
Indicator lamp		Detection indicator (red LED)				
Operating status (with sensing object approaching)		NO	C1 models: NO C2 type: NC		E1 models, F1 models: NO E2 models, F2 models: NC	
Protective circuits		Reverse connection protection, surge absorber				
Ambient temperature		Operating/Storage: -25°C to 70°C (with no icing or condensation)				
Ambient humidity		Operating/Storage: 35% to 95%RH (with no condensation)				
Temperature influence		±10% max. of sensing distance at 23°C within the temperature range of -25°C and 70°C				
Voltage influence		±2.5% max. of sensing distance within a range of ±10% of rated power supply voltage		±2.5% max. of sensing distance within a range of ±20% of rated power supply voltage	±2.5% max. of sensing distance within a range of ±10% of rated power supply voltage	
Insulation resistance		50 M min. (at 500 VDC) between energized parts and case				
Dielectric strength		1000 VAC 50/60 Hz for 1 min between energized part and case				
Vibration resistance		10 to 55 Hz, 1.5 mm double amplitude for 2 hours each in X, Y, and Z directions				
Shock resistance		Destruction: 500 m/s ² for 3 times each in X, Y, and Z directions				Destruction: 500 m/s ² for 10 times each in X, Y, and Z directions
Protective structure		IEC60529 IP67				
Connection method		Pre-wired models (standard length: 2 m)				
Weight (Packed state)		30 g	Approx. 45 g	Approx. 70 g		Approx. 180 g
Material	Case	Heat-resistant ABS resin			Diecast aluminum	Heat-resistant ABS resin
	Sensing surface	Heat-resistant ABS resin				
Accessories		Mounting bracket, instruction manual		Instruction manual		

Characteristic data (typical)

Sensing Distance vs. Sensing Object

TL-W1R5M□

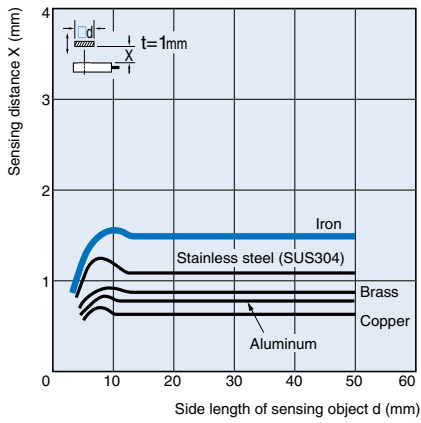

TL-W3M□

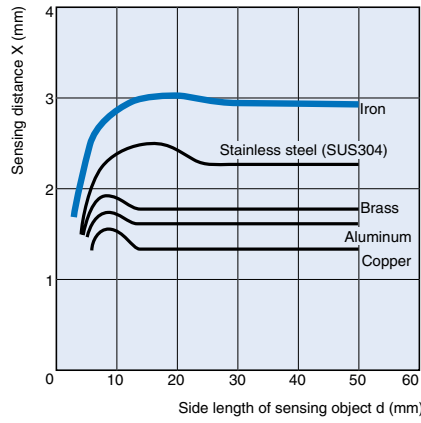

TL-W5MB□/C□

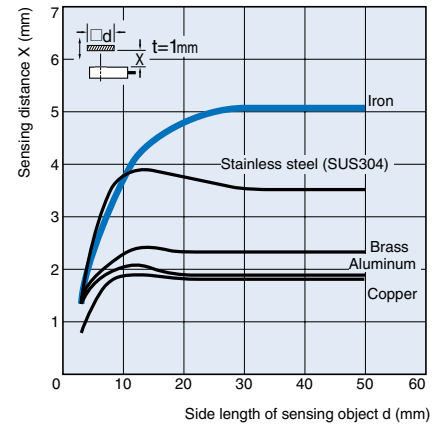

TL-W5E□/-W5F□/-W5MD□

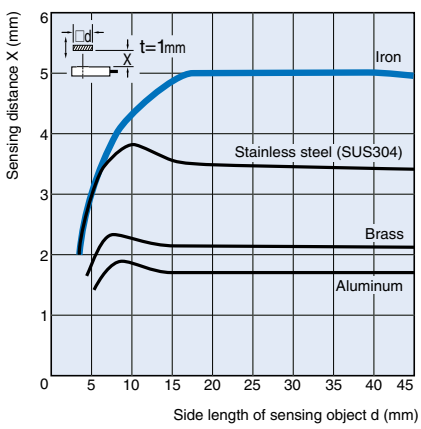

TL-W20□

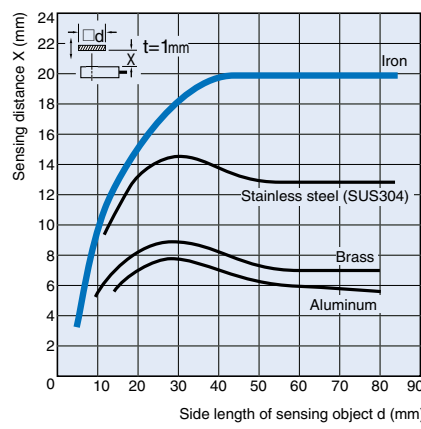

Output Circuit Diagram

DC 2-wire Models

Operating status	Model	Timing chart	Output circuit
NO	TL-W5MD1	<p>Setting position Non-sensing zone Unstable Sensing zone Stable sensing zone Proximity Sensor Sensing object (%) 100 80(TYP) 0 Rated sensing distance</p> <p>ON OFF Setting indicator (green) ON OFF Operation indicator (red) ON OFF Control output</p>	<p>Note: The Load can be connected to either the +V and 0-V side.</p>
NC	TL-W5MD2	<p>Non-sensing zone Sensing zone Proximity Sensor Sensing object (%) 100 0 Rated sensing distance</p> <p>ON OFF Operation indicator (red) ON OFF Control output</p>	

DC 3-wire Models

Operating status	Model	Timing chart	Output circuit
NO	TL-W1R5M□1 TL-W3M□1 TL-W5M□1	<p>Sensing object Yes No Output transistor (load) ON OFF Operation indicator (red) ON OFF</p>	<p>* Maximum load current: 100 mA</p>
NC	TL-W3M□2 TL-W5M□2	<p>Sensing object Yes No Output transistor (load) ON OFF Operation indicator (red) ON OFF</p>	
NO	TL-W1R5B1 TL-W3MB1 TL-W5MB1	<p>Sensing object Yes No Output transistor (load) ON OFF Operation indicator (red) ON OFF</p>	
NC	TL-W3MB2 TL-W5MB2	<p>Sensing object Yes No Output transistor (load) ON OFF Operation indicator (red) ON OFF</p>	
NO	TL-W5E1 TL-W20ME1	<p>Sensing object Yes No Load Operate Release (between brown and black) Output voltage H L (between blue and black) Operation indicator (red) ON OFF</p>	<p>* Maximum load current: 100 mA * 2. Current flows in this direction if the circuit incorporates the transistor.</p>
NC	TL-W5E2 TL-W20ME2	<p>Sensing object Yes No Load Operate Release (between brown and black) Output voltage H L (between blue and black) Operation indicator (red) ON OFF</p>	

TL-W

Operating status	Model	Timing chart	Output circuit
NO	TL-W5F1		<p>* 1. Maximum load current: 200 mA * 2. Current flows in this direction if the circuit incorporates the transistor.</p>
NC	TL-W5F2		

Precautions

Correct Use

Design

Effects of Surrounding Metal

Provide a minimum distance between the Sensor and the surrounding metal as shown in the table below.

Front Surface Sensing Type (Not exceeding the sensor head height).

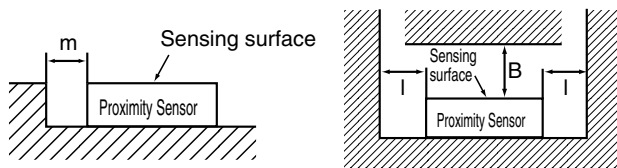

Effects of Surrounding Metal(Unit: mm)

Model	Length	l	m	n
TL-W1R5M□		2	0	8
TL-W3M□		3		12
TL-W5MD□		5		20
TL-W5M□				
TL-W20ME□		25	16	100
TL-W5E□/-W5F□		0	0	20

Mutual Interference

If two or more Sensors are mounted face to face or side by side, keep them separate at the following minimum distance.

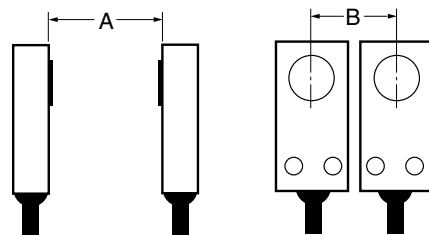

Mutual Interference (unit: mm)

Model	Length	A	B
TL-W1R5M□		75 (50)	120(60)
TL-W3MC□		90 (60)	200(100)
TL-W5MD□		120(80)	60(30)
TL-W5MC□			
TL-W20ME□		200(100)	200(100)
TL-W5E□/-W5F□		50	35

Note: The above values in parentheses are applicable when using two sensors with different frequencies.

Installation

- Use M3 flat-head screws to install TL-W1R5M□ and TL-W3M□.
- Ensure that the resin cover should be tightened with a torque according to the following table.

Model	Tensile strength (torque)
TL-W1R5MC1	0.98 Nm
TL-W3MC□	
TL-W5MD□	
TL-W20M□	1.5 Nm

● Adjustment

Power ON

Please note that the power injection AND connection generate an error pulse for approximately 1 ms.

Dimensions (Unit: mm)

TL-W1R5M□1

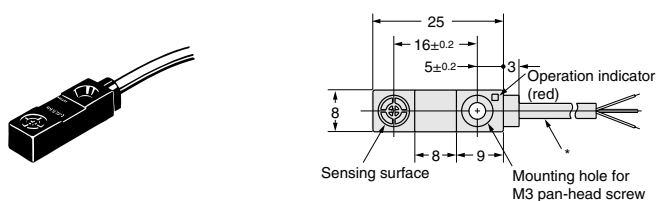

Mounting Bracket (Attachment)

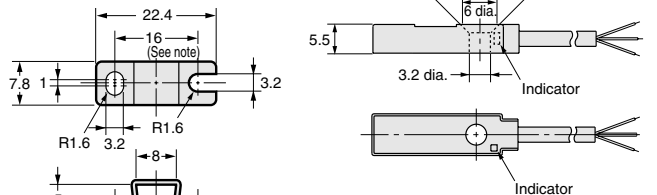

Note:
Mounting dimensions: 17±0.2

* Vinyl-insulated round cable with three conductors, 2.9 dia. (conductor cross-sectional area: 0.15 mm²; insulation diameter: 0.9 mm); standard length: 2 m

TL-W3M□□

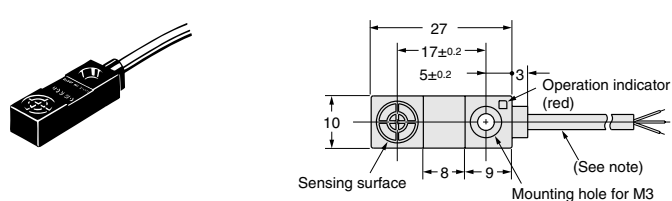

Mounting Bracket (Attachment)

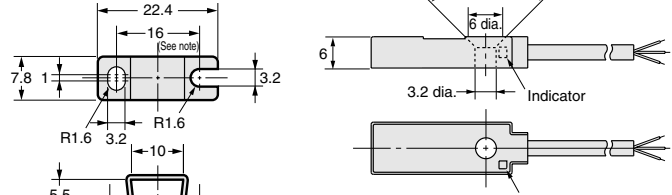

Note: Mounting dimensions: 17±0.2

* Vinyl-insulated round cable with three conductors, 2.9 dia. (conductor cross-sectional area: 0.14 mm²; insulation diameter: 0.9 mm); standard length: 2 m

TL-W5M□□

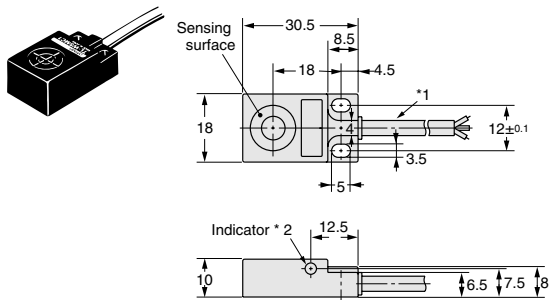

* 1. TL-W5MC1: Vinyl-insulated round cable with three conductors, 4 dia. (conductor cross-sectional area: 0.2 mm²; insulation diameter: 1.2 mm); standard length: 2 m
TL-W5MD□: Vinyl-insulated round cable with two conductors, 4 dia. (conductor cross-sectional area: 0.3 mm²; insulation diameter: 1.3 mm); standard length: 2 m
* 2. C type: Operation indicator (red)
D type: Operation indicator (red), Setting indicator (green)

TL-W5E□
TL-W5F□

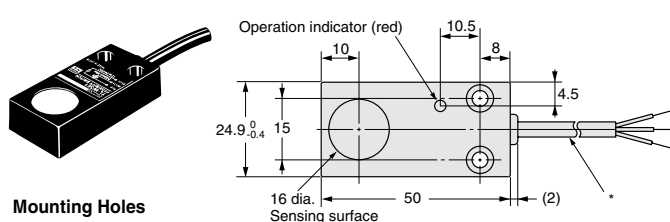

Mounting Holes

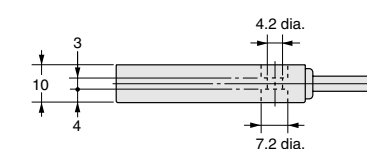
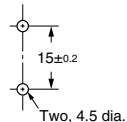

* Vinyl-insulated round cable with three conductors, 4 dia. (conductor cross-sectional area: 0.2mm²; insulation diameter: 1.2 mm); standard length: 2 m

TL-W20ME□

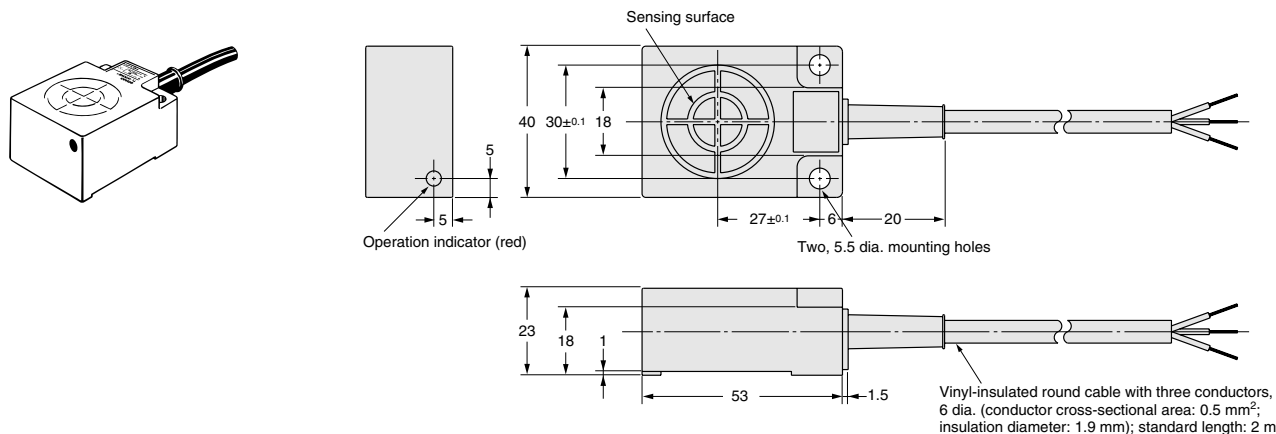

Vinyl-insulated round cable with three conductors, 6 dia. (conductor cross-sectional area: 0.5 mm²; insulation diameter: 1.9 mm); standard length: 2 m

ALL DIMENSIONS SHOWN ARE IN MILLIMETERS.

To convert millimeters into inches, multiply by 0.03937. To convert grams into ounces, multiply by 0.03527.

Cat. No. E221-E2-03-X

In the interest of product improvement, specifications are subject to change without notice.