

Smart Sensors
ZS Series

CompoWay/F Communication

Command Reference

OMRON

Introduction

Thank you for purchasing the ZS Series. This manual provides information regarding operations and input/output formats for the communication between ZS Series controllers and external devices using the Omron proprietary protocol, CompoWay/F.

This manual provides information for the following models and versions.

| Model | Firmware Version |
|--------------|-------------------------|
| ZS-LDC | v2.000 or later |
| ZS-HLDC | v1.000 or later |
| ZS-MDC | v2.000 or later |
| ZS-DSU | v2.000 or later |

- * Different firmware versions may cause communication errors, unintended setting overwrite, and damages on the controller. Please make sure to use the controller with the correct software version.

If your software version is not listed in the table above, please update the software using the SmartMonitorZS firmware update software, such as WarpEngineZS, to match the software version.

When using the ZS Series, be sure to observe the following:

- The ZS Series must be operated by personnel knowledgeable in electrical engineering.
- To ensure correct use, please read this manual thoroughly to deepen your understanding of the product.
- Please keep this manual in a safe place so that it can be referred to whenever necessary.

Contents

| | |
|---|------------|
| Contents | 1 |
| Section 1 About Communication Commands | 1-1 |
| How Communication Works | 1-2 |
| Setting the Communication Specifications | 1-3 |
| Command Formats | 1-4 |
| Response Formats | 1-6 |
| Examples of Abnormal End | 1-8 |
| Section 2 Details of Commands | 2-1 |
| About General Information of Communication Commands | 2-2 |
| Reading Parameter Areas | 2-3 |
| List of Parameter Area Reading Commands | 2-3 |
| Commands and Responses | 2-4 |
| Writing Parameter Areas | 2-6 |
| List of Parameter Area Writing Commands | 2-6 |
| Commands and Responses | 2-7 |
| Reading Variable Areas | 2-9 |
| List of Variable Area Reading Commands | 2-9 |
| Commands and Responses | 2-9 |
| Reading Controller Information | 2-11 |
| Operation Instructions | 2-12 |
| List of Operation Instruction Commands | 2-12 |
| Commands and Responses | 2-12 |
| Section 3 Unit No. and Parameter No. | 3-1 |
| Measurement Result Obtaining Command | 3-2 |
| Setting Value Obtaining and Changing Command | 3-4 |
| Parameter List (ZS-LDC) | 3-4 |
| Parameter List (ZS-HLDC) | 3-11 |
| Parameter List (ZS-MDC) | 3-18 |
| Parameter List (ZS-DSU) | 3-27 |

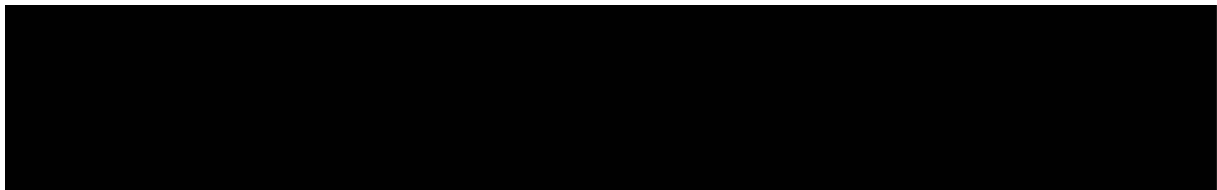

| | | |
|------------------|---|-------------|
| Section 4 | How to Obtain Flow Data | 4-1 |
| | <u>About Obtaining Flow Data</u> | <u>4-2</u> |
| | <u>Setting Procedures for Data Obtaining Conditions</u> | <u>4-3</u> |
| | <u>Setting Parameters</u> | <u>4-8</u> |
| | <u>Buffer Size and Buffer Interval</u> | <u>4-8</u> |
| | <u>Logging Data Type</u> | <u>4-8</u> |
| | <u>Flow Data Response</u> | <u>4-11</u> |
| | <u>Format</u> | <u>4-11</u> |
| | <u>Composition of Response</u> | <u>4-11</u> |

Section 1

About Communication Commands

| | |
|---|------------|
| ▣ <u>How Communication Works</u> | <u>1-2</u> |
| ▣ <u>Setting the Communication Specifications</u> | <u>1-3</u> |
| ▣ <u>Command Formats</u> | <u>1-4</u> |
| ▣ <u>Response Formats</u> | <u>1-6</u> |
| ▣ <u>Examples of Abnormal End</u> | <u>1-8</u> |

How Communication Works

ZS Series controllers have communication functions with external devices. Use this function to read the data in ZS Series controllers from the host and to write the setting data. Communication is achieved via the Command and Response Method based on the CompoWay/F, which is Omron's proprietary communication protocol. Controllers perform processing according to the command sent from the host, and then return the result to the host which sent the command as a response.

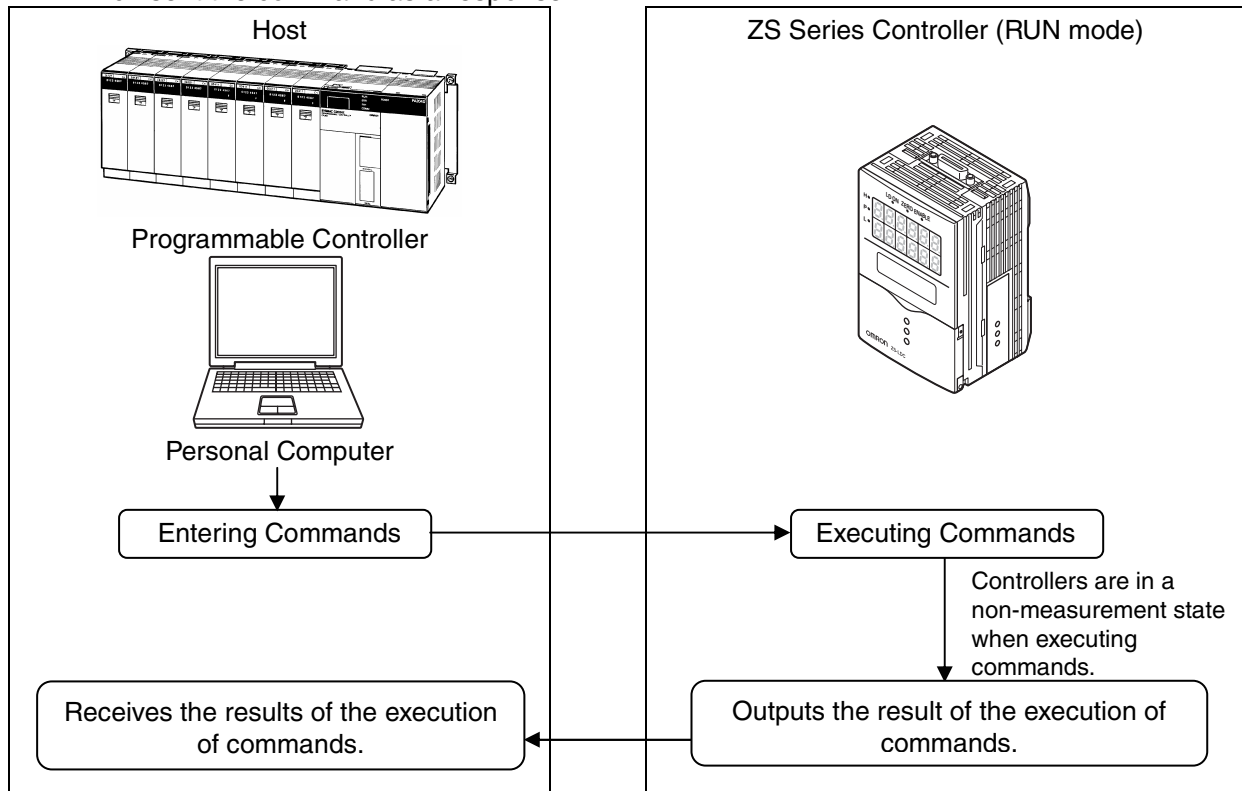

Setting the Communication Specifications

Change the settings of the controller communication specifications for communicating with the external device by CompoWay/F protocol.



Use USB cable or RS-232C cable to connect ZS Series controllers to external devices.

For USB cable connection, install Smart Monitor ZS and USB driver beforehand. After installing Smart Monitor ZS, USB ports are recognized as standard COM ports, and communication is achieved as with the RS-232C. (Setting the communication specifications including baud rate is not necessary.)

For details on how to connect cable, refer to the User's Manual for each controller.

- 1. Set the mode switch to "FUN"**
- 2. Select [System] - [Communication] - [Mode] menu.**
- 3. Select [CompoWay/F].**
- 4. For RS-232C cable connection, select [System] - [Communication] - [RS-232C] menu to set the appropriate communication specifications for the external device.**
- 5. Save the settings.**

Command Formats

The command format of the communication commands is shown below.
In the following section, items described with "Hex" after numerical values (ex. 02Hex) indicate hexadecimal numbers. Those described with " " or only with numeral values indicate ASCII characters.

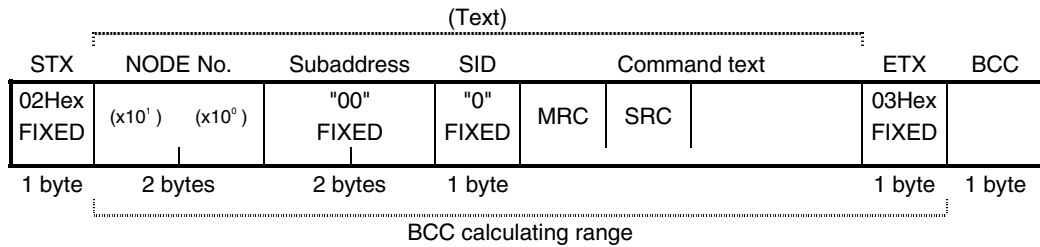

* In the example format, 1 byte = 1 ASCII character.

| Elements | Details |
|------------------|--|
| STX | This is a code to indicate the first part of communication frames (02Hex). Make sure to set the first byte to 02Hex. When a controller receives STX while receiving a command, it receives the command again starting from where it received STX. |
| NODE No. | This is the Node No. for the identification of the destination. * About Node No. It refers to the connection group No. as seen from the host device (PLC). Not only the ZS Series but other multiple devices are connected to the PLC. The number assigned to devices connected to a PLC such as this is referred to as a Node No. |
| Subaddress | This should be fixed to "00." |
| SID (Service ID) | This should be fixed to "0." |
| Command text | This is the text part of the command. "Section 2 – Details of Commands" describes these parts by command. |
| ETX | This is a code to indicate the end of the text (03Hex). |
| BCC | This is a block check character. The exclusive OR (XOR) of values from Node No. to ETX per byte is BCC. |

■ Example of BCC calculation

| STX | NODE No. | | Subaddress | SID | Command text | ETX | BCC |
|-------|----------|---------|------------|---------|-----------------------|-------|-------|
| 02Hex | "0" | "0" | "00" | "0" | "30053001" | 03Hex | 37Hex |
| | (30Hex) | (30Hex) | (3030Hex) | (30Hex) | (3330303533303031Hex) | | |

Set the result of calculation, which is "37Hex," to BCC.

<Calculation>

$$\text{BCC} = 30\text{Hex} + 30\text{Hex} + 30\text{Hex} + 30\text{Hex} + 30\text{Hex} + 33\text{Hex} + 30\text{Hex} + 30\text{Hex} + 35\text{Hex} + 33\text{Hex} + 30\text{Hex} + 30\text{Hex} + 31\text{Hex} + 03\text{Hex} = 37\text{Hex}$$



"+" indicates the exclusive OR (XOR) operation.

Response Formats

The response format of the communication commands is shown below.

In the following section, items described with "Hex" after numerical values (ex. 02Hex) indicate hexadecimal numbers. Those described with " " or only with numeral values indicate ASCII characters.

| STX | NODE No. | | Subaddress | End code | Response text | | ETX | BCC |
|----------------|-------------------|-------------------|---------------|----------|---------------|-----|----------------|--------|
| 02Hex Fixed | ($\times 10^1$) | ($\times 10^0$) | "00" Fixed | | MRC | SRC | 03Hex Fixed | |
| 1 byte | 2 bytes | | 2 bytes | 2 bytes | | | 1 byte | 1 byte |

| Elements | Details |
|---------------|---|
| STX |  Command Formats - page 1 - 4 |
| NODE No. | |
| Subaddress | |
| End code | Refer to the next page. |
| Response text | This is the response text part of the command. "Section 2 – Details of Commands" describes these parts by command. |
| ETX |  Command Formats - page 1 - 4 |
| BCC | |

End codes of responses are shown below.

| End code | Name | Details |
|----------|--------------------|--|
| "00" | Normal end | Command ends successfully. |
| "0F" | Command error | Specified command is not executed. Refer to the response code for details of the non-execution. |
| "10" | Parity error | Parity error occurred with any character while receiving a command. |
| "11" | Framing error | Framing error occurred with any character while receiving a command. |
| "12" | Overrun error | Overrun error occurred with any character while receiving a command. |
| "13" | BCC error | Received an invalid BCC. |
| "14" | Format error | <ul style="list-style-type: none"> Occurs when characters other than 0 to 9 or A to F are used for command text parts. (Except during echo back tests) No SID and command texts exist. Or no command text exists. Either MRC or SRC is missing in the command text. |
| "16" | Subaddress error | <ul style="list-style-type: none"> Subaddress of the receiving frame is invalid (not supported). No subaddress, SID, and command texts exist. Subaddress is shorter than two characters, and no SID and command texts exist. |
| "18" | Frame length error | Receiving frame exceeds the supported number of bytes. |

One end code is returned after receiving one complete command frame to the node.

No response is made when ETX or BCC characters are missing.



CHECK!

Noises may cause response errors or no response.
Make sure to retry from the host.

It may take three seconds at longest from sending a command to receiving a response. If no response is returned, make sure to send another command after waiting for more than three seconds.

Examples of Abnormal End

This section shows the examples of end codes for abnormal ends while receiving commands.

- **Invalid subaddress, and no SID and command text exist**

Command

| STX | NODE No. | Subaddress | | ETX | BCC |
|-------|----------|------------|-----|-------|-----|
| 02Hex | | "0" | "A" | 03Hex | |

Response

| STX | NODE No. | Subaddress | | End code | | ETX | BCC |
|-------|----------|------------|-----|----------|-----|-------|-----|
| 02Hex | | "0" | "A" | "1" | "6" | 03Hex | |

End code is "16" (Subaddress error).

- This response occurred because subaddress errors are prioritized over format errors.

- **No command text exists in the command**

Command

| STX | NODE No. | Subaddress | | SID | ETX | BCC |
|-------|----------|------------|-----|-----|-------|-----|
| 02Hex | | "0" | "0" | "0" | 03Hex | |

Response

| STX | NODE No. | Subaddress | | End code | | ETX | BCC |
|-------|----------|------------|-----|----------|-----|-------|-----|
| 02Hex | | "0" | "0" | "1" | "4" | 03Hex | |

End code is "14" (Format error).

- **Node No. is missing**

Command

| STX | ETX | BCC |
|-------|-------|-----|
| 02Hex | 03Hex | |

One character is missing for the Node No.

Response
No response is returned.

- **No subaddress exists, and an invalid BCC is used**

Command

| STX | NODE No. | ETX | BCC |
|-------|----------|-------|-----|
| 02Hex | | 03Hex | Err |

Response

| STX | NODE No. | Subaddress | | End code | | ETX | BCC |
|-------|----------|------------|-----|----------|-----|-------|-----|
| 02Hex | | "0" | "0" | "1" | "3" | 03Hex | |

Subaddress is "00" and end code is "13" (BCC error).

Section 2

Details of Commands

| | | |
|---|--|------|
| ▣ | <u>About General Information of Communication Commands</u> | 2-2 |
| ▣ | <u>Reading Parameter Areas</u> | 2-3 |
| | List of Parameter Area Reading Commands | 2-3 |
| | Commands and Responses | 2-4 |
| ▣ | <u>Writing Parameter Areas</u> | 2-6 |
| | List of Parameter Area Writing Commands | 2-6 |
| | Commands and Responses | 2-7 |
| ▣ | <u>Reading Variable Areas</u> | 2-9 |
| | List of Variable Area Reading Commands | 2-9 |
| | Commands and Responses | 2-9 |
| ▣ | <u>Reading Controller Information</u> | 2-11 |
| ▣ | <u>Operation Instructions</u> | 2-12 |
| | List of Operation Instruction Commands | 2-12 |
| | Commands and Responses | 2-12 |

About General Information of Communication Commands

Communication commands are categorized into the groups and meanings as in the following table:

| Groups | | Meanings | Pages for Reference |
|--------------------------------|----------------------|--|--|
| Reading parameter areas | System- related | Read setting values related to the target CH system. | Page 2-3 |
| | Measurement- related | Read measurement-related setting values and results of measurements. Obtain data by specifying Unit No. and Data No. | (Refer to Section 3 for Unit No. and Data No.) |
| Writing parameter areas | System- related | Write setting values related to the target CH system. | - |
| | Measurement- related | Write measurement-related setting values and results of measurements. Write data by specifying Unit No. and Data No. | (Refer to Section 3 for Unit No. and Data No.) |
| Reading variable areas | | Read particular kinds of data in the target CH system. | Page 2-9 |
| Reading controller information | | Read information on the models connected with a cable. | Page 2-11 |
| Operation instructions | | Operate data of each bank or all banks. | Page 2-12 |

[Notes on the exchange of communication data]

- Number of elements indicates the size of data to be exchanged. ASCII character length per element is determined depending on parameter type codes. Specifically,
8000h to BFFFh : 4 characters per element
From C000h: 8 characters per element
Number of elements = 1 for all commands in this manual. Please enter "8001h" to specify number of elements.
- Machine No. indicates channel No. of the destination controller.
- All data is exchanged in hexadecimal numbers. Therefore, "15" of the decimal number should be expressed as "0000000Eh." (*1)
- Distance values should be expressed in the unit of [nm]. Therefore, note that "100 (=00000064h)" indicates "100nm 0.1um" and not 100mm. (*1)
- Negative values are expressed as the complements of 2. For example, "-100" should be expressed as "FFFFFF9Ch." (*1)
- In the case that the measured values such as distance are abnormal values, data parts are expressed as "7FFFFFFXh" ("X" varies depending on the case.) (*1)

*1: This is an example for 8 characters per element.

Reading Parameter Areas

Read parameter areas.

List of Parameter Area Reading Commands

| Data Name | MRC | SRC | Parameter Type | Reading start address | Specification of element numbers | Data to be read | Data Length *2 |
|---------------------------------|-----|-----|----------------------|--|----------------------------------|---|----------------|
| Bank switching | 02h | 01h | 8000h | <Machine No.> | 8001h | 0 to 3 | 4 |
| Keylock | 02h | 01h | A002h | <Machine No.> | 8001h | 0 : OFF, 1 : ON | 4 |
| Version Information | 02h | 01h | A021h | <Machine No.> | 8001h | Software Version | 4 |
| Controller type Information | 02h | 01h | A022h | <Machine No.> | 8001h | 0 : ZS-LDC, 1 : ZS-MDC, 2 : ZS-DSU | 4 |
| RS-232C Data Length Setting | 02h | 01h | A030h | <Machine No.> | 8001h | 0 : 7 bits, 1 : 8 bits | 4 |
| RS-232C Parity Setting | 02h | 01h | A031h | <Machine No.> | 8001h | 0 : None, 1 : Odd Number, 2 : Even Number | 4 |
| Stop bits setting | 02h | 01h | A032h | <Machine No.> | 8001h | 0 : 1 bit, 1 : 2 bits | 4 |
| Communication node setting | 02h | 01h | A033h | <Machine No.> | 8001h | 0 to 64 | 4 |
| Digits after decimal point | 02h | 01h | A040 | <Machine No.> | 8001h | 0 : 1 digit, 1 : 2 digits, 2 : 3 digits, 3 : 4 digits, 4 : 5 digits | 4 |
| Digital "Eco" mode | 02h | 01h | A041h | <Machine No.> | 8001h | 0 : NORMAL, 1 : ECO1, 2 : OFF | 4 |
| LCD ON/OFF | 02h | 01h | A042h | <Machine No.> | 8001h | 0 : OFF, 1 : AUTOOFF, 2 : ON | 4 |
| LCD Backlight | 02h | 01h | A043h | <Machine No.> | 8001h | 0 : OFF, 1 : AUTOOFF, 2 : ON | 4 |
| Sensor Load | 02h | 01h | A050h | <Machine No.> | 8001h | 0 : LOAD every time, 1 : SAVE | 4 |
| Language | 02h | 01h | A051h | <Machine No.> | 8001h | 0 : Japanese, 1 : English | 4 |
| Reading processing unit data *1 | 02h | 01h | C000h+ <Data No.> | XXYYh XX : Unit No. YY : Machine No. | 8000h + <No. of Elements> | Data to be read | 8 |

* 1 - All reading/writing operations on processing units are assigned by using this command.

* 2 - Indicates ASCII character length. Refer to page 2-2 for details.



Refer to "Section 3 - Unit No. and Parameter No." for Unit No. and Parameter No. for each processing unit.

Example 1: To read the "language" information from the 2CH controller, assign a command as follows:

[Machine No.]=0002h

| MRC | SRC | Parameter Type | Reading start address | Number of elements |
|-----|-----|----------------|-----------------------|--------------------|
| 02h | 01h | A051h | 0002h | 8001h |

Example 2: To read the final measured value from the 1CH controller, assign a command as follows:



[Data No.]=20h, [Unit No.]=30h, [Machine No.]=01h

| MRC | SRC | Parameter Type | Reading start address | Number of elements |
|-----|-----|----------------|-----------------------|--------------------|
| 02h | 01h | C020h | 3001 | 8001h |

Commands and Responses

Command

| MRC | SRC | Parameter Type | Reading start address | Number of elements |
|---------|---------|----------------|-----------------------|--------------------|
| "02" | "01" | | | |
| 2 bytes | 2 bytes | 4 bytes | 4 bytes | 4 bytes |

| Elements | Details |
|-----------------------|---|
| Parameter Type | Specify parameters depending on the data to be obtained.  List of Parameter Area Reading Commands page 2-3 |
| Reading start address | Specify the Machine No. (=CH No.) of the controller to read data by using an ASCII code expressed in hexadecimal numbers. Please note that the format of "processing unit data reading" commands is XXYYh (XX : <Unit No.>, YY : <Machine No.>)  Unit No. and Parameter No. page 3-4 |
| Number of elements | Specify number of elements depending on the Parameter Type.  List of Parameter Area Reading Commands page 2-3 |

Response

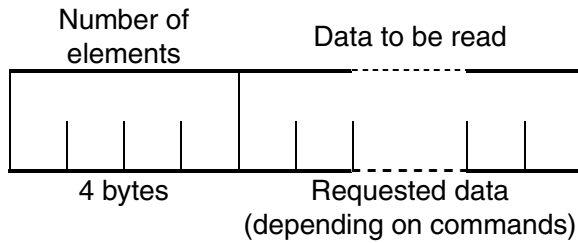
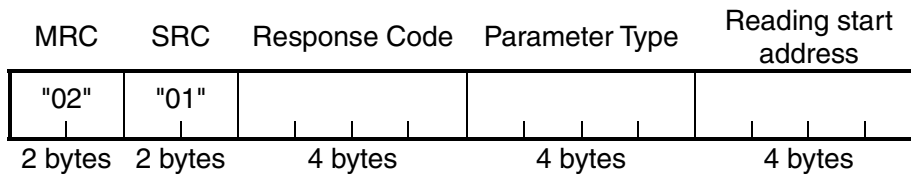

| Elements | Details |
|-----------------|---|
| Response Code | Indicates controller status for the command. Data to be read is not returned when an error occurs. |
| Data to be read | Data to be read is expressed by using an ASCII code in hexadecimal numbers. Data length varies depending on commands.  List of Parameter Area Reading Commands page 2-3 |

Response code for normal end

| Response Code | Name | Details |
|---------------|------------|------------|
| "0000" | Normal end | No errors. |

Response code when an error occurs

| Response Code | Error name | Cause |
|---------------|--------------------------------------|---|
| "1001" | Long command length | Command length is too long. |
| "1002" | Short command length | Command length is too short. |
| "1003" | Inconsistent number of elements/data | Number of elements and data do not match. |
| "1101" | Area type error | Parameter type is wrong. |
| "1103" | Start address outside of range error | Reading start address is out of range. Reading start address specifies the sensor of the unconnected Machine No. Bit position is other than "00." |
| "1104" | End address outside of range error | Specified number of elements is out of range. |
| "2203" | Operating error | Reading error. |
| "2204" | Operating error | Operating mode of sensor is other than RUN. |
| "2205" | Operating error | Invalid command. |

Writing Parameter Areas

Write parameter areas.

List of Parameter Area Writing Commands

| Data Name | MRC | SRC | Parameter Type | Writing start address | Specification of element numbers | Data to be written | Data Length *2 |
|---------------------------------|-----|-----|----------------------|--|----------------------------------|---|----------------|
| Bank switching | 02h | 02h | 8000h | <Machine No.> | 8001h | 0 to 3 | 4 |
| KEYLOCK | 02h | 02h | A002h | <Machine No.> | 8001h | 0 : OFF, 1 : ON | 4 |
| RS-232C Data Length Setting | 02h | 02h | A030h | <Machine No.> | 8001h | 0 : 7 bits, 1 : 8 bits | 4 |
| RS-232C Parity Setting | 02h | 02h | A031h | <Machine No.> | 8001h | 0 : None, 1 : Odd Number, 2 : Even Number | 4 |
| Stop bits setting | 02h | 02h | A032h | <Machine No.> | 8001h | 0 : 1 bit, 1 : 2 bits | 4 |
| Communication node setting | 02h | 02h | A033h | <Machine No.> | 8001h | 0 to 64 | 4 |
| Digits after decimal point | 02h | 02h | A040 | <Machine No.> | 8001h | 0 : 1 digit, 1 : 2 digits, 2 : 3 digits, 3 : 4 digits, 4 : 5 digits | 4 |
| Digital "Eco" mode | 02h | 02h | A041h | <Machine No.> | 8001h | 0 : NORMAL, 1 : ECO1, 2 : OFF | 4 |
| LCD ON/OFF | 02h | 02h | A042h | <Machine No.> | 8001h | 0 : OFF, 1 : AUTOOFF, 2 : ON | 4 |
| LCD Backlight | 02h | 02h | A043h | <Machine No.> | 8001h | 0 : OFF, 1 : AUTOOFF, 2 : ON | 4 |
| Sensor Load | 02h | 02h | A050h | <Machine No.> | 8001h | 0 : LOAD, 1 : SAVE | 4 |
| Language | 02h | 02h | A051h | <Machine No.> | 8001h | 0 : Japanese, 1 : English | 4 |
| Writing processing unit data *1 | 02h | 02h | C000h+ <Data No.> | XXYYh XX : Unit No. YY : Machine No. | 8000h + <No. of Elements> | Data to be written | 8 |

* 1 - All reading/writing operations on processing units are assigned by using this command.

* 2 - Indicates ASCII character length. Refer to page 2-2 for details.



Refer to "Section 3 - Unit No. and Parameter No." for Unit No. and Parameter No. for each processing unit.

Example 1: To turn on the "KEYLOCK" of the 2CH controller, assign a command as follows:

[Machine No.]=0002h, [Data to be written]=0001h

| MRC | SRC | Parameter Type | Reading start address | Number of elements | Data to be written |
|-----|-----|----------------|-----------------------|--------------------|--------------------|
| 02h | 02h | A002h | 0002h | 8001h | 0001h |

Example 2: To set the peak hold mode for the 1CH controller, assign a command as follows:





[Data No.]=02h, [Unit No.]=2Dh, [Machine No.]=01h, [Data to be written]=00000001h

| MRC | SRC | Parameter Type | Writing start address | Number of elements | Data to be written |
|-----|-----|----------------|-----------------------|--------------------|--------------------|
| 02h | 02h | C002h | 2D01 | 8001h | 00000001h |

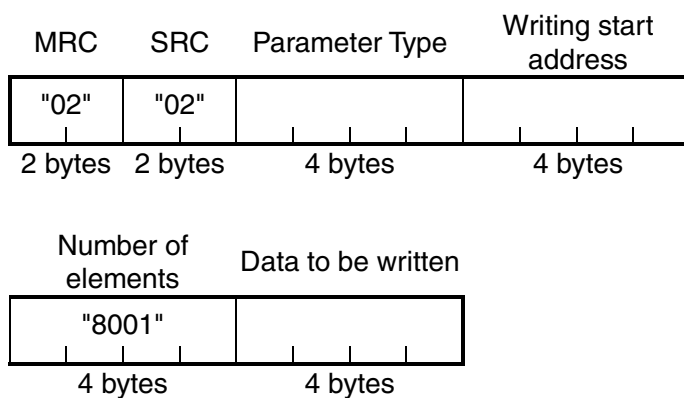
Commands and Responses

Command



| Elements | Details |
|-----------------------|---|
| Parameter Type | Specify parameters depending on the data to be written.  List of Parameter Area Writing Commands page 2-6 |
| Writing start address | Specify the Machine No. (=CH No.) of the controller to write data by using an ASCII code expressed in hexadecimal numbers. Please note that the format of "processing unit data writing" commands is XYYh (XX : <Unit No.>, YY : <Machine No.>)  Unit No. and Parameter No. page 3-4 |
| Number of elements | Specify number of elements depending on the Parameter Type.  List of Parameter Area Writing Commands page 2-6 |
| Data to be written | Data to be written is specified by using an ASCII code in hexadecimal numbers. Data length varies depending on commands. <ul style="list-style-type: none"> • List of Parameter Area Writing Commands page 2-6 • Do not issue commands other than specified parameter types. Issuing wrong commands may rewrite internal parameters. In the case that internal parameters of connected sensors are rewritten, execute "EEPROM initialization" of operation instruction commands.  |

Response

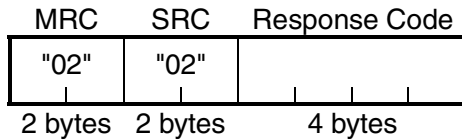

| Elements | Details |
|---------------|--|
| Response Code | Indicates controller status for the command. |

Response code for normal end

| Response Code | Name | Details |
|---------------|------------|------------|
| "0000" | Normal end | No errors. |

Response code when an error occurs

| Response Code | Error name | Cause |
|---------------|--------------------------------------|--|
| "1001" | Long command length | Command length is too long. |
| "1002" | Short command length | Command length is too short. |
| "1003" | Inconsistent number of elements/data | Number of elements and data do not match. |
| "1100" | Parameter error | Data to be written is out of specified range. |
| "1101" | Area type error | Parameter type is wrong. |
| "1103" | Start address outside of range error | Writing start address is out of range. Writing start address specifies the sensor of the unconnected Machine No. |
| "1104" | End address outside of range error | Specified number of elements is other than "8001." |
| "2203" | Operating error | Setting is abnormal. Refer to the User's Manual of the ZS Series for setting error conditions of thresholds and the hysteresis width. |
| "2204" | Operating error | Operating mode of sensor is other than RUN. |
| "2205" | Operating error | Invalid command. |

Reading Variable Areas

Read variable areas.

List of Variable Area Reading Commands

| Data Name | MRC | SRC | Variable Type | Reading start address | Bit position | Number of elements |
|-------------------|-----|-----|---------------|-----------------------|--------------|--------------------|
| Flow data | 01h | 01h | E1h | 0000h | 00h | 0001h |
| Measurement Cycle | 01h | 01h | 81h | <Machine No.> | 00h | 0002h |

Example: To read the measurement cycle information from the 2CH controller, assign a command as follows:



[Machine No.]=0002h

| MRC | SRC | Variable Type | Reading start address | Bit position | Number of elements |
|-----|-----|---------------|-----------------------|--------------|--------------------|
| 01h | 01h | 81h | 0002h | 00h | 0002h |

Commands and Responses

Command

| MRC | SRC | Variable Type | Reading start address | Bit position | Number of elements |
|---------|---------|---------------|-----------------------|--------------|--------------------|
| "01" | "01" | | | "00" | |
| 2 bytes | 2 bytes | 2 bytes | 4 bytes | 2 bytes | 4 bytes |

| Elements | Details |
|-----------------------|--|
| Variable type | Specify variables depending on the data to be obtained.  List of Variable Area Reading Commands page 2-9 |
| Reading start address | Specify the Machine No. (=CH No.) of the controller to read data by using an ASCII code expressed in hexadecimal numbers.  Unit No. and Parameter No. page 3-4 |
| Bit position | ZS Series does not support bit access. It is fixed to "00." |
| Number of elements | Specify number of elements depending on the Variable Type.  List of Variable Area Reading Commands page 2-6 |

Response

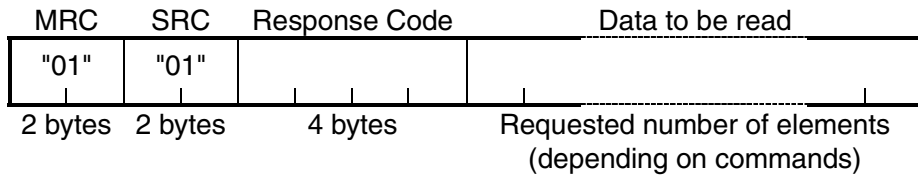

| Elements | Details |
|-----------------|---|
| Response Code | Indicates controller status for the command. Data to be read is not returned when an error occurs. |
| Data to be read | Data length is number of elements x 4 ASCII characters. Since the data reading part of the flow data obtaining commands use special formats, refer to "Section 4: How to Obtain Flow Data."  Composition of Flow Data Responses page 4-10 |

Response code for normal end

| Response Code | Name | Details |
|---------------|------------|------------|
| "0000" | Normal end | No errors. |

Response code when an error occurs

| Response Code | Error name | Cause |
|---------------|--------------------------------------|---|
| "1001" | Long command length | Command length is too long. |
| "1002" | Short command length | Command length is too short. |
| "1003" | Inconsistent number of elements/data | Number of elements and data do not match. |
| "1101" | Area type error | Variable type is wrong. |
| "1103" | Start address outside of range error | Reading start address is out of range. Reading start address specifies the sensor of the unconnected Machine No. Bit position is other than "00." |
| "1104" | End address outside of range error | Specified number of elements is out of range. |
| "2203" | Operating error | Reading error. |
| "2204" | Operating error | Operating mode of sensor is other than RUN. |
| "2205" | Operating error | Invalid command. |

Reading Controller Information

Read data about ZS Series types and so on.

Command

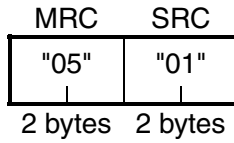

Response

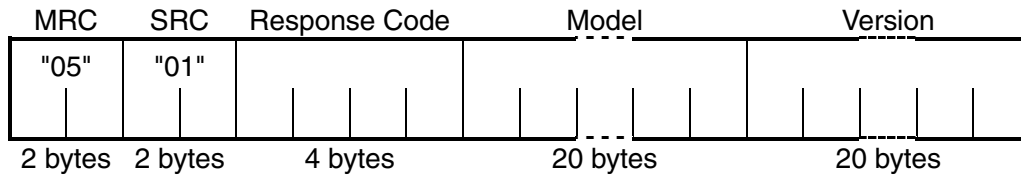

| Elements | Details |
|---------------|--|
| Response Code | Indicates controller status for the command. Data to be read is not returned when an error occurs. |
| Model | Model is expressed with 20 ASCII characters. |
| Version | Version is expressed with 20 ASCII characters. |

Response code for normal end

| Response Code | Name | Details |
|---------------|------------|------------|
| "0000" | Normal end | No errors. |

Response code when an error occurs

| Response Code | Error Name | Cause |
|---------------|----------------------|------------------------------|
| "1001" | Long command length | Command length is too long. |
| "1002" | Short command length | Command length is too short. |

Operation Instructions

Provides operation instructions to controllers.

List of Operation Instruction Commands

| Instruction Name | MRC | SRC | Instruction Code | Related Information 1 | Related Information 2 |
|------------------|-----|-----|------------------|-----------------------|-----------------------|
| Complete INIT | 30h | 05h | 55h | <Machine No.> | 0000h |
| DATA SAVE | 30h | 05h | 57h | <Machine No.> | 0000h |
| CLEAR | 30h | 05h | 58h | <Machine No.> | 0000h |

CLEAR (which clears banks) initializes current banks' sensing settings and measurement settings. Settings of other banks and system settings are not initialized.
Complete INIT initializes all settings (settings of all banks and system settings).

Example: To execute Complete INIT of the 2CH controller, assign a command as follows:

[Related information1]=02h

| MRC | SRC | Instruction Code | Related Information 1 | Related Information 2 |
|-----|-----|------------------|-----------------------|-----------------------|
| 30h | 05h | 55h | 02h | 0001h |

Commands and Responses

Command

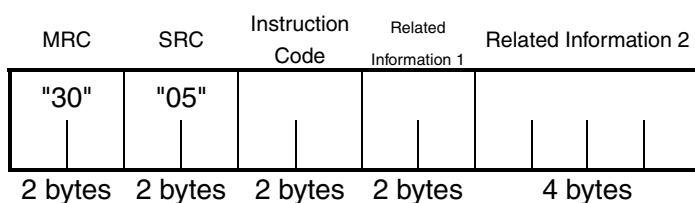

| Elements | Details |
|-----------------------|---|
| Instruction Code | Specify commands depending on the instruction to be executed. |
| Related Information 1 | Specify the channel No. of the controller related to the command. Example: In the case of 2CH, specify "02." |
| Related Information 2 | Usually, setting other than "0000" is not accepted. |

Response

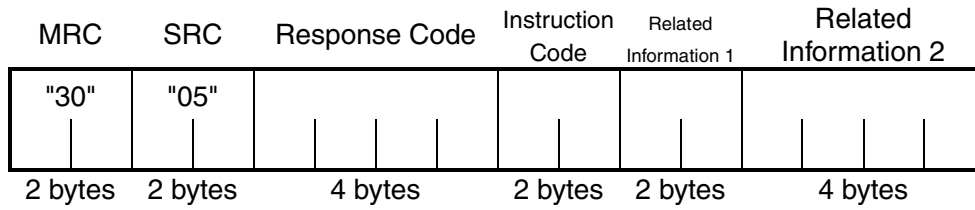

| Elements | Details |
|-----------------------|---|
| Response Code | Indicates controller status for the command. |
| Instruction Code | The code which is the same as the transmitted will be returned. |
| Related Information 1 | |
| Related Information 2 | |

Response code for normal end

| Response Code | Name | Details |
|---------------|------------|------------|
| "0000" | Normal end | No errors. |

Response code when an error occurs

| Response Code | Error Name | Cause |
|---------------|--------------------------------------|---|
| "1001" | Long command length | Command length is too long. |
| "1002" | Short command length | Command length is too short. |
| "1101" | Area type error | Instruction code is invalid. |
| "1103" | Start address outside of range error | Related information specifies the sensor of the unconnected Machine No. |
| "2203" | Operating error | Setting is abnormal. Refer to the User's Manual of the ZS Series for error conditions. |
| "2204" | Operating error | Operating mode of sensor is other than RUN. |
| "2205" | Operating error | Invalid command. |

MEMO

Section 3

Unit No. and Parameter No.

| | | |
|---|---|------|
| ▣ | <u>Measurement Result Obtaining Command</u> | 3-2 |
| ▣ | <u>Setting Value Obtaining and Changing Command</u> | 3-4 |
| | Parameter List (ZS-LDC) | 3-4 |
| | Parameter List (ZS-HLDC) | 3-11 |
| | Parameter List (ZS-MDC) | 3-18 |
| | Parameter List (ZS-DSU) | 3-27 |

Measurement Result Obtaining Command

■ Parameter List (ZS-LDC)

When selecting a mode other than "THICK/GAP - FILM/OTHERS - TRANSFER" mode (when no 2-area measurement is performed):

| Unit No. | Data No. | Parameter Description |
|----------|----------|--|
| 30h | 20h | Measurement result (=Main digital display value) |

When selecting "THICK/GAP - FILM/OTHERS - TRANSFER" mode (when a 2-area measurement is performed):

| Unit No. | Data No. | Parameter |
|----------|----------|---|
| 30h | 20h | Area 1 displacement value (TASK1) |
| 44h | | Area 2 displacement value (TASK2) |
| 58h | | Thickness and/or Gap results (=Main digital display value = TASK3 = Area1 – Area2) |

■ Parameter List (ZS-HLDC)

For single task mode

When selecting a mode other than "GLASS/MODE 2" or "GLASS THICKNESS/MODE 2" mode

(when no 2-area measurement is performed):

| Unit No. | Data No. | Parameter Description |
|----------|----------|--|
| 30h | 20h | Measurement result (=Main digital display value) |

When selecting "GLASS/MODE 2" or "GLASS THICKNESS/MODE 2" mode

(when a 2-area measurement is performed):

| Unit No. | Data No. | Parameter |
|----------|----------|---|
| 30h | 20h | Area 1 displacement value (TASK1) |
| 44h | | Area 2 displacement value (TASK2) |
| 58h | | Glass surface and/or Glass thickness results (=Main digital display value = TASK3 = Area1 – Area2) |

For multi-task mode

| Unit No. | Data No. | Parameter |
|----------|----------|--------------------------|
| 30h | 20h | TASK1 measurement result |
| 44h | | TASK2 measurement result |
| 58h | | TASK3 measurement result |
| 6Ch | | TASK4 measurement result |

Parameter List (ZS-MDC)

| Unit No. | Data No. | Parameter |
|----------|----------|--------------------------|
| 30h | 20h | TASK1 measurement result |
| 44h | | TASK2 measurement result |
| 58h | | TASK3 measurement result |
| 6Ch | | TASK4 measurement result |

Example1: When obtaining a measurement result of ZS-LDC (2CH) (and when no 2-area measurement is performed):

02h 01h (C000h + 20h (Data No.)) 30h (Unit No.) 02h (CH No.) (8000h + 1h (Number of elements))

In the command section, the value is shown as below:

02h 01h C020h 3002h 8001h

To this command, if the response is shown as below:

02h 01h C020h 3002h 8001h 04CC5520h

It indicates as 80500000nm (= 80.5mm) because 04CC5520h = 80500000.

Example2: When obtaining a displacement value of a standalone ZS-LDC (0CH) Area2 (and a 2-area measurement is performed):

02h 01h (C000h + 20h (Data No.)) 44h (Unit No.) 00h (CH No.) (8000h + 1h (Number of elements))

In the command section, the value is shown as below:

02h 01h C020h 4400h 8001h

To this command, if the response is shown as below:

02h 01h C020h 4400h 8001h 02719C40h

It indicates as 41000000nm (= 41mm) because 02719C40h = 41000000.

Example3: When obtaining a measurement result of ZS-MDC (0CH) TASK3:

02h 01h (C000h + 20h (Data No.)) 58h (Unit No.) 00h (CH No.) (8000h + 1h (Number of elements))

In the command section, the value is shown as below:

02h 01h C020h 5800h 8001h

To this command, if the response is shown as below:

02h 01h C020h 5800h 8001h FFF0BDC0h

It indicates as -1000000nm (= -1mm) because FFF0BDC0h = -1000000.

(A negative value is expressed as a complement of two.)

Setting Value Obtaining and Changing Command Parameter List (ZS-LDC)

■ Sensing Setting (common for all TASKs)

| Unit No. | Data No. | Parameter | Setting range/ output range | Remarks |
|----------|--------------------------------|---|--|---|
| 00h | 00h | Measurement mode | 0: STANDARD 1: HI-RESO 2: HI-SPEED 3: HI-SENS 4: CUSTOM | |
| | 12h | Exposure time | 2 to 200 (1div:0.1ms) | Parameters when [Measurement mode]=[Custom] |
| | 13h | Number of additional lines | 1 to 200 | |
| | 14h | Line skipping | 0: ON 1: OFF | |
| 01h | 00h | Head installation | 0: DIFFUSE 1: REGULAR | |
| 02h | 00h | LD power mode | 0: Auto 1: Auto range 2: Fixed | (Note 1) |
| | 02h | Surface to be controlled for light amount | 0: Peak 1: Surface 2: Second surface 3: Third surface | |
| | 06h | LD power when fixed | 0 to 1000 (1div:0.1%) | Parameters when [Emitted light amount setting]=[Fixed] |
| | 0Dh | Lower limit of LD power | 0 to 800 (1div:0.1%) | Parameters when [Emitted light amount setting]=[Auto range] |
| | 0Eh | Upper limit of LD power | 0 to 800 (1div:0.1%) | |
| | 25h | Incident level (First surface) | 0 to 4095 (tone) | |
| | 26h | Incident level (Second surface) | 0 to 4095 (tone) | |
| 27h | Incident level (Third surface) | 0 to 4095 (tone) | | |
| 03h | 00h | Measurement object | 0: NORMAL 1: PCB 2: MIRROR 3: GLASS 4: THICKNESS 5: GAP | |
| | 01h | Glass material | 0: NORMAL 1: FILM/OTHERS | Parameters when [Measurement object]=[Thickness] or [Gap] |
| | 02h | Glass thickness measurement mode | 0: STOP 1: Moving | Parameters when [Glass material]=[FILM/ OTHERS] |

| Unit No. | Data No. | Parameter | Setting range/ output range | Remarks |
|----------|----------|---|--|---|
| 03h | 03h | Image smoothing level | 0: None 1: Filter size 2 2: Filter size 4 3: Filter size 8 4: Filter size 16 | |
| | 04h | Background removing level before addition | 0 to 255 (tone) | |
| | 05h | Background removing level after addition | 0 to 4095 (tone) | |
| | 06h | Edge threshold | 0: 0 % 1: 12.5 % 2: 25% 3: 37.5 % 4: 50% 5: 62.5 % 6: 75% 7: 87.5 % | |
| 04h | 00h | Mutual interference prevention mode | 0: OFF 1: ON | |
| | 01h | Timing setting | 0: Timing A 1: Timing B | Parameters when [Mutual interference prevention mode]=[ON] |
| 05h | 00h | Gain setting | 1 to 5 | |
| 07h | 00h | LD power mode (Area 1) | 0: Auto 1: Auto range 2: Fixed | (Note 1) |
| | 02h | Surface to be controlled for light amount | 0: Peak 1: Surface 2: Second surface 3: Third surface | |
| | 06h | LD power when fixed | 0 to 1000 (1div:0.1%) | Parameters when [Emitted light amount setting]=[Fixed] |
| | 0Dh | Lower limit of LD power | 0 to 800 (1div:0.1%) | Parameters when [Emitted light amount setting]=[Auto range] |
| | 0Eh | Upper limit of LD power | 0 to 800 (1div:0.1%) | |
| | 11h | Measurement target area | 0: Surface 1: Second surface 2: Third surface | |
| | 25h | Incident level (First surface) | 0 to 4095 (tone) | |
| | 26h | Incident level (Second surface) | 0 to 4095 (tone) | |
| | 27h | Incident level (Third surface) | 0 to 4095 (tone) | |

Section 3 Setting Value Obtaining and Changing Command

| Unit No. | Data No. | Parameter | Setting range/ output range | Remarks |
|----------|----------|---|--|---|
| 08h | 00h | LD power mode (Area 2) | 0: Auto 1: Auto range 2: Fixed | (Note 1) |
| | 02h | Surface to be controlled for light amount | 0: Peak 1: Surface 2: Second surface 3: Third surface | |
| | 06h | LD power when fixed | 0 to 1000 (1div:0.1%) | Parameters when [Emitted light amount setting]=[Fixed] |
| | 0Dh | Lower limit of LD power | 0 to 800 (1div:0.1%) | Parameters when [Emitted light amount setting]=[Auto range] |
| | 0Eh | Upper limit of LD power | 0 to 800 (1div:0.1%) | |
| | 11h | Measurement target area | 0: Surface 1: Second surface 2: Third surface | |
| | 25h | Incident level (First surface) | 0 to 4095 (tone) | |
| | 26h | Incident level (Second surface) | 0 to 4095 (tone) | |
| | 27h | Incident level (Third surface) | 0 to 4095 (tone) | |

Note 1: When no 2-area measurement is performed, Unit No. 2 is valid and Unit No. 7 and 8 are invalid.

When a 2-area measurement is performed, Unit No. 2 is invalid and Unit No. 7 and 8 are valid.

Example 1: When reading the setting values of edge threshold (when LDC is 1CH):

Since the edge threshold for Unit No. is 03h, and Data No. is 06h, values are shown as below:

02h 01h (C000h + 06h (Data No.)) 03h (Unit No.) 01h (CH No.) (8000h + 1h (Number of elements))

In the command section, the value is shown as below:

02h 01h C006h 0301h 8001h

To this command, if the response is shown as below:

02h 01h C006h 0301h 8001h 00000004h,

It indicates 50 % because the value is 4.

Example 2: When changing the gain setting to 3 (when ZS-LDC is 0CH):

Since the gain setting for Unit No. is 05h, and Data No. is 00h, values are shown as below:

02h 02h (C000h + 00h (Data No.)) 05h (Unit No.) 00h (CH No.)

and (8000h + 1h (Number of Elements)) 00000003h (Data to be written),

In the command section, the value is shown as below:

02h 02h C000h 0000h 8001h 00000003h

To this command, if the response is shown as below:

02h 02h 0000h

It indicates a normal end.

■ Measurement Setting 1 (Settings per TASK) (Note 2)

| Unit No. (Note 3) | Data No. | Parameter | Setting range/output range | Remarks |
|----------------------|----------|-----------------------------|--|---------|
| 29h | 00h | Scaling mode | 0: OFF 1: ON | |
| | 01h | Span value | -20000 to 20000 (X0.0001) | |
| | 02h | Offset value | -999999999 to 999999999 (nm) | |
| 2Ah | 02h | Smooth | 0: OFF 1: ON | |
| 2Bh | 02h | Average number of times | 0: 1 time 1: 2 times 2: 4 times 3: 8 times 4: 16 times 5: 32 times 6: 64 times 7: 128 times 8: 256 times 9: 512 times 10: 1024 times 11: 2048 times 12: 4096 times | |
| 2Ch | 02h | Differential mode | 0: OFF 1: ON | |
| | 03h | Differentiation cycles | 1 to 5000 (ms) | |
| 2Dh | 02h | Hold type | 0: OFF 1: PEAK 2: BOTTOM 3: P-P 4: AVERAGE 5: SAMPLE | |
| | 03h | Trigger method | 0: External 1: Self-up trigger 2: Self-down trigger | |
| | 04h | Trigger level | -999999999 to 999999999 (nm) | |
| | 05h | Trigger hysteresis | 0 to 999999999 (nm) | |
| | 06h | Trigger delay (ms) | 0 to 5000 (ms) | |
| | 07h | Sampling period (ms) | 1 to 5000 (ms) | |
| | 08h | Trigger delay mode | 0: OFF 1: ON | |
| 2Eh | 05h | Offset value for zero reset | -999999999 to 999999999 (nm) | |
| | 07h | Zero reset mode | 0: REAL 1: HOLD | |
| 30h | 02h | LOW threshold value | -999999999 to 999999999 (nm) | |
| | 03h | HIGH threshold value | -999999999 to 999999999 (nm) | |

(Note 2)

The same task as MDC is performed as internal processing when selecting a “THICK/GAP - FILM/OTHERS - TRANSFER” mode (when a 2-area measurement is performed).

Processing is assigned to each task as below:

| | When 2-area measurement is performed (*3) | When measurement other than 2-area measurement is performed |
|--------------|--|---|
| TASK1 | Calculates Area 1 displacement value | Measurement result (*1) |
| TASK2 | Calculates Area 2 displacement value | Unused (*2) |
| TASK3 | Calculates the difference (=Thickness/gap) between TASK 1 and TASK 2 | Unused (*2) |
| TASK4 | Unused (*2) | Unused (*2) |

*1: The result is a thickness distance value when the thickness measurement is set.

Other than the above, the result is a surface distance value.

*2: An error always occurs.

*3: Only TASK3 can be displayed or set on the controller.

(Note 3)

The Unit No. here indicates TASK 1 Unit No.

Unit No. other than the above, such as TASK2 or a later one, can be calculated by adding (TASK number -1) to the Unit No. and multiplying it by 14h for another reference or setting.

Example1: When reading the setting values of the average number of times (when ZS-LDC is 1CH, and no 2-area measurement is performed):

Since the average number of times is 2Bh for Unit No., and 02h for Data No., values are shown as below:

02h 01h (C000h + 02h (Data No.)) 2Bh (Unit No.) 01h (CH No.) (8000h + 1h (Number of elements))

In the command section, the value is shown as below:

02h 01h C002h 2B01h 8001h

To this command, if the response is shown as below:

02h 01h C002h 2B01h 8001h 00000004h

Since the value is 4, this indicates 16 times.

Example 2: When changing a high threshold value for the result of thickness to 100 mm (when ZS-LDC is 0CH, and a 2-area measurement is performed):

The thickness result is calculated by using TASK3 when performing a 2-area measurement.

Usually, the high threshold value is 30h for Unit No., and 03h for Data No.

However, Unit No. is 58h (= 30h + (3-1) x 14h) because TASK3 is set this time.

Besides, 100mm thickness is expressed as 05F5E100h in a hexadecimal number because 100 mm is 100,000,000nm.

02h 02h (C000h + 03h (Data No.)) 58h (Unit No.) 00h (CH No.)

and (8000h + 1h (Number of Elements)) 05F5E100h (Data to be written)

In the command section, the value is shown as below:

02h 02h C003h 5800h 8001h 05F5E100h

To this command, if the response is shown as below:

02h 02h 0000h

It indicates a normal end.

■ Measurement Setting 2 (common to all TASKs)

| Unit No. | Data No. | Parameter | Setting range/output range | Remarks |
|----------|----------|------------------------------------|---|----------|
| 78h | 00h | Non-measurement settings | 0: Keep 1: Clamp | |
| | 01h | Output at CLAMP | 0: MAX 1: 20mA 2: 12mA 3: 4mA 4: MIN | |
| 79h | 00h | Hysteresis width | 0 to 999999999 (nm) | |
| | 01h | Timer mode | 0: OFF 1: OFF DELAY 2: ON DELAY 3: 1 shot | |
| | 02h | Delay time | 1 to 5000 (ms) | |
| 7Ah | 02h | Monitor focus mode | 0: OFF, 1: ON | (Note 4) |
| | 03h | Monitor focus distance value 1 | -999999999 to 999999999 (nm) | |
| | 04h | Monitor focus distance value 2 | -999999999 to 999999999 (nm) | |
| | 05h | Monitor focus current value 1 | 4 to 20 (mA) | |
| | 06h | Monitor focus current value 2 | 4 to 20 (mA) | |
| | 07h | Monitor focus voltage value 1 | -10 to 10 (V) | |
| | 08h | Monitor focus voltage value 2 | -10 to 10 (V) | |
| 7Eh | 04h | Input polarity of external input 0 | 0: L active 1: H active | |
| | 05h | Input polarity of external input 1 | | |
| | 06h | Input polarity of external input 2 | | |
| | 07h | Input polarity of external input 3 | | |
| 7Fh | 01h | External Input (IN) function mode | 0: Standard 1: Bank | |
| | 06h | Digital output target | 0: OFF 1: ON | |
| | 0Ah | External input 0 mode | 0: Not used 1: Trigger 2: Hold reset 3: Laser OFF 4: Zero-reset | (Note 5) |
| | 0Bh | External input 1 mode | | |
| | 0Ch | External input 2 mode | | |
| | 0Dh | External Input 3 mode | | |
| F0h | 08h | External input mode | 0: STANDARD 2: Parallel input OFF mode | |
| | C0h | Timing input | 0: OFF 1: ON | |
| | C1h | Reset input | 0: OFF 1: ON | |
| | C2h | LD-OFF input | 0: OFF 1: ON | |
| | C3h | Zero-reset execution | 1: Execution | |
| | C4h | Zero-reset cancel | 1: Cancel | |

(Note 4)

To change the monitor focus setting, monitor focus mode must be ON.

For example, to change the current setting of the monitor focus, change parameters below:

- Monitor focus mode (ON)
- Monitor focus distance value 1
- Monitor focus distance value 2
- Monitor focus current value 1
- Monitor focus current value 2

In addition, set outputs (current and voltage), which are set by the analog output switch in the controller.

(Note 5)

External input 0 mode and External input 1 mode settings cannot be changed because they automatically function as bank inputs when the bank mode is used (when “external input (IN) function mode” is set to “bank”).

(Note 6)

When the external input mode is set to “STANDARD”, the controller enters into the status below:

- * External input of the controller is enabled,
- * Commands from timing input to zero-resetting are disabled.

When the external input mode is set to “Parallel input OFF”, the controller enters into the status below:

- * External input of the controller is enabled,
- * Commands from timing input to zero-resetting are disabled.

Therefore, to send a command related to inputs, the external input mode should be set to “Parallel input OFF.”

Once ON is written to the timing input, reset input, and LD-OFF input parameters, the ON state is kept until OFF is written next.

Controller operates in the same manner as the input state is kept ON.

However, special care shall be taken because the operation changes depending on the state of external input line to the controller when the external input mode is set back to the “standard mode.” Operations are performed depending on the settings when “Execution” or “Cancel” is written to the parameter with respect to the zero-reset.

Example 1: To perform zero-reset (when ZS-LDC is 1CH):

The command sending sequence is as follows:

- (1) Write “parallel input OFF mode” to the “external input mode” parameter.
- (2) Write “execution” to the “zero-reset execution” parameter.
- (3) Write “STANDARD” to the “external input mode” parameter.

An actual example of a command procedure is shown below:

- (1) 02h 02h C008h F001h 8001h 00000002h
- (2) 02h 02h C0C3h F001h 8001h 00000001h
- (3) 02h 02h C008h F001h 8001h 00000000h

Writing commands (1) and (3) above before and after the input-related operation command, respectively, is recommended.

Parameter List (ZS-HLDC)

■ Sensing Setting (common for all TASKs)

| Unit No. | Data No. | Parameter | Setting range/output range | Remarks |
|----------|---|----------------------------|--|-----------------------------|
| 0h | 0h | Measurement mode | 0: STANDARD 1: HI-RESO 2: HI-SPEED 3: HI-SENS 4: CUSTOM | When multi-task mode is OFF |
| | | Measurement mode | 1: STANDARD 2: HI-RESO 3: HI-SENS 4: CUSTOM | When multi-task mode is ON |
| | Ch | Start position of area 1 | 0 to 639 (pix) | |
| | Eh | End position of area 1 | 0 to 639 (pix) | |
| | Dh | Start line of area 1 | 0 to (Number of additional lines - 1) | |
| | Fh | End line of area 1 | 0 to (Number of additional lines - 1) | |
| | 18h | Start position of area 2 | 0 to 639 (pix) | |
| | 1Ah | End position of area 2 | 0 to 639 (pix) | |
| | 19h | Start line of area 2 | 0 to (Number of additional lines - 1) | |
| | 1Ah | End line of area 2 | 0 to (Number of additional lines - 1) | |
| | 12h | Exposure time | 2 to 200 (1div:0.1ms) When multi-task mode is OFF | Parameters for CUSTOM mode |
| | | | 5 to 200 (1div:0.1ms) When multi-task mode is ON | |
| | 13h | Number of additional lines | 1 to 200 When multi-task mode is OFF | |
| | | | 8 to 200 When multi-task mode is ON | |
| | 14h | Line skipping | 0: OFF | |
| | | | 1: ON | |
| | 16h | 2-area mode | 0: OFF | |
| | | | 1: ON | |
| | 17h | Compensation mode | 0: OFF 1: Start position compensation 2: End position compensation 3: Start/end position compensation | |
| 20h | Measurement cycle | 112 to 20000 (us) | | |
| C0h | Reference point teach for compensation mode | 1: Execute teach | | |
| C1h | 2-area teach | 1: Execute teach | | |
| 1h | 0h | Head installation | 0: Diffuse 1: Regular | |
| 2h | 0h | LD power mode | 0: Auto 1: Auto-scale 2: Fixed | |

Section 3
Setting Value Obtaining and Changing Command

| Unit No. | Data No. | Parameter | Setting range/output range | Remarks |
|----------|----------|---|---|--|
| | 2h | Surface to be controlled for light amount | 0: Peak 1: First surface 2: Second surface 3: Third surface | |
| | 6h | LD power when fixed | 0 to 800 (1div:0.1%) | |
| 2h | Dh | Lower limit of LD power | 0 to 800 (1div:0.1%) | |
| | Eh | Upper limit of LD power | 0 to 800 (1div:0.1%) | |
| | 20h | Incident level | 0 to 4095 (1div:0.1%) | |
| | 24h | LD power | 0 to 800 (1div:0.1%) | |
| | 25h | Incident level (First surface) | 0 to 4095 (1div:0.1%) | |
| | 26h | Incident level (Second surface) | 0 to 4095 (1div:0.1%) | |
| | 27h | Incident level (Third surface) | 0 to 4095 (1div:0.1%) | |
| 3h | 0h | Measuring object | 0: Normal 1: PCB 2: Mirror 3: Glass 4: Glass thickness | |
| | 2h | GLASS/GLASS THICKNESS mode | 0: Mode 1 1: Mode 2 | |
| | 3h | Image smoothing level | 0: No filter 1: Filter size 2 2: Filter size 4 3: Filter size 8 4: Filter size 16 | When the measurement object is changed, the settings are initialized according to the selected object. |
| | 4h | Background removing level before addition | 0 to 255 (tone) | |
| | 6h | Edge threshold | 0: 0% 1: 12.5% 2: 25% 3: 37.5% 4: 50% 5: 62.5% 6: 75% 7: 87.5% | |
| 4h | 0h | Mutual interference prevention mode | 0: OFF 1: ON | |
| | 1h | Mutual interference prevention timing | 0: Timing A 1: Timing B | |
| 5h | 0h | Gain setting | 1 to 5 | |
| 28h | 0h | Measurement mode | 0: OFF 1: Average 2: Peak 3: Bottom 4: Thickness 5: Gap 6: K+mX;+nY | TASK1 settings. The settings in Unit Number 28h are valid only for multi-task mode. |

| Unit No. | Data No. | Parameter | Setting range/output range | Remarks |
|----------|----------|--|---|-----------------|
| | 3h | Parameter X | 0: None 1: TASK1 2: TASK2 3: TASK3 4: TASK4 | |
| 28h | 4h | Parameter Y | 0: None 1: TASK1 2: TASK2 3: TASK3 4: TASK4 | |
| | 5h | Parameter K | -999999999 to 999999999 | |
| | 8h | Parameter M | -100 to 100 (1div:0.1%) | |
| | 9h | Parameter N | -100 to 100 (1div:0.1%) | |
| | 1h | Surface for measurement (Area 1) | 0: First surface 1: Second surface 2: Third surface | |
| | Ah | Surface for measurement (Area 2) | 0: First surface 1: Second surface 2: Third surface | |
| | Bh | Measurement position 1 (for thickness measurement) | 0: None 1: Average 2: Peak 3: Bottom | |
| | Ch | Measurement position 2 (for thickness measurement) | 0: None 1: Average 2: Peak 3: Bottom | |
| | Dh | Measurement area | 0: Area 1 1: Area 2 | |
| | Eh | Width of peak bottom | 0 to 255 | |
| | 20h | Measurement value (First surface) | - (nm) | |
| | 21h | Measurement value (Second surface) | - (nm) | |
| | 22h | Measurement value (Third surface) | - (nm) | |
| 29h | 0h | Scaling mode | 0: OFF 1: ON | |
| | 1h | Span value | -20000 to 20000 (1div:0.0001) | |
| | 2h | Offset value | -999999999 to 999999999 (nm) | |
| 2Ah | 2h | Smooth | 0: OFF 1: ON | TASK1 settings. |

Section 3
Setting Value Obtaining and Changing Command

| Unit No. | Data No. | Parameter | Setting range/output range | Remarks |
|----------|----------|------------------------|--|------------------------------|
| 2Bh | 2h | Average | 0: 1 time 1: 2 times 2: 4 times 3: 8 times 4: 16 times 5: 32 times 6: 64 times 7: 128 times 8: 256 times 9: 512 times 10: 1024 times 11: 2048 times 12: 4096 times | |
| 2Ch | 2h | Differential | 0: OFF 1: ON | |
| | 3h | Differentiation cycles | 1 to 5000 (ms) | |
| 2Dh | 2h | Hold type | 0: Through 1: Peak 2: Bottom 3: Peak to peak 4: Average 5: Sampling | |
| | 3h | Trigger method | 0: External input 1: Self up 2: Self down | |
| | 4h | Trigger level | -999999999 to 999999999 (nm) | |
| | 5h | Trigger hysteresis | 0 to 999999999 (nm) | |
| | 6h | Trigger delay (ms) | 0 to 5000 (ms) | |
| | 7h | Sampling time (ms) | 1 to 5000 (ms) | |
| | 8h | Trigger delay mode | 0: OFF 1: ON | |
| | 2Eh | 5h | Offset at zero reset | -999999999 to 999999999 (nm) |
| 7h | | Zero reset mode | 0: Real 1: Hold | |
| 40h | | Status | 0: OFF 1: ON | |

Section 3

Unit No. and Parameter No.

(*)

If GLASS/MODE 2 or GLASS THICKNESS/MODE 2 is selected, a process using multiple tasks will be performed, as in multi-task mode.

The following processes are assigned to the respective tasks:

| | |
|--------------|---|
| TASK1 | Calculates Area 1 displacement value |
| TASK2 | Calculates Area 2 displacement value |
| TASK3 | GLASS: Calculates the result of the NEAR side of TASK 1 and TASK 2. |
| | GALSS THICKNESS: Calculates the difference value between TASK1 and TASK2. |
| TASK4 | Unused |

The measurement conditions can be set for each task in this mode.

| Unit No. | Data No. | Parameter | Setting range/output range | Remarks |
|----------|----------|--------------------------------|--|--------------------------|
| 78h | 0h | Hysteresis width | 0 to 999999999 (nm) | Setting judgment process |
| | 1h | Timer mode | 0: OFF 1: OFF-Delay 2: ON-Delay 3: One shot | |
| | 2h | Delay time | 1 to 5000 (ms) | |
| | 3h | Judgment output TASK | 0: TASK1 1: TASK2 2: TASK3 3: TASK4 | |
| 79h | 0h | Non-measurement settings | 0: Keep 1: Clamp | |
| 7Ah | 2h | Monitor focus mode | 0: OFF, 1: ON | |
| | 3h | Monitor focus distance value 1 | -999999999 to 999999999 (nm) | |
| | 4h | Monitor focus distance value 2 | -999999999 to 999999999 (nm) | |
| | 5h | Monitor focus current value 1 | 4 to 20 (mA) | |
| | 6h | Monitor focus current value 2 | 4 to 20 (mA) | |
| | 7h | Monitor focus voltage value 1 | -10 to 10 (V) | |
| | 8h | Monitor focus voltage value 2 | -10 to 10 (V) | |
| | 15h | Output mode TASK | When multi-task mode is OFF 0: OFF 1: ON When multi-task mode is ON 0: OFF 1: TASK1 2: TASK2 3: TASK3 | |

Section 3
Setting Value Obtaining and Changing Command

| Unit No. | Data No. | Parameter | Setting range/output range | Remarks |
|--------------------------|----------|--------------------------------|--|---------|
| 7Ah | 17h | Output at CLAMP | Voltage output 0: MAX 1: 10V 2: 9V 3: 8V 4: 7V 5: 6V 6: 5V 7: 4V 8: 3V 9: 2V 10: 1V 11: 0V 12: -1V 13: -2V 14: -3V 15: -4V 16: -5V 17: -6V 18: -7V 19: -8V 20: -9V 21: -10V 22: MIN | |
| | | | Current output 0: MAX 1: 20mA 2: 19mA 3: 18mA 4: 17mA 5: 16mA 6: 15mA 7: 14mA 8: 13mA 9: 12mA 10: 11mA 11: 10mA 12: 9mA 13: 8mA 14: 7mA 15: 6mA 16: 5mA 17: 4mA | |
| 7Bh Digital Output | 2h | Monitor focus mode | 0: OFF, 1: ON | |
| | 3h | Monitor focus distance value 1 | -999999999 to 999999999 (nm) | |
| | 4h | Monitor focus distance value 2 | -999999999 to 999999999 (nm) | |
| | 5h | Monitor focus current value 1 | 0 to 65535 | |
| | 6h | Monitor focus current value 2 | 0 to 65535 | |
| | 7h | Clear Monitor Focus | 1: Clear | |
| | 8h | Output at CLAMP | 0 to 65535 | |

Section 3

Unit No. and Parameter No.

| Unit No. | Data No. | Parameter | Setting range/output range | Remarks |
|--------------------------|----------|---|---|----------------------------|
| 7Bh Digital Output | Ah | Output TASK(When the measurement value is output) | 0: TASK1 1: TASK2 2: TASK3 3: TASK4 4: Consecutively | |
| | Bh | Output mode | 0: OFF 1: Measurement value 2: Judgment | |
| | Ch | Update cycle | 1 to 100 | |
| 7Ch Logging | 5h | Mode | 0: OFF 1: ON | |
| | 3h | Buffering period | 1 to 65535 | |
| | 4h | Buffer size per item of data | 1 to 1000 | |
| | Eh | TASK1 | 0: OFF 1: ON | When multi-task mode is ON |
| | Fh | TASK2 | 0: OFF 1: ON | |
| | 10h | TASK3 | 0: OFF 1: ON | |
| 11h | TASK4 | 0: OFF 1: ON | | |
| 7Eh Link | 0h | Output TASK | 0: TASK1 1: TASK2 2: TASK3 3: TASK4 | |
| | 6h | Mode | 0: OFF 1: ON | |
| F0h Parallel Input | 4h | Input 0 | 0: Low Active 1: High Active | |
| | 5h | Input 1 | | |
| | 6h | Input 2 | | |
| | 7h | Input 3 | | |
| | 8h | External input mode | 0: Normal mode 1: Bank switching mode 2: Parallel IN off mode | |
| | 9h | Control TASK setting | 0: TASK1 1: TASK2 2: TASK3 3: TASK4 | |

Parameter List (ZS-MDC)

■ Input Setting (common to all TASKs)

| Unit No. | Data No. | Parameter | Setting range/output range | Remarks |
|----------|----------|-----------------------------|---------------------------------|-----------------|
| 00h | 00h | Data A input destination CH | 0 to 11 (CH) | |
| | 01h | Data B input destination CH | | |
| | 02h | Data C input destination CH | | |
| | 03h | Data D input destination CH | | |
| | 04h | Data E input destination CH | | |
| | 05h | Data F input destination CH | | |
| | 06h | Data G input destination CH | | |
| | 07h | Data H input destination CH | | |
| | 08h | Data I input destination CH | | |
| | 09h | Data A input mode | | 0: OFF 1: ON |
| | 0Ah | Data B input mode | | |
| | 0Bh | Data C input mode | | |
| | 0Ch | Data D input mode | | |
| | 0Dh | Data E input mode | | |
| | 0Eh | Data F input mode | | |
| | 0Fh | Data G input mode | | |
| | 10h | Data H input mode | | |
| | 11h | Data I input mode | | |
| | 20h | Obtained result A | -999999999 to 999999999 (nm) | |
| | 21h | Obtained result B | | |
| | 22h | Obtained result C | | |
| | 23h | Obtained result D | | |
| | 24h | Obtained result E | | |
| | 25h | Obtained result F | | |
| | 26h | Obtained result G | | |
| | 27h | Obtained result H | | |
| | 28h | Obtained result I | | |

Example 1: When assigning (writing) input A to CH3:

To assign input A to CH3, input destination CH of data A should be set to 3CH and input mode of data A should be ON.

- (1) For input destination CH of data A, both Unit No. and Data No. are 00h.
- (2) For input mode of data A, Unit No. and Data No. are 00h and 09h, respectively.

Therefore, commands to be sent are shown as below:

- (1) When 02h 02h (C000h + 00h (Data No.)) 00h(Unit No.) 00h (CH No.),
and (8000h + 1h (Number of Elements)) 00000003h (Data to be written),
Command is: 02h 02h C000h 0000h 8001h 00000003h.

To this command, if the response is shown as below:

02h 02h 0000h

It indicates a normal end.

- (2) In the same manner as above,

When 02h 02h (C000h + 09h (Data No.)) 00h(Unit No.) 00h (CH No.),
and (8000h + 1h (Number of Elements)) 00000001h (Data to be written),
Command is: 02h 02h C009h 0000h 8001h 00000001h.

To this command, if the response is shown as below:

02h 02h 0000h

It indicates a normal end.

■ Measurement Setting 1 (Setting per TASK)

| Unit No. (Note 1) | Data No. | Parameter | Setting range/output range | Remarks |
|----------------------|----------|-------------------------|--|---|
| 28h | 00h | Mode | 0: OFF 1: INDIV 2: OPERATION | |
| | 01h | Input selection | 0: Input A 1: Input B 2: Input C 3: Input D 4: Input E 5: Input F 6: Input G 7: Input H 8: Input I | Parameters when [Mode]=[INDIV] |
| | 02h | Expression | 0: THICKNESS (K-(X+Y)) 1: STEP (X-Y) 2: K+mX+nY 3: AVE 4: MAX-MIN | Parameters when [Mode]=[Operation] |
| | 03h | Calculation parameter X | 0: Input A 1: Input B 2: Input C 3: Input D 4: Input E 5: Input F | Parameters when [Expression]=[Thickness], [STEP], and [K+mX+nY] |
| | 04h | Calculation parameter Y | 6: Input G 7: Input H 8: Input I 9: TASK 1 10: TASK 2 11: TASK 3 12: TASK 4 | |
| | 05h | Calculation parameter K | -999999999 to 999999999 (nm) | Parameters when [Expression]=[K+mX+nY] |
| | 06h | Calculation parameter m | -100 to 100 (X0.1) | |
| | 07h | Calculation parameter n | -100 to 100 (X0.1) | |

| Unit No. (Note 1) | Data No. | Parameter | Setting range/output range | Remarks |
|----------------------|----------|-----------------------------------|---|---|
| 28h | 08h | Input A setting (AVE, MAX-MIN) | 0: OFF 1: ON | Parameters when [Expression]= [AVE] and [MAX-MIN] |
| | 09h | Input B setting (AVE, MAX-MIN) | | |
| | 0Ah | Input C setting (AVE, MAX-MIN) | | |
| | 0Bh | Input D setting (AVE, MAX-MIN) | | |
| | 0Ch | Input E setting (AVE, MAX-MIN) | | |
| | 0Dh | Input F setting (AVE, MAX-MIN) | | |
| | 0Eh | Input G setting (AVE, MAX-MIN) | | |
| | 0Fh | Input H setting (AVE, MAX-MIN) | | |
| | 10h | Input I setting (AVE, MAX-MIN) | | |
| | 11h | TASK 1 setting (AVE, MAX-MIN) | | |
| | 12h | TASK 2 setting (AVE, MAX-MIN) | | |
| | 13h | TASK 3 setting (AVE, MAX-MIN) | | |
| | 14h | TASK 4 setting (AVE, MAX-MIN) | | |
| | 15h | Thickness | | |
| 29h | 02h | Scaling mode | 0: OFF 1: ON | |
| | 03h | Span value | -20000 to 20000 (X0.0001) | |
| | 04h | Offset value | -999999999 to 999999999 (nm) | |
| 2Ah | 02h | Smooth | 0: OFF 1: ON | |
| 2Bh | 02h | Average number of times | 0: 1 1: 2 2: 4 3: 8 4: 16 5: 32 6: 64 7: 128 8: 256 9: 512 10: 1024 11: 2048 12: 4096 | |

Section 3
Setting Value Obtaining and Changing Command

| Unit No. (Note 1) | Data No. | Parameter | Setting range/output range | Remarks |
|----------------------|----------|--------------------------------|---|---------|
| 2Ch | 02h | Differential mode | 0: OFF 1: ON | |
| | 03h | Differentiation cycles | 1 to 5000 (ms) | |
| 2Dh | 02h | Hold mode | 0: OFF 1: PEAK 2: BOTTOM 3: P-P 4: AVERAGE 5: SAMPLE | |
| | 03h | Trigger method | 0: External 1: Self-up trigger 2: Self-down trigger | |
| | 04h | Trigger level | -999999999 to 999999999 (nm) | |
| | 05h | Trigger hysteresis | 0 to 999999999 (nm) | |
| | 06h | Trigger delay (ms) | 0 to 5000 (ms) | |
| | 07h | Sampling period (ms) | 1 to 5000 (ms) | |
| | 08h | Trigger delay mode | 0: OFF 1: ON | |
| 2Eh | 05h | Offset value for zero reset | -999999999 to 999999999 (nm) | |
| | 07h | Zero reset mode | 0: REAL 1: HOLD | |
| 30h | 02h | LOW threshold value | -999999999 to 999999999 (nm) | |
| | 03h | HIGH threshold value | -999999999 to 999999999 (nm) | |

(Note 1)

The Unit No. here indicates TASK 1 Unit No.

Unit No. other than the above, such as TASK2 or a later one, can be calculated by adding (TASK number -1) to the Unit No. and multiplying it by 14h for another reference or setting.

Example 1: When reading the setting values of the average number of times for TASK 1:

Since the average number of times is 2Bh for Unit No., and 02h for Data No., values are shown as below:

02h 01h (C000h + 02h (Data No.)) 2Bh (Unit No.) 00h (CH No.) (8000h + 1h (Number of elements))

In the command section, the value is shown as below:

02h 01h C002h 2B00h 8001h

To this command, if the response is shown as below:

02h 01h C002h 2B01h 8001h 00000004h

Since the value is 4, this indicates 16 times.

Example 2: When changing the high threshold value of TASK 4 to 100 mm:

Usually, the high threshold value is 30h for Unit No., and 03h for Data No.

However, Unit No. is 6Ch (= 30h + (4-1) x 14h) because TASK4 is set this time.

Besides, 100mm thickness is expressed as 05F5E100h in a hexadecimal number because 100 mm is 100,000,000nm.

02h 02h (C000h + 03h (Data No.)) 6Ch (Unit No.) 00h (CH No.)

and (8000h + 1h (Number of Elements)) 05F5E100h (Data to be written)

In the command section, the value is shown as below:

02h 02h C003h 6C00h 8001h 05F5E100h

To this command, if the response is shown as below:

02h 02h 0000h

It indicates a normal end.

■ Measurement Setting 2 (common to all TASKs)

| Unit No. | Data No. | Parameter | Setting range/ output range | Remarks |
|----------|----------|------------------------------------|--|----------|
| 78h | 00h | Non-measurement settings | 0: Keep 1: Clamp | |
| | 01h | Output upon clamp | 0: MAX 1: 20mA 2: 12mA 3: 4mA 4: MIN | |
| 79h | 00h | HYS | 0 to 999999999 (nm) | |
| | 01h | Timer mode | 0: OFF 1: OFF DELAY 2: ON DELAY 3: 1 shot | |
| | 02h | Delay time | 1 to 5000 (ms) | |
| 7Ah | 02h | Monitor focus mode | 0: OFF, 1: ON | (Note 2) |
| | 03h | Monitor focus distance value 1 | -999999999 to 999999999 (nm) | |
| | 04h | Monitor focus distance value 2 | -999999999 to 999999999 (nm) | |
| | 05h | Monitor focus current value 1 | 4 to 20 (mA) | |
| | 06h | Monitor focus current value 2 | 4 to 20 (mA) | |
| | 07h | Monitor focus voltage value 1 | -10 to 10 (V) | |
| | 08h | Monitor focus voltage value 2 | -10 to 10 (V) | |
| 7Dh | 04h | Input polarity of external input 0 | 0: L active 1: H active | |
| | 05h | Input polarity of external input 1 | | |
| | 06h | Input polarity of external input 2 | | |
| | 07h | Input polarity of external input 3 | | |
| 7Eh | 00h | External input (IN) | 0: None 1: TASK 1 2: TASK 2 3: TASK 3 4: TASK 4 5: TASK ALL | |
| | 01h | External Input (IN) function mode | 0: Standard 1: Bank | |
| | 02h | External output (OUT) | 0: None 1: TASK 1 2: TASK 2 3: TASK 3 4: TASK 4 | |

| Unit No. | Data No. | Parameter | Setting range/ output range | Remarks |
|----------|----------|-------------------------|---|---|
| 7Eh | 04h | Linear output (ANALOG) | 0: None 1: TASK 1 2: TASK 2 3: TASK 3 4: TASK 4 | |
| | 06h | Digital output target 1 | 0: None 1: TASK 1 2: TASK 2 3: TASK 3 4: TASK 4 5: Input A 6: Input B 7: Input C 8: Input D 9: Input E 10: Input F 11: Input G 12: Input H 13: Input I | |
| | 07h | Digital output target 2 | | |
| | 08h | Digital output target 3 | | |
| | 09h | Digital output target 4 | | |
| | 0Ah | Digital output target 5 | | |
| | 0Bh | Digital output target 6 | | |
| | 0Ch | Digital output target 7 | | |
| | 0Dh | Digital output target 8 | | |
| | 0Eh | Digital output target 9 | | |
| | 0Fh | External input 0 mode | | 0: Not used 1: Trigger 2: Hold reset 3: Laser OFF 4: Zero-reset |
| | 10h | External input 1 mode | | |
| | 11h | External input 2 mode | | |
| | 12h | External input 3 mode | | |
| F0h | 08h | External input mode | 0: STANDARD 2: Parallel input OFF mode | (Note 4) |
| | C0h | Timing input | 0: OFF 1: ON | |
| | C1h | Reset input | 0: OFF 1: ON | |
| | C2h | LD-OFF input | 0: OFF 1: ON | |
| | C3h | Zero-reset executed. | 1: Execution | |
| | C4h | Zero-reset cancel. | 1: Cancel | |

(Note 2)

To change the monitor focus setting, monitor focus mode must be ON.

For example, to change the current setting of the monitor focus, change parameters below:

- Monitor focus mode (ON)
- Monitor focus distance value 1
- Monitor focus distance value 2
- Monitor focus current value 1
- Monitor focus current value 2

In addition, set outputs (current and voltage), which are set by the analog output switch in the controller.

(Note 3)

External input 0 mode and External input 1 mode settings cannot be changed because they automatically function as bank inputs when the bank mode is used (when “external input (IN) function mode” is set to “bank”).

(Note 4)

When the external input mode is set to “STANDARD”, the controller enters into the status below:

- * External input of the controller is enabled,
- * Commands from timing input to zero-resetting are disabled.

When the external input mode is set to “Parallel input OFF”, the controller enters into the status below:

- * External input of the controller is enabled,
- * Commands from timing input to zero-resetting are disabled.

Therefore, to send a command related to inputs, the external input mode should be set to “Parallel input OFF.”

Once ON is written to the timing input, reset input, and LD-OFF input parameters, the ON state is kept until OFF is written next.

Controller operates in the same manner as the input state is kept ON.

However, special care shall be taken because the operation changes depending on the state of external input line to the controller when the external input mode is set back to the “standard mode.”

Operations are performed depending on the settings when “Execution” or “Cancel” is written to the parameter with respect to the zero-reset.

Example 1: To perform zero-reset:

The command sending sequence is as follows:

- (1) Write “parallel input OFF mode” to the “external input mode” parameter.
- (2) Write “execution” to the “zero-reset execution” parameter.
- (3) Write “STANDARD” to the “external input mode” parameter.

An actual example of a command procedure is shown below:

- (1) 02h 02h C008h F000h 8001h 00000002h
- (2) 02h 02h C0C3h F000h 8001h 00000001h
- (3) 02h 02h C008h F000h 8001h 00000000h

Writing commands (1) and (3) above before and after the input-related operation command, respectively, is recommended.

Parameter List (ZS-DSU)

| Unit No. | Data No. | Parameter | Setting range/ output range | Remarks |
|----------|----------|-------------------------|-----------------------------|--|
| 00h | 00h | Source A Input CH | 0: 1CH | |
| | 01h | Source B Input CH | 1: 2CH | |
| | 02h | Source C Input CH | 2: 3CH | |
| | 03h | Source D Input CH | 3: 4CH | |
| | 04h | Source E Input CH | 4: 5CH | |
| | 05h | Source F Input CH | 5: 6CH | |
| | 06h | Source G Input CH | 6: 7CH | |
| | 07h | Source H Input CH | 7: 8CH | |
| | 08h | Source I Input CH | 8: 9CH | |
| | 09h | Source J Input CH | 9: 10CH | |
| | 0Ah | Source K Input CH | 10: 11CH | |
| | 0Bh | Source L Input CH | 11: 12CH | |
| | 0Ch | Source M Input CH | 12: 13CH | |
| | 0Dh | Source N Input CH | 13: 14CH | |
| | 0Eh | Source A selection TASK | 0: TASK1 | Settings are valid when the gang-mounted controller is MDC . |
| | 0Fh | Source B selection TASK | 1: TASK2 | |
| | 10h | Source C selection TASK | 2: TASK3 | |
| | 11h | Source D selection TASK | 3: TASK4 | |
| | 12h | Source E selection TASK | 4: Input A | |
| | 13h | Source F selection TASK | 5: Input B | |
| | 14h | Source G selection TASK | 6: Input C | |
| | 15h | Source H selection TASK | 7: Input D | |
| | 16h | Source I selection TASK | 8: Input E | |
| | 17h | Source J selection TASK | 9: Input F | |
| | 18h | Source K selection TASK | 10: Input G | |
| | 19h | Source L selection TASK | 11: Input H | |
| | 1Ah | Source M selection TASK | 12: Input I | |
| | 1Bh | Source N selection TASK | | |
| | 1Ch | Source A save mode | 0: OFF | |
| | 1Dh | Source B save mode | 1: ON | |
| | 1Eh | Source C save mode | | |
| | 1Fh | Source D save mode | | |
| | 20h | Source E save mode | | |
| | 21h | Source F save mode | | |
| | 22h | Source G save mode | | |
| | 23h | Source H save mode | | |
| | 24h | Source I save mode | | |
| | 25h | Source J save mode | | |
| | 26h | Source K save mode | | |
| | 27h | Source L save mode | | |
| | 28h | Source M save mode | | |
| | 29h | Source N save mode | | |

Section 3
Setting Value Obtaining and Changing Command

| Unit No. | Data No. | Parameter | Setting range/output range | Remarks |
|----------|----------|---|--|---|
| 00h | 40h | Obtained result A | -999999999 to 999999999 (nm) | |
| | 41h | Obtained result B | | |
| | 42h | Obtained result C | | |
| | 43h | Obtained result D | | |
| | 44h | Obtained result E | | |
| | 45h | Obtained result F | | |
| | 46h | Obtained result G | | |
| | 47h | Obtained result H | | |
| | 48h | Obtained result I | | |
| | 49h | Obtained result J | | |
| | 4Ah | Obtained result K | | |
| | 4Bh | Obtained result L | | |
| | 4Ch | Obtained result M | | |
| | 4Dh | Obtained result N | | |
| 01h | 00h | Start trigger mode | 0: Button 1: External input 2: Data 3: Window 4: I/O 5: Time | |
| | 01h | Start trigger, trigger edge polarity | 0: UP 1: DOWN | |
| | 02h | Start trigger, data selection | 0: Source A 1: Source B 2: Source C 3: Source D 4: Source E 5: Source F 6: Source G 7: Source H 8: Source I 9: Source J 10: Source K 11: Source L 12: Source M | |
| | 03h | Start trigger, delay | -9999 to 9999 (ms) (*1) -127 to 127 (Number of images) (*2) | (*1) [Save image] is set to OFF. (*2) [Save image] is set to ON. |
| | 04h | Start trigger, data threshold | -999999999 to 999999999 (nm) | |
| | 06h | Start trigger, window mode | 0: Window-in 1: Window-out | |
| | 07h | Start trigger, window upper limit value | -999999999 to 999999999 (nm) | |
| | 08h | Start trigger, window lower limit value | -999999999 to 999999999 (nm) | |

Section 3

Unit No. and Parameter No.

| Unit No. | Data No. | Parameter | Setting range/output range | Remarks |
|----------|----------|---|--|---|
| 01h | 0Ah | Start trigger, I/O result, I/O selection | 0: IN 0 1: IN 1 2: IN 2 3: IN 3 4: OUT 0 5: OUT 1 6: OUT 2 7: OUT 3 8: OUT 4 | |
| 0Ch | 0Ch | End trigger mode | 0: Button 1: External input 2: Data 3: Window 4: I/O 5: Time 6: QUANT 7: Time | When [Save image] is set to ON, [TIME] is not available. |
| 01h | 0Dh | End trigger, trigger edge polarity | Same as start trigger | |
| | 0Eh | End trigger, data selection | | |
| | 0Fh | End trigger, data threshold | | |
| | 11h | End trigger, window mode | | |
| | 12h | End trigger, window upper limit | | |
| | 13h | End trigger, window lower limit | | |
| | 15h | End trigger, I/O result, I/O selection | | |
| | 18h | End trigger, number of logging data items | 1 to 999999 (*1) 1 to 128 (*2) | (*1) [Save image] is set to OFF. (*2) [Save image] is set to ON. |
| 02h | 00h | Save mode | 0: 1 SHOT 1: REPEAT | When [Save image] is set to ON, [REPEAT] is not available. |
| | 01h | Repeat mode | 0: NEW 1: ADD 2: OVER WR | When [Save image] is set to ON, [ADD] is not available. |
| | 02h | Repeat end condition | 0: None 1: Number of triggers 2: Time (time-out) | |
| | 03h | Repeat end condition, number of triggers | 1 to 100000 (times) | |
| | 06h | Interval of saving image | 0: All 1: Save NG | It is available only if [Save image] is set to ON. |
| | 07h | NG save mode | 0: OR 1: AND | |
| | 08h | Save image mode | 0: Standard 1: Latest | |

Section 3 Setting Value Obtaining and Changing Command

| Unit No. | Data No. | Parameter | Setting range/output range | Remarks |
|----------|----------|------------------------|----------------------------|---------|
| 03h | 01h | I/O data | 0: NONE 1: SAVE | |
| | 02h | Save direction (ALIGN) | 0: COLUMN 1: ROW | |
| | 03h | Line feed input | 0: Ignored 1: Enabled | |

* About label input and time setting
The label input and time setting cannot be set or referred to.

■ Judgment-related

| Unit No. | Data No. | Parameter | Setting range/output range | Remarks |
|----------|----------|-----------------------------|--|---------|
| 28h | 00h | Input source | 0: Source A 1: Source B 2: Source C 3: Source D 4: Source E 5: Source F 6: Source G 7: Source H 8: Source I 9: Source J 10: Source K 11: Source L 12: Source M 13: Source N | |
| 28h | 01h | Threshold lower limit value | -999999999 to 999999999 (nm) | |
| 28h | 02h | Threshold upper limit value | -999999999 to 999999999 (nm) | |

■ For Image Logging

| Unit No. | Data No. | Parameter | Setting range/output range | Remarks |
|----------|----------|-------------|---|---------|
| 14h | 00h | Align image | 0: None 1: 1CH 2: 2CH 3: 3CH 4: 4CH 5: 5CH 6: 6CH 7: 7CH 8: 8CH 9: 9CH 10: 10CH 11: 11CH 12: 12CH 13: 13CH 14: 14CH | |
| 14h | 01h | Save image | 0: OFF 1: ON | |

Section 4

How to Obtain Flow Data

| | | |
|---|---|------|
| ▣ | <u>About Obtaining Flow Data</u> | 4-2 |
| ▣ | <u>Setting Procedures for Data Obtaining Conditions</u> | 4-3 |
| ▣ | <u>Setting Parameters</u> | 4-8 |
| | Buffer Size and Buffer Interval | 4-8 |
| | Logging Data Type | 4-8 |
| ▣ | <u>Flow Data Response</u> | 4-11 |
| | Format | 4-11 |
| | Composition of Response | 4-11 |

About Obtaining Flow Data

■ What is flow data?

In the ZS series, a high-speed sampling measurement at a maximum of 110 microseconds is implemented. To handle the measurement data with external devices, it is necessary to obtain a large volume of data. The ZS series provides a system to handle measurement data as a bunch of any number of data items and to obtain data in units of bunches. A bunch of data is called flow data.

■ Process to obtain flow data

A data items bunch is transmitted as flow data output upon full data accumulation specified by buffer size (a maximum of 1000 data items) if a flow data obtaining command has been received. A data recipient (such as a personal computer) must issue a command in advance of full measurement data accumulation specified by buffer size to the ZS controller.

Commands and data items are exchanged between a data recipient and the ZS controller as shown in the flow chart below:

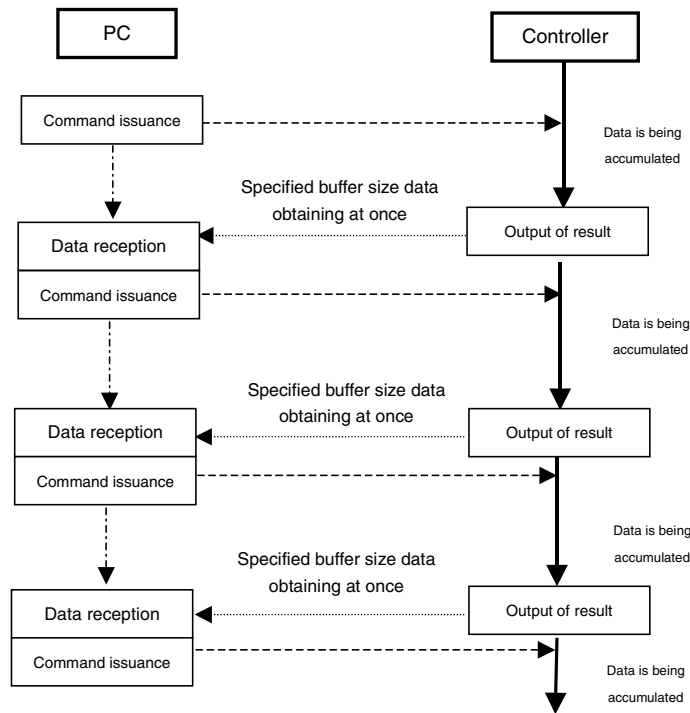

CHECK!

The previous data is overwritten upon full measurement data accumulation specified by buffer size in the ZS controller if no command has been received.

In this case, an error flag appears as buffer overflow occurs. A data recipient (such as a personal computer) must confirm whether or not a command is properly issued in time by observing this flag.

Setting Procedures for Data Obtaining Conditions

Follow the procedures below to set the data obtaining conditions:

Note that setting conditions described in this section are cleared upon turning OFF the power of the controller. (Set the threshold values again.)

The all data obtaining conditions set here are written using the parameter area write command. When setting, refer to the corresponding tables in "Unit No." and "Data No.", command examples described in Section 3, and the description of the parameter area write in Section 2.

1. Set the accumulation mode to ON.

Set the flow data accumulation mode to ON (=1). Make sure to set this value to ON (or write 1 to this value) in advance of obtaining data because flow data is not accumulated unless this setting is made. Specifically, write ON (=1) to Data No. 2 of Unit No.124 (=7Ch). (*)

Example: When writing the above command to ZS-MDC (0CH), a command to be sent is shown as below:

```
02h 02h C002h 7C00h 8001h 00000001
```

(*)

A measurement cycle changes from 112 microseconds to 142 microseconds upon setting the accumulation mode to ON when the ZS-LDC is used in the high speed mode. That is to say, the LDC itself as a single unit cannot obtain measurement data at every 112 microseconds via communications. To obtain the measurement data at every 112 microseconds, use a composition of ZS-LDC and ZS-MDC to obtain the measurement data from ZS-LDC via ZS-MDC.

2. Set the target data to be obtained.

Controllers have accumulation areas from “accumulation data 1” through “accumulation data 9” in the software. (*)

First, set the data to be accumulated in the respective area. Specifically, write the Parameter No., which corresponds to the data to be accumulated, to Data No. 5 through 13 of Unit No. 124 (=7Ch). (*)

(*)

The example here describes the case of ZS-MDC. In the case of ZS-LDC, Data No. 5 to 7 can be specified because only accumulate data areas from 1 to 3 exist.

Example: When writing data items: TASK1, TASK2, and input A to accumulate data 1, accumulate data 2, and accumulate data 3, respectively, for the ZS-MDC (0Ch), a command to be sent is shown as below:

```
02h 02h C005h 7C00h 8001h 00000001h } (Accumulate data 1=TASK1)
02h 02h C006h 7C00h 8001h 00000002h } (Accumulate data 2=TASK2)
02h 02h C007h 7C00h 8001h 00000005h } (Accumulate data 3=Input A)
02h 02h C008h 7C00h 8001h 00000000h }
02h 02h C009h 7C00h 8001h 00000000h }
      :                               (Accumulate data 4 to 13 = no accumulation)
02h 02h C00Dh 7C00h 8001h 00000000h
```

3. Read a measurement cycle.

Read the current measurement cycle.

Measurement cycle information is necessary to execute step 4, “Specify the buffer interval.”

The measurement cycle information must be obtained again in this step because it may vary depending on the settings specified in the steps 1 and 2 above.

Example: When reading the measurement cycle to the ZS-MDC (0ch), a command to be sent is shown as below:

```
01h 01h 81h 0000h 00h 0002h
```

You will find that the measurement cycle is 269 microseconds (=010Dh) when the response is returned as below:

```
01h 01h 0000h 0000010Dh
```

4. Specify the buffer interval.

A number of skips, which is referred to as a “buffer interval”, can be set to the controller upon data accumulation. Calculate and set an optimal value according to the sampling interval to be obtained.

For example, to set the sampling interval to 100ms when the current measurement cycle is 269 μ s, set the buffer interval to 371 (=372-1), which is calculated by the following formula:

$$100\text{ms}/269\mu\text{s}=371.747\dots (*)$$

(*)

Set the most approximate value to the sampling interval to be obtained because the sampling interval can be set only to the multiple number of measurement cycles as shown above.

The buffer interval value can be calculated by subtracting 1 from the value calculated using the formula above because the buffer interval must be the number of skips to be executed.

Example: When writing the buffer interval (=371) to ZS-MDC (0CH), a command to be sent is shown below:

02h 02h C003h 7C00h 8001h 00000173h (371(dec) = 1F4(hex))

5. Set the number of data items to be accumulated.

Set the number of data items to be batch-obtained.

Because the number of data items specified in this step is the one for the respective accumulation data area, the number of data items to be batch-obtained can be calculated as shown below when three types of data items are obtained as in the example above:

Number of data items specified in this step x 3

Example: When setting the number of data items to be accumulated (=500) to ZS-MDC (0CH), a command to be sent is shown below:

02h 02h C004h 7C00h 8001h 000001F4h (500(dec) = 1F4(hex))

6. Request and receive data.

Setting is completed.

All the data items are returned at once when the flow data request command is sent in the status above.

Example: When sending a request command to the ZS-MDC (0ch), the command is shown as below:

01h 01h E1h 0000h 00h 0001h

(No area is assigned for the specification of command send destination channel in the flow data request command. The CH of USB cable connection destination is the channel of command transmission destination.)

Because the flow data belongs to the “variable area reading” commands, the response follows their format. However, note that only the contents of the “data to be read” follow the format below:

(*)

In addition, whether or not the command ends cannot be judged by ETX specified based on the CompoWay/F because the data to be read is composed by binary data. Confirming the completion of data reception with the number obtained is recommended.

The number of data items to be received can be calculated using the formula specified in the step above: Data type (target data to be obtained) x Number of data items to be accumulated.

[About Continual Data Obtaining]

Note that sending a request command is necessary after starting the data reception until the next data accumulation is completed as described in “How to obtain flow data.”

Calculate the time for the completion of the accumulation using the formula specified in the step above: measurement cycle x number of data items to be accumulated, and send the next request command until the calculated time expires.

Example: When measurement cycle=269 μ s and the number of data items to be accumulated=500:

It will take 134.5 ms (=269 μ s x 500) until the accumulation is completed.

Sending the next request command before the time above expires is necessary.

The “flow data overflow bit,” which is described in Section, “Data Composition of Flow Data” and other sections, is enabled when sending a command is delayed due to the delay of processing at the master side of the communication devices, such as a personal computer.

(In this case, the continuity of data is lost.) Check the processing delay if the bit is enabled or not.

When the processing delay occurred due to the personal computer specification, adjustments below must be performed:

- Increase the buffer interval and decrease the number of data items per unit time.
- Increase the number of data items to be accumulated and lessen the frequency of communication processing.

Flow data is returned from controller upon completion of the data accumulation. Therefore, flow data is immediately returned after sending a command when data accumulation has already been completed upon sending a command. Response is not performed unless the data accumulation is completed upon sending a command.

Setting Parameters

This section describes buffer size, buffer interval, and logging data.

Buffer Size and Buffer Interval

Buffer size of the measurement data to be accumulated in the ZS controller and its buffer interval can be changed. To change buffer size and buffer interval, change the parameters below:

* Use DATAGET and DATASET commands to change and view the parameter.

| Unit No. | Data No. | Parameter | Details |
|----------|----------|-----------------------------|-----------------|
| 7Ch | 2h | Flow data accumulation mode | 0: OFF 1: ON |
| | 3h | Buffer interval | 1 to 65535 |
| | 4h | Buffer size | 1 to 1000 |

Logging Data Type

Data to be accumulated in the ZS controller can be selected.

■ When using ZS-LDC

Up to 3 data types can be accumulated.

| Unit No. | Data No. | Parameter | Details |
|----------|----------|---------------------|---------|
| 7Ch | 5h | Accumulation data 1 | * |
| | 6h | Accumulation data 2 | |
| | 7h | Accumulation data 3 | |

* Setting varies depending on the measurement mode.

- When "THICK/GAP - FILM/OTHERS - TRANSFER" mode is selected

| Value | Details |
|-------|---------------------|
| 0 | No accumulation |
| 1 | Result of area 1 |
| 2 | Result of area 2 |
| 3 | Thickness/gap value |

- When a mode other than above is selected

| Value | Details |
|-------|---------------------------------------|
| 0 | No accumulation |
| 1 | Distance value (measurement value) |

■ When using ZS-HLDC

- When multi-task mode is OFF
 - When GLASS/MODE 2 or GLASS THICKNESS/MODE 2 is selected for the measurement object

| Unit No. | Data No. | Parameter | Details |
|----------|----------|-----------|--|
| 7Ch | 5h | 0 | No accumulation |
| | | 1 | Accumulation of result of area 1 |
| | | 2 | Accumulation of result of area 2 |
| | | 3 | Accumulation of result of glass surface or glass thickness |

- When a mode other than the above is selected for the measurement object

| Unit No. | Data No. | Parameter | Details |
|----------|----------|-----------|-----------------|
| 7Ch | 5h | 0 | No accumulation |
| | | 1 | Accumulation |

- When multi-task mode is ON

| Unit No. | Data No. | Parameter | Details |
|----------|----------|-----------|--|
| 7Ch | Eh | 0 | Does not accumulate the result of TASK1. |
| | | 1 | Accumulates the result of TASK1. |
| | Fh | 0 | Does not accumulate the result of TASK2. |
| | | 1 | Accumulates the result of TASK2. |
| | 10h | 0 | Does not accumulate the result of TASK3. |
| | | 1 | Accumulates the result of TASK3. |
| | 11h | 0 | Does not accumulate the result of TASK4. |
| | | 1 | Accumulates the result of TASK4. |

- When a mode other than the above is selected

| Value | Details |
|-------|---------------------------------------|
| 0 | No accumulation |
| 1 | Distance value (Measurement value) |

■ When using ZS-MDC

Up to 9 data types can be accumulated.

| Unit No. | Data No. | Parameter | Details |
|----------|----------|---------------------|--|
| 7Ch | 5h | Accumulation data 1 | 0: No accumulation 1: Measurement result of TASK 1 2: TASK 2 3: TASK 3 4: TASK 4 5: Input A 6: Input B 7: Input C 8: Input D 9: Input E 10: Input F 11: Input G 12: Input H 13: Input I |
| | 6h | Accumulation data 2 | |
| | 7h | Accumulation data 3 | |
| | 8h | Accumulation data 4 | |
| | 9h | Accumulation data 5 | |
| | 10Ah | Accumulation data 6 | |
| | 11Bh | Accumulation data 7 | |
| | 12Ch | Accumulation data 8 | |
| | 13Dh | Accumulation data 9 | |



Increasing the accumulation data lengthens the measurement cycle of the ZS controller.
Check the "System - Information - Cycle" after setting.

Flow Data Response

This section describes the format and composition of response of flow data.

Format

Binary data is output in the format below after outputting the flow data obtaining command.

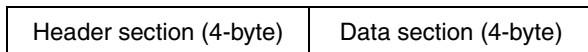

For details, refer to “Composition of Flow Data.”



Response data of the flow data is composed by binary data for the purpose of giving top priority to speed. Therefore, response data may not be received by generic communication tools, such as hyper terminal.

Composition of Response

| FlowDATA 1 packet | | | | | | | | | | | | |
|-------------------|----------|---|---|---|----------|---|---|----------|---|---|---|--------------|
| Header section | | | | | | | | | | | | Data section |
| 1st byte | 2nd byte | | | | 3rd byte | | | 4th byte | | | | - |
| A | B | C | D | E | F | G | H | I | J | K | L | Data |
| 8 | 1 | 1 | 2 | 4 | 5 | 1 | 2 | 1 | 1 | 1 | 5 | 32 |

Meaning of data
Number of bits

= Total
64 bits

■ Details of Header Section

| Data | Name | Details |
|------|---------------------------|--|
| A | Not used | Reserved bit |
| B | FlowDATA Overflow bit | NORMAL, 0 : 1 is set when flow data accumulation overflows. |
| C | Decimal point information | NORMAL, 0 : 0: nm order, 1: μ m order |
| D | TASK No. | TASK1 to TASK4 (*1) |
| E | Channel No. | Channel No. of the data source |
| F | Unit status (input) | Indicates ON/OFF status of each input wire. (*2) |
| G | FlowData stop bit | <ul style="list-style-type: none"> All the data items are 1 when no flow data is sent afterward (or always 1 upon single request). All the data items are 0 when flow data is continuously sent afterward (after the continual flow data request until it is stopped). |
| H | TASK judgment result bit | Indicates the judgment result for the TASK of the data source. (*3) |
| I | Use prohibited | Reserved bit |
| J | | |
| K | | |
| L | Unit status (output) | Indicates output status (measurement result status) (*4) |
| Data | Measurement data | Signed 32-bit data When the decimal point information section is 0: data in the unit of nm When the decimal point information section is 1: data in the unit of μ m |

*1 TASK No. = bit data + 1

Example: When bit data=10B=2(dec)

It indicates as TASK3 data.

*2 The input wires are assigned from the lower bit as:

When ZS is used;

- Input terminal 4 (Unused, always 0)

- Input terminal 3

- Input terminal 2

- Input terminal 1

- Input terminal 0

(5 outputs in total)

*3 Data items and statuses to be received are shown below:

00b = unexecuted

01b = LOW

10b = PASS

11b = HIGH

*4 The output statuses are assigned from the lower bit as:

When ZS is used;

- Output terminal 4 (Busy output)

- Output terminal 3 (Enable output)

- Output terminal 2 (Low output)

- Output terminal 1 (Pass output)

- Output terminal 0 (High output)

(5 outputs in total)

Standard status is described in the parentheses.

Revision History

| Revision code | Date | Revised contents |
|---------------|-----------|---|
| A | Apr. 2004 | Original production |
| B | Oct. 2004 | Commands compatible with ZS-LDC (v2.000), ZS-MDC (v2.000), and ZS-DSU (v1.000) are added and matched. |
| C | Dec. 2004 | "Section 4 How to Obtain Flow Data" is added. |
| D | June 2004 | <ul style="list-style-type: none">• Commands and parameters compatible with ZS-DSU (v2.000) are added.• Multiple controllers connection with ZFV is added. |
| E | Oct. 2005 | <ul style="list-style-type: none">• Commands and parameters compatible with ZS-HLDC are added. |