

F160-2

Vision Sensor

**Manual 2:
CONVERSATIONAL
MENU
OPERATION MANUAL**

OMRON

READ AND UNDERSTAND THIS DOCUMENT

Please read and understand this document before using the products. Please consult your OMRON representative if you have any questions or comments.

WARRANTY

OMRON's exclusive warranty is that the products are free from defects in materials and workmanship for a period of one year (or other period if specified) from date of sale by OMRON.

OMRON MAKES NO WARRANTY OR REPRESENTATION, EXPRESS OR IMPLIED, REGARDING NON-INFRINGEMENT, MERCHANTABILITY, OR FITNESS FOR PARTICULAR PURPOSE OF THE PRODUCTS. ANY BUYER OR USER ACKNOWLEDGES THAT THE BUYER OR USER ALONE HAS DETERMINED THAT THE PRODUCTS WILL SUITABLY MEET THE REQUIREMENTS OF THEIR INTENDED USE. OMRON DISCLAIMS ALL OTHER WARRANTIES, EXPRESS OR IMPLIED.

LIMITATIONS OF LIABILITY

OMRON SHALL NOT BE RESPONSIBLE FOR SPECIAL, INDIRECT, OR CONSEQUENTIAL DAMAGES, LOSS OF PROFITS OR COMMERCIAL LOSS IN ANY WAY CONNECTED WITH THE PRODUCTS, WHETHER SUCH CLAIM IS BASED ON CONTRACT, WARRANTY, NEGLIGENCE, OR STRICT LIABILITY.

In no event shall responsibility of OMRON for any act exceed the individual price of the product on which liability is asserted.

IN NO EVENT SHALL OMRON BE RESPONSIBLE FOR WARRANTY, REPAIR, OR OTHER CLAIMS REGARDING THE PRODUCTS UNLESS OMRON'S ANALYSIS CONFIRMS THAT THE PRODUCTS WERE PROPERLY HANDLED, STORED, INSTALLED, AND MAINTAINED AND NOT SUBJECT TO CONTAMINATION, ABUSE, MISUSE, OR INAPPROPRIATE MODIFICATION OR REPAIR.

SUITABILITY FOR USE

OMRON shall not be responsible for conformity with any standards, codes, or regulations that apply to the combination of products in the customer's application or use of the product.

At the customer's request, OMRON will provide applicable third party certification documents identifying ratings and limitations of use that apply to the products. This information by itself is not sufficient for a complete determination of the suitability of the products in combination with the end product, machine, system, or other application or use.

The following are some examples of applications for which particular attention must be given. This is not intended to be an exhaustive list of all possible uses of the products, nor is it intended to imply that the uses listed may be suitable for the products:

- Outdoor use, uses involving potential chemical contamination or electrical interference, or conditions or uses not described in this document.
- Nuclear energy control systems, combustion systems, railroad systems, aviation systems, medical equipment, amusement machines, vehicles, safety equipment, and installations subject to separate industry or government regulations.
- Systems, machines, and equipment that could present a risk to life or property.

Please know and observe all prohibitions of use applicable to the products.

NEVER USE THE PRODUCTS FOR AN APPLICATION INVOLVING SERIOUS RISK TO LIFE OR PROPERTY WITHOUT ENSURING THAT THE SYSTEM AS A WHOLE HAS BEEN DESIGNED TO ADDRESS THE RISKS, AND THAT THE OMRON PRODUCT IS PROPERLY RATED AND INSTALLED FOR THE INTENDED USE WITHIN THE OVERALL EQUIPMENT OR SYSTEM.

PERFORMANCE DATA

Performance data given in this document is provided as a guide for the user in determining suitability and does not constitute a warranty. It may represent the result of OMRON's test conditions, and the users must correlate it to actual application requirements. Actual performance is subject to the OMRON Warranty and Limitations of Liability.

CHANGE IN SPECIFICATIONS

Product specifications and accessories may be changed at any time based on improvements and other reasons.

It is our practice to change model numbers when published ratings or features are changed, or when significant construction changes are made. However, some specifications of the product may be changed without any notice. When in doubt, special model numbers may be assigned to fix or establish key specifications for your application on your request. Please consult with your OMRON representative at any time to confirm actual specifications of purchased products.

DIMENSIONS AND WEIGHTS

Dimensions and weights are nominal and are not to be used for manufacturing purposes, even when tolerances are shown.

ERRORS AND OMISSIONS

The information in this document has been carefully checked and is believed to be accurate; however, no responsibility is assumed for clerical, typographical, or proofreading errors, or omissions.

PROGRAMMABLE PRODUCTS

OMRON shall not be responsible for the user's programming of a programmable product, or any consequence thereof.

COPYRIGHT AND COPY PERMISSION

This document shall not be copied for sales or promotions without permission.

This document is protected by copyright and is intended solely for use in conjunction with the product. Please notify us before copying or reproducing this document in any manner, for any other purpose. If copying or transmitting this document to another, please copy or transmit it in its entirety.

F160-2 Vision Sensor

Manual 2: Conversational Menu Operation Manual

Revised July 2004

Notice:

OMRON products are manufactured for use according to proper procedures by a qualified operator and only for the purposes described in this manual.

The following conventions are used to indicate and classify precautions in this manual. Always heed the information provided with them. Failure to heed precautions can result in injury to people or damage to property.

 **DANGER** Indicates an imminently hazardous situation which, if not avoided, will result in death or serious injury.

 **WARNING** Indicates a potentially hazardous situation which, if not avoided, could result in death or serious injury.

 **Caution** Indicates a potentially hazardous situation which, if not avoided, may result in minor or moderate injury, or property damage.

OMRON Product References

All OMRON products are capitalized in this manual. The word “Unit” is also capitalized when it refers to an OMRON product, regardless of whether or not it appears in the proper name of the product.

Visual Aids

The following headings appear in the left column of the manual to help you locate different types of information.

Note Indicates information of particular interest for efficient and convenient operation of the product.

1,2,3... 1. Indicates lists of one sort or another, such as procedures, checklists, etc.

Precaution Indicates information required to take full advantage of the functions and performance of the product. Incorrect application methods may result in the loss of damage or damage to the product. Read and follow all precautionary information.

CHECK Indicates points that are important in using product functions or in application procedures.

TwoCamera Indicates information required when using a 2-camera system.

SeeAlso Indicates where to find related information.

HELP Indicates information helpful in operation, such as the definition of terms.

© OMRON, 2003

All rights reserved. No part of this publication may be reproduced, stored in a retrieval system, or transmitted, in any form, or by any means, mechanical, electronic, photocopying, recording, or otherwise, without the prior written permission of OMRON.

No patent liability is assumed with respect to the use of the information contained herein. Moreover, because OMRON is constantly striving to improve its high-quality products, the information contained in this manual is subject to change without notice. Every precaution has been taken in the preparation of this manual. Nevertheless, OMRON assumes no responsibility for errors or omissions. Neither is any liability assumed for damages resulting from the use of the information contained in this publication.

TABLE OF CONTENTS

SECTION 1

Features of Conversational Menus	1
1-1 Vision Sensors	2
1-2 Inspection Types	3
1-3 Advantages of Conversational Menus	7
1-4 Useful Features	8
1-5 Operational Flow	9

SECTION 2

Basic Operations	11
2-1 Starting the F160 and Displaying Images	12
2-2 Menu Operations	14
2-3 Understanding Setting Operations	21
2-4 Saving Settings and Exiting the F160	44

SECTION 3

Designing Inspections for Specific Applications	47
3-1 Conformity	48
3-2 Orientation	50
3-3 Position	52
3-4 Dimension	57
3-5 Chips and Burs	62
3-6 Surface	63

SECTION 4

Application Settings	65
4-1 Changing and Clearing Inspection Conditions	66
4-2 Changing Scenes and Scene Groups	71
4-3 Backing Up Data	78
4-4 Checking Image Density Distribution: Line Brightness	88
4-5 Checking I/O Status with External Devices	90
4-6 Memory Card Operations	93

SECTION 5

System Settings	101
5-1 Entering System Mode	102
5-2 Camera Settings	102
5-3 Screen Display and Monitor	104
5-4 Customizing Operations	108
5-5 Setting Conditions for Saving Measurement Images	112
5-6 Using BUSY Signals	115

TABLE OF CONTENTS

5-7	Selecting Items to be Shown in Overall Judgements.	117
5-8	Setting Startup Conditions.	118
5-9	Setting the Calendar Date and Time (Date/Time)	119
5-10	Checking System Information	119
5-11	Changing to Expert Menus	120

SECTION 6

Troubleshooting 123

6-1	Troubleshooting	124
6-2	FAQ	126

Appendices

A	Menus	127
B	Training Samples	129

Index. 131

Revision History 137

About this Manual:

This manual describes operating procedures for the F160 Vision Sensor using the Conversational Menus and it includes the sections described below. The Conversational Menus enable easily setting inspections by responding to queries provided on the screen.

This is one of four manuals used to operate the F160. Refer to the following table for the contents of each manual.

Manual	Contents	Cat. No.
1: Setup Manual	Provides information on system hardware and installation. Be sure to read this manual first.	Z170
2: Conversational Menu Operation Manual	Describes operation of the F160 using the Conversational Menus. The Conversational Menus enable the simplest operation based on registered images of acceptable and unacceptable products.	Z171
3: Expert Menu Operation Manual	Describes operation of the F160 using the Expert Menus. The Expert Menu enable application of all F160 capabilities, including setting region images and criteria.	Z173
4: Communications Reference Manual	Describes the communications settings and communications protocol used to transfer data through the parallel interface or serial interface.	Z172

Please read the above manuals carefully and be sure you understand the information provided before attempting to install or operate the F160.

Section 1 Features of Conversational Menus describes the features of the Conversational Menus and the types of inspections that are possible.

Section 2 Basic Operations describes the basic operations of the Conversational Menus.

Section 3 Designing Inspections for Specific Applications describes the six inspection methods not described in *2-3 Understanding Setting Operations*. The other inspection method, presence inspections, are explained in *2-3 Understanding Setting Operations*.

Section 4 Application Settings describes how to change, delete, and save inspection settings and how to use various functions with Conversational Menus

Section 5 System Settings describes how to set conditions related to the system environment. Refer to the Communications Reference Manual for information on communications specifications.

Section 6 Troubleshooting provides information on troubleshooting and a list of frequently asked questions.

 **WARNING** Failure to read and understand the information provided in this manual may result in personal injury or death, damage to the product, or product failure. Please read each section in its entirety and be sure you understand the information provided in the section and related sections before attempting any of the procedures or operations given.

SECTION 1

Features of Conversational Menus

This section describes the features of the Conversational Menus and the types of inspections that are possible.

1-1	Vision Sensors	2
1-2	Inspection Types	3
1-3	Advantages of Conversational Menus	7
1-4	Useful Features	8
1-5	Operational Flow	9

1-1 Vision Sensors

Vision Sensors work in place of the human eye to perform inspections by processing images using cameras. The visual inspections can be automated and complicated inspections can be performed accurately at high speeds.

The OMRON F160 Vision Sensor helps create production lines with a highly efficient inspection system, which is important to meet current demands for small-lot, variable-product production, produce greater added-value, and improve product quality.

Using the F160 yields a high return on investments by ensuring the following benefits:

- Repetitive work is reduced.
- More complicated, more precise inspections are possible.
- Inspection data management is easier (CIM, GMP, ISO9000).
- Working hours can be shortened.
- Less 3-D work (difficult, dirty, dangerous) is required.
- Work can be performed by less experienced staff.

1-2 Inspection Types

Presence

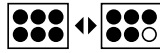

Presence inspections detect whether a component, mark, hole, etc., is at a specified position on the workpiece.

SeeAlso Refer to page 28.

Inspecting for the Presence of a Medical Tablet

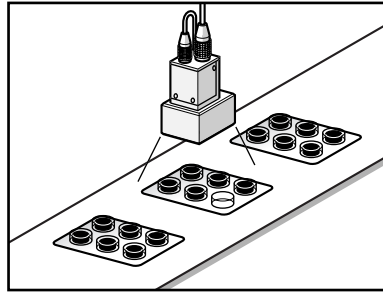

- Inspections for labels.
- Inspections for electronic parts on PCBs.
- Inspections for soldering on PCBs.

Conformity

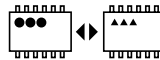

Conformity inspections check whether or not the workpiece matches a registered product image.

SeeAlso Refer to page 48.

Inspecting for Package Conformity

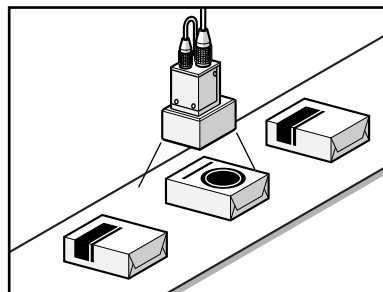

- Model checks based on grading marks.
- IC model checks based on number of leads.
- Model checks based on shape.

Orientation

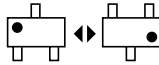

Orientation inspections detect the orientation of the workpiece to see if it is facing correctly.

SeeAlso Refer to page 50.

Checking Label Orientation

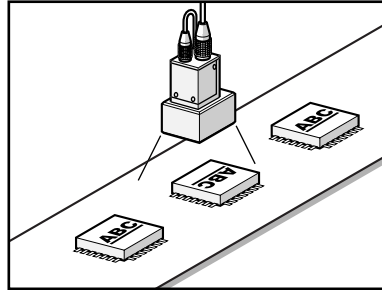

- Checks for IC orientation and front/back positioning.

Position

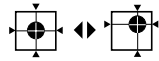

Position inspections find the position of a specified mark, hole, or other feature and determine whether or not it is within the correct range.

SeeAlso Refer to page 52.

Inspecting for Label Displacement

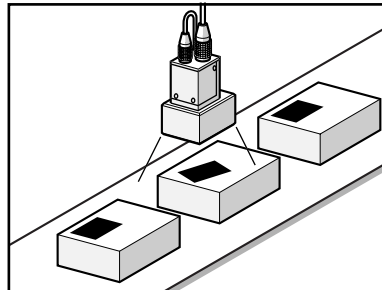

- Checks for printing displacement.
- Checks for registration marks on liquid crystal.
- Position checks for PCBs.
- Position checks for screw holes.

Dimensions



Dimension inspections check the relationship between two specified points and determine whether or not the distance between the two points is within the correct range.

SeeAlso Refer to page 57.

Checking Bolt Length

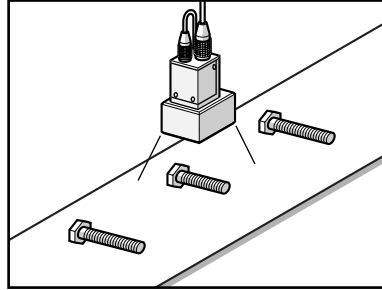

- Dimension checks for molded products, such as connectors.
- Inspections for pin pitch of capacitors.

Chips and Burs



Chip and burr inspections check for chips and burrs on the profile and circumference of workpieces.

SeeAlso Refer to page 62.

Inspecting for Chips and Burrs on O Rings

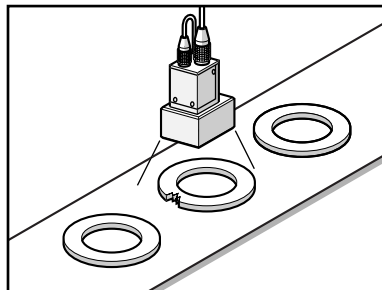

- Inspections for chips and burrs on plastic molded parts.

Surfaces



Surface inspections check for defects and impurities within a specified range.

SeeAlso Refer to page 63.

Checking for Marks on Sheets

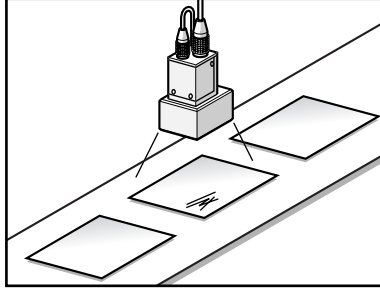

- Checks for pin holes
- Checks for bubbles on liquid crystal panels.
- Checks for cracks in cast items.
- Checks for impurities in liquids.

1-3 Advantages of Conversational Menus

Operating guidance is given on the monitor screen and settings can be made easily by entering information as requested - just as though you are having a conversation with the F160. Try the Conversational Menu if using a Visual Sensor for the first time or if you want to set the inspection conditions simply.

Displays settings sequence

You can grasp what stage you are at as you proceed.

Guides operation

The F160 tells you what the next procedure is.

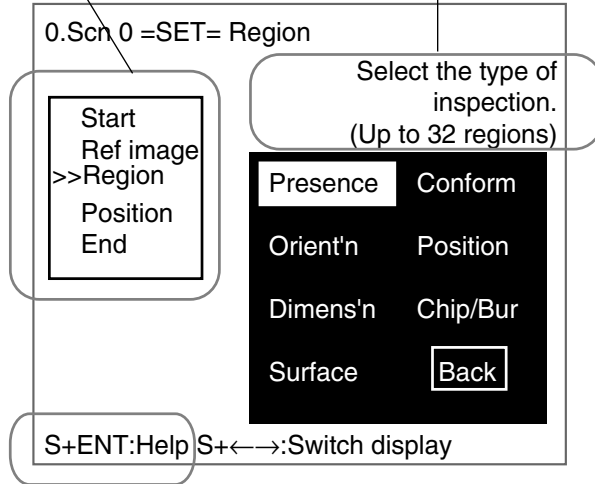

Go to the Help Screen if you are unsure

The F160 has comprehensive Help Screens that give greater understanding of and hints for settings operations.

Help Screen Example

● Presence Inspection

Determines if a component, mark, hole, etc. is at a set position on the workpiece.

1-4 Useful Features

The F160 provides the following features to enable more accurate and faster inspections. Refer to the reference pages for details and operating procedures.

Adjust Lighting Areas and Brightness from the F160

This function is supported only when Intelligent Lighting is connected.

SeeAlso Refer to page 25.

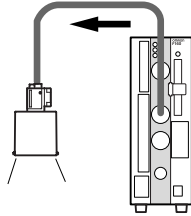

Save Up to 35 NG Images

Past NG results can be checked on the screen. Once the power is turned OFF, however, the saved images will be cleared. The saved images can be backed up to a computer.

SeeAlso Refer to page 112.

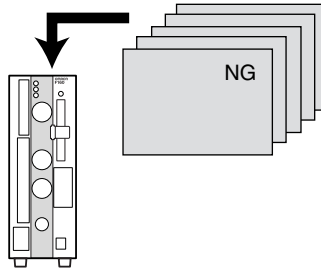

Change Measurement Setups Smoothly

If the scene function is used, 32 sets of inspection conditions can be set. If the scene group function is used, the setting capacity can be expanded up to 1,024 scenes. The measurement setup can be changed easily for different types of measurement objects simply by changing the scene.

SeeAlso Refer to page 71.

Input Measurement Triggers and Output Judgement Results via a Parallel Interface

SeeAlso Refer to the *Communications Reference Manual*.

Back Up Settings on a Computer or Memory Card

SeeAlso Refer to page 78.

Manipulate F160 Menus from a Computer

SeeAlso Refer to the *Communications Reference Manual*.

1-5 Operational Flow

Preparations

Turn ON the power supply.

The inspection object will appear on the monitor.

SeeAlso Refer to page 12 for information on starting the F160 and displaying images.

Set Detection Conditions

CHECK To learn about the basic operational flow from setting inspection conditions to measurement, refer to page 21.

- 1,2,3...**
1. Enter Set Mode. (Refer to *Starting Conversational Menus* on page 21.)
 2. Register the reference image. (Refer to *Registering Reference Images* on page 22.)
 3. Set the detection conditions for presence inspection. (Refer to *Selecting and Setting Inspection Types* on page 28.)
 4. Compensate for workpiece position displacement. (Refer to *Inconsistent Workpiece Positions* on page 31.)
 5. Select the measurement method that suits the inspection target.

SeeAlso

Refer to page 48 for information on conformity inspections.
Refer to page 50 for information on orientation inspections.
Refer to page 52 for information on position inspections.
Refer to page 57 for information on dimension inspections.
Refer to page 62 for information on chip and bur inspections.
Refer to page 63 for information on surface inspections.

Confirm Settings and Execute Measurement

- 1,2,3...**
1. Perform tests and make fine adjustments to measurement conditions. (Refer to *Entering Monitor Mode and Testing* on page 35.)
 2. Start measurement. (Refer to *Entering Run Mode and Starting Inspections* on page 43.)

Error Messages

When an error message has been displayed on the screen, refer to *Troubleshooting* on page 124.

Troubleshooting

If you think that there may be a malfunction, refer to *FAQ* on page 126 or refer to the *Setup Manual*.

Changing, Adding, and Deleting Settings

Change, add, or delete the inspection position referring to *Changing and Clearing Inspection Conditions* on page 66.

Saving Settings

- Save the inspection conditions. (Refer to *Saving Settings and Exiting the F160* on page 44.)
- Back up the image and system scene data. (Refer to *Backing Up Data* on page 78.)

Applied Setting Operations

- Set the measurement conditions by model type. (Refer to *Changing Scenes and Scene Groups* on page 71.)
- Set the system environment conditions. (Refer to *System Settings* on page 101.)
- Initialize the set inspection conditions. (Refer to *Initializing Measurement Conditions: Clearing Scenes* on page 75.)
- Set the communications specifications and I/O format for the external device. (Refer to the *Communications Reference Manual*.)

SECTION 2

Basic Operations

This section describes the basic operations of the Conversational Menus.

2-1	Starting the F160 and Displaying Images	12
2-1-1	Starting the Conversational Menus	12
2-1-2	Displaying Images and Focussing	13
2-2	Menu Operations	14
2-2-1	Screen Displays	14
2-2-2	Key Operations for Input Devices	16
2-2-3	Drawing Figures	18
2-2-4	Inputting Values	19
2-2-5	Inputting Characters	20
2-3	Understanding Setting Operations	21
2-3-1	STEP 1: Starting Conversational Menus	21
2-3-2	STEP 2: Registering Reference Images	22
2-3-3	STEP 3: Selecting and Setting Inspection Types	28
2-3-4	STEP 4: Inconsistent Workpiece Positions	31
2-3-5	STEP 5: Entering Monitor Mode and Testing	35
2-3-6	STEP 6: Entering Run Mode and Starting Inspections	43
2-4	Saving Settings and Exiting the F160	44

2-1 Starting the F160 and Displaying Images

This section describes how to start the F160 Conversational Menu and how to display images on the monitor. Refer to the displayed image when adjusting the Camera position and focus.

2-1-1 Starting the Conversational Menu

1. Check that the basic F160 components have been connected properly.

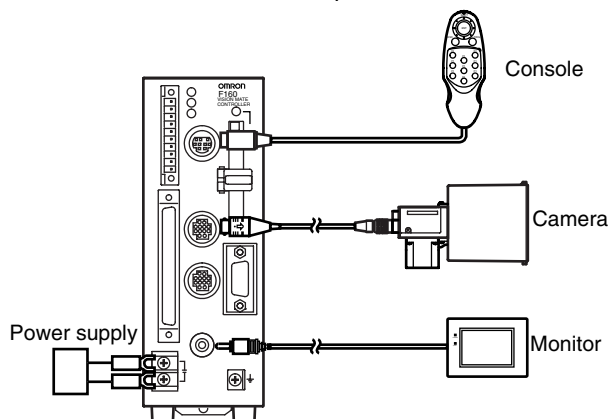

CHECK

Before connecting components or wiring power supply lines and grounding wires, be sure to refer to the relevant section in the *Setup Manual*.

SeeAlso

Refer to the *Setup Manual*.

2. Turn ON the power supply to the monitor.
3. Turn ON the power supply on the F160.

The Select Menu Screen will be displayed.

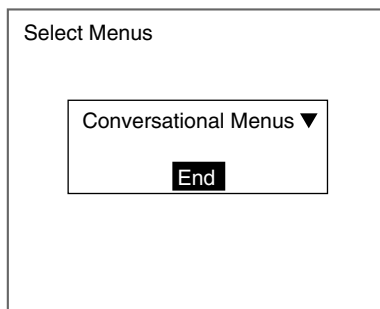

4. Check that **Conversational Menu** is selected and press the **ENT** Key. After a short pause, the Camera Settings Screen will be displayed.

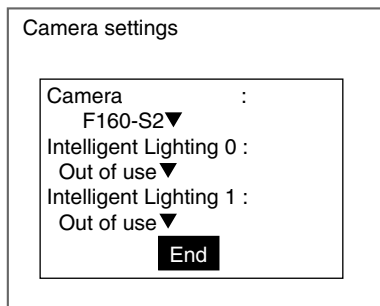

- SeeAlso** Refer to page 102 for information on the Camera Settings Screen.
5. Select the Camera model to be connected.
 6. When using Intelligent Lighting, select the model.
 7. Select **END**.

The Basic Screen for the Conversational Menu will be displayed.

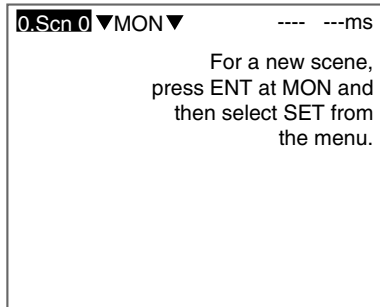

CHECK When the settings have been completed, it is useful to use Startup Mode when actually operating the F160. Startup Mode is used to set the startup conditions (display screen) when the F160 is next started. For example, set the F160 to start in Run Mode. This will allow measurements to be started immediately and will make day-to-day operations easier. (Refer to page 118.)

CHECK You can select whether or not to display the Select Menus or Camera Settings Screens when starting the F160. (Refer to page 118.)

2-1-2 Displaying Images and Focussing

1. Check that the inspection object is displayed on the monitor screen.

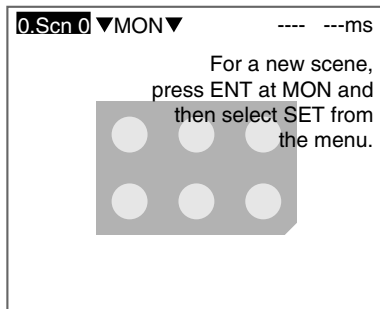

If it is not displayed, adjust the position of the inspection object so that it appears in the center of the monitor screen.

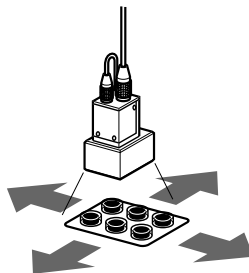

Adjusting the position of the inspection object.

2. Focus the Camera.

Cameras with a Light Source (Including Intelligent Lighting)

Lenses have a fixed focal point. Adjust the Camera position based on the positioning distances in the *Setup Manual* to focus the Camera.

CHECK The light level for Intelligent Lighting can be adjusted from the F160. The level can be changed from the screen where the reference image is registered in Set Mode. (Refer to page 25.)

Using Cameras without Lighting

Turn the focus ring to focus the Camera.

CHECK Camera Shutter Speed
Change the shutter speed if the object is moving quickly, causing the image to be blurred. The shutter speed can be changed from the screen where the reference image is registered in Set Mode. (Refer to page 24.)

2-2 Menu Operations

The F160 is operated by selecting functions displayed on the screen. Familiarize yourself with each function before operating the F160.

2-2-1 Screen Displays

Basic Screen Configuration

The scene number is displayed.

There are 32 scenes. Setting different measurement conditions for each scene allows easy switching between different setups.

Mode (See note 1.)

The current operating mode is displayed.

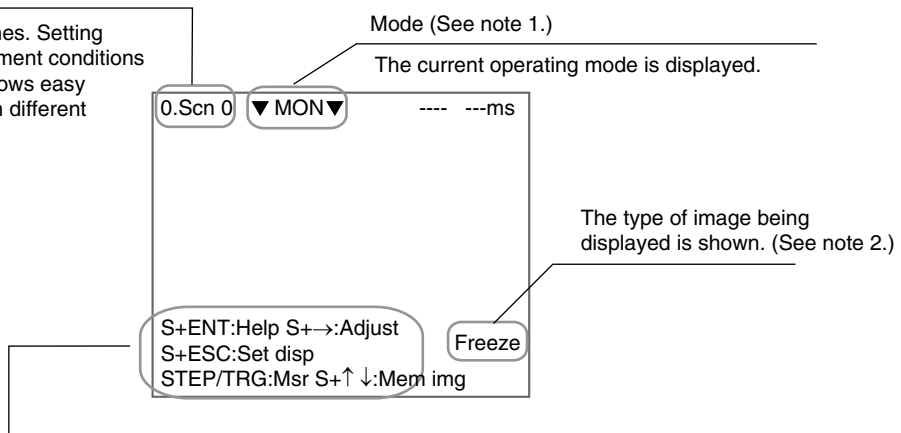

The type of image being displayed is shown. (See note 2.)

The Console Keys that can be used on the screen currently displayed and the roles of those keys is displayed.

S indicates the SHIFT Key.

S + ENT indicates that the ENT Key should be pressed while holding down the SHIFT Key.

(Refer to page 16.)

Note 1: Modes

Display	Meaning
SET	Sets the inspection conditions.
MON (Monitor)	Checks whether inspection is being performed correctly under the set inspection conditions. The measurement results are displayed on the monitor only. The results cannot be output to external devices.
RUN	Performs inspection. The measurement results are output to an external device via a parallel interface.
SYS (System)	Sets system conditions for the F160.

Display	Meaning
TOOL	Has data backup and Memory Card menus. Saves settings and images to a computer or Memory Card as backup.
SAVE	Saves data to flash memory. If new settings have been made, be sure to save the data before quitting.

Note 2: Display Images

SeeAlso Refer to page 104.

Display	Meaning
Through	The latest image taken by the Camera is displayed directly.
Freeze	A still of the image taken by the Camera is displayed.
... Memory□□	The previously saved measurement images are displayed. Up to 36 screens can be saved by the F160 and they are saved in order from 0 to 35.

Screen Configuration for Conversational Menus

The settings sequence for Conversational Menus is displayed. >> indicates the current setting step.

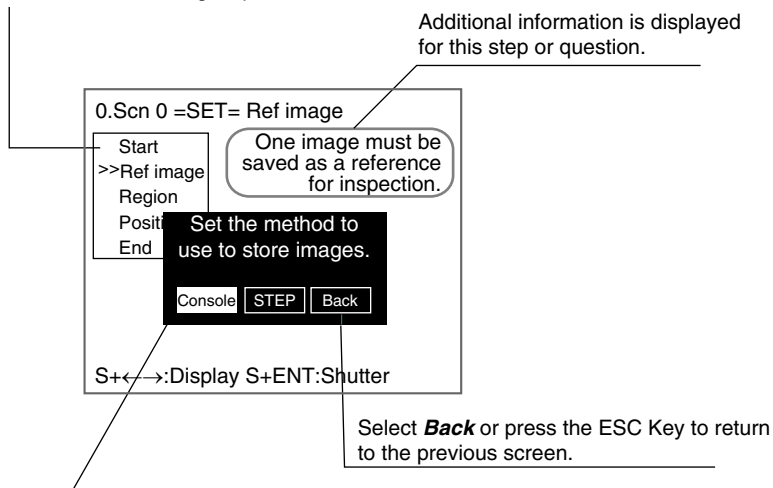

Questions or instructions from the F160 are displayed. Possible selections are given in boxes.

CHECK The message box is displayed in black to make it easier to read the messages. When you want to check the whole screen image, use the following procedure to change the message display conditions.

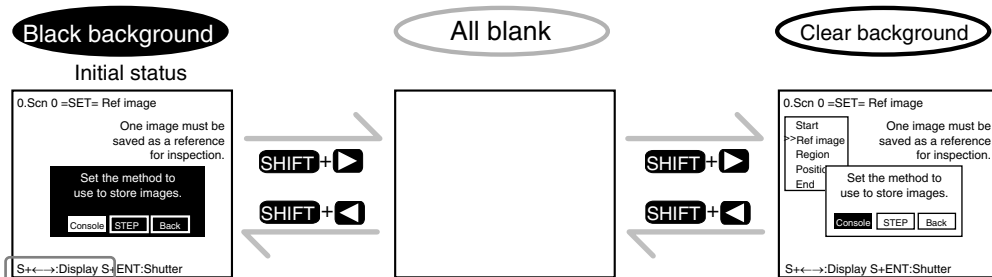

Use the S + Left and S + Right Keys to switch between message box display types on the current screen.

2-2-2 Key Operations for Input Devices

The menu operations are performed from the input device, called the Console.

The basic operations of the Console Keys are shown in the following diagram.

■ F160-KP Console

■ F150-KP Console

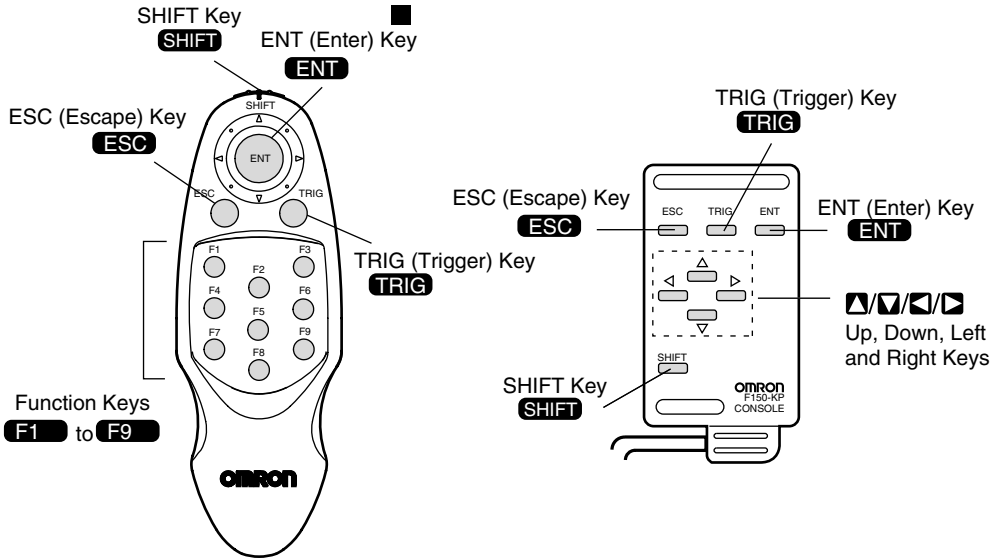

Key	Function
ESC: Escape Key	Returns the user to the previous menu display or operation.
TRIG: Trigger Key	Starts object measurement.
ENT: Enter Key	Executes a function or sets a value. Note: Also works as a Cursor Key for the F160-KP.
SHIFT Key	Must be pressed in combination with another key to have any effect. Specific functions are assigned to SHIFT + another key for specific screens.
Up, Down, Left and Right Keys	The Up and Down Keys are used to move the cursor up and down to set values. The Up Key will increase a value by 1 and the Down Key will decrease a value by 1. Continue pressing the Up or Down Key to quickly increase or decrease a value. The Left and Right Keys are used to move the cursor left or right.
Function Keys	F1 to F8: Not used The display capture function can be set to F9. Refer to page 108.

CHECK Menu operations can be performed from a personal computer via a serial interface in addition to from the Console Keys.

SeeAlso For details, refer to the *Communications Reference Manual*.

Operation Example

The following example shows how to use the Console Keys to operation the menus and how to enter Set Mode.

1. Press the **Right** Key once to move the cursor to **MON** and press the **ENT** Key.

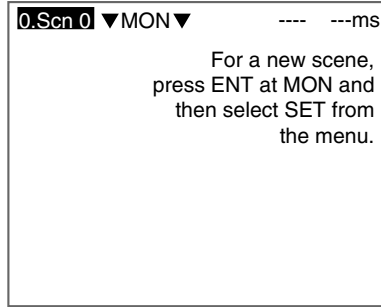

A list of modes will be displayed.

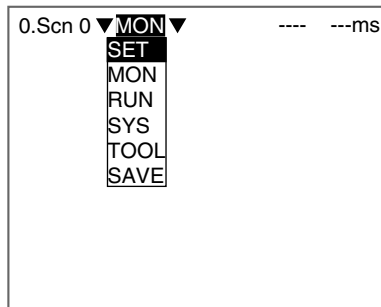

2. Use the **Up** and **Down** Keys to scroll up and down the list. To select Set Mode, move the cursor to **SET**.
3. Press the **ENT** Key. The mode at the cursor position, i.e., Set Mode will be selected. The F160 will enter Set Mode.

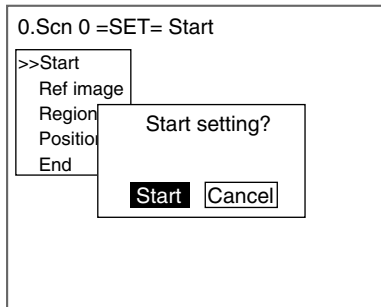





The initial screen for Set Mode for Conversational Menus will be displayed. To return to the previous screen, press the **ESC** Key.

2-2-3 Drawing Figures

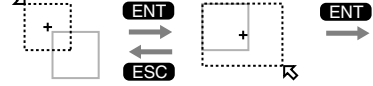
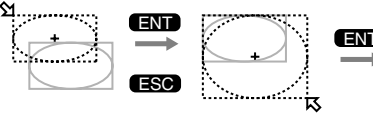
This section describes how to draw figures used to specify the region to be inspected.

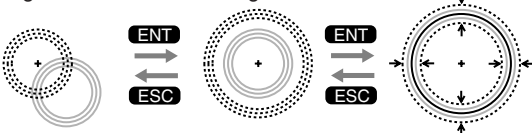
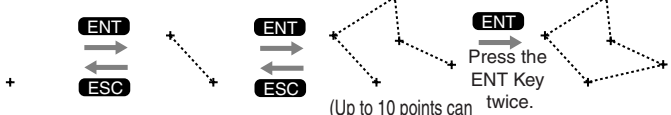
Move the cursor with the Up, Down, Left and Right Keys. Use together with the SHIFT Key to move the cursor quickly. Press the **ENT** Key at the desired positions and press the **ESC** Key to undo the setting.

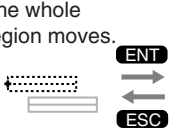
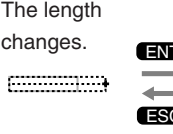
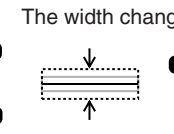
Measurement item	Figures that can be drawn	Drawing method				
Presence Conformity Orientation Surface (for boxes only)	Box	The whole region moves.	The lower right coordinates move.	 <p>The figure is set.</p>		
	Ellipse	The whole region moves.	The lower right coordinates move.	 <p>The figure is set.</p>		
	Circle	The whole region moves.	The circumference changes.	 <p>The figure is set.</p>		
	Circumference	The whole region moves.	The circumference changes.	The width changes.	 <p>The figure is set.</p>	
	Polygon	Specify the first point.	Specify the second point.	Specify the third and other points.	 <p>The figure is set. (Up to 10 points can be specified.)</p>	

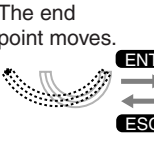
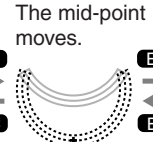
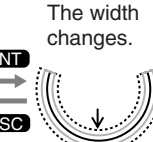
Measurement item	Figures that can be drawn	Drawing method
Chips and burs	Line	The whole region moves.  The length changes.  The width changes.  ENT → The figure is set.
	Arc	The whole region moves.  The end point moves.  The mid-point moves.  The width changes.  ENT → The figure is set.
	Circumference	Specify the center, diameter, and thickness. Refer to <i>Circumference</i> above.

2-2-4 Inputting Values

This section explains how to input values when setting measurement conditions or communications specifications.

1. Move the cursor to the item for which a value is to be changed.

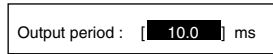

2. Press the **ENT** Key.

The cursor size will change to a cursor the size of a single digit.

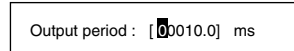

3. Use the **Left** and **Right** Keys to move the cursor.

Move the cursor to the digit to be changed.

4. Use the **Up** Key to increase the value.
Use the **Down** Key to decrease the value.

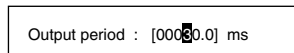

Repeat steps 3 and 4 to change other values.

5. Press the **ENT** Key.

The values will be set.



2-2-5 Inputting Characters

This section explains how to input characters. The software keyboard shown below is displayed on the screen where characters are input.

A	B	C	D	E	F	G	H	I	J	K	L	M	N
O	P	Q	R	S	T	U	V	W	X	Y	Z		
a	b	c	d	e	f	g	h	i	j	k	l	m	n
o	p	q	r	s	t	u	v	w	x	y	z		
0	1	2	3	4	5	6	7	8	9	.	-	_	!
#	\$	%	'	()	^	`						
SPC DEL BS INS ← →													END

—These characters can be input.

SPC	Inserts a space.
DEL	Deletes 1 character to the right of the I cursor.
BS	Deletes 1 character to the left of the I cursor.
INS	Switches between insert (default)/overwrite.
←	Moves the I cursor to the left.
→	Moves the I cursor to the right.
END	Ends character input.

1. Move the cursor to the character to be input.

I cursor
Cursor

[I]

A	B	C	D	E	F	G	H	I	J	K	L	M	N
O	P	Q	R	S	T	U	V	W	X	Y	Z		
a	b	c	d	e	f	g	h	i	j	k	l	m	n
o	p	q	r	s	t	u	v	w	x	y	z		
0	1	2	3	4	5	6	7	8	9	.	-	_	!
#	\$	%	'	()	^	`						
SPC DEL BS INS ← →													END

2. Press the **ENT** Key.

The character is set and the I cursor moves one space to the right.

[LI]

A	B	C	D	E	F	G	H	I	J	K	L	M	N
O	P	Q	R	S	T	U	V	W	X	Y	Z		

3. Repeat these steps to input more characters.
4. Once all required characters have been input, move the cursor to **END**.

[LABELI]

A	B	C	D	E	F	G	H	I	J	K	L	M	N
O	P	Q	R	S	T	U	V	W	X	Y	Z		
a	b	c	d	e	f	g	h	i	j	k	l	m	n
o	p	q	r	s	t	u	v	w	x	y	z		
0	1	2	3	4	5	6	7	8	9	.	-	_	!
#	\$	%	'	()	^	`						
SPC DEL BS INS ← →													END

ENT:Select
Ins.

5. Press the **ENT** Key.
The characters will be set.

2-3 Understanding Setting Operations

This section uses a simple example to explain the procedures for using Conversational Menus, from setting inspection conditions through to starting inspection. The example used is a presence inspection. The operating guides displayed on the screen can be used just like a conversation to help perform procedures.

2-3-1 STEP 1: Starting Conversational Menu

1. The screen shown below will be displayed when the Conversational Menus are started for the first time.

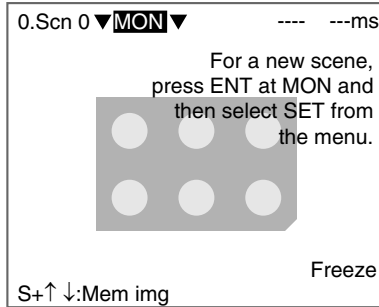

2. Move the cursor to **MON** and press the **ENT** Key. A list of modes will be displayed.

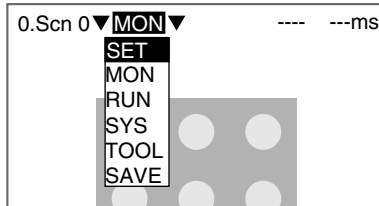

3. Use the **Up** and **Down** Keys to move the cursor and select **SET**. The F160 will enter Set Mode.

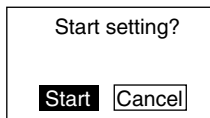

4. Select **Start** to start making the settings. Follow the instructions given by the operation guide displayed on the screen for the rest of the procedure.

2-3-2 STEP 2: Registering Reference Images

Copy *Sample A* found at the end of this manual. Register the Sample A image on the F160. This image will be used as a reference image for setting inspection conditions.

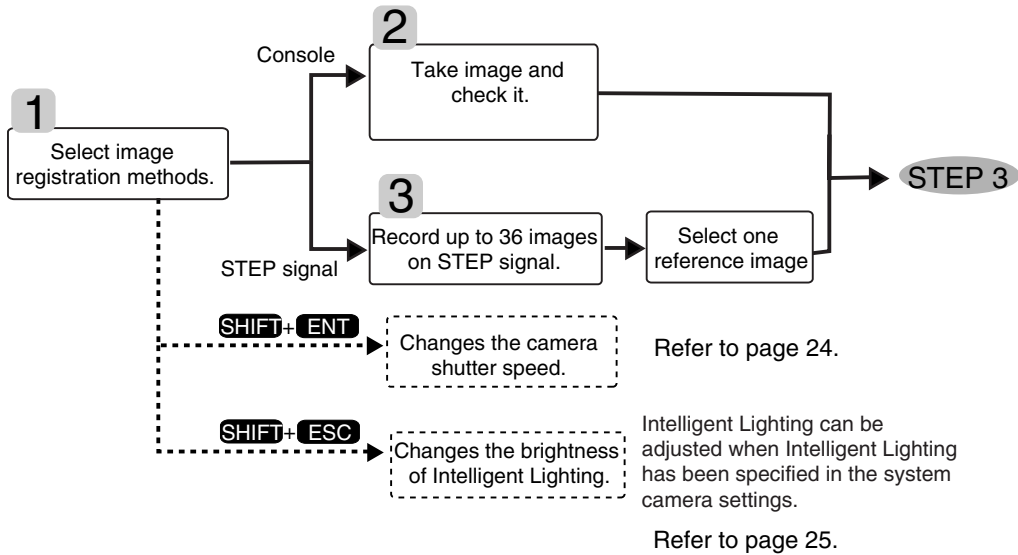

CHECK Registered reference images are lost when the power is turned OFF or the image save function is used. For possible future amendments to inspection conditions, it is recommended that the reference images are backed up to a computer or Memory Card. Up to 36 reference images can be registered when a Console is being used. When a reference image is not backed up, the workpiece must be displayed in the same position and size as the previous inspection to recreate the reference image. (Refer to page 78.)

2-3-2-1 Selecting Image Registration Methods

The Console or the parallel interface STEP signal can be used to register images.

HELP Console
Once the image is confirmed on the screen, Console Keys are pressed to register the image.

HELP STEP Signal
A sync signal is input to the STEP signal in the parallel interface to register images. Up to 36 images can be registered, i.e., you can register several workpieces as they travel down the production line and select one appropriate image as the reference image.

0.Scen 0 =SET= Ref image

Start	One image must be
>>Ref image	saved as a reference
Region	for inspection.
Positi	
End	Set the method to
	use to store images.

Console
STEP
Back

S+ESC:Adjust illumination
S+←→:Display S+ENT:Shutter

2-3-2-2 When Console Is Selected

1. Set the workpiece in the correct position.

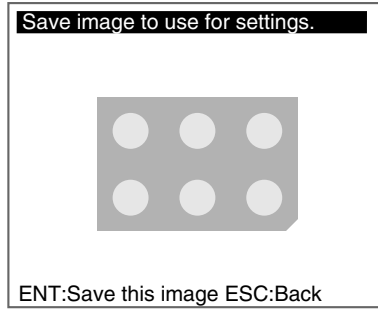

2. Press the **ENT** Key on the Console.
A confirmation message will be displayed.

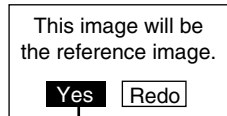

step3

3. Select **Yes** if that image is acceptable as the reference image.
The reference image has now been registered.

2-3-2-3 When STEP Is Selected

1. Set the workpiece and input a sync signal for the STEP signal.

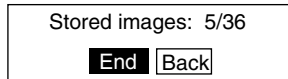

2. When the signal has been input, select **End**.
Note Up to 36 images can be registered one after the other.
An image selection message will be displayed.

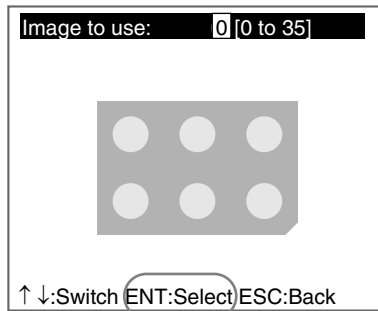

step3

3. Use the **Up** and **Down** Keys to switch between images and select one image to be used as the reference for inspection.
4. Once the image has been decided upon, press the **ENT** Key to select it.

The reference image registration has now been completed.

Changing Shutter Speed

Change the shutter speed when the object is moving quickly causing the image to be blurred.

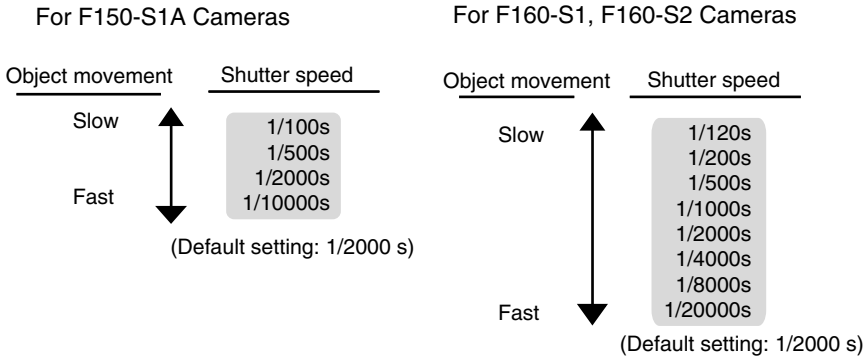

1. Press the **SHIFT + ENT** Keys on the screen for selecting the image storage method.

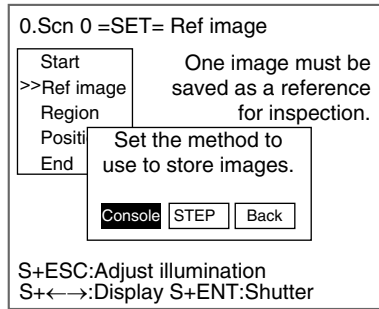

The Shutter Speed Screen will be displayed.

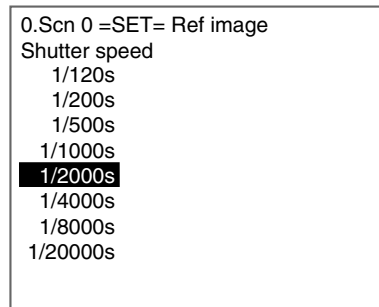

2. Use the **Up** and **Down** Keys to select the shutter speed.
 3. Press the **ENT** Key to set the selection.
- The screen in (1.) will return.

Adjusting Light Levels for Intelligent Lighting

When using Cameras with Intelligent Lighting, the light level can be adjusted from the F160.

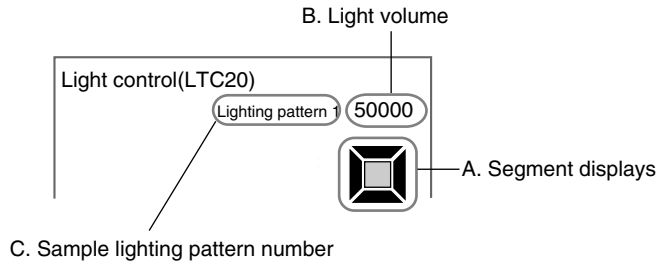

Segment Display

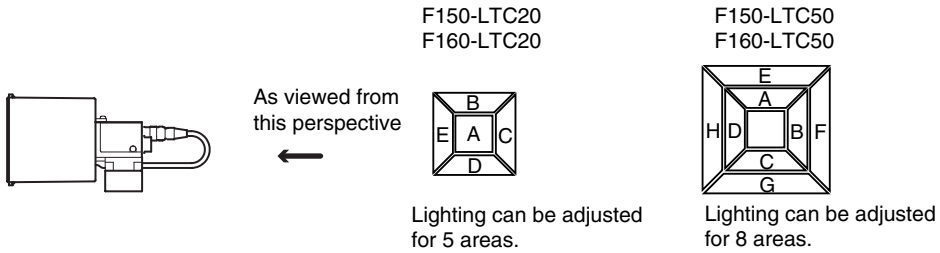

CHECK The measurement points are displayed with thick lines. The brightness depends on the set light level. Refer to page 26.

Displaying Light Levels

The light level for each segment is displayed as a 5- or 8-digit value, with each digit representing the light level of one of the segments. The light levels are displayed from 0 to 7, with 0 indicating that the light is OFF. The higher the setting, the higher the light level.

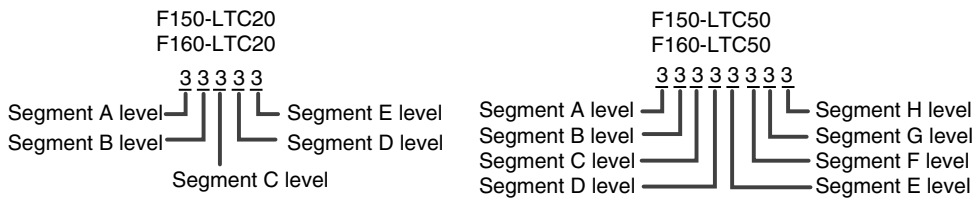

Sample Lighting Patterns

There are 15 sample lighting patterns registered in the F160.

Adjustment Method 1: Sample Lighting Patterns

There are 15 lighting patterns registered in the F160. The lighting can be set simply by going through the different patterns in order and selecting the one that gives the clearest image. Use the SHIFT + Up and Down Keys to switch between sample patterns.

F150-LTC20, F160-LTC20

■ Not lit
 □ Lit (maximum light level)

Pat-tern No.	Light level	Pat-tern No.	Light level	Pat-tern No.	Light level	Pat-tern No.	Light level	Pat-tern No.	Light level
1	50000 	4	07070 	7	22727 	10	00070 	13	52222
2	03333 	5	27272 	8	07000 	11	00007 	14	17777
3	07777 	6	00707 	9	00700 	12	51111 	15	27777

F150-LTC50, F160-LTC50

Pat-tern No.	Light level	Pat-tern No.	Light level	Pat-tern No.	Light level	Pat-tern No.	Light level	Pat-tern No.	Light level
1	7777777 	4	00004444 	7	07070707 	10	00700000 	13	00000700
2	44440000 	5	00007777 	8	70000000 	11	00070000 	14	00000070
3	77770000 	6	70707070 	9	07000000 	12	00007000 	15	00000007

Adjustment Method 2: Adjusting Light Levels by Segment

The light level for each segment can be set separately to a value between 0 and 7. The setting “0” represents the unlit state, and the higher the setting value the higher the light level. Light levels can also be set by adjusting the light levels for the sections separately after selecting a sample lighting pattern.

Use the Left and Right Keys to select the section to be adjusted and use the Up and Down Keys to adjust the light level.

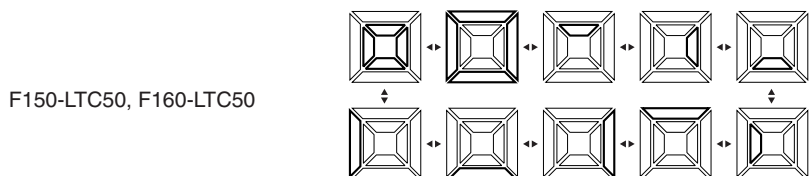
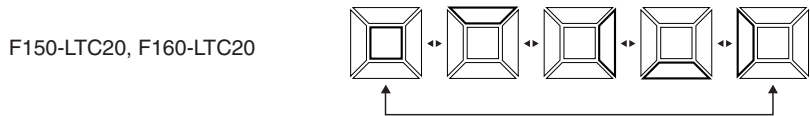

1. Press the **SHIFT + ENT** Keys on the screen for selecting the image storage method.

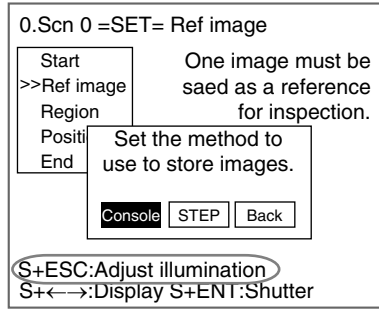

CHECK

If *S+ESC: Adjust illumination* is not displayed, exit Set Mode and change the settings under *SYS/Camera settings* to enable use of Intelligent Lighting. (Refer to page 102.)

The Intelligent Lighting Settings Screen will be displayed.

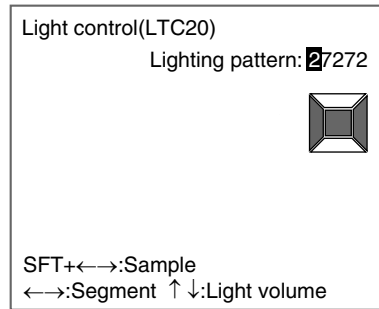

2. Change the settings.
 SHIFT + Left/Right Keys: Switches between sample patterns.
 Left/Right Keys: Switches between segments.
 Up/Down Keys: Switches between light levels.
3. Press the **ENT** Key to set the settings.
 The screen in (1.) will return.

2-3-3 STEP 3: Selecting and Setting Inspection Types

Specify the details of the inspection and the region to be inspected. Up to 32 points can be specified for inspection. This section uses presence inspection as an example to explain the settings operation.

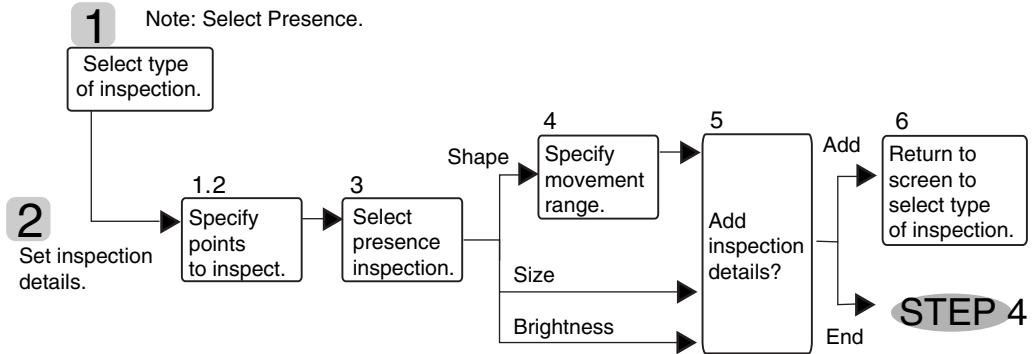

2-3-3-1 Selecting Presence Inspection



1. If a reference image is set as outlined under 1-3-2 STEP 2: Registering Reference Images, the inspection types will be displayed together with the operation guide.
2. Use the **Up** and **Down** Keys to move the cursor and select **Presence**.
 SHIFT + ENT Keys: Displays an explanation of the inspection type at the cursor position.
 SHIFT + Left/Right Keys: Switches between message display types (black or transparent backgrounds or blank message boxes.)

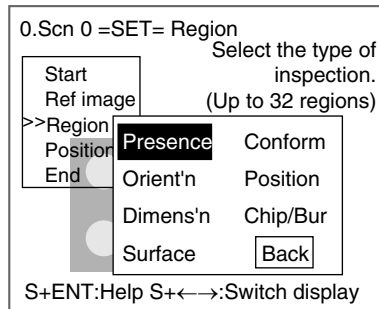

HELP

Presence inspection detects whether a component, mark, hole, etc., is at a specified position on the workpiece. Refer to page 3.

3. Press the **ENT** Key to set the setting.

2-3-3-2 Setting Inspection Details

1. Select the shape appropriate for the region to be inspected.

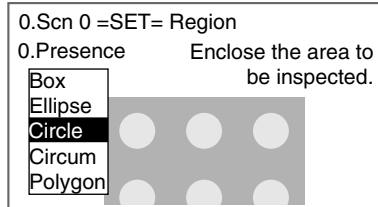

The shape will be displayed.

2. Enclose the region to be inspected.

SeeAlso

Refer to page 18 *Drawing Figures*.

Example

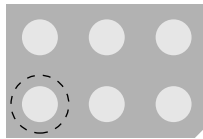





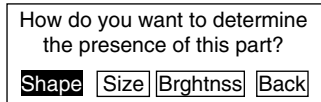







Enclose with a circle.

The screen for selecting how to determine the presence of the part will be displayed.



3. Select the desired method.

Methods for Determining Presence

Method	Details	Example
Shape	Judges based on differences in shape. Objects with the same shape but different orientation will give an NG result.	Reference  →  OK  NG  NG
Size	Judges based on differences in size. Objects with the same size but different shape will still give an OK result.	Reference  →  OK  NG  NG
Brightness	Judges based on differences in brightness.	Reference  →  OK  NG  NG

The following explanation applies if *Shape* was selected.

```

0.Scen 0 =SET= Region
0.Presence           220, 341
Set the movement range.
    
```

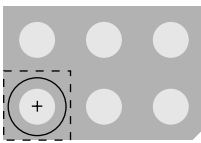

↑ ↓ ← →: Move ENT:Set ESC: Back

4. Specify the object movement range.

If the region to be measured is always in the same position, use the initial box displayed in dotted lines and use the ENT Key to select the upper-left and lower-right corners.

If the region to be inspected may be displaced, draw a rectangle large enough to allow for the range of movement. Use the Up/Down and Left/Right Keys to move the cursor and use the ENT Key to select the range.

Example

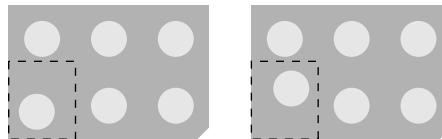

Draw a tall rectangle.
 Make sure that surrounding circles are not inside the rectangle, otherwise they will be included in the inspection.

A final message will be displayed.

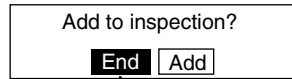

STEP 4

- If nothing more is to be added to the inspection, select **End**.

CHECK

To correct or delete settings, first end the setting and then go back into Set Mode and make the changes. (Refer to page 66.)

Select **Add** to combine other inspections.

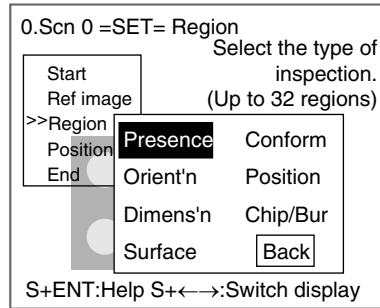

The screen for selecting the type of inspection will return. Follow the procedure outlined above to set the next inspection conditions.

The settings for the inspection region have now been completed.

2-3-4 STEP 4: Inconsistent Workpiece Positions

Measurement results will not be accurate if the position of the workpiece varies horizontally or vertically. Perform position compensation to enable accurate inspections.

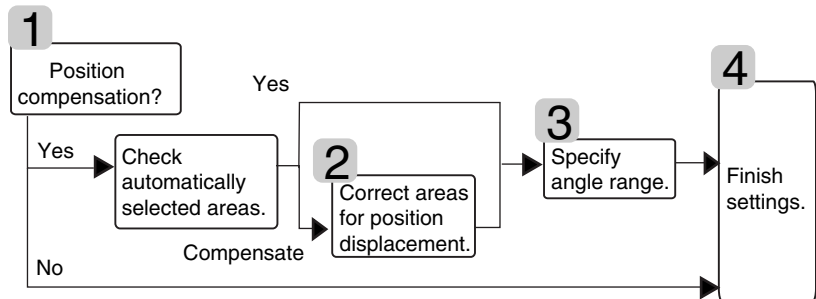

2-3-4-1 Deciding Whether to Perform Position Displacement Compensation

1. If inspection conditions are set in STEP 3, a message for selecting position compensation will be displayed along with the operation guide.

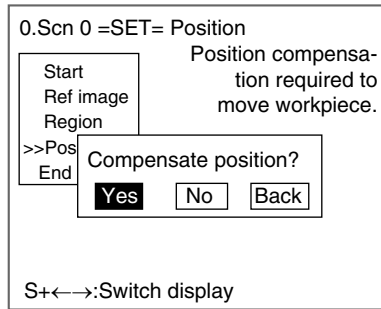

2. Check on the Monitor and select **Yes** if position compensation is required. If position compensation is not required, select **No** and go to 2-3-4-4 *Finishing Settings*.

Position compensation not required if the workpiece is always in the same position.

Position compensation required if the position of the workpiece varies.

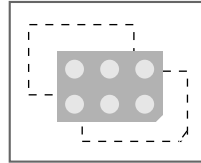
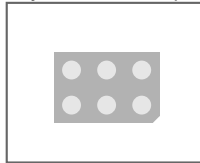

If **Yes** is selected, the F160 automatically determines the appropriate position compensation areas.

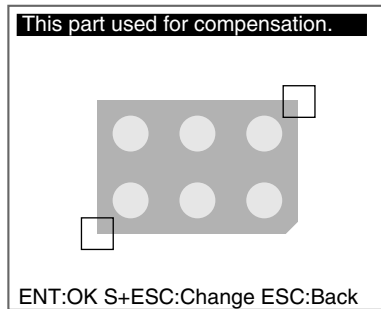

3. If the automatically selected regions are acceptable, press the **ENT** Key to confirm the setting and go to 2-3-4-3 *Objects at an Angle*.

If the automatically selected regions include marks that are not on every workpiece or inconsistent shapes, press the **SHIFT + ESC** Keys to select **Change** and go to 2-3-4-2 *Changing Position Displacement Compensation Regions*.

2-3-4-2 Changing Position Displacement Compensation Regions

1. Enclose with a rectangle two places to use for position compensation.

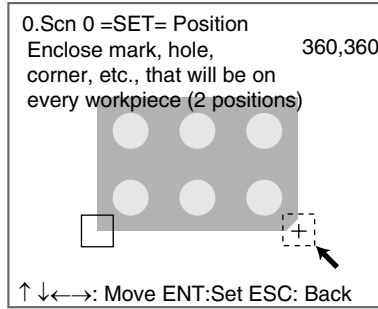

Up/Down and Left/Right Keys: Move the arrow cursor.

SHIFT + Up/Down and Left/Right Keys: Move the arrow cursor quickly.

ENT Key: Sets the position.

The screen for setting the movement range will be displayed.

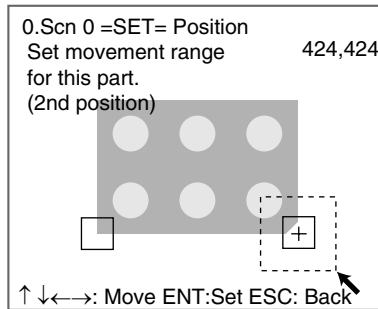

2. Specify each movement range.

The F160 will find the part in this movement range that most resembles the registered mark and finds the workpiece based on that position.

Go to 2-3-4-3 *Objects at an Angle*.

2-3-4-3 Objects at an Angle

1. Check on the Monitor and select **Yes** for objects that require angle compensation.

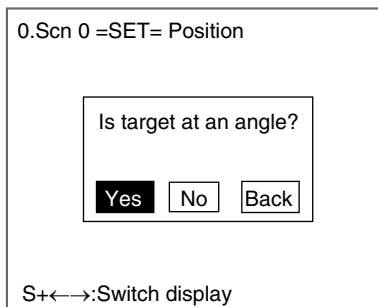

If angle compensation is not required, select **No** and go to 2-3-4-4 *Finishing Settings*.

Compensation is not required if the object is not at an angle. A rotation range must be set for objects at an angle.

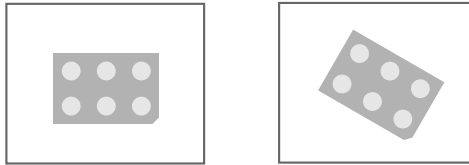

The screen for selecting the angle range will be displayed.

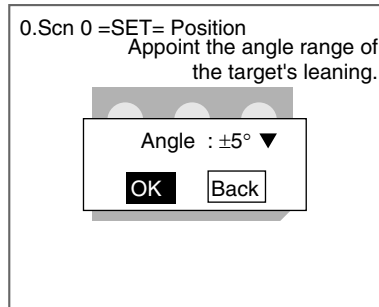

2. Select the angle range for the object.

Angle range selections
±5°
±15°
±30°
±45°
±90°
360°

The larger the angle range, the longer the time required for measurement.

3. Select **OK**.

Go to 2-3-4-4 *Finishing Settings*.

2-3-4-4 Finishing Settings

1. A message prompting a switch to Monitor Mode will be displayed. Select **Yes**.

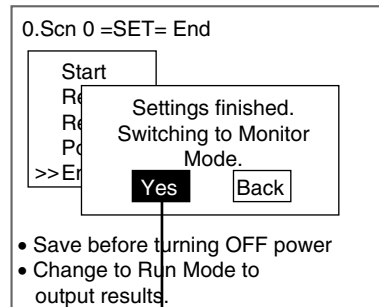

STEP 5

You will enter Monitor Mode. Perform a test to see if correct inspections will occur.

- CHECK** Results are not output via the parallel interface in Monitor Mode. Change to Run Mode to output the results.
- CHECK** Always save the condition settings to flash memory after they are set. The settings will be cleared when the power is turned OFF if they are not saved beforehand. (Refer to page 86.)

2-3-5 STEP 5: Entering Monitor Mode and Testing

Perform a test to confirm that inspections will be performed according to the set conditions.

The measurement results can be referred to when adjusting the precision of the judgement and the measurement time. The results are not output to the parallel interface or serial interface and so the test can be performed with the F160 only.

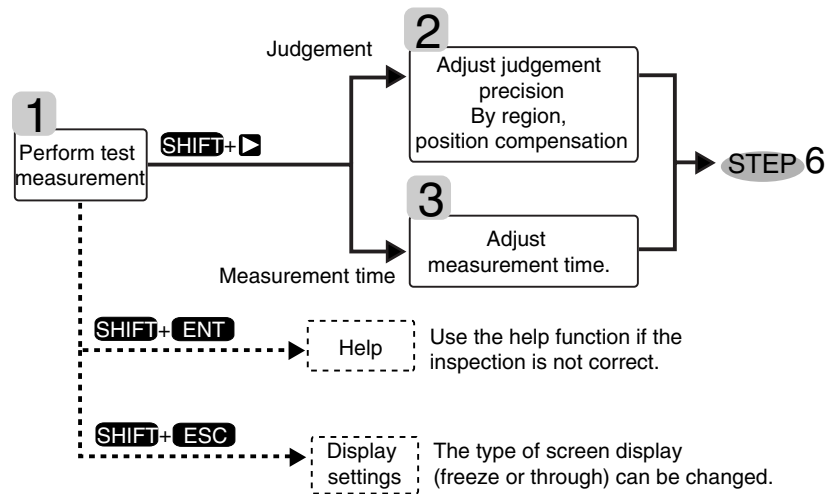

2-3-5-1 Performing Test Measurements

1. Press the TRIG Key on the Console or turn ON the STEP signal. One measurement will be executed.

- If adjustments are required, press the **SHIFT + Right** Keys to move to the Adjustment Screen.

The judgement result and measurement time will be displayed.

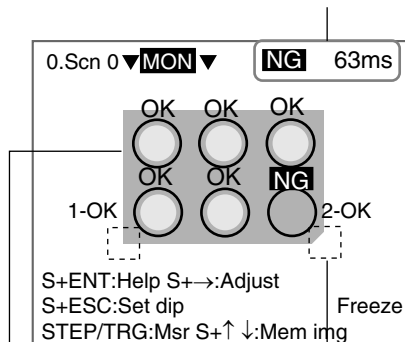

A graphic frame and the inspection result will appear in each inspection position. The areas to be used for position compensation will appear in dotted boxes.

(For freeze display only)

SHIFT + TRIG Keys: Re-execute measurement for the displayed image (for freeze and stored images only.)

SHIFT + ENT Keys: Display help messages.

SHIFT + ESC Keys: Display screen setting menus.

SHIFT + Up/Down Keys: Display stored images.

Help Messages

Help messages provide countermeasures for possible problems.

Problem	Countermeasure	Ref. page
Image moves or is out of focus.	Increase shutter speed or adjust the focus.	page 24
Image too dark or too light.	Adjust lighting. Adjust the lens aperture if using normal CCTV lens.	page 25
OK and NG judgments inaccurate.	Adjust the precision of the judgement.	page 37
Measurement time too long.	Adjust the measurement time. However, the inspection accuracy decreases the shorter the measurement time. Always perform a test and check the inspection results after adjusting the measurement time.	page 42
No graphic frame appears in the are to be inspected.	The workpiece position may be inconsistent. Change the settings to allow position compensation.	page 32

Display Settings

Change the image display method as required.



HELP Freeze
A still of the image taken by the Camera is displayed. Select *Freeze* when measuring moving objects.

HELP Through
The latest image taken by the Camera is displayed directly. It is useful to use through display when adjusting workpiece positions. However, through display is set when measurement is performed, the graphic frames and the judgement results for each inspection point will not be displayed.

2-3-5-2 Adjusting Judgement Precision

Adjust judgment precision when the OK and NG results are incorrect.

1. Press the **SHIFT + Right** Keys in Monitor Mode.

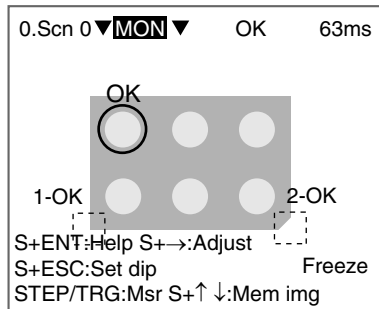

The screen for selecting the type of adjustment will be displayed.

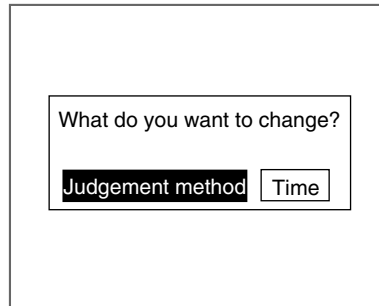

2. Select **Judgement method**.

The screen for selecting the target region will be displayed.

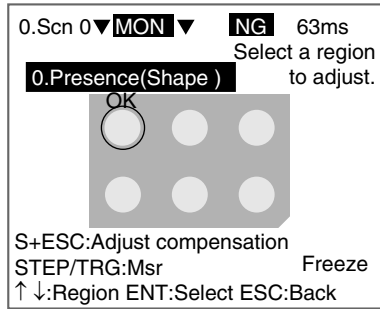

3. Use the **Up/Down** Keys to switch to the target adjustment region.
4. Press the **ENT** Key to confirm the selection.

A detailed screen for the selected region will be displayed.

Example: When "0. Presence (Shape)" has been selected.

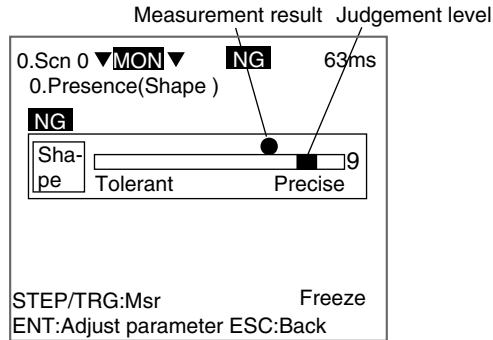

5. Press the **TRIG** Key. Measure a sample and look at the relationship between the measurement result and the judgement level.
6. Press the **ENT** Key.

The Parameter Adjustment Screen will be displayed.

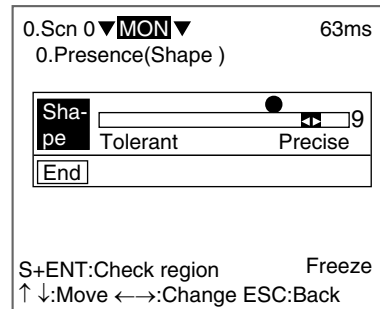

Note: Measurement cannot be executed in this screen.

7. Use the **Up/Down** Keys to select the parameter and use the **Left/Right** Keys to adjust the level.

CHECK

If the SHIFT + ENT Keys are pressed, the F160 will diagnose the inspection and display advice.

8. Use the **Down** Key to select **End** and press the **ENT** Key.

The settings will be registered and the screen in (5.) will return.

Adjustable Parameters

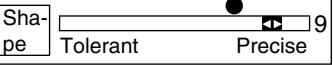
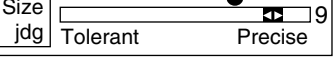
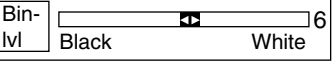
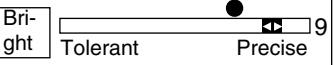
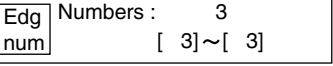
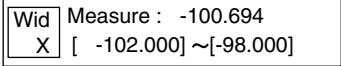
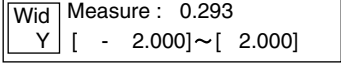
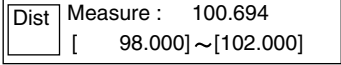
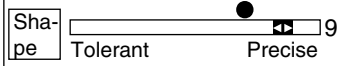
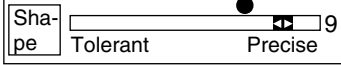
Inspection method		Adjustable parameters	
Presence Conformity Orientation	Shape (with self-diagnostic function)		Judgement precision is set to a level between 1 and 10.
	Size		Judgement precision is set to a level between 1 and 10.
			Adjust the black/white level if the lighting changed during movement. Adjust towards black if lighting became dark. Adjust towards white if lighting become bright.
	Brightness		Judgement precision is set to a level between 1 and 10.
	No. of edges (for conformity and orientation inspections)		Set the number of edges for an OK judgement.
Position (with reference) Dimension (with self-diagnostic function)		Set the X and Y coordinates and distance for an OK judgement.	
			
			
	Switch pages ↑ SHIFT + ESC		
		Make the shape judgement more tolerant if the inspection position is not found correctly.	
	Position inspection: The upper parameter is for the reference point and the lower parameter is for the inspection position. Dimension inspection: The upper parameter is for the first point and the lower parameter is for the second point.		

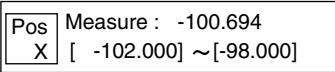
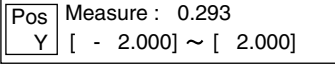
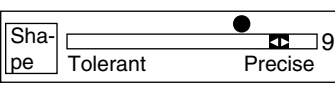
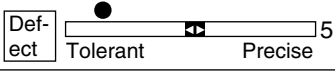
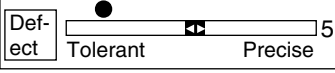
Inspection method	Adjustable parameters	
Position (no reference) (with self-diagnostic function)		Set the range for an OK judgement.
		
		Make the shape judgement more tolerant if the inspection position is not found correctly.
Chips and burs		Judgement precision is set to a level between 1 and 10.
Surface		Judgement precision is set to a level between 1 and 10.

Changing Judgement Precision for Position Displacement Compensation

The judgement precision can be changed if position displacement compensation is set. If the measurement object is not within the field of vision, an NG judgement is output at the position compensation stage, thus preventing incorrect measurements. The judgement position can be changed for both position compensation regions.

1. Press the **SHIFT + ENT** Keys in Monitor Mode.

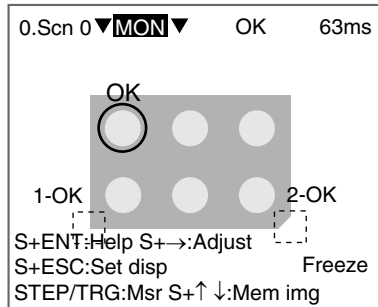

The screen for selecting the type of adjustment will be displayed.

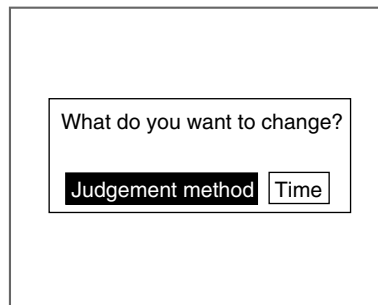

2. Select **Judgement method**.

The screen for selecting the target region will be displayed.

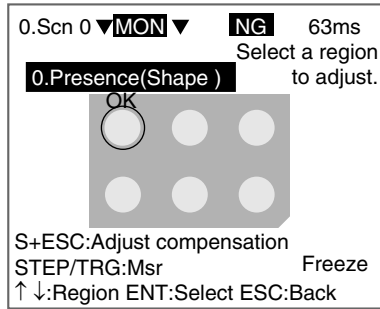

3. Press the **SHIFT + ESC** Keys to select **Adjust compensation**.

The position compensation details will be displayed.

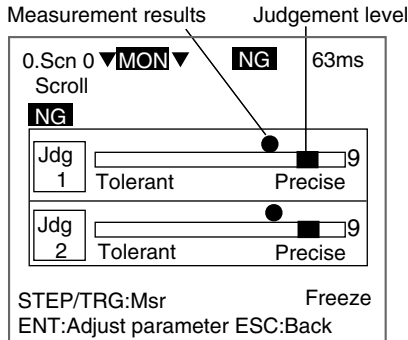

4. Press the **TRIG** Key. Measure a sample and look at the relationship between the measurement result and the judgement level.
5. Press the **ENT** Key.

The Parameter Adjustment Screen will be displayed.

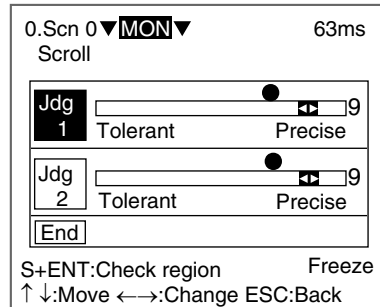

Note: Measurement cannot be executed on this screen.

6. Use the **Up/Down** Keys to select the parameter and use the **Left/Right** Keys to adjust the level.

CHECK

If the **SHIFT + ENT** Keys are pressed, the F160 will diagnose the inspection and display advice.

7. Use the **Down** Key to select **End** and press the **ENT** Key. The settings will be registered and the screen in (4.) will return.

2-3-5-3 Adjusting Measurement Time

The processing speed can be adjusted if the measurement time is too long and the line speed too slow.

1. Press the **SHIFT + Right** Keys in Monitor Mode.

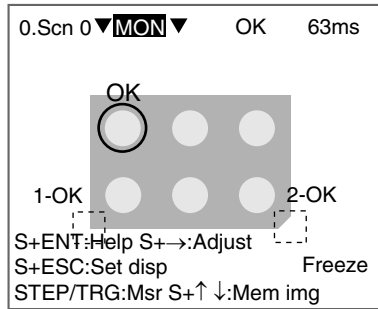

The screen for selecting the type of adjustment will be displayed.

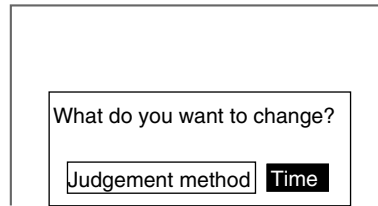

2. Select **Time**.

The Measurement Time Settings Screen will be displayed.

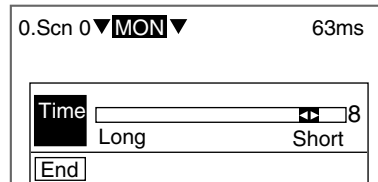

3. Use the **Left/Right** Keys to adjust the time.
Up/Down Keys: Move the cursor between *Time* and *End*.
4. Use the **Down** Key to select **End** and press the **ENT** Key.
A confirmation message will be displayed.

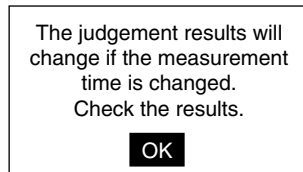

5. Select **OK**.
The settings will be registered and the screen in (1.) will return.

2-3-6 STEP 6: Entering Run Mode and Starting Inspections

This section describes how to enter Run Mode and start inspections. The measurement results will also be output to the parallel interface.

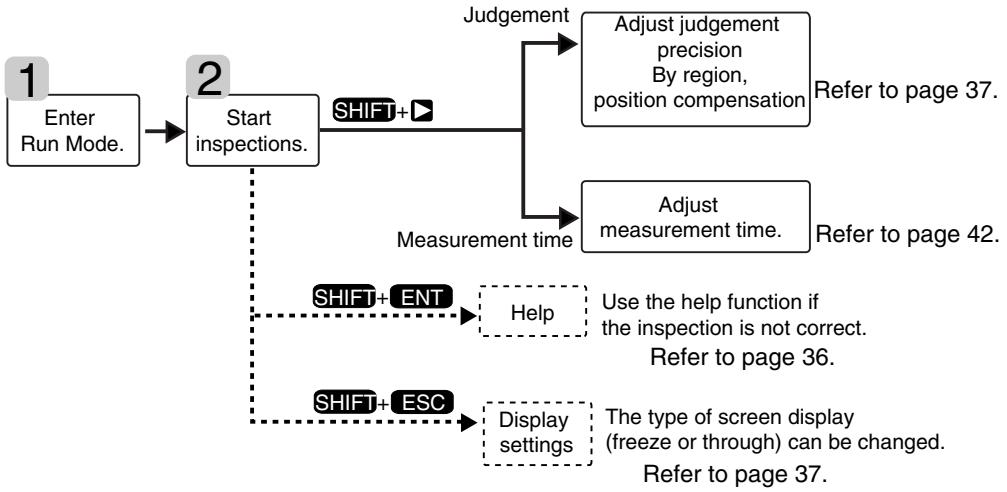

2-3-6-1 Entering Run Mode

1. Move the cursor to **OK** to change the mode.

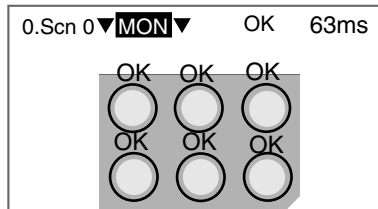

2. Press the **ENT** Key.
The mode selections will be displayed.

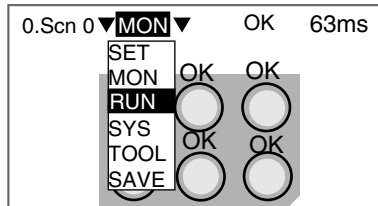

3. Use the **Up/Down** Keys to move the cursor and select **RUN**.
The Run Mode Screen will be displayed.

2-3-6-2 Starting Inspections

1. Press the TRIG Key on the Console or turn ON the STEP signal.

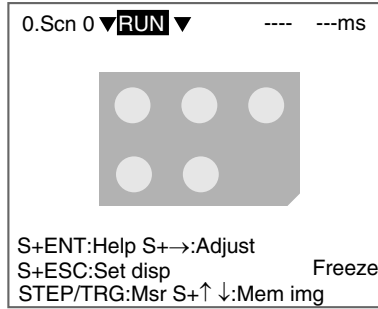

SHIFT + TRIG Keys: Re-execute measurement for the displayed image (for freeze and stored images only.)

SHIFT + ENT Keys: Display help messages.

SHIFT + Right Keys: Go to Adjustment Screen.

SHIFT + ESC Keys: Display screen setting menus.

SHIFT + Up/Down Keys: Display stored images.

One measurement will be performed.

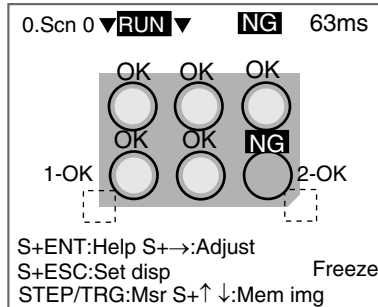

2-4 Saving Settings and Exiting the F160

Save settings to flash memory before turning the power OFF.

Precaution

Flash memory data is loaded each time the F160 is started. Therefore, when settings have been changed, be sure to save them to flash memory before turning OFF the power. If the power is turned OFF without saving new settings, all of the setting changes will be lost. Stored images cannot be saved to flash memory, so all stored images will be cleared when the power is turned OFF. If you want to keep stored images, backup the images to a personal computer or Memory Card. Refer to page 78.

1. Display the Basic Screen for Monitor Mode or Run Mode.



2. Move the cursor to **MON** (or **RUN**) and press the **ENT** Key.

The mode selections will be displayed.

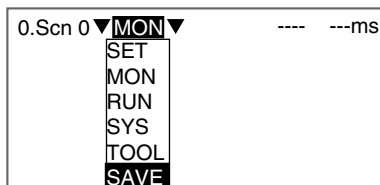

3. Select **SAVE**.

A confirmation message will be displayed.

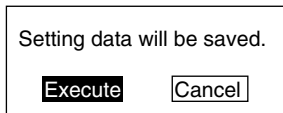

4. Select **Execute**.

Precaution

Do not turn OFF the power or input a RESET signal while a message is being displayed in any save or load operation. Data in memory will be destroyed, and the F160 may not operate correctly the next time it is started.

Once the setting data has been saved, the screen in (1.) return.

5. Turn OFF the power to exit the F160.

CHECK

When Using the Scene Group Function

The scene data set to Scene Group 0 and the system data will be saved to flash memory. The settings data for Scene Groups 1 to 31 will be overwritten to the Memory Card when this save operation is executed.

SECTION 3

Designing Inspections for Specific Applications

The Conversational Menus provide 7 inspection methods. Presence inspection procedures were explained in 2-3 *Understanding Setting Operations*. The specific settings for the other six inspection methods are explained in this section. The selection of the inspection method is STEP 3 in the operational flow. Once the selection has been made, move to STEP 4.

3-1	Conformity	48
3-1-1	Selecting Conformity Inspection	48
3-1-2	Setting Inspection Details	49
3-2	Orientation	50
3-2-1	Selecting Orientation Inspection	50
3-2-2	Setting Inspection Details	51
3-3	Position	52
3-3-1	Selecting Position Inspection	52
3-3-2	Setting Inspection Details	53
3-4	Dimension	57
3-4-1	Selecting Dimension	58
3-4-2	Setting Inspection Details	58
3-5	Chips and Burs	62
3-5-1	Selecting Chips and Burs	62
3-5-2	Specifying Inspection Regions	62
3-6	Surface	63
3-6-1	Selecting Surface	63
3-6-2	Specifying Inspection Regions	63

3-1 Conformity

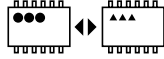

Conformity inspections check whether or not the workpiece matches the registered product.

SeeAlso Refer to page 3 *Inspection Types*.

The settings operation is shown in the following diagram. Only the outline will be given here. Follow the instructions given by the operational guide on the Monitor screen.

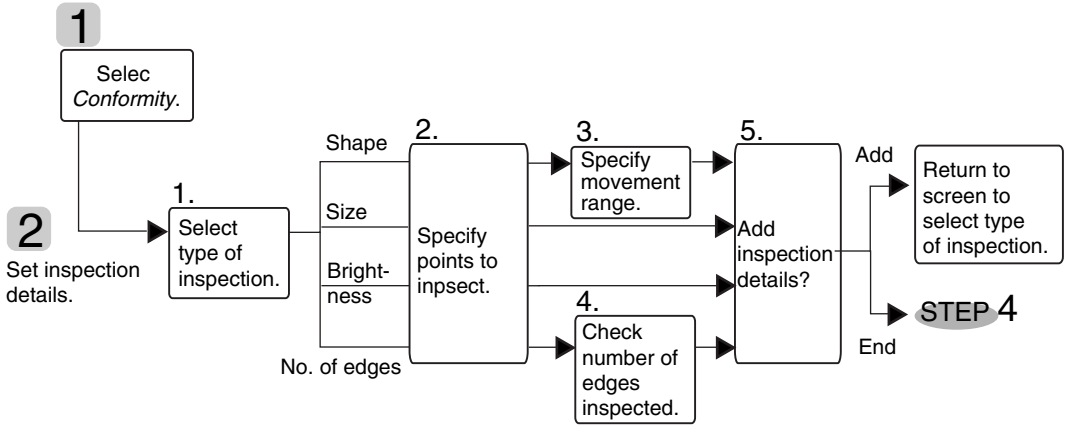

3-1-1 Selecting Conformity Inspection

Select **Conform** on the screen for selecting inspection types.

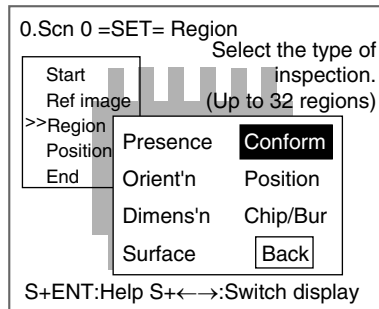

3-1-2 Setting Inspection Details

1. Select the method for checking non-conforming items.

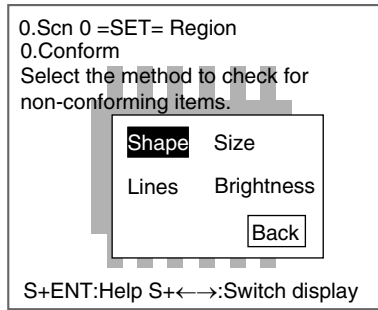

2. Follow the instructions provided by the on-screen operational guide to make the rest of the settings.

Checking Methods

Methods for Judging Conformity

Checking method	Details	Example
Shape	Judges based on differences in shape. Objects with the same shape but different orientation will give an NG result.	Reference Reference → OK NG NG
	<p>Movement Range</p> <p>If the Inspection Point is Always in the Same Position Use the initial box displayed in dotted lines and select the upper-left and lower-right corners.</p> <p>If the Inspection Point is Inconsistent Draw a box that encloses the range of positions. Do not include surrounding patterns or other marks in the box because they will be included in the inspection.</p>	
Size	Judges based on differences in size. Objects with the same size but different shape will still give an OK result.	Reference Reference → OK NG NG
Brightness	Judges based on differences in brightness.	Reference Reference → OK NG NG
Lines (No. of edges)	Judges based on the number of edges.	Reference Reference → OK NG NG
	The only shape that can be drawn is a box. The edges are detected in the direction of the long side of the box.	<p>Inspection direction: 2 edges Inspection direction: 0 edges</p>

3-2 Orientation

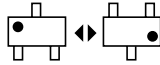

Orientation inspections detect the orientation of the workpiece and to see if the workpiece is facing the correct direction.

SeeAlso Refer to page 3 *Inspection Types*.

The settings operation is shown in the following diagram. Only the outline will be given here. Follow the instructions given by the operational guide on the Monitor screen.

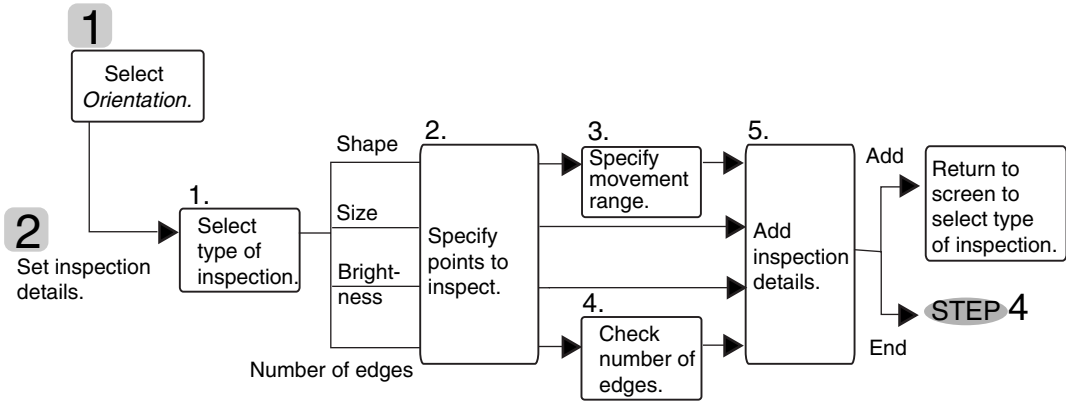

3-2-1 Selecting Orientation Inspection

Select ***Orient'n*** on the screen for selecting inspection types.

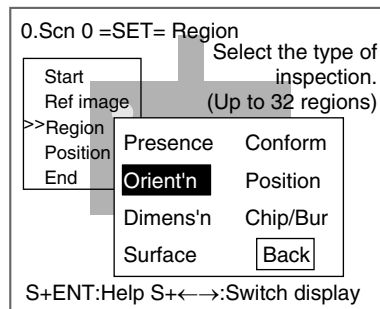

3-2-2 Setting Inspection Details

1. Select the method for checking the orientation of items.

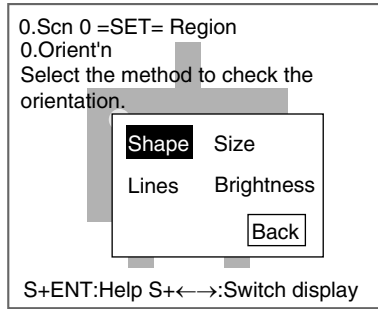

2. Follow the instructions provided by the on-screen operational guide to make the rest of the settings.

Checking Methods

Methods for Judging Conformity

Checking method	Details	Example
Shape	Judges based on differences in shape. Objects with the same shape but different orientation will give an NG result.	Reference Reference → OK NG NG
	<p>Movement Range</p> <p>If the Inspection Point is Always in the Same Position Use the initial box displayed in dotted lines and select the upper-left and lower-right corners.</p> <p>If the Inspection Point is Inconsistent Draw a box that encloses the range of positions. Do not include surrounding patterns or other marks in the box because they will be included in the inspection.</p>	
Size	Judges based on differences in size. Objects with the same size but different shape will still give an OK result.	Reference Reference → OK NG NG
Brightness	Judges based on differences in brightness.	Reference Reference → OK NG NG
Lines (No. of edges)	Judges based on the number of edges.	Reference Reference → OK NG NG
	The only shape that can be drawn is a box. The edges are detected in the direction of the long side of the box.	<p>Inspection direction: 2 edges</p> <p>Inspection direction: 0 edges</p>

3-3 Position

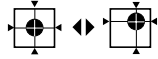

Position inspections find the position of a specified mark, hole, or other feature and determine whether or not it is within the correct range.

SeeAlso. Refer to page 3 *Inspection Types*.

The settings operation is shown in the following diagram. Only the outline will be given here. Follow the instructions given by the operational guide on the Monitor screen.

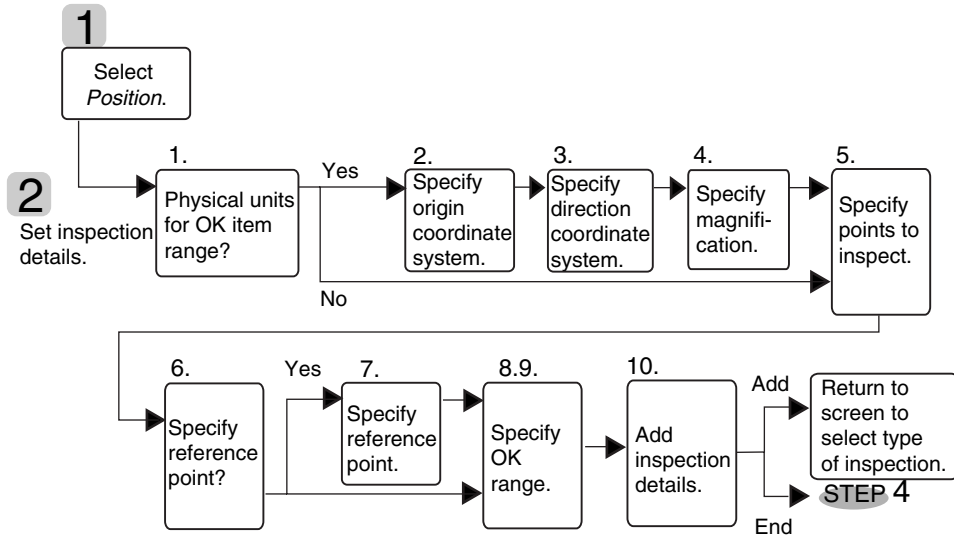

3-3-1 Selecting Position Inspection

Select **Position** on the screen for selecting inspection types.

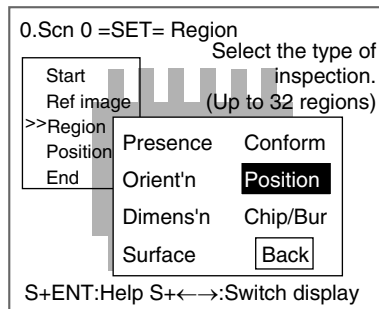

3-3-2 Setting Inspection Details

1. Decide whether or not to specify physical units for the OK item range.

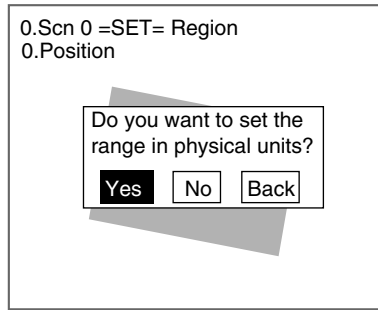

CHECK

This screen will not be displayed if the coordinate system, has already been set in another inspection region.

If Yes is Selected

Set the range for OK items in physical units. Go to step (2.)

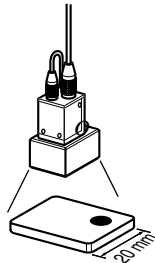

If No is Selected

Set the range for OK items in pixel units. Go to step (5.)

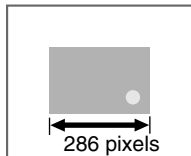

The following explanation of how to align the coordinate scale with the dimensions of the workpiece will use a workpiece on an angle as an example.

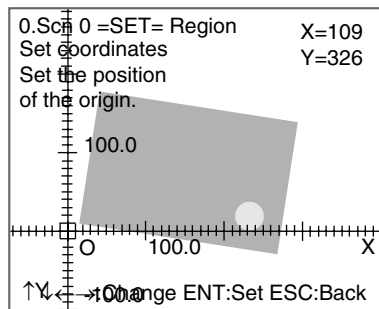

2. Align the origin of the coordinates (0) with the left corner or other part of the workpiece that will serve as the origin for the physical units.

Up/Down and Left/Right Keys: Move the origin (0).

SHIFT + Up/Down or Left/Right Keys: Move the origin quickly.

ENT Key: Sets the position.

The screen for aligning the coordinate axis will be displayed.

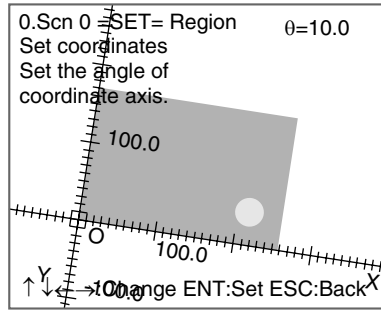

3. If the workpiece is on an angle, use the **Down/Right** and **Up/Left** Keys to specify the angle for the axis.

Down and Right Keys: Rotates the axis in the clockwise direction.

Up and Left Keys: Rotates the axis in the anti-clockwise direction.

SHIFT + Down/Right or Up/Left Keys: Rotates the axis quickly.

ENT Key: Sets the position.

The screen for setting the magnification will be displayed.

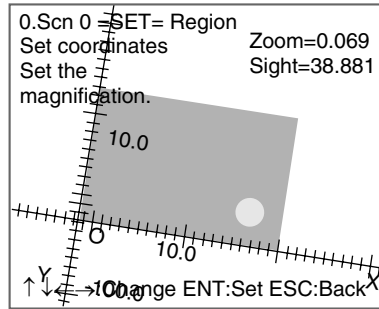

Example: 20 mm Workpiece

Align the origin with the bottom left corner of the workpiece and enlarge or reduce the scale to match

20.0 on the scale with the bottom right corner of the workpiece.

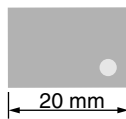

4. Use the **Down/Right** and **Up/Left** Keys to enlarge and reduce the coordinate scale and align with the physical dimensions of the workpiece.

Up/Left Keys: Enlarge the scale.

Down/Right Keys: Reduce the scale.

SHIFT + Down/Right or Up/Left: Reduces or enlarges the scale quickly.

ENT Key: Sets the magnification.

The screen for specifying the inspection position will be displayed.

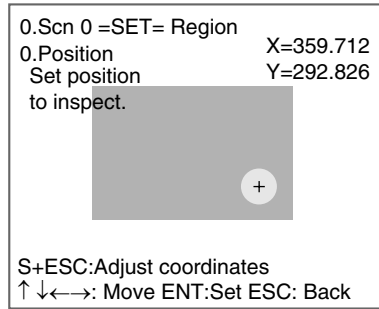

- Use the **Up/Down** and **Left/Right** Keys to move the cursor to the position to be inspected. This specifies the inspection position.

SHIFT + Up/Down or Left/Right Keys: Move the cursor quickly.

SHIFT + ESC Keys: Used to correct the position. Returns to the screen for aligning the coordinate axis.

ENT: Sets the position.

A screen giving the option to specify a reference position will be displayed.

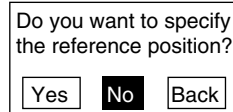

- Select **Yes** to specify a relationship between the inspection point and a particular point on the workpiece.

Select **No** if no particular relationship is to be specified.

If **Yes** is Selected

Any point can be specified as the reference point. The relationship between the two points is found when inspection is performed. Go to step (7.)

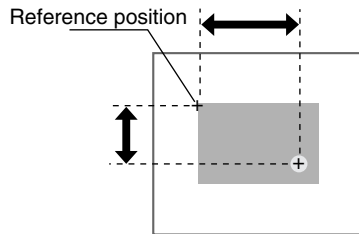

If **No** is Selected

The origin will become the reference point. Go to step (9.)

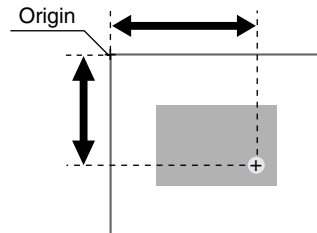

If Yes was selected in step (6.), the screen for specifying the reference position will be displayed.

Coordinates with the origin as the specified reference position and the distance from the origin.

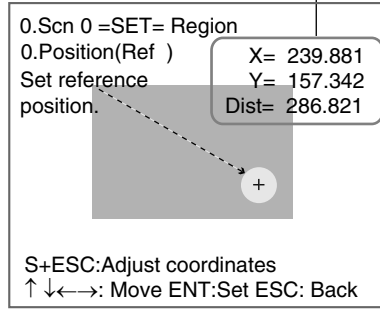

- 7. Use the **Up/Down** and **Left/Right** Keys to move the cursor to the reference position.

SHIFT + Up/Down or Left/Right Keys: Move the cursor quickly.

SHIFT + ESC Keys: Used to correct the position. Returns to the screen for aligning the coordinate axis.

ENT: Sets the position.

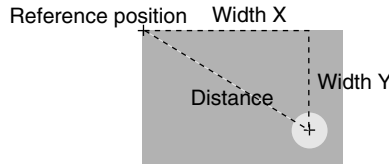

The screen for changing the range for OK items will be displayed.

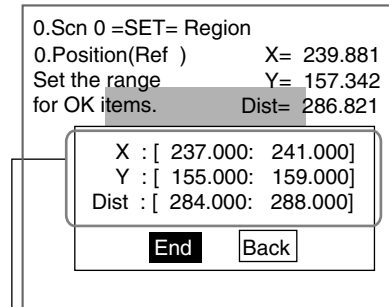

Range for OK items automatically calculated by the F160 based on the coordinates.

SeeAlso

Refer to page 19 for details on inputting values.

- 8. Move the cursor to the value to be changed and set the range for OK items. Go to step (10.)

If *No* was selected at step (6.), the screen for changing the OK item range will be displayed.

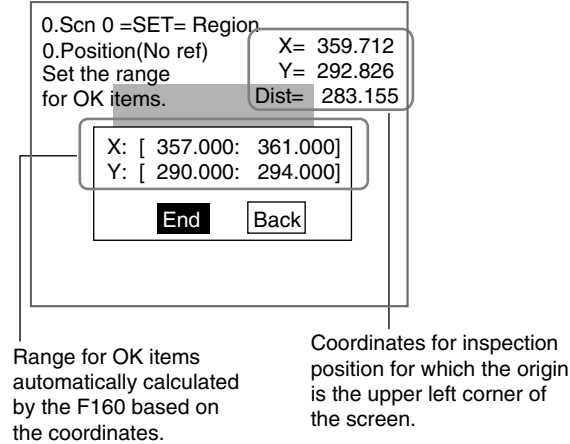

SeeAlso Refer to page 19 for details on inputting values.

- 9. Move the cursor to the value to be changed and specify the range for OK items.
- 10. Select **End**.

A confirmation message will be displayed.

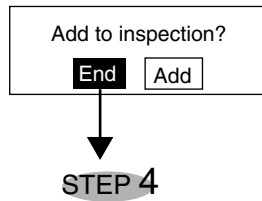

- 11. Select **End** if there are no more conditions to be added to the inspection.

3-4 Dimension



Dimension inspections inspect the relationship (distance) between two specified points to see if it is within a range.

SeeAlso Refer to page 3 *Inspection Types*.

The settings operation is shown in the following diagram. Only the outline will be given here. Follow the instructions given by the operational guide on the Monitor screen.

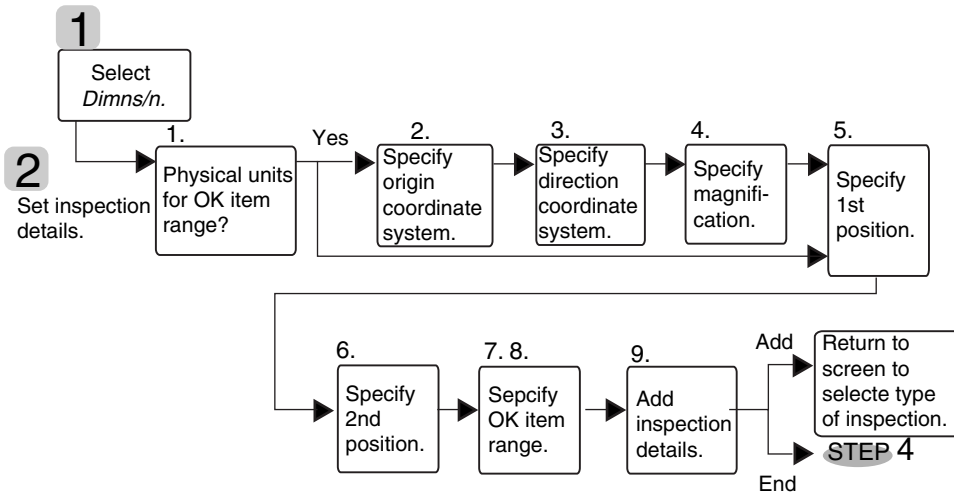

3-4-1 Selecting Dimension

Select **Dimns'n** on the screen for selecting inspection types.

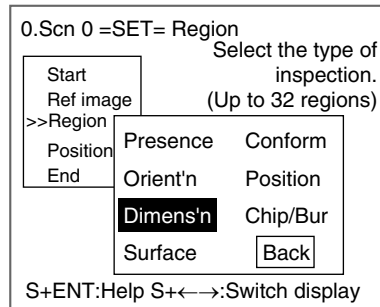

3-4-2 Setting Inspection Details

1. Select whether the range for OK items will be set in physical units.

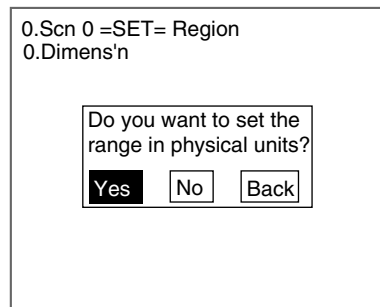

CHECK

This screen will not be displayed if the coordinate system has already been aligned in another inspection region.

If *Yes* is Selected
 Set the range for OK items in physical units. Go to step (2.)

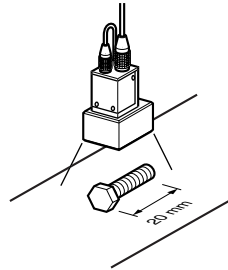

If *No* is Selected
 Set the range for OK items in pixel units. Go to step (5.)

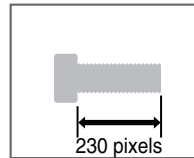

The following explanation of how to align the coordinate scale with the dimensions of the workpiece will use a workpiece on an angle as an example.

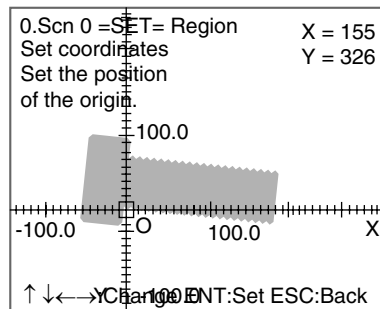

2. Align the origin of the coordinates (O) with the left corner or other part of the workpiece that will serve as the origin for the physical units.
 Up/Down and Left/Right Keys: Move the origin (O).
 SHIFT + Up/Down or Left/Right Keys: Move the origin quickly.
 ENT Key: Sets the position.

The screen for aligning the coordinate axis will be displayed.

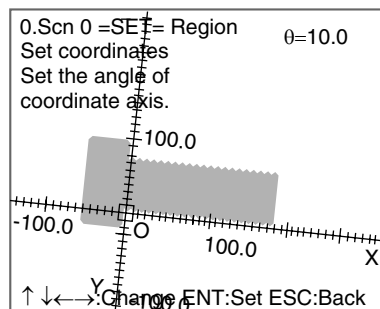

3. If the workpiece is on an angle, use the **Down/Right** and **Up/Left** Keys to specify the angle for the axis.
 Down and Right Keys: Rotates the axis in the clockwise direction.

Up and Left Keys: Rotates the axis in the anti-clockwise direction.

SHIFT + Down/Right or Up/Left Keys: Rotates the axis quickly.

ENT Key: Sets the position.

The screen for setting the magnification will be displayed.

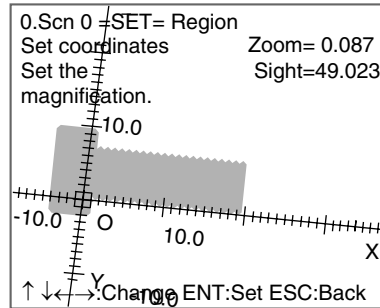

Example: 20 mm Workpiece

Align the origin with the bottom left corner of the

workpiece and enlarge or reduce the scale to match

20.0 on the scale with the bottom right corner of the workpiece.

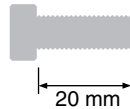

- Use the **Down/Right** and **Up/Left** Keys to enlarge and reduce the coordinate scale and align with the physical dimensions of the workpiece.

Up/Left Keys: Enlarge the scale.

Down/Right Keys: Reduce the scale.

SHIFT + Down/Right or Up/Left: Reduces or enlarges the scale quickly.

ENT Key: Sets the magnification.

The screen for specifying the inspection start position will be displayed.

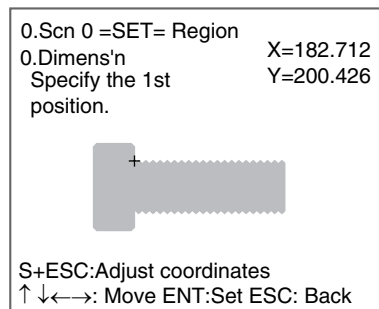

- Use the **Up/Down** and **Left/Right** Keys to move the cursor to the position to be inspected. This specifies the start position (1st position).

SHIFT + Up/Down or Left/Right Keys: Move the cursor quickly.

SHIFT + ESC Keys: Used to correct the position. Returns to the screen for aligning the coordinate axis.

ENT: Sets the position.

A screen giving the option to specify the inspection end position will be displayed.

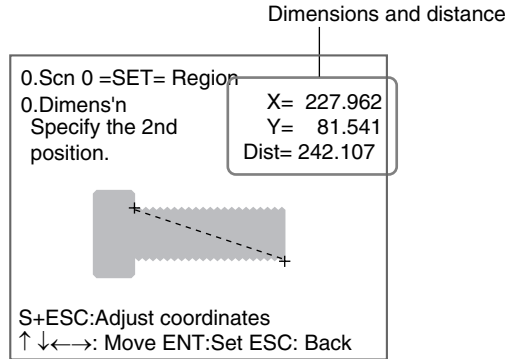

- Specify the end position (2nd position) that will measure the dimensions using the same procedure.

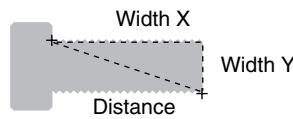

The screen for changing the range for OK items will be displayed.

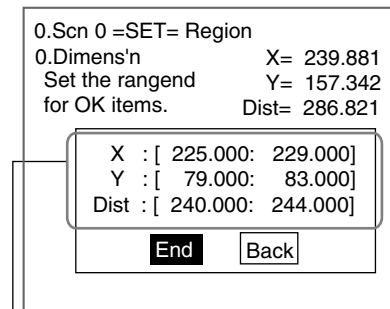

Range for OK items automatically calculated by the F160 based on the coordinates.

SeeAlso

Refer to page 19 for details on inputting values.

- Move the cursor to the value to be changed and set the range for OK items.
- Select **End**.
A confirmation message will be displayed.

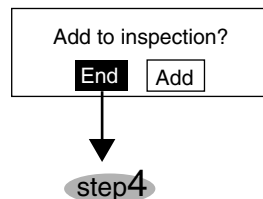

- Select **End** if there are no more conditions to be added to the inspection.

3-5 Chips and Burs



Chip and bur inspections check for chips and burs on the circumference of workpieces.

SeeAlso Refer to page 3 *Inspection Types*.

The settings operation is shown in the following diagram. Only the outline will be given here. Follow the instructions given by the operational guide on the Monitor screen.

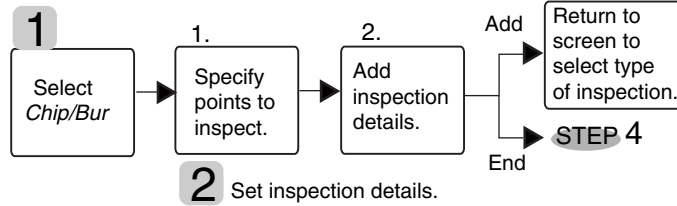

3-5-1 Selecting Chips and Burs

Select **Chip/Bur** on the screen for selecting inspection types.

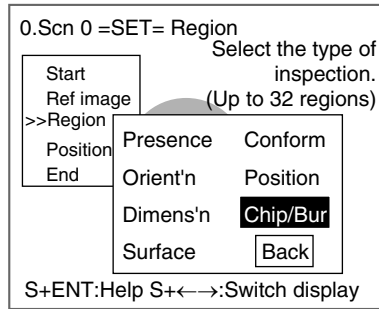

3-5-2 Specifying Inspection Regions

1. Select and draw a figure suitable for the inspection region and press the **ENT** Key to set the region.

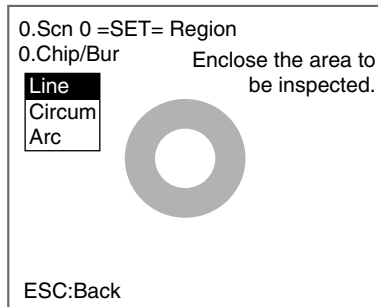

SeeAlso Refer to page 18 for details on drawing figures.

2. Follow the instructions provided by the on-screen operational guide to make the rest of the settings.

3-6 Surface



Surface inspections check for defects and impurities within a specified range.

SeeAlso Refer to page 3 *Inspection Types*.

The settings operation is shown in the following diagram. Only the outline will be given here. Follow the instructions given by the operational guide on the Monitor screen.

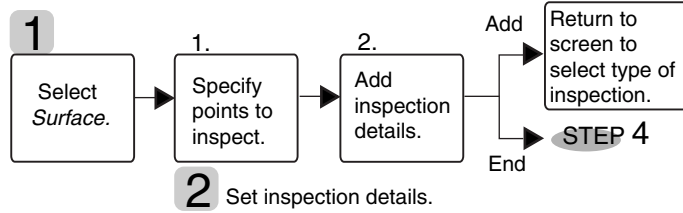

3-6-1 Selecting Surface

Select **Surface** on the screen for selecting inspection types.

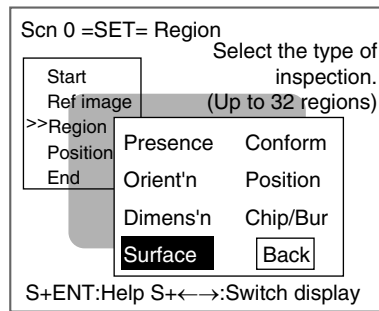

3-6-2 Specifying Inspection Regions

1. Decide the upper left point for a box that will enclose the inspection region and then set the lower right point.

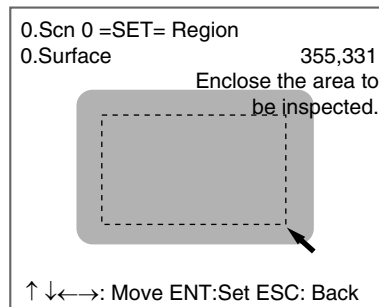

Up/Down and Left/Right Keys: Move the arrow cursor.

SHIFT + Up/Down and Left/Right Keys: Move the arrow cursor quickly.

ENT Key: Sets the position.

2. Follow the instructions provided by the on-screen operational guide to make the rest of the settings.

CHECK

Do not draw a box where there are marks or patterns. If marks or patterns are included in the box, the inspection will be incorrect because the marks or pattern will not be distinguished from defects.

SECTION 4

Application Settings

This section describes how to change, delete, and save inspection settings and how to use various functions with Conversational Menus.

4-1	Changing and Clearing Inspection Conditions	66
4-1-1	Entering Set Mode.	66
4-1-2	Re-registering Reference Images	67
4-1-3	Changing Setting Details.	67
4-1-4	Changing Position Displacement Compensation	70
4-2	Changing Scenes and Scene Groups	71
4-2-1	Setting Measurement Conditions for Different Models: Changing Scenes	72
4-2-2	Copying Scene Data	74
4-2-3	Initializing Measurement Conditions: Clearing Scenes	75
4-2-4	Adding Comments to Scenes	76
4-2-5	Using Scene Group Function	77
4-3	Backing Up Data	78
4-3-1	Backing Up to a Personal Computer	78
4-3-2	Backing Up to Memory Cards	83
4-3-3	Backing Up to Flash Memory	86
4-4	Checking Image Density Distribution: Line Brightness	88
4-5	Checking I/O Status with External Devices	90
4-5-1	Serial Interface	90
4-5-2	Parallel Interface	92
4-6	Memory Card Operations	93
4-6-1	Creating Directories	93
4-6-2	Copying Files	95
4-6-3	Checking File Properties	97
4-6-4	Changing File Names	97
4-6-5	Deleting Files and Directories.	99
4-6-6	Turning OFF the Power Supply to the Memory Card.	99

4-1 Changing and Clearing Inspection Conditions

To change, add, or delete inspection area positions, enter Set Mode again and change the conditions.

You can also clear all settings and start again. The reference images will remain, however, unless the power is turned OFF or the images are overwritten using the save function. Decide whether to register other images or use the existing reference images.

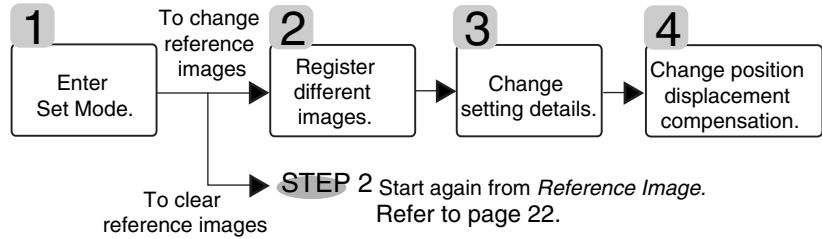

4-1-1 Entering Set Mode

1. Move the cursor to **MON** and press the **ENT** Key once.

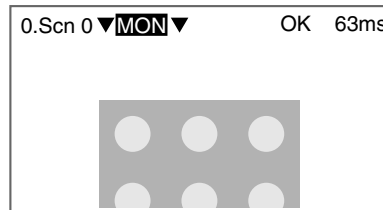

A list of selections will be displayed.

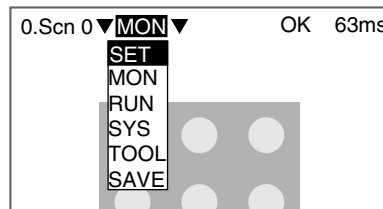

2. Select **SET**.

The Start Screen for Conversational Menus will be displayed.

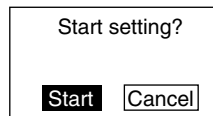

3. Select **Start**.

The screen for selecting whether or not to clear all settings will be displayed.

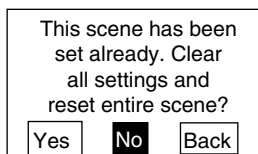

If **Yes** is Selected

Return to *STEP 2: Registering Reference Images* and re-register the images. (The stored reference images are not cleared.)

If **No** is Selected, go to *4-1-2 Re-registering Reference Images*.

4-1-2 Re-registering Reference Images

Select **Yes** to update the reference images. The reference images will be registered using the same procedure as the first time.

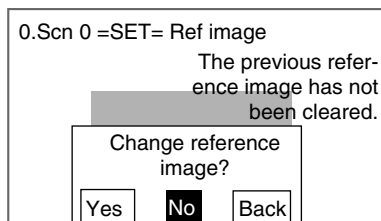

SeeAlso Refer to page 22 *STEP 2: Registering Reference Images*.
If you want to keep the previous reference image, select **No**.

CHECK When the Power Has Been Turned OFF After Previous Inspection Conditions Were Set
The reference images will have been cleared. Either place a workpiece of the same size in the same position and register that image or, if the reference image was backed up to a computer or Memory Card, download the image as memory image 35. (Refer to page 81 and page 85.)

CHECK If you have downloaded backed up images, select *STEP* as the image storage method and select memory image 35. (Refer to page 22.)

4-1-3 Changing Setting Details

Adding Regions

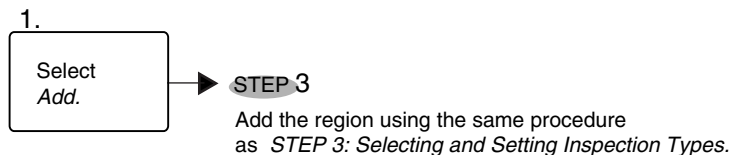

1. Select **Add**.

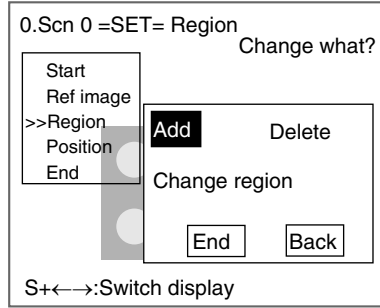

Use the same procedure as *STEP 3: Selecting and Setting Inspection Types* to add the region.

Changing the Position or Size of Regions

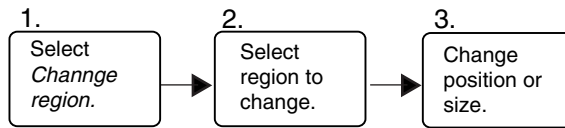

1. Select **Change region**.

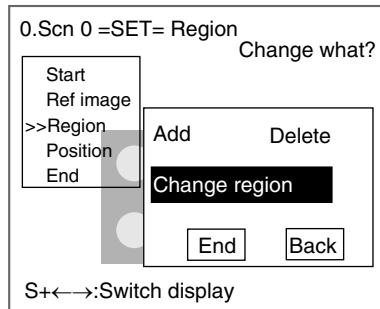

In this explanation, *Presence/Size* will be used as an example. The Select Region to Change Screen will be displayed.

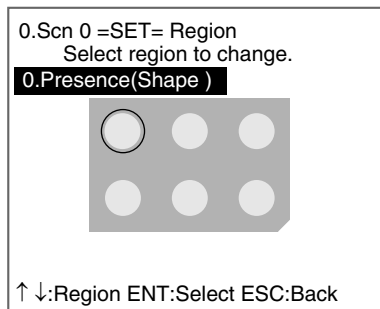

2. Select the number of the region to be changed.
 Up/Down Keys: Switch between regions.
 ENT Key: Sets the selection.

The screen for changing the position and size of the region will be displayed.

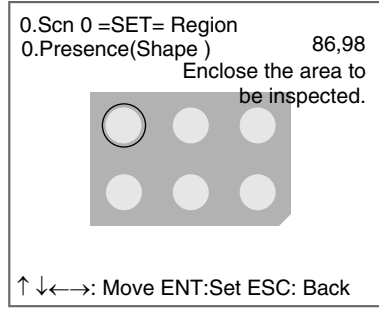

SeeAlso

Refer to page 18 for details on drawing figures.

3. Change the position and size.
The screen in step (2.) will return.

Deleting Regions

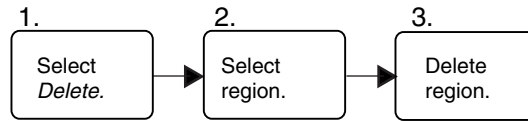

1. Select **Delete**.

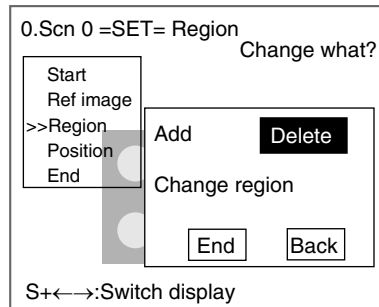

The Select Region To Delete Screen will be displayed.

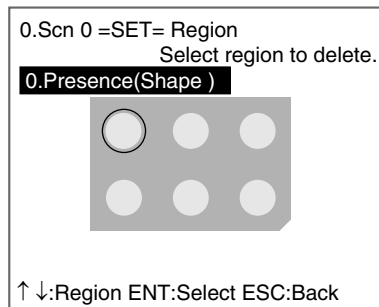

2. Select the region to delete.
Up/Down Keys: Switch between regions.
ENT Key: Sets the selection.

A confirmation message will be displayed.

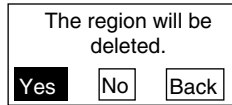

3. Select **Yes** to delete the region.

If other regions are set, the screen in step (1.) will return.

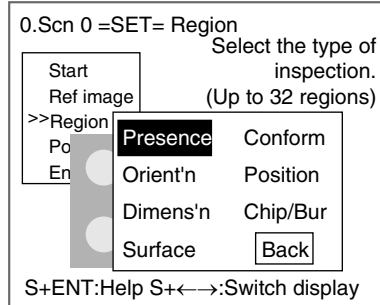

If the deleted region was the only region, the screen for selecting inspection types will return.

4-1-4 Changing Position Displacement Compensation

When Position Compensation Is Set

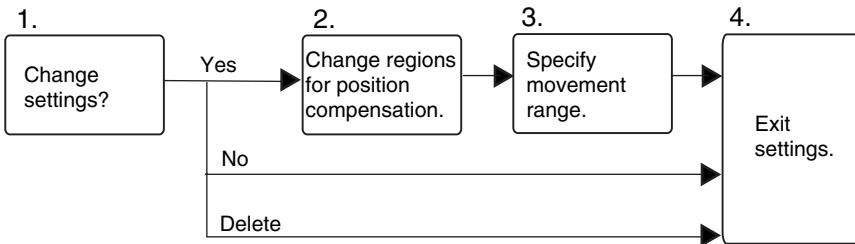

When Position Compensation Is Not Set

Perform the operations outlined under *STEP 4: Inconsistent Workpiece Positions.*

1. Select **Yes** to change the position compensation settings.

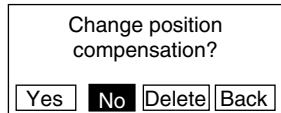

Select **No** to not change the settings.

Select **Delete** to delete the settings.

If Yes was selected, the Position Compensation Screen will be displayed.

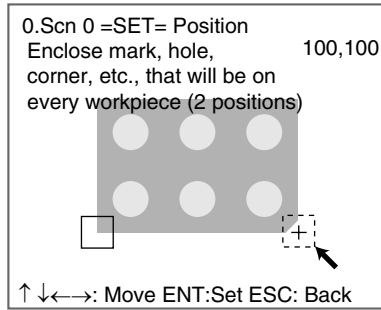

SeeAlso

Refer to page 18 for details on drawing figures.

2. Follow the instructions provided by the on-screen operational guide to make the rest of the settings.

CHECK

After the settings have been changed, be sure to save them to flash memory before turning OFF the power. If the power is turned OFF without saving new settings, all of the setting changes will be lost. (Refer to page 86.)

4-2 Changing Scenes and Scene Groups

The different situations (types of measurement object and types of measurements required) in which measurements are performed are called “scenes” and the measurement conditions set in Set Mode are called “scene data.” The scene function can be used to set 32 types of measurement conditions. If detection conditions change, simply switch scenes to change to a different measurement setup.

The normal limit of 32 scenes may not be possible for some settings if there is insufficient memory. A message will appear on the screen if there is insufficient memory. Make the region smaller or delete unnecessary regions or models.

CHECK

Up to 1,024 scenes can be stored if a 128-Mbyte Memory Card is inserted. Up to 32 scenes make up a scene group and up to 32 scene groups can be set, i.e., 32 scenes x 32 scene groups = 1,024.

Scene group 0 will be saved in the internal flash memory and scene groups 1 to 31 will be saved to the Memory Card.

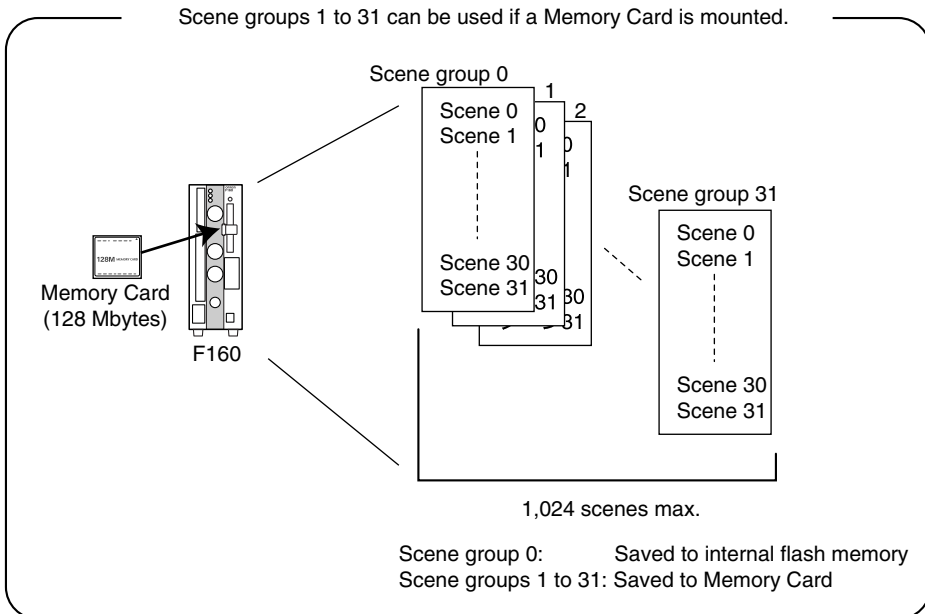
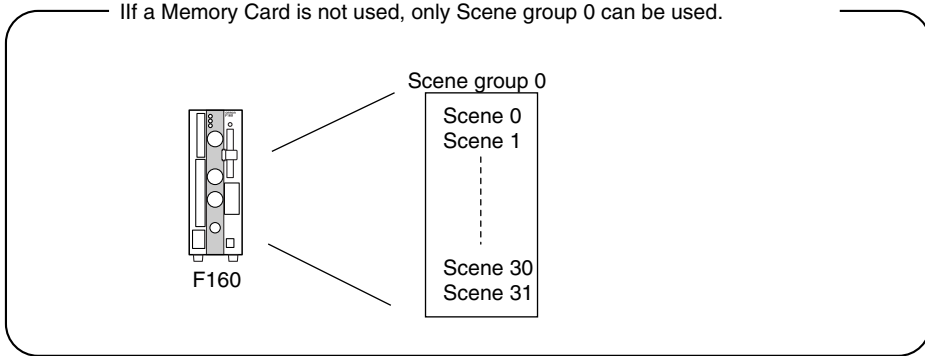

4-2-1 Setting Measurement Conditions for Different Models: Changing Scenes

Use the scene changing function to switch between different measurement conditions for different measurement setups or measurement objects. Scene 0 will be displayed by default when the power is turned ON, however, the F160 also accommodates scenes 1 to 31. If a Memory Card is inserted and the scene group function used, up to 1,024 scenes can be set.

The command for changing scenes or scene groups can be input from an external device via a parallel or serial interface.

1. Display the Basic Screen for Monitor Mode or Run Mode.

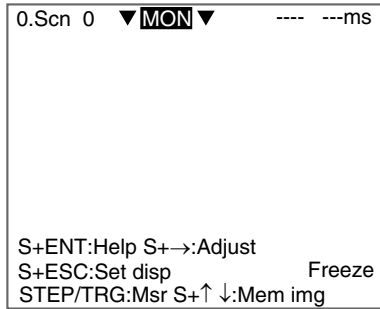

2. Move the cursor to **Scn** and press the **ENT** Key.
The Scn 0 to Scn 7 options will be displayed.
Use the **Down** Key to display scene numbers 8 to 31.

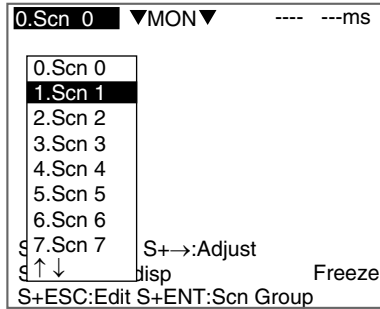

3. Move the cursor to the scene number to be switched to and press the **ENT** Key.
The selected scene will be displayed.

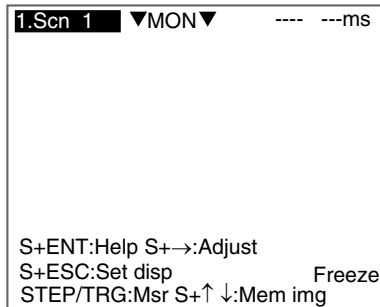

Using Scene Group Function

1. Insert a Memory Card.

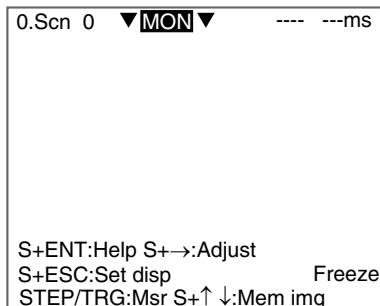

2. Display the Basic Screen for Monitor Mode or Run Mode.
3. Move the cursor to **Scn** and press the **ENT** Key.

The Scn 0 to Scn 7 options will be displayed.

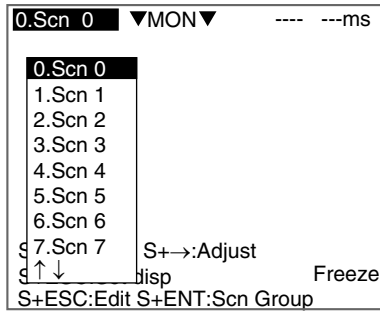

4. Press the **SHIFT+ENT** Keys.
- The Scene Group 0 to Scene Group 7 options will be displayed.
Use the **Down** Key to display scene group numbers 8 to 31.

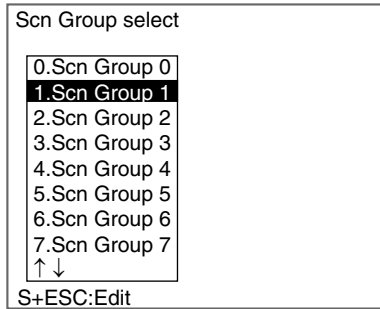

5. Move the cursor to the scene group number to be switched to and press the **ENT** Key.
- The selected scene group will be displayed.

CHECK

When scene groups 1 to 31 are switched to, a directory called “DEFSCN-GR” will be automatically created in the root directory of the Memory Card. The scene group data will be saved in files called “SGR_00** .SGR.” The asterisks (*) are the scene number.

4-2-2 Copying Scene Data

This function is useful for creating new scenes by copying scene data from another scene and changing some settings to suit the new requirements.

CHECK

Scene data can be copied only within the same scene group. To copy data between scene groups, copy the whole scene group. Refer to page 77.

1. Move the cursor to **Scn 0** and press the **ENT** Key.

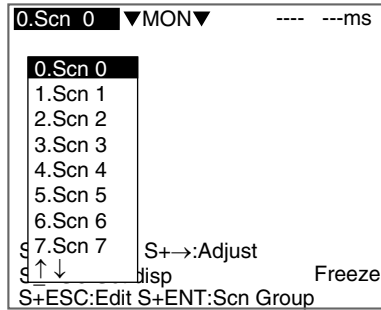

2. Move the cursor to the scene number to which data is to be copied.
3. Press the **SHIFT+ESC** Keys.

The Copy/Clear/Comment Menu will be displayed.

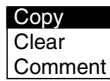

4. Select **Copy**.

The screen for copying will be displayed.

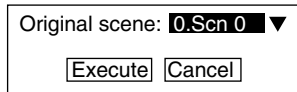

5. Enter the number of the scene from which data is to be copied (Original scene), and select **Execute**.

The data will be copied.

4-2-3 Initializing Measurement Conditions: Clearing Scenes

Use the following procedure to clear measurement conditions set in Set Mode, and to return scenes to their default settings. This section explains the procedure performed separately for each scene.

SeeAlso Refer to page 77 for information on initializing whole scene groups.

1. Move the cursor to **Scn 0** and press the **ENT** Key.

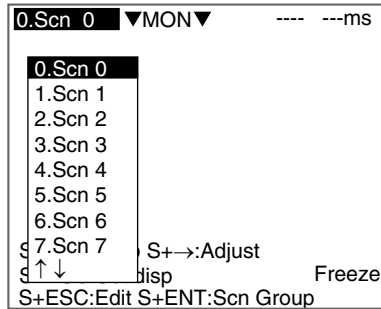

2. Move the cursor to the number of the scene to be cleared.
3. Press the **SHIFT+ESC** Keys.

The Copy/Clear/Comment Menu will be displayed.

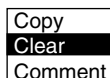

4. Select **Clear**.
A confirmation message will be displayed.

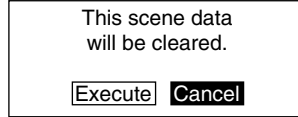

5. Select **Execute**.
The scene will be cleared.

4-2-4 Adding Comments to Scenes

Any comment can be added to each scene. This is useful for understanding settings when many regions have been registered.

1. Move the cursor to **Scn 0** and press the **ENT** Key.

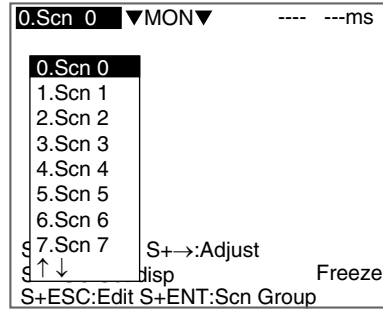

2. Move the cursor to the number of the scene for the name change.
3. Press the **SHIFT+ESC** Keys.

The Copy/Clear/Comment Menu will be displayed.

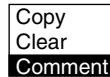

4. Select **Comment**.
A software keyboard will be displayed.

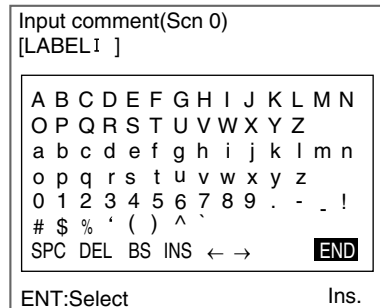

5. Set up to 8 characters.
6. Move the cursor to **END** and press the **ENT** Key.
The scene name will be changed.



4-2-5 Using Scene Group Function

Use the scene group function to copy and clear whole scene groups and change the scene group name to any 11 standard characters.

1. Insert a Memory Card.

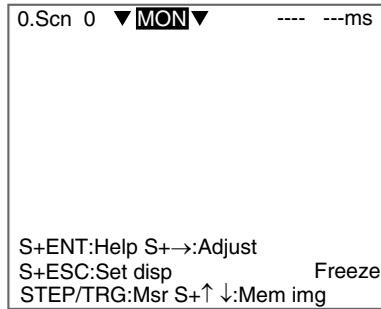

2. Display the Basic Screen for Monitor Mode or Run Mode.
3. Move the cursor to **Scn** and press the **ENT** Key.

The Scene 0 to Scene 7 options will be displayed.

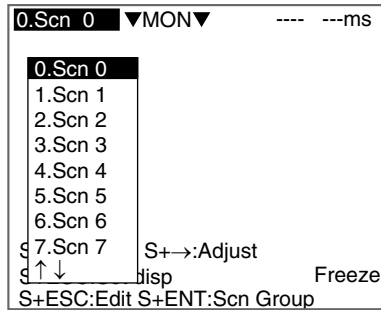

4. Press the **SHIFT+ENT** Keys.

The Scene Group 0 to Scene Group 7 options will be displayed.

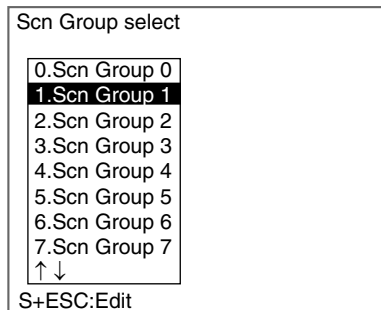

5. Move the cursor to the desired scene group number.
6. Press the **SHIFT + ENT** Keys.

The Copy/Clear/Comment Menu will be displayed.

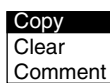

The rest of the operations are the same as when using the scene function.

4-3 Backing Up Data

This section explains how to make backup copies of data to flash memory or a computer.

When the power to the F160 is turned OFF, all data settings are cleared. The F160 loads data saved to flash memory at startup. Therefore, when settings are changed, in order not to lose these settings, be sure to save them to flash memory.

The 5 types of system and scene data listed below can be backed up on a computer or Memory Card. The same data can also be loaded from a computer to the F160. Saving and loading data enables using the same data on other F160 Controllers.

It is recommended that data is backed up in case data is lost or the F160 malfunctions.

Data	Contents
System data	Settings under <i>SYS</i> .
Scene group data	Scene data (scenes 0 to 31) for specified scene group.
Scene data	Settings under <i>SET</i> .
System data and scene group data	Both the system data and scene group data (for the scene group currently displayed) together.
Image data	Saved measurement images in BMP format. This is the basic image format for Windows and so the images can be displayed on a personal computer.

CHECK Image data is saved as frame images. Even if *Field* is selected for the Camera mode, the images will be converted to frame images before being saved.

Precaution Do not turn OFF the power or input a RESET signal while a message is being displayed in any save or load operation. Data in memory will be destroyed, and the F160 may not operate correctly the next time it is started.

CHECK Depending on the contents of the settings, it may not be possible to backup data to a Memory Card because of insufficient memory. In this case, a message will be displayed on the screen. Delete unnecessary scenes.

4-3-1 Backing Up to a Personal Computer

This section describes data transfer procedures, using Hyper Terminal, a standard tool for Windows 98 and Windows NT4.0.

This example is based on the presumption that an RS-232C cable has been commented to the COM1 port on the personal computer. Make the necessary adjustments when the cable is connected to a different port. If using different communications software, refer to the relevant manual.

Data is transferred using XMODEM (-CRC or -SUM) or ZMODEM protocol. XMODEM (-1K) is not supported.

Saving Data to the Computer

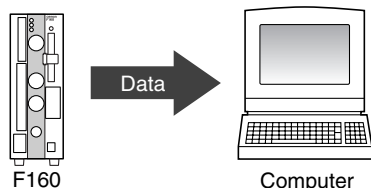

1. Connect the RS-232C cable to the COM1 port on the personal computer and the RS-232C/422 connector on the F160.
2. Make the F160 communications settings (serial).

The default communications settings are as shown in the following table. These settings can Normally be used.

Item	Setting
Communications protocol	RS-232C
Baud rate	38,400 (bps)
Data length	8 (bits)
Parity bits	None
Stop bits	1 (bit)
Protocol	XMODEM (See note.)

Note Both XMODEM and ZMODEM transfer protocols are supported. Use the protocol that matches the computer settings.

3. Start the Hyper Terminal program on the computer and make the following communications settings. The same communications settings must be used on both the F160 and the modem on the computer.

Item	Setting
Baud rate	38,400 (bps)
Data length	8 (bits)
Parity bits	None
Stop bits	1 (bit)
Flow control	None (See note.)

Note XMODEM or ZMODEM protocol is used, so flow control is not performed.

4. Once the communications settings have been made on the computer, display the Basic Screen for Monitor Mode or Run Mode.

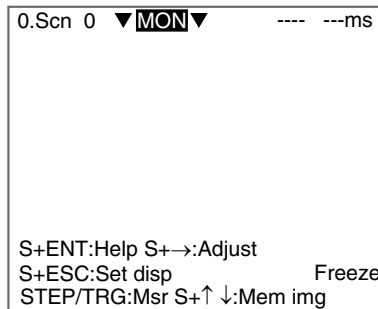

5. Move the cursor to **MON** (or **RUN**) and press the **ENT** Key. The mode selections will be displayed.

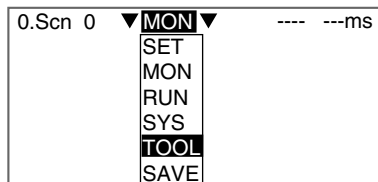

6. Select **TOOL**.

The data selections will be displayed.

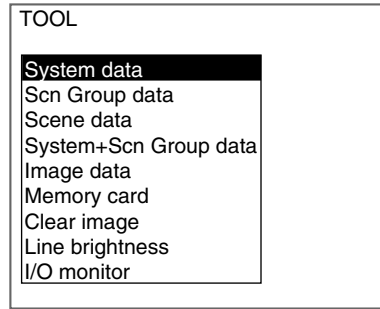

- 7. Select the data to be saved.

The destination selections for load and save will be displayed.

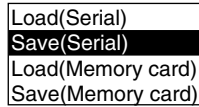

- 8. Select **Save (Serial)**.
- 9. Select the desired number for scene group, scene, or image data.

When using ZMODEM for communications, set a file name of 8 characters or less after inputting the desired number.

Scene group No.	Scene No.	Image data No.
Scn Group 0	Scn 0	Memory 0
Scn Group 1	Scn 1	Memory 1
Scn Group 2	Scn 2	Memory 2
Scn Group 3	Scn 3	Memory 3
Scn Group 4	Scn 4	Memory 4
Scn Group 5	Scn 5	Memory 5
Scn Group 6	Scn 6	Memory 6
Scn Group 7	Scn 7	Memory 7
↑ ↓	↑ ↓	↑ ↓
(0 to 31)	(0 to 31)	(0 to 35)

CHECK

When backing up system and scene group data, the currently displayed scene group will be saved.

A confirmation message will be displayed.

Example:

Confirmation message when saving system data.

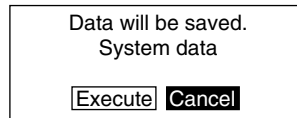

- 10. Select **Execute**.

A screen showing the transfer progress will be displayed.

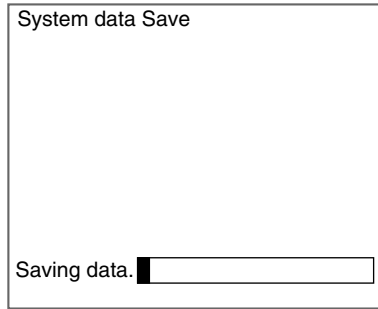

11. Select **Transfer/Receive File** from the Hyper Terminal menu on the computer.
12. Specify where the file is to be saved.
13. Set the protocol to **XMODEM** or **ZMODEM**.
14. Select **Receive**. When using XMODEM, input a file name.
The data will be transferred from the F160 to the computer.
When the transfer has been completed, the screen in (8.) will return.

Loading Data from the Computer

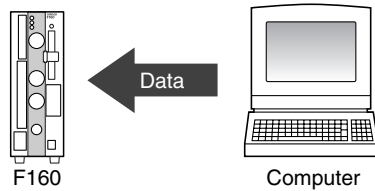

1. Follow steps 1 to 3 in the above procedure to connect the F160 and the computer.

SeeAlso

Refer to page 78.

2. Select **Transfer/Send File** from the Hyper Terminal menu.
3. Select the file to be sent.
4. Set the protocol to **XMODEM** or **ZMODEM**.
5. Select **Send**.
The data transfer screen will be displayed.
6. Once the preparations have been completed on the computer, display the Basic Screen for Monitor Mode or Run Mode.

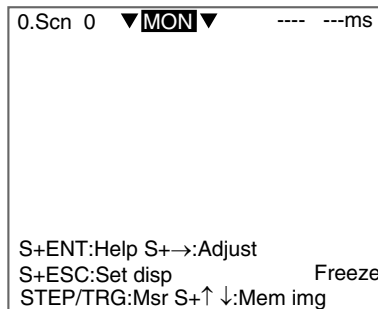

7. Move the cursor to **MON** (or **RUN**) and press the **ENT** Key.

The mode selections will be displayed.

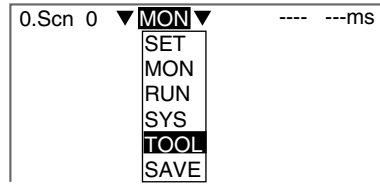

8. Select **TOOL**.

The data selections will be displayed.

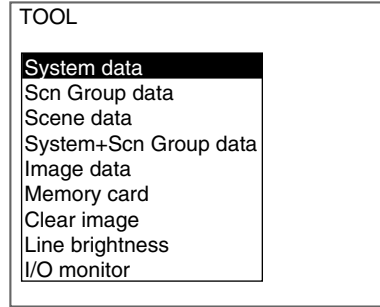

9. Select the data to be loaded.

The destination selections for load and save will be displayed.

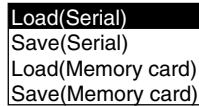

10. Select **Load (Serial)**.

11. Select the desired number for scene group, scene, or image data.

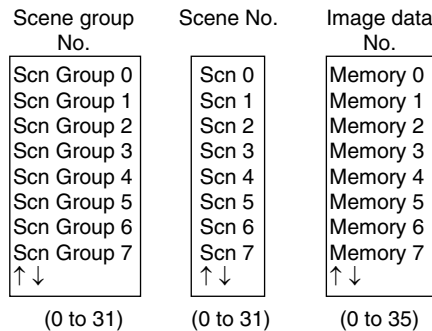

CHECK

When backing up system and scene group data, the currently displayed scene group will be loaded.

A confirmation message will be displayed.

Example:

Confirmation message when loading system data.

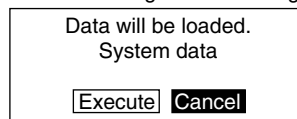

12. Select **Execute**.

The data will be transferred from the computer to the F160.

When loading has been completed, the screen in (1.) will return.

4-3-2 Backing Up to Memory Cards

This section describes inserting a Memory Card and backing up settings data to the Memory Card.

CHECK Data can be backed up to Memory Cards inserted for screen group data.

Data for scene groups 1 to 31 will be saved in the files listed below. Do not overwrite these files.

```

[DEFSCNGR]-----Directory for saving scene group data
├── SGR_0001.SGR -- Scene group 1 file
├── SGR_0002.SGR -- Scene group 2 file
│   │
│   │
│   │
│   │
└── SGR_0031.SGR -- Scene group 31 file

```

Precaution Turn OFF the power supply to the Memory Card before removing the Memory Card. Refer to page 99.

Saving from the F160 to the Memory Card

1. Insert the Memory Card.

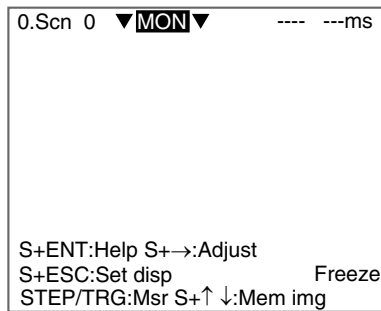

2. Display the Basic Screen for Monitor Mode or Run Mode.
3. Move the cursor to **MON** (or **RUN**) and press the **ENT** Key.

The mode selections will be displayed.

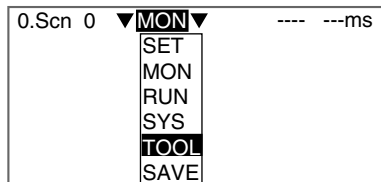

4. Select **TOOL**.

The data selections will be displayed.

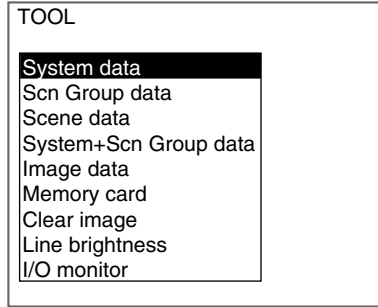

- 5. Select the data to be saved.

The destination selections for load and save will be displayed.

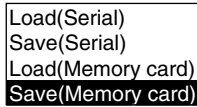

- 6. Select **Save (Memory card)**.
- 7. Select the desired number for scene group, scene, or image data.

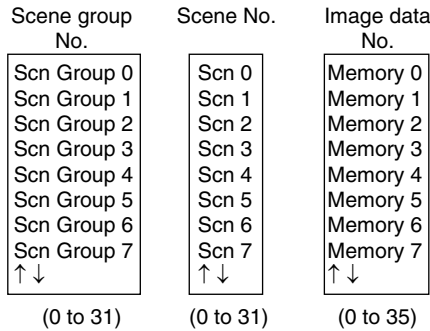

CHECK

When backing up system and scene group data, the currently displayed scene group will be saved.

A list of files in the Memory Card root directory will be displayed.

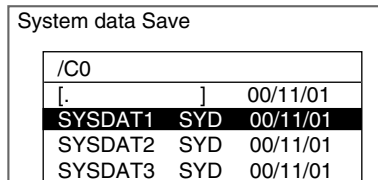

CHECK

To overwrite existing files, select the file by pressing the ENT Key and then go to step 12.

To specify a new file name, perform steps 8 to 11.

- 8. Press the **SHIFT+ESC** Keys.

The edit menu will be displayed.

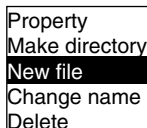

- 9. Select **New file**.

CHECK

If *Make directory* is selected, the screen for creating new directories will be displayed. Files can be saved in the newly created directory. The software keyboard will be displayed.

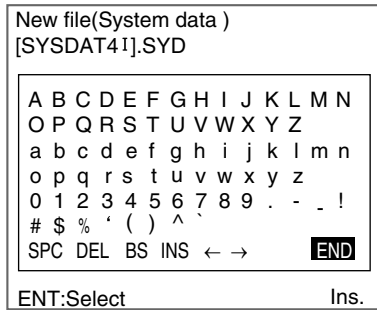

SeeAlso

Refer to page 20 for details on inputting characters.

10. Set the file name with up to 8 characters.

CHECK

Periods (.) cannot be used in file names.

11. Move the cursor to **END** and press the **ENT** Key.

A confirmation message will be displayed.

Example:

Confirmation message when saving system data.

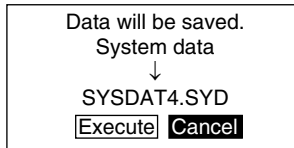

12. Select **Execute**.

When saving has been completed, the screen in (6.) will return.

Loading from the Memory Card to the F160

1. Follow steps 1 to 5 for *Saving from the F160 to the Memory Card* and move to the screen for selecting load destinations.

SeeAlso

Refer to page 83.

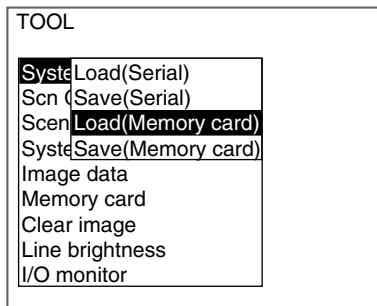

2. Select **Load (Memory card)**.

- 3. Select the desired number for scene group, scene, or image data.

Scene group No.	Scene No.	Image data No.
Scn Group 0	Scn 0	Memory 0
Scn Group 1	Scn 1	Memory 1
Scn Group 2	Scn 2	Memory 2
Scn Group 3	Scn 3	Memory 3
Scn Group 4	Scn 4	Memory 4
Scn Group 5	Scn 5	Memory 5
Scn Group 6	Scn 6	Memory 6
Scn Group 7	Scn 7	Memory 7
↑↓	↑↓	↑↓
(0 to 31)	(0 to 31)	(0 to 35)

CHECK

When backing up system and scene group data, the currently displayed scene group will be loaded.

The screen for selecting files will be displayed.

Example:

Screen for loading system data

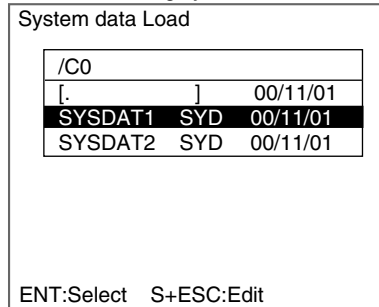

- 4. Select the file to be loaded.

A confirmation message will be displayed.

Example:

Screen when loading system data

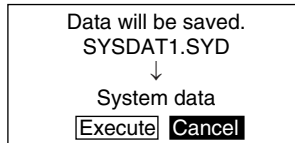

- 5. Select **Execute**.

When the loading has been completed, the screen in (1.) will return.

4-3-3 Backing Up to Flash Memory

The scene data set to scene group 0 and system data will be saved to the F160 internal flash memory. If this save operation is performed for scene groups 1 to 31, the data will overwrite the contents of the files on the Memory Card.

Precaution

Flash memory and Memory Card data is loaded each time the F160 is started up. Therefore, when settings have been changed, be sure to save to flash memory before turning the power OFF. If the power is turned OFF without saving, all of the setting changes will be lost.

1. Display the Basic Screen for Monitor Mode or Run Mode.

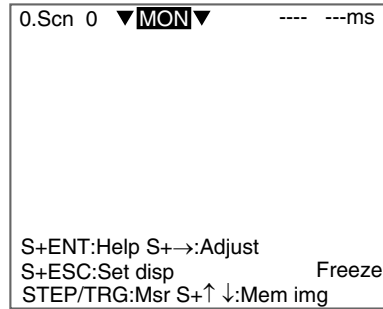

2. Move the cursor to **MON** or **RUN** and press the **ENT** Key.
A list of mode selections will be displayed.

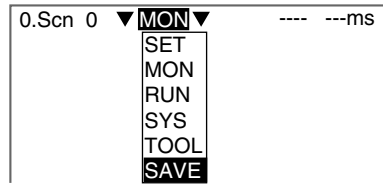

3. Select **SAVE**.
A confirmation message will be displayed.

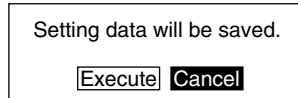

4. Select **Execute**.

Precaution

Do not turn OFF the power or input a RESET signal while a message is being displayed in any save or load operation. Data in memory will be destroyed, and the F150 may not operate correctly the next time it is started. When saving has been completed, the screen for step 1 will return.

4-4 Checking Image Density Distribution: Line Brightness

The graph showing the density distribution for 1 line in an image is called the line brightness graph. The line brightness can be shown for any line in a horizontal or vertical direction.

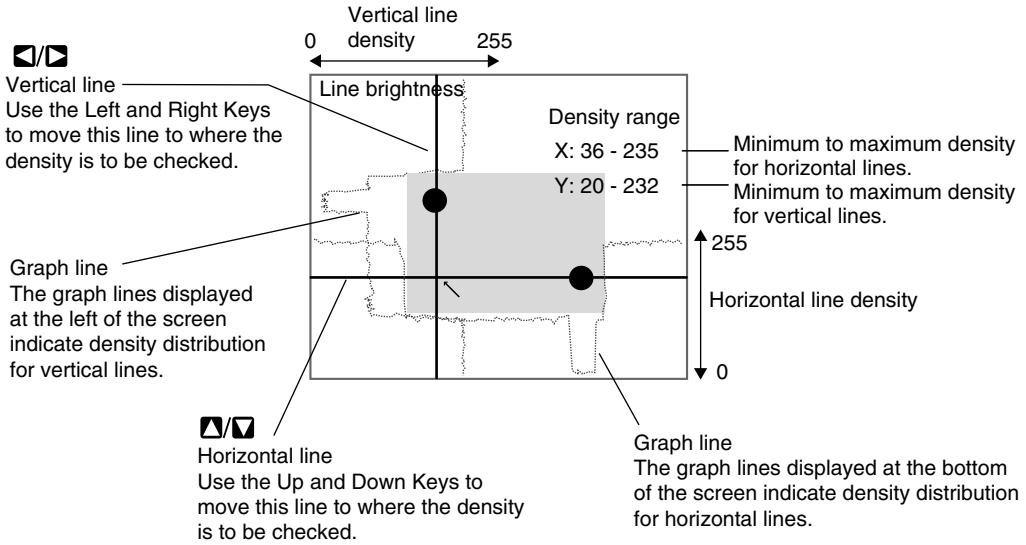

CHECK Using Line Brightness

- Use to check if the light distribution is uneven.

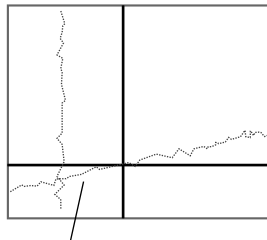

If a homogeneous color is being displayed but the graph has an incline, it indicates that the lighting is uneven.

- Use to find how great the density difference is between the location to be measured and the background.

Example: Defect detection

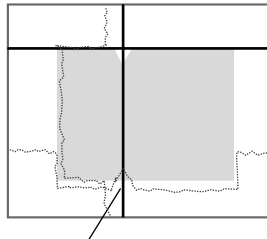

Observe the bumps in the graph line to determine how much difference in density can be detected in what areas.

1. Display the Basic Screen for Monitor Mode or Run Mode.

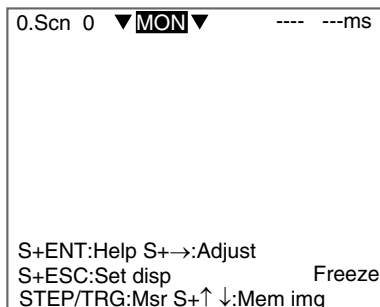

2. Move the cursor to **MON** (or **RUN**) and press the **ENT** Key. The mode selections will be displayed.

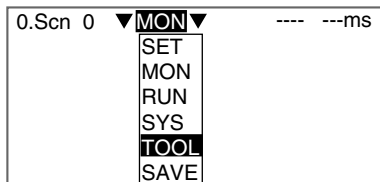

3. Select **TOOL**. The tool selections will be displayed.

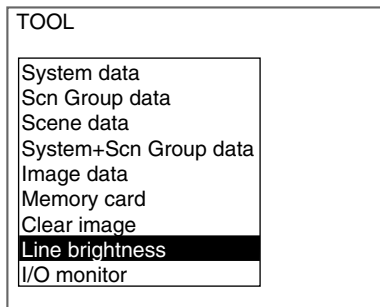

4. Select **Line brightness**. The Line Brightness screen will be displayed.

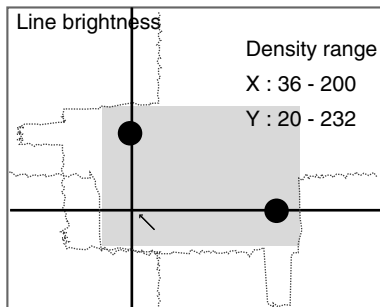

5. Move the solid line to the desired position for observing density distribution. Use the **Up/Down** Keys to move the horizontal line. Use the **Right/Left** Keys to move the vertical line.
6. Press the **ESC** Key to exit this screen. The screen in (4.) will return.

4-5 Checking I/O Status with External Devices

Use the I/O monitor function to check the communications status via serial or parallel interfaces. Wiring and communications settings can be checked.

4-5-1 Serial Interface

The communications status via the serial interface can be checked.

1. Display the Basic Screen for Monitor Mode or Run Mode.

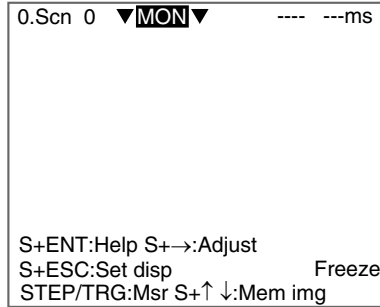

2. Move the cursor to **MON** (or **RUN**) and press the **ENT** Key.

The mode selections will be displayed.

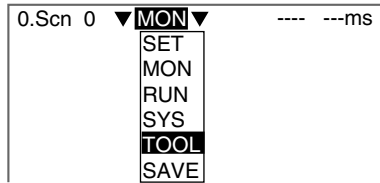

3. Select **TOOL**.

The tool selections will be displayed.

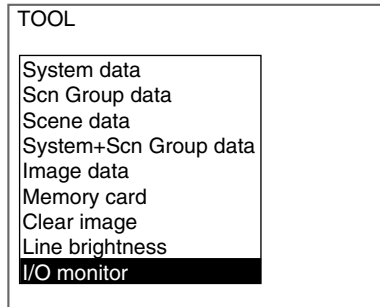

4. Select **I/O monitor**.

The interface selections will be displayed.



5. Select **Serial**.

The Serial I/O Monitor Screen will be displayed.

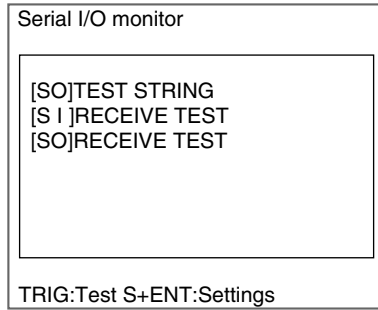

CHECK

Display Details

Display	Meaning
SO	Output to external device. Press the TRIG Key once to send a test character string "TEST STRING" from the F160 to the external device. The contents of the test character string can be changed. Refer to page 91.
SI	Input from external device. If more than 26 characters are received, only the first 26 characters will be displayed. If <i>Echo back</i> is set to ON, the received data will be returned as is to the external device. Refer to page 91.

6. Press the **ESC** Key to exit this screen.
The screen in (5.) will return.

Changing Test Character String and Echo Back

1. Display the Serial I/O Monitor Screen and press the **SHIFT+ENT** Keys.
The screen for making detailed settings will be displayed.

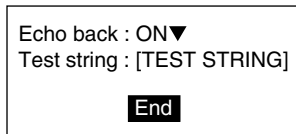

2. Select **ON** or **OFF** for **Echo back**.
3. Move the cursor to the square brackets [] and press the **ENT** Key.
The software keyboard will be displayed.

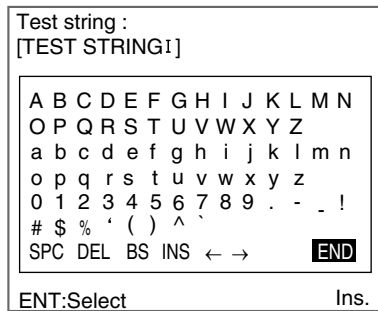

SeeAlso

Refer to page 20 for details on inputting characters.

4. Change the test string. Up to 12 characters can be inserted.
5. Select **END** and the screen in (2.) will return.
6. Move the cursor to **End** and press the **ENT** Key.

The Serial I/O Monitor Screen will return.

4-5-2 Parallel Interface

The communications status via the parallel interface can be checked.

1. Display the Basic Screen for Monitor Mode or Run Mode.

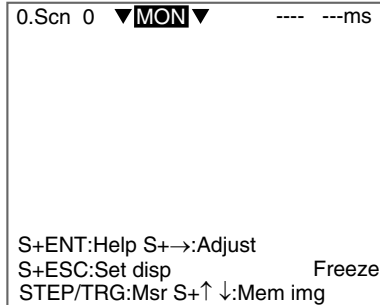

2. Move the cursor to **MON** (or **RUN**) and press the **ENT** Key.

The mode selections will be displayed.

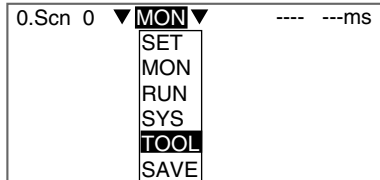

3. Select **TOOL**.

The tool selections will be displayed.

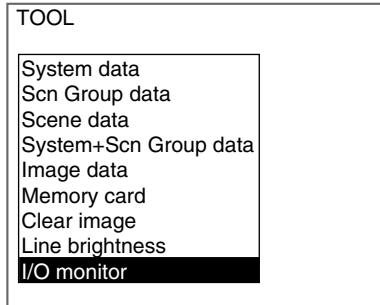

4. Select **I/O monitor**.

The interface selections will be displayed.



5. Select **Parallel**.

The Parallel I/O Monitor Screen will be displayed.

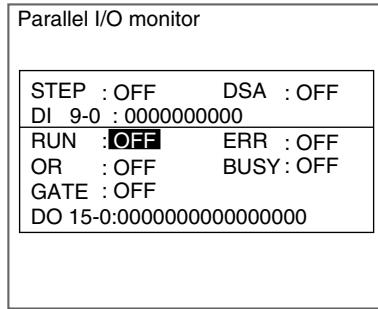

CHECK

Display Details

Display	Meaning
STEP	Displays the input status for each signal from the external device to the F160.
DSA	
DI	
RUN	Displays the output status for each signal from the F160 to the external device.
ERR	
OR	These displays can be changed to ON/OFF or 0/1 even if measurements are not executed.
BUSY	
GATE	Move the cursor to the display item. The display will change each time the ENT Key is pressed.
DO	

- Press the **ESC** Key to exit this screen.
The screen in (5.) will return.

4-6 Memory Card Operations

Data settings and measurement images can be saved from the F160 to a Memory Card. The files on the Memory Card can be copied and the file names changed. This section explains these operations for Memory Cards.

Precaution

Turn OFF the power supply to the Memory Card before removing the Memory Card. If the power is not turned OFF before the Memory Card is removed, the Memory Card and the F160 may be damaged. Refer to page 99.

4-6-1 Creating Directories

Directories can be created in the Memory Card and files can be stored in those directories. It is easier to find files if separate directories are created for related files.

- Insert the Memory Card.

2. Display the Basic Screen for Monitor Mode or Run Mode.

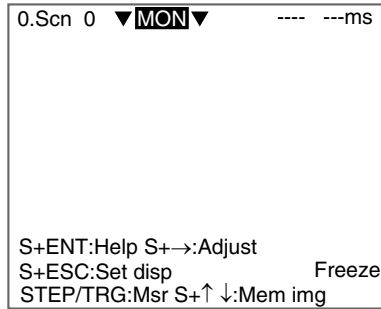

3. Move the cursor to **MON** (or **RUN**) and press the **ENT** Key. The mode selections will be displayed.

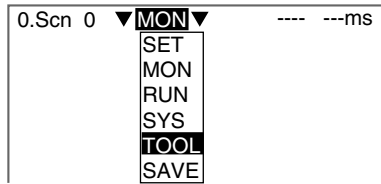

4. Select **TOOL**. The tool selections will be displayed.

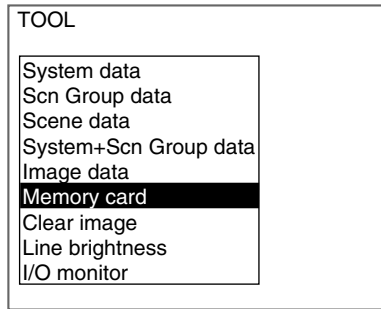

5. Select **Memory card**. The Copy file/File operation/Drive status Menu will be displayed.

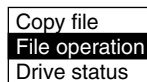

6. Select **File operation**. A list of files in the Memory Card root directory will be displayed.

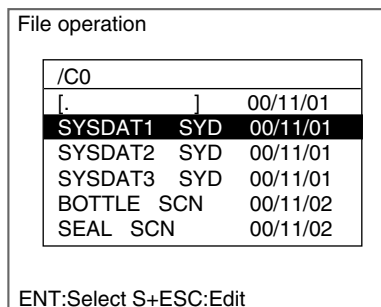

7. Press the **SHIFT+ESC** Keys.

The edit menu will be displayed.

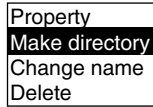

8. Select **Make directory**.

A software keyboard will be displayed.

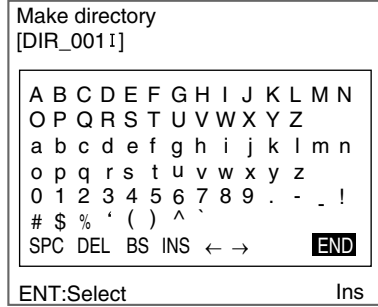

SeeAlso Refer to page 20 for details on inputting characters.

9. Set up to 8 characters.

CHECK Periods (.) cannot be used in file names.

10. Move the cursor to **END** and press the **ENT** Key.

A confirmation message will be displayed.

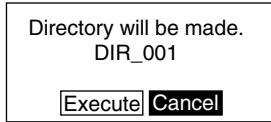

11. Select **Execute**.

The directory will be created and the screen in (7.) will return.

CHECK The directory is displayed in the list of files, encased in square brackets []. Move the cursor to the directory and press the **ENT** Key to display a list of files in that directory.

Example

When directory [DIC_1] is selected.

The files in [DIC_1] will be displayed.

/C0		
[.]		00/11/01
[DIC_1]		00/11/01
SYSDAT1	SYD	00/11/01
SYSDAT2	SYD	00/11/01
SYSDAT3	SYD	00/11/01
SEAL	SCN	00/11/02



/C0/DIC_1		
[]		00/11/01
[]		00/11/01
MARK-B	SCN	00/11/01
MARK-C	SCN	00/11/01
MARK-D	SCN	00/11/02

Select [.] to move up a level.

4-6-2 Copying Files

1. Perform steps 1 to 5 for *Creating Directories* and display the Copy file/File operation/Drive status Menu.

SeeAlso Refer to page 93.

2. Select **Copy file**.

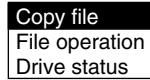

A list of files in the Memory Card root directory will be displayed.

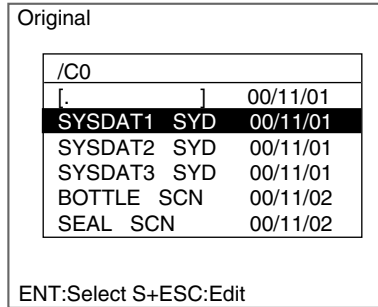

3. Move the cursor to the file to be copied and press the **ENT** Key.

A screen for specifying the copy destination will be displayed.

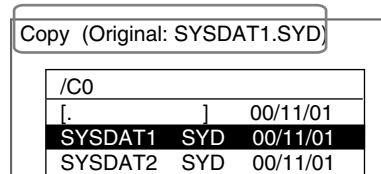

CHECK

To overwrite existing files, select the file by pressing the ENT Key and then go to step 8.

To specify a new file name, perform steps 4 to 8.

4. Press the **SHIFT+ESC** Keys.

The edit menu will be displayed.

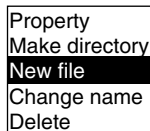

5. Select **New file**.

CHECK

If *Make directory* is selected, the screen for creating new directories will be displayed. Files can be saved in the newly created directory.

The software keyboard will be displayed.

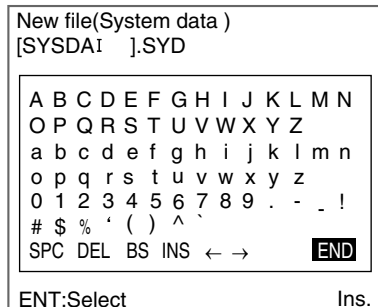

SeeAlso

Refer to page 20 for details on inputting characters.

6. Set the file name with up to 8 characters.

CHECK

Periods (.) cannot be used in file names.

7. Move the cursor to **END** and press the **ENT** Key.

A confirmation message will be displayed.

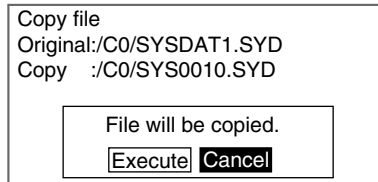

8. Select **Execute**.

The file will be copied and the screen in (2.) will return.

4-6-3 Checking File Properties

The size, type, or date a file was created can be checked.

1. Perform steps 1 to 6 for *Creating Directories* and display the list of file names.

SeeAlso

Refer to page 93.

2. Move the cursor to the file for which the information is to be checked and press the **SHIFT + ESC** Keys.

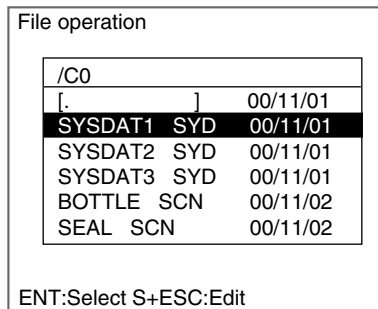

The edit menu will be displayed.

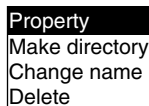

3. Select **Property**.

The properties of the selected file will be displayed.

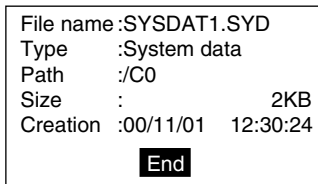

4. Select **End**.

The screen in (2.) will return.

4-6-4 Changing File Names

CHECK

Only the file name can be changed. The directory name cannot be changed.

1. Perform steps 1 to 6 for *Creating Directories* and display the list of file names.

SeeAlso

Refer to page 93.

2. Move the cursor to the file for which the name is to be changed and press the **SHIFT + ESC** Keys.

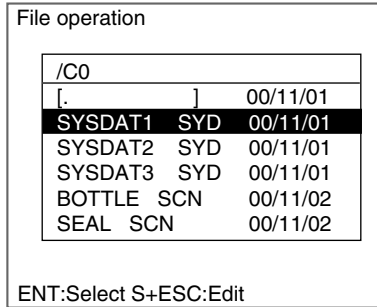

The edit menu will be displayed.

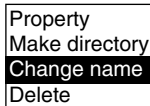

3. Select **Change name**.

A software keyboard will be displayed.

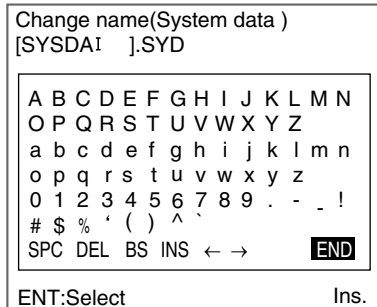

SeeAlso

Refer to page 20 for details on inputting characters.

4. Set the file name with up to 8 characters.

CHECK

Periods (.) cannot be used in file names.

5. Move the cursor to **END** and press the **ENT** Key.

A confirmation message will be displayed.

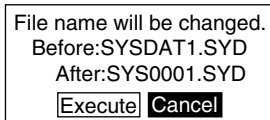

6. Select **Execute**.

The file name will be changed and the screen in (2.) will return.

CHECK

When the scene group function is used, scene groups 1 to 31 are saved in the root directory of the Memory Card under the file names shown below.

Do not change these file names. If these file names are changed, measurement setups will no longer be able to be changed by switching scene

2. Select **Drive status**.

```
Copy file
File operation
Drive status
```

The Drive Status Screen will be displayed.

```
Drive status

Drive C0 : Inserted ▼
Free space: Inserted 436KB
Stop
End
```

3. If a Memory Card is inserted, "Inserted" will be highlighted. Change the display to **Stop**.

CHECK

If a Memory Card is not inserted, the display will be "Not inserted."

4. Select **End**.

A confirmation message will be displayed.

```
Memory card can be removed
safely.
Push ENT after remove it.

OK
```

5. Remove the Memory Card and press the **ENT** Key.
The screen in (2.) will return.

SECTION 5 System Settings

This section describes how to set conditions related to the system environment. Refer to the *Communications Reference Manual* for information on communications specifications.

5-1	Entering System Mode	102
5-2	Camera Settings	102
5-3	Screen Display and Monitor	104
5-3-1	Measurement Screen Settings	104
5-3-2	Selecting Color or Monochrome Monitors	104
5-3-3	Changing Character or Figure Colors	105
5-3-4	Creating Original Colors	106
5-4	Customizing Operations	108
5-4-1	Capturing and Saving Images	108
5-4-2	Shortening Scene Group Switching Time	109
5-4-3	Setting Passwords	110
5-5	Setting Conditions for Saving Measurement Images	112
5-5-1	Displaying Stored Images	113
5-5-2	Clearing All Stored Images	114
5-6	Using BUSY Signals	115
5-7	Selecting Items to be Shown in Overall Judgements	117
5-8	Setting Startup Conditions	118
5-9	Setting the Calendar Date and Time (Date/Time)	119
5-10	Checking System Information	119
5-10-1	Checking Remaining Memory Space and Battery Status	119
5-10-2	Checking the Software Version	120
5-11	Changing to Expert Menus	120

5-1 Entering System Mode

To set conditions related to the system environment it is necessary to enter System Mode.

1. Display the Basic Screen for Monitor Mode or Run Mode.

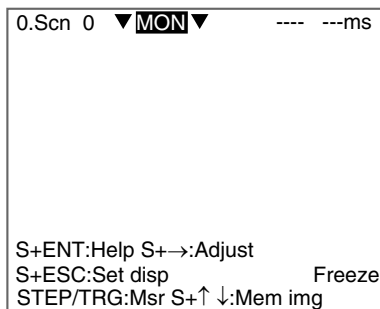

2. Move the cursor to **MON** and press the **ENT** Key.

The mode selections will be displayed.

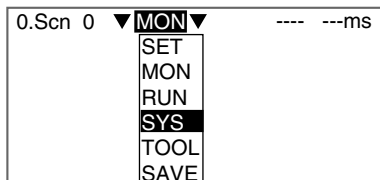

3. Select **SYS**.

The System Settings Screen will be displayed.

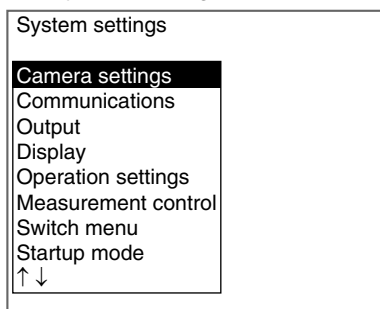

CHECK

The *Output* selection cannot be used in the Conversational Menus.

5-2 Camera Settings

Specify the model of the connected Camera and Intelligent Lighting (if using any). The model is written on each Unit.

Menu item	Models	Details
Camera	F150-S1A F160-S1* F160-S2 Other	Select the model of the connected Camera.

Menu item	Models	Details
Intelligent Lighting 0	Out of use* LTC20 LTC50	If a Camera with Intelligent Lighting is connected, select the model of the Intelligent Lighting. Always set the DIP switch on the Intelligent Lighting to 0, regardless of the Camera number. Refer to the <i>Setup Manual</i> .
Intelligent Lighting 1	Out of use*	Only one Camera can be used with the Conversational Menus so this menu item must be set to <i>Out of use</i> .

Note The default setting is marked with an asterisk.

1. Enter System mode and select **Camera settings**.

SeeAlso

Refer to page 102.

The Camera Settings Screen will be displayed.

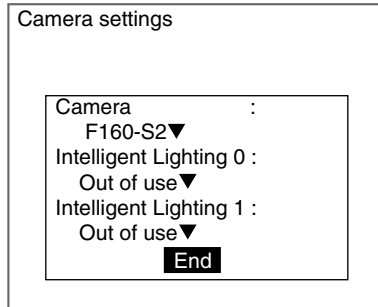

2. Select the model of the connected Camera.
3. If using Intelligent Lighting, select the model.
4. Select **End**.

The settings will be registered and the System Settings Screen will return.

CHECK

If *Other* is selected under *Camera*, the Camera Settings (Detail) Screen will be displayed.

The settings for F200/F300 Cameras are listed in the *Setup Manual*. Refer to the *Setup Manual*.

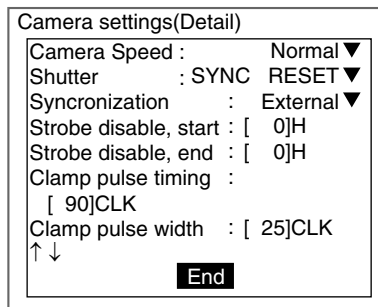

Precaution

When changing the Camera model, save settings data in flash memory. Set the measurement conditions after starting the F160 again.

5-3 Screen Display and Monitor

5-3-1 Measurement Screen Settings

Select the type of image to be displayed in Run Mode and Monitor Mode. The display settings made here will be reflected in all scenes.

Selection	Details
Freeze*	A still of the image taken by the Camera is displayed. This image is updated when measurement is performed. Select <i>Freeze</i> when measuring moving objects.
Through	The latest image taken by the Camera is displayed directly. If measurement is performed using Through display, the measurement time will be increased by the amount of time from when the measurement command is input until the image input starts. This delay is included in the measurement time shown on the Monitor and Run Mode screens.

Note The default setting is marked with an asterisk.

1. Enter System mode and select **Display**.

SeeAlso

Refer to page 102.

The Display Settings/Monitor/Designate Colors/Make Colors Menu will be displayed.

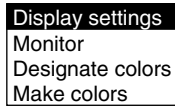

2. Select **Display settings**.

The Display Settings Screen will be displayed.

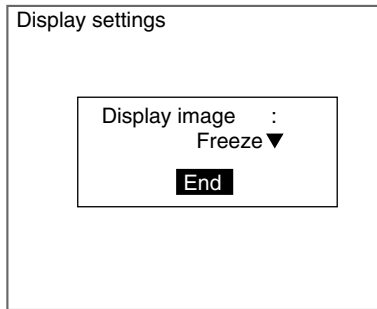

3. Change the settings for each item.
4. Select **End**.

The settings will be registered and the screen in (2.) will return.

5-3-2 Selecting Color or Monochrome Monitors

Select the type of monitor to be connected. When color monitors are used, characters and figures can be color-coded and displayed in color.

1. Enter System mode and select **Display**.

SeeAlso

Refer to page 102.

The Display Settings/Monitor/Designate Colors/Make Colors Menu will be displayed.

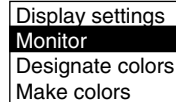

2. Select **Monitor**.

The Monitor Settings Screen will be displayed.

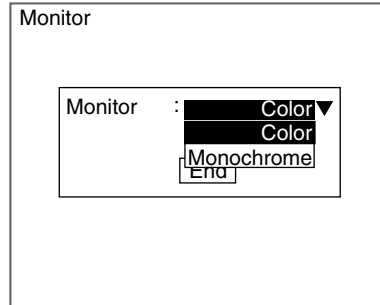

3. Select the monitor type.
4. Select **End**.

The settings will be registered and the screen in (2.) will return.

5-3-3 Changing Character or Figure Colors

The color for characters or added figures can be set. Change the color when it is difficult to see the character or figure on the image. The display color set here, however, will be reflected in all scenes.

For color monitors, select white, black, red, green, blue, yellow, or original (a combination of up to any 7 colors can be set.)

For monochrome monitors, select white or black.

SeeAlso Refer to page 106 for information on creating original colors.

The positions where color can be changed are described below.

Normal and Background Colors

Messages displayed on the screen will be appear in the color set under *Normal*. Menu boxes will shaded in the color set under *Background*.

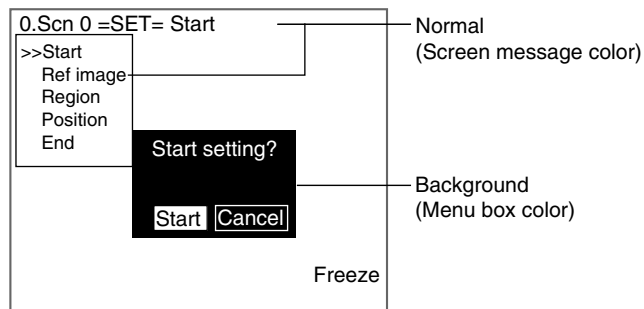

OK and NG Colors

The judgement display, all measurement values, and the measurement region will be displayed in the color set under *OK color* or *NG color*, depending on the measurement result.

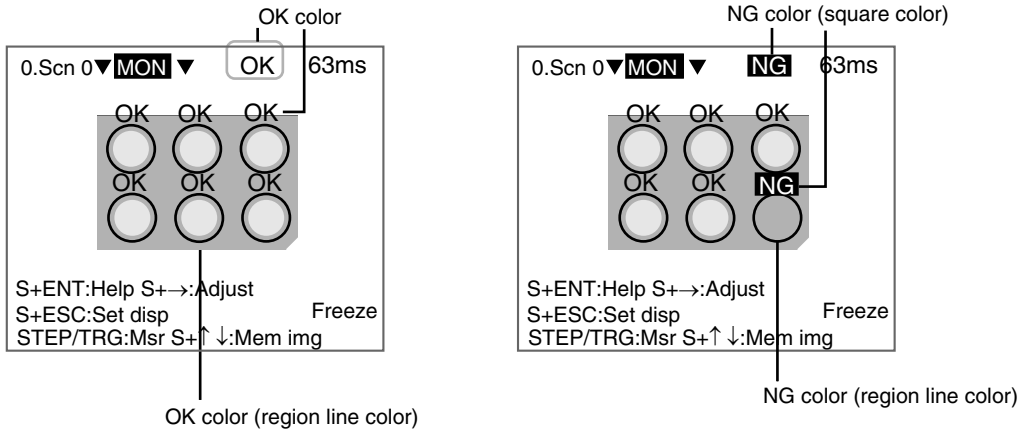

Figure Colors 0 to 6

Figure colors 0 to 6 cannot be used with the Conversational Menus.

1. Enter System mode and select **Display**.

SeeAlso

Refer to page 102.

The Display Settings/Monitor/Designate Colors/Make Colors Menu will be displayed.

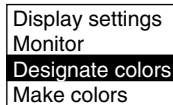

2. Select **Designate colors**.

The Designate Colors Screen will be displayed.

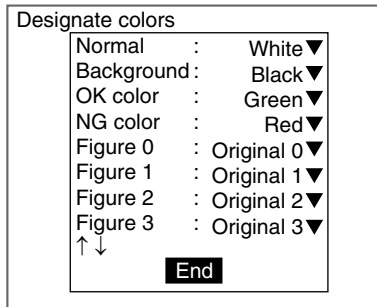

3. Make the settings for each item.
4. Select **End**.

The settings will be registered and the screen in (2.) will return.

5-3-4 Creating Original Colors

Up to 7 original colors can be created for displaying characters or figures, using a combination of red, green, and blue.

SeeAlso

Refer to page 105 for information on how to display the original color.

The default settings are shown below.

Display item	R (red)	G (green)	B (blue)
Original 0	32	32	32
Original 1	64	64	64
Original 2	96	96	96
Original 3	128	128	128
Original 4	160	160	160
Original 5	196	196	196
Original 6	224	224	224

SeeAlso

1. Enter System mode and select **Display**.

Refer to page 102.

The Display Settings/Monitor/Designate Colors/Make Colors Menu will be displayed.

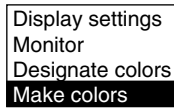

2. Select **Make colors**.

The menu for selecting color numbers will be displayed.

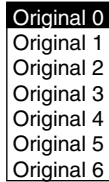

3. Select a color number to set for the new color.

The Make Color Screen will be displayed.

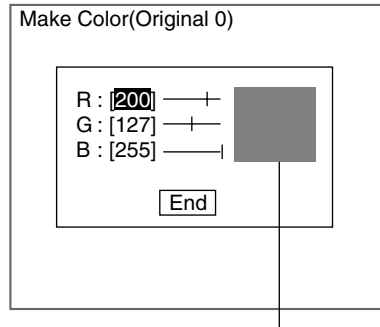

The set color will be displayed here.

4. Make the settings for each item.

Up and Down Keys: Moves the cursor

Left and Right Keys: Reduces/increases the color at the cursor position by one.

SHIFT + Left/Right Keys: Reduces/increases the color at the cursor position by ten.

5. Select **End**.

The settings will be saved and the screen in (3.) will return.

5-4 Customizing Operations

The following setting options are available to customize operations. However, *Set key operation*, *Setting menu masking*, and *Processing menu masking* cannot be used with the Conversational Menus.

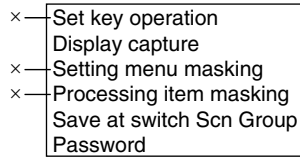

5-4-1 Capturing and Saving Images

Enabling the display capture function allows images displayed on the monitor screen to be captured and saved to the Memory Card.

Stored images can be pasted to documents on a personal computer or loaded to the F160 and re-measured.

The default setting is OFF.

CHECK

The capture operation takes several seconds, during which measurement cannot be performed. To prevent incorrect operation, set this function to OFF.

1. Enter System mode and select **Operation settings**.

SeeAlso

Refer to page 102.

The Menu will be displayed.

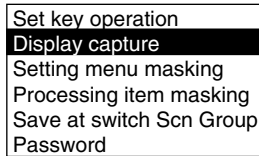

2. Select **Display capture**.

The Display Capture Screen will be displayed.

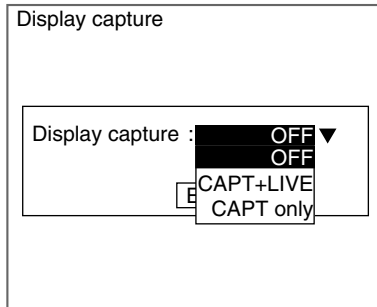

3. Change the settings.

OFF: Images are not captured.

CAPT+LIVE: Two types of image are captured (CAPT***.BMP and LIVE***.BMP).

CAPT only: Only CAPT***.BMP images are captured.

4. Select **End**.

The settings will be registered and the screen in (2.) will return.

Execution Keys

The following keys execute display capture when the display capture function is enabled.

- For F160-KP: F9 Key
- For F150-KP: SHIFT + Left + Right Keys (press 3 keys at the same time.)

Display Capture Results

When display capture is executed, a directory called IMAGE will automatically be created in the root directory of the Memory Card and the following two types of files will be stored in that directory.

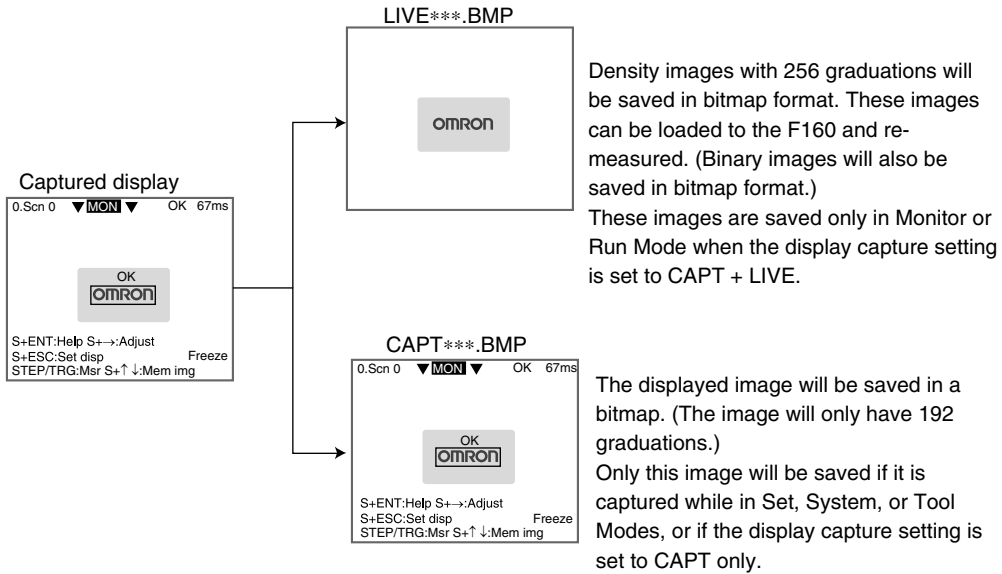

A serial number starting from 000 will be automatically allocated to ***. The same number is used for both files.

5-4-2 Shortening Scene Group Switching Time

Normally, settings data is saved to flash memory and the Memory Card when scene groups are changed. The time taken to save is, therefore, added to the time taken to change scene groups. The time to change scene for changes in measurement setups can be reduced by omitting the save process.

Precaution

If this function is set to OFF and settings data changed, always save the data before changing scene groups. When scene groups are changed, data from the flash memory or the Memory Card is loaded. So if the changed settings data is not saved, the data will be replaced by the loaded data. Refer to page 86.

1. Enter System mode and select **Operation settings**.

SeeAlso

Refer to page 102.
The Menu will be displayed.

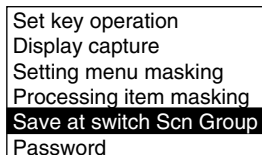

2. Select **Save at switch Scn Group**.

The Saving at Switch Scn Group Settings Screen will be displayed.

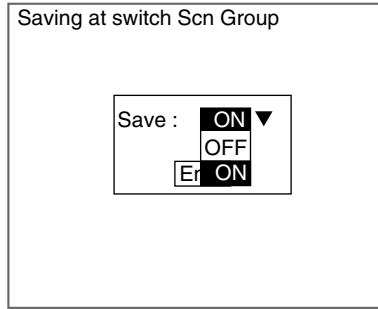

3. Select **ON** or **OFF**.
 ON: Saves the data (default)
 OFF: Does not save the data

4. Select **End**.

The setting will be saved and the screen in (2.) will return.

5-4-3 Setting Passwords

Passwords can be set to prevent settings being changed through incorrect operation. Set whether or not a password is required for the following two operations.

- When moving from Run Mode to Set, Monitor, or other modes.
- When changing scenes in Run Mode.

1. Enter System mode and select **Operation settings**.

SeeAlso

Refer to page 102.

The Menu will be displayed.

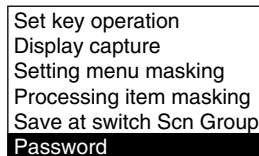

2. Select **Password**.

The Password Settings Screen will be displayed.

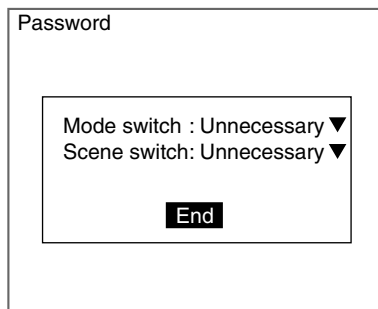

3. Set **Necessary** or **Unnecessary**.
4. Select **End**.

If **Necessary** has been selected, the Input Password Settings Screen will be displayed.

```

Input Password
[I      ]

A B C D E F G H I J K L M N
O P Q R S T U V W X Y Z
a b c d e f g h i j k l m n
o p q r s t u v w x y z
0 1 2 3 4 5 6 7 8 9 . - _ !
# $ % ' ( ) ^ `
SPC DEL BS INS ← →  END
ENT>Select                               Ins.
    
```

SeeAlso

Refer to page 20 for details on inputting characters.

5. Set a password of 6 to 8 characters.
6. Select **END**.

The settings will be registered and the screen in (2.) will return.

Example: Password Set for Mode Switching

1. Move the cursor to the mode and press the **ENT** Key.

```

0.Scen 0 ▼MON▼      ---- ---ms
    
```

The Input Password Settings Screen will be displayed.

```

Input Password
[I      ]

A B C D E F G H I J K L M N
O P Q R S T U V W X Y Z
a b c d e f g h i j k l m n
o p q r s t u v w x y z
0 1 2 3 4 5 6 7 8 9 . - _ !
# $ % ' ( ) ^ `
SPC DEL BS INS ← →  END
ENT>Select                               Ins.
    
```

2. Enter the password.
3. Select **END**.

If the entered password is correct, the mode selections will be displayed.

```

0.Scen 0 ▼MON▼      ---- ---ms
          SET
          MON
          RUN
          SYS
          TOOL
          SAVE
    
```

If the entered password is incorrect, an error message will be displayed.

```

Password is incorrect.
          OK
    
```

CHECK

Forgotten Passwords

The password can be checked by inputting a password confirmation command (page 111) (normal PASSWORD command) from the serial interface. Refer to the *Communications Reference Manual*.

Note The only normal command that can be used with the Conversational Menus is the PASSWORD command. No other normal commands are supported.

5-5 Setting Conditions for Saving Measurement Images

The F160 can save up to 35 measured images. These 35 scenes are shared by 32 scenes. The condition for saving the images can be selected from saving only when the measurement result is NG or saving all images regardless of the measurement result.

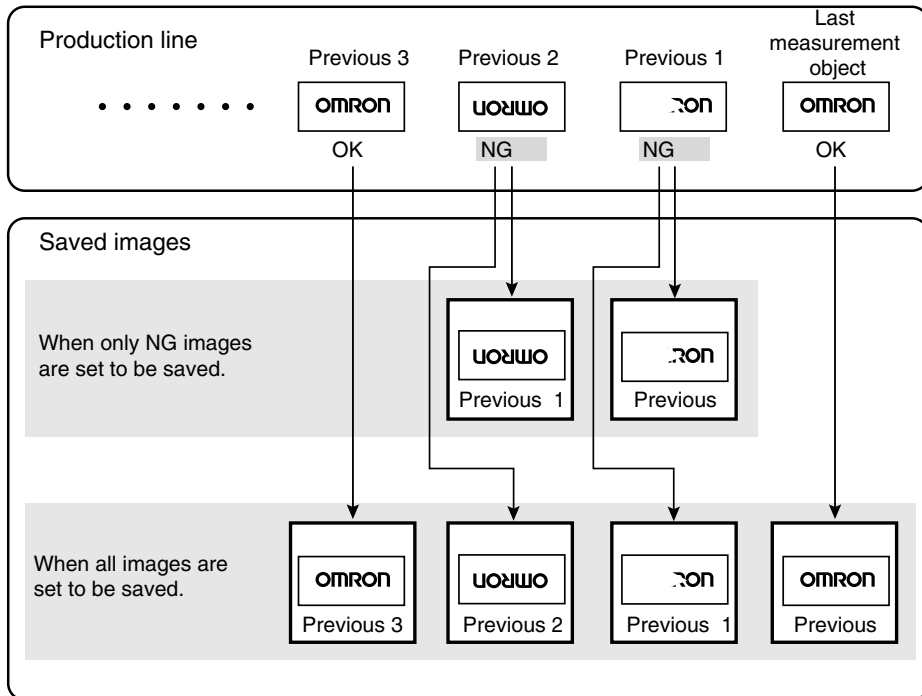

Precaution

Stored images will be cleared when the power is turned OFF. Images to be kept must be backed up to a personal computer or Memory Card. Refer to page 78.

1. Enter System mode and select **Measurement control**.

SeeAlso

Refer to page 102.

The Measurement Control Settings Screen will be displayed.

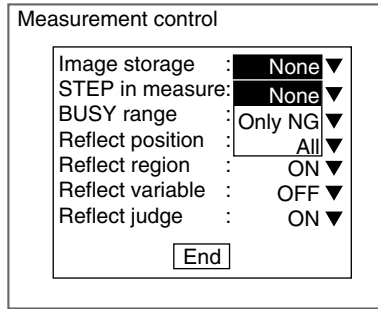

2. Change the conditions under **Image storage**.
3. Select **End**.

The settings will be recorded and the System Mode Screen will return.

5-5-1 Displaying Stored Images

By displaying a stored image on the screen, the reason for a previous NG judgement can be checked. Also, measurement can be re-performed on the stored image with different evaluation criteria.

The current image is displayed in the lower-right corner of the screen.

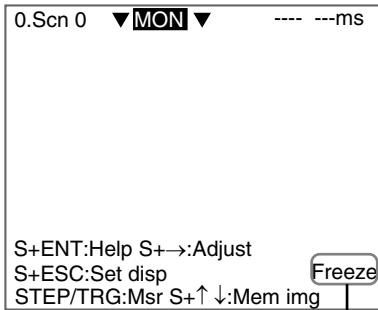

Note: Current image status (See note 1.)

When saved images are displayed (See note 2.)



Memory number the displayed image is stored under.

The NG image saved 2 before the last image.

Display	Details	
Freeze	The image that has just been measured is displayed. Whether this image is a freeze image or a through image depends on the settings in SYS/Conditions. Refer to page 104.	Note 1
Through		
____ (Memory □)	A previously stored image is displayed. Up to 35 images are stored in accordance with the conditions for storage of measured images (only NG or All). When the image is to be backed up to a personal computer, specify a memory number in □.	Note 2
→ Types of saved images		
Last	The measured image most recently stored is displayed. If this image had an NG judgement, "Last" will be highlighted.	
Last *	The * after "Last" contains the number of screens stored before the image. Up to 35 previous images can be displayed. "Last *" will be highlighted for NG images.	
-----	Either no image is stored in memory, or an image other than a measurement image (an image loaded from a personal computer)	

Switching Method

In Monitor Mode or Run Mode, press the SHIFT + Up/Down Keys to switch between images.

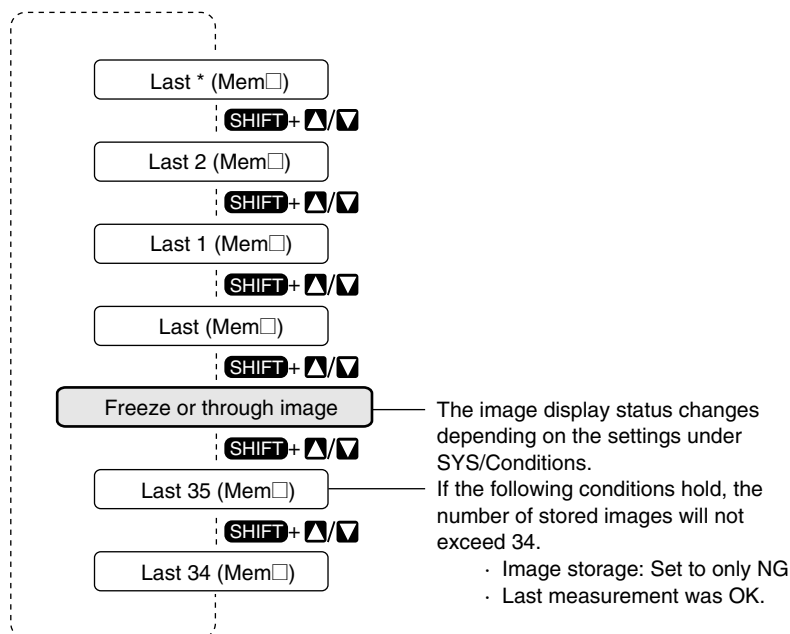

5-5-2 Clearing All Stored Images

All images are automatically cleared when the power is turned OFF, but the images can also be cleared without turning OFF the power.

1. Display the Basic Screen in Monitor or Run Modes.

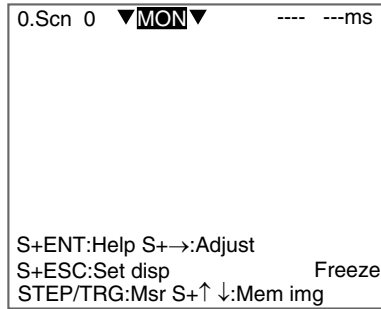

2. Move the cursor to **MON** (or **RUN**) and press the **ENT** Key. The mode selections will be displayed.

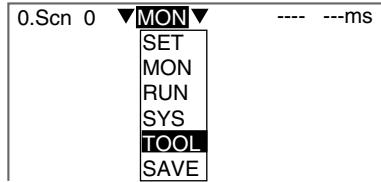

3. Select **TOOL**. The data selections will be displayed.

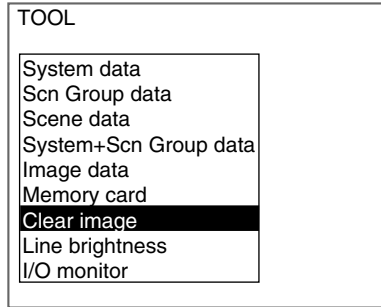

4. Select **Clear image**. A confirmation message will be displayed.

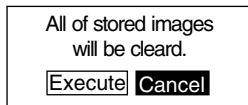

5. Select **Execute**. The stored images will be cleared and the screen in (4.) will return.

5-6 Using **BUSY** Signals

The **BUSY** signal is a control signal used to show that the F160 is busy processing. The ON/OFF timing of this **BUSY** signal is monitored at the external device to time communications. The handling of the **BUSY** signal can be changed to create a smoother system.

STEP in Measure

Measurement will not be performed by the F160 during another measurement, even if the STEP signal turns ON. Set whether or not the ERR signal will turn ON to notify the external device that the STEP signal was not accepted.

Selection	Details
ERR ON (See note.)	Measurement will not be performed and the ERR signal will turn ON if the STEP signal turns ON during processing. The ERR signal will turn OFF when the next STEP signal is input at the correct timing.
OFF	The ERR signal will not turn ON even if the STEP signal turns ON during processing. Measurement will not be performed.

Note The default setting is marked with an asterisk.

BUSY Range

Select at what point in the F160 processing that the BUSY signal will turn OFF.

Selection	Details
Image input completed	<p>The BUSY signal turns OFF when the image input has been completed. This can be used as a guide as to whether or not the work piece can be moved.</p> <p>When this selection is made, do not enter the next command until measurement has been completed, even if the BUSY signal has turned OFF. If the next command is input before the measurement has been completed, the current processing and the input command may not be executed correctly.</p>
Measurement completed*	<p>The BUSY signal turns OFF when the measurement has been completed.</p>
Display completed	<p>The BUSY signal turns OFF when the display of the measurement result has been completed. The F160 remains busy until the display has been completed.</p>

Note The default setting is marked with an asterisk.

1. Enter System mode and select **Measurement control**.

SeeAlso Refer to page 102.

The Measurement Control Settings Screen will be displayed.

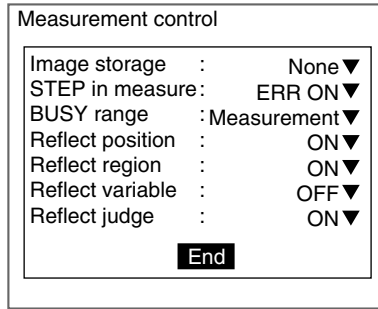

2. Change the **STEP in measure** and **BUSY range** settings.
3. Select **End**.

The settings are registered and the System Mode Screen will return.

5-7 Selecting Items to be Shown in Overall Judgements

Select which of the following two items will be shown in the overall judgement output to the OR signal of the parallel interface.

- Position compensation judgement result
- Judgement result for each region

CHECK

The overall judgement is displayed at the top of the Monitor and Run Mode screens.

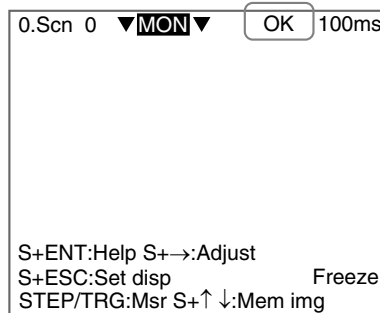

1. Enter System mode and select **Measurement control**.

SeeAlso

Refer to page 102.

The Measurement Control Settings Screen will be displayed.

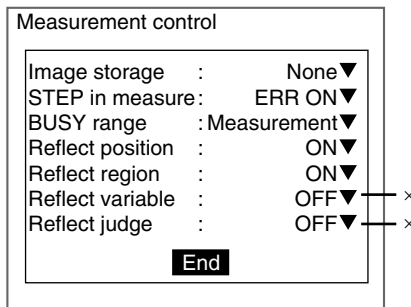

x: Cannot be used with the Conversational Menus

2. Change the settings.

3. Select **End**.

The settings will be registered and the System Mode Screen will return.

5-8 Setting Startup Conditions

Use the following procedure to set the status when the power is turned ON. If the F160 is set to start in Run Mode for the scene where the desired measurement conditions are registered, measurement of objects can be started by simply turning the power ON.

Also, unnecessary menu selection screens and Camera setting screens that are always displayed at startup can be set to not be displayed.

Item	Details
Startup scene group	Selections: 0 to 31* When a scene group between 1 and 31 is selected, make sure the Memory Card where that scene group is stored is inserted.
Startup scene	Selections: 0* to 31, OFF(scene number when saved to flash memory)
Startup mode	Selections: Set, Monitor*, Run, OFF(mode when saved to flash memory)
Startup language	Select the language for screen messages. Selections: Japanese*, English
Menu selection at startup	The F160 has a Conversational Menu and an Expert Menu. Select whether or not to display the Select Menus Screen at startup. Refer to page 13. Selections: ON* (display), OFF (no display)
Camera settings at startup	Select whether or not to display the Camera Settings Screen. Refer to page 13. Selections: ON* (display), OFF (no display)

Note The default setting is marked with an asterisk.

1. Enter System mode and select **Startup mode**.

SeeAlso

Refer to page 102.

The Startup Mode Settings Screen will be displayed.

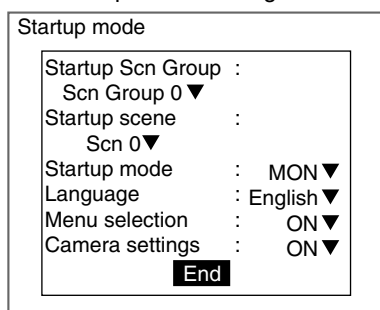

2. Change the settings.
3. Select **End**.

The settings will be saved and the System Mode Screen will return.

5-9 Setting the Calendar Date and Time (Date/Time)

Check if the internal calendar is set to the correct date and time and adjust if necessary.

1. Enter System mode and select **Date/Time**.

SeeAlso

Refer to page 102.

The Date/Time Settings Screen will be displayed.

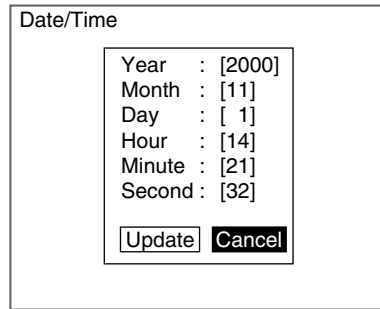

SeeAlso

Refer to page 19 for details on inputting values.

2. Check if the date and time is correct. Adjust if necessary.
3. If the settings do not require adjustment, select **Cancel** to exit this screen. Select **Update** to save changes to the date and time. The settings will be registered and the System Mode Screen will return.

5-10 Checking System Information

5-10-1 Checking Remaining Memory Space and Battery Status

Use the following procedure to check the remaining work memory and internal flash memory and the status of the battery mounted for date and time data backup.

1. Enter System mode and select **System information**.

SeeAlso

Refer to page 102.

The Memory capacity/Version Menu will be displayed.

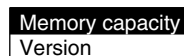

2. Select **Memory capacity**.

The memory capacity will be displayed.

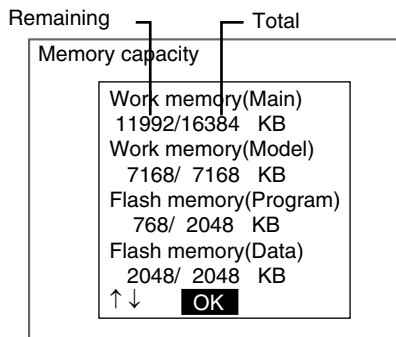

Press the **Down** Key to scroll down and display the rest of the information. The battery status will be displayed at the bottom of the list.

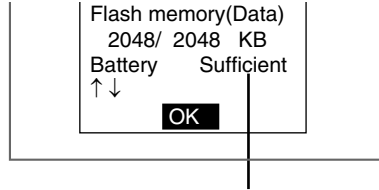

If Replace is displayed here, replace the battery.

Refer to the *Setup Manual*.

3. Select **OK** to exit this screen. The screen in (2.) will return.

5-10-2 Checking the Software Version

Use the following procedure to check the software system version.

1. Enter System mode and select **System information**.

SeeAlso

Refer to page 102.

The Memory Capacity/Version Menu will be displayed.

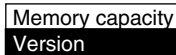

2. Select **Version**. The version information will be displayed.

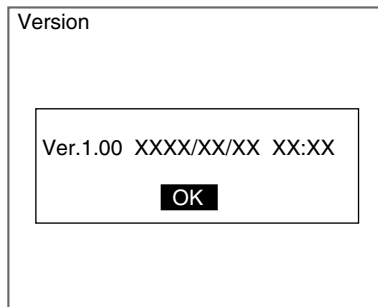

3. Select **OK** to exit this screen. The screen in (2.) will return.

5-11 Changing to Expert Menus

The F160 has Conversational Menus and Expert Menus.

You can switch to the Expert Menu with the inspection conditions (scene data) set using the Conversational Menu still saved. Fine adjustments can then be made to those settings.

1. Enter System mode and select **Switch menu**.

SeeAlso

Refer to page 102.

The Switch Menu Screen will be displayed.

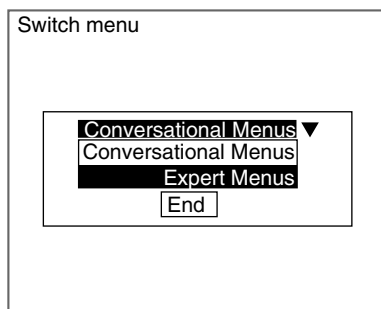

2. Switch from **Conversational Menus** to **Expert Menus**.
3. Select **End**.

A save confirmation message will be displayed.

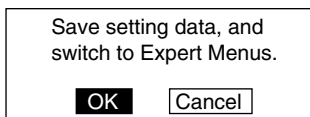

4. Select **OK**.

CHECK

If scene group 0 is displayed, the data will be saved to the F160 internal flash memory.

If scene groups 1 to 31 are displayed, the data will be saved (overwritten) to the Memory Card.

The Expert Menu will start up.

SECTION 6

Troubleshooting

This section provides information on troubleshooting and a list of frequently asked questions.

6-1	Troubleshooting	124
6-2	FAQ	126

6-1 Troubleshooting

This section lists the errors that may occur during F160 operation, along with their probable causes and remedies.

The letters used in the reference page column represent the following reference materials:

Setup: Setup Manual

Conv.: Conversational Menu Operation Manual (this manual)

Comm.: Communications Reference Manual

Error message	Causes and remedies	Reference
This camera cannot use Intelligent Lighting.	Check the settings under <i>SYS/Camera settings</i> . Reason: Cameras other than F160-S1, F160-S2, and F150-S1A cannot use Intelligent Lighting.	Conv.: page 102
Detailed settings of camera are incorrect.	Correct the settings.	Conv.: page 102
Camera is not connected properly.*	Check the following: - Are the Camera Cables connected to the F160? - Is the Camera Cable disconnected from the Camera? - Check the settings under <i>SYS/Camera settings</i> then cycle the power.	Conv.: page 102 Setup
Output file cannot be written.*	Specify a different file. Change the file attributes so that it is write enabled.	-
Cannot access this file.	Check the following points and re-select a file. - Is the file read-only? - Does the Memory Card have sufficient space to save the file?	-
Cannot write to scene group file.	Delete unnecessary scenes or save scenes individually. Reason: Writing is not possible because the scene group capacity is too big. Change the file attributes so that it is write enabled.	Conv.: page 75
The Camera shutter speed is fixed and cannot be changed.	Check the <i>Camera settings</i> under <i>SYS/Camera settings</i> . Reason: Only F160-S1, F160-S2, and F150-S1A Camera shutter speeds can be adjusted from the menu.	Conv.: page 102
Communications error (Data transfer) (See note.)*	Turn OFF the power to the F160, and check for the following items before restarting the F160.	Setup Comm.
Timeout error. (Data transmission) (See note.)*	- The cable is connected properly. - The communications specifications for the external device and the F160 are the same. - The external device is operating properly. Reason: Data transfer has been interrupted due to a communications error in communications between the F160 and an external device. If the same error message appears after restart, it may mean that the F160 is faulty. Contact your OMRON representative.	
Incorrect data format received. (See note.)*	Select the correct transfer file and re-execute the data transfer. Reason: The wrong file has been selected.	-
Background must not be same color as Normal	Change one of the colors.	Conv.: page 105
Cannot delete directory having files.	Delete the files in the directory to be deleted or move the files to another directory. Reason: Only empty directories can be deleted.	Conv.: page 99
Directory name is not specified.	Specify the directory name and press the ENT Key.	Conv.: page 93

Error message	Causes and remedies	Reference
Directory name contains unusable character.	Check the directory name. The following characters cannot be used: ¥ / : , ; * ? " < > ! & .	-
Same directory name has already existed.	Specify a directory name that is not being used.	-
Same file name has already existed.	Specify a file name that is not being used.	-
Password is incorrect.	Enter the correct password.	Conv.: page 110 Comm.: page 56
Password must be inputted from 6 to 8 characters or numbers.	Password must be input from 6 to 8 characters or numbers.	Conv.: page 110
Date/time settings error.	Set the correct date and time. Reason: A date not in the calendar or an invalid time has been input.	Conv.: page 119
File name is not specified.	Specify the file name and then press the ENT Key.	Conv.: page 93
File name contains unusable character.	Check the directory name. The following characters cannot be used: ¥ / : , ; * ? " < > ! & .	Conv.: page 20
Memory card access error (see note.)*	Check for the following items: - The recommended Memory Card has not been inserted. - Use another Memory Card. - The Memory Card has not been formatted.	Setup
Memory card is not inserted (See note.)*	Insert the recommended Memory Card.	Setup
Insufficient free space of memory card (See note.)*	- Delete unnecessary files to create free space. - Replace the Memory Card with a bigger capacity card.	Conv.: page 99
Insufficient flash memory.*	- Make the region to be registered smaller. - Delete unnecessary scenes and detection items.	Conv.: page 18 page 75
Insufficient model memory.*	- Make the region to be registered smaller. - Delete unnecessary regions.	Conv.: page 22
Insufficient work memory.*	- Make the region to be registered smaller. - Delete unnecessary scenes and detection items.	Conv.: page 18 page 75
Loaded file error.*	Specify the correct file and reload. Reason: A formatting error may have occurred during data or program file load.	Conv.: page 85

When the error messages marked with an asterisk are displayed, the ERR signal will come ON at the parallel interface.

Note The ERR signal will turn ON only when the error occurs in Monitor or Run Mode.

6-2 FAQ

I/O

Question	Answer
Will the RUN signal be output during scene switching?	- The RUN signal will remain ON during scene switching in Run Mode. - The RUN signal will remain OFF during scene switching in Monitor Mode.
Will the RUN signal turn OFF when the ERROR signal turns ON with Camera or other errors in Run Mode?	The RUN signal will remain ON even if the ERROR signal turns ON.
Why does the ERR signal turn ON when no error message has been displayed?	The ERR signal turns ON when STEP is input while the BUSY signal is ON. Select whether or not the ERR signal will turn ON under <i>SYS/Measurement control</i> . Refer to page 115.

Operation

Question	Answer
What happens to a registered images when scenes are switched using the Conversational Menus?	Registered images are deleted when scenes are switched. However, the automatically set measurement conditions based on the registered images will be saved.
If the position displacement compensation gives an NG result when using the Conversational Menus, will the workpiece measurement be executed?	Yes. If the position compensation measurement gives an NG result based on a low correlation, the measurement will still be performed. The image will not be scrolled in these cases. Also, the overall judgement will always be NG.
Are scene names and measurement item names set using the Expert Menu enabled for Conversational Menus?	Yes. The names will be displayed as is, whether or not they are customized or default names.
Can measurement region parameters set using the Expert Menu be changed using Conversational Menus?	No. With the Conversational Menus, only the measurement item names for regions set using the Expert Menu will be displayed. Nothing will be displayed even if the ENT Key is pressed with one of these names selected.
Why has the measurement time increased after switching from the Expert Menu to the Conversational Menus, even though no settings have been changed?	The measurement time will increase for Expert Menu settings if the following three conditions are met: 1. Position displacement compensation is set. 2. <i>Compensated Image</i> under <i>SYS/Conditions/Display Settings</i> is set to not be displayed. 3. <i>BUSY range</i> under <i>SYS/Measurement control</i> is set to end of display. When you enter Conversational Menus Mode, the <i>Compensated Image</i> setting under <i>SYS/Conditions/Display Settings</i> will automatically change to display the image. As a result, the measurement time is extended by the amount of time it takes to display the compensated image.
What data is saved to flash memory or the Memory Card when the save operation is executed?	System data and the scene data for scene group 0 is saved to flash memory. Scene data for scene groups 1 to 31 is overwritten to the Memory Card.

Appendix A

Menus

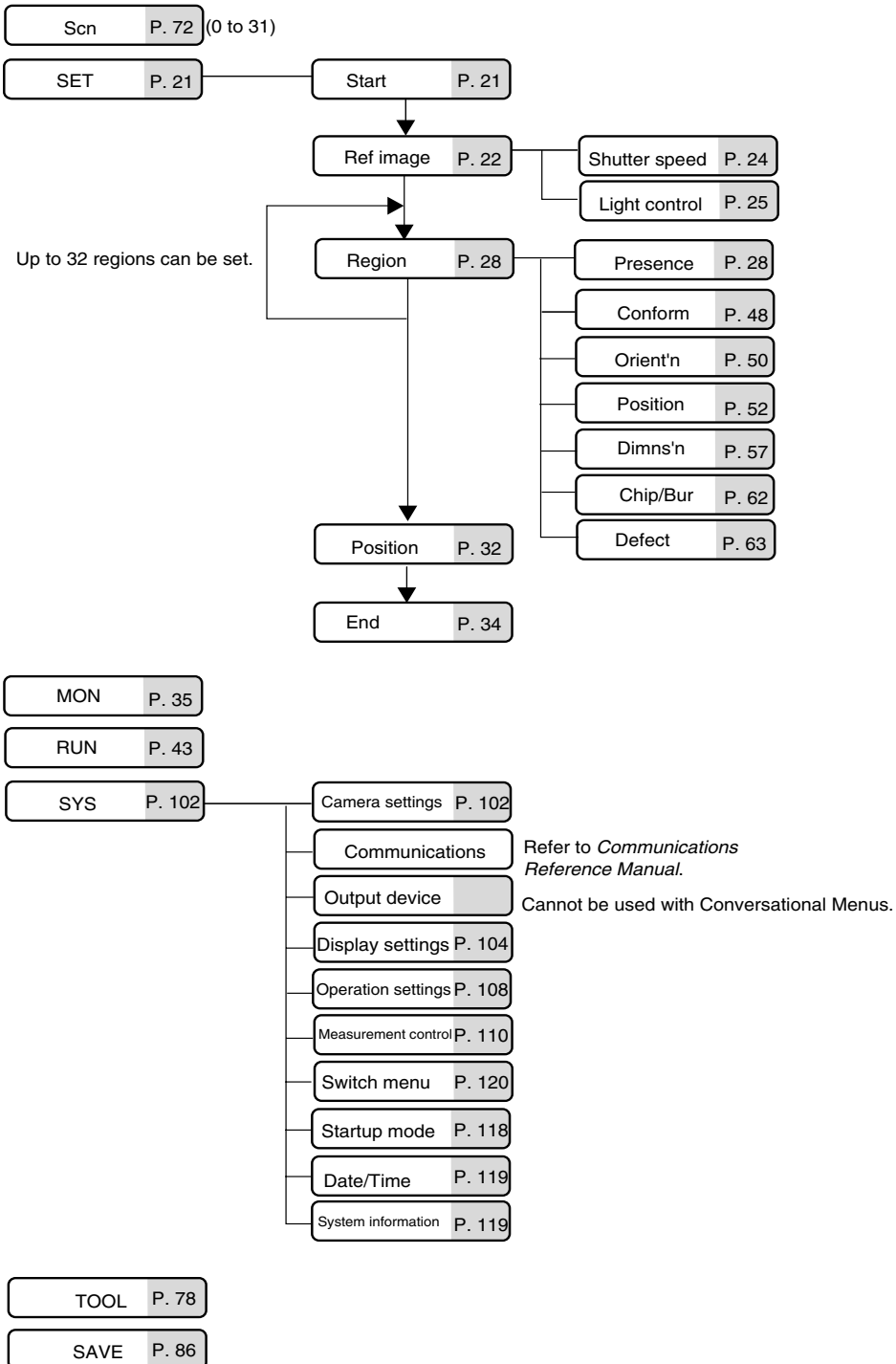

Appendix B

Training Samples

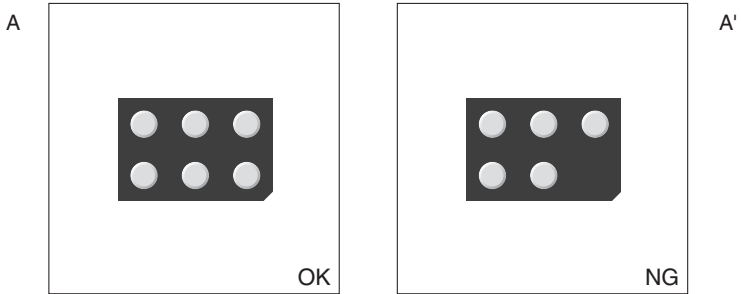

Presence

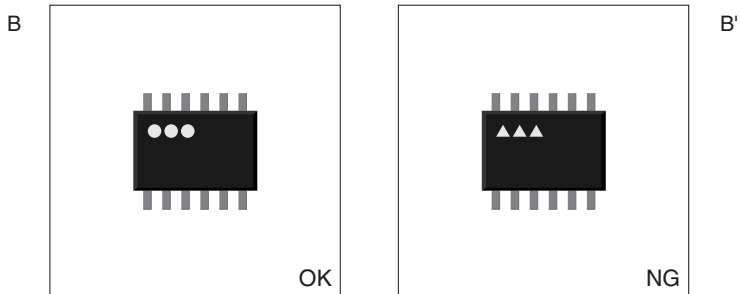

Conform

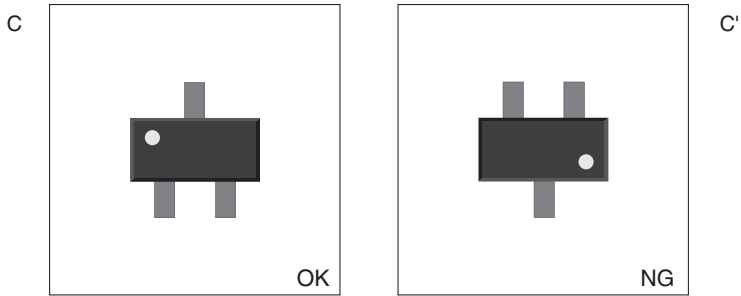

Orient'n

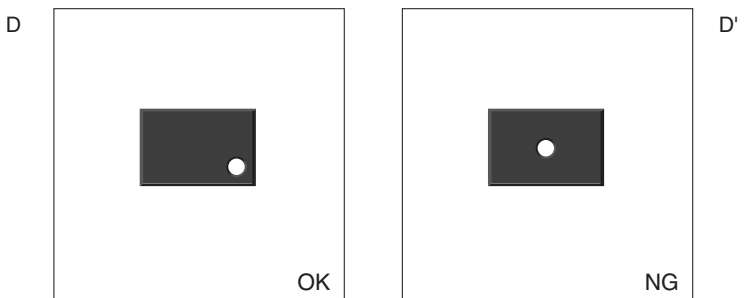

Position

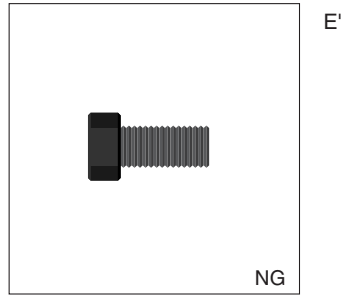
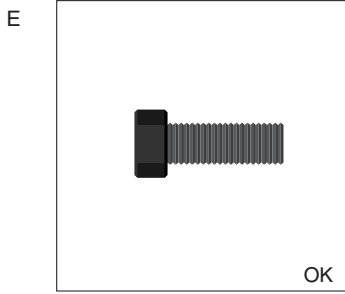

Dimns'n

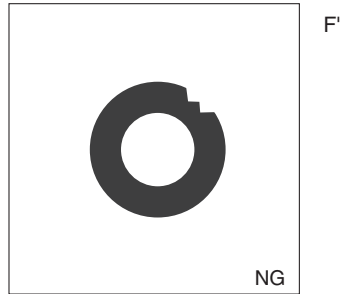
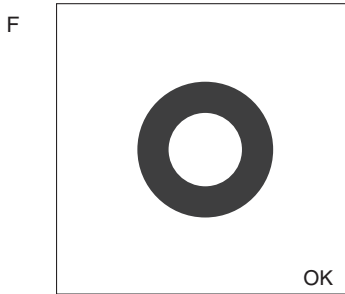

Chip/Bur

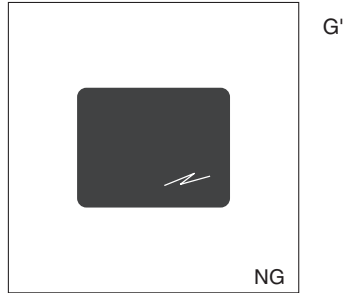
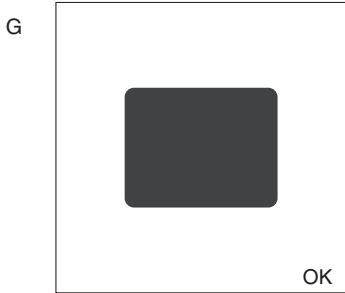

Defect

Index

B

- backup
 - data, 78
- battery
 - status, 119
- BUSY signal, 115

C

- calendar, 119
- camera modes, 102
- Camera settings, 102
- colors, 104
 - characters or figures, 105
 - customizing, 106
 - foreground and background, 105
- comments
 - adding comments to scenes, 76
- components, 12
- computer
 - data backup, 78
- connections, 12
- Consoles
 - keys, 16
- conversational menus
 - advantages, 7
- customizing
 - colors, 106
 - operations, 108

D

- data backup, 78
 - flash memory, 86
 - Memory Cards, 83
- date, 119
- density distribution, 88
- detection conditions
 - setting, 9
- displays
 - image type, 104
 - judgement items, 117
 - stored images, 113
- drawing, 18

E

- echoback test, 91
- error messages, 9
- exiting, 44
- expert menus, 120
- external devices
 - monitoring I/O status, 90

F

- FAQ, 126
- features, 1
 - useful features, 8
- figures
 - drawing, 18
- file names, 97
- files
 - copying, 95
 - deleting, 99
 - properties, 97
- flash memory, 44, 78
 - data backup, 86
- focussing, 13
- freeze images, 104

H

- help messages, 36

I

- I/O status
 - monitoring, 90, 92
- image registration methods, 22
- images
 - capturing, 108
 - clearing stored images, 114
 - conditions for saving, 112
 - displaying, 13
 - displaying stored images, 113
 - saving, 8
 - type of images displayed, 15
- inputting
 - characters, 20
- inputting values, 19
- inspection conditions
 - changing and clearing, 66

inspection details
 setting, 29

inspection types, 3

- adjustable parameters, 39
- chips and burs, 5
 - procedure, 62
- conformity, 3
 - procedure, 48
- dimensions, 5
 - procedure, 57
- orientation, 4
 - procedure, 50
- position, 4
 - procedure, 52
- presence, 3
 - methods, 30
- selecting, 28
- setting details, 29
- surfaces, 6
 - procedure, 63

inspections

- specific applications, 47

Intelligent Lighting, 25

J

judgement results

- outputting, 8

judgements

- displayed items, 117

judgment precision, 37

K

key operations, 16

L

light levels, 25

lighting

- adjusting, 8

lighting patterns, 25

line brightness, 88

M

manuals, ix

measurement conditions

- changing, 72

measurement setups

- changing, 8

measurement time, 42

measurements

- executing, 9
- executing with triggers, 8

memory

- remaining memory, 119

Memory Cards, 8

- data backup, 83
- operations, 93
- turning OFF power, 99

menus, 127

- manipulation from a computer, 8

monitor

- color or monochrome, 104

Monitor Mode, 35

O

operating modes, 14

operating procedure

- overview, 9

operations

- basic, 11
- inputting characters, 20
- inputting values, 19
- keys, 16
- Memory Cards, 93
- menus, 14
- setting procedure, 21

P

parallel interface

- monitoring I/O status, 92

parameters

- adjusting, 39

passwords, 110

position compensation, 31

- changing, 70

position compensation regions, 33

preparations, 9

R

reference images

- registering, 22
- re-registering, 67

regions

- changing, 68
- deleting, 69

Run Mode, 43

S

- samples, 129
- save
 - images, 112
- scene groups, 8
 - changing, 71
 - reducing switching time, 109
 - using, 73, 77
- scenes, 8
 - changing, 71, 72
 - clearing, 75
 - comments, 76
 - copying, 74
- screen configuration, 14, 15
- serial interface
 - monitoring I/O status, 90
- Set Mode, 66
- settings
 - application settings, 10
 - backup, 8
 - changing, 67
 - confirming, 9
 - measurement screens, 104
 - saving, 9, 44
- shutter speed, 24
- software system version, 120
- starting, 12
 - conversational menus, 21
 - inspections, 43
- startup conditions, 118
- STEP signal, 23, 116
- system environment, 101
- system information, 119
- System Mode, 102

T

- testing inspections, 35
- through images, 104
- time, 119
- troubleshooting, 9, 123

V

- Vision Sensors
 - overview, 2

Version Information (Ver. 1.□□ → 2.0)

Controller

Item	Details
The number of types of Camera that can be connected has increased.	The F160-S2 Camera can now be connected. Refer to the <i>Setup Manual</i> for details.

Menu

Item	Details
The display capture selections have changed.	The selections have changed from ON/OFF to OFF/CAPT only/ CAPT+LIVE. Refer to page 108 for details.

Revision History

A manual revision code appears as a suffix to the catalog number on the front cover of the manual.

Cat. No. Z171-E1-01A



The following table outlines the changes made to the manual during each revision. Page numbers refer to the previous version.

Revision code	Date	Revised content
01	February 2003	Original production
01A	July 2004	Information on warranty and limitations of liability added to the front of the manual. Page ix: Suffixes removed from catalog numbers in table.

OMRON CORPORATION
Industrial Automation Company

Application Sensors Division
Sensing Devices and Components Division H.Q.
Shiokoji Horikawa, Shimogyo-ku,
Kyoto, 600-8530 Japan
Tel: (81)75-344-7068/Fax: (81)75-344-7107

Regional Headquarters

OMRON EUROPE B.V.
Sensor Business Unit,
Carl-Benz-Str. 4, D-71154 Nufringen,
Germany
Tel: (49)7032-811-0/Fax: (49)7032-811-199

OMRON ELECTRONICS LLC
1 East Commerce Drive, Schaumburg, IL 60173
U.S.A.
Tel: (1)847-843-7900/Fax: (1)847-843-8568

OMRON ASIA PACIFIC PTE. LTD.
83 Clemenceau Avenue,
#11-01, UE Square,
239920 Singapore
Tel: (65)6835-3011/Fax: (65)6835-2711

OMRON CHINA CO., LTD. BEIJING OFFICE
Room 1028, Office Building,
Beijing Capital Times Square,
No. 88 West Chang'an Road,
Beijing, 100031 China
Tel: (86)10-8391-3005/Fax: (86)10-8391-3688

OMRON

Authorized Distributor:

Cat. No. Z171-E1-01A

F160-2 Vision Sensor

Manual 2: CONVERSATIONAL MENU OPERATION MANUAL

OMRON