

CP1L-J14D□-□

CP1L-J20D□-□

CP1L-L10D□-□

CP1L-L14D□-□

CP1L-L20D□-□

CP1L-M30D□-□

CP1L-M40D□-□

CP1L-M60D□-□

## CP1L CPU Unit

# GETTING STARTED GUIDE

**OMRON**

**CP1L-J14D□-□**

**CP1L-J20D□-□**

**CP1L-L10D□-□**

**CP1L-L14D□-□**

**CP1L-L20D□-□**

**CP1L-M30D□-□**

**CP1L-M40D□-□**

**CP1L-M60D□-□**

## **CP1L CPU Unit**

### **Getting Started Guide**

## Notice:

OMRON products are manufactured for use according to proper procedures by a qualified operator and only for the purposes described in this manual.

The following conventions are used to indicate and classify precautions in this manual. Always heed the information provided with them. Failure to heed precautions can result in injury to people or damage to property.

 **DANGER** Indicates an imminently hazardous situation which, if not avoided, will result in death or serious injury. Additionally, there may be severe property damage.

 **WARNING** Indicates a potentially hazardous situation which, if not avoided, could result in death or serious injury. Additionally, there may be severe property damage.

 **Caution** Indicates a potentially hazardous situation which, if not avoided, may result in minor or moderate injury, or property damage.

## OMRON Product References

All OMRON products are capitalized in this manual. The word “Unit” is also capitalized when it refers to an OMRON product, regardless of whether or not it appears in the proper name of the product.

The abbreviation “Ch,” which appears in some displays and on some OMRON products, often means “word” and is abbreviated “Wd” in documentation in this sense.

The abbreviation “PLC” means Programmable Controller. “PC” is used, however, in some CX-Programmer displays to mean Programmable Controller.

## Visual Aids

The following headings appear in the left column of the manual to help you locate different types of information.

**Note** Indicates information of particular interest for efficient and convenient operation of the product.

**1,2,3...** 1. Indicates lists of one sort or another, such as procedures, checklists, etc.

## Trademarks

Windows is a registered trademark of Microsoft Corporation in the United States and other countries.

SYSMAC is a registered trademark of OMRON’s Programmable Controllers.

Other brand and product names are trademarks or registered trademarks of their respective owners.

## © OMRON, 2007

All rights reserved. No part of this publication may be reproduced, stored in a retrieval system, or transmitted, in any form, or by any means, mechanical, electronic, photocopying, recording, or otherwise, without the prior written permission of OMRON.

No patent liability is assumed with respect to the use of the information contained herein. Moreover, because OMRON is constantly striving to improve its high-quality products, the information contained in this manual is subject to change without notice. Every precaution has been taken in the preparation of this manual. Nevertheless, OMRON assumes no responsibility for errors or omissions. Neither is any liability assumed for damages resulting from the use of the information contained in this publication.

# TABLE OF CONTENTS

<b>PRECAUTIONS</b> .....	<b>9</b>
1 Intended Audience.....	10
2 General Precautions.....	10
3 Safety Precautions .....	10
4 Application Precautions .....	10
<b>SECTION 1CP1L Overview</b> .....	<b>11</b>
1-1 CP1L Models .....	12
1-2 Part Names and Functions .....	15
<b>SECTION 2Designing Systems</b> .....	<b>19</b>
2-1 Organization of this Manual.....	20
2-2 About the Shutter Control System .....	22
2-3 I/O Allocation for the Shutter Control System.....	24
2-4 Example Ladder Program.....	26
<b>SECTION 3Mounting and Wiring</b> .....	<b>27</b>
3-1 Installation Notes .....	28
3-2 Mounting onto DIN Tracks.....	31
3-3 Wiring Devices.....	32
3-4 Power Testing CP1L.....	35
<b>SECTION 4Creating Programs</b> .....	<b>37</b>
4-1 Preparing for Programming .....	38
4-2 Creating Ladder Programs .....	44
4-3 Using CX-Programmer .....	47
4-4 Using the Help .....	50
4-5 Inputting Programs .....	53
4-6 Saving/Loading Programs .....	70
4-7 Editing Programs .....	73
<b>SECTION 5Transferring and Debugging Programs</b> .....	<b>77</b>
5-1 Going Online.....	78
5-2 Adjusting/Debugging Online .....	85
<b>Appendix</b> .....	<b>95</b>
A-1 Channel/Relay Numbers .....	96
A-2 Instructions .....	101
A-3 Inner Workings of CP1L .....	105
A-4 CP1L Programming Examples .....	114

## ***About this Manual:***

This manual describes installation and operation of the CP-series Programmable Controllers (PLCs) and includes the sections described below. The CP Series provides advanced package-type PLCs based on OMRON's advanced control technologies and vast experience in automated control.

Please read this manual carefully and be sure you understand the information provided before attempting to install or operate a CP-series PLC. Be sure to read the precautions provided in the following section.

This manual is intended for first-time users of the SYSMAC CP series. The basic use of the series is explained based on SYSMAC CP1L.

Circuit configurations, wiring methods, and programs provided in this manual are given strictly as examples. When constructing an actual system, check the specifications, performance, and safety of each component by referring to the respective manuals.

Ladder programs in this manual are provided strictly as examples. When designing the actual circuits, take adequate safety measures.

***Precautions*** provide general precautions for using the Programmable Controller and related devices.

***Section 1*** introduces the types of CP1L, as well the part names.

***Section 2*** explains how to construct a CP1L system, using a shutter control system as an example.

***Section 3*** explains the how to install CP1L onto a DIN track, how to wire power supply and I/O lines, and how to test operation.

***Section 4*** explains the basic functions of CX-Programmer creating the ladder program for the shutter control system.

***Section 5*** describes how to transfer and debug programs.

The ***Appendices*** provide channel/relay numbers, instructions, inner workings of CP1L, and CP1L programming examples.

## Related Manuals

The following manuals are used for the CP-series CPU Units. Refer to these manuals as required.

Cat. No.	Manual name	Description
W462	SYSMAC CP Series CP1L CPU Unit User's Manual	Explains the system configuration, installation, wiring, I/O allocation, pulse/counter functions, and expansion unit connections in details. Also provides information on errors, troubleshooting, maintenance, and inspection.
W451	SYSMAC CP Series CP1H/CP1L CPU Unit Programming Manual	Provides the following information on the CP Series: <ul style="list-style-type: none"><li>• Programming instructions</li><li>• Programming methods</li><li>• Tasks</li><li>• File memory</li><li>• Functions</li></ul> Use this manual together with the <i>CP1H Programmable Controllers Operation Manual (W450)</i> .
W446	SYSMAC CX-Programmer Operation Manual	Provides information on installing and operating the CX-Programmer for all functions except for function blocks.

## ***Read and Understand this Manual***

Please read and understand this manual before using the product. Please consult your OMRON representative if you have any questions or comments.

## ***Warranty and Limitations of Liability***

### **■ WARRANTY**

OMRON's exclusive warranty is that the products are free from defects in materials and workmanship for a period of one year (or other period if specified) from date of sale by OMRON.

OMRON MAKES NO WARRANTY OR REPRESENTATION, EXPRESS OR IMPLIED, REGARDING NON-INFRINGEMENT, MERCHANTABILITY, OR FITNESS FOR PARTICULAR PURPOSE OF THE PRODUCTS. ANY BUYER OR USER ACKNOWLEDGES THAT THE BUYER OR USER ALONE HAS DETERMINED THAT THE PRODUCTS WILL SUITABLY MEET THE REQUIREMENTS OF THEIR INTENDED USE. OMRON DISCLAIMS ALL OTHER WARRANTIES, EXPRESS OR IMPLIED.

### **■ LIMITATIONS OF LIABILITY**

OMRON SHALL NOT BE RESPONSIBLE FOR SPECIAL, INDIRECT, OR CONSEQUENTIAL DAMAGES, LOSS OF PROFITS OR COMMERCIAL LOSS IN ANY WAY CONNECTED WITH THE PRODUCTS, WHETHER SUCH CLAIM IS BASED ON CONTRACT, WARRANTY, NEGLIGENCE, OR STRICT LIABILITY.

In no event shall the responsibility of OMRON for any act exceed the individual price of the product on which liability is asserted.

IN NO EVENT SHALL OMRON BE RESPONSIBLE FOR WARRANTY, REPAIR, OR OTHER CLAIMS REGARDING THE PRODUCTS UNLESS OMRON'S ANALYSIS CONFIRMS THAT THE PRODUCTS WERE PROPERLY HANDLED, STORED, INSTALLED, AND MAINTAINED AND NOT SUBJECT TO CONTAMINATION, ABUSE, MISUSE, OR INAPPROPRIATE MODIFICATION OR REPAIR.

# ***Application Considerations***

## **■ SUITABILITY FOR USE**

OMRON shall not be responsible for conformity with any standards, codes, or regulations that apply to the combination of products in the customer's application or use of the products.

At the customer's request, OMRON will provide applicable third party certification documents identifying ratings and limitations of use that apply to the products. This information by itself is not sufficient for a complete determination of the suitability of the products in combination with the end product, machine, system, or other application or use.

The following are some examples of applications for which particular attention must be given. This is not intended to be an exhaustive list of all possible uses of the products, nor is it intended to imply that the uses listed may be suitable for the products:

- Outdoor use, uses involving potential chemical contamination or electrical interference, or conditions or uses not described in this manual.
- Nuclear energy control systems, combustion systems, railroad systems, aviation systems, medical equipment, amusement machines, vehicles, safety equipment, and installations subject to separate industry or government regulations.
- Systems, machines, and equipment that could present a risk to life or property.

Please know and observe all prohibitions of use applicable to the products.

**NEVER USE THE PRODUCTS FOR AN APPLICATION INVOLVING SERIOUS RISK TO LIFE OR PROPERTY WITHOUT ENSURING THAT THE SYSTEM AS A WHOLE HAS BEEN DESIGNED TO ADDRESS THE RISKS, AND THAT THE OMRON PRODUCTS ARE PROPERLY RATED AND INSTALLED FOR THE INTENDED USE WITHIN THE OVERALL EQUIPMENT OR SYSTEM.**

## **■ PROGRAMMABLE PRODUCTS**

OMRON shall not be responsible for the user's programming of a programmable product, or any consequence thereof.



# **Disclaimers**

## **■ CHANGE IN SPECIFICATIONS**

Product specifications and accessories may be changed at any time based on improvements and other reasons.

It is our practice to change model numbers when published ratings or features are changed, or when significant construction changes are made. However, some specifications of the products may be changed without any notice. When in doubt, special model numbers may be assigned to fix or establish key specifications for your application on your request. Please consult with your OMRON representative at any time to confirm actual specifications of purchased products.

## **■ DIMENSIONS AND WEIGHTS**

Dimensions and weights are nominal and are not to be used for manufacturing purposes, even when tolerances are shown.

## **■ PERFORMANCE DATA**

Performance data given in this manual is provided as a guide for the user in determining suitability and does not constitute a warranty. It may represent the result of OMRON's test conditions, and the users must correlate it to actual application requirements. Actual performance is subject to the OMRON Warranty and Limitations of Liability.

## **■ ERRORS AND OMISSIONS**

The information in this manual has been carefully checked and is believed to be accurate; however, no responsibility is assumed for clerical, typographical, or proofreading errors, or omissions.

# PRECAUTIONS

This section provides general precautions for using the CP-series Programmable Controllers (PLCs) and related devices.

The information contained in this section is important for the safe and reliable application of Programmable Controllers. You must read this section and understand the information contained before attempting to set up or operate a PLC system.

1	Intended Audience .....	10
2	General Precautions .....	10
3	Safety Precautions .....	10
4	Application Precautions .....	10

## 1 Intended Audience

This manual is intended for the following personnel, who must also have knowledge of electrical systems (an electrical engineer or the equivalent).

- Personnel in charge of installing FA systems.
- Personnel in charge of designing FA systems.
- Personnel in charge of managing FA systems and facilities.

## 2 General Precautions

The user must operate the product according to the performance specifications described in the operation manuals.

Before using the product under conditions which are not described in the manual or applying the product to nuclear control systems, railroad systems, aviation systems, vehicles, combustion systems, medical equipment, amusement machines, safety equipment, and other systems, machines, and equipment that may have a serious influence on lives and property if used improperly, consult your OMRON representative.

Make sure that the ratings and performance characteristics of the product are sufficient for the systems, machines, and equipment, and be sure to provide the systems, machines, and equipment with double safety mechanisms.

This manual provides information for programming and operating the Unit. Be sure to read this manual before attempting to use the Unit and keep this manual close at hand for reference during operation.

 **WARNING** It is extremely important that a PLC and all PLC Units be used for the specified purpose and under the specified conditions, especially in applications that can directly or indirectly affect human life. You must consult with your OMRON representative before applying a PLC System to the above-mentioned applications.

## 3 Safety Precautions

 **Caution** When power is ON or has just been turned OFF, do not touch the power supply, I/O terminals, or the surrounding areas. Doing so may result in burns. After turning the power OFF, wait for the unit to cool down sufficiently before touching it.

 **Caution** Secure the AC power supply line to the terminal block with a 0.5N·m of torque. Loosening the screw may result in a fire or malfunction.

 **Caution** Before starting online editing, confirm that the extension of cycle time will have no adverse effects. Otherwise, input signals may not be read.

## 4 Application Precautions

 **Caution** Confirm that the facility will not be affected by changing to MONITOR or RUN mode.

# SECTION 1

---

## CP1L Overview

This section introduces the types of CP1L, as well the part names used during operation.

1-1 CP1L Models .....	12
1-2 Part Names and Functions .....	15

# 1 CP1L Overview

## 1-1 CP1L Models

CP1L programmable controller is a PLC package type, available with 10, 14, 20, 30, 40, or 60 I/O points. For application examples that use CP1L, refer to appendix A-4 *CP1L Programming Examples*.

### ■ 10-point I/O Units (CP1L-L10D□-□)

- The CPU Unit has 6 inputs and 4 outputs built in.
- The PLC cannot use CP-series Expansion I/O Units to expand the maximum total of I/O points.

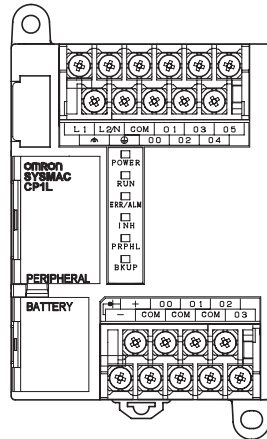

### ■ 14-point I/O Units (CP1L-L14D□-□/CP1L-J14D□-□)

- CPU unit has 8 input points and 6 output points.
- CP-series expansion I/O units can be used to add I/O points, up to a total of 54 I/O points.

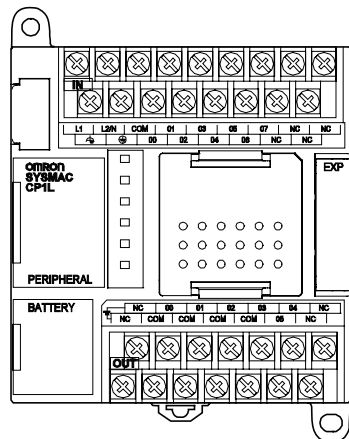

### ■ 20-point I/O Units (CP1L-L20D□-□/CP1L-J20D□-□)

- CPU unit has 12 input points and 8 output points.
- CP-series expansion I/O units can be used to add I/O points, up to a total of 60 I/O points.

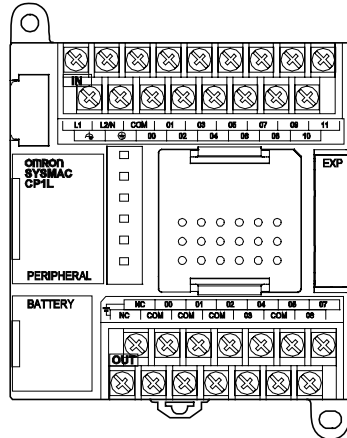

### ■ 30-point I/O Units (CP1L-M30D□-□)

- CPU unit has 18 input points and 12 output points.
- CP-series expansion I/O units can be used to add I/O points, up to a total of 150 I/O points .

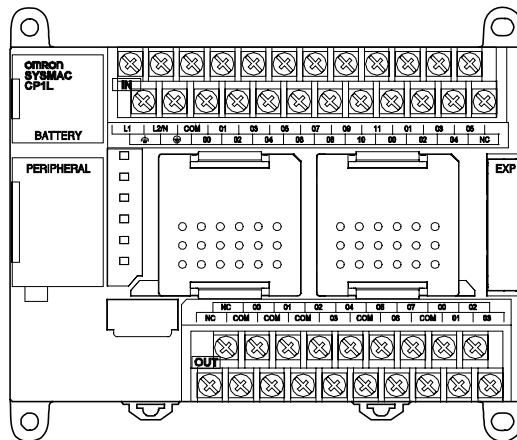

### ■ 40-point I/O Units (CP1L-M40D□-□)

- CPU unit has 24 input points and 16 output points.
- CP-series expansion I/O units can be used to add I/O points, up to a total of 160 I/O points.

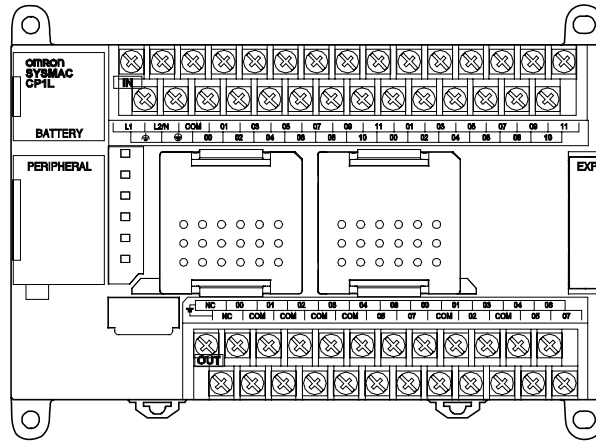

### ■ 60-point I/O Units (CP1L-M60D□-□)

- CPU unit has 36 input points and 24 output points.
- CP-series expansion I/O units can be used to add I/O points, up to a total of 180 I/O points.

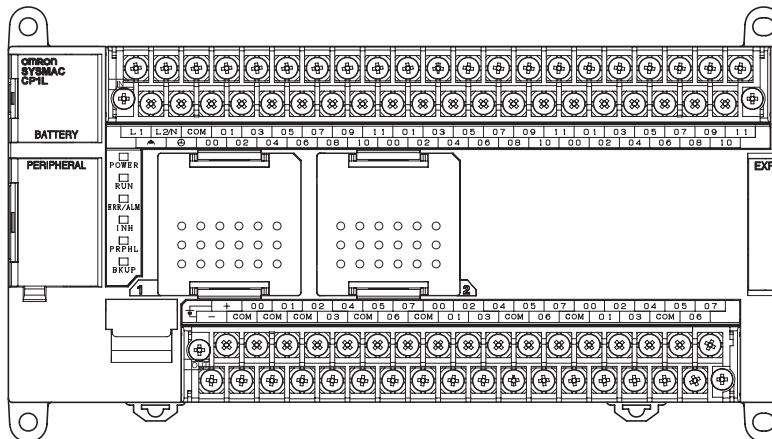

## 1-2 Part Names and Functions

This section describes the part names and functions, using the 14-point I/O unit as an example.

### ■ 14-point I/O Unit

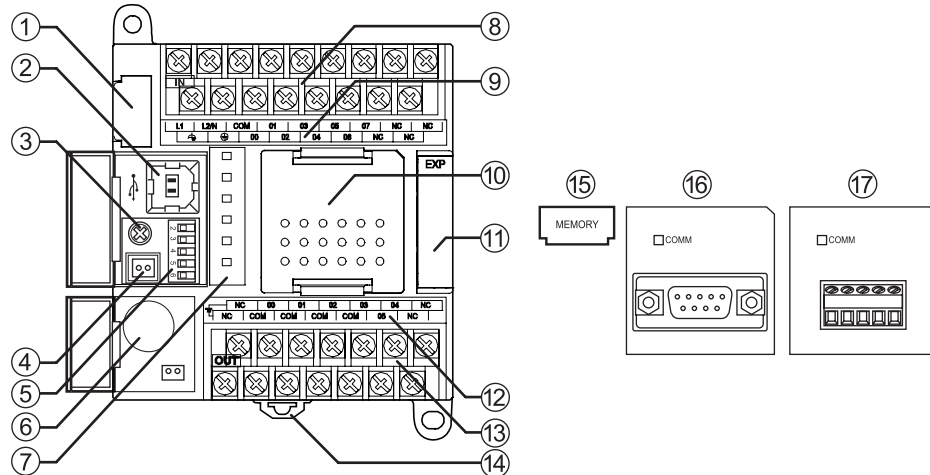

- (1) Memory cassette slot  
Used to attach a memory cassette (15). Memory cassettes can be used to store backups for CP1L programs, parameters, and data memory. They also allow you to copy data to other CP1L units without using a programming tool (software).
- (2) Peripheral USB port  
Used for connection to a computer. Computers can be used for programming and monitoring.
- (3) Analog adjuster  
Rotate to adjust the value for auxiliary area A642CH to within the 0 to 255 range. Use to change timer and counter settings without using a programming tool (software).
- (4) External analog settings input connector  
Takes an external input between 0 and 10V, and changes the value for auxiliary area A643CH to a value between 0 and 256. This input is not isolated.
- (5) DIP switches  
Used for settings such as write-permission on user memory, automatic transfers from memory cassettes, and tool bus use.  
For details, refer to *2-1 Part Names and Functions of CP Series CP1L CPU Unit User's Manual (W462)*.
- (6) Battery  
Maintains the internal clock and RAM contents while the power supply is OFF.



- (7) Operation indicators  
Indicates the operating status of CP1L. Indicated statuses include power status, operating mode, errors, and peripheral USB communication status.
- (8) Power supply, ground, and input terminal block  
Used to connect the power supply line, ground line, and input lines.
- (9) Input indicators  
Lit when the corresponding input terminal contact is ON.
- (10) Option board slot  
Used to install an RS-232C option board (16) or an RS-422A/485 option board (17).  
14/20-point I/O units may have 1 serial communication option board installed.  
30/40/60-point I/O units may have up to 2 serial communication option boards installed.
- (11) Expansion I/O unit connector  
Used to connect CP-series expansion I/O units and expansion units. 14/20-point I/O units may have 1 expansion unit connected. 30/40/60-point I/O units may have up to 3 expansion units connected.
- (12) Output indicators  
Lit when the corresponding output terminal contact is ON.
- (13) External power supply and output terminal block
  - External power supply terminal:  
Units that use AC power supply have a 24VDC external power supply terminal with a maximum capacity of 300mA. This can be used as a service power supply for input devices.
  - Output terminals: Used to connect output lines.
- (14) DIN track mounting pin  
Used for mounting unit to a DIN track.
- (15) Memory cassette (optional)  
Used to store data from the built-in flash memory. Insert into memory cassette slot (1).
- (16) RS-232C option board  
Insert into option board slot (10).
- (17) RS-422A/485 option board  
Insert into option board slot (10).

●Indicator Statuses

This section describes the operating statuses of CP1L as displayed by the operation indicators.

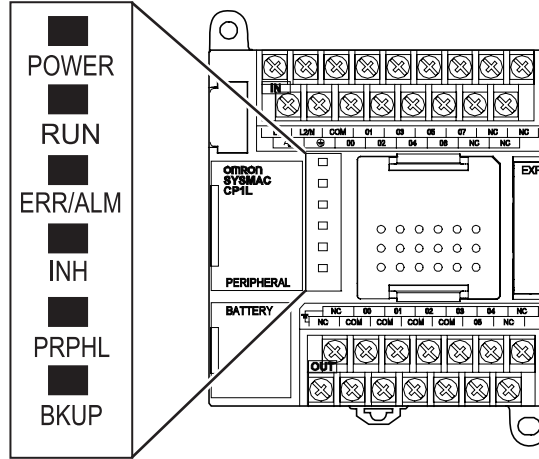

POWER (Green)	Lit	Power is ON.
	Not lit	Power is OFF.
RUN (Green)	Lit	CP1L is executing a program in either RUN or MONITOR mode.
	Not lit	Operation is stopped in PROGRAM mode, or stopped due to a fatal error.
ERR/ALM (Red)	Lit	A fatal error (including FALS execution) or a hardware error (WDT error) has occurred. CP1L operation will stop, and all outputs will be turned OFF.
	Blinking	A non-fatal error (including FAL execution) has occurred. CP1L operation will continue.
	Not lit	Operation normal.
INH (Yellow)	Lit	The output OFF bit (A500.15) has turned ON. All outputs will be turned OFF.
	Not lit	Operation normal.
PRPHL (Yellow)	Blinking	Communication (either sending or receiving) is active on the peripheral USB port.
	Not lit	Any other state.
BKUP (Yellow)	Lit	<ul style="list-style-type: none"> <li>User program, parameter, or data memory is being written to or read from the built-in flash memory (backup memory).</li> <li>User program, parameter, data memory, DM defaults, or comment memory is being written to or read from the memory cassette.</li> <li>User programs, parameters, and data memory are being restored following a PLC power-on.</li> </ul> Note: Do not turn the PLC power supply OFF while this indicator is lit.
	Not lit	Any other state.



# SECTION 2

## Designing Systems

This section explains how to construct a CP1L system, using a shutter control system as an example.

All subsequent sections are written based on the sample program used in this section.

2-1	Organization of this Manual .....	20
2-2	About the Shutter Control System .....	22
2-2-1	Operation.....	22
2-2-2	System Components .....	23
2-3	I/O Allocation for the Shutter Control System .....	24
2-4	Example Ladder Program .....	26

# 2 Designing Systems

## 2-1 Organization of this Manual

Sections 2 through 5 of this manual explain the construction process of a CP1L system, from design to operation, using a shutter control system as an example. Section contents are as follows:

Section 2: Workflow from design to operation, shutter control system specifications, components, and I/O allocation.

Section 3: CP1L installation, component wiring, and power testing.

Section 4: Connecting CP1L to a computer, and creating ladder programs.

Section 5: Setting PLC clock and PLC operation mode, transferring data from computer to CP1L, operation, adjustment, and debugging.

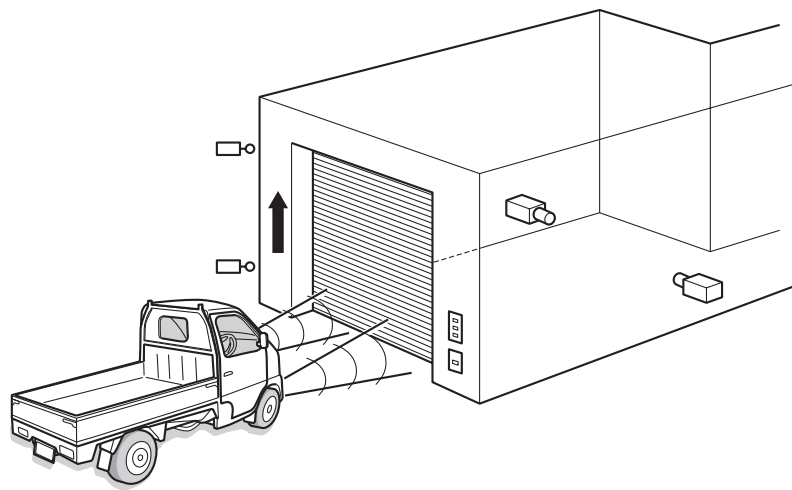

**Note** Circuit configurations, wiring methods, and programs provided in this manual are given strictly as examples. When constructing an actual system, check the specifications, performance, and safety of each component by referring to the respective manuals.

## ● Workflow from Design to Operation

The workflow for constructing a CP1L shutter control system is shown below. For details, refer to the respective sections of the manual.

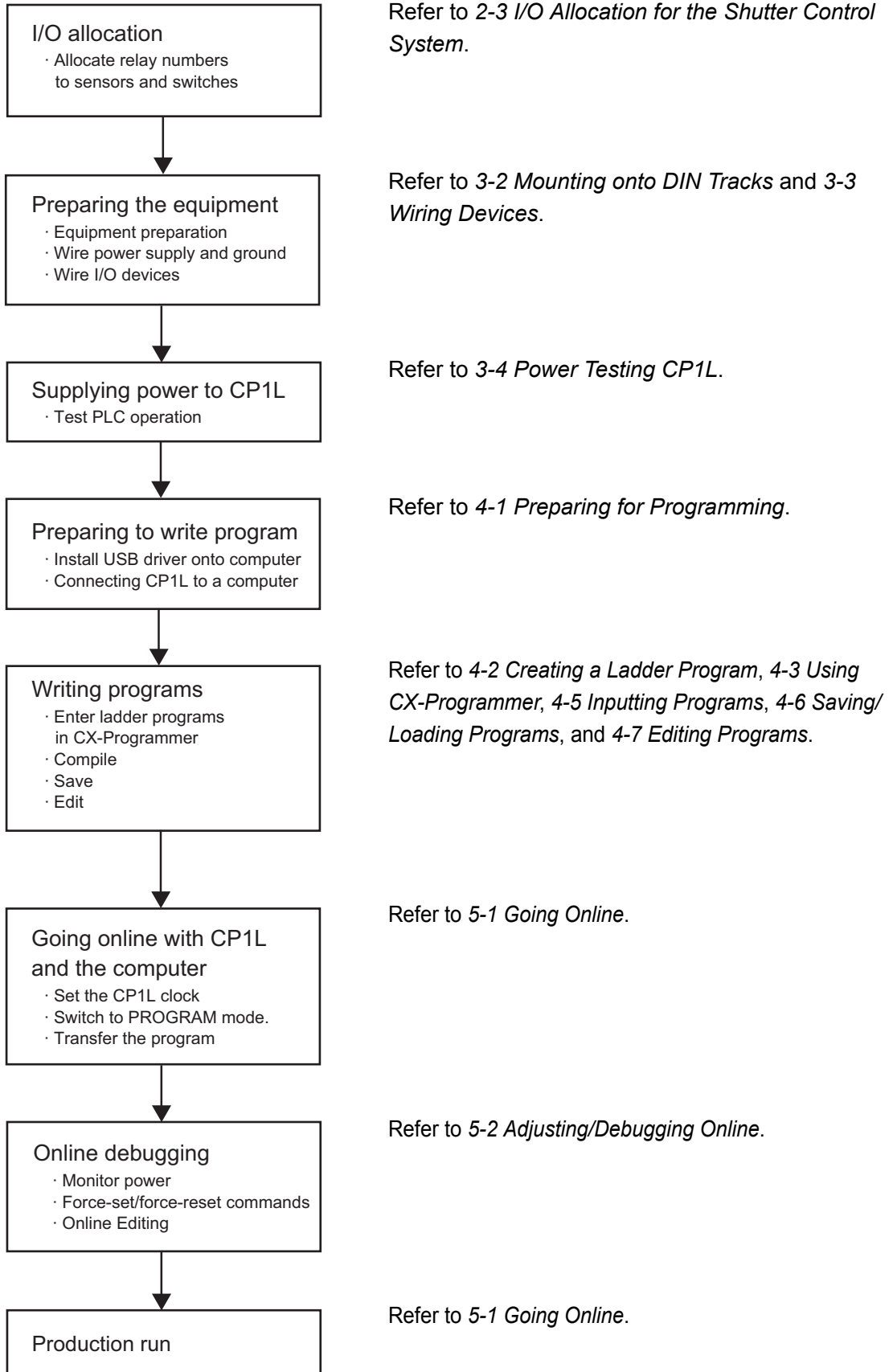

## 2-2 About the Shutter Control System

This section defines the operation and components of a shutter control system.

### 2-2-1 Operation

This section defines the operation of a shutter control system.

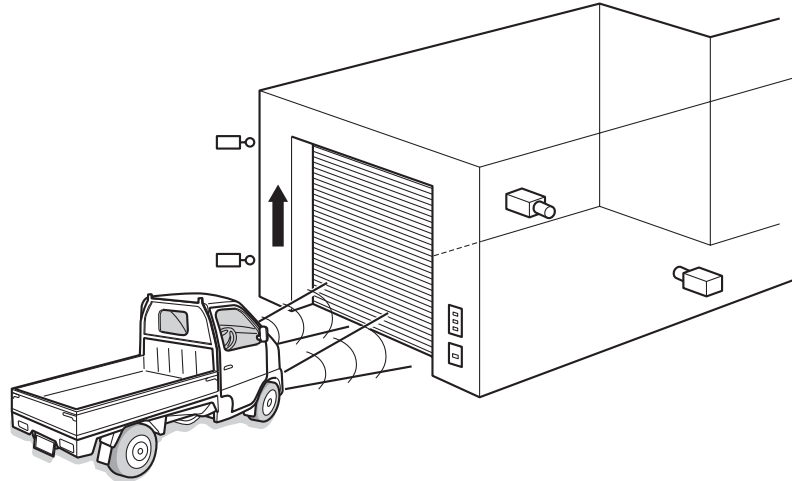

A car approaches the shutter.

- When a sensor detects 3 headlight flashes within 5 seconds, the shutter opens.
- The shutter can also be opened, closed, and stopped with buttons.

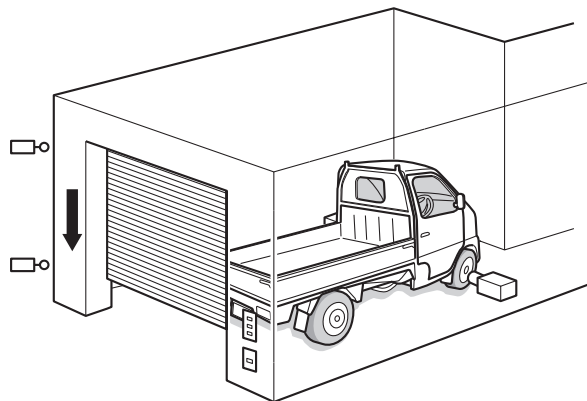

- When a sensor detects full car entrance into the garage, the shutter closes.
- When pulling the car out of the garage, use the buttons to operate the shutter.

## 2-2-2 System Components

This section defines components to be used in the shutter control system. The following components are to be used.

### ●PLC

- CP1L (14-point I/O unit with AC power supply)

### ●Equipment and Software for Programming

- CX-Programmer
- Computer
- USB cable (A-B)

### ●Inputs

- Shutter OPEN button : PB1
- Shutter STOP button : PB2
- Shutter CLOSE button : PB3
- Car detection sensor : SEN1
- Headlight detection sensor : SEN2
- Limit switch, turned ON when shutter is fully open : LS1
- Limit switch, turned ON when shutter is fully closed : LS2

### ●Outputs

- Contact for activating the shutter escalation motor : MO1
- Contact for activating the shutter de-escalation motor : MO2

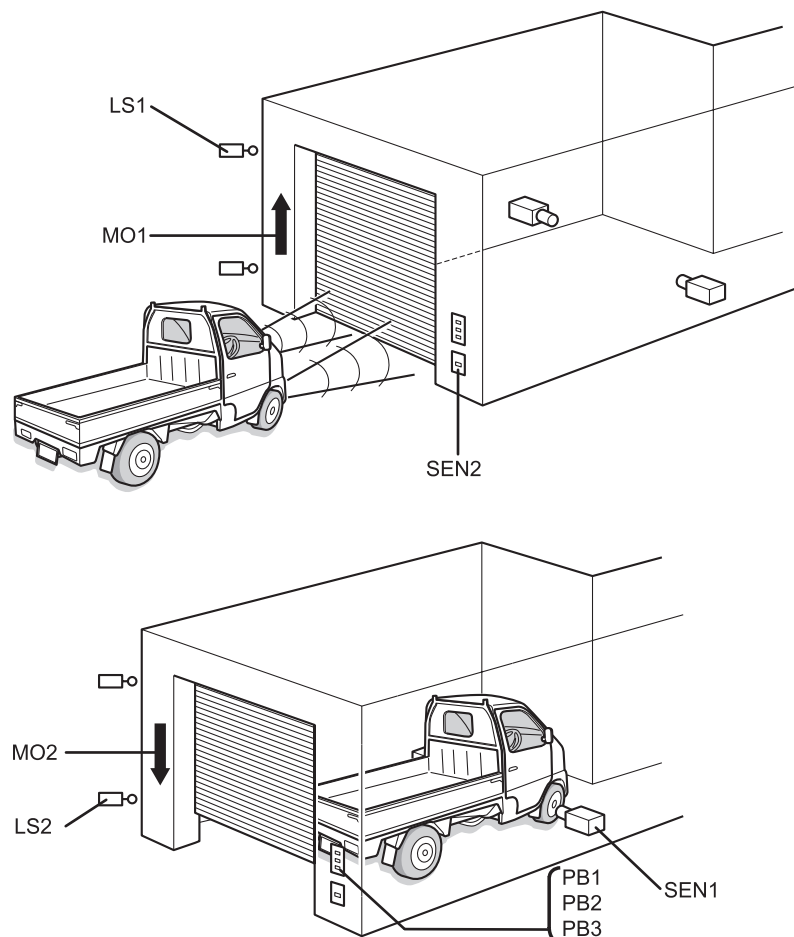



## 2-3 I/O Allocation for the Shutter Control System

I/O relays on CP1L are allocated to contacts as defined by following.

### ●Inputs

Device	Contact	Address
OPEN button	PB1	0.00
STOP button	PB2	0.01
CLOSE button	PB3	0.02
Car detection sensor	SEN1	0.03
Light detection sensor	SEN2	0.04
Upper limit LS	LS1	0.05
Lower limit LS	LS2	0.06

### ●Outputs

Device	Contact	Address
Escalation motor	MO1	100.00
De-escalation motor	MO2	100.01

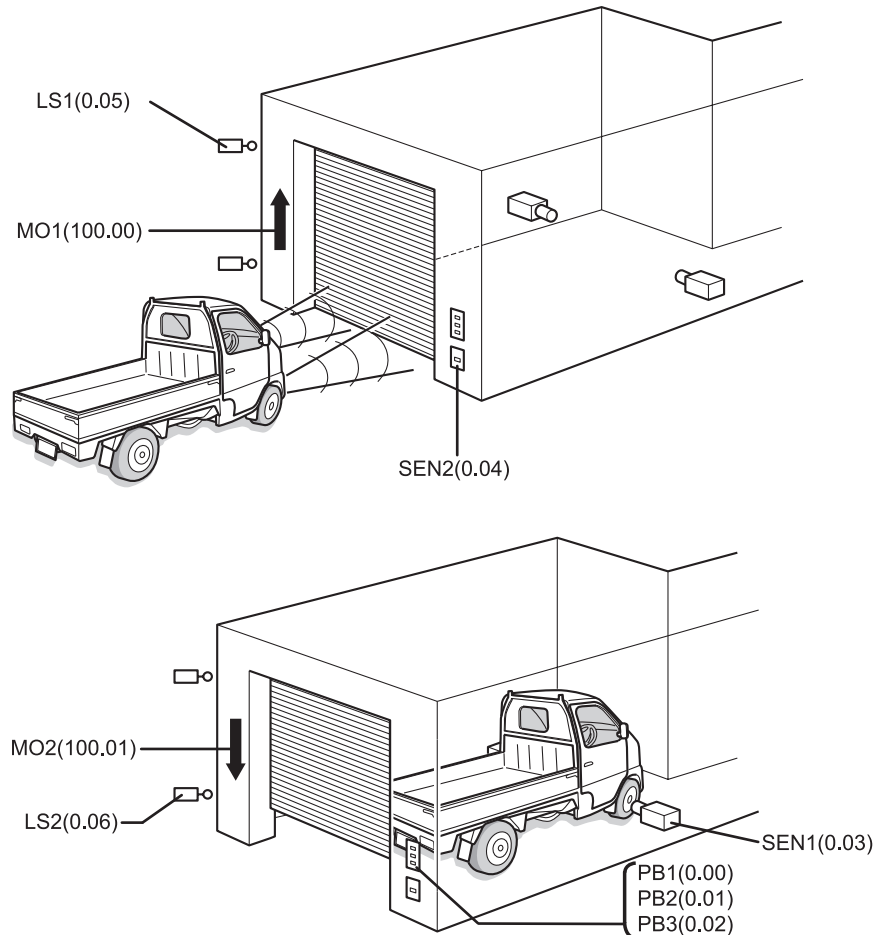

● I/O Allocation on CP1L with 14-point I/O

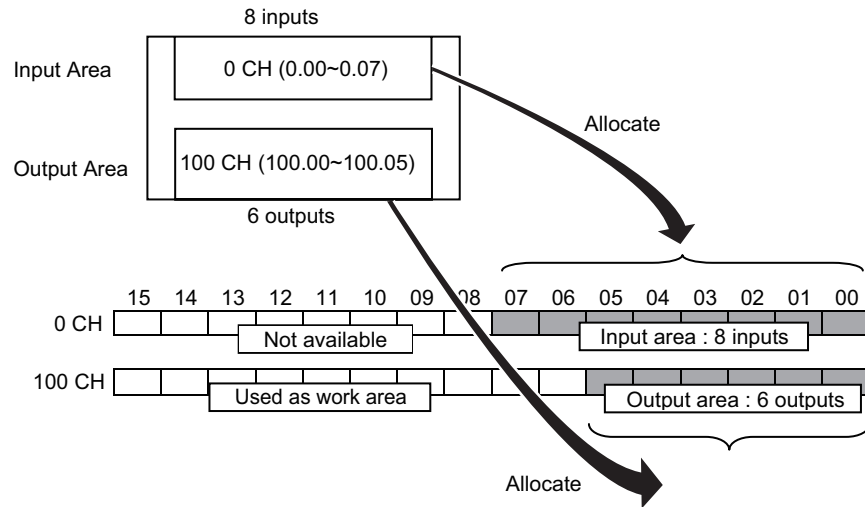

On 14-point I/O units, 8 inputs, from 0.00 to 0.07 (bits 00 to 07 on 0CH), are allocated to the input terminal block.

Also, 6 output relays, from 100.00 to 100.05 (bits 00 to 05 on 100CH), are allocated to the output terminal block.

Unused upper bits on the input channel (bits 08 to 15) cannot be used as a work area. Unused upper bits on the output channel (bits 06 to 15), however, can be used.

## 2-4 Example Ladder Program

An example ladder program for the shutter control system is shown below. Program creation is explained in *SECTION 4*.

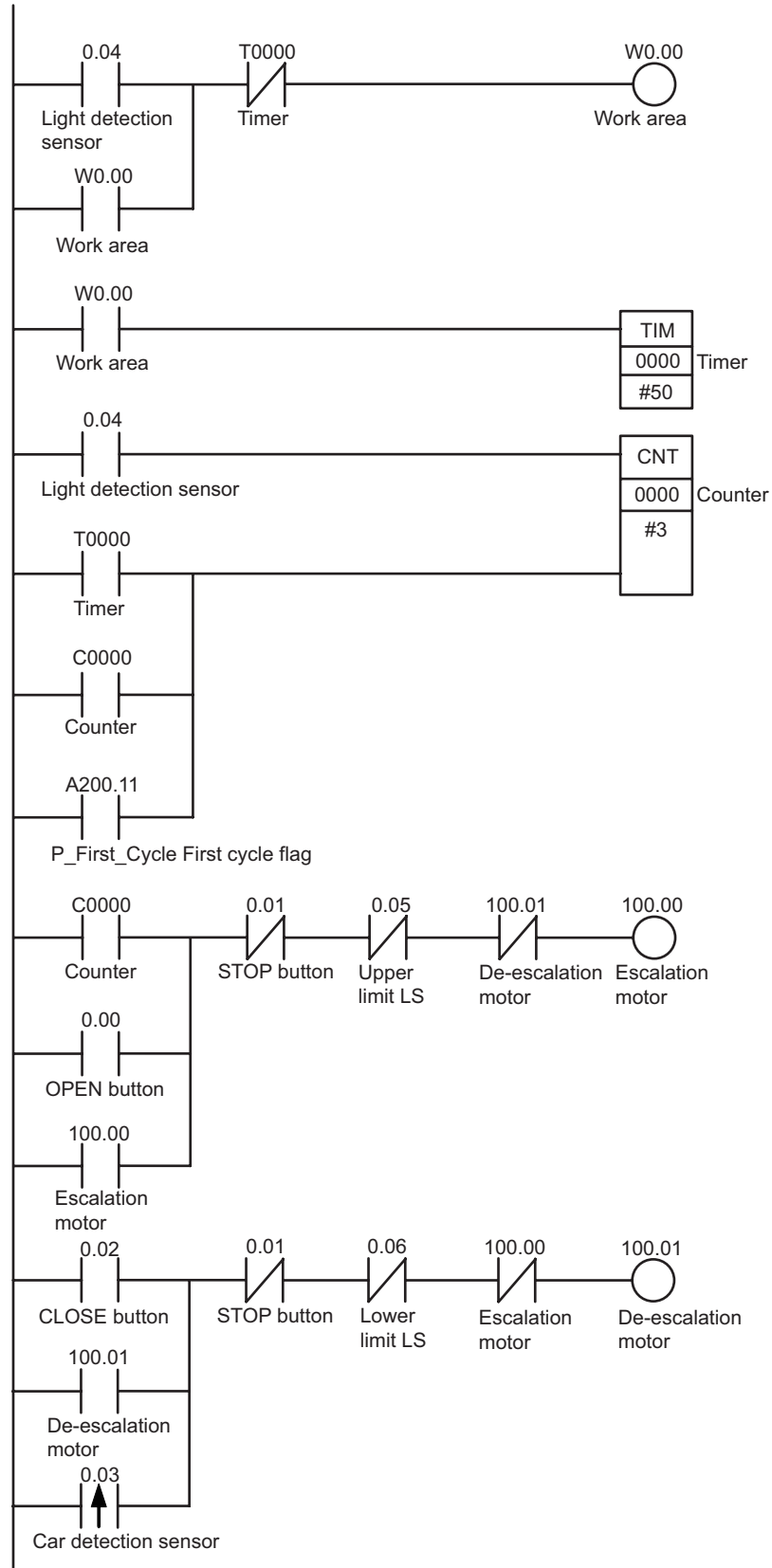

# SECTION 3

## Mounting and Wiring

This section explains how to install CP1L onto a DIN track, how to wire power supply and I/O lines, and how to test operation.

3-1	Installation Notes .....	28
3-2	Mounting onto DIN Tracks .....	31
3-3	Wiring Devices .....	32
3-3-1	Connecting Power Supply and Ground Lines .....	32
3-3-2	Connecting I/O Lines .....	33
3-4	Power Testing CP1L .....	35

## 3-1 Installation Notes

---

For improved reliability and maximized functionality, take the following factors into consideration when installing a CP1L system.

### ■ Installation Location

Do not install in the following locations:

- Locations subject to ambient temperature lower than 0°C or higher than 55°C.
- Locations subject to dramatic temperature changes, causing possible condensation.
- Locations subject to relative humidity lower than 10%RH or higher than 90%RH.
- Locations subject to corrosive or flammable gases.
- Locations subject to excessive dust, salt, or metal powder.
- Locations subject to shock or vibration.
- Locations exposed to direct sunlight.
- Locations subject to water, oil, or chemical reagent splashes.

Shield the system sufficiently when installing in the following locations:

- Locations subject to static electricity and other forms of noise.
- Locations subject to strong electromagnetic fields.
- Locations subject to possible radioactive exposure.
- Locations in close proximity to close to power lines.

### ■ Installation into Cabinets and Control Panels

When installing CP1L into a cabinet or control panel, ensure adequate environment resistance, as well as sufficient accessibility for operation and maintenance.

#### ● Temperature Control

The ambient operating temperature for CP1L is 0 to 55°C. The following precautions apply.

- Provide adequate space for air flow.
- Do not install above equipment, which generates significant heat (i.e. heaters, transformers, high-capacity resistors).
- If the ambient temperature is to exceed 55°C, install a cooling fan or air conditioner.

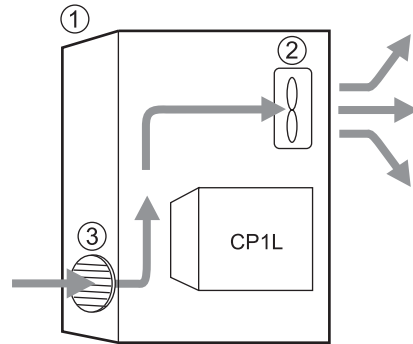

- (1) Control panel
- (2) Fan
- (3) Louver

#### ● Accessibility for Operation and Maintenance

- For safety during operation and maintenance, separate the unit as far as possible from high-voltage equipment and power machinery.
- For ease of operation, mount the unit onto the control panel at a height of 1,000 to 1,600mm.

**⚠ Caution** When power is ON or has just been turned OFF, do not touch the power supply, I/O terminals, or the surrounding areas. Doing so may result in burns. After turning the power OFF, wait for the unit to cool down sufficiently before touching it.

#### ● Improving Noise Resistance

- Avoid installing into a cabinet, which also has high-voltage equipment installed.
- Secure at a distance of 200mm or more from power lines.

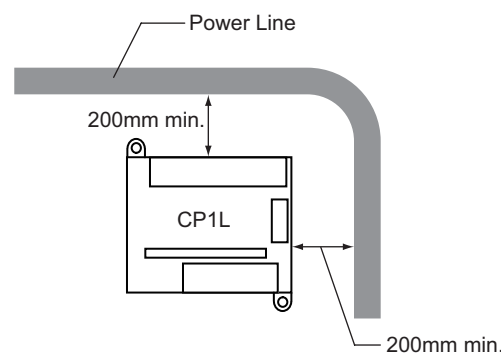

- Properly ground the mounting plate between the unit and the mounting surface.

### ● Mounting

For heat dissipation, mount CP1L in the orientation shown below.

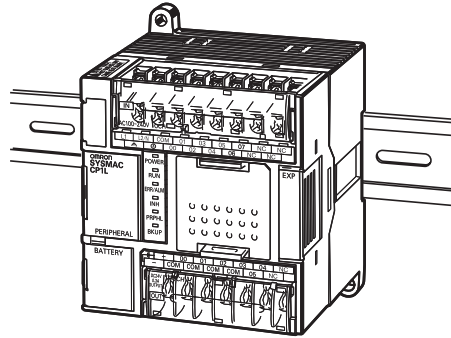

### ■ External Dimensions

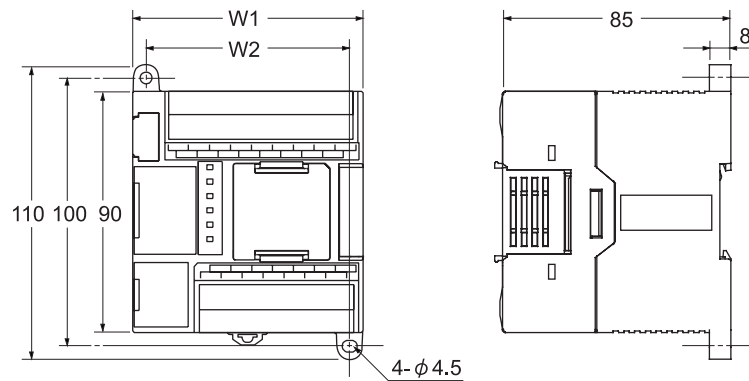

Model	W1	W2
CP1L-L10D□-□	66	56
CP1L-L14D□-□	86	76
CP1L-L20D□-□	86	76
CP1L-L30D□-□	130	120
CP1L-L40D□-□	150	140
CP1L-M60D□-□	195	185

### ■ DIN Track

Secure the DIN track onto the control panel, using at least 3 screws.

- Use M4 screws at intervals of 210mm (6 holes) or less. Screw torque is 1.2N·m.

For details on installing CP1L, refer to *SECTION 3 Installation and Wiring of CP Series CP1L CPU Unit User's Manual (W462)*.

## 3-2 Mounting onto DIN Tracks

This section explains how to mount CP1L onto a DIN track.

1. Pull out the DIN track mounting pin (1).

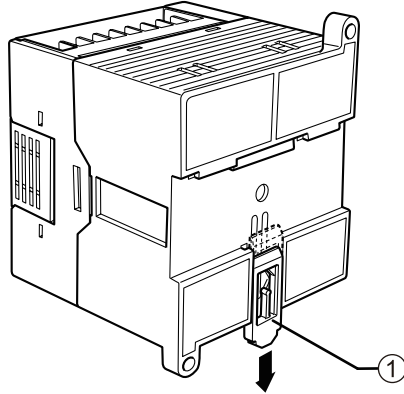

2. Hook the rear panel of CP1L onto the DIN track (1), as shown.

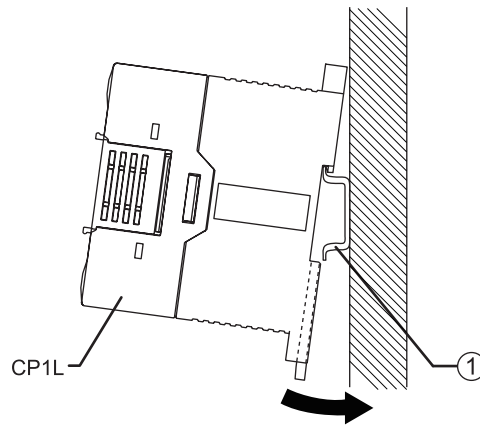

3. Push in the DIN track mounting pin (1) to secure CP1L.

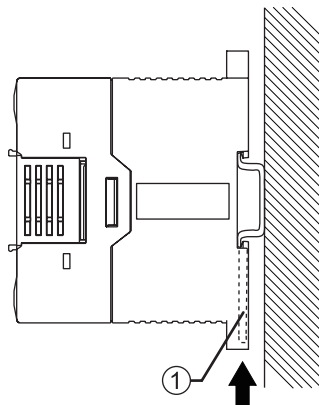



## 3-3 Wiring Devices

This section explains how to wire CP1L (14-point I/O unit with AC power supply).

### ■ Protective Label

Wire scraps may be scattered during wiring. To prevent them from entering the unit, leave the protective label (adhered on the top surface of the unit) on until wiring is done.

When wiring is complete, remove the label to ensure proper heat dissipation.

### 3-3-1 Connecting Power Supply and Ground Lines

This section explains how to wire the power and ground lines.

#### ■ Units with AC Power Supply

Power and ground terminals (A) are located near the top of CP1L.

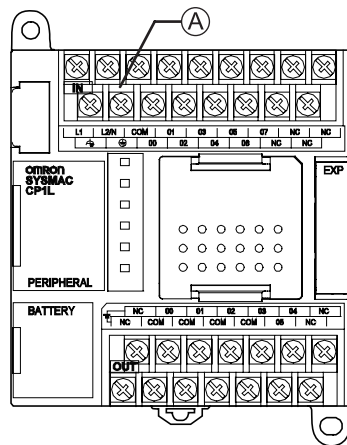

Terminal block layout at (A)

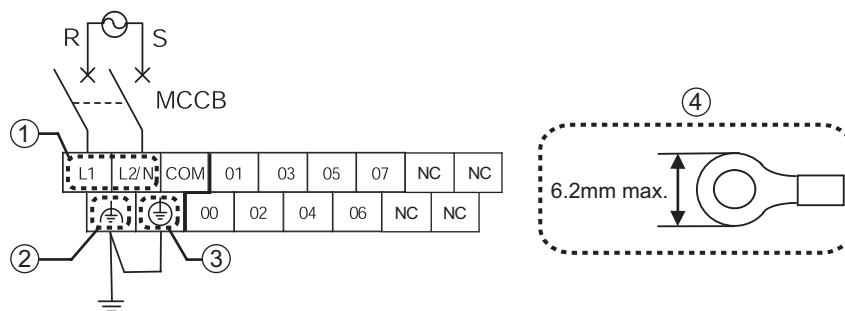

#### (1) Power supply terminal

Supply 100 to 240VAC voltage at 50/60Hz.

The acceptable supply voltage range is 85 to 264VAC.

- Use separate circuits for the power supply circuit and the motor circuit, in order to prevent voltage drops due to starting currents and inrush currents from other equipment.
- Use a twisted-pair of power supply cables to prevent noise from the power supply line. Adding a 1:1 isolating transformer will further reduce electrical noise.

- In consideration of voltage drops and allowable current, use the thickest electrical wire possible.
- (2) LG  
LG is a functional ground terminal (noise-filtered neutral terminal). To resolve errors and electrical shocks caused by noise, short the LG and GR terminals for a class D grounding (ground resistance of 100  $\Omega$  or less).
  - (3) GR  
GR is a protective ground terminal. To prevent electrical shocks, use a dedicated ground line (2mm<sup>2</sup> or thicker) for a class D grounding (ground resistance of 100  $\Omega$  or less).
    - To prevent electrical shocks and noise, always ground the terminal with class D grounding (ground resistance of 100  $\Omega$  or less).
    - If the power supply has a grounded phase, connect the grounded phase to the L2/N terminal.
    - Do not share the ground line with other equipment, or connect it to building structure beams. The results may be unfavorable.
  - (4) Recommended crimp terminal  
When wiring the AC power supply, use ring-type crimp terminals to prevent unintended disconnection.

**⚠ WARNING** Secure the AC power supply line to the terminal block with 0.5N·m of torque. Loosening the screw may result in a fire or malfunction.

## 3-3-2 Connecting I/O Lines

### ■ 14-point I/O Units

CP1L has input terminals located at the top, and output terminals located at the bottom.

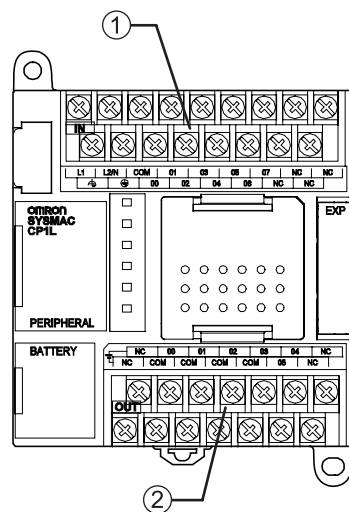

- (1) Input terminal
- (2) Output terminal

### ●Wiring Inputs

1. Wire the inputs as shown, while referring to *2-3 I/O Allocation for the Shutter Control System*.

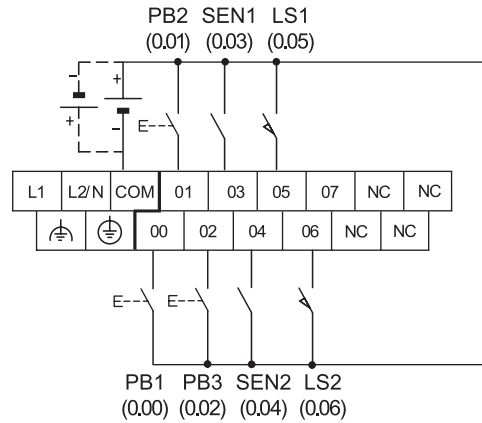

### ●Wiring Outputs

1. Wire the outputs as shown, while referring to *2-3 I/O Allocation for the Shutter Control System*.

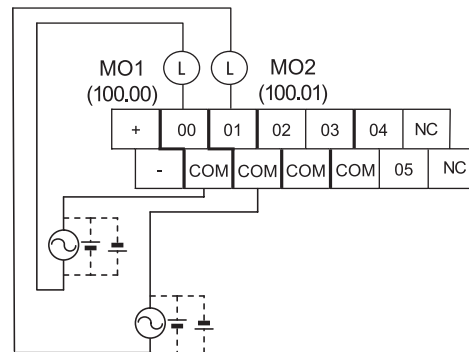

For details on wiring, refer to *3-5-4 I/O Wiring for CPU Units with 14 I/O Points of CP Series CP1L CPU Unit User's Manual (W462)*.

## 3-4 Power Testing CP1L

After wiring CP1L, perform a power test.

### ■ Turning Power ON

Supply power to CP1L, and then check the status with the indicators.

1. Turn the power OFF for all components (escalation motor, de-escalation motor, etc.).
2. Turn the power ON for CP1L.
3. Wait 2 seconds for the CP1L to initialize.
4. Check the indicators on CP1L. If [POWER] and [RUN] are lit, CP1L is operating normally.

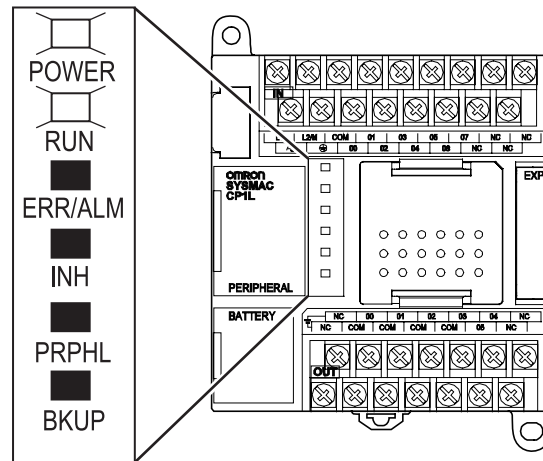

**Note** When CP1L is turned ON, it will go into RUN mode automatically.

5. Turn the power OFF for CP1L.

**Note** Battery

## • Using a battery

The battery maintains the internal clock and retained regions of I/O memory while the power supply is OFF.

If no battery is installed, or if the installed battery is running low, the internal clock will stop, and data in the retained regions of I/O memory will be lost.

Data such as user programs and PLC system settings are not lost even when the power is OFF and no battery is installed.

For details on replacing the battery, refer to *10-2 Replacing User-servicable Parts of CP Series CP1L CPU Unit User's Manual (W462)*.

## • Battery-free operation

If there is no need to reference the PLC clock and RAM data, CP1L can be used without a battery (battery-free operation).

For details, refer to *6-5 Battery-free Operation of CP Series CP1L CPU Unit User's Manual (W462)*.

# SECTION 4

## Creating Programs

In this section, the steps for creating ladder programs essential to CP1L operation will be shown, using CX-Programmer. In creating the ladder program for the shutter control system, the basic functions of CX-Programmer will be explained.

4-1	Preparing for Programming.....	38
4-1-1	What is CX-Programmer? .....	38
4-1-2	Connecting to a Computer and Installing the USB Driver .....	39
4-2	Creating Ladder Programs .....	44
4-2-1	Operation.....	44
4-2-2	Ladder Program.....	46
4-3	Using CX-Programmer.....	47
4-3-1	Starting CX-Programmer .....	47
4-3-2	Operation Screens.....	48
4-4	Using the Help .....	50
4-5	Inputting Programs .....	53
4-5-1	Creating New Projects .....	53
4-5-2	Inputting Contacts.....	56
4-5-3	Inputting Output Coils .....	59
4-5-4	Inputting Timers .....	61
4-5-5	Inputting Counters .....	63
4-5-6	Inputting Auxiliary Areas.....	66
4-5-7	Inputting Differentiated Up Contacts.....	68
4-5-8	END Instruction .....	69
4-6	Saving/Loading Programs .....	70
4-6-1	Compiling Programs .....	70
4-6-2	Saving Programs .....	71
4-6-3	Loading Programs .....	72
4-7	Editing Programs .....	73
4-7-1	Editing I/O Comments .....	73
4-7-2	Inputting Rung Comments.....	74
4-7-3	Editing Rungs .....	75

## 4-1 Preparing for Programming

---

---

This section explains the necessary preparations, such as connecting CP1L to a computer and installing the USB driver, in order to begin creating ladder programs.

### 4-1-1 What is CX-Programmer?

CX-Programmer is a programming tool (software) for creating the ladder programs that are to be executed by CP1L.

In addition to programming functions, it also offers other useful functions for CP1L setup and operation, such as debugging programs, address and values display, PLC setup and monitoring; and remote programming and monitoring via the network.

CX-Programmer can be run on computers running Windows 98 SE, Me, NT 4.0 (SP6a), 2000 (SP3 or later), or XP.

For details on installing CX-Programmer, refer to *1-1 Installation of CX-Programmer* of *CX-Programmer Introduction Guide* (R132).

For details on using CX-Programmer, refer to *CX-Programmer Operation Manual* (W446).

## 4-1-2 Connecting to a Computer and Installing the USB Driver

To use CX-Programmer, you must connect CP1L to a computer, which has CX-Programmer installed. This section explains how to connect CP1L to a computer. The computer to be connected to must have CX-Programmer Ver.7.1 or later installed.

You will also need a USB cable to connect CP1L to the computer.

Furthermore, a USB driver must be installed for CP1L to be recognized by the computer.

### ●Items Required for Connection

Operating system	Windows 98, Me, 2000, or XP
Software	CX-One (i.e. CX-Programmer)
USB driver	Included with software
USB cable	USB 1.1 (or 2.0) cable (A-B), 5m or shorter

### ●Restrictions on USB Connections

Due to limitations of the USB specifications, the following restrictions apply when connecting CP1L to a computer.

- Only 1 CP1L can be connected to a computer at any given time. You cannot connect multiple CP1Ls simultaneously.
- Do not disconnect the USB cable while the system is online. Before disconnecting the USB cable, switch the application to offline status. If the USB cable is disconnected while online, the following will occur:

[Windows 2000, XP]

Simply reconnecting the USB cable will not restore CX-Programmer to online status. First switch CX-Programmer to offline status, reconnect the USB cable, and then switch CX-Programmer back to online status.

[Windows 98, Me]

If the USB cable is disconnected while the system is online, a blue error screen may be displayed. In this case, you will need to reboot the computer.



## ■ Connecting to a Computer and Installing the USB Driver

This section explains how to connect CP1L to a computer running Windows XP. For details on connecting CP1L to a computer running Windows 2000, refer to *1-3-1 Connecting with a Commercially Available USB Cable of CP Series CP1L CPU Unit User's Manual (W462)*.

1. Turn the power ON for CP1L and the computer.
2. Using a USB cable (2), connect the peripheral USB port (3) on CP1L to a USB port on the computer (1).

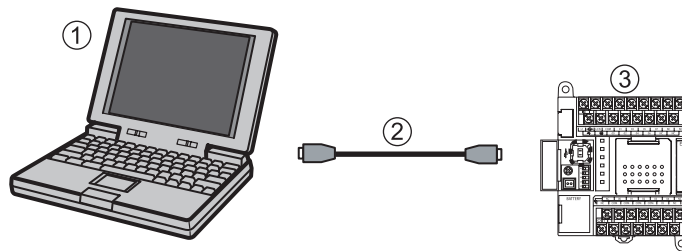

When the computer detects CP1L, the following message will be displayed.



The Found New Hardware Wizard dialog box will be displayed. This screen will be used to install the USB driver.

**Note** The programming console is not available for CP1L.

3. On the Found New Hardware Wizard dialog box, select [No, not this time], and click [Next].

Depending on computer environment, the Found New Hardware Wizard dialog box may not be displayed. If it is not displayed, proceed to step 4.



4. Select [Install from a list of specific location (Advanced)], and click [Next].



5. Confirm that [Include this location in the search] is checked, and that [C:\Program Files\OMRON\CX-Server\USB\Win2000\_XP\Inf] is displayed in the location field. Click [Next].

Driver installation will begin.

When the installation is complete, a dialog box will be displayed, confirming that installation is complete.

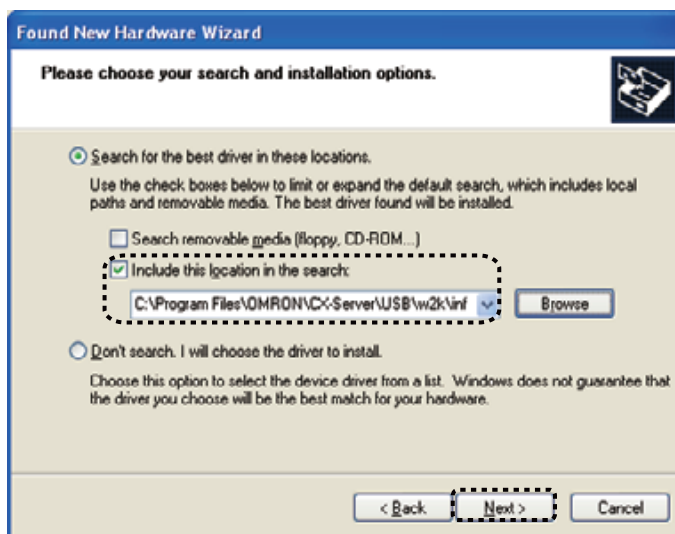

If the Hardware Installation dialog box is displayed, click [Continue Anyway].

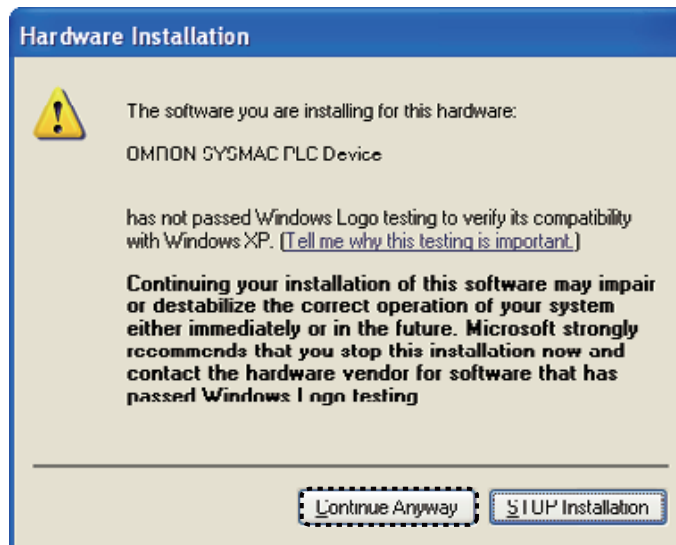

6. Click [Finish].  
USB driver installation is now complete.



## ■ Confirming Installation

Confirm that the driver has been installed properly.

1. **On the desktop, select [Start], and then right-click [My Computer].**  
A context menu will be displayed.
2. **Select [Properties].**  
The System Properties dialog box will be displayed.
3. **Select the Hardware tab, and click [Device Manager].**  
The Device Manager dialog box will be displayed.
4. **Double-click [Universal Serial Bus controllers].**
5. **Confirm that [OMRON SYSMAC PLC Device] is displayed.**  
If so, the USB driver has been installed successfully.

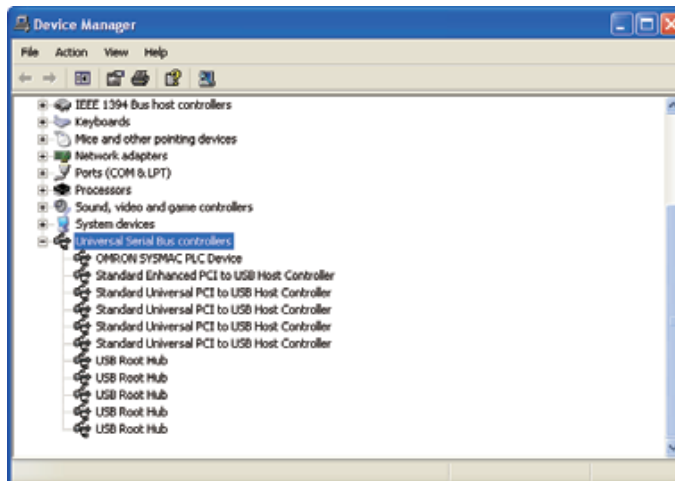

6. **Close the Device Manager dialog box, and then the System Properties dialog box.**

If [OMRON SYSMAC PLC Device] is not displayed, reinstall the USB driver. For details on reinstalling the USB driver, refer to *1-3-1 Connecting with a Commercially Available USB Cable of CP Series CP1L CPU Unit User's Manual (W462)*.

## 4-2 Creating Ladder Programs

A ladder program can now be created for the example introduced in *SECTION 2 System Design*. First, however, the functions of the ladder program will be described.

### 4-2-1 Operation

The ladder program to be created will open and close a garage shutter. For details on the example application, refer to *2-2-1 Operation*.

#### ● Entering the Garage

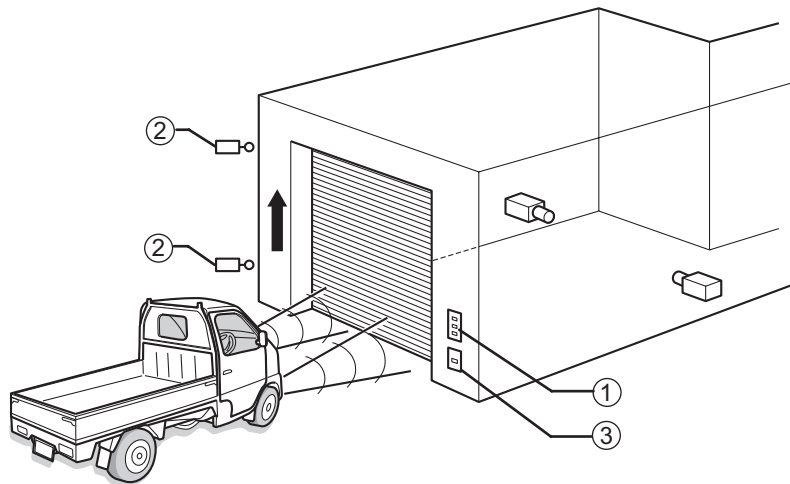

The component functions and operations will be defined in detail below.

(1) Push-buttons:

- The shutter can be opened, closed, and stopped with buttons.
- The OPEN and CLOSE buttons will continue operating the shutter even when they are not held down. A self-maintaining bit is used to achieve this.

(2) Limit switches:

- When the shutter is fully opened or fully closed, it will be stopped by a limit switch.
- When the shutter is opening, the de-escalation motor will be interlocked to prevent damage.

(3) Light detection sensor:

- A light detection sensor detects light from headlights pointed at the garage. When 3 headlight flashes are detected by a counter instruction, the shutter escalation motor is activated.
- After the first headlight flash, a timer is activated by a timer instruction. After 5 seconds, a reset command is given to the counter instruction.
- The present value of the counter instruction is retained even when CP1L is powered OFF. To prevent malfunction, a reset command is given to the counter instruction when CP1L is powered ON.

●After Entering the Garage / Exiting the Garage

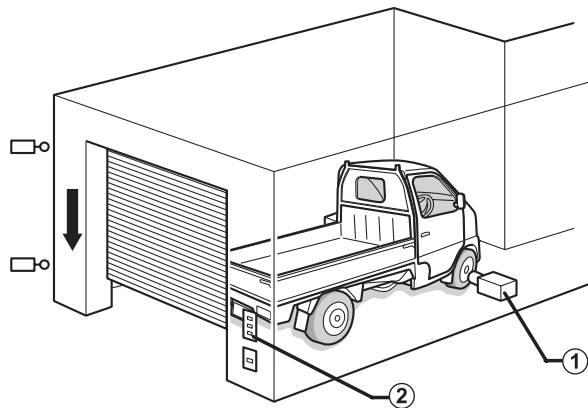

(1) Car detection sensor:

- A car detection sensor will detect full car entrance into the garage, and activate the shutter de-escalation motor.

(2) Push-buttons:

- When pulling the car out of the garage, use the buttons to operate the shutter.
- When pulling the car out of the garage, a differentiated up contact should be used as the car detection sensor, so that the shutter does not close immediately upon fully opening.

A ladder program will be set forth hereafter based on the description above.

## 4-2-2 Ladder Program

The ladder program for the example application is shown below.

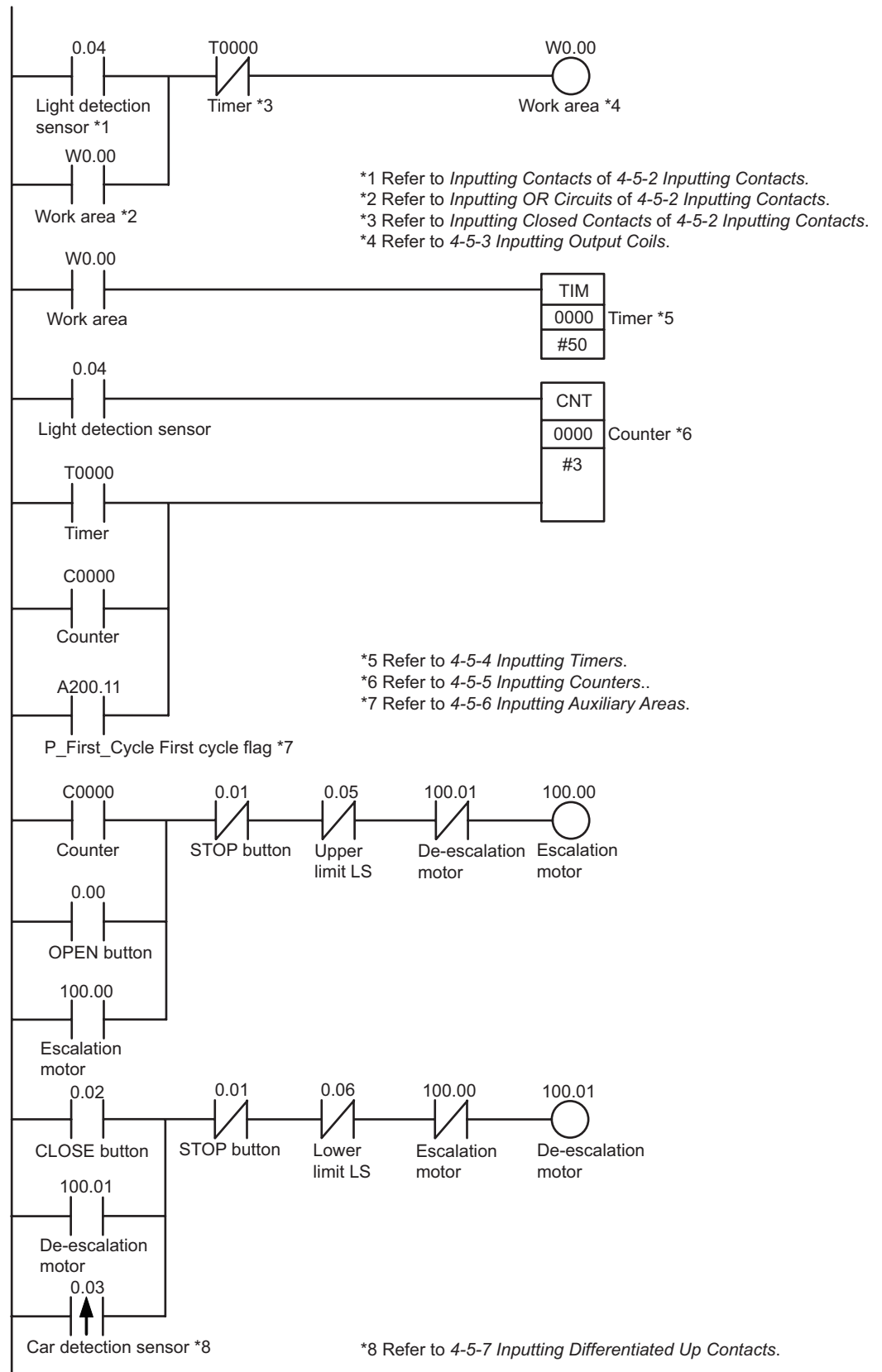

Creating the program in CX-Programmer will be explained in the next section.

## 4-3 Using CX-Programmer

This section explains CX-Programmer start-up and operation screens..

### 4-3-1 Starting CX-Programmer

1. On the desktop, select [Start] - [All Programs] - [OMRON] - [CX-One] - [CX-Programmer] - [CX-Programmer].

CX-Programmer will start.

The title screen will be displayed, followed by the main window.

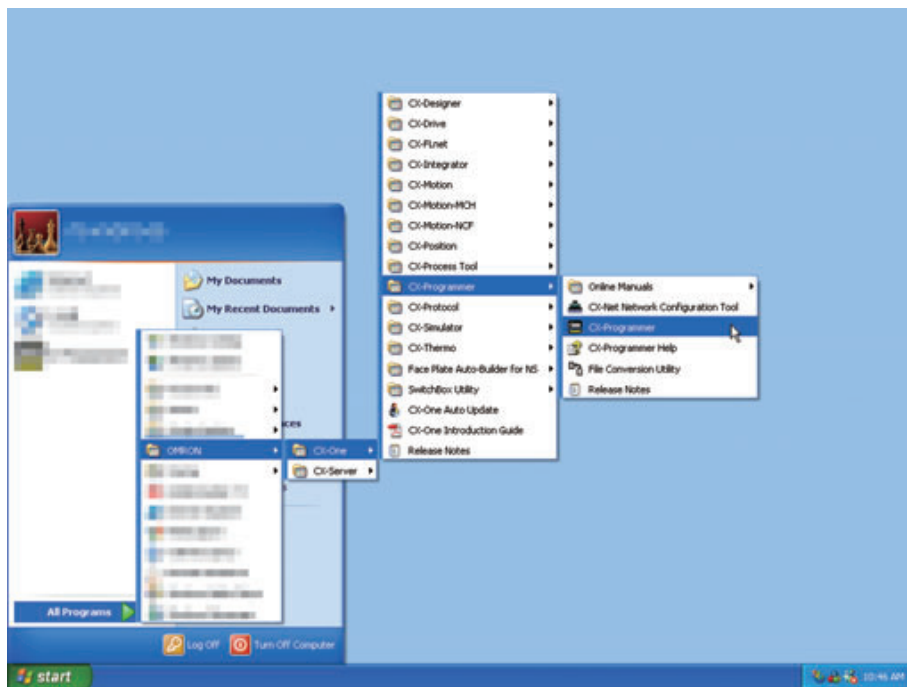

**Note** For details on installing CX-Programmer, refer to *Chapter 1 Overview and Installation of CX-One* of *CX-One Introduction Guide (R145)*.



## 4-3-2 Operation Screens

This section explains the functions available on the CX-Programmer main window. For details on using CX-Programmer, refer to *CX-Programmer Operation Manual* (W446).

### ● Main Window

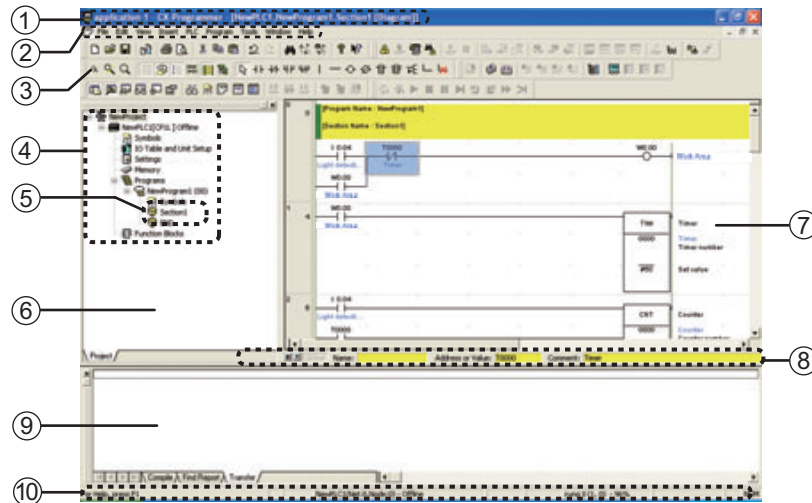

- (1) Title bar  
Displays the data file name, created in CX-Programmer.
- (2) Main menu  
Used to select CX-Programmer functions.
- (3) Toolbars  
Displays icons for frequently used functions. Place the mouse cursor over an icon to display the corresponding function name.  
Select View - Toolbars from the main menu to show/hide toolbars. Drag the toolbars to change their position.
- (4) Project tree / (6) Project workspace  
Used to manage programs and settings. Drag & drop items to copy the data.  
Select [View] - [Windows] - [Workspace] from the main menu to show/hide the workspace.
- (5) Section  
Programs can be split into and managed as multiple parts.
- (7) Diagram workspace  
Used to create and edit ladder programs.
- (8) I/O comment bar  
Displays the name, address/value, and I/O comment for the variable selected by the mouse cursor.

## (9) Output window

Select [View] - [Windows] - [Output] from the main menu to show/hide the output window. Displays the following information:

Compile:

Displays program check results.

Find Report:

Displays search results for contacts, instructions, and coils.

Transfer:

Displays errors which occurred while loading a project file.

## (10) Status bar

Displays information such as PLC name, offline/online status, and active cell position.

If an online connection error or other errors occur and are recorded by the error log while online, a blinking red error message will be displayed. Select [View] - [Windows] - [Status Bar] from the main menu to show/hide the status bar.

### ●Diagram Workspace

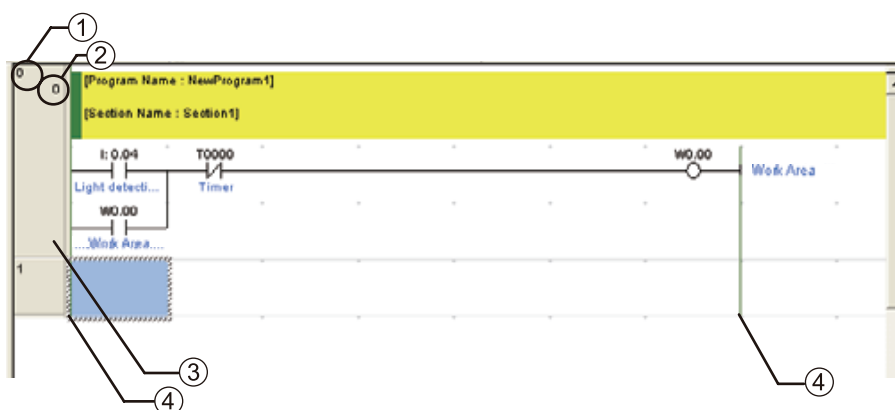

(1) Rung number

(2) Program address

(3) Rung header

If a rung is incomplete, a red line will be displayed to the right of its rung header.

(4) Bus bar

### ●Information Window



Displays basic shortcut keys used in CX-Programmer.

Select [View] - [Windows] - [Information Window] from the main menu to show/hide the information window.

## 4-4 Using the Help

CX-Programmer Help provides information on the CX-Programmer screens, and explains all operations including basic functions, program creation, and monitoring. Instructions, as well as formats and operand functions, are also explained.

### ■ Referencing CX-Programmer Help

1. **While using CX-Programmer, press the [F1] key.**

The help window will be displayed.

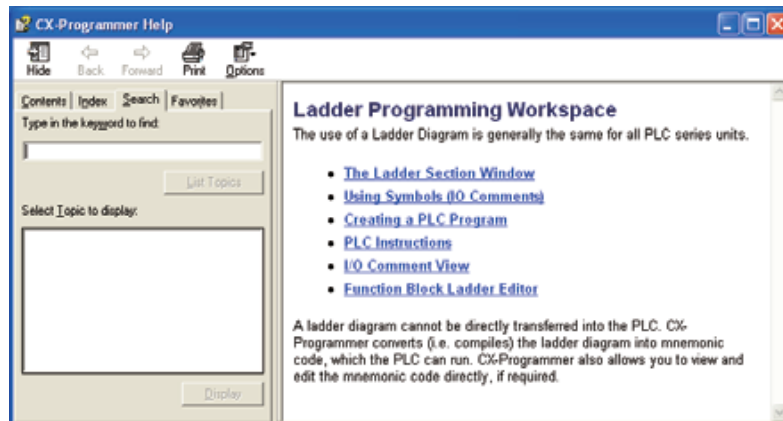

CX-Programmer Help can also be displayed in several other ways.

### ● From the Desktop Menu

1. **On the desktop, select [Start] - [All Programs] - [OMRON] - [CX-One] - [CX-Programmer] - [CX-Programmer Help].**

CX-Programmer Help will be displayed.

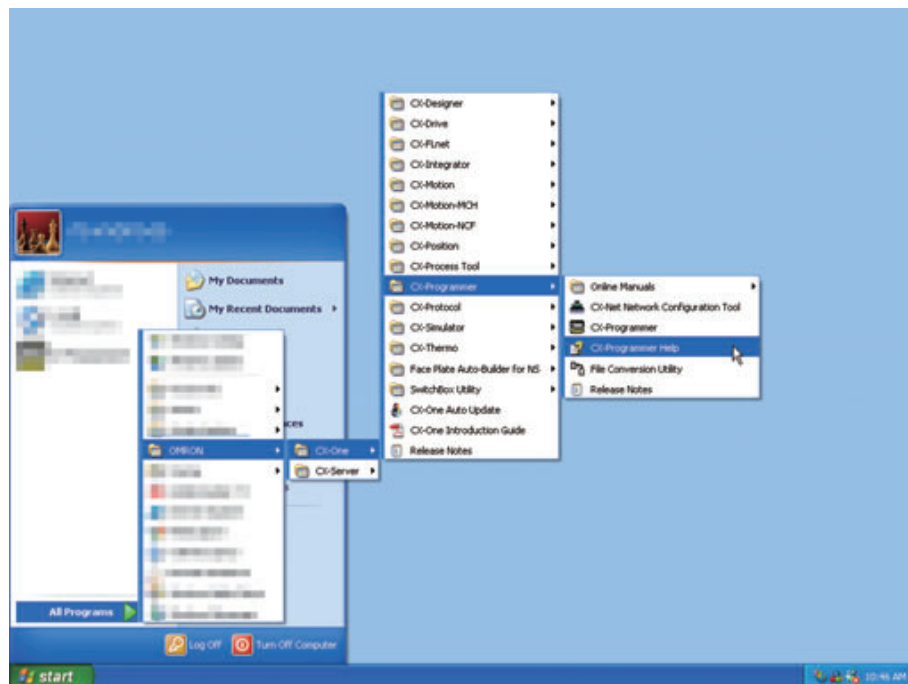

- From CX-Programmer

1. **Select [Help] - [Help Contents] from the main menu.**  
CX-Programmer Help will be displayed.

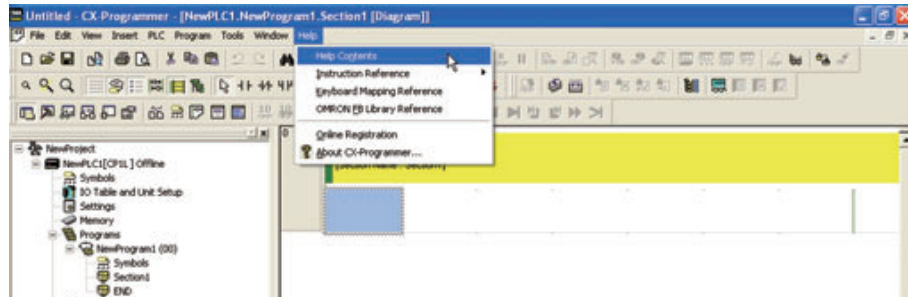

- Referencing PLC Instruction Sets

For details on instructions used in ladder programs, refer to PLC Instruction Sets.

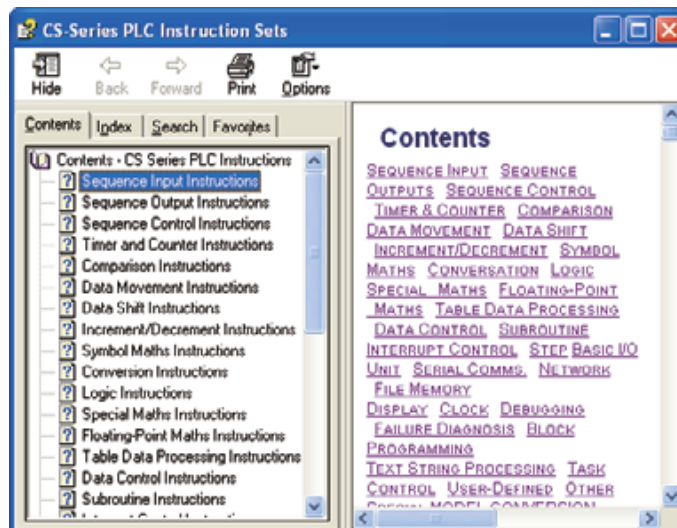

- From CX-Programmer

1. **Select [Help] - [Instruction Reference] - [CS/CJ-Series and CP-Series] from the main menu.**

CP-Series PLC Instruction Sets will be displayed.

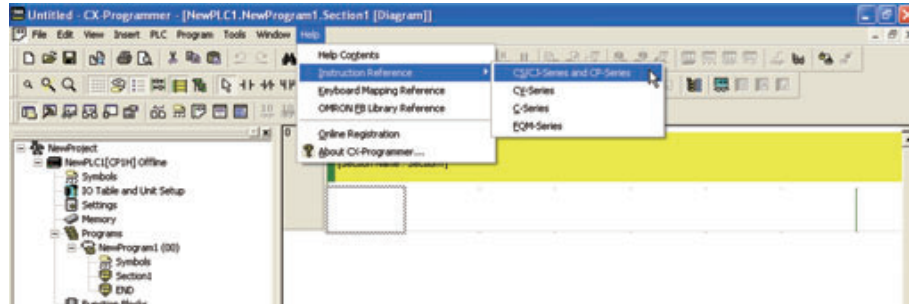

- While Creating Ladder Programs

1. **While creating a ladder program instruction, click [Instruction Help] on the New Instruction dialog box.**

CP-Series PLC Instruction Sets will be displayed.

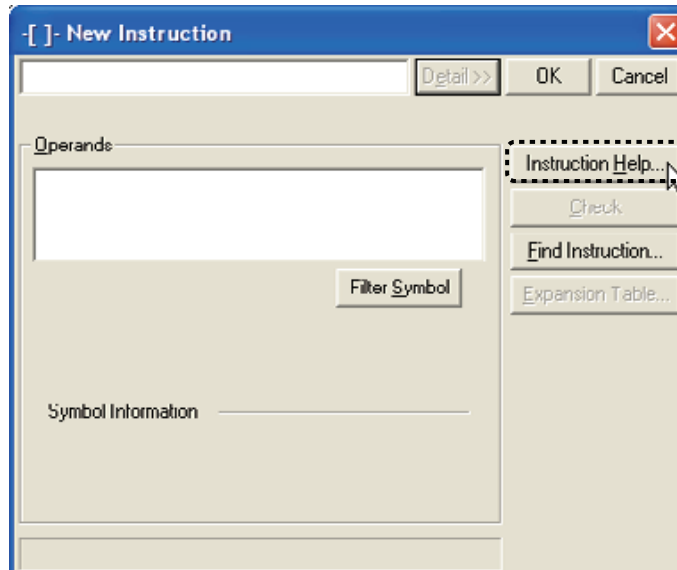

**Note** When selecting a special instruction, Instruction Help will be displayed.

## 4-5 Inputting Programs

Using the commands available in CX-Programmer, create a program for the example application.

### 4-5-1 Creating New Projects

When using CX-Programmer for the first time, you will need to create a new project. When creating a new project, you must set the target device type and CPU type for the program and data being created.

1. **Select [File] - [New] from the main menu.**  
The Change PLC dialog box will be displayed.

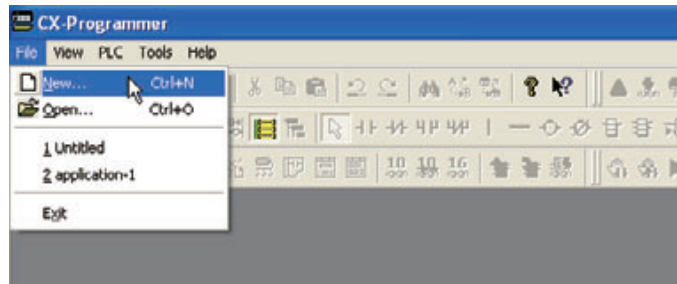

2. **Select [CP1L] from the Device Type drop-down list.**

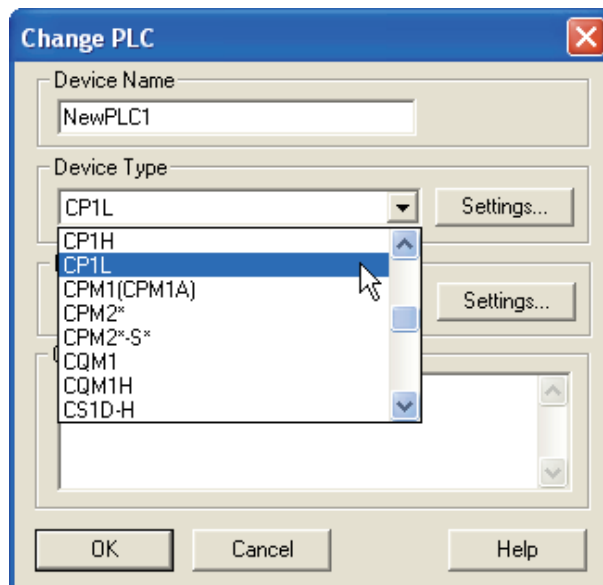

3. Click **[Settings]**.  
The Device Type Settings dialog box will be displayed.

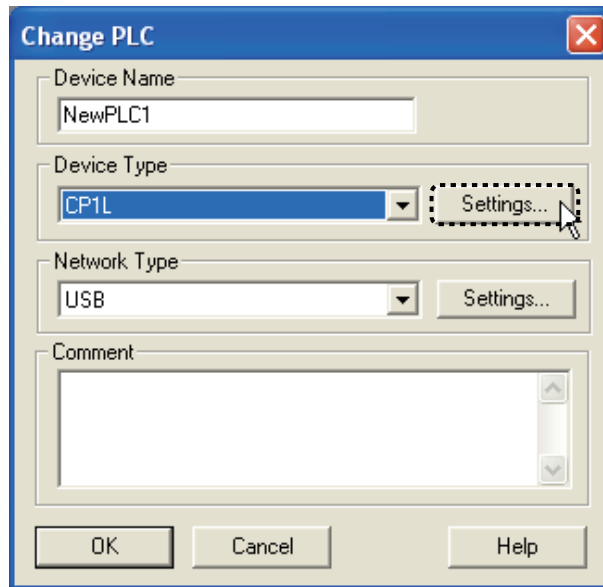

4. Select the CPU from the CPU Type drop-down list. Click **[OK]**.  
The Device Type Settings dialog box will be closed.

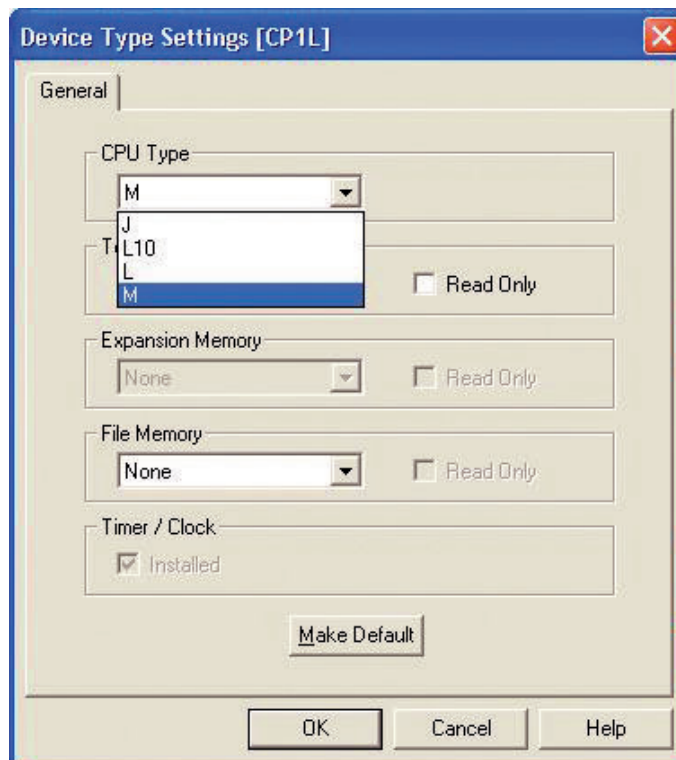

5. Confirm that [USB] is displayed for Network Type. Click [OK].

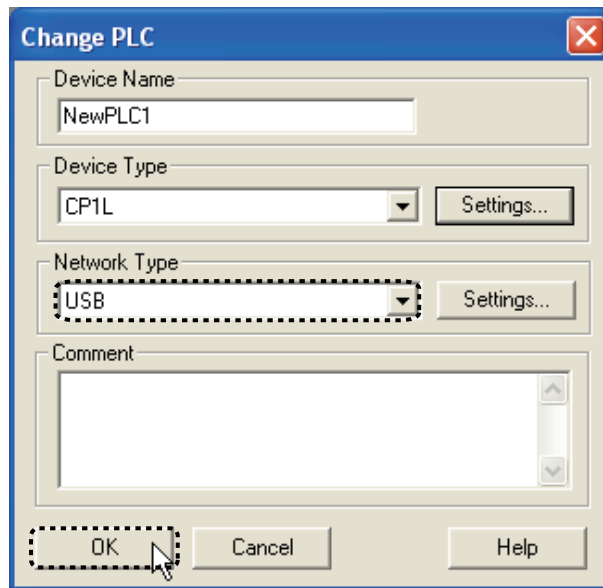

The Change PLC dialog box will be closed. Main window for the new project will be displayed.

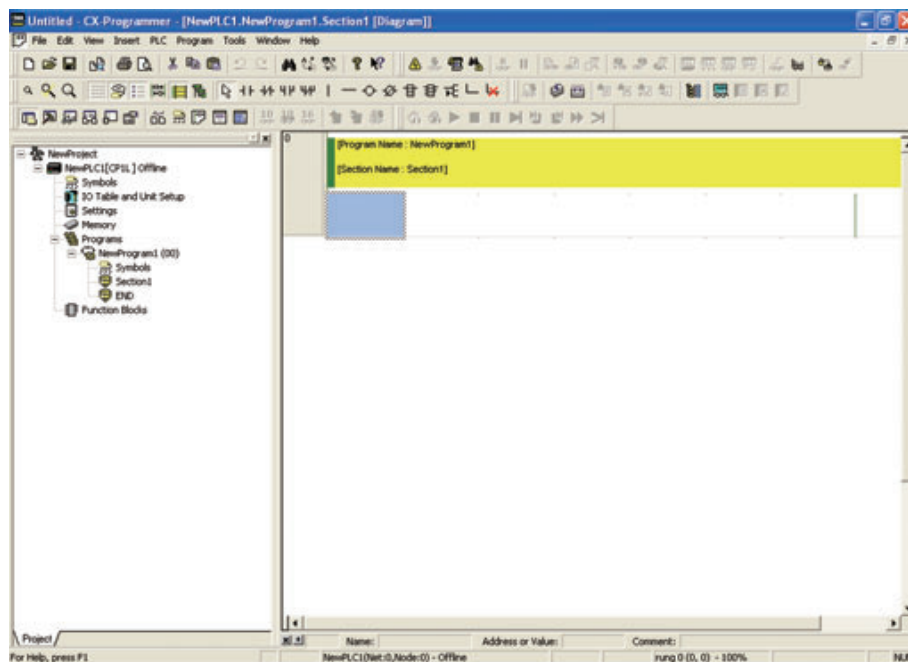

If [USB] is not displayed for Network Type, refer to *4-1-2 Connecting to a Computer and Installing the USB Driver* and confirm that the USB driver has been installed properly.



## 4-5-2 Inputting Contacts

Input a contact. For details on ladder programs, refer to *4-2-2 Ladder Program*.

### ■ Inputting Contacts

1. **Press the [C] key.**

The New Contact dialog box will be displayed.

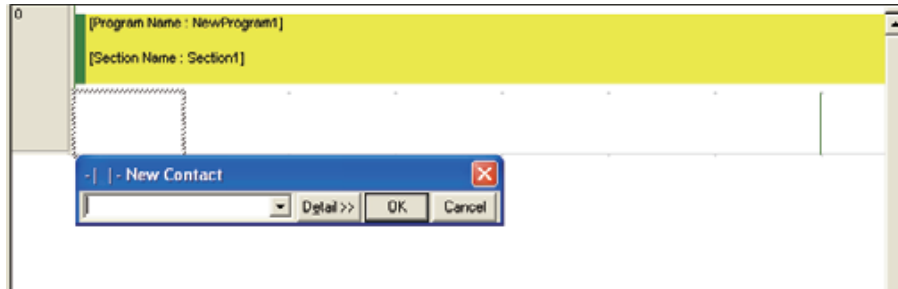

2. **Input address "4". Press the [Enter] key.**

"4" is entered. The Edit Comment dialog box will be displayed.



3. **Input "Light detection sensor" as the I/O comment. Press the [Enter] key.**

A contact representing input from the light detection sensor will be displayed on the ladder program.

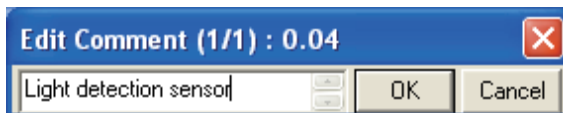

Next, input an OR circuit.

## ■ Inputting OR Circuits

1. **Place the cursor on the program. Press the [Enter] key.**  
A space for inserting an OR circuit will be created.



2. **Press the [W] key.**  
The New Contact OR dialog box will be displayed.

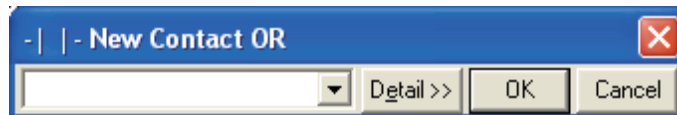

3. **Input address "W0". Press the [Enter] key.**  
"W0" is entered. The Edit Comment dialog box will be displayed.

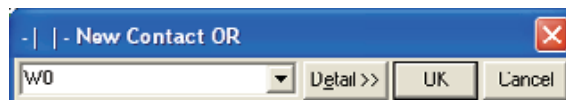

4. **Input "Work Area" as the I/O comment. Press the [Enter] key.**  
An OR circuit representing the work area contact will be displayed.



Next, input a closed contact.

## ■ Inputting Closed Contacts

1. **Press the up arrow key.**

The cursor is moved upward.

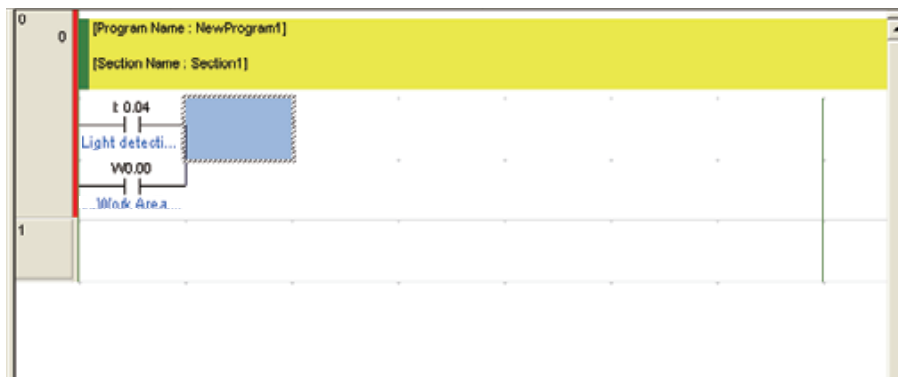

2. **With the cursor in the up position, press the [/] key.**  
The New Closed Contact dialog box will be displayed.

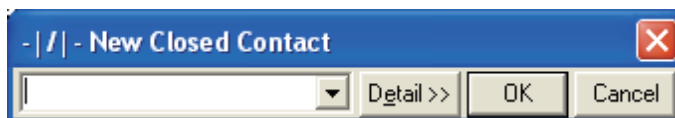

3. **Input address "T0". Press the [Enter] key.**

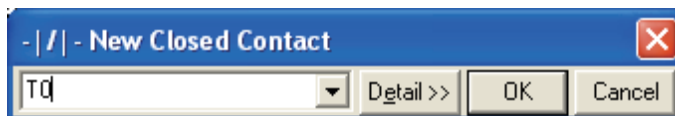

"T0" is entered. The Edit Comment dialog box will be displayed.



4. **Input "Timer" as the I/O comment. Press the [Enter] key.**  
An AND circuit representing the timer closed contact will be displayed.



Next, input a work area output.

### 4-5-3 Inputting Output Coils

Input an output coil for the work area.

1. **Press the [O] key.**  
The New Coil dialog box will be displayed.

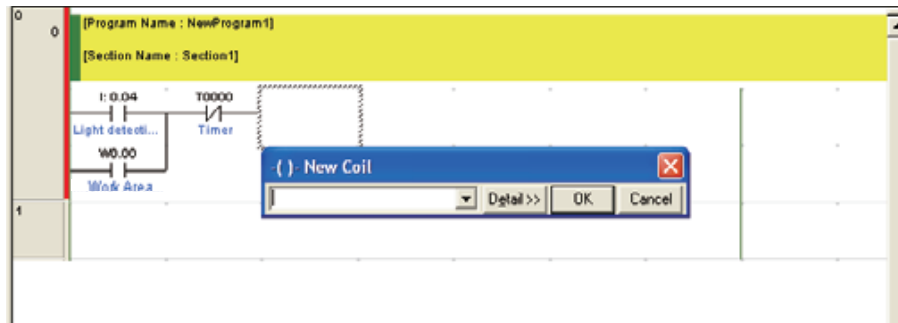

2. **Input address "W0". Press the [Enter] key.**  
"W0" is entered. The Edit Comment dialog box is displayed with the I/O comment already entered.



3. **Press the [Enter] key.**



An output coil for the work area will be displayed on the ladder program.

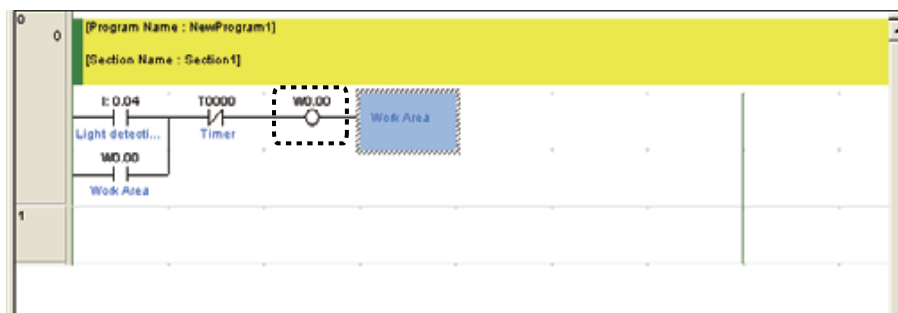

#### 4. Press the down arrow key 2 times.

When the cursor is positioned on the next rung, the current rung input is complete.

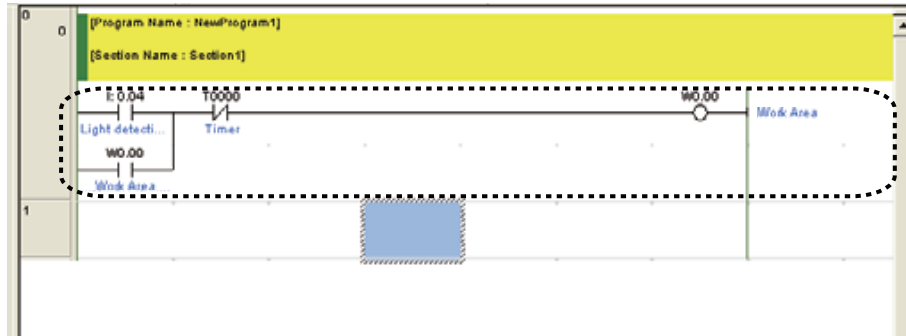

Next, input a timer instruction.

#### Note Duplicated Coils

Do not duplicate coils.

If the same address is specified for multiple outputs, only the rung closer to the END instruction will be valid.

This is because programs are executed sequentially from top to bottom. Invalid rungs caused by duplicated coils will be detected by CX-Programmer as an error.

E.g. A program with duplicated coils

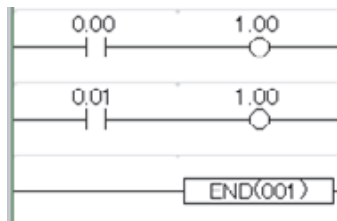

The error may be resolved by modifying the program as shown below.

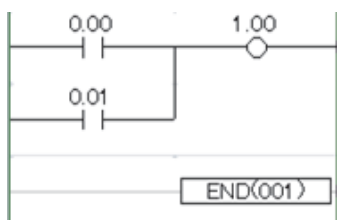

## 4-5-4 Inputting Timers

1. Press the [C] key. Input contact "W000". Then, press the [Enter] key while the Edit Comment dialog box is up.

For details on inputting a contact, refer to 4-5-2 *Inputting Contacts*.

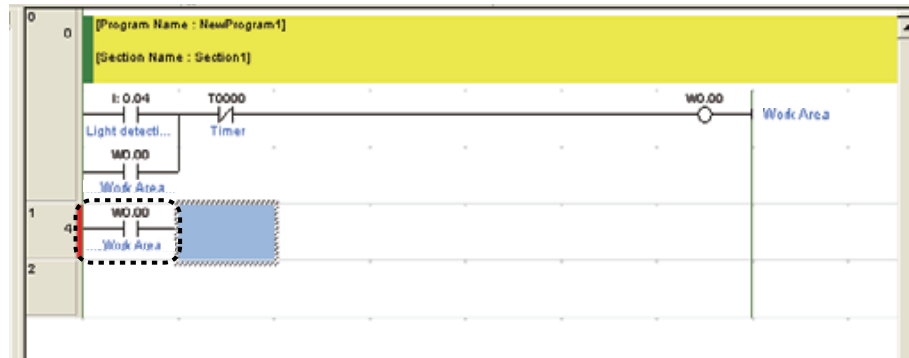

2. Press the [I] key.

The New Instruction dialog box will be displayed.

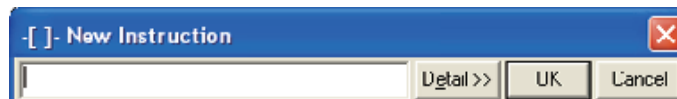

3. Input timer instruction "TIM 0 #50". Press the [Enter] key.

"TIM 0 #50" is entered. The Edit Comment dialog box is displayed with the I/O comment already entered.

"TIM 0 #50" indicates a 5.0 second delay timer, with a timer completion flag of T0000.



4. Press the [Enter] key.

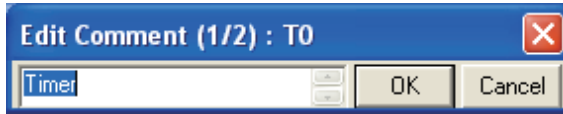

A timer instruction will be displayed on the ladder program.

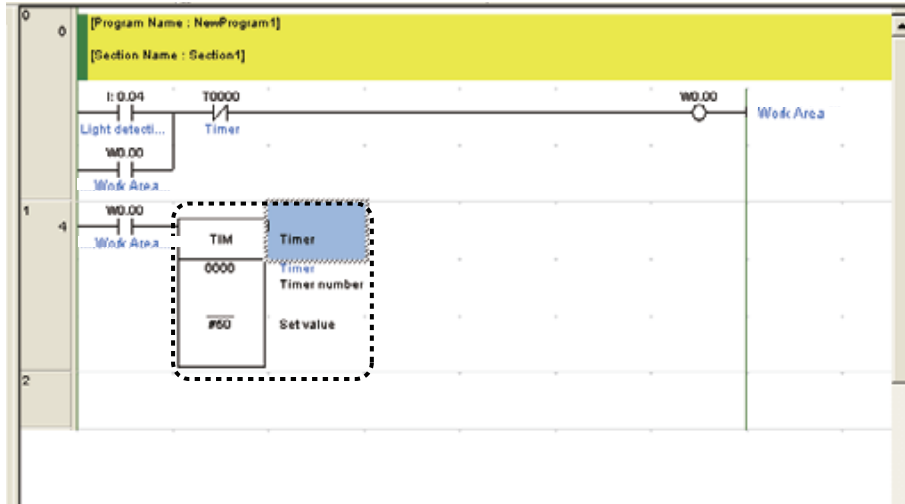

5. Press the down arrow key 3 times.

When the cursor is positioned on the next rung, timer instruction input is complete.

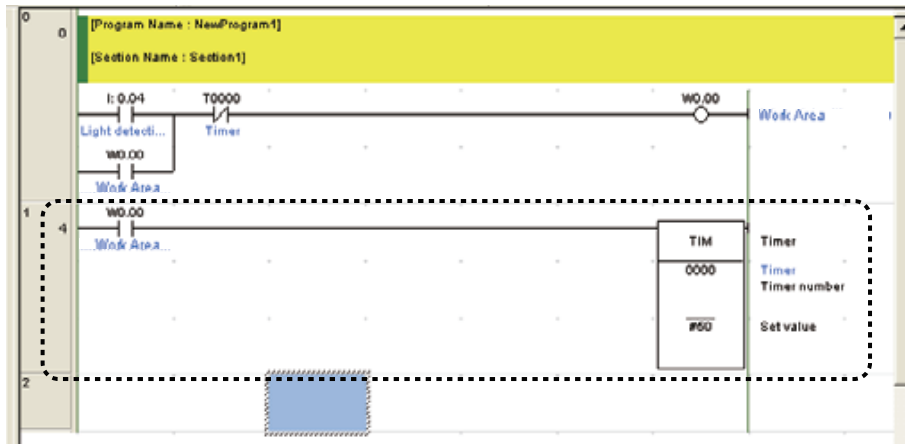

Next, input a counter instruction.

## 4-5-5 Inputting Counters

1. Press the [C] key. Input contact "004". Then, press the [Enter] key while the Edit Comment dialog box is up.

For details on inputting a contact, refer to 4-5-2 *Inputting Contacts*.

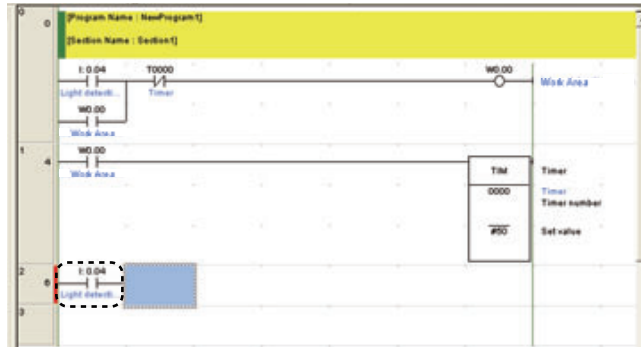

2. Press the [I] key. The New Instruction dialog box will be displayed.

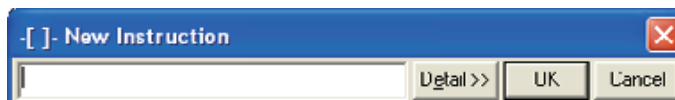

3. Input counter instruction "CNT 0 #3". Press the [Enter] key.

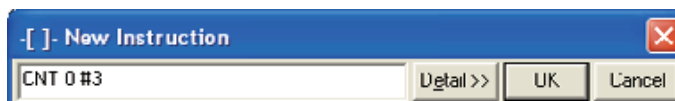

"CNT 0 #3" is entered. The Edit Comment dialog box is displayed with the I/O comment already entered.

"CNT 0 #3" indicates a decrementing counter starting at count 3, with a counter completion flag of C0000.

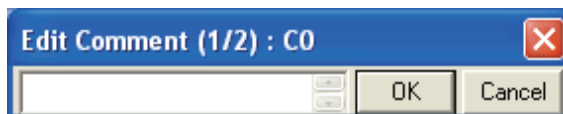



4. Input "Counter" as the I/O comment. Press the [Enter] key.

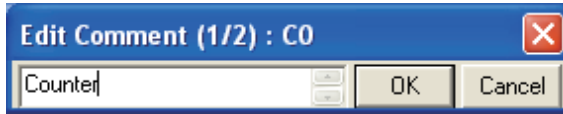

A counter instruction will be displayed on the ladder program.

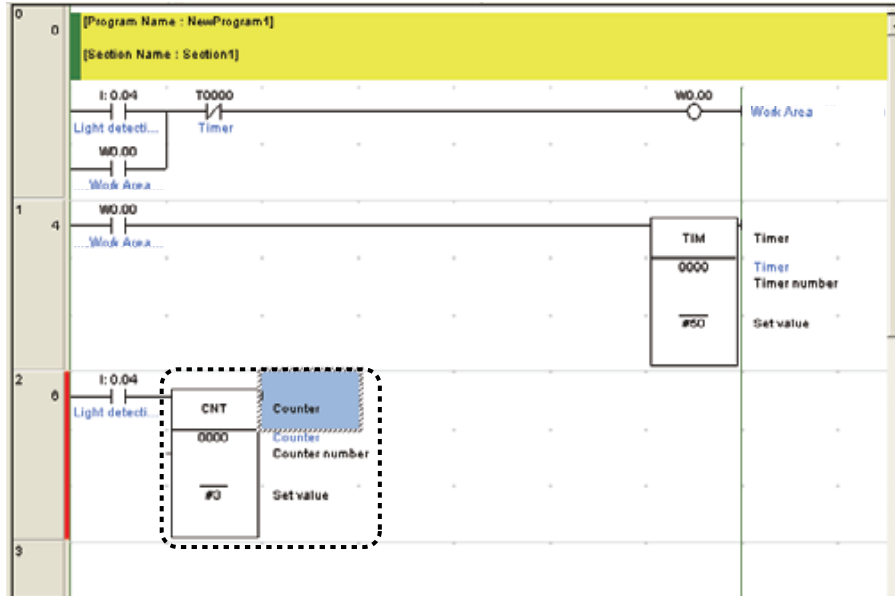

Next, input a reset input for the counter instruction.

The timer contact (TIM 0000) will be used as the reset input.

5. Place the cursor below the contact created in step 1.

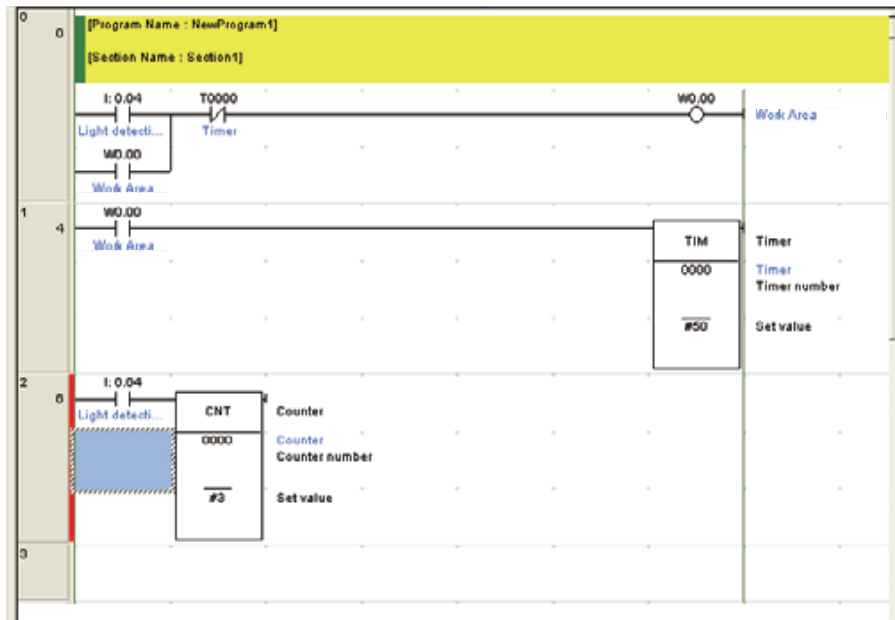

## 6. Input contact "T0000".

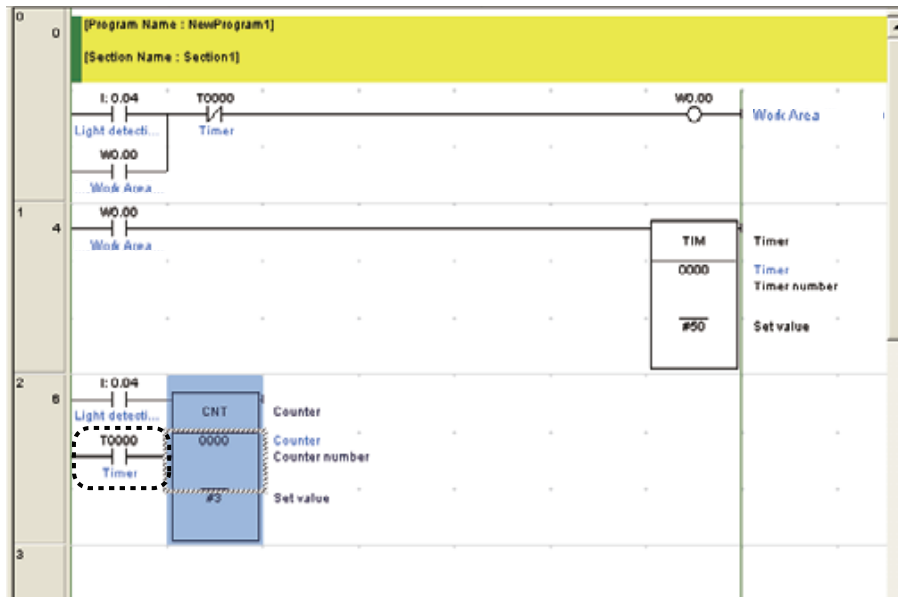

## 7. Press the down arrow key 2 times.

When the cursor is positioned on the next rung, counter instruction input is complete.

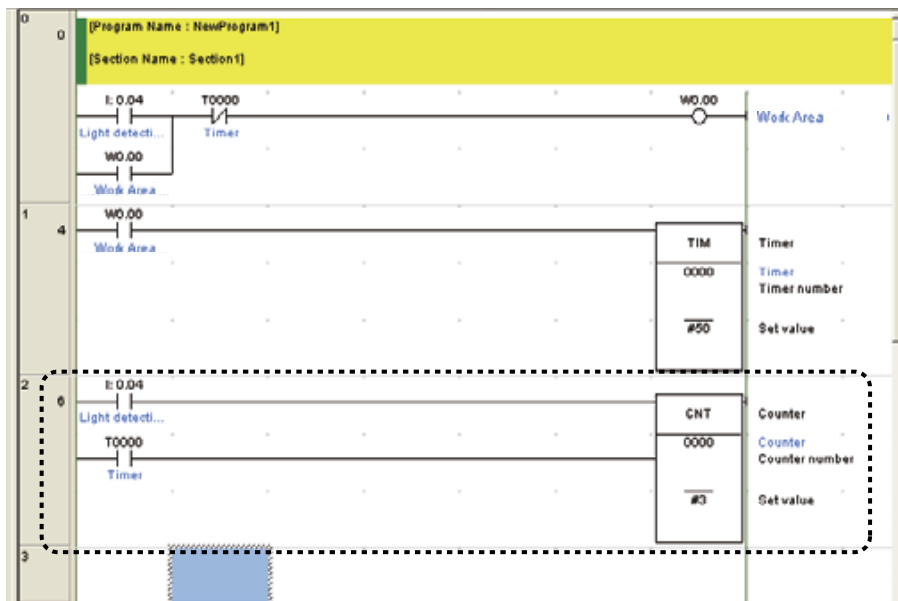

Next, input an auxiliary area.

### 4-5-6 Inputting Auxiliary Areas

Auxiliary area is a relay with a specific purpose.

The first cycle flag will be ON for only 1 cycle after the PLC has been powered ON. Here, it will be used to reset the counter when CP1L is powered ON.

1. Press the [W] key. Input an OR circuit contact "C0000". Then, press the [Enter] key while the Edit Comment dialog box is up.

For details on inputting a contact, refer to 4-5-2 Inputting Contacts.

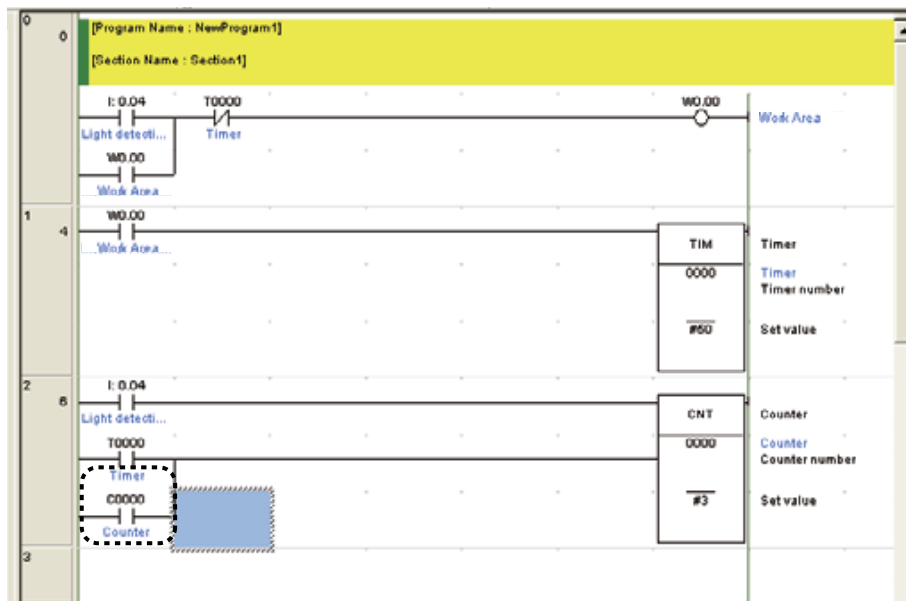

2. Press the [Enter] key.

A space for inserting an OR circuit will be created.

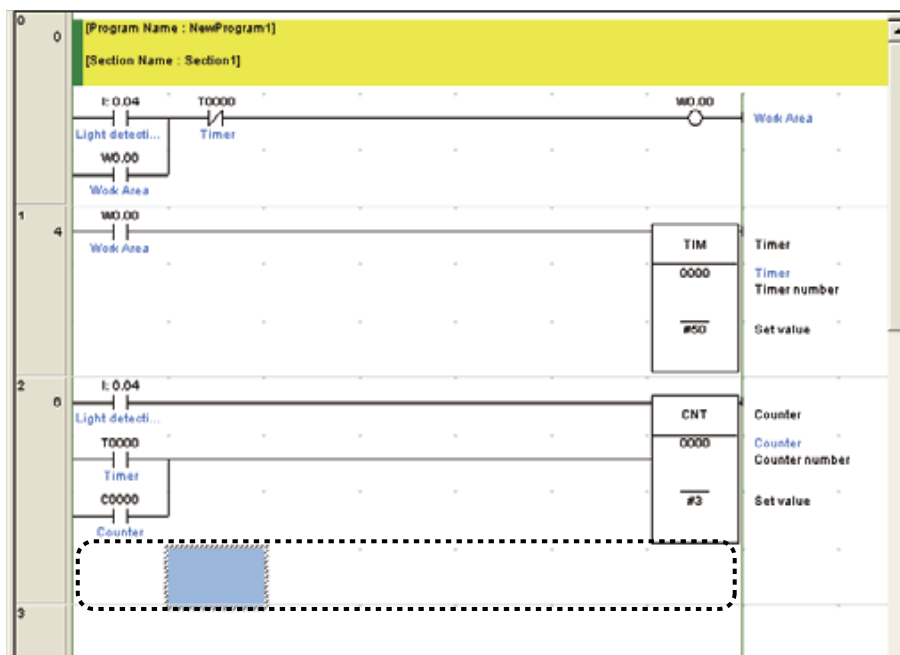

3. Press the left arrow key.
4. Press the [W] key.  
The New Contact OR dialog box will be displayed.
5. Input address "A20011". Press the [Enter] key.



A first cycle flag will be displayed on the ladder program.

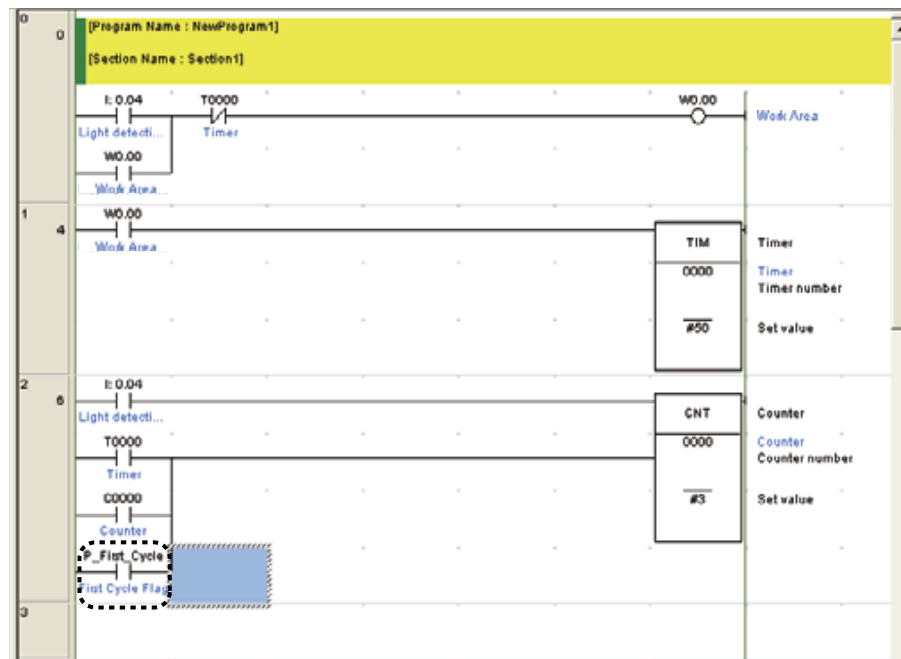

## 4-5-7 Inputting Differentiated Up Contacts

1. While referring to 4-2-2 Ladder Programs, enter a ladder program, extending to de-escalation motor contact, "10001".

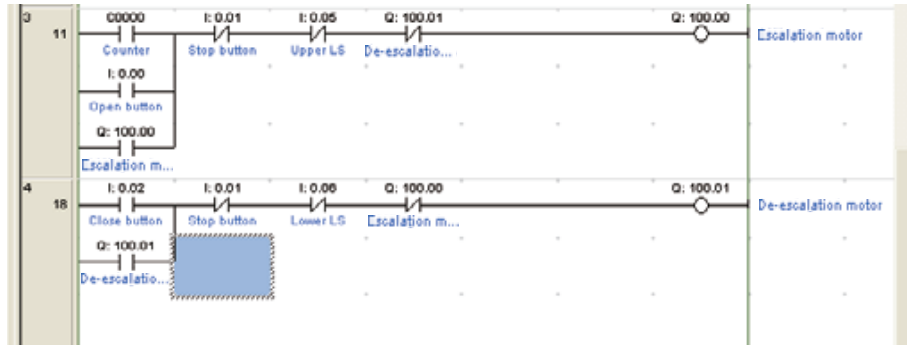

2. Press the [Enter] key.  
A space for inserting an OR circuit will be created.
3. Press the [W] key.  
The New Contact OR dialog box will be displayed.
4. Input address "3". Press the [Enter] key.  
The Edit Comment dialog box will be displayed.
5. Input "Car detection sensor" as the I/O comment. Press the [Enter] key.  
A contact representing input from the car detection sensor will be displayed as an OR circuit.

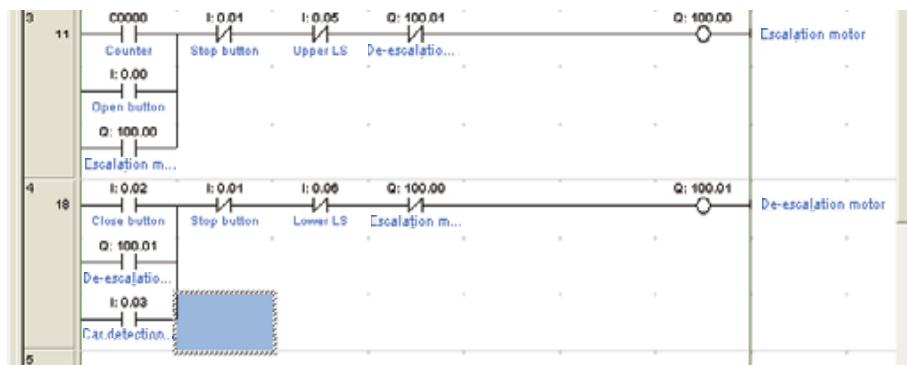

6. Double-click contact "003".  
The Edit Contact dialog box will be displayed.

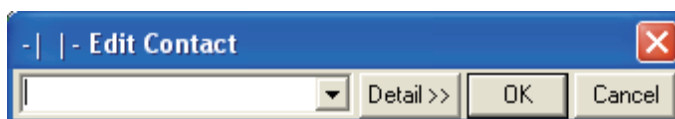

7. Click [Detail].



8. Select [Up] for Differentiation. Click [OK].

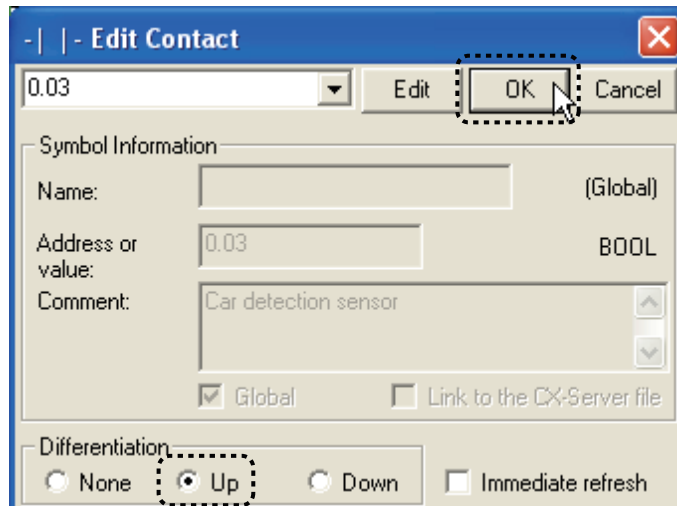

An upward arrow representing a differentiated up condition will be displayed on the contact.

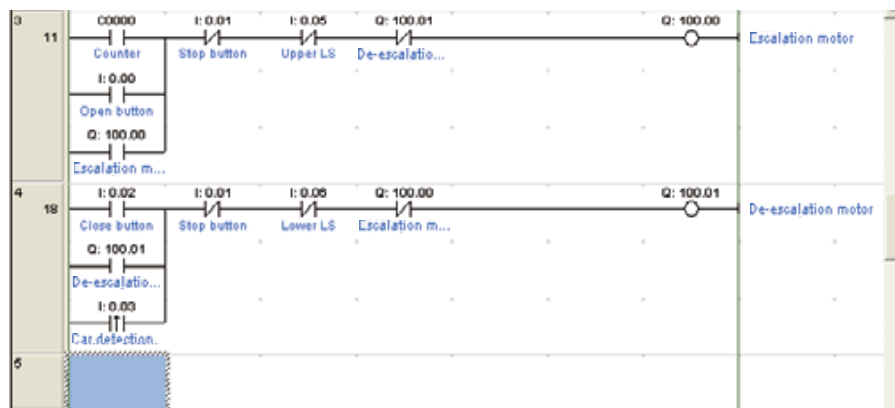

## 4-5-8 END Instruction

Ladder programs must be terminated with an END instruction.

When a new program is created in CX-Programmer, a section inclusive of an END instruction will be inserted automatically. Hence, there is no need to input an END instruction manually.

To confirm the ladder program containing only the END instruction, double-click the [END] section.

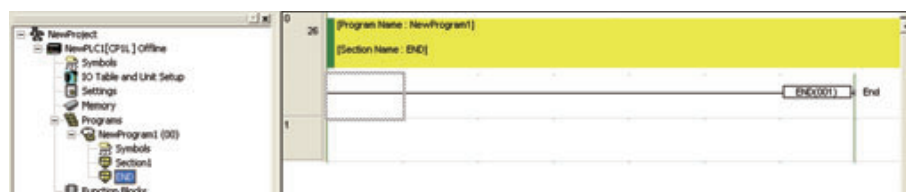

## 4-6 Saving/Loading Programs

Created ladder programs must be saved. This section explains how to check, save, and load ladder programs.

### 4-6-1 Compiling Programs

By compiling, you can check for errors in the program.

1. Select [PLC] - [Compile All PLC Programs] from the main menu.

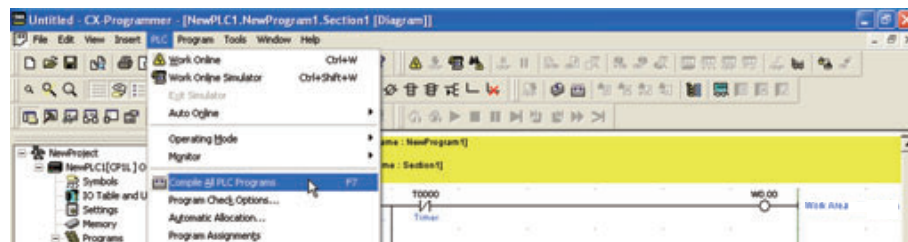

The compilation is started.

When the compilation is complete, program check results will be displayed in the output window.



2. If an error has been detected, double-click the error message in the output window.

The cursor is moved to where the error was detected. Correct the error.

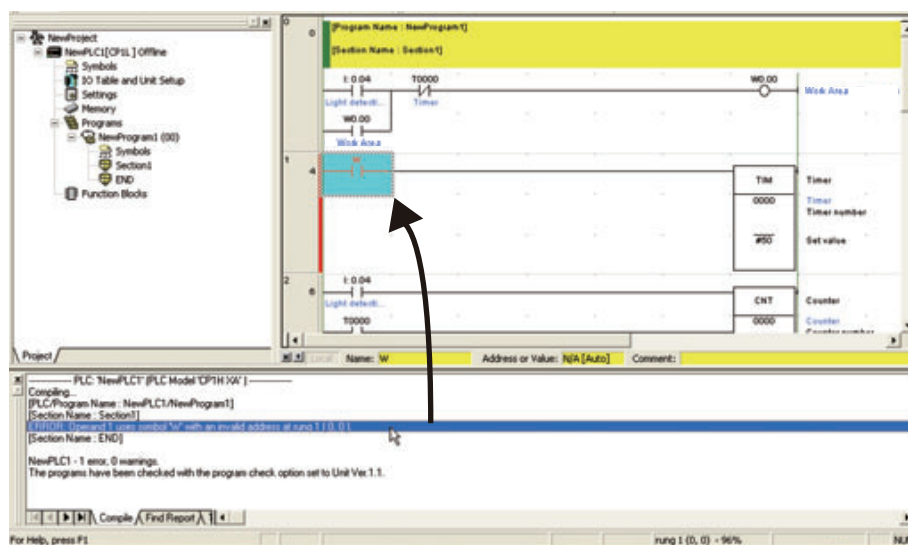

## 4-6-2 Saving Programs

Save the created ladder program. Programs are saved in groups for each project.

1. **Select [File] - [Save As] from the main menu.**

The Save CX-Programmer File dialog box will be displayed.

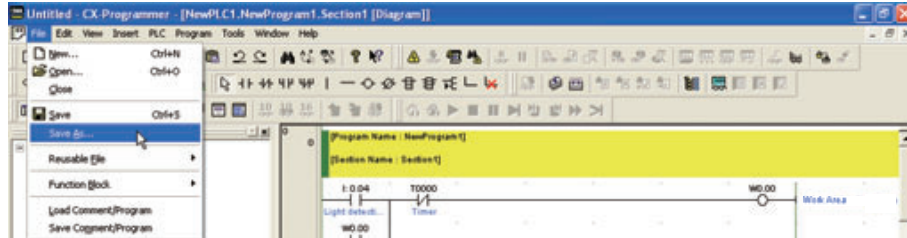

2. **Specify the save location, and input a file name. Click [Save].**

The CX-Programmer project file will be saved.

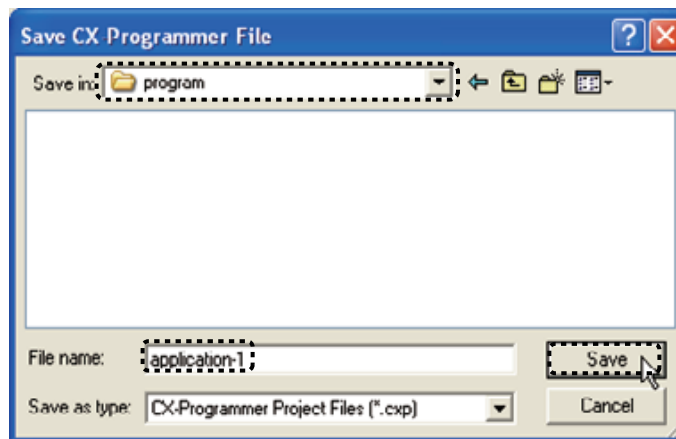



### 4-6-3 Loading Programs

Load a saved ladder program into CX-Programmer. Programs are loaded in groups for each project.

1. **Select [File] - [Open] from the main menu.**

The Open CX-Programmer Project dialog box will be displayed.

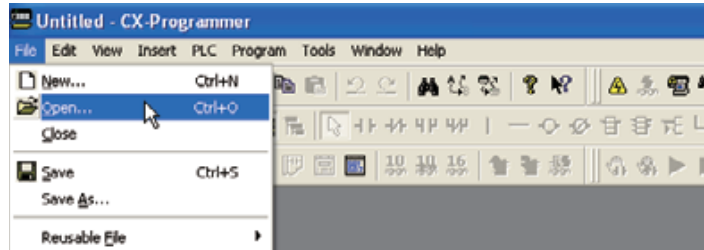

2. **Specify the save location and file. Click [Open].**

The CX-Programmer project file will be opened, and the saved programs will be displayed.

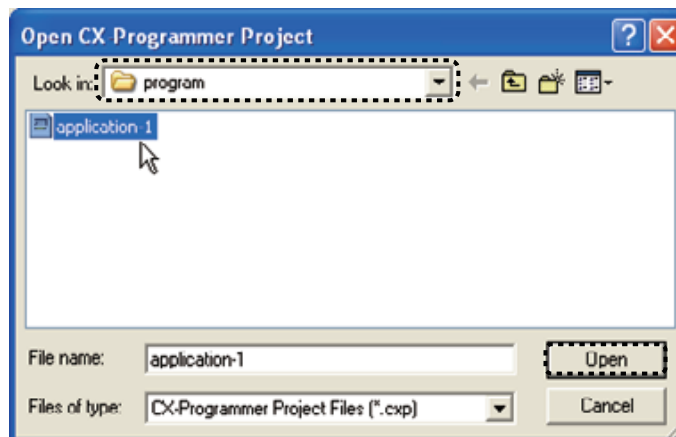

## 4-7 Editing Programs

Created ladder programs can be edited in CX-Programmer. I/O comments and rung comments can also be added or edited.

### 4-7-1 Editing I/O Comments

I/O comments can be added and edited via a list of addresses.

1. Select [Edit] - [I/O Comment] from the main menu.

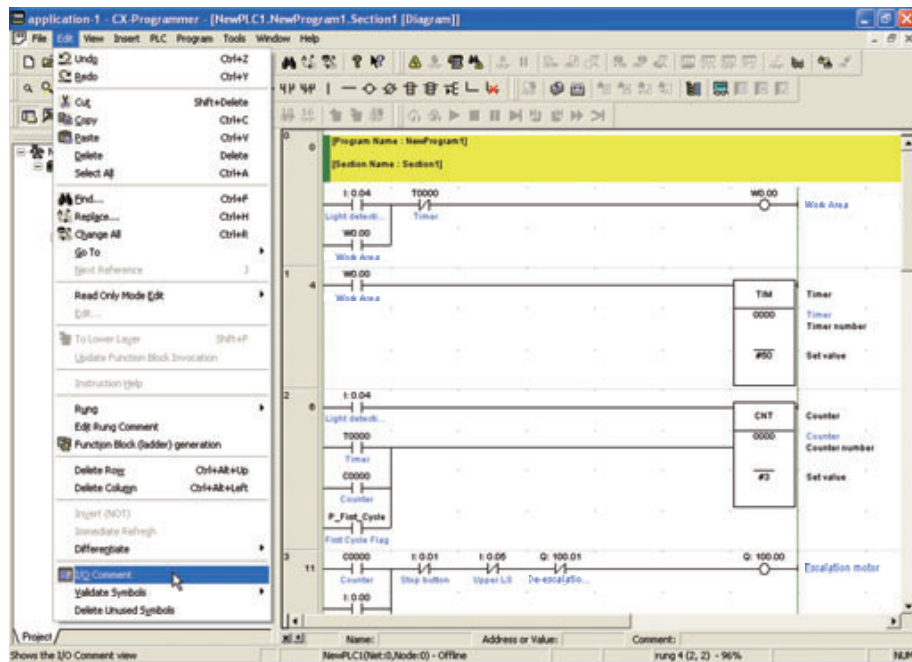

The I/O comment window will be displayed.

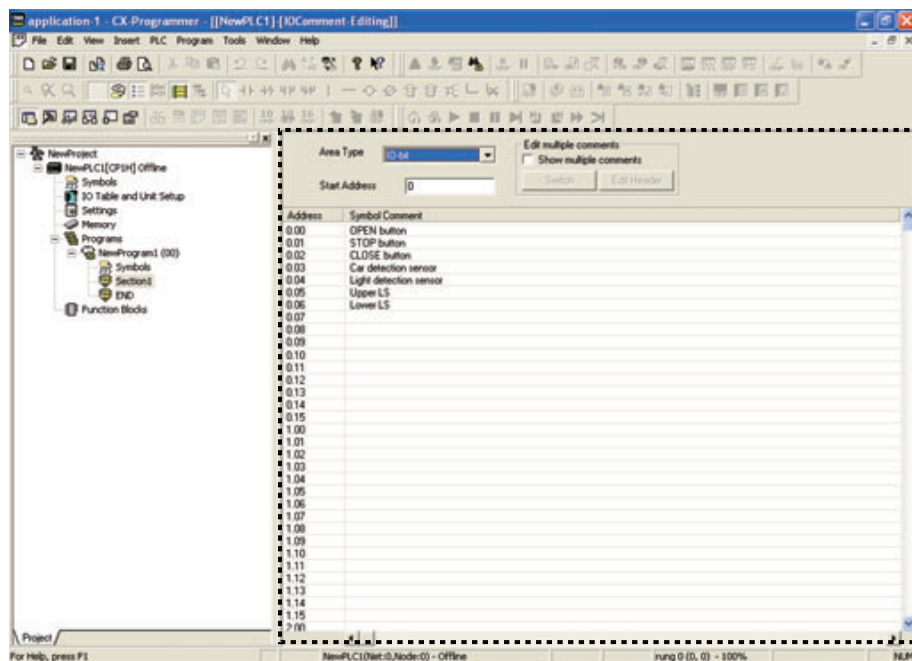

2. **Double-click the address for which you wish to input or edit the I/O comment.**

The I/O comment field will become editable. Input or edit the I/O comment.

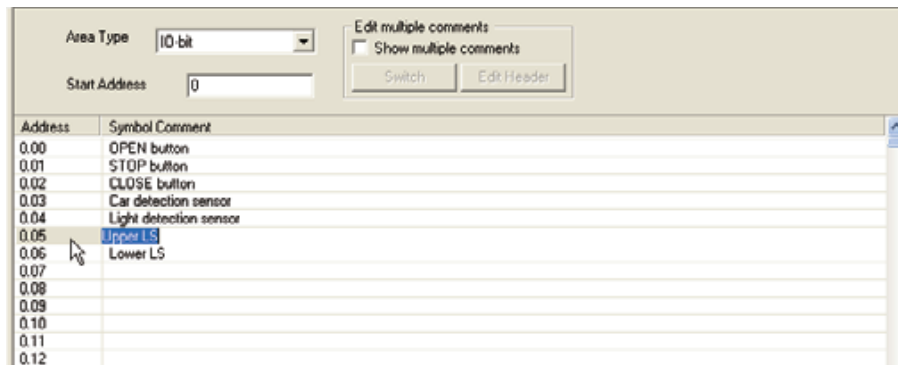

## 4-7-2 Inputting Rung Comments

Comments can be added to each rung of a ladder program.

1. **Double-click the rung header for the rung you wish to add a comment to.**  
The Rung Properties dialog box will be displayed.

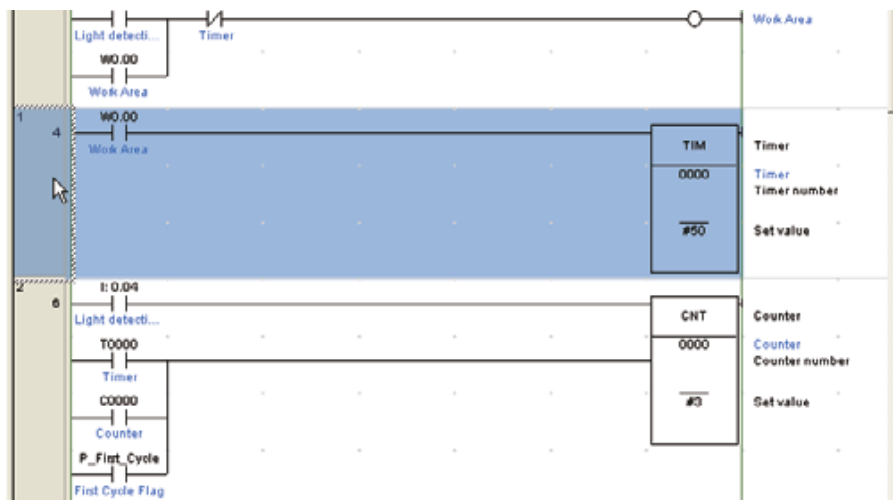

2. **On the General tab, input the comment into the comment field.**

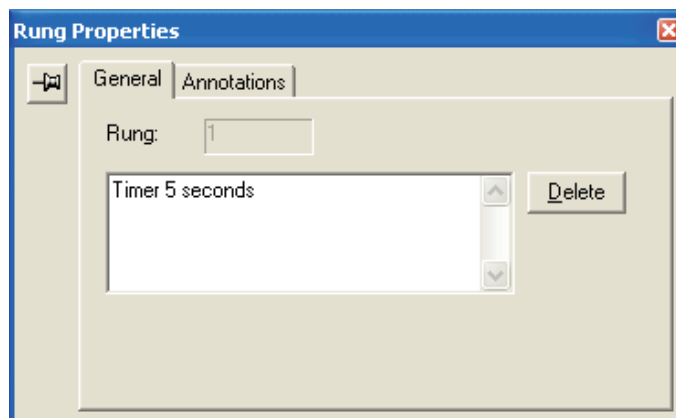

### 3. Close the Rung Properties dialog box.

The entered rung comment will be displayed on the ladder program.

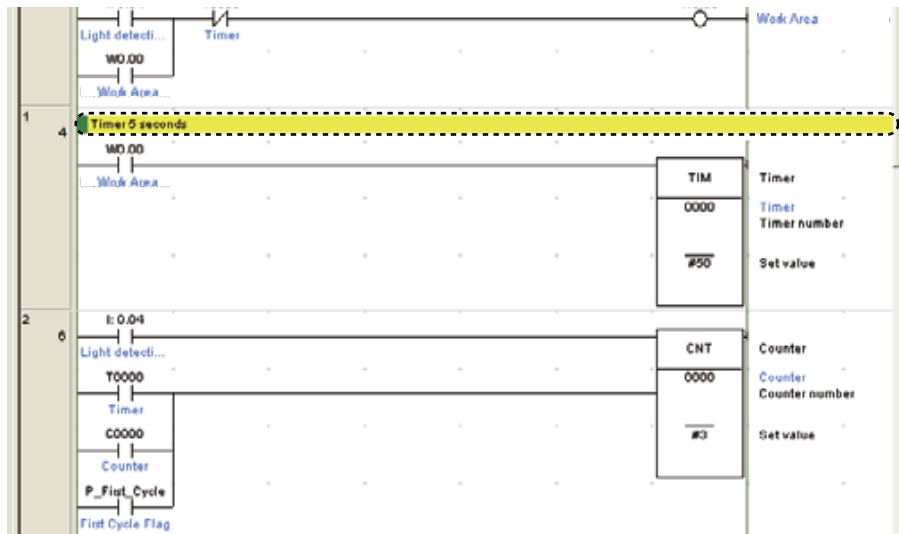

## 4-7-3 Editing Rungs

Created ladder programs can be edited.

### ■ Deleting

#### ● Contacts/Instructions

1. **Place the cursor on a contact or on an instruction. Press the [Delete] key.**  
The selected contact or instruction will be deleted.

#### ● Rungs

1. **Click a rung header.**  
The whole rung will be selected.

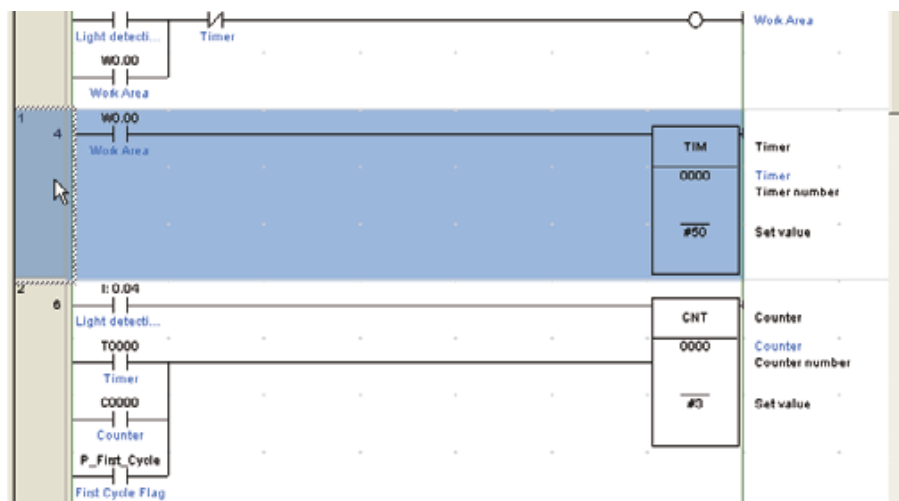

2. **Press the [Delete] key.**  
The selected rung will be deleted.

## ■ Creating Vertical/Horizontal Lines

Vertical and horizontal connection lines can be created.

Vertical lines are created as follows:

1. **Position the cursor at the starting point of the vertical line.**
2. **Hold down the [Ctrl] key, and press the up/down arrow key.**

Horizontal lines can be created in the same manner.

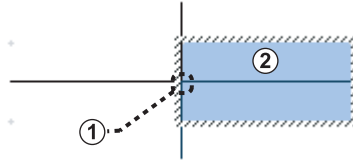

(1) Starting point

(2) Cursor

- Creating a line from right to left:  
Hold down the [Ctrl] key and press the left arrow key.
- Creating a line from left to right:  
Hold down the [Ctrl] key and press the right arrow key.
- Creating a line from bottom to top:  
Hold down the [Ctrl] key and press the up arrow key.
- Creating a line from top to bottom:  
Hold down the [Ctrl] key and press the down arrow key.

**Note** Repeating the process over an existing connection line will delete it.

## ■ Copying/Pasting Contacts/Instructions/Rungs

### ● Contacts/Instructions

1. **Place the cursor on a contact or an instruction.**
2. **Hold down the [Ctrl] key and press the [C] key.**  
The selected contact or instruction will be copied to the clipboard.
3. **Move the cursor to where you wish to paste. Hold down the [Ctrl] key and press the [V] key.**  
The contact or instruction on the clipboard will be pasted.

### ● Rungs

1. **Click the rung header of the rung you wish to copy.**  
The whole rung will be selected.
2. **Hold down the [Ctrl] key and press the [C] key.**  
The selected rung will be copied to the clipboard.
3. **Move the cursor to the rung where you wish to paste. Hold down the [Ctrl] key and press the [V] key.**  
The rung on the clipboard will be pasted.

# SECTION 5

## Transferring and Debugging Programs

To transfer data from a computer to CP1L, the computer and CP1L must first be online.

Monitoring and debugging programs executed on CP1L are also performed with the computer and CP1L online.

5-1	Going Online .....	78
5-1-1	Setting the CP1L Clock .....	79
5-1-2	Changing the Operating Mode .....	80
5-1-3	Transferring Programs .....	82
5-1-4	Executing Operations .....	84
5-2	Adjusting/Debugging Online .....	85
5-2-1	Monitoring .....	85
5-2-2	Force-Setting/Force-Resetting .....	88
5-2-3	Changing Timer Settings .....	90
5-2-4	Searching .....	90
5-2-5	Online Editing .....	93
5-2-6	Confirming Cycle Time .....	94

## 5-1 Going Online

To configure CP1L settings, transfer programs, or execute programs, the computer and CP1L must first be online.

1. In CX-Programmer, open the program to be transferred.
2. Select [PLC] - [Work Online] from the main menu.  
A dialog box will be displayed to confirm going online.

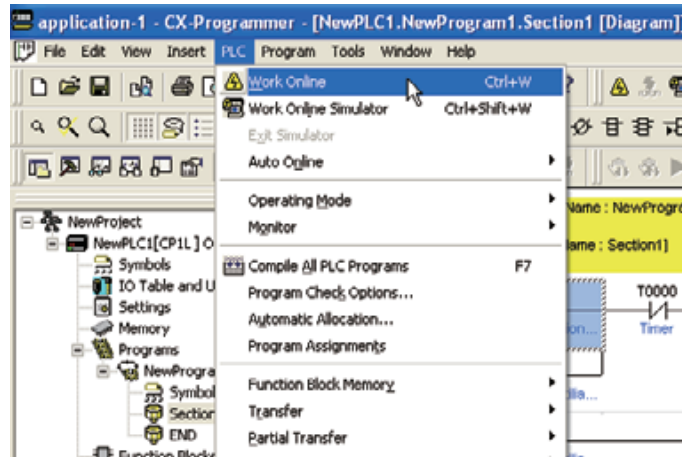

3. Click [Yes].  
The dialog box will be closed.

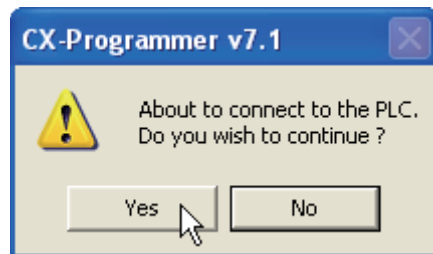

When the system goes online, the ladder section window will turn light grey.

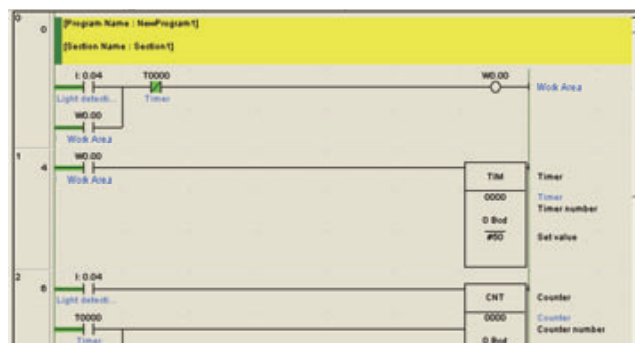

Online status is one in which the computer and CP1L are connected. To execute a program created with CX-Programmer on CP1L, the program will need to be transferred. For details on transferring programs, refer to 5-1-3 *Transferring Programs*.

**Note** If the system fails to go online, check the PLC type setting and communication settings.

To check the settings, double-click [NewPLC1[CP1L]Offline] in the project tree. For details on the settings, refer to 4-5-1 *Creating New Projects*.

## 5-1-1 Setting the CP1L Clock

The CP1L clock should be set to match your time zone. Use CX-Programmer to set the time. If the time on CP1L is not set properly, the error log will not be displayed correctly.

1. **In CX-Programmer, open an existing project.**  
For details on opening a project, refer to 4-6-3 *Loading Programs*.
2. **Double-click [PLC Clock].**  
The PLC Clock dialog box will be displayed.

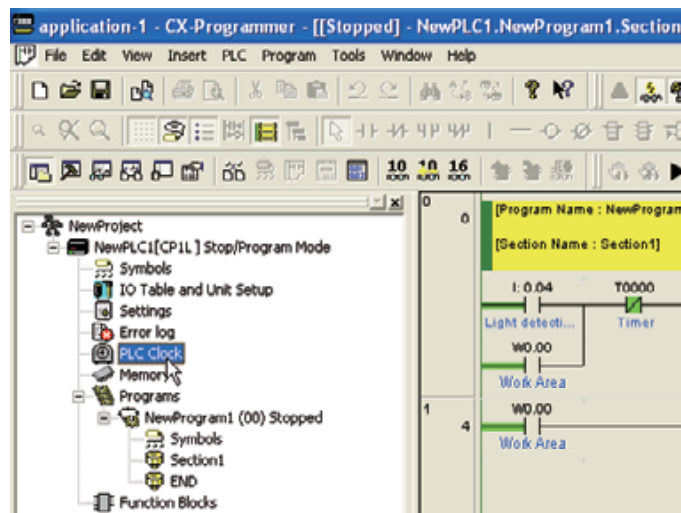

3. **Select [Options] - [Set PLC Clock] from the menu.**  
The Set PLC Clock dialog box will be displayed.

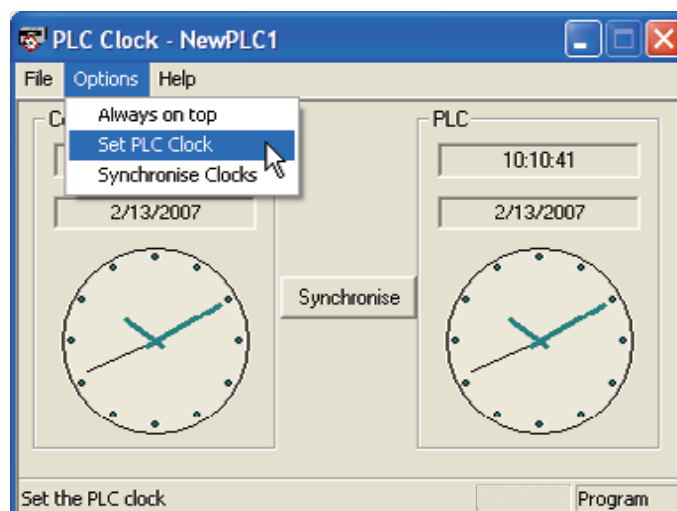



4. **Set the date and time. Click OK.**  
The Set PLC Clock dialog box will be closed.

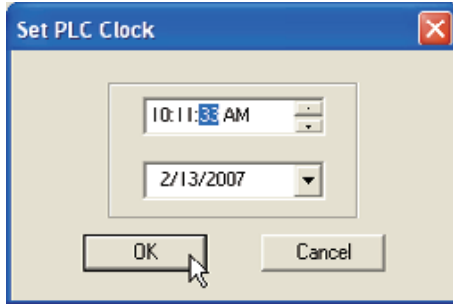

5. **Select [File] - [Exit] from the menu.**  
The clock on CP1L is now set.

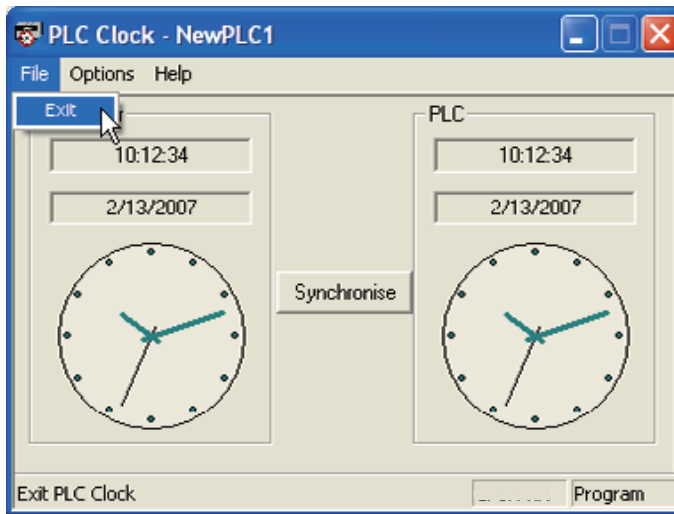

## 5-1-2 Changing the Operating Mode

Change to PROGRAM mode.

The procedure for changing to the PROGRAM operation mode is as follows.

1. **Select [PLC] - [Operating Mode] - [Program] from the main menu.**  
A dialog box will be displayed to confirm the operating mode change.

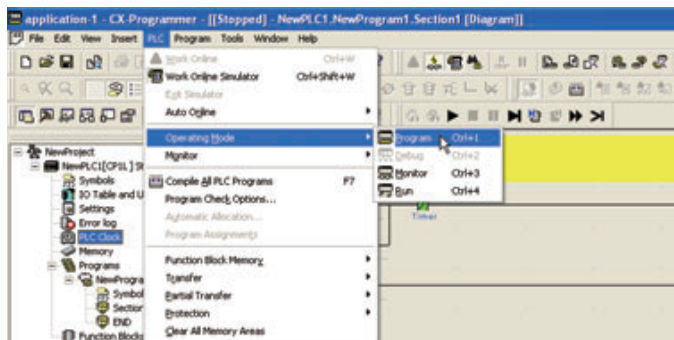

## 2. Click [Yes].

The operating mode will be changed.

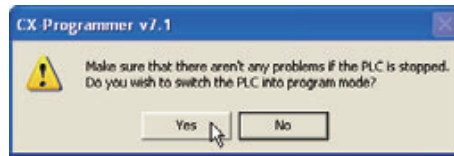

The operating mode will be displayed on the title bar and on the project tree.

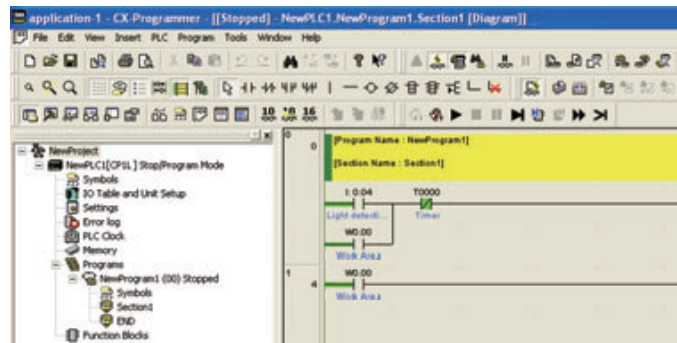

### ■ CP1L Operating Mode

CP1L has 3 operating modes: PROGRAM, MONITOR, and RUN. Change the operating mode to reflect the operation to be performed. The operation mode affects the whole user program, and is common to all tasks.

- **PROGRAM mode:**  
In this state, the program is stopped. This mode is used to prepare for program execution by performing initial settings such as PLC setup, transferring the program, checking the program, and force-setting/force-resetting.
- **MONITOR mode:**  
In this state, the program is executed. You can perform online editing, force-set/force-reset, and change I/O memory values. This mode is also used for making adjustments during test runs.
- **RUN mode:**  
In this state, the program is executed. Use this mode for production runs.

The following table lists the status and available operations for each mode.

Operating Mode		PROGRAM	RUN	MONITOR	
Program status		Stopped	Running	Running	
I/O refreshing		Execute	Execute	Execute	
External I/O status		OFF	Depends on program	Depends on program	
I/O memory	Non-holding memory	Cleared	Depends on program	Depends on program	
	Holding memory	Held			
Operations from CX-Programmer	I/O memory monitoring		OK	OK	
	Program monitoring		OK	OK	
	Program transfer	From PLC	OK	OK	OK
		To PLC	OK	X	X
	Compiling		OK	X	X
	PLC setup		OK	X	X
	Changing program		OK	X	OK
	Force-setting/Force-resetting		OK	X	OK
	Changing timer/counter SV		OK	X	OK
	Changing timer/counter PV		OK	X	OK
	Changing I/O memory PV		OK	X	OK

### 5-1-3 Transferring Programs

A program created with CX-Programmer can be transferred to CP1L.

1. **Select [PLC] - [Transfer] - [To PLC]** from the main menu. The Download Options dialog box will be displayed.

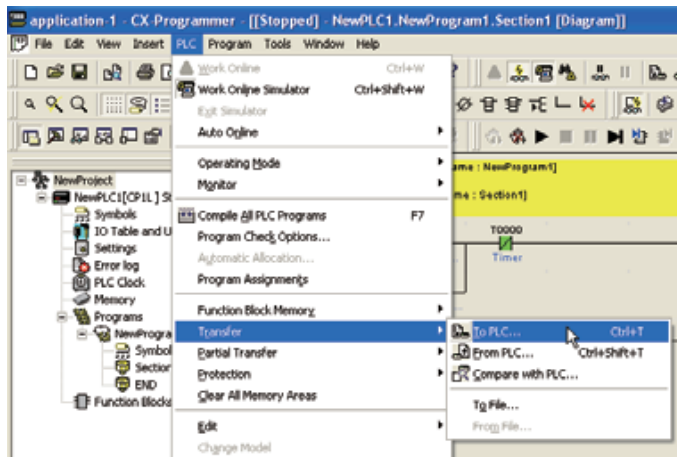

## 2. Click [OK].

A dialog box will be displayed to confirm the transfer.

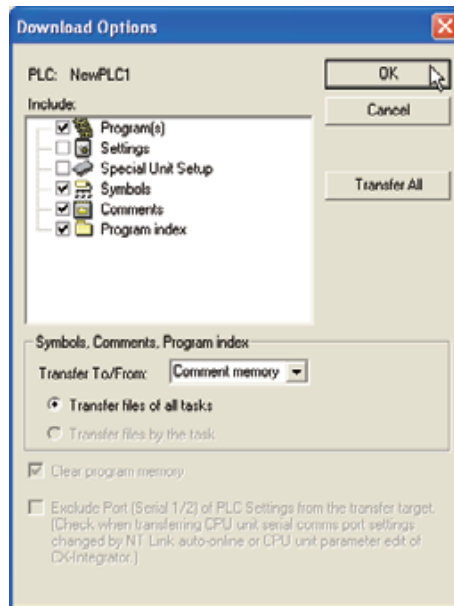

**Note** For details on the transfer options, refer to *SECTION 9 Transferring/Monitoring/Debugging Programs* of *CX-Programmer Operation Manual (W446)*.

## 3. Click [Yes].

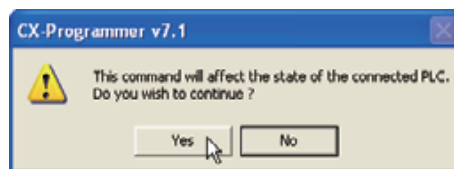

If the following dialog box is displayed, click [Yes].

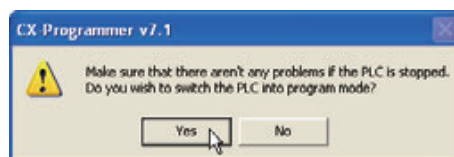

The transfer will begin. The Download dialog box will be displayed.

4. **Click [OK].**

Transferring of the program is now complete.

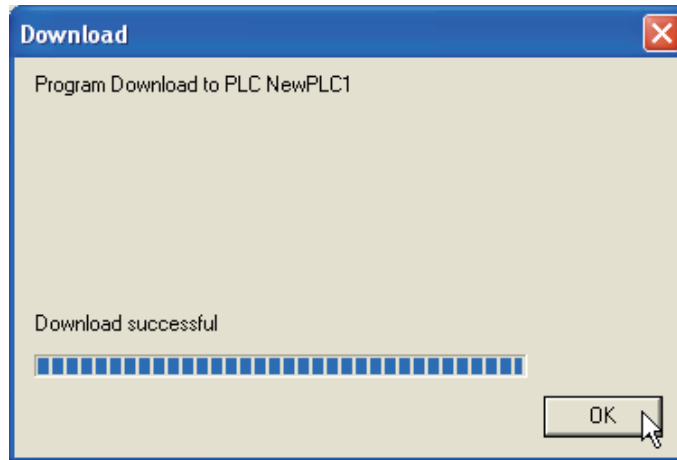

### 5-1-4 Executing Operations

To perform a production run, change to the RUN operating mode. The procedure for changing to RUN mode is described below.

To perform a trial run for adjustments and debugging, change to MONITOR mode.



**Caution** Confirm that the facility will not be affected by changing to MONITOR or RUN mode.

1. **Select [PLC] - [Operating Mode] - [Run] from the main menu.**

A dialog box will be displayed to confirm the operating mode change.

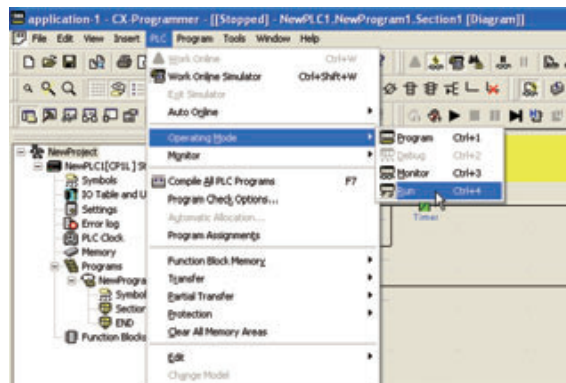
2. **Click [Yes].**

The system will change to RUN mode and begin operating.

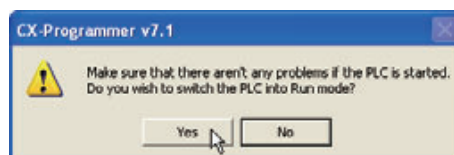

## 5-2 Adjusting/Debugging Online

This section explains functions used for debugging and for adjustments during test runs.

### 5-2-1 Monitoring

#### ■ Displaying Conduction Status

The conduction status of the program rungs will be displayed. This will allow you to confirm program execution.

1. **Change CP1L to the MONITOR operating mode.**
2. **Select [PLC] - [Monitor] - [Monitoring] from the main menu.**

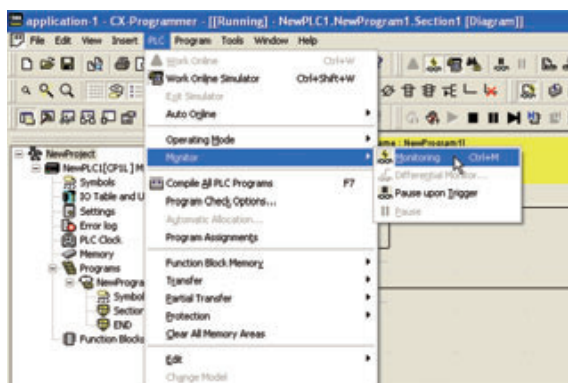

The conduction status is displayed on the program.

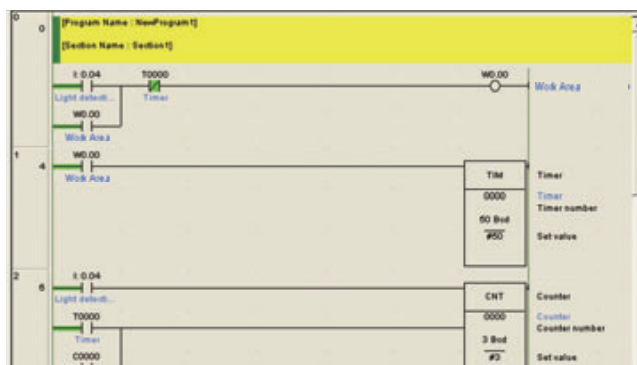

## ■ Displaying Conduction Status at Multiple Sections

The diagram workspace can be split. Multiple sections of the program can be viewed simultaneously.

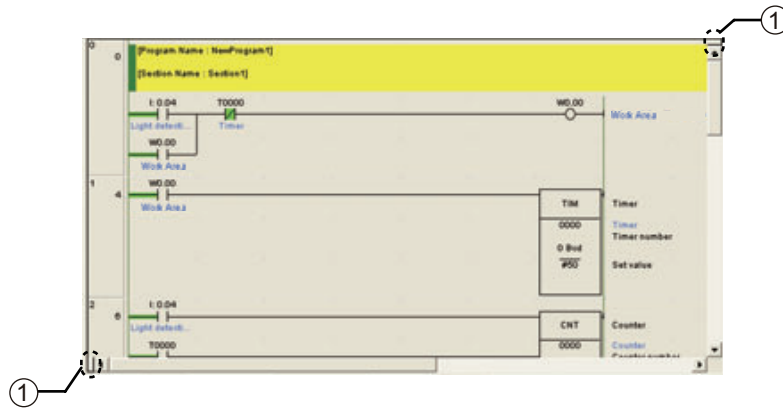

(1) Window divider

Drag the window divider to split the diagram workspace. The workspace can be split in up to 4 sections.



## ■ Monitoring Specific Addresses

I/O values can be monitored by specifying their address.

1. Select [PLC] - [Monitor] - [Monitoring] from the main menu.
2. Select [View] - [Windows] - [Watch] from the main menu.
3. Input an address.

The I/O value will be displayed. For Boolean values, "0" indicates OFF.

PLC Name	Name	Address	Data T...	FB Usage	Value	Value(0)	Comment
NewPLC1		0.04	BOOL (...)		0		Light d...
NewPLC1		0.05	BOOL (...)		0		Upper LS

- Note**
- Input the address as the channel followed by a period and the bit. For example, "0 CH 04 bit" should be input as "0.04".
  - You can input addresses by dragging & dropping items from the diagram workspace to the watch window. Select the rung header to input all addresses included in the rung.

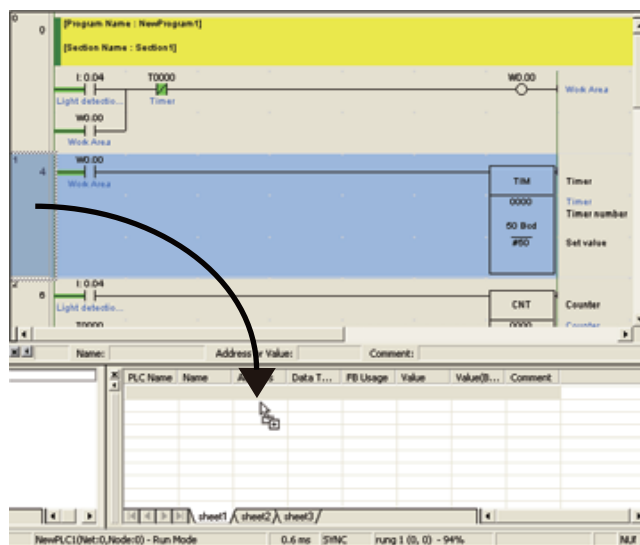



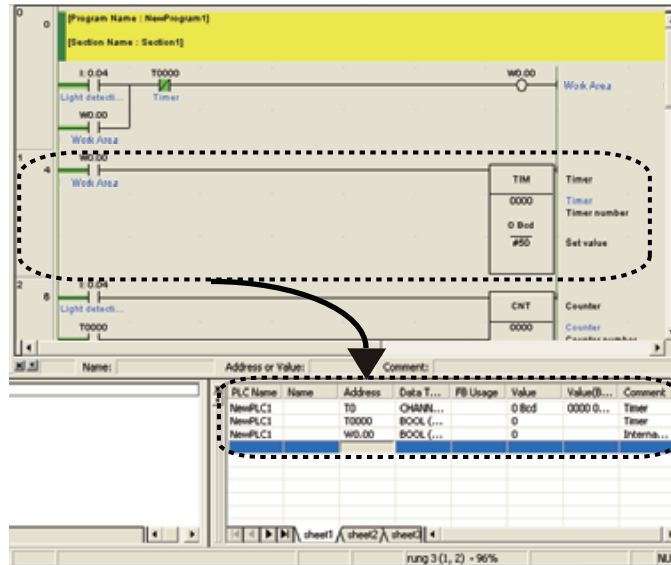

## 5-2-2 Force-Setting/Force-Resetting

CX-Programmer can control inputs, independent of inputs from I/O devices. Use this function to force input conditions and output conditions during test runs.

**Note** Before force-setting/force-resetting/releasing or setting/resetting, confirm that the facility will not be affected.

The force-setting procedure is as follows.

1. Change CP1L to the **MONITOR** or **PROGRAM** operating mode.
2. Place the cursor on the contact to force-set.



### 3. Select [PLC] - [Force] - [On] from the main menu.

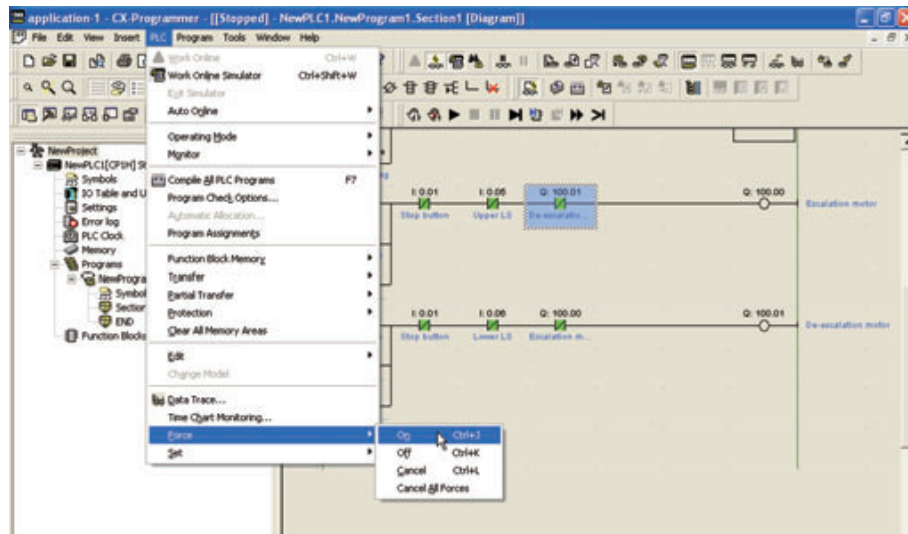

Force-set will be set. The contact will be marked with the force-set symbol.

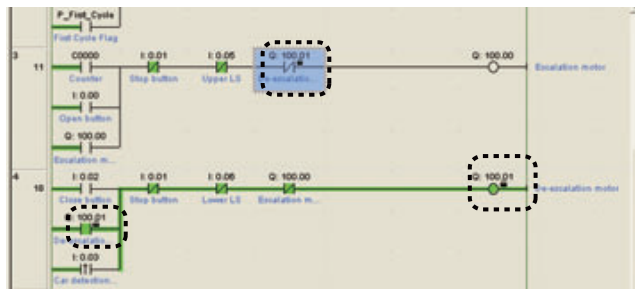

- Note**
- Select [On] to force the contact ON, and [Off] to force the contact OFF.
  - To undo the force-set/force-reset, select [Cancel].
  - The following areas can be force-set/force-reset:  
CIO area (I/O area, data link area, CPU bus unit area, special I/O area, and work area), work area (WR), timer completion flag, holding area (HR), counter completion flag

### 5-2-3 Changing Timer Settings

Timer settings can be changed to better suit operating conditions.

1. **Change CP1L to the MONITOR or PROGRAM operating mode.**
2. **Double-click the timer setting to be changed.**  
The Set Timer/Counter Value dialog box will be displayed.

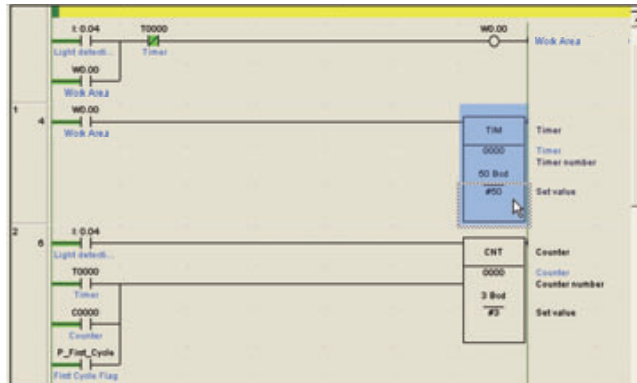

3. **Input the new value. Click [OK].**  
The timer setting will be updated.

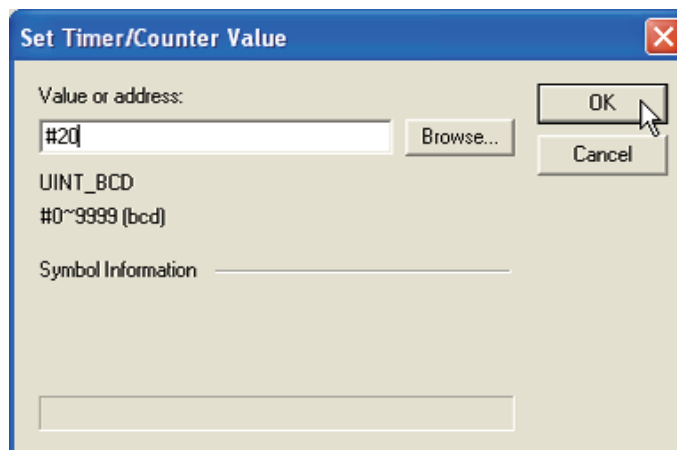

### 5-2-4 Searching

#### ■ Address Reference Tool

The address reference tool displays which instructions are using the address being pointed to with the cursor. It also allows jumping to another instruction with the same address.

The address reference tool will display the following items:

- Address at the cursor position
- Variables (local, global)
- Program name, section name
- Program address (step)
- Instruction using the address

1. Select [View] - [Windows] - [Address Reference Tool] from the main menu.

The address reference tool will be displayed.

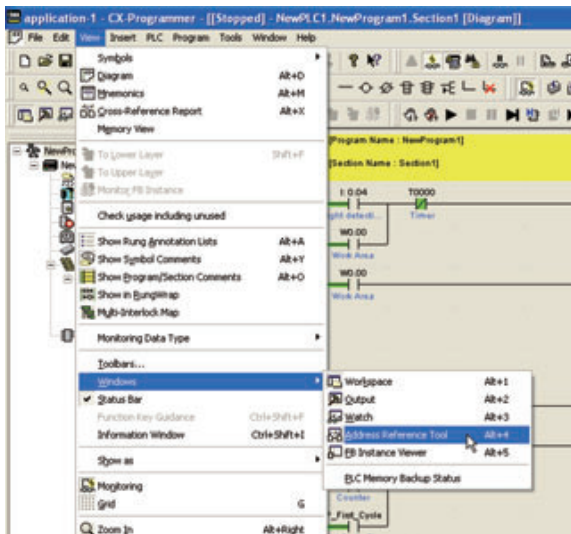

2. Input the address to search for. Click [Find].

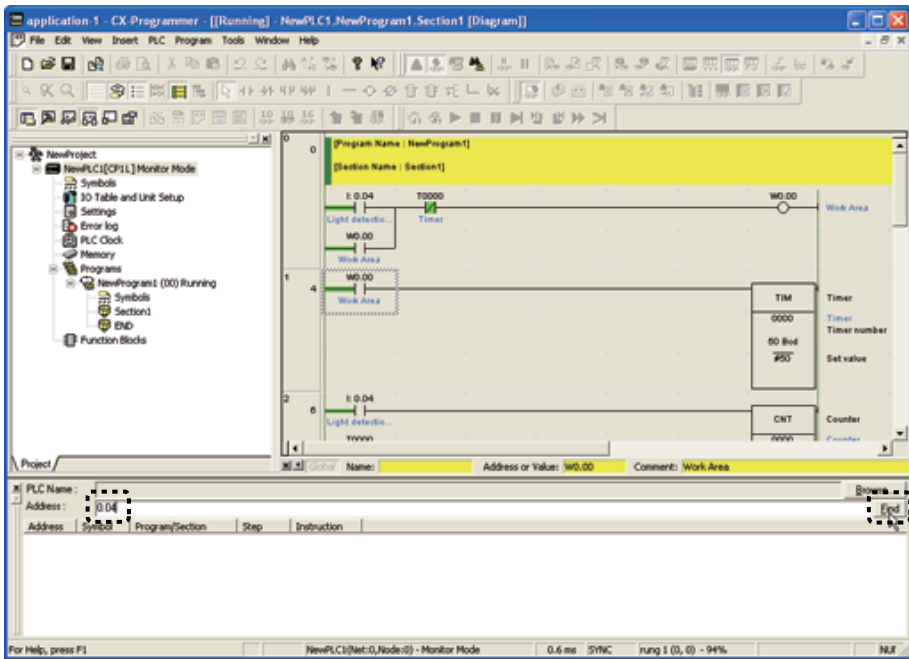

A list of used addresses will be displayed. Click an address to display the program being used.

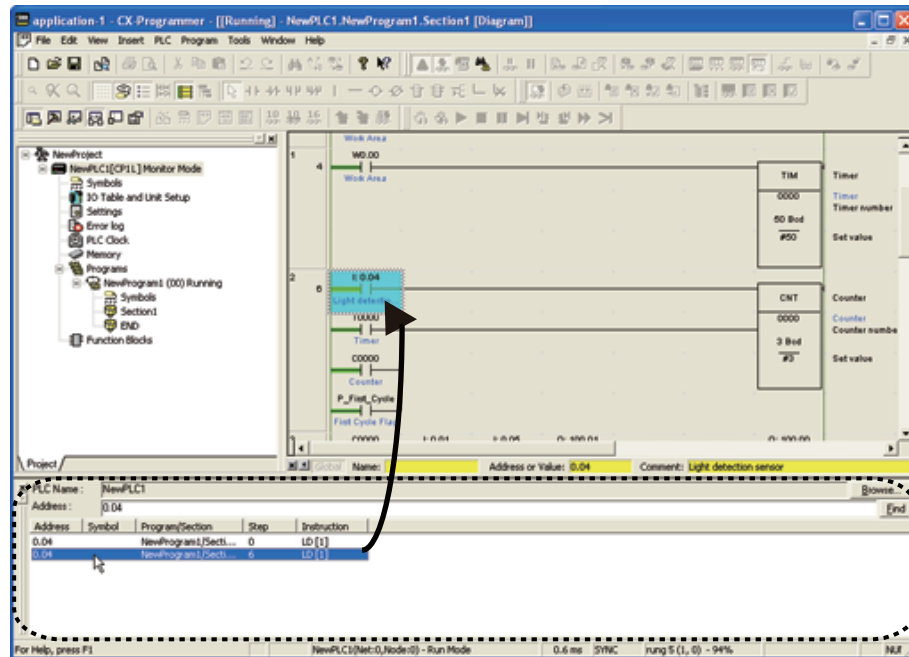

### ■ Ladder Backtracking

This function is used to backtrack the ladder, to determine why a contact does not turn ON, for example.

1. Place the cursor on the contact being investigated.



2. Press the [Space] key.

The cursor will be moved to the source output for the contact.

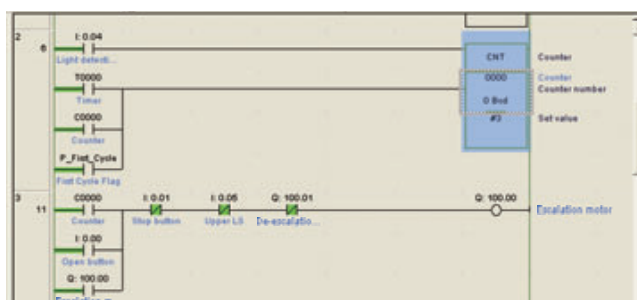

## 5-2-5 Online Editing

The CP1L program can be edited online.

**⚠ Caution** Before starting online editing, confirm that the extension of cycle time will have no adverse effects.

Otherwise, input signals may not be read.

- Note**
- Note that if CP1L is running in MONITOR mode, changing the program via editing online may cause the cycle time to become longer and/or failure to read input signals.
  - When making large changes, when moving or copying rungs, or when inserting or deleting block programs, edit offline, then transfer the program.

1. **Change CP1L to the MONITOR or PROGRAM operating mode.**

2. **Click the rung header of the rung you wish to edit.**

3. **Select [Program] - [Online Edit] - [Begin] from the main menu.**

The grey shading in the diagram workspace will disappear, and the program becomes editable.

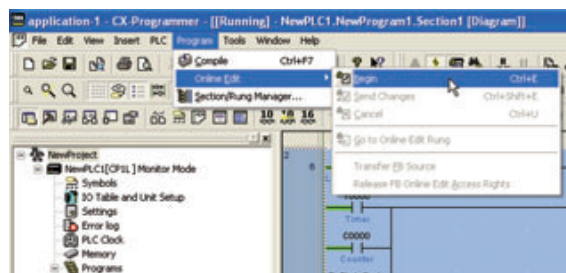

4. **Edit the program.**

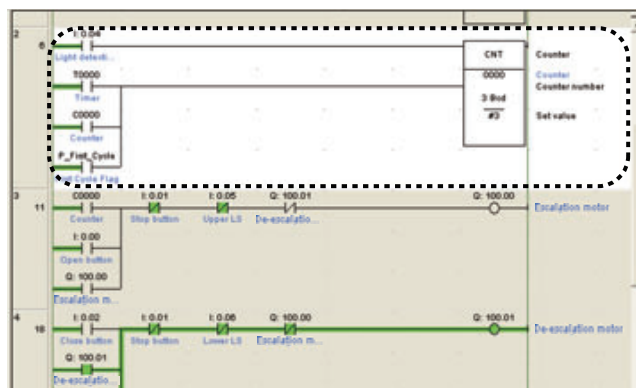

5. Select **[Program] - [Online Edit] - [Send Changes]** from the main menu. The edited rungs will be transferred to CP1L.

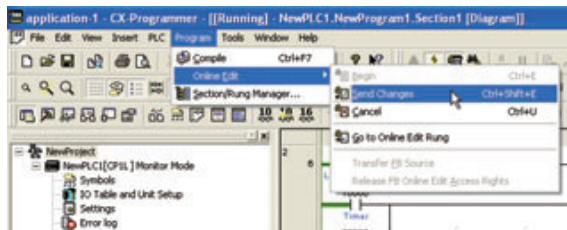

### 5-2-6 Confirming Cycle Time

1. Change CP1L to the **MONITOR** or **RUN** operating mode.
2. Click the diagram workspace. Cycle time will be displayed on the status bar.

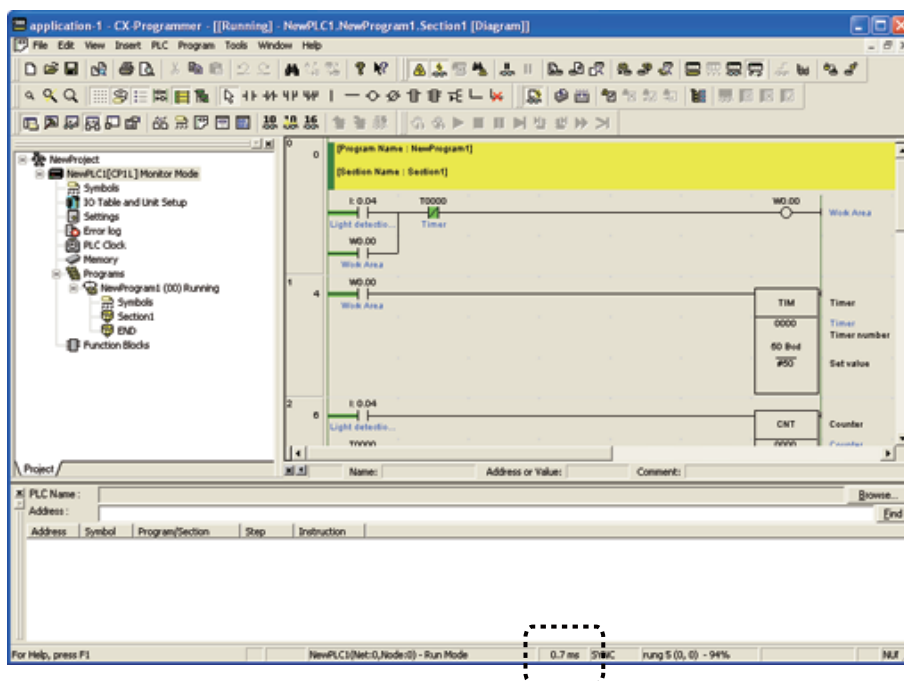

**Note** For details on cycle time, refer to *A-3-2 CPU Unit Behavior*.

# Appendix

This section briefly explains channel and relay numbers, instructions, and the inner workings of CP1L. This section also provides examples of applications utilizing CP1L functions such as pulse functions, communication functions, and special instructions.

A-1	Channel/Relay Numbers .....	96
A-2	Instructions .....	101
A-2-1	Using Instructions .....	101
A-2-2	Basic I/O Processing Instructions .....	102
A-3	Inner Workings of CP1L .....	105
A-3-1	Inner Structure of CPU Units .....	105
A-3-2	CPU Unit Behavior .....	107
A-4	CP1L Programming Examples .....	114
A-4-1	Using Adjusters to Set Timers .....	114
A-4-2	Capturing Short Signals .....	117
A-4-3	Using Interrupt Inputs to Accelerate Processes .....	121
A-4-4	Using Calendar Timers .....	127
A-4-5	Using Rotary Encoders to Measure Positions .....	132
A-4-6	Using Servo Drivers for Positioning .....	137
A-4-7	Using Inverters for Speed Control (1) .....	143
A-4-8	Using Inverters for Speed Control (2) .....	150
A-4-9	Exchanging Data between CP1Ls .....	160



## A-1 Channel/Relay Numbers

In CP1L, channel (CH) numbers and relay numbers are specified as described below.

Each channel consists of 16 bits.

Hence, relay numbers are expressed as [channel number] + [bit number (00 to 15)].

Relay numbers are used to handle contacts. Channel numbers are mainly used as operands for special instructions when processing data by the channel.

**Note** In CX-Programmer (abbreviated as CX-P below), upper bits of channel numbers and relay numbers are not displayed if their value is 0. For example, 0000CH will be displayed as 0.

Relay numbers are displayed as a channel number followed by a period and a bit number. The bit number ranges in value from 00 to 15.

A

Appendix

Area		Channel	Relay		
			In CX-P		In CX-P
CIO area	I/O area	00 to 199	0 to 199	00000 to 19915	0.00 to 199.15
	1:1 link area	3000 to 3063 CH	3000 to 3063	300000 to 306300	3000.00 to 3063.00
	Serial PLC link area	3100 to 3189 CH	3100 to 3189	310000 to 318915	3100.00 to 3189.15
	Work area	3800 to 6143 CH	3800 to 6143	380000 to 614300	3800.00 to 6143.00
Work area		W000 to W511 CH	W000 to W511	W00000 to W51115	W0.00 to W511.15
Holding area		H000 to H511 CH	H000 to H511	H00000 to H51115	H0.00 to H511.15
Auxiliary area		A000 to A959 CH	A000 to A959	A00000 to A95915	A0.00 to A959.15
DM area		D00000 to D32767*	D0 to D32767*	-	-
Timer		T000 to T511	T0 to T511	T000 to T511	T0000 to T0511
Counter		C000 to C511	C000 to C511	C000 to C511	C0000 to C0511

\*For 14/20-point I/O units: D0 to D9999, D32000 to D32767.

**Note** The work words in CIO Area may be assigned to new functions in future versions of the CPU Units. Be sure to use the work words in W000 to W511CH first.

●Channel Data Notation

Channel data is represented by 4 hexadecimal digits, derived from 16 binary digits, representing the ON/OFF state of the 16 bits.

In other words, for each 4 bits, the sum of ON bits are calculated and expressed as a single digit.

	MSB (Most Significant Bit)								LSB (Least Significant Bit)							
Bit	15	14	13	12	11	10	09	08	07	06	05	04	03	02	01	00
Bit value	2 <sup>3</sup>	2 <sup>2</sup>	2 <sup>1</sup>	2 <sup>0</sup>	2 <sup>3</sup>	2 <sup>2</sup>	2 <sup>1</sup>	2 <sup>0</sup>	2 <sup>3</sup>	2 <sup>2</sup>	2 <sup>1</sup>	2 <sup>0</sup>	2 <sup>3</sup>	2 <sup>2</sup>	2 <sup>1</sup>	2 <sup>0</sup>
Content (1=ON, 0=OFF)	0	0	0	0	1	1	1	1	0	1	1	1	1	1	0	0
Digit value	0				F				7				C			

The above channel will be expressed as "0F7C (Hex)".

●Constants Notation

Constants used in CP1L instructions are represented as follows.

Notation	Content/Purpose
#0000 to 9999 (BCD)	Timer/counter values, BCD arithmetic instruction, etc.
#0000 to FFFF (Hex)	Comparison data for comparison instructions, transfer data, BIN arithmetic instructions, etc.
&0 to 65535	Unsigned decimal notation (Available in certain special instructions only. Can be loaded into CX-Programmer by converting to and from hex digits.)

●Instruction Execution Conditions

There are 2 types of instructions: cyclic instructions, and differentiated instructions.

• Cyclic Instructions

The instruction is executed on each cycle, for as long as the execution condition is ON.

Example

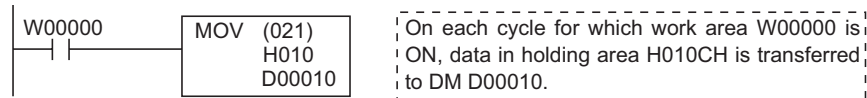

• Differentiated Instructions

The instruction is executed only once (i.e. on 1 cycle only) when the execution condition turns ON.

The instruction name is prefixed with an "@".

Example

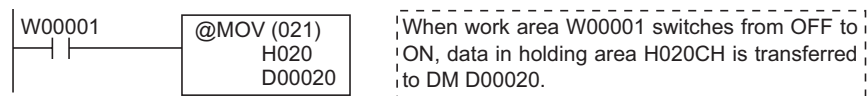

Some instructions cannot be specified as a differentiated instruction (with the "@" prefix). If such is the case, use the UP(521)/DOWN(522) or DIFU(013)(differentiated UP)/DIFD(014)(differentiated DOWN) instructions.

## ●Condition Flags

Condition flags are used to reflect the processing results during or after the execution of instructions. Whether a flag is used or not will depend on the instruction. These flags are used in ladder programs as contacts.

Name	Label	In CX-P	Function
Error flag	ER	P_ER	<ul style="list-style-type: none"> <li>• Turns ON when an instruction handling BCD data attempts to execute using non-BCD data.</li> <li>• Turns ON when an operand value specified by the instruction is invalid (e.g. a value outside the work area).</li> </ul>
Access error flag	AER	P_AER	Turns ON when unauthorized access is attempted on an area that is not meant to be accessed.
Carry flag	CY	P_CY	<ul style="list-style-type: none"> <li>• Turns ON when the number of digits is increased or decreased as a result of executing an arithmetical instruction.</li> <li>• Data shift instructions and some arithmetical instructions may handle the carry as part of their processing.</li> </ul>
Equals flag	=	P_EQ	<ul style="list-style-type: none"> <li>• Turns ON when data comparison returns an "equal".</li> <li>• Turns ON when data becomes 0 as a result of calculations or transfers.</li> </ul>
Unequal flag	< >	P_NE	Turns ON when data comparison returns an "unequal".
Greater than flag	>	P_GT	Turns ON when data comparison returns "data1>data2".
Greater than or equals flag	>=	P_GE	Turns ON when data comparison returns "data1>=data2".
Less than flag	<	P_LT	Turns ON when data comparison returns "data1<data2".
Less than or equals flag	<=	P_LE	Turns ON when data comparison returns "data1<=data2".
Negative flag	N	P_N	Turns ON when the MSB becomes 1 as a result of calculations.
Overflow flag	OF	P_OF	Turns ON when the calculation result overflows.
Underflow flag	UF	P_UF	Turns ON when the calculation result underflows.
Always ON flag	ON	P_ON	Remains ON at all times. Used as an execution condition for instructions that cannot be connected directly to the bus bar.
Always OFF flag	OFF	P_OFF	Remains OFF at all times.

## ●Clock Pulses

Clock pulses are contacts that turn ON/OFF at a fixed time interval.

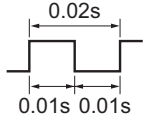
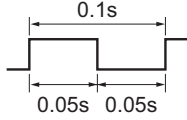
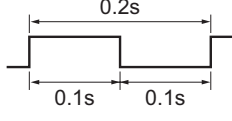
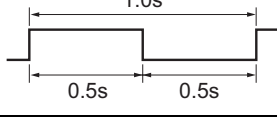
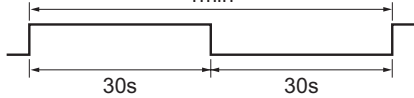
Name	Label	In CX-P	Function
0.02s clock pulse	0.02s	P_0.02s	
0.1s clock pulse	0.1s	P_0.1s	
0.2s clock pulse	0.2s	P_0.2s	
1.0s clock pulse	1s	P_1s	
1min clock pulse	1min	P_1min	

**Note** To enter a clock pulse or condition flag into CX-Programmer, first enter a contact, then press the [P] key to select from the drop-down list.

## ● I/O Areas

Input area	0.00 to 99.15 (100 CHs)
Output area	100.00 to 199.15 (100 CHs)

With CP1L, the first 1 or 2 channel(s) of the input and output areas, starting at 0CH and 100CH, respectively, are reserved by the CPU unit.

As expansion I/O units and expansion units are connected to the CPU unit, input and output areas are assigned 1 channel at a time, in the order of connection.

### • Number of Reserved Channels and Expansion (I/O) Units

CPU unit	Reserved CH		Number of Expansion (I/O) Units Allowed
	Input area	Output area	
10-point I/O unit	0 CH	100 CH	0
14-point I/O unit	0 CH	100 CH	1
20-point I/O unit	0 CH	100 CH	1
30-point I/O unit	0 CH, 1 CH	100 CH, 101 CH	3
40-point I/O unit	0 CH, 1 CH	100 CH, 101 CH	3
60-point I/O unit	0 CH, 1 CH, 2 CH	100 CH, 101 CH, 102 CH	3

For example, when using a 40-point I/O unit, input areas 0CH and 1CH, and output areas 100CH and 101CH are assigned to the internal I/O of the CPU unit.

If expansion (I/O) units are connected to the CPU unit, input areas 2CH and later, and output areas 102CH and later, will be assigned in order.

When the CPU unit is powered ON, input and output channels are automatically allocated to the input and output areas of the expansion (I/O) units after the connections are checked.

Changes to the connection order of the units will result in inconsistencies with the ladder program. Be sure to review the ladder program when changing the unit connection order.

## A-2 Instructions

---

---

CP1L has a rich instruction set. This section explains how to use the instructions, and gives some basic instructions.

### A-2-1 Using Instructions

With previous PLCs, from C-series to micro PLCs, instruction sets were designed with the primary focus on handling BCD data. However, as data size grow and exchange of data between computers becomes more commonplace, however, support for BIN data has become a necessity for control equipment, as well. In response to such needs and for greater convenience, many of the instructions for handling BIN data have been added in the process of creating the CP-series.

**Note** For a list and explanation of the instructions, refer to the CX-Programmer Help. For details on using the CX-Programmer Help, refer to *4-4 Using the Help*.

#### ■ Notation for Instructions

##### ● Instructions and Function Numbers

In this section, special instructions, which have a function number assigned are displayed as a mnemonic followed by a 3-digit function number in parenthesis. E.g. MOV(021).

## A-2-2 Basic I/O Processing Instructions

Basic I/O processing instructions are used for writing to contacts and coils.

	Instruction Name	Instruction	Function
Contact	LOAD	LD	Used for contacts connected to the bus bar or to the beginning of a rung block.
	LOAD NOT	LD NOT	Used for closed contacts connected to the bus bar or to the beginning of a rung block.
	AND	AND	Used for contacts connected in series.
	AND NOT	AND NOT	Used for closed contacts connected in series.
	OR	OR	Used for contacts connected in parallel.
	OR NOT	OR NOT	Used for closed contacts connected in parallel.
Coil (Output)	OUT	OUT	Turns relay coil ON when execution condition is 1, and OFF when execution condition is 0.
	OUT NOT	OUT NOT	Turns relay coil OFF when execution condition is 1, and ON when execution condition is 0.
	SET	SET	Turns relay coil ON when execution condition changes from OFF to ON. The relay coil will remain ON even when the execution condition changes back to OFF.
	RSET	RSET	Turns relay coil OFF when execution condition changes from OFF to ON. The relay coil will remain OFF even when the execution condition changes back to OFF.
	KEEP RELAY	KEEP(011)	Makes the specified relay function as a keep relay.

**Note** When programming in CX-Programmer, there is no need to think of contacts and coils (OUTs) as instructions. They can be written into the program by simply selecting the corresponding symbols.

### ■ Writing Contacts

#### ● LD (LOAD) / LD NOT (LOAD NOT) Instructions

Use at the bus bar or at the beginning of a rung block.

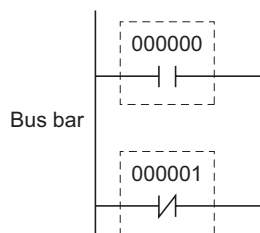

### ●AND / AND NOT Instructions

Use for contacts connected in series.

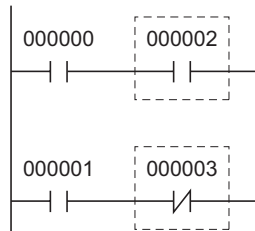

**Note** There is no limit on the number of contacts that can be connected by AND/AND NOT instructions.

### ●OR / OR NOT Instructions

Use for contacts connected in parallel.

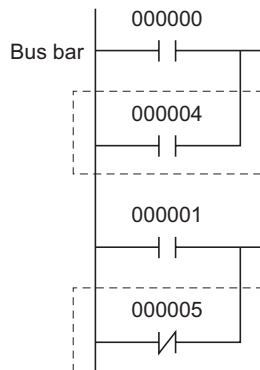

**Note** There is no limit on the number of contacts that can be connected by OR/OR NOT instructions.

## ■ Writing Relay Coils

### ●OUT / OUT NOT Instructions

OUT instructions turn a relay coil ON when the execution condition is ON. OUT NOT instructions turn a relay coil OFF when the execution condition is ON.

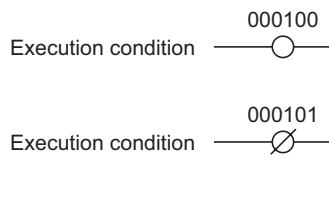

**Note** Do not use coils with the same relay number for OUT and OUT NOT simultaneously. Doing so will result in a "duplicated coil" program error.



●SET / RSET (RESET) Instructions

SET instructions turn and keep a relay coil ON once the input condition is ON.

RSET instructions turn and keep a relay coil OFF.

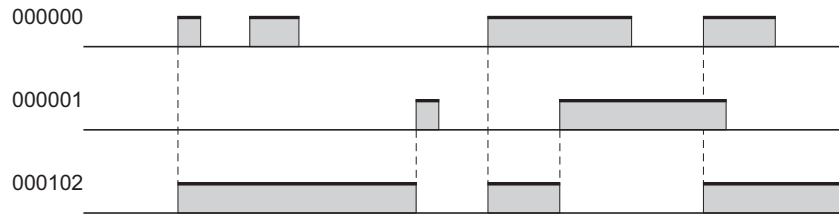
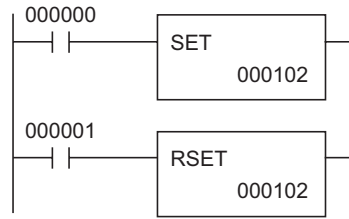

In the above example, relay coil 000102 is turned ON by the SET condition and OFF by the RSET condition.

**Note** Holding areas and auxiliary areas turned ON by SET instructions will retain the ON status even when power is interrupted or when operation is stopped.

●KEEP(011) (KEEP RELAY) Instructions

KEEP instructions make relay coils function as keep relays. This allows for easy construction of self-maintaining bits.

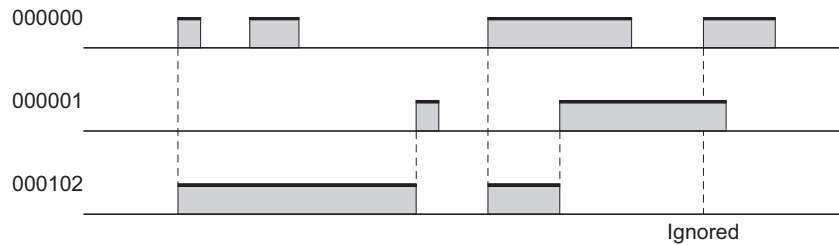
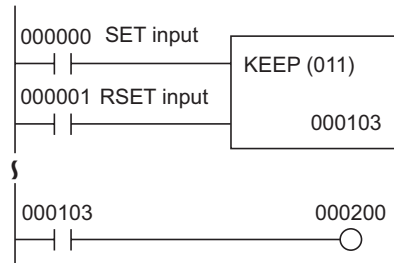

In the above example, relay coil 000103 is turned ON by the set condition and OFF by the reset condition. While the reset input is ON, the set input will be ignored.

**Note** Holding areas and auxiliary areas turned ON by KEEP instructions will retain the ON status even when power is interrupted or when operation is stopped.

## A-3 Inner Workings of CP1L

This section briefly explains the inner structure, functions, and internal operation flow of CP1L CPU units.

### A-3-1 Inner Structure of CPU Units

The inner structure of a CP1L CPU unit is shown below.

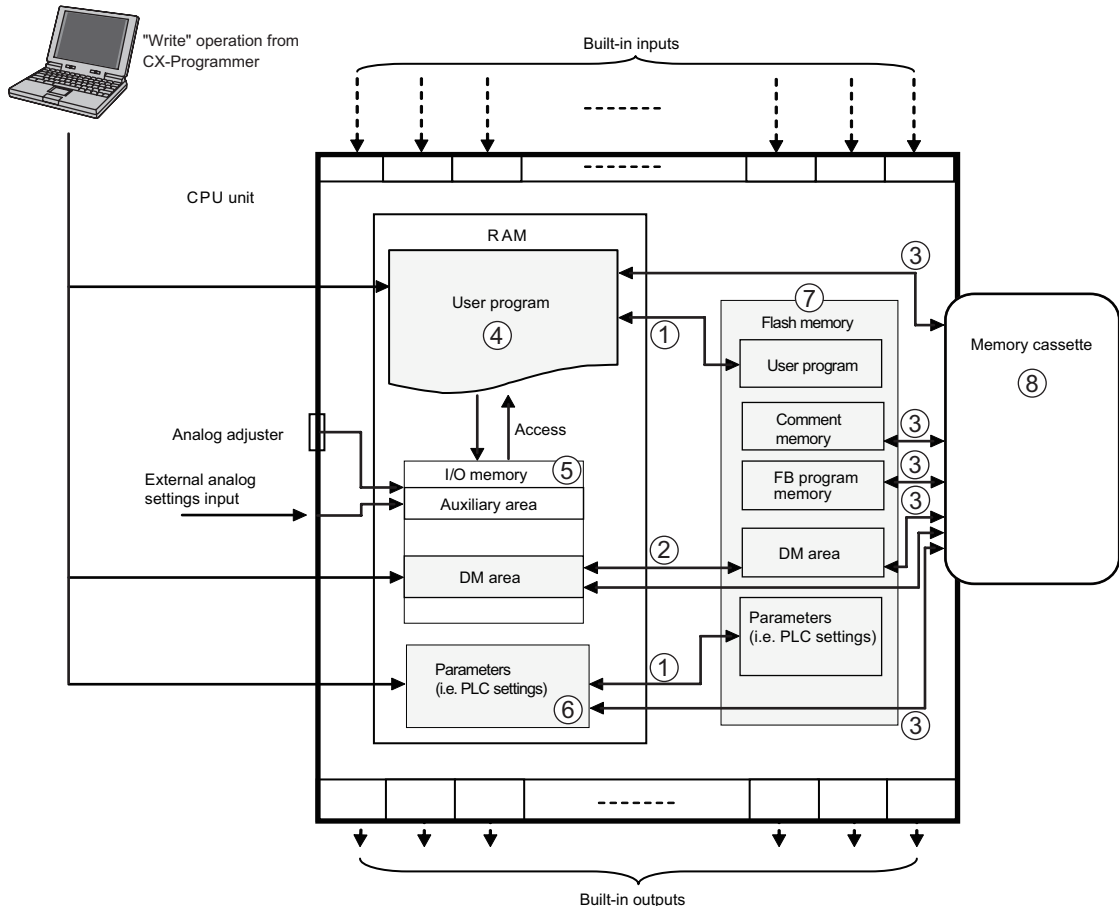

- (1) Transfer of programs and parameter data
  - Data in RAM is automatically backed up to the built-in flash memory when changes are made, for example, from the CX-Programmer.
  - When the unit is powered ON, data is transferred from the built-in flash memory to RAM.
- (2) Transfer of DM defaults data
  - When initiated from CX-Programmer, DM defaults are transferred from RAM to the built-in flash memory.
  - According to PLC setup, DM defaults are transferred from the built-in flash memory to RAM when the unit is powered ON.
- (3) Transfer of data between flash memory and memory cassette
  - When initiated from CX-Programmer, data is transferred from RAM or the built-in flash memory to the memory cassette.
  - When the unit is powered ON, data is transferred from the memory cassette to the built-in flash memory.

- (4) User program
  - The ladder program is stored in this memory (RAM) area. The ladder program can be saved, edited, or opened from CX-Programmer.
- (5) I/O memory
  - This is the memory (RAM) area the user program writes to and reads from. Some parts of the I/O memory are cleared when the power is interrupted. Other parts are maintained. There are also parts, which are used for data exchange with PLC units, and other parts, which are only used internally.
  - There are 2 ways to exchange data with other units: once each execution cycles, or only when instructed.
- (6) Parameter areas
  - In addition to I/O memory area, which is used as instruction operands by the user, there is also a separate memory area that can be manipulated only from CX-Programmer. This is the “parameter area”. The parameter area stores PLC setup data.

[PLC Setup]

PLC setup is the configuration data used by the user to provide a software definition of the basic specifications of the CPU unit. These consist of parameters such as serial port settings and minimum cycle time settings. For details on configuring PLC setup, refer to *CX-Programmer Operation Manual (W446)*.
- (7) Built-in flash memory
  - CP1L CPU units have built-in flash memory. Data is automatically backed up to the built-in flash memory as they are written to the user program area or the parameter area (PLC setup, routing table) by methods other than programmed instructions, i.e. when transferred or edited using CX-Programmer or PT, or when transferred from the memory cassette.
  - The next time the unit is powered ON, user memory (user program or parameter area) will automatically be transferred back from the built-in flash memory to RAM.
  - By using CX-Programmer, data in the DM area of the I/O memory can also be saved to the built-in flash memory. This saved data can be set as defaults for the DM area, and can be automatically written back into the DM area when the unit is powered ON next.
  - Symbol table, comment file, and program index file can be stored in the comment memory portion of the flash memory. When a project is transferred from CX-Programmer to the CPU unit, program information for the function block will automatically be saved to the flash memory.
- (8) Memory cassette
  - Memory cassettes can store programs, data memory contents, PLC setup data, and I/O comments from CX-Programmer.
  - Data stored in the memory cassette can be loaded automatically when the unit is powered ON.

## A-3-2 CPU Unit Behavior

This section briefly explains operations that take place within a CP1L CPU unit.

### ■ CPU Unit Operation Flow

Program executions (execution of instructions) are first processed, followed by I/O refresh and execution of the peripheral servicing. These processes are repeated in cyclic fashion.

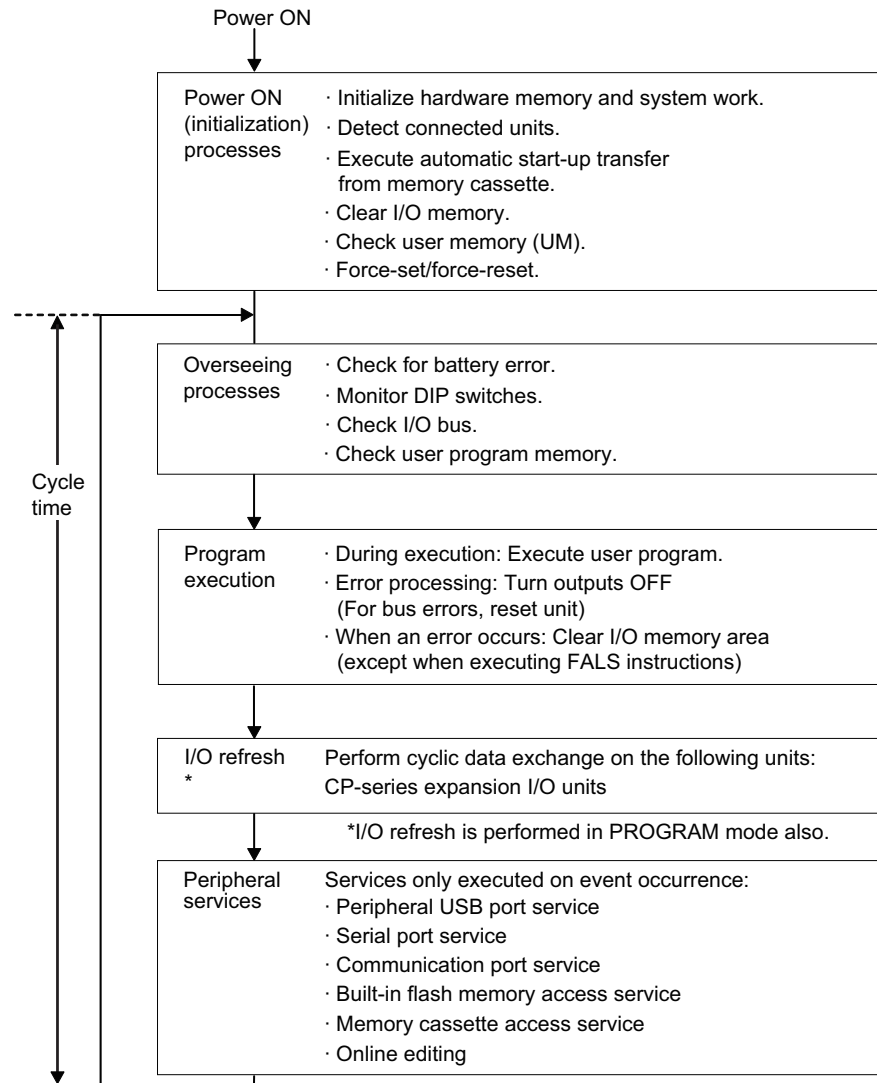

■ I/O Refreshing

I/O refreshing refers to cyclic data transfers between a preset area of the memory and an external source. It involves the following refreshing processes.

Target Unit Type	Max. Data Exchange	Data Exchange Area
CPU unit's built-in I/O	Input: 2 CH Output: 2 CH	I/O area
CP-series expansion I/O unit, expansion unit	Fixed; dependent on unit	I/O area

I/O refreshing is performed without interruption within a single cycle. Furthermore, I/O refreshing is always performed after program execution.

I/O refreshing can be performed for CP1L's built-in normal I/O and CP-series expansion (I/O) units at one of the following 3 timings:

- Cyclic refreshing
- Execution by instructions with immediate refresh variation
- Execution by an IORF instruction

● Cyclic Refreshing

I/O refreshing is performed after all instructions in the executable tasks have been executed.

This is the standard method for I/O refreshing.

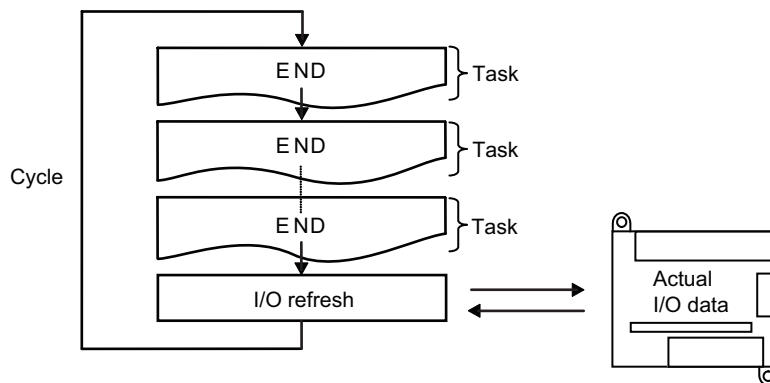

● Execution by Instructions with Immediate Refresh Variation

If the immediate refresh variation has been specified for an instruction, and the built-in I/O area has been specified as an operand, then I/O refreshing is performed when the instruction is executed during the program execution cycle.

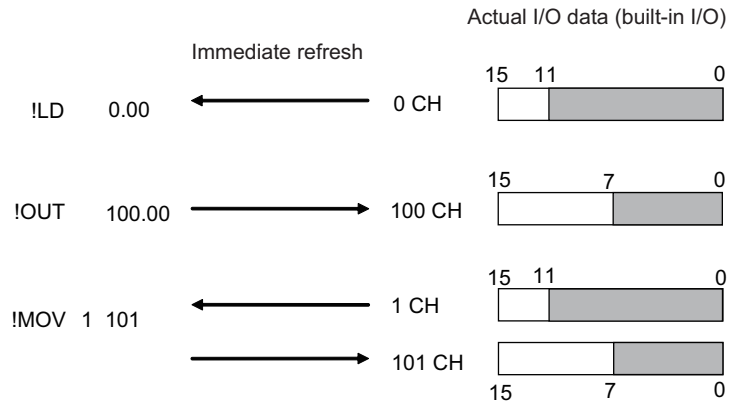

- Note**
1. Immediate refreshing is possible on the built-in I/O area only. For CP-series expansion (I/O) units, use the IORF instruction.
  2. Bit-specific instructions:  
The channel (16 bits) containing the specified bit will be refreshed.  
Channel-specified instruction:  
The specified channel (16 bits) will be refreshed.
  3. Inputs and S (source) operands:  
The input is refreshed immediately before executing the instruction.  
Outputs and D (destination) operands:  
The output is refreshed immediately after executing the instruction.

● Executing IORF(I/O REFRESH) Instructions

IORF (I/O REFRESH) instructions can be used to refresh all I/O data or just the data within the specified range, at a desired timing. IORF instructions refresh CP-series expansion (I/O) units.

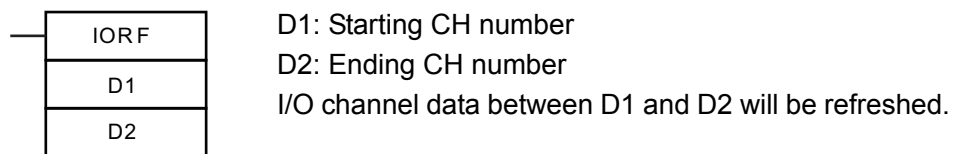

- Note** IORF instructions take a relatively long time to execute. The execution time will increase as the number of channels being refreshed increases. Hence, the total cycle time may be extended. It should be noted that the total cycle time may be increased significantly.
- For details, refer to *SECTION 4 Instruction Execution Times and Number of Steps of CP Series CP1H/CP1L CPU Unit Programming Manual (W451)*.

## ■ Peripheral Services

Peripheral services are event services that occur on an irregular basis, such as monitoring and setup on PT, and online editing (editing programs under execution) and monitoring on CX-Programmer.

It involves processing of service requests both to and from external devices.

In the CP-series, most of the services use the FINS command.

Each service is allocated with a fixed amount of time specified by the system, and is executed every cycle. If the services processing completes within the allocated time, no processing is performed during the remaining time.

Service Type	Content
Peripheral USB port service	<ul style="list-style-type: none"> <li>Processes unscheduled requests received as FINS or Host Link commands from CX-Programmer, PT, or from a host computer via a peripheral USB port or serial port (i.e. requests for program transfer, monitoring, forced-set/reset, or online editing).</li> <li>Processes unscheduled requests issued by the CPU unit via a serial port (non-solicited communications).</li> </ul>
Serial port service	
Communication port service	<ul style="list-style-type: none"> <li>Executes serial communication by SEND, RECV, and CMND instructions. Uses internal logic ports 0 to 7 as communication ports.</li> <li>Executes instructions in the background, using internal logic ports 0 to 7 as communication ports.</li> </ul>
Built-in flash memory accessing service	<ul style="list-style-type: none"> <li>Processes reading and writing of data from and to the built-in flash memory.</li> </ul>
Memory cassette accessing service	<ul style="list-style-type: none"> <li>Processes reading and writing of data from and to the memory cassette.</li> </ul>

**Note** Service time is separately allocated for the peripheral USB port, serial port, and communication port services. By default, 4% of the preceding cycle time will be allocated.

If services take several cycles for execution, and are delayed, allocate a fixed amount of time (as opposed to percentage) to each service. To do this, use [Set time to all events] under PLC Settings.

## ■ Cycle Time

CPU units process data in cycles starting with Overseeing processes and ending with Peripheral services.

### ● Calculating Cycle Time

The cycle time is calculated as the sum of the following processing times.

Cycle Time = Overseeing Processes + Program Execution + (Cycle Time Calculation) + I/O Refresh + Peripheral Services

#### Overseeing Processes

Details	Processing Time and Variation Factors
Checks I/O buses. Checking of user program memory, battery error, etc.	0.4ms

#### Program execution

Details	Processing Time and Variation Factors
Processes program execution (execution of instructions). The processing time is the sum of individual instruction execution times.	Sum of instruction execution times

For details, refer to *SECTION 4 Instruction Execution Times and Number of Steps of CP Series CP1H/CP1L CPU Unit Programming Manual (W451)*.

#### Cycle Time Calculation

Details	Processing Time and Variation Factors
Waits for the specified cycle time to elapse when a minimum (fixed) cycle time is specified in PLC Settings. Calculates the cycle time.	When the cycle time has not been fixed, the processing time is approximately 0. Additional time for fixing the cycle time = Fixed cycle time – Actual cycle time (processing time for: overseeing processes + program execution + I/O refreshing + peripheral services)

#### I/O Refreshing

Details	Processing Time and Variation Factors
CP-series Expansion I/O Units and Expansion Units	Each unit is refreshed. Outputs (from the CPU unit to the expansion units) are refreshed first, followed by the inputs (from the expansion units to the CPU unit). I/O refresh time for each unit is multiplied by the number of units used

For details on I/O refresh time, refer to *2-7 Computing the Cycle Time of CP Series CP1L CPU Unit User's Manual (W462)*.



## Peripheral Services

Details	Processing Time and Variation Factors
Peripheral USB port service	Processing time for these services will vary depending on the PLC settings. If a cycle time has not been specified, service will be executed using 4% of the preceding cycle time calculated by "cycle time calculation". If a cycle time has been specified, service will be executed for the specified time. Execution will take at least 0.1ms, regardless of whether a cycle time has been specified or not. If the ports are not connected, the servicing time will be 0ms.
Serial port service	
Communication port service	If a cycle time has not been specified in the PLC settings, service will be executed for 4% of the preceding cycle time calculated by "cycle time calculation".
	If a cycle time has been specified, service will be executed for the specified time.
	Execution will take at least 0.1ms, regardless of whether the cycle time has been specified.
	If no communications ports are used, the servicing time will be 0ms.
Built-in flash memory accessing service	Processing time for these services will vary depending on the PLC settings. If a cycle time has not been specified, service will be executed using 4% of the preceding cycle time calculated by "cycle time calculation". If a cycle time has been specified, service will be executed for the specified time. Execution will take at least 0.1ms, regardless of whether the cycle time has been specified. If there is no access, the servicing time will be 0ms.
Memory cassette accessing service	

- Note**
- The cycle time will vary depending on the following factors.
    - Type and number of instructions in the user program (all cyclic tasks and additional tasks executable during the cycle, and interrupt tasks of which execution condition are satisfied)
    - Type and number of CP-series expansion I/O units and expansion units connected (use of protocol macro, and max. number of transmission data channels within messages)
    - "Minimum cycle time" specified in the PLC settings
    - Use of peripheral USB ports and serial ports
    - "Fixed peripheral servicing time" specified in the PLC settings
  - The cycle time is not affected by the number of tasks in the user program. The cycle time is only affected by cyclic tasks that are READY within the cycle.
  - When changing from MONITOR to RUN mode, the cycle time will be extended by approx. 10ms (this will not, however, make the cycle time too long).

### ● Example Calculation of Cycle Time

An example for 4-2-2 Ladder Programs is shown.

Process Name	Formula	Processing Time
Overseeing processes	-	0.4ms
Program execution	Sequential input instructions LD 0.55 $\mu$ s x 6 instructions OR 0.68 $\mu$ s x 6 instructions AND NOT 0.65 $\mu$ s x 7 instructions Sequential input instructions (differentiated) 5.5 $\mu$ s x 1 instruction Sequential output instructions 1.1 $\mu$ s x 3 instructions Timer instructions 6.4 $\mu$ s x 1 instruction Counter instructions 6.7 $\mu$ s x 1 instruction END instruction 6.2 $\mu$ s x 1 instruction	0.04ms
Cycle time calculation	N/A	0ms
I/O refreshing	N/A (no expansion unit)	0ms
Peripheral services	N/A (no connection)	0ms
Cycle time		0.44ms

The following conditions apply:

- CP1L 14-point I/O unit is used.
- No expansion units are used.
- No connections are made, i.e. with CX-Programmer.

## A-4 CP1L Programming Examples

This section provides examples for wiring, DIP switch settings, and programming.

For details on wiring and settings, refer to *CP Series CP1L CPU Unit User's Manual (W462)*. For details on CP1L instructions, refer to *CP Series CP1H/CP1L CPU Unit Programming Manual (W451)*. For details on using CX-Programmer, refer to *CX-Programmer Operation Manual (W446)*.

### A-4-1 Using Adjusters to Set Timers

#### ■ Functions Used

##### ● External Analog Settings Input

Analog values can be digitized according to the external analog settings input (0 to 10V, resolution: 256). Converted values are sent to the auxiliary area (A643CH).

This function is useful for changing settings based on inputs such as change in outside temperature or feedback from a variable resistor.

An example using input from a variable resistor is shown below.

#### ■ Operation Overview

A photoelectric sensor is placed in front of a gate. When the sensor detects a car, the gate is opened.

When the car passes the gate, the sensor is turned OFF.

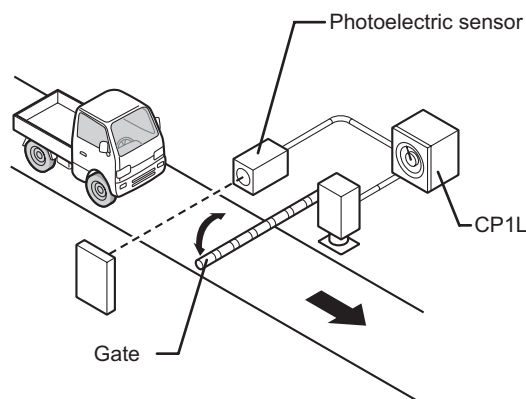

When a set amount of time passes after the sensor is turned OFF, the gate is closed.

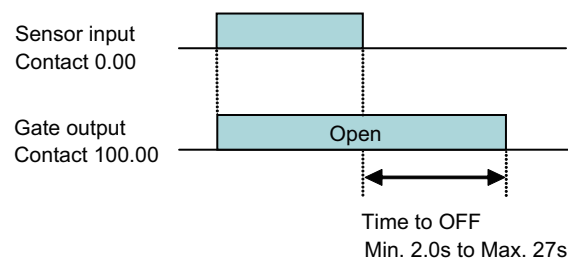

The time until the gate closure will be adjusted with by a variable resistor connected to CP1L.

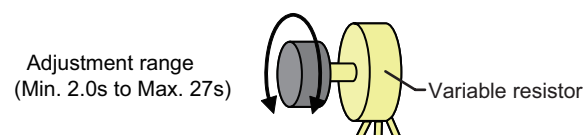

■ System Configuration  
 ● Wiring Example

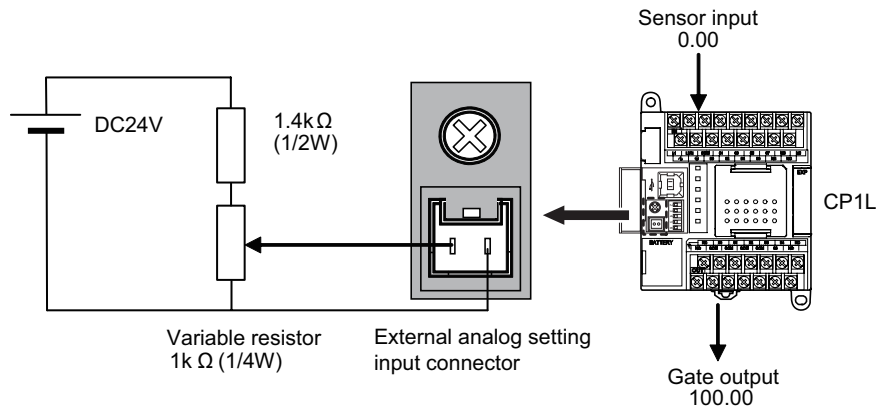

■ Programming Example  
 ● Ladder Program

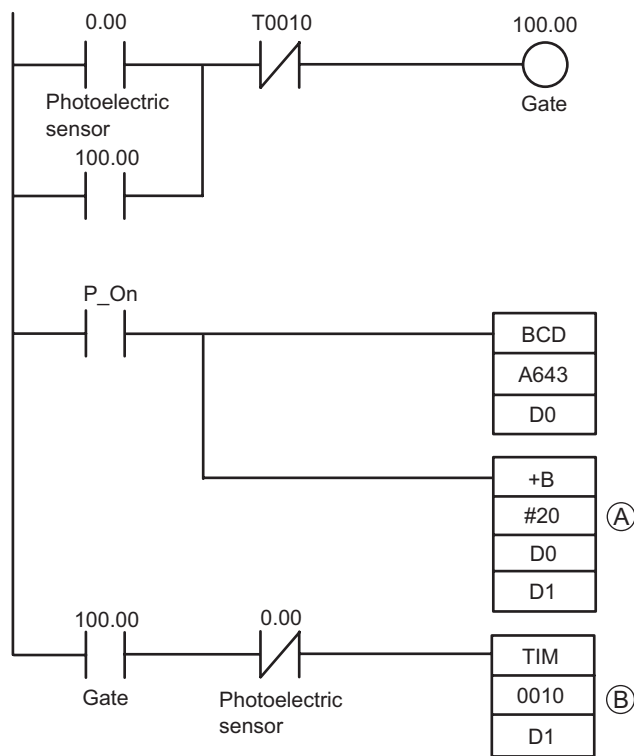

(A): To set a minimal value of 2sec, first convert the external analog input value A643 to a BCD value of D0, increment it by 20BCD/2sec, and then store it as D1.

(B): TIM will act as a decrementing ON timer with 0.1sec intervals.

■ INFO

● Relationship between Input Voltage and A643's PV

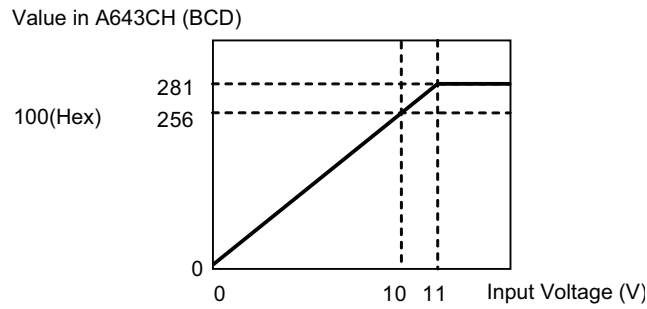

The maximum input voltage is 11VDC. Do not apply voltages any greater.

● Using the Analog Adjuster on CP1L

Settings can be changed by using the analog adjuster on CP1L instead of using an external analog settings input. The analog adjuster can set the auxiliary area (A642CH) to any value in the 0 to 255 range (0 to FF Hex).

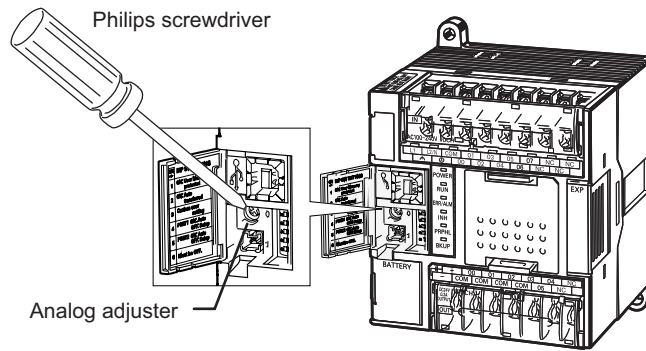

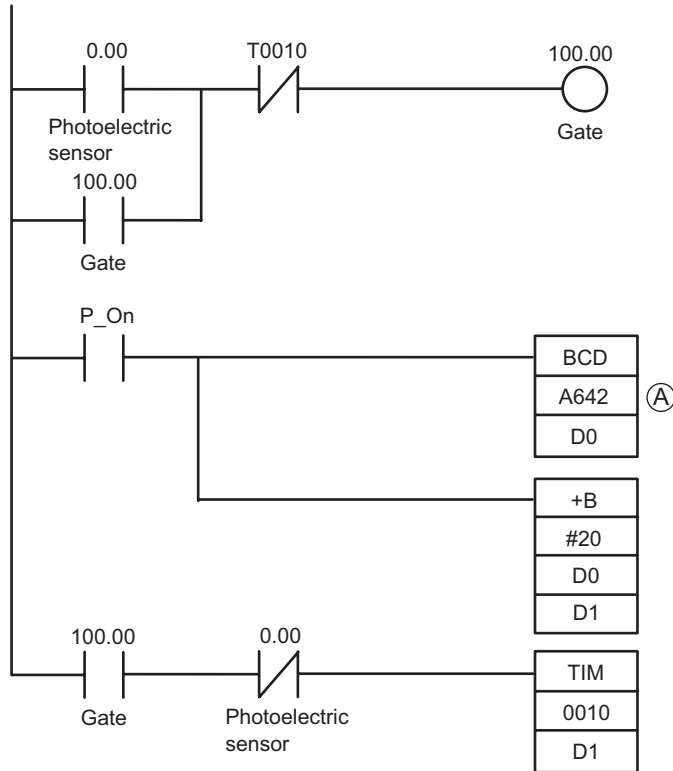

(A): To use the analog adjuster on CP1L for setting the timer in the example application, change auxiliary area A643 in the ladder program to A642.

## A-4-2 Capturing Short Signals

### ■ Functions Used

#### ● Quick-Response Input

By setting the built-in input to use quick-response inputs, inputs having a signal width as small as 30 $\mu$ s can be captured, regardless of the cycle time.

14-point I/O units can use up to 4 quick-response inputs. 20/30/40-point I/O types can use up to 6.

### ■ Operation Overview

Products moving at high speeds are detected by a sensor and counted.

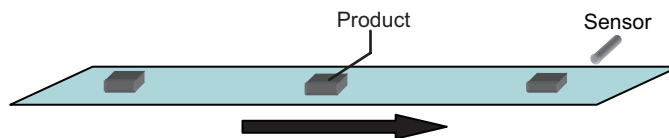

Signals that are shorter than the scan time must be read and counted.  
 When 100 signals have been counted, a counting completed signal will be output.

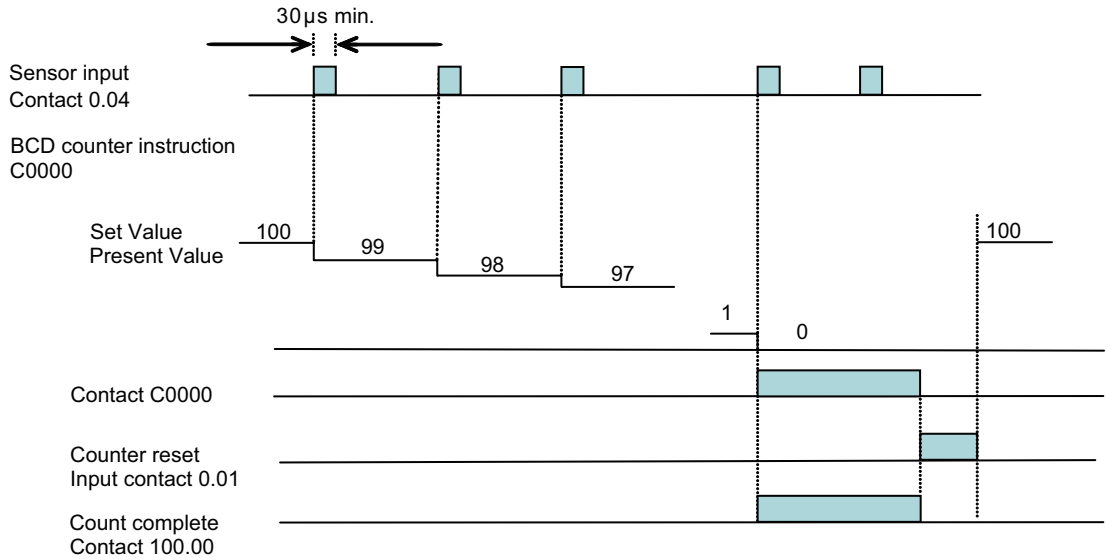

- Quick-response inputs can read short signals that are shorter than the cycle time. However, as with any other input, the full cycle time will be used for ladder processing. For accelerated processing unaffected by the scan time, use interrupt inputs.
- The input can only be counted once during each cycle time, regardless of how many times the input occurs. To count the input multiple times within each cycle time, use a high-speed counter.

## ■ System Configuration

### ● Wiring Example

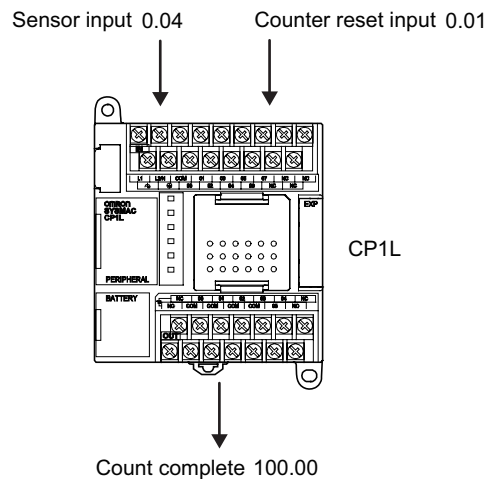

## ■ PLC Setup

On the PLC Settings dialog box, set the sensor input (0.04) to [Quick].

1. **Open the CX-Programmer main window.**
2. **Double-click [Settings] in the project tree.**

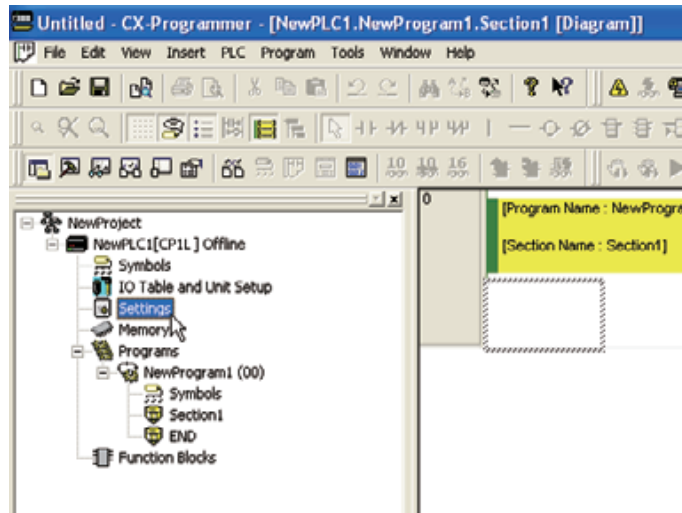

The PLC Settings dialog box will be displayed.

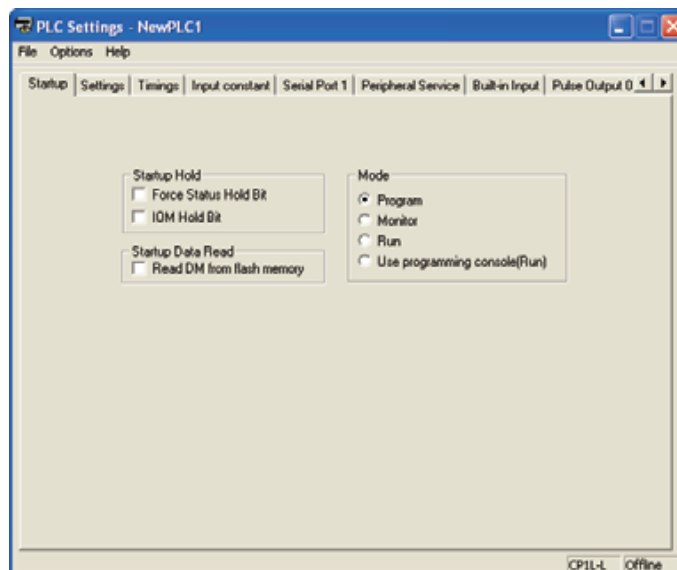

3. **Click the Built-in Input tab.**



4. On the IN0 drop-down list for Interrupt Input, select [Quick]. While the sensor input contact is 0.04, setup is performed for [IN0] since the interrupt input / quick-response input setting is set to 0.

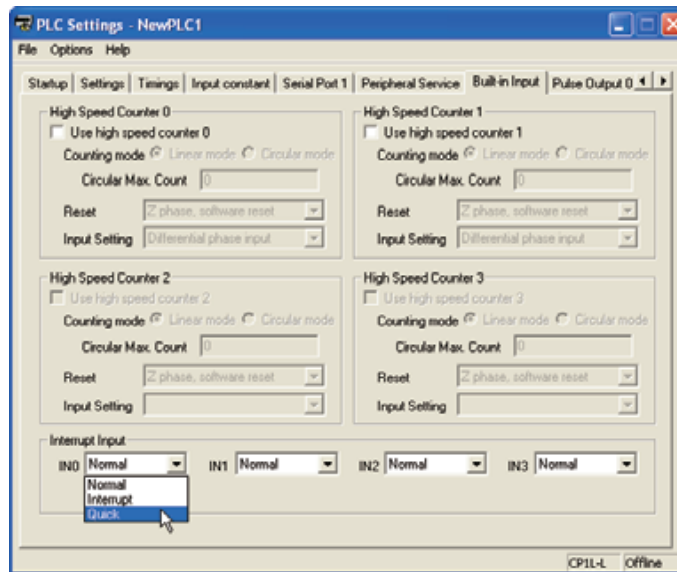

5. Close the PLC Settings dialog box.
6. To apply changes made to the PLC settings, turn the PLC power ON.

■ Programming Example

● Ladder Program

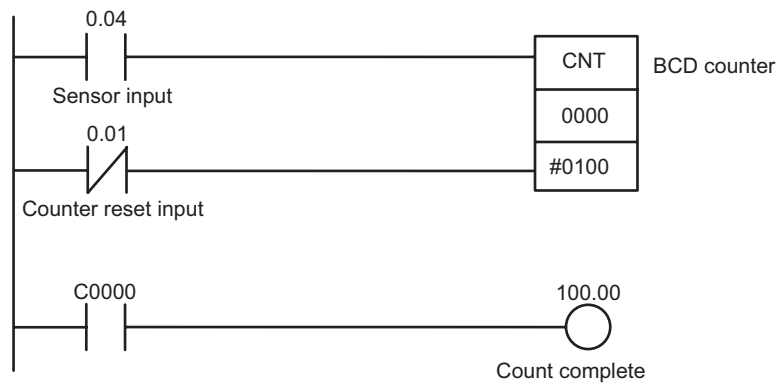

## A-4-3 Using Interrupt Inputs to Accelerate Processes

### ■ Functions Used

#### ● Interrupt Inputs

CP1L CPU Units normally repeat processes in the following order: overseeing processes, program execution, I/O refreshing, peripheral servicing. During the program execution stage, cyclic tasks are executed. The interrupt function, on the other hand, allows a specified condition to interrupt a cycle and execute the specified program. Interrupt inputs (direct mode) execute interrupt tasks when the built-in input of a CPU unit switches from OFF to ON, or from ON to OFF. Interrupt tasks 140 to 145 are allocated to the input contacts. The allocation is fixed. Use interrupt inputs to achieve faster processing that is unaffected by the scan time.

### ■ Operation Overview

Moving product (i.e. IC chips) will be inspected for curvatures and bends. Use interrupt inputs if the normal cycle time cannot provide fast enough processing.

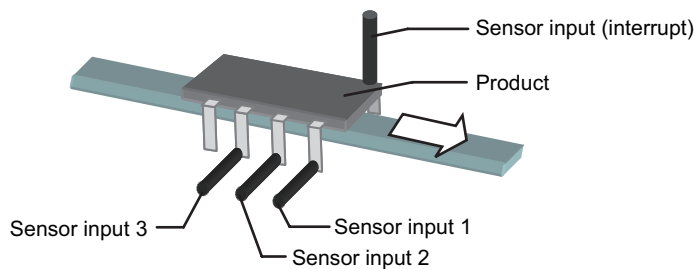

Interrupt tasks will be executed when the sensor input (interrupt) changes from OFF to ON.

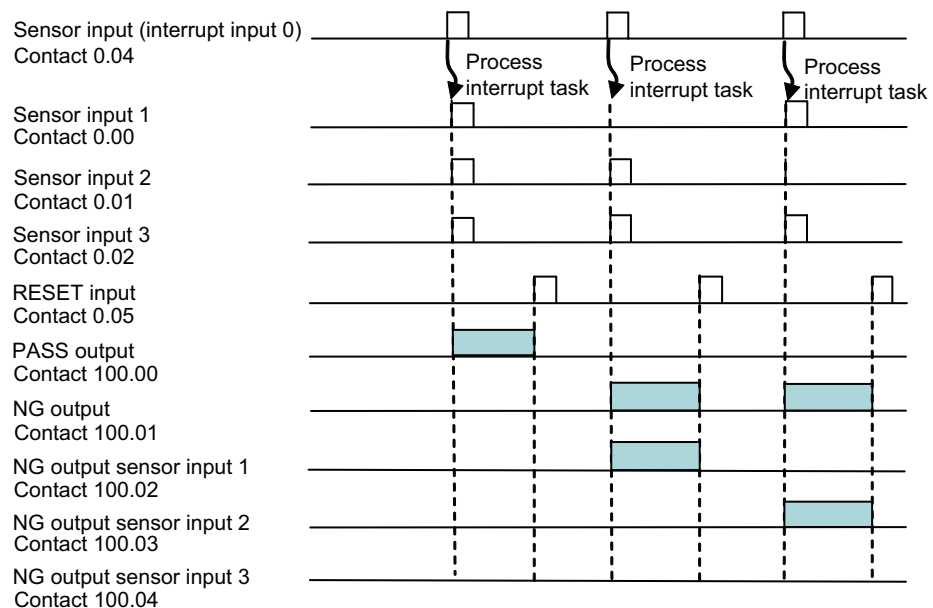

■ System Configuration

● Wiring Example

On CP1L units with 14-point I/O, interrupt inputs can be allocated to contacts 0.04 to 0.07.

Input interrupt 0 will be allocated to contact 0.04. The interrupt task executed by input interrupt 0 is task No.140.

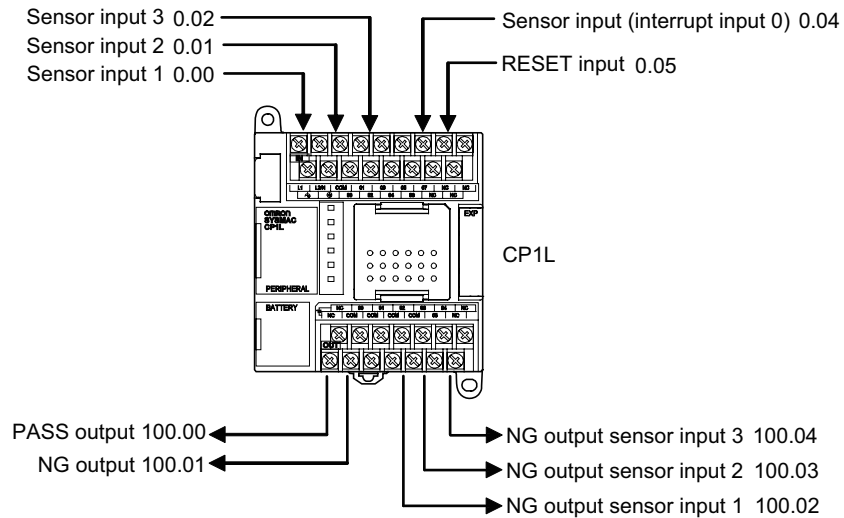

● PLC Setup

Set contact 0.04 to be [Interrupt].

1. **Open the PLC Settings dialog box.**
2. **Click the Built-in Input tab.**
3. **On the IN0 drop-down list for [Interrupt Input], select [Interrupt].**  
**While the sensor input contact is 0.04, setup is performed for [IN0] since the interrupt input setting is set to 0.**

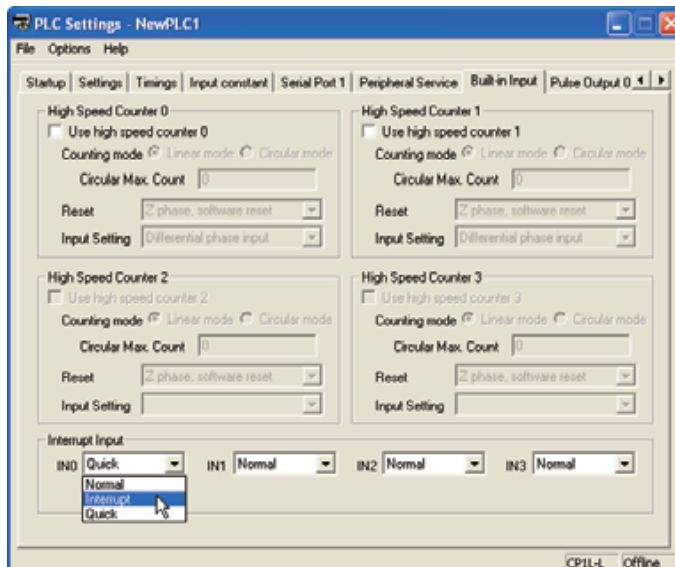

4. **Close the PLC Settings dialog box.**
5. **To apply changes made to the PLC settings, turn the PLC power ON.**

■ Programming Example  
 ● Ladder Program

MSKS (interrupt mask set) instructions will be used to assign the "up" specification to the interrupt input, and to set the interrupt permission for enabling the interrupt inputs.

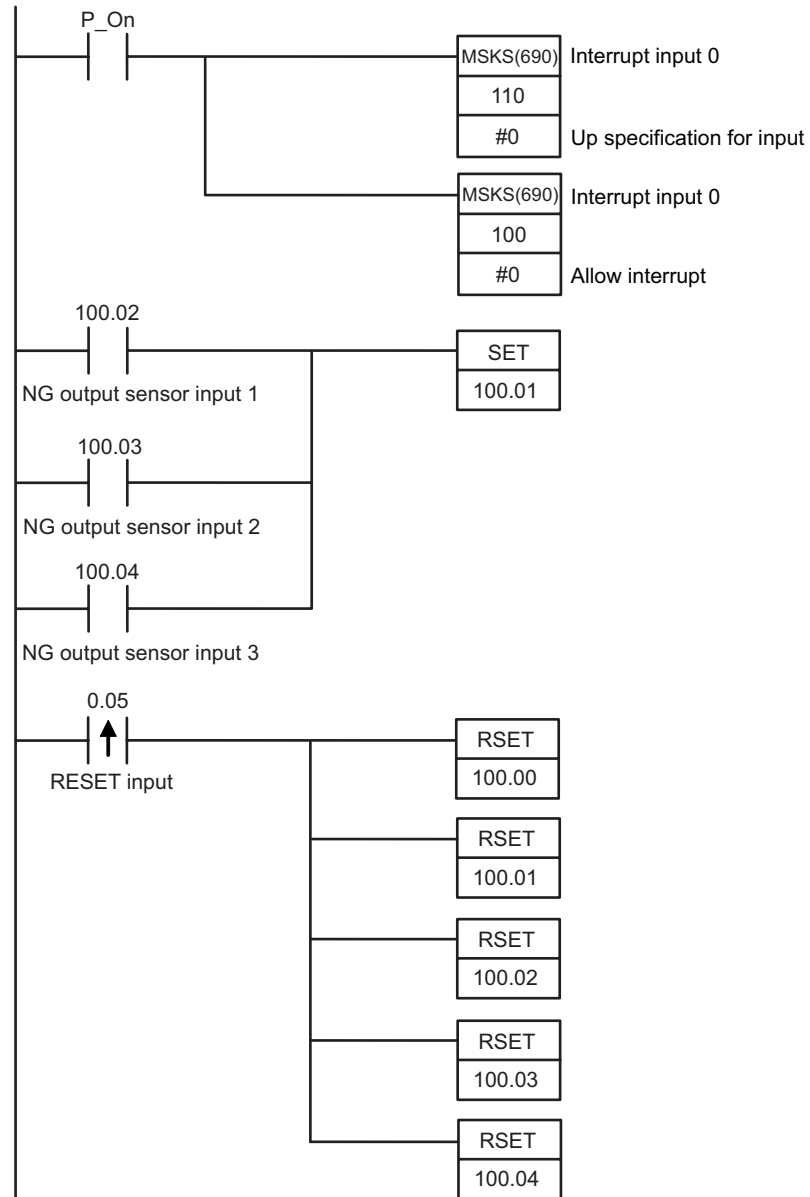

When interrupt input 0 (contact 0.04) turns ON, the following "interrupt task 140" will be executed once. Assignment of interrupt tasks to interrupt inputs is fixed. Interrupt input 0 will always execute interrupt task 140.

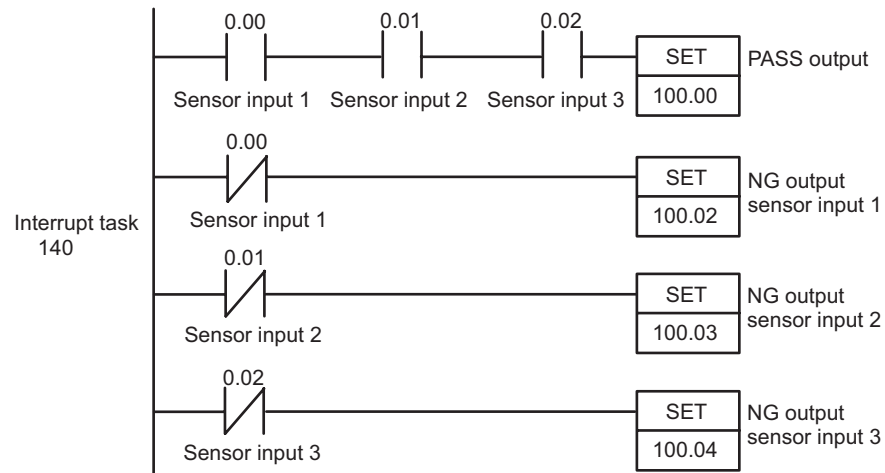

A

## ■ INFO

### ● Creating Interrupt Task Programs

1. **Right-click [NewPLC1[CP1L]Offline] in the project tree. Select [Insert Program] from the pop-up menu.**

[NewProgram2(Unassigned)] will be added to the bottom of the project tree.

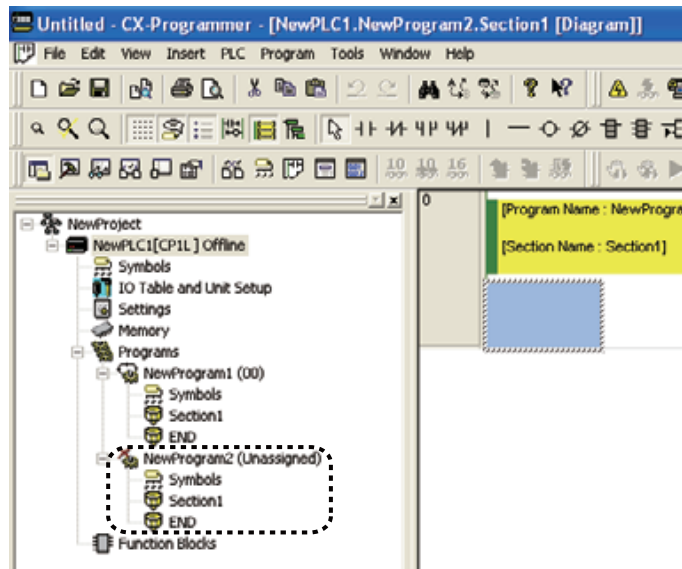

2. **Right-click [NewProgram2(Unassigned)]. Select [Properties] from the pop-up menu.**

The Program Properties dialog box will be displayed.

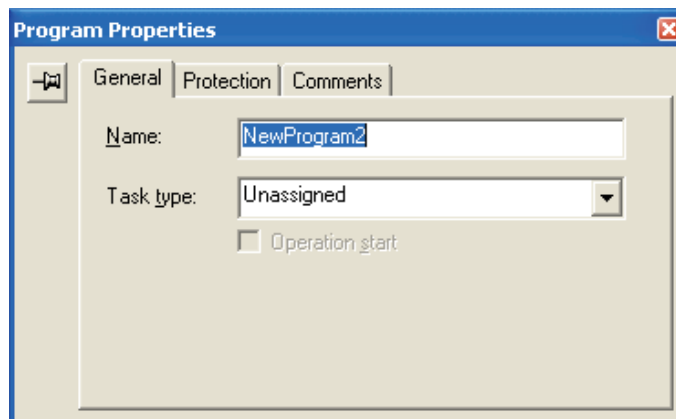

- Click the **General** tab. Select **[Interrupt Task 140]** from the **Task type** drop-down list.

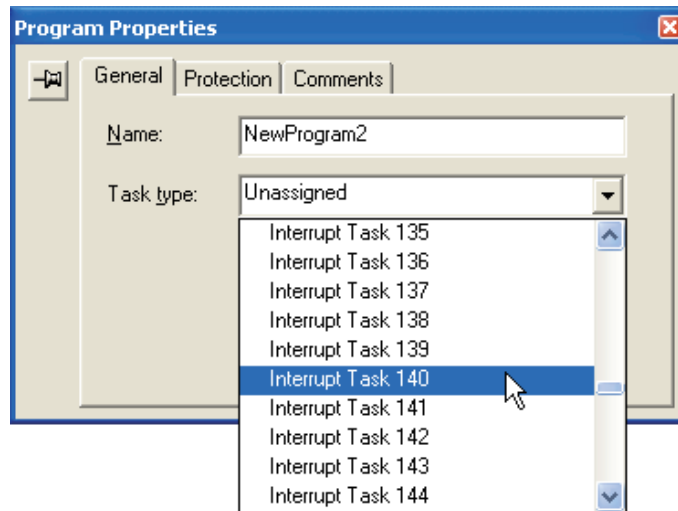

- Close the **Program Properties** dialog box.
- Select **[Section1]** under **[NewProgram2(Int 140)]**.

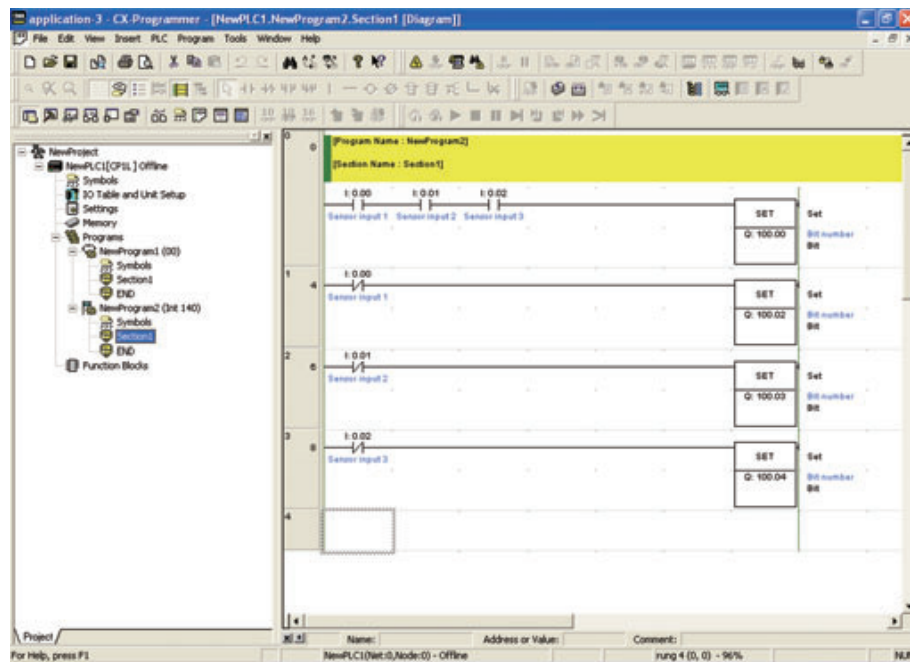

- Input the ladder program for the interrupt.  
To display the main ladder program, double-click **[Section1]** under **[NewProgram1(00)]** in the project tree.

## A-4-4 Using Calendar Timers

### ■ Functions Used

#### ● Clock

CP1L CPU units have a built-in clock.

The clock cannot be used if a battery is not installed or the battery voltage is low.

### ■ Operation Overview

In this example, a fountain will be controlled.

The fountain is to be activated according to the following schedule:

- Mon thru Fri: 17:30 to 20:30
- Sat, Sun: 10:00 to 21:15

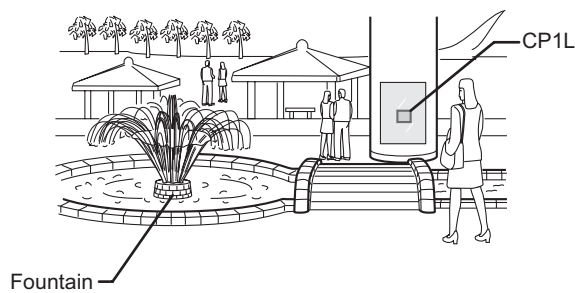

### ■ System Configuration

#### ● Wiring Example

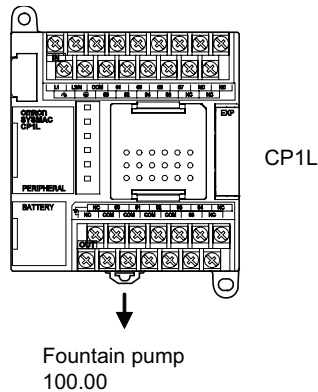



■ Programming Example  
● Ladder Program

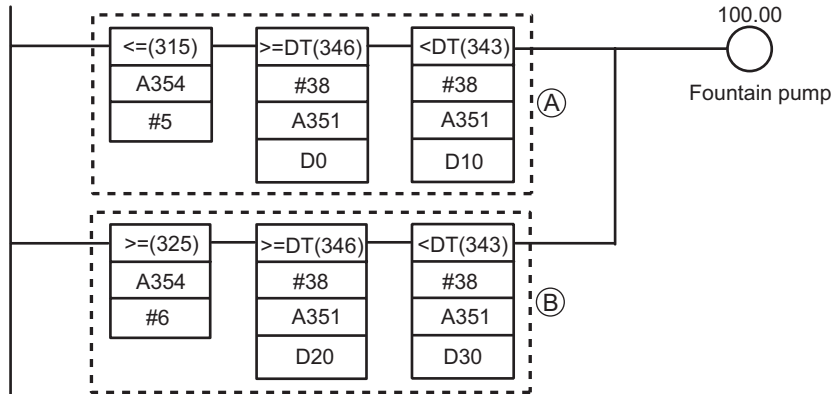

(A): Turned ON for Monday thru Friday (i.e. when A354 [day] is less than or equal to [Friday]),  
from 17:30 (when A351 [hh:mm:ss] becomes equal to the value set in D0 [17:30:00])  
until 20:30 (when A351 [hh:mm:ss] becomes equal to the value set in D10 [20:30:00]).

(B): Turned ON for Saturday and Sunday (i.e. when A354 [day] is greater than or equal to [Saturday]),  
from 10:00 (when A351 [hh:mm:ss] becomes equal to the value set in D20 [10:00:00])  
until 21:15 (when A351 [hh:mm:ss] becomes equal to the value set in D30 [21:15:00]).

- >=DT and <DT are time comparison instructions.

■ INFO

● Time Data on CP1L

The clock's PV is output to the following auxiliary areas.

Name	Address	Content
Time data	A351.00 to A351.07	Second: 00 to 59 (BCD)
	A351.08 to A351.15	Minute: 00 to 59 (BCD)
	A352.00 to A352.07	Hour: 00 to 23 (BCD)
	A352.08 to A352.15	Day of the month: 01 to 31 (BCD)
	A353.00 to A353.07	Month: 01 to 12 (BCD)
	A353.08 to A353.15	Year: 00 to 99 (BCD)
	A354.00 to A354.07	Day of the week: 00 to 06 (BCD) 00: Sunday, 01: Monday, 02: Tuesday, 03: Wednesday, 04: Thursday, 05: Friday, 06: Saturday

● Time Comparison Instructions

Time comparison instructions allow for easy comparisons of time.

E.g. If 0.00 is ON and the time is 13:00:00, turn 100.00 ON.

The hour, minute, and second of the current time in the CPU unit's built-in clock (A351 to A352) and set time (D100 to D102) will be compared.

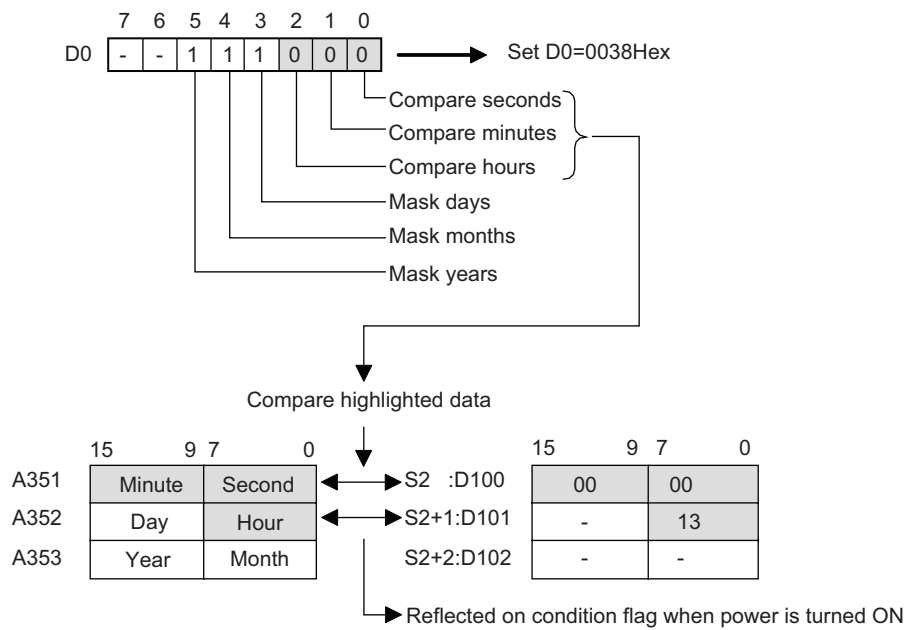
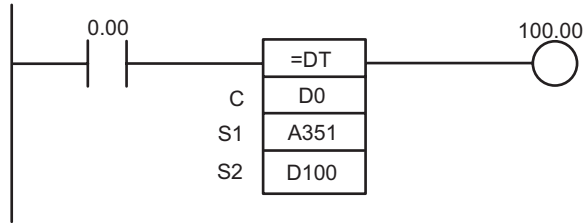

## ●DM Area Setup

The following values are set into the DM area as BCD.

Channel	Value	Content
D0	3000	30min 00sec
D1	0017	17hr
D2	0000	-
D10	3000	30min 00sec
D11	0020	20hr
D12	0000	-
D20	0000	00min 00sec
D21	0010	10hr
D22	0000	-
D30	1500	15min 00sec
D31	0021	21hr
D32	0000	-

1. Open the CX-Programmer main window.
2. Double-click [Memory] in the project tree.

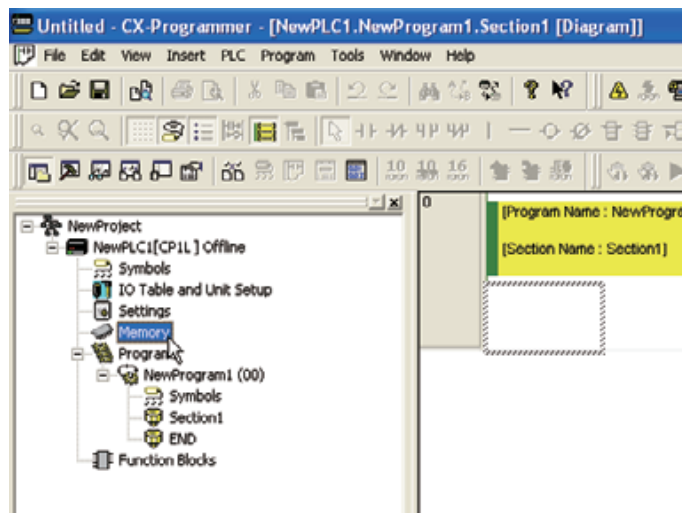

The Memory window will be displayed.

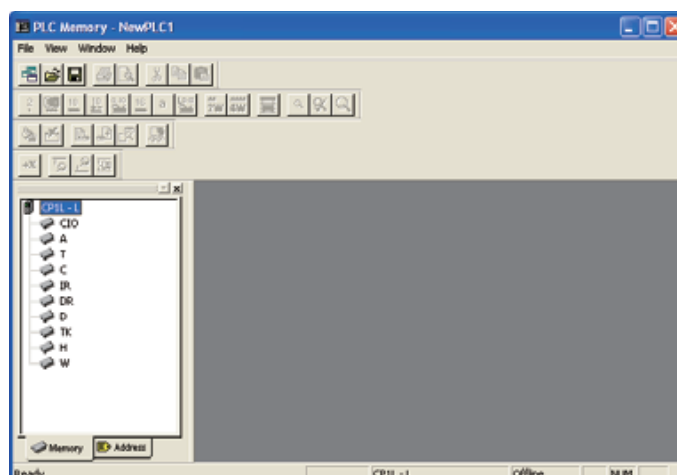

3. **Double-click [D] in the data area workspace.**  
The PLC data table will be displayed.

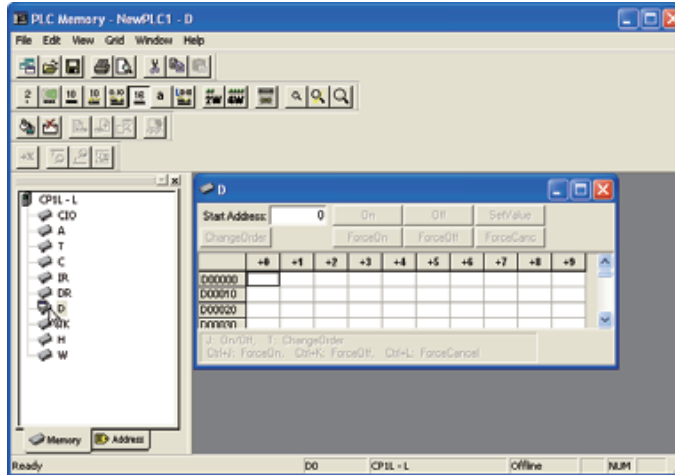

4. **Input the values for the DM addresses.**

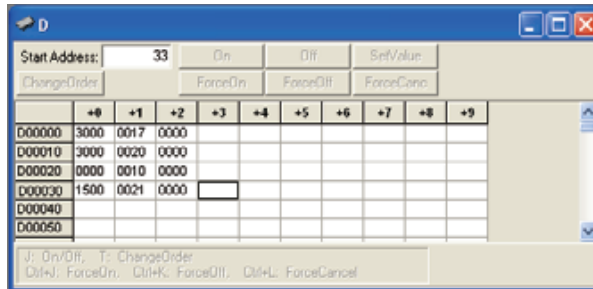

5. **Click [Save in Project].**  
The settings will be saved.
6. **Transfer the data from the computer to CP1L.**
  - 1) Confirm that the computer is online with CP1L.
  - 2) Select [Online] - [Transfer to PLC] from the menu.  
The Transfer to PLC dialog box will be displayed.
  - 3) Select the area and its region for the transfer. Click [Transfer to PLC].  
The data will be transferred.

## A-4-5 Using Rotary Encoders to Measure Positions

### ■ Functions Used

#### ● High-Speed Counting by Built-in Input

High-speed counter inputs can be enabled by connecting rotary encoders to the built-in inputs. CP1L units come with multiple high-speed counter inputs, making it possible to control multi-axis devices with a single CP1L.

High-speed counters can be used for matching target values, and for high-speed processing, using range comparison interrupts. Interrupt tasks can be triggered when the counter value reaches a specific value or value range.

### ■ Operation Overview

A sheet feeder will be regulated to feed constant lengths in a given direction, i.e. for vacuum packing of food products.

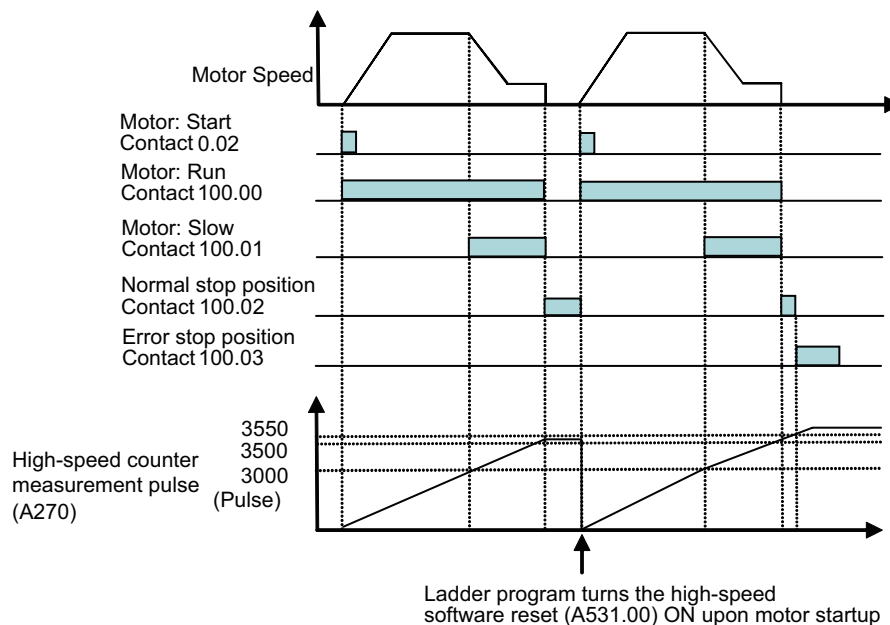

While the pulse count is between 3500 and 3550, normal stop position (100.02) will be ON. When the pulse count exceeds 3550, error stop position (100.03) will be ON.

■ System Configuration  
 ● Wiring Example

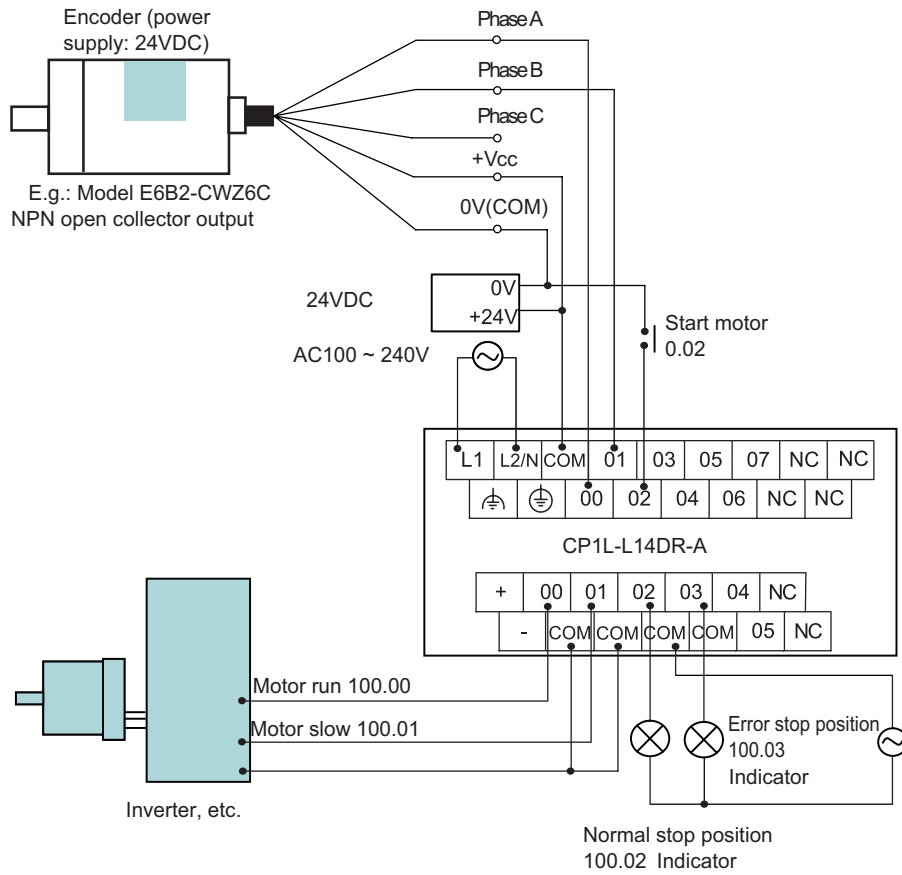

**Note** Use the external power supply for input devices only. (It cannot be used to power output devices.)

## ● PLC Setup

High-speed counter 0 will be enabled.

1. **Open the PLC Settings dialog box.**
2. **Click the Built-in Input tab.**

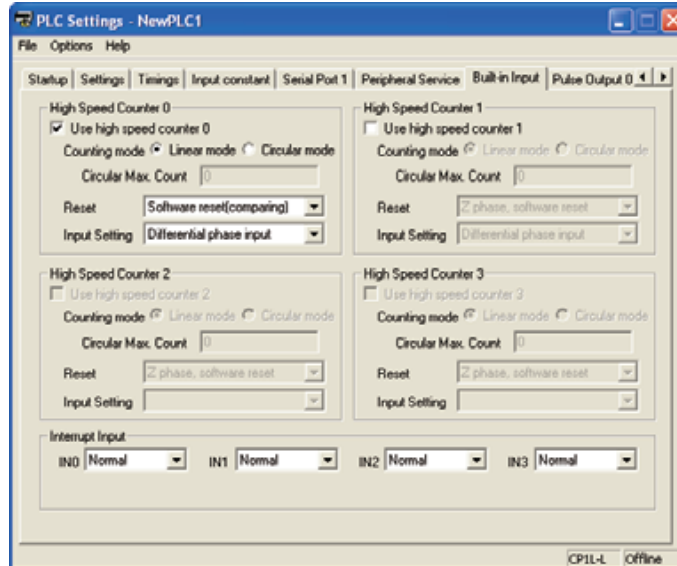

3. **Check the [Use high speed counter 0] checkbox for High Speed Counter 0.**
4. **Select [Linear mode] for [Counting mode].**
5. **Select [Software reset(comparing)] from the Reset drop-down list.**
6. **Select [Differential phase input] from the Input Setting drop-down list.**
7. **Close the PLC Settings dialog box.**
8. **To apply changes made to the PLC settings, turn the PLC power ON.**

### ■ Programming Example 1

Use comparison instructions to compare counter values.

The program can be created easily by using comparison instructions to compare counter values.

#### ● Ladder Program

Counter values are used to start/slow/stop the motor.

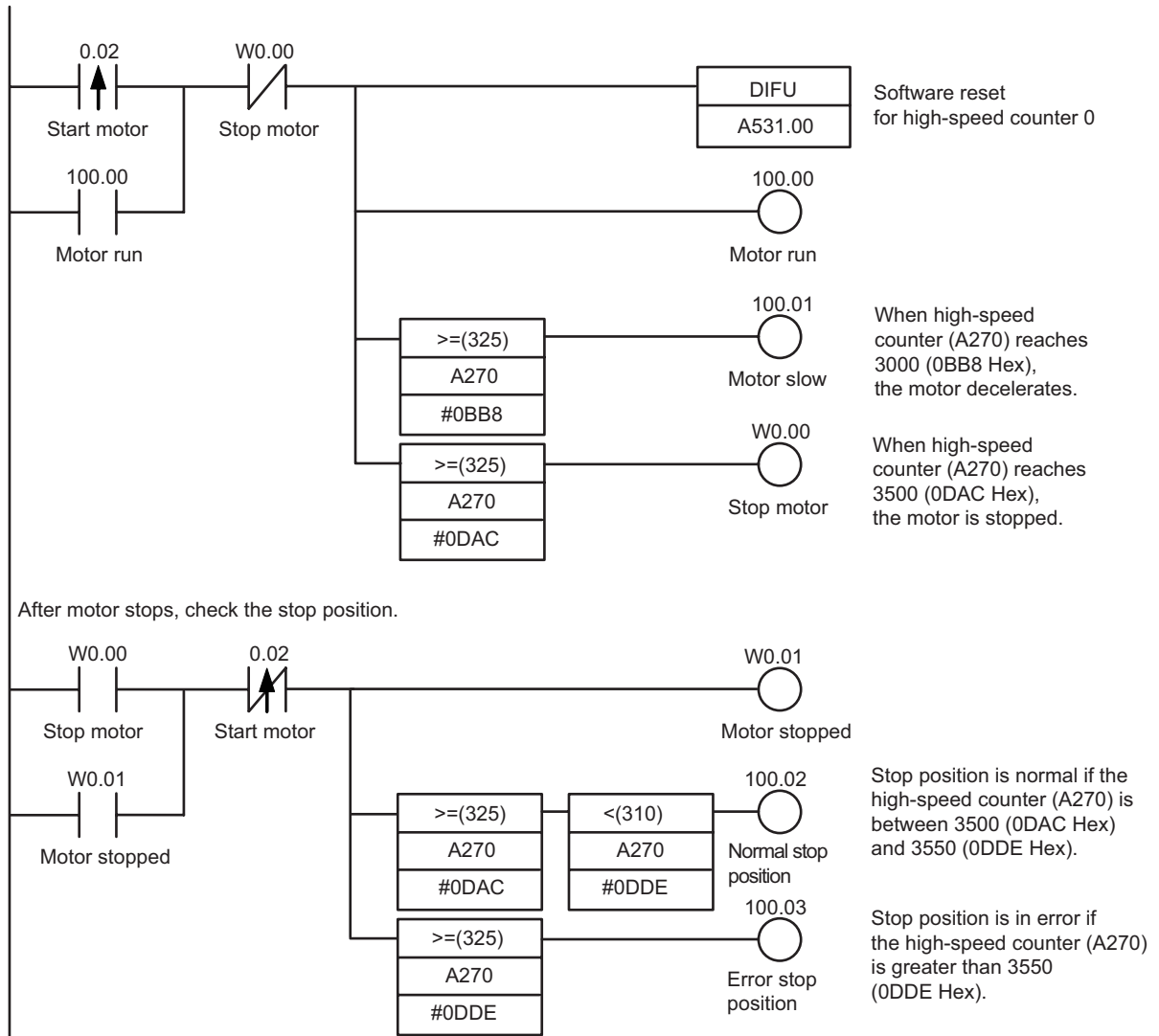



■ Programming Example 2

Use a CTBL (register comparison table) instruction to execute an interrupt process when the target value is achieved.

Slowing and stopping are executed as interrupt tasks, allowing high-speed processes to be executed without affecting the cycle time.

● Ladder Program

Use a CTBL instruction to execute interrupt tasks when the target position is reached.

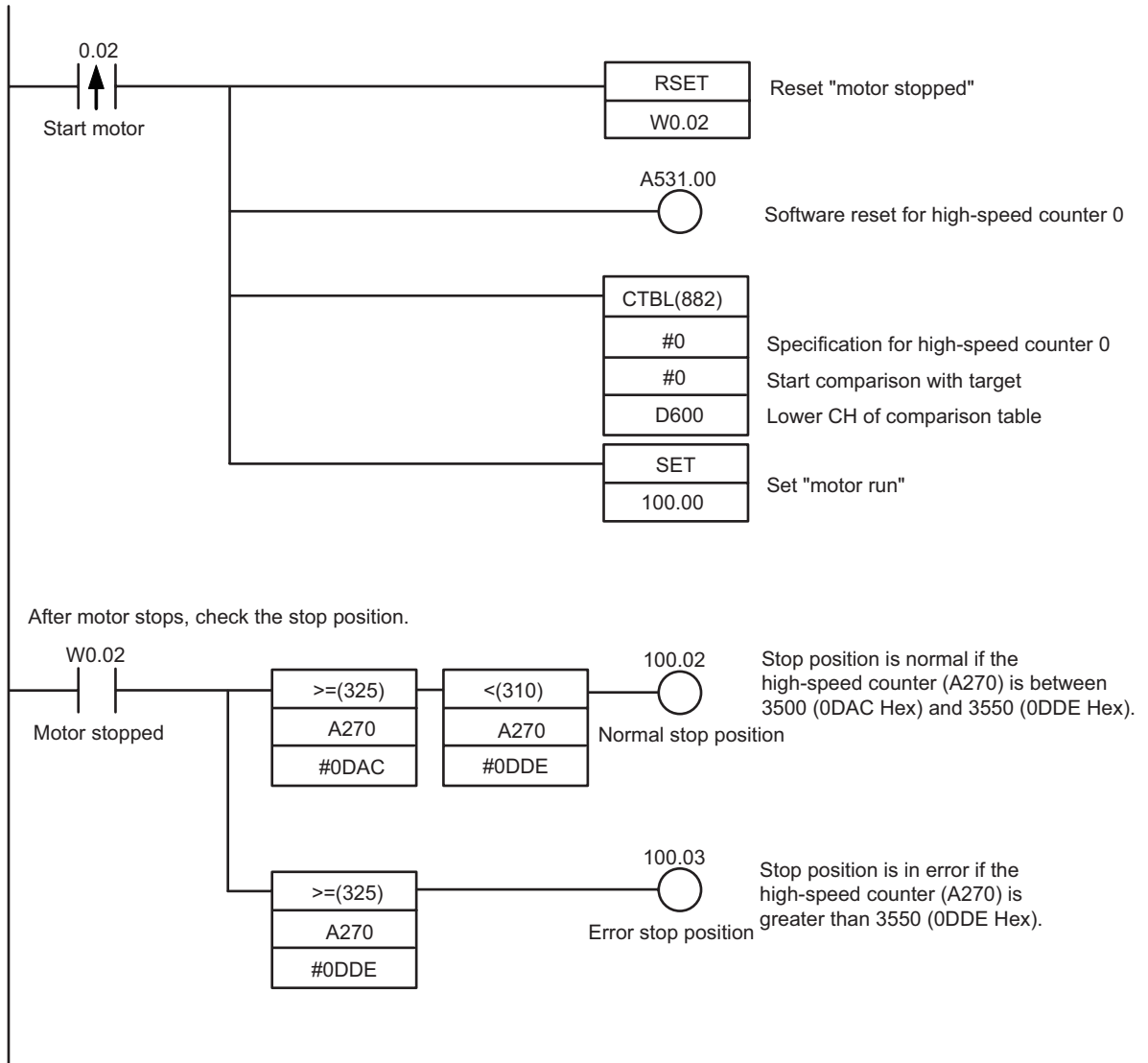

When the PV of the high-speed counter matches target value 1 (3000), interrupt task 04 will be executed.



When the PV of the high-speed counter matches target value 2 (3500), interrupt task 05 will be executed.

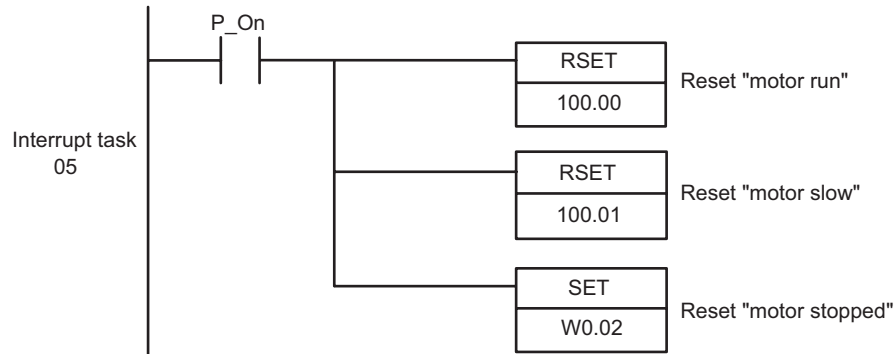

●DM Area Setup

The comparison table for the CTBL (register comparison table) instruction should be allocated to DM D600 through D606.

Channel	Value	Content
D600	0002	Items compared: 2
D601	0BB8	Target value 1: 3000 BCD (BB8 Hex)
D602	0000	
D603	0004	Target value 1: Interrupt task No.4
D604	0DAC	Target value 2: 3500 BCD (DAC Hex)
D605	0000	
D606	0005	Target value 2: Interrupt task No.5

## A-4-6 Using Servo Drivers for Positioning

■ Functions Used

●Pulse Output by Built-in Output

Pulse signal outputs from the built-in output of a CPU unit can be used for positioning and speed control of a servo motor driver with up to 2 axes.

■ Operation Overview

The following example is for a single-axis handling machine that is used to transfer product.

Origin search will be executed, followed by positioning operations to points A and B.

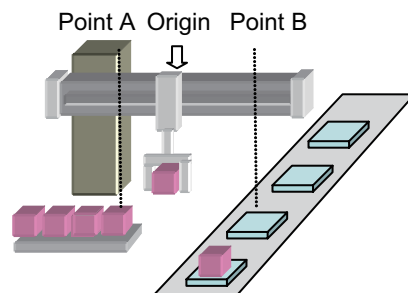

●Origin Search

An accurate origin search that makes use of various I/O signals (origin proximity input signal, origin input signal, positioning completed signal, error counter reset output, etc.) can be executed with a single instruction.

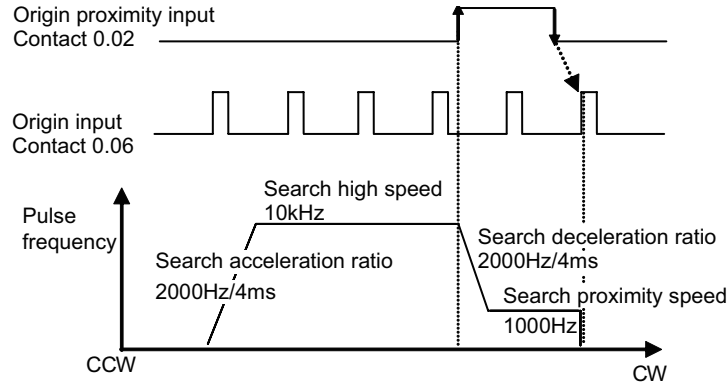

Origin Search Method	Setting	Description
Search direction	CW	Origin search is executed in the CW direction.
Detection method	Methd 0	Reads the first origin input signal after an OFF-ON-OFF sequence of the origin proximity input signal.
Search operation	Invers 1	Reverses direction on a limit input, and continues the origin search.
Operating mode	Mode 1	Executes an error counter reset output when the origin is detected. Positioning completed input will not be used.

●Positioning

Common settings for the positioning operations are as follows:

- Target frequency 50kHz
- Acceleration/deceleration ratio 2000Hz/4ms
- Initial frequency 0Hz

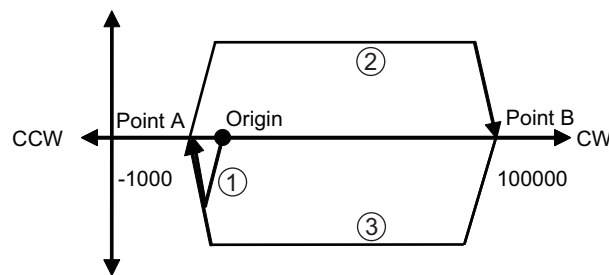

- (1) After completion of the origin search, the equipment will be positioned to point A (-1000) by absolute pulse specification (absolute coordinate system).
- (2) After positioning to point A, the equipment will be positioned to point B (100000) by absolute pulse specification (absolute coordinate system).
- (3) Positioning of points A and B are repeated. Because absolute pulse specification is used, the positioning SV for (3) will be the same as for (1).

■ System Configuration  
 ● Wiring Example

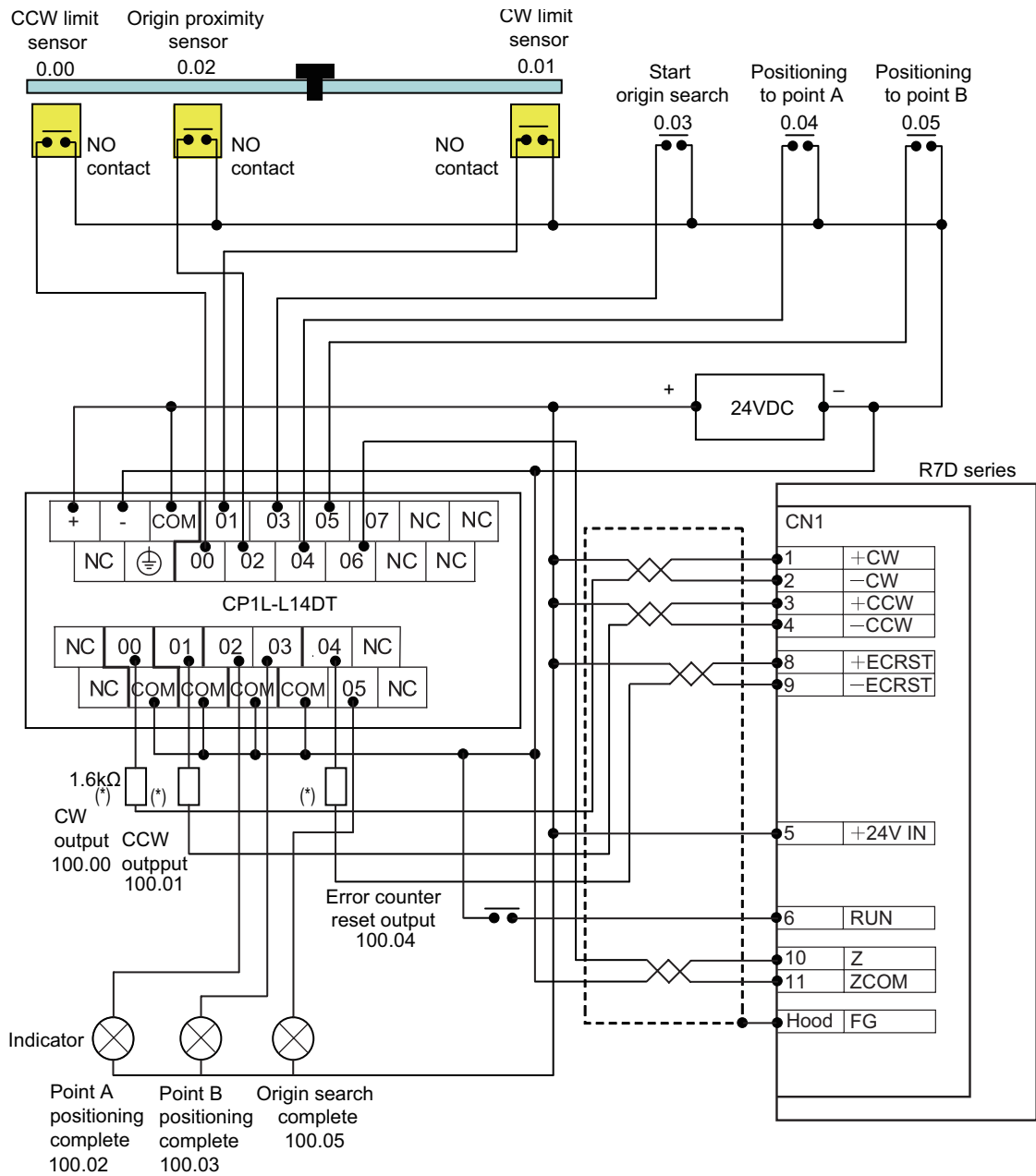

\*Insert a resistance of 1.6 to 2.2kΩ, so that the current is within the 7 to 15mA range.

\*For a 20/30/40-point CPU, the origin proximity input (pulse 0) will be 0CH10bit.

● PLC Setup

Specify the settings for pulse output 0.

1. **Open the PLC Settings dialog box.**
2. **Click the Pulse Output 0 tab.**
3. **Set the following settings.**

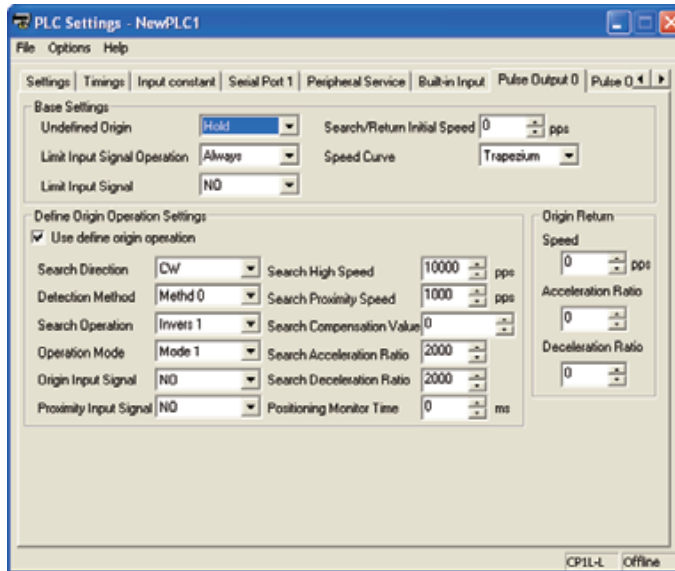

Base Settings

Item	Setting
Undefined Origin	Hold
Limit Input Signal Operation	Always
Limit Input Signal	NO
Search/Return Initial Speed	0pps
Speed Curve	Trapezoidal

Origin Search

Item	Setting
Use define origin operation	Use
Search Direction	CW
Detection Method	Methd 0
Search Operation	Invers 1
Operating Mode	Mode 1
Origin Input Signal	NO
Proximity Input Signal	NO
Search High Speed	10000pps
Search Proximity Speed	1000pps
Search Compensation Value	0
Search Acceleration Ratio	2000
Search Deceleration Ratio	2000
Positioning Monitor Time	0ms

4. **Close the PLC Settings dialog box.**
5. **To apply changes made to the PLC settings, turn the PLC power ON.**

■ Programming Example  
● Ladder Program

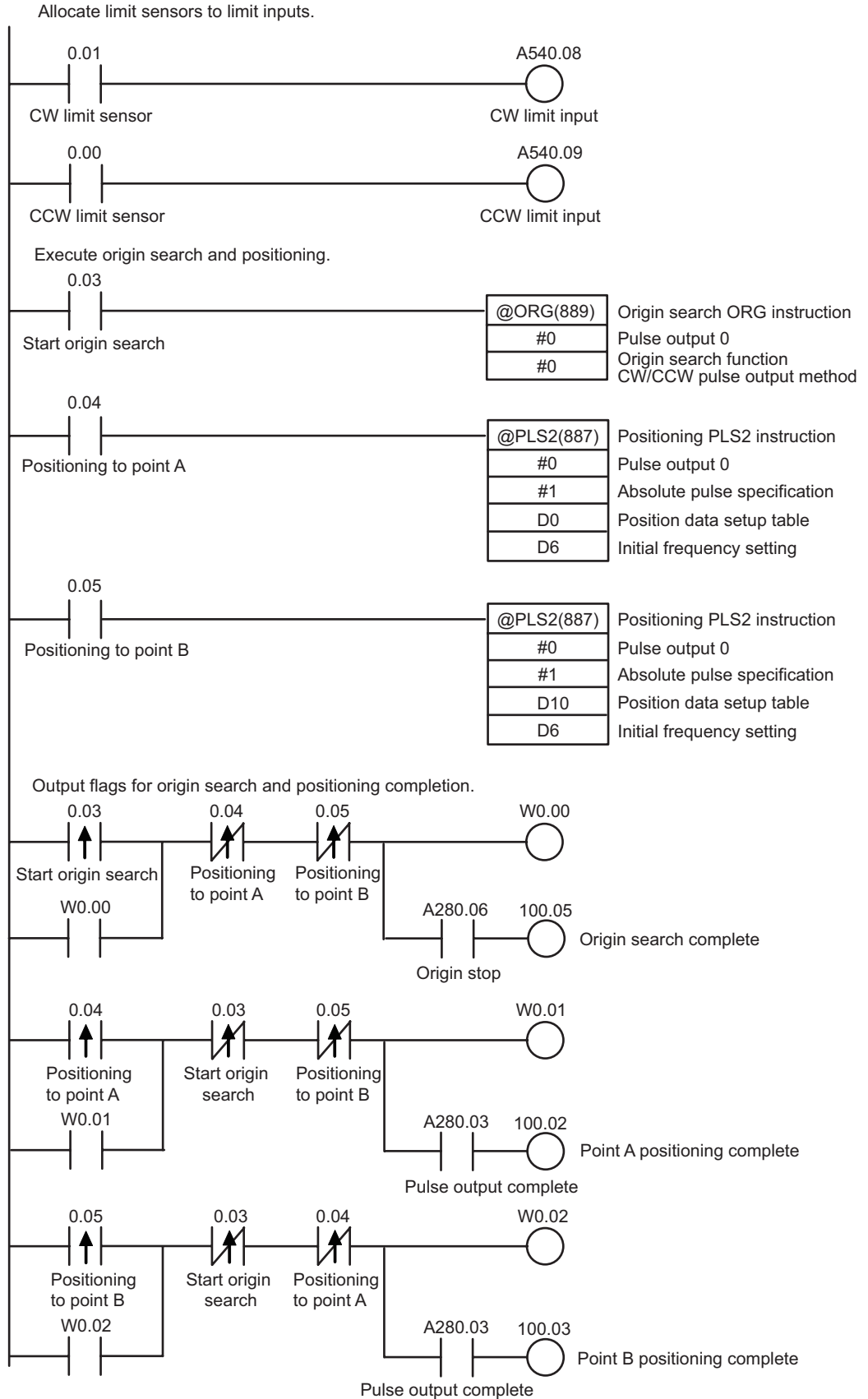

## ●DM Area Setup Example

	Address	Value	Content
Point A positioning	D0000	07D0	Acceleration ratio: 2000 (Hz/4ms)
	D0001	07D0	Deceleration ratio: 2000 (Hz/4ms)
	D0002	C350	Target frequency: 50000 (Hz)
	D0003	0000	
	D0004	FC18	Pulse output volume: -1000 (Hz)
	D0005	FFFF	
Initial frequency	D0006	0000	Initial frequency: 0 (Hz)
	D0007	0000	
Point B positioning	D0010	07D0	Acceleration ratio: 2000 (Hz/4ms)
	D0011	07D0	Deceleration ratio: 2000 (Hz/4ms)
	D0012	C350	Target frequency: 50000 (Hz)
	D0013	0000	
	D0014	86A0	Pulse output volume: 100000 (Hz)
	D0015	0001	

## A-4-7 Using Inverters for Speed Control (1)

### ■ Functions Used

#### ● Modbus-RTU Easy Master Function

By using Modbus-RTU easy master function, Modbus-compliant slave devices (i.e. inverters) can be controlled easily via serial communication.

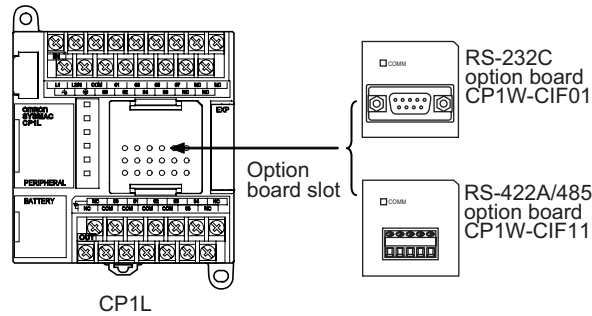

To perform serial communication on CP1L, install an optional serial communication board (RS232C or RS422A/485). 14/20-point I/O units can have 1 optional serial communication board installed. 30/40-point I/O units can have up to 2 boards installed.

The Modbus-RTU easy master function allows for easy communication with components connected via a serial connection board.

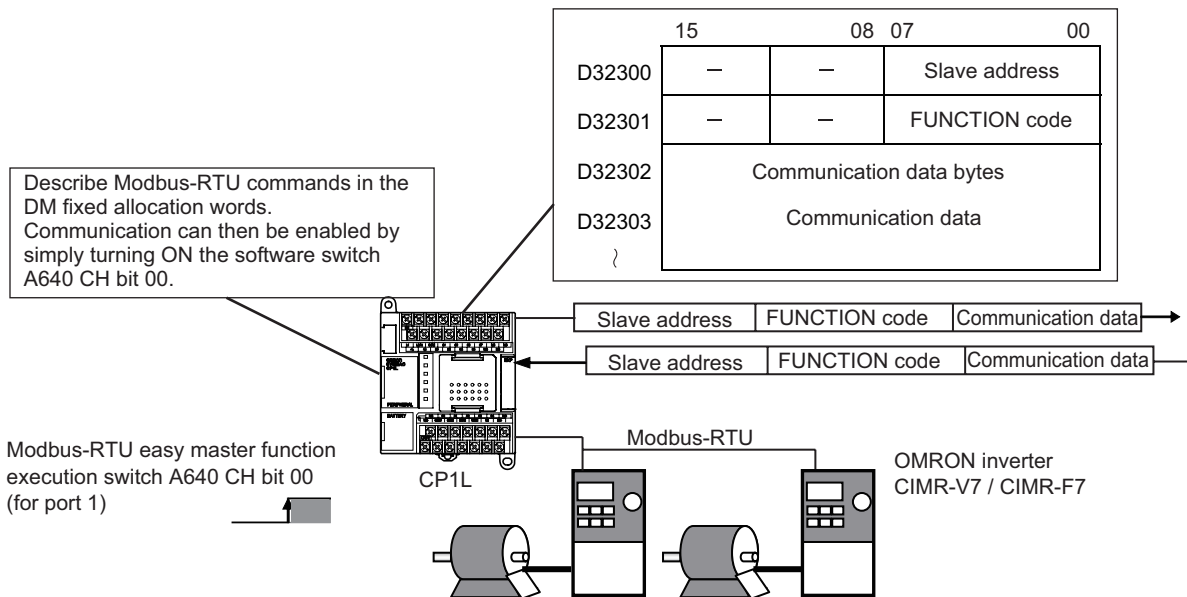

In the DM fixed allocation words for Modbus-RTU easy master, allocate the slave address, function, and data to the Modbus slave device. After the allocations have been made, Modbus-RTU commands can be sent by turning the software switch ON. Received responses are automatically stored in the DM fixed allocation words.

**Note** Modbus-RTU easy master execution bits and DM Fixed Allocation words depend on unit type, 14/20-point I/O units or 30/40-point I/O units. For details, refer to *CP Series CP1L CPU Unit User's Manual (W462)*.



### ■ Operation Overview

A bobbin winder on a spinning machine will be used for in the following example. The rotation speed of the bobbin winder must be made variable as the thread is wound, so that the speed at which the thread is pulled stays constant.

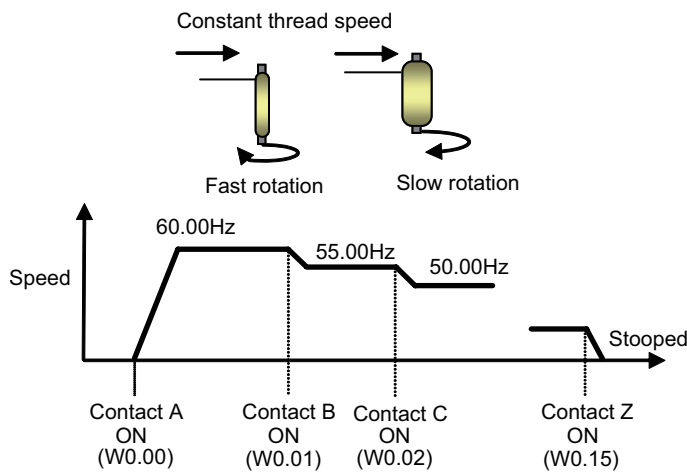
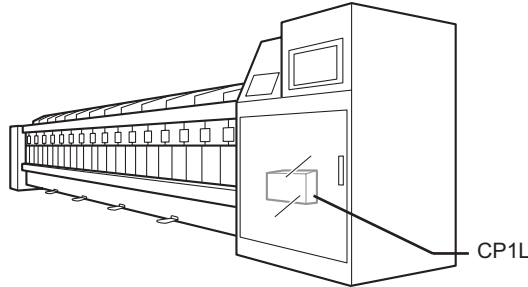

The target speed is achieved based on input from multiple contacts. Acceleration and deceleration is modified by the acceleration and deceleration of an inverter.

### ■ System Configuration

CP1L and CIMR-V7 (an OMRON inverter) are connected by RS485 for frequency and start/stop control.

#### ●Wiring Example

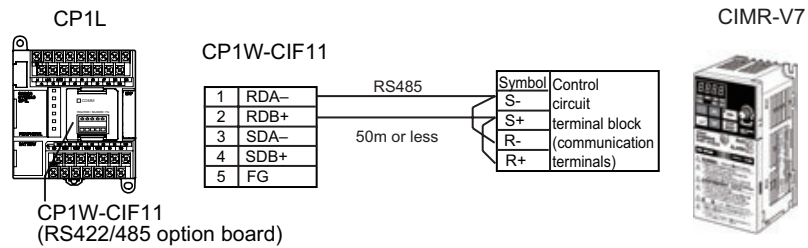

## ●CP1W-CIF11 Setup

Set the DIP switches as follows.

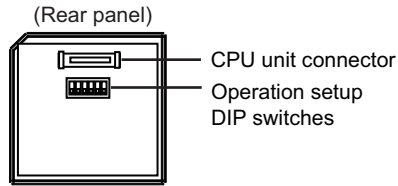

No.	Setting	ON/OFF	Content
1	Presence of terminating resistance	ON	Terminating resistance present
2	2/4-wire selection	ON	2-wire type
3	2/4-wire selection	ON	2-wire type
4	-	OFF	Always OFF
5	RS control for RD	ON	Enabled
6	SD control for RD	ON	Enabled

## ●CIMR-V7 Setup

Set the DIP switches as follows.

- SW2-1: ON (terminating resistance present) Terminating resistance for RS422/485 communication

Next, set the parameters as follows:

No.	Name	Value	Comments
n003	Operation command	2	RS-422/485 communication enabled
n004	Frequency command	6	Frequency commands from RS-422/485 communication enabled
n019	Acceleration time 1	5.0	Acceleration time (sec)
n020	Deceleration time 1	5.0	Deceleration time (sec)
n151	RS-422/485 communication Timeout detection	1	Detection enabled, detect errors, stop deceleration after deceleration time 1 (Default)
n152	RS-422/485 communication Frequency commands and monitoring	1	Select unit for communication of frequency commands data and frequency monitoring data. Unit: 0.01Hz (Default).
n153	RS-422/485 communication Slave address	1	Slave address (slave node number), unit 1
n154	RS-422/485 communication Baud rate	2	Communication baud rate (communication speed): 9600bps (Default)
n155	RS-422/485 communication Parity	0	Even parity
n156	RS-422/485 communication Transmission wait time	10	Sets the response wait time for request messages received from the master. 10ms (Default).
n157	RS-422/485 communication RTS control	0	RTS control enabled (Default)

## ● PLC Setup

Configure serial port 1.

1. **Open the PLC Settings dialog box.**
2. **Click the Serial Port 1 tab.**
3. **Set the following settings.**

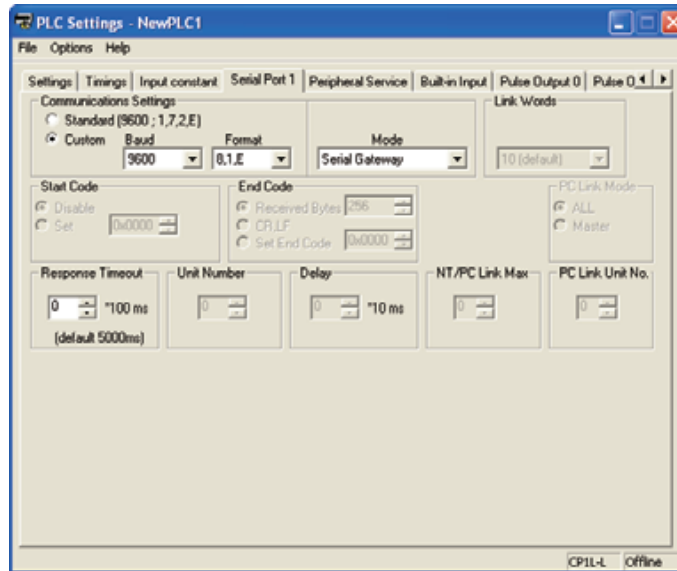

Item	Setting
Communication Settings	Custom
Baud	9600bps
Format	8, 1, E
Mode	Serial Gateway Mode
Response Timeout	0 (Default)

4. **Close the PLC Settings dialog box.**

■ Programming Example  
 ● Ladder Program

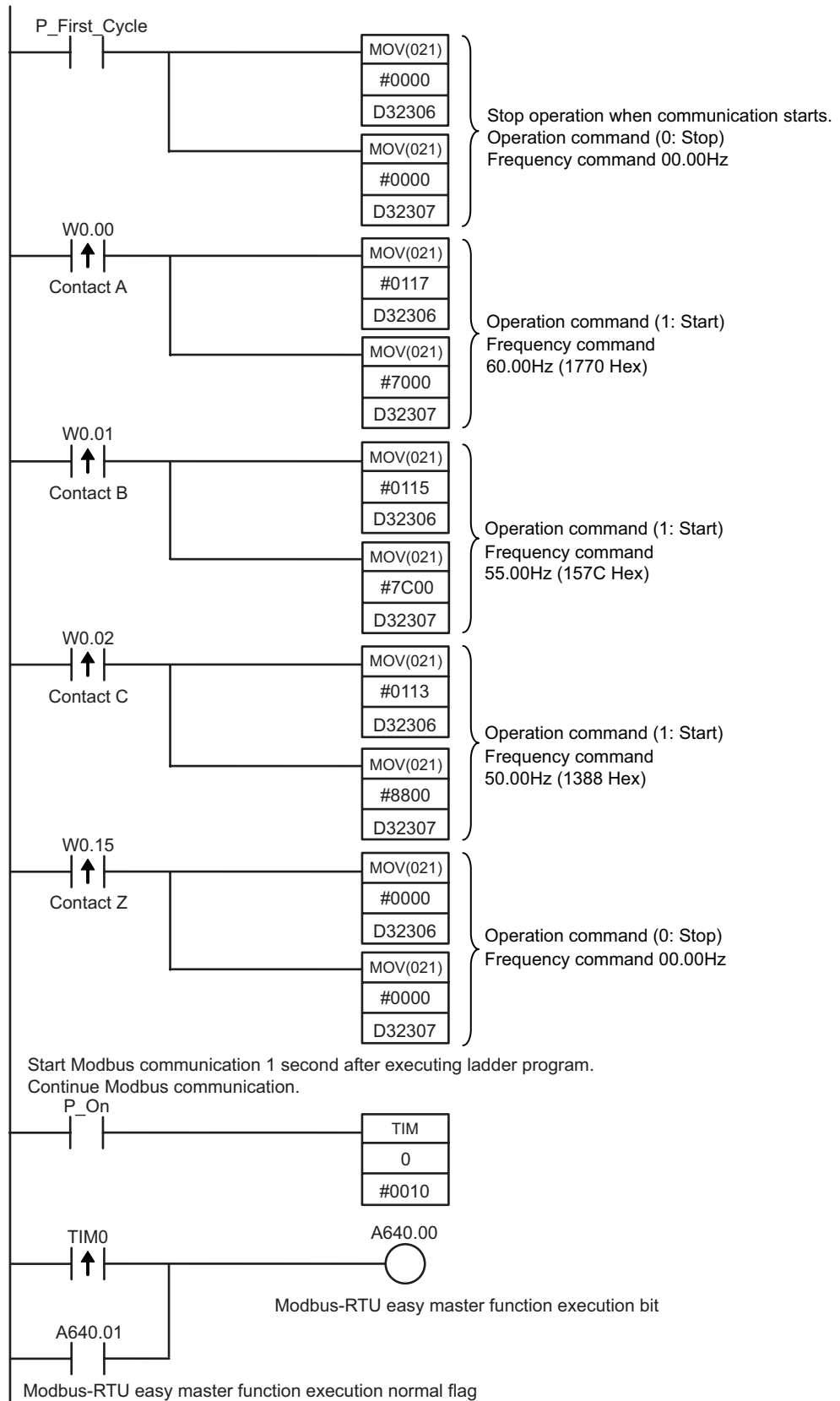

●Flags for Modbus-RTU Easy Master Function (Serial Port 1)

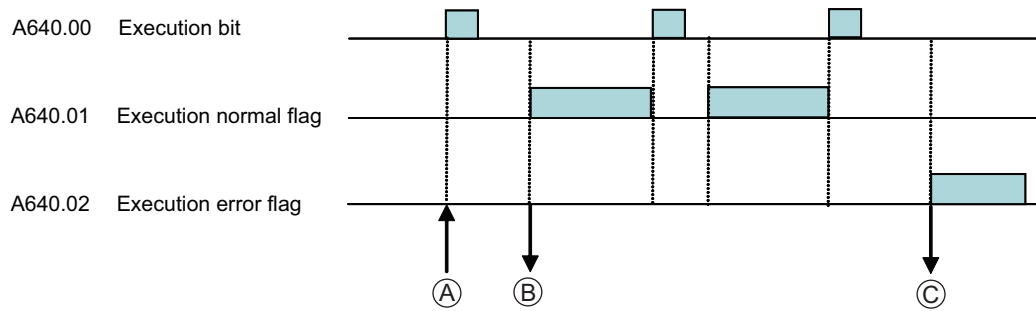

(A): Turn the A640.00 execution flag ON to send command data D32300 and later. For details, refer to *DM Area Setup* on the next page.

Channel	Bits	Setting	
Serial Port 1			
D32300	07 to 00	Command	Slave address (00 to F7 Hex)
	15 to 08		Reserved (must be 00 Hex)
D32301	07 to 00		FUNCTION code
	15 to 08		Reserved (must be 00 Hex)
D32302	15 to 00		Number of communication data bytes (0000 to 005E hex)
D32303 to D32349	15 to 00		Communication data (max. 94bytes)

(B): When a command has been sent successfully, A640.01 execution normal flag is turned ON, and data is stored to responses D32350 and later.

Channel	Bits	Setting	
Serial Port 1			
D32350	07 to 00	Response	Slave address (01 to F7 Hex)
	15 to 08		Reserved (must be 00 Hex)
D32351	07 to 00		FUNCTION code
	15 to 08		Reserved
D32352	07 to 00		Error code
	15 to 08		Reserved (must be 00 Hex)
D32353	15 to 00	Number of response bytes (0000 to 03EA Hex)	
D32354 to D32399	15 to 00	Response data (max. 92bytes)	

(C): When a communication error occurs, A640.02 execution error flag is turned ON, and the error code is stored to D32352.

●DM Area Setup

- DM Fixed Allocation Words for Modbus-RTU Easy Master

DM settings from D32300 to D32305 are set before the execution of the ladder program.

D32306 and D32307 do not need to be set explicitly. They are modified by MOV instructions, and are used to change, start, and stop frequency commands.

Serial Port 1: Command

Setting	Slave address	FUNCTION code	Communication data bytes	Communication data: D32303 to Max. D32349				
Address	D32300	D32301	D32302	D32303	D32304	D32305	D32306	D32307
Value	00 01	00 10	00 09	00 01	00 02	04 00	01 02	58

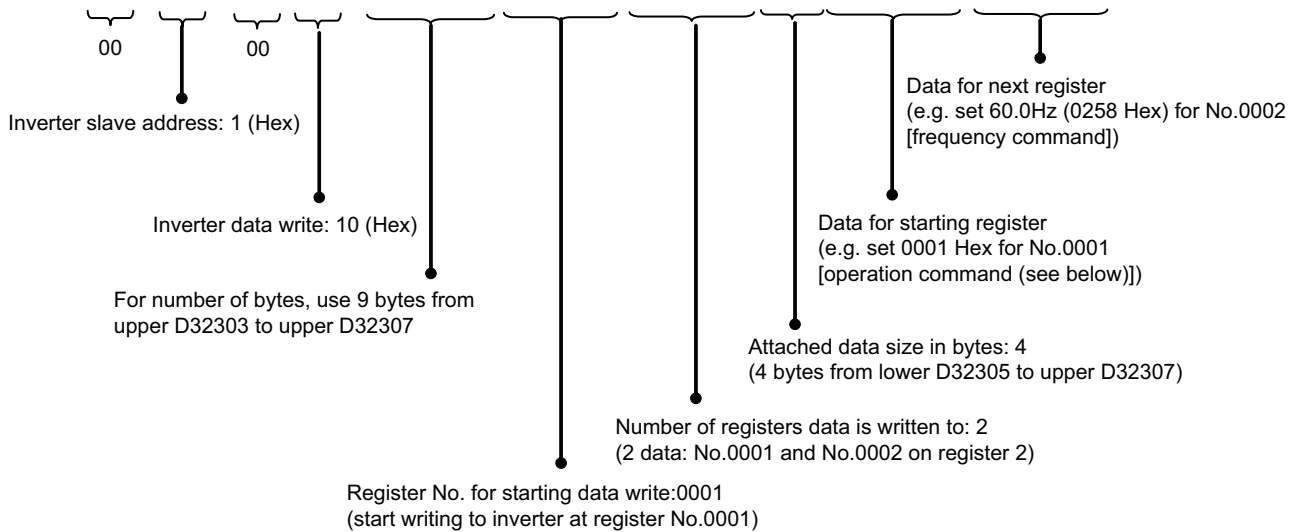

- Operation Command (Register No.0001 Hex) allocation and details for Inverter CIMR-V7

Bit No.	Setting
0	Operation command (1: Start)
1	Normal/reversed rotation (1: Reversed)
2	External error (1: EF0)
3	Error reset (1: Error reset)
4	Multifunction input 1 (1: ON)
5	Multifunction input 2 (1: ON)
6	Multifunction input 3 (1: ON)
7	Multifunction input 4 (1: ON)
8	Multifunction input 5 (1: ON)
9	Multifunction input 6 (1: ON)
10	Multifunction input 7 (1: ON)
11 to 15	(Unused)

For this example, only operation command (No.0 bit) will be used.

- With Modbus-RTU easy master function, CRC-16 checksums do not need to be set in the DM area, since they are calculated automatically.

## A-4-8 Using Inverters for Speed Control (2)

### ■ Functions Used

#### ● Smart FB Library

Smart FB Library (smart function block library) is a set of components provided by OMRON as an FB (function block). By using Smart FB Library, OMRON PLC and FA component functions can be easily used in PLC programs.

When using serial ports for communication between an inverter and a PLC, substantial knowledge of communication command specifications and communication procedures are generally required in creating the program. In such cases, Smart FB Library can be used to significantly simplify the programming process.

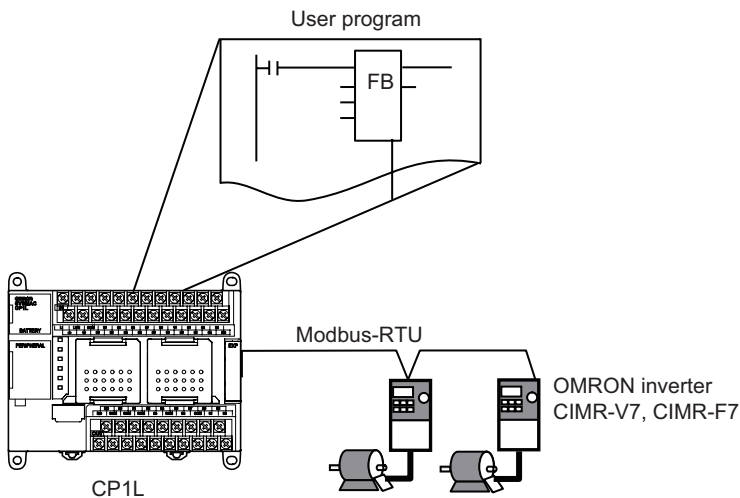

#### Smart FB Library for OMRON CIMR-V7 / CIMR-F7 Inverter

FB Name	Function Name	Function Summary
_INV002_Refresh (*)	Status refresh	Refreshes the inverter status.
_INV032_MoveVelocity_Hz (*)	Execute rotation (frequency specification in Hz)	Specifies start signal, rotation direction, and rotation speed in Hz.
_INV033_MoveVelocity_RPM	Execute rotation (rotation speed specified in rpm)	Specifies start signal, rotation direction, and rotation speed in rpm (r/min).
_INV060_Stop (*)	Decelerate to stop	Decelerates an operating axis to a stop.
_INV080_Reset	Error reset	Decelerates an operating axis to a stop.
_INV200_ReadStatus	Read status	Reads the status.
_INV201_ReadParameter	Read parameter	Reads a parameter.
_INV203_ReadAxisError	Read axis error	Reads the error information.
_INV401_WriteParameter	Write parameter	Writes parameters.
_INV600_SetComm	Set communication unit	Sets the communication settings.

\*FB used in this example.

**Note** Documentation (PDF file) on Smart FB Library functions can be found in the [FBL] - [omronlib] - [Inverter] - [INVRT] - [Serial] folder. For details on the Smart FB Library, refer to this file.

●Function Blocks

Function blocks are programming elements (templates) that group a set of processes (functions) into a single block. The user can define a function block in advance, and then use it by simply inserting it into a program and setting its I/O. Create and save standard program sections as function blocks. The function blocks can then be placed in a program, and be easily reused by simply setting the I/O parameters.

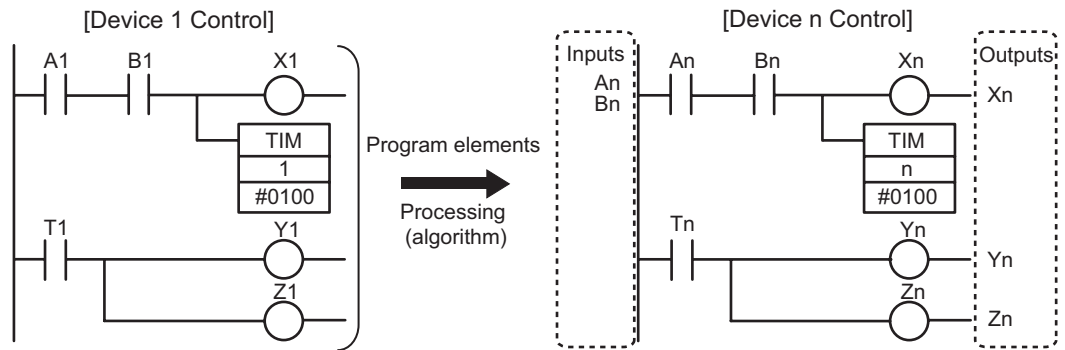

Take a ladder program for "Device 1 Control".  
 Replace the program I/Os with parameters. Save the algorithm as a template.  
 The template is defined as a function block (FB).

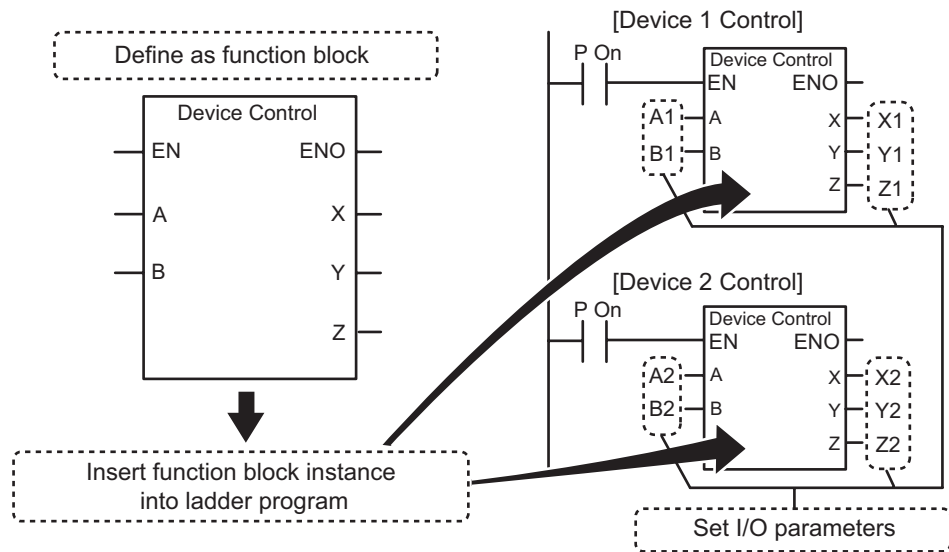

The defined function block can be used in ladder programs as function block instances.



## ■ Operation Overview

The example for *A-4-7 Using Inverters for Speed Control (1)* will be used again.

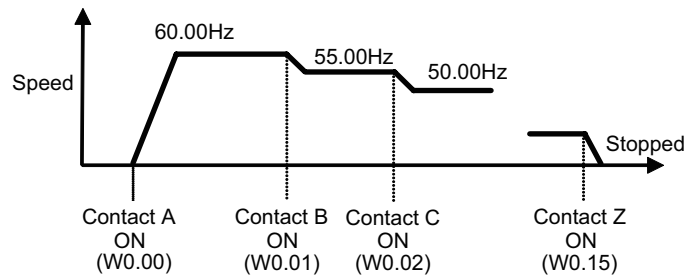

The target speed is achieved based on input from multiple contacts. Acceleration and deceleration is modified by the acceleration and deceleration of an inverter.

## ■ System Configuration

The system configuration for *A-4-7 Using Inverters for Speed Control (1)* will be used again.

CP1L and CIMR-V7 (an OMRON inverter) are connected by RS485 for frequency and start/stop control.

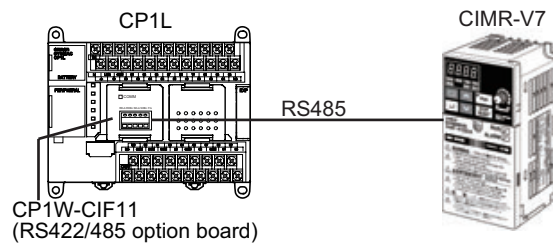

In this FB library example, capacity of the user memory may exceed 5K steps.

For this reason, since a memory capacity error may occur on a 14/20-point CP1L (with a user memory of 5K steps), use a 30/40-point CP1L (with a user memory of 10K steps) for this example

For details on wiring, and on the settings for CP1W-CIF11, CIMR-V7, and CP1L, refer to *System Configuration of A-4-7 Using Inverters for Speed Control (1)*.

■ Programming Example  
 ● Function Blocks Used

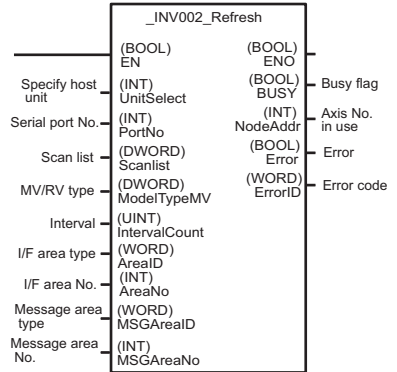
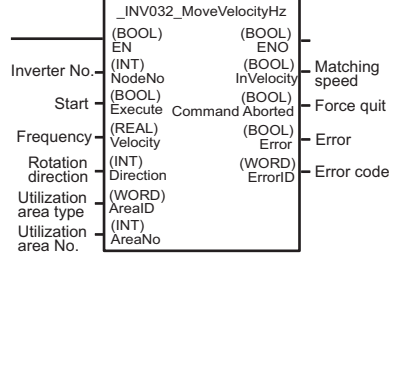
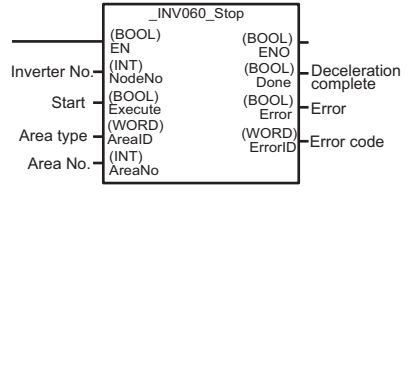
Status refresh (_INV002_Refresh)	Execute rotation (frequency specification in Hz) (_INV032_MoveVelocity_Hz)	Decelerate to stop (_INV060_Stop)
 <p>The diagram shows the _INV002_Refresh function block with the following inputs and outputs:</p> <ul style="list-style-type: none"> <li><b>Inputs:</b> Specify host unit (BOOL), Serial port No. (INT), Scan list (DWORD), MV/RV type (DWORD), Interval (UINT), I/F area type (WORD), I/F area No. (INT), Message area type (WORD), Message area No. (INT).</li> <li><b>Outputs:</b> Busy flag (BOOL), Axis No. in use (INT), Error (BOOL), Error code (WORD).</li> </ul>	 <p>The diagram shows the _INV032_MoveVelocityHz function block with the following inputs and outputs:</p> <ul style="list-style-type: none"> <li><b>Inputs:</b> Inverter No. (INT), Start (BOOL), Frequency (REAL), Rotation direction (INT), Utilization area type (WORD), Utilization area No. (INT).</li> <li><b>Outputs:</b> Matching speed (BOOL), Force quit (BOOL), Error (BOOL), Error code (WORD).</li> </ul>	 <p>The diagram shows the _INV060_Stop function block with the following inputs and outputs:</p> <ul style="list-style-type: none"> <li><b>Inputs:</b> Inverter No. (INT), Start (BOOL), Area type (WORD), Area No. (INT).</li> <li><b>Outputs:</b> Deceleration complete (BOOL), Error (BOOL), Error code (WORD).</li> </ul>
<p>Required for communication with the inverter.                      1 FB is used for each PLC serial port.                      1 "Status refresh" FB will be used for a serial port, even if the serial port has multiple inverters connected.</p> <ul style="list-style-type: none"> <li>• Issues communication commands to inverters.</li> <li>• Processes communication errors.</li> <li>• Assigns priorities when multiple commands are issued.</li> </ul>	<p>Specifies start signal, rotation direction, and frequency in Hz.</p>	<p>Decelerates an operating axis to a stop.</p>

● Ladder Program

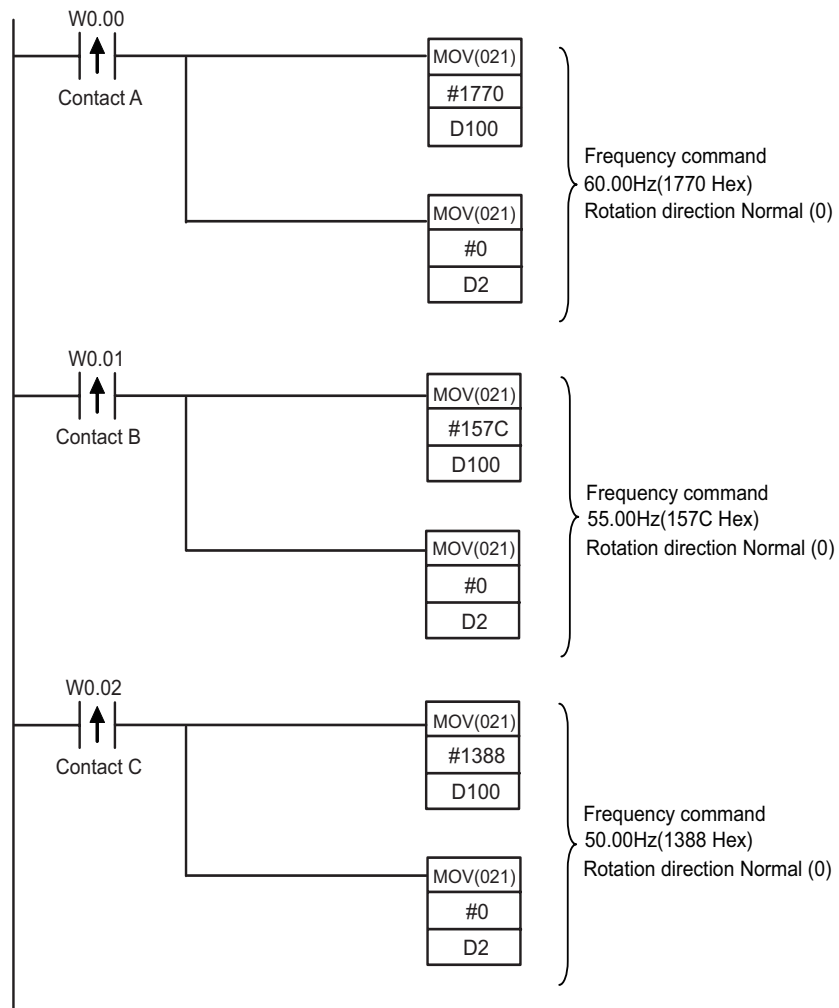

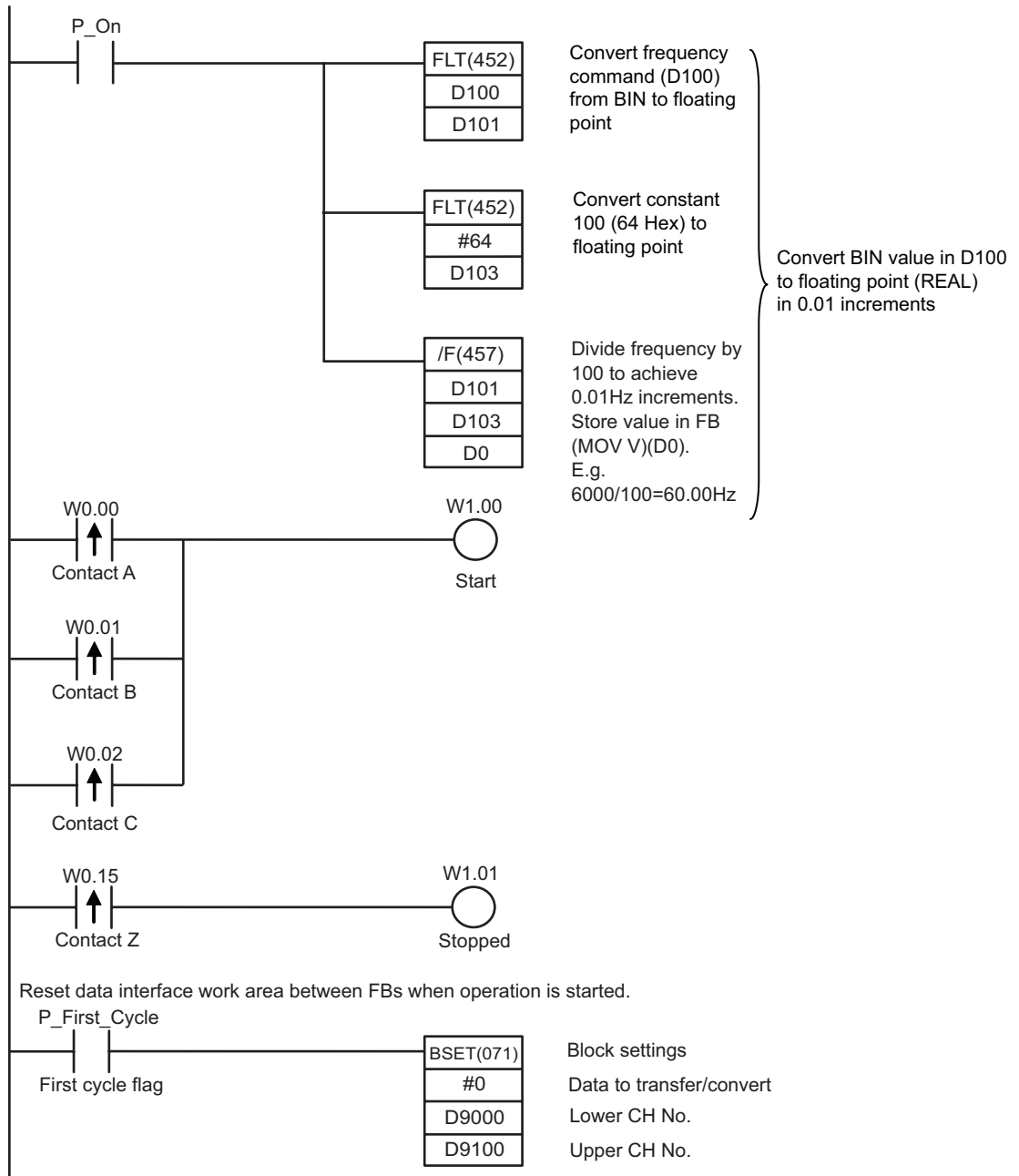

**Note** For floating point data, secure regions for 2CH.

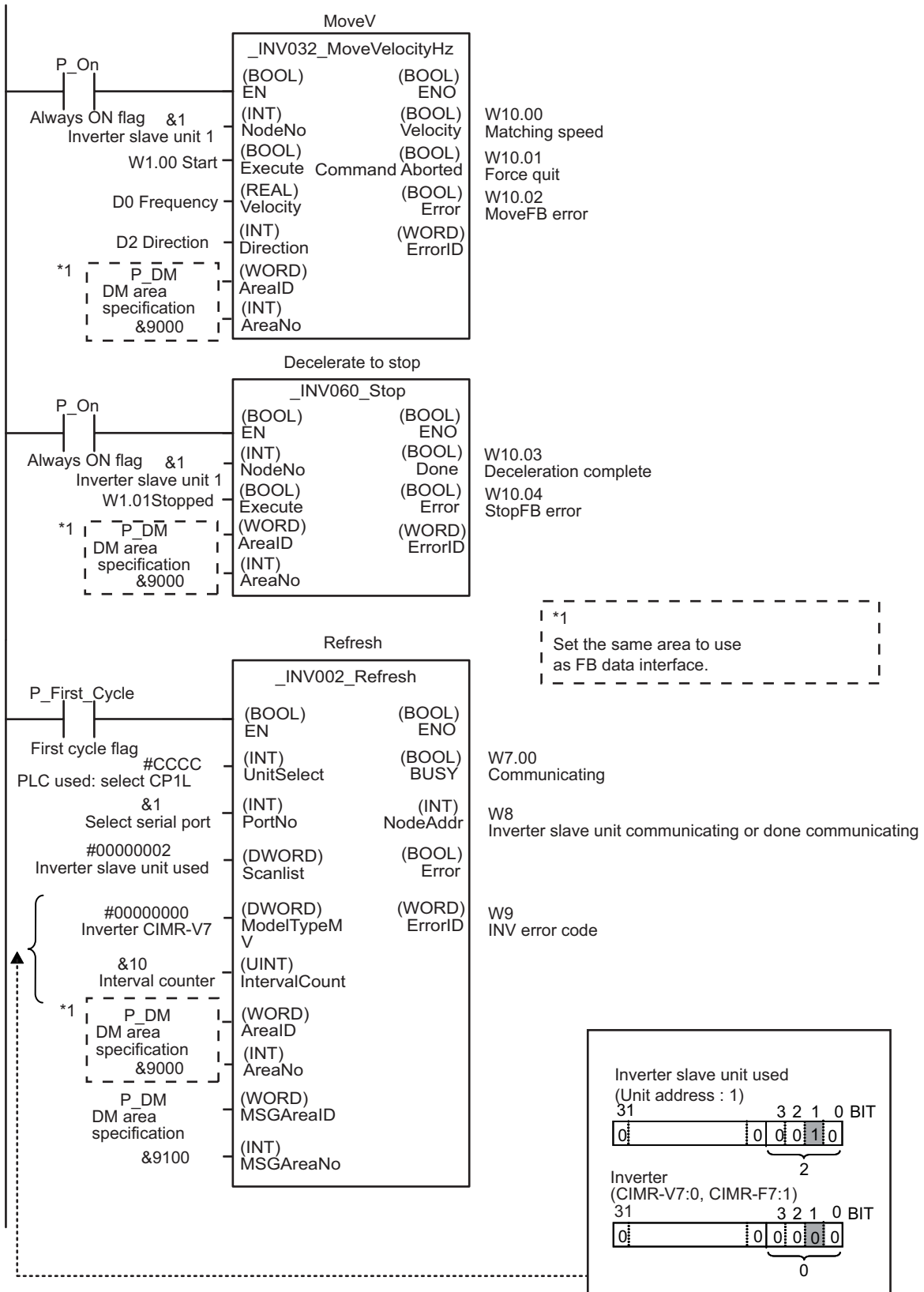

## ■ INFO

### ● Using Smart FB Library

E.g. Reading "\_INV002\_Refresh12".

1. **Select [File] - [Function Block] - [Load Function Block from File] from the main menu.**

The Select CX-Programmer Function Block Library File dialog box will be displayed.

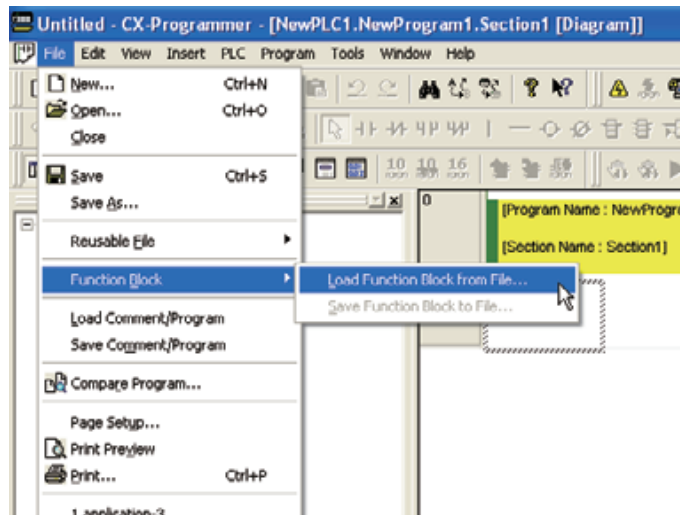

2. **Select the [FBL] - [omronlib] - [Inverter] - [INVRT] - [Serial] folder.**  
A list of FB library files for serial communication with inverters will be displayed.

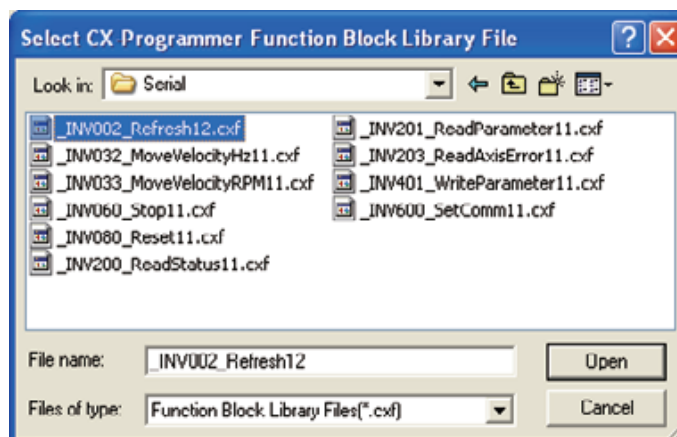

3. **Select [\_INV002\_Refresh12.cxf]. Click [Open].**  
\_INV002\_Refresh is added under [Function Blocks] in the project tree.

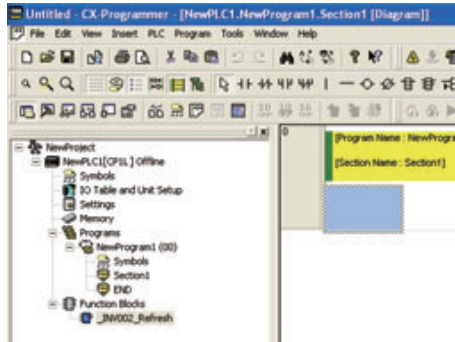

4. **Place the cursor at the position where the \_INV002\_Refresh FB is to be inserted.**
5. **Select [Insert] - [Function Block Invocation] from the main menu.**

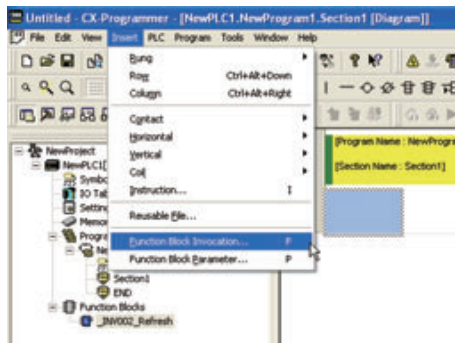

The New Function Block Invocation dialog box will be displayed.

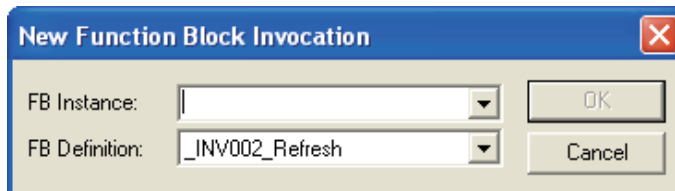

6. **Input a name for FB Instance. Press the [Enter] key.**  
The named FB instance will be displayed.

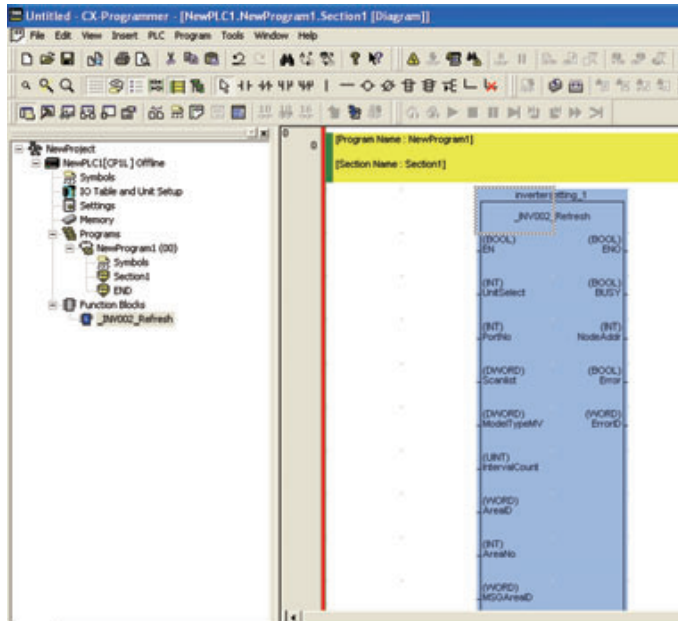

7. **Connect an input contact to the FB.**
8. **Set the I/O parameters for the FB.**
- 1) Place the cursor next to an FB parameter. Press the [Enter] key.  
The New Parameter dialog box will be displayed.
  - 2) Input the parameter. Press the [Enter] key.

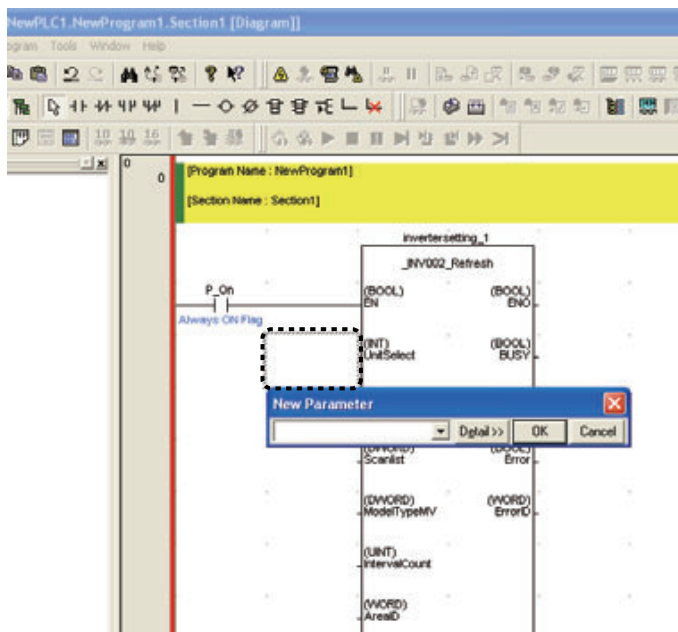



## A-4-9 Exchanging Data between CP1Ls

### ■ Functions Used

#### ● Simple PLC Link

By using RS-422A/485 option boards, up to 10CH of data per CPU unit can be shared by as many as 9 CP1L/CP1H/CJ1M units, without the aid of a program.

### ■ Operation Overview

Current temperature information is exchanged by boilers.

This setup may be used to adjust boiler temperatures according to the other boiler conditions, or to monitor the boilers from a single location.

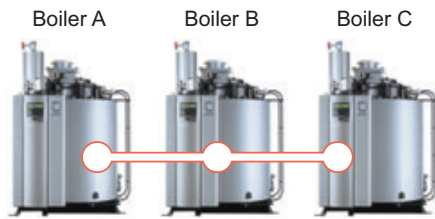

### ■ System Configuration

#### ● Wiring Example

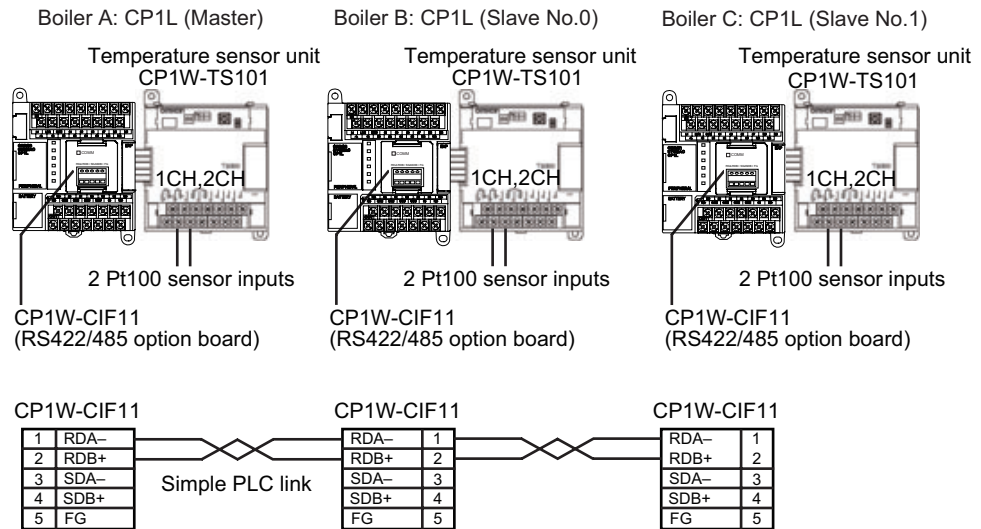

●DIP Switch Setup for CP1W-CIF11 (RS422/485 Option Board)

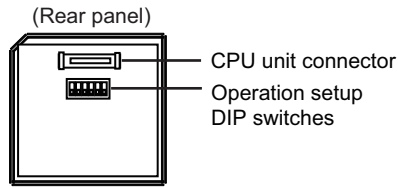

No.	Setting	Master	Slave No.0	Slave No.1	Content
1	Presence of terminating resistance	ON	OFF	ON	Terminating resistance present for PLCs at the ends.
2	2/4-wire selection	ON	ON	ON	2-wire type
3	2/4-wire selection	ON	ON	ON	2-wire type
4	-	OFF	OFF	OFF	Always OFF
5	RS control for RD	OFF	OFF	OFF	Disabled
6	SD control for RD	ON	ON	ON	Enabled

●PLC Setup

Configure serial port 1.

1. **Open the PLC Settings dialog box.**
2. **Click the Serial Port 1 tab.**
3. **Set the following settings.**

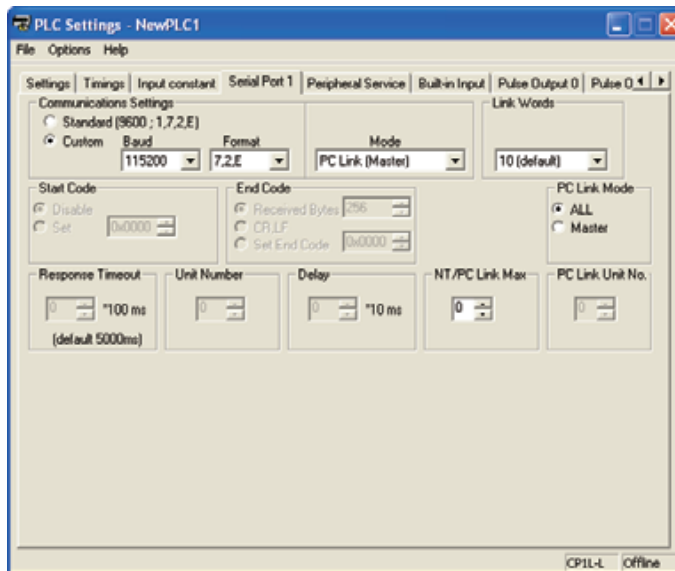

Item	Boiler A (Master)	Boiler B (Slave No.0)	Boiler C (Slave No.1)
Communication Settings	Custom		
Baud	115200bps		
Format	7.2.E (Default)		
Mode	PLC Link (Master)	PLC Link (Slave)	
Link Words	10 (Default)	-	-
PLC Link Mode	Complete Link Method	-	-
NT/PLC Link Max	0 (Default)	-	-
PLC Link Unit No.	-	0	1

4. Close the PLC Settings dialog box.

■ Programming Example

Serial PLC links are used for program-free linking of data in the serial PLC link areas. The ladder program transfers the data to be linked to the data link area.

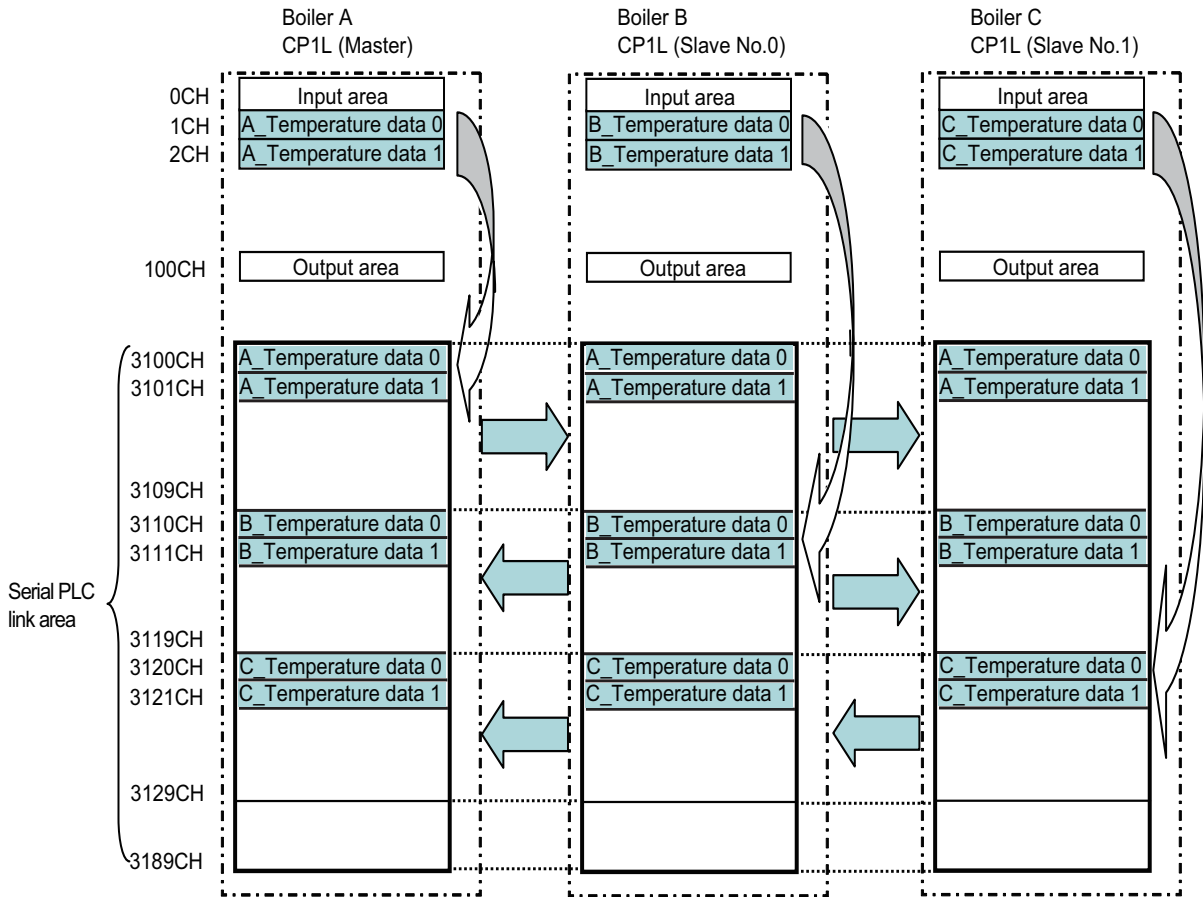

● Ladder Program

Boiler A  
CP1L (Master)

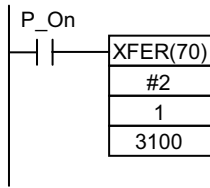

Use block transfer instruction to transfer 1CH, 2CH to 3100CH, 3101CH

Boiler B  
CP1L (Slave No.0)

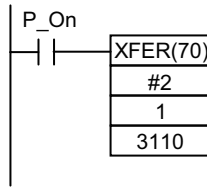

Use block transfer instruction to transfer 1CH, 2CH to 3110CH, 3111CH

Boiler C  
CP1L (Slave No.1)

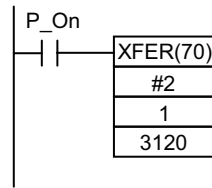

Use block transfer instruction to transfer 1CH, 2CH to 3120CH, 3121CH

# A

## Appendix

# Index

	Numerics		external analog settings input . . . . .	15, 114
20-point I/O unit . . . . .		13	external dimension . . . . .	30
30-point I/O unit . . . . .		13		
40-point I/O unit . . . . .		14		
	A			
address reference tool . . . . .		90		
analog adjuster . . . . .		15, 116		
auxiliary area . . . . .		66		
	B			
basic I/O processing instruction . . . . .		102		
battery . . . . .		15		
battery-free operation . . . . .		36		
built-in flash memory . . . . .		106		
built-in I/O area . . . . .		109		
	C			
calendar timer . . . . .		127		
changing timer setting . . . . .		90		
channel . . . . .		96		
clock . . . . .		79		
clock pulse . . . . .		99		
closed contact . . . . .		58		
compile . . . . .		70		
condition flag . . . . .		98		
connecting CX-Programmer and CP1L .		39		
connecting to a computer . . . . .		40		
connection line . . . . .		76		
contact . . . . .		56		
counter instruction . . . . .		63		
CPU unit . . . . .		14, 105		
CX-Programmer . . . . .		38		
cycle time . . . . .		93, 94, 111		
cyclic refreshing . . . . .		108		
	D			
data memory (DM) . . . . .		15		
debug . . . . .		85		
deleting contacts and coils . . . . .		75		
device type . . . . .		53		
diagram workspace . . . . .		48, 49		
differentiated up contact . . . . .		68		
DIN track . . . . .		30		
DIP switch . . . . .		15		
	E			
editing rung . . . . .		75		
END instruction . . . . .		69		
error . . . . .		17		
expansion unit . . . . .		16		
			external analog settings input . . . . .	15, 114
			external dimension . . . . .	30
			F	
			first cycle flag . . . . .	66
			force-set/force-reset . . . . .	88
			function block . . . . .	151
			G	
			going online . . . . .	78
			H	
			help . . . . .	50
			high-speed counter . . . . .	132
			I	
			I/O allocation . . . . .	24
			I/O area . . . . .	100
			I/O comment . . . . .	73
			I/O comment bar . . . . .	48
			I/O refreshing . . . . .	108
			information window . . . . .	49
			inputting contact . . . . .	56
			inputting output coil . . . . .	59
			instruction . . . . .	51, 101
			instructions reference . . . . .	51
			interlock . . . . .	44
			interrupt function . . . . .	121
			L	
			ladder backtracking . . . . .	92
			ladder program . . . . .	44, 46
			loading program . . . . .	72
			M	
			main menu . . . . .	48
			main window . . . . .	48
			Modbus-RTU easy master function . . .	143
			monitoring . . . . .	85
			mounting CP1L . . . . .	31
			O	
			online editing . . . . .	93
			operating mode . . . . .	80
			operation indicator . . . . .	17
			option board . . . . .	16
			OR circuit . . . . .	57
			P	
			peripheral service . . . . .	110
			PLC link . . . . .	160

---

## Index

---

PLC setup . . . . . 106, 119  
power supply voltage. . . . . 32  
precautions . . . . . 9  
program check. . . . . 70  
programming . . . . . 38  
project . . . . . 53  
project tree . . . . . 48  
project workspace . . . . . 48  
pulse signal . . . . . 137

### Q

quick-response input . . . . . 117

### R

relay. . . . . 96  
relay number . . . . . 96  
rung comment . . . . . 74  
rung header. . . . . 49

### S

saving program . . . . . 71  
scan time . . . . . 118, 121  
search . . . . . 90  
section . . . . . 48  
serial communication. . . . . 143  
setting the clock. . . . . 79  
Smart FB Library . . . . . 150  
special instruction . . . . . 101  
starting CX-Programmer . . . . . 47

### T

test run . . . . . 85  
timer instruction. . . . . 61  
title bar. . . . . 48  
toolbar . . . . . 48  
transferring program . . . . . 82  
turning power on . . . . . 35

### U

USB driver. . . . . 40  
USB port . . . . . 15

### W

watch window . . . . . 87  
wiring ground line . . . . . 32  
wiring input . . . . . 34  
wiring output . . . . . 34  
wiring power line . . . . . 32  
writing relay coil. . . . . 103