

NT-series RS-232C/RS422 Interface Unit

Operation Manual

Produced October 1993

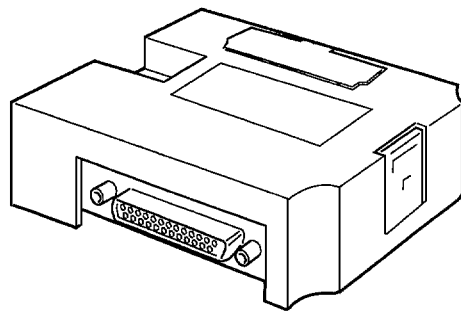

Notice:

OMRON products are manufactured for use according to proper procedures by a qualified operator and only for the purposes described in this manual.

The following conventions are used to indicate and classify precautions in this manual. Always heed the information provided with them. Failure to heed precautions can result in injury to people or damage to the product.

DANGER! Indicates information that, if not heeded, is likely to result in loss of life or serious injury.

WARNING Indicates information that, if not heeded, could possibly result in loss of life or serious injury.

Caution Indicates information that, if not heeded, could result in relative serious or minor injury, damage to the product, or faulty operation.

OMRON Product References

All OMRON products are capitalized in this manual. The word "Unit" is also capitalized when it refers to an OMRON product, regardless of whether or not it appears in the proper name of the product.

The abbreviation "Ch," which appears in some displays and on some OMRON products, often means "word" and is abbreviated "Wd" in documentation in this sense.

The abbreviation "PC" means Programmable Controller and is not used as an abbreviation for anything else.

Visual Aids

The following headings appear in the left column of the manual to help you locate different types of information.

Note Indicates information of particular interest for efficient and convenient operation of the product.

1, 2, 3... 1. Indicates lists of one sort or another, such as procedures, checklists, etc.

© OMRON, 1993

All rights reserved. No part of this publication may be reproduced, stored in a retrieval system, or transmitted, in any form, or by any means, mechanical, electronic, photocopying, recording, or otherwise, without the prior written permission of OMRON.

No patent liability is assumed with respect to the use of the information contained herein. Moreover, because OMRON is constantly striving to improve its high-quality products, the information contained in this manual is subject to change without notice. Every precaution has been taken in the preparation of this manual. Nevertheless, OMRON assumes no responsibility for errors or omissions. Neither is any liability assumed for damages resulting from the use of the information contained in this publication.

TABLE OF CONTENTS

SECTION 1	
RS-232C/RS-422 Interface Unit	1
1-1 Getting Started	2
1-2 RS-232C/RS-422 Interface Unit	5
1-3 System Configuration	6
1-4 Before Operating	8
SECTION 2	
RS-232C Interface Unit Installation and Connection ...	11
2-1 Components	12
2-2 Installing the RS-232C Interface Unit	12
2-3 Host Connections	15
SECTION 3	
RS-422 Interface Unit Settings and Connection	17
3-1 Components	18
3-2 RS-422 Interface Unit Switch Settings	18
3-3 Host Connections	20
SECTION 4	
RS-232C/RS-422 Interface Unit Operation	23
4-1 RS-232C Interface Unit Communications	24
4-2 RS-422 Interface Unit Communications	24
4-3 Flow of Control and Notification Using Commands	26
4-4 Precautions	29
SECTION 5	
Operating Commands	31
5-1 Commands Sent by the Host Computer	32
5-2 Commands Sent by the PT	38
SECTION 6	
Terminal Commands	43
6-1 Terminal Commands	44
SECTION 7	
Online Transfer Commands	49
7-1 Commands to Start and End Online Transfer	50
7-2 Commands to Set Transfer from PT to Host Computer	50
7-3 Commands to Notify the Data Type	51
7-4 Commands to Transfer Data and Notify Results	52
7-5 Configuration of Display History Data	53
SECTION 8	
Sample Programs	55
8-1 Key to Programs	56
8-2 Program	57
SECTION 9	
Troubleshooting	65
9-1 Errors Occurring when the Power is Turned ON	66
9-2 Troubleshooting Communication Errors	66

TABLE OF CONTENTS

Appendices

A Communication Specifications	69
B RS-232C and RS-422 Connector Cables	71
C Connections Using Different Cable Types	73
D Special Characters	75
Revision History	77

About this Manual:

This manual describes the installation and operation of the NT-series RS-232C/RS422 Interface Unit and includes the sections described below.

Please read this manual carefully and be sure you understand the information provided before attempting to install and operate the NT-series RS-232C/RS422 Interface Unit.

Section 1 describes the role and operation of the RS232C/RS422 Interface Unit, and its relationship to the PT features and provides a command reference table.

Section 2 describes how to connect the RS-232C Interface Unit to the PT and the PT to the host computer.

Section 3 describes how to set the RS-422 Interface Unit and how to connect the PT to the host computer. Installation of the RS-422 Interface Unit in the PT and the PT DIP switch settings are identical to the RS-232C Interface Unit.

Section 4 describes RS-232C/RS-422 Interface Unit communication procedures and how to use the commands.

Section 5 describes the functions of the operating commands and how to use them. The operating commands allows control of the PT by the host computer and notification of PT operations to the host computer.

Section 6 describes the functions of the terminal commands and how to use them. Terminal commands allow the display of information from the host computer as text and graphics, independently of the screens stored in the PT.

Section 7 describes the functions of the online transfer commands to transfer screen and memory table data between the host computer and PT. The commands cannot be used with PTs fitted with an EPROM or EEPROM image memory.

Section 8 provides some sample programs using the Transfer commands. Refer to these sample programs for actual information on using the commands.

Section 9 describes the cause of errors and possible remedies.

This manual also contains four **Appendices** which provide information on communication specifications, preparing RS-232C/RS422 Connector Cables, and connections using different cable types.

<p>WARNING Failure to read and understand the information provided in this manual may result in personal injury or death, damage to the product, or product failure. Please read each section in its entirety and be sure you understand the information provided in the section and related sections before attempting any of the procedures or operations given.</p>

SECTION 1

RS-232C/RS-422 Interface Unit

This section describes the role and operation of the RS-232C/RS-422 Interface Unit, and its relationship to the PT features and provides a command reference table.

1-1	Getting Started	2
1-2	RS-232C/RS-422 Interface Unit	5
1-3	System Configuration	6
1-4	Before Operating	8

1-1 Getting Started

To ensure that the RS-232C/RS-422 Interface Unit works correctly, carefully observe the following when positioning and handling it.

Location

Do not install the RS-232C/RS-422 Interface Unit in a location subject to the following conditions:

- Dust, chemicals, or steam
- Severe temperature fluctuations
- High humidity and condensation
- Direct sunlight
- Strong electrical or magnetic fields
- Poor ventilation
- Severe vibration

Handling

Do not:

- Subject the Unit to strong shocks or vibrations
- Position the Unit's PCB downward
- Touch the Unit's PCB
- Put heavy objects on the unit
- Supply a voltage different from the specified voltage

To ensure that the RS-232C/422 Interface Unit works correctly, carefully follow the advice below on positioning and handling the unit.

System Configuration

The equipment and parts required to configure the system to use the RS-232C/RS-422 Interface Unit are shown below.

Programmable Terminal		Screen-data Memory Board/ Screen Memory	Host I/F Unit	System ROM	Support tools	Expansion I/O Unit	System Key Unit
NT20M/ NT2000M	Monochrome LCD: NT20M-DT121-V2 Touch-panel Model NT20M-DN121-V2 Without Touch-panel Model	Screen Memory SRAM/32 KB: RAM22-15 SRAM/128 KB: RAM13-10 EPROM/64 KB: ROM-KD-B EPROM/128 KB: ROM13-12B EEPROM/32 KB: EER22-20	RS-232C I/F Unit NT600M- LK201 RS-422 I/F Unit NT600M- LK202	NT20M- SMR01- E	NT20M- ZASAT- EV4: 3.5-inch (2DD) and 5.25-inch (2HD) disks	For connection to a without touch-panel model NT20M-FK210 12-key Function Key Unit	NT-FK200 for con- nection to NT2000M
	Backlit replaceable: NT20M-DT131 Touch-panel Model NT20M-DN131 Without Touch-panel Model						
	Large size: NT2000M- DT131/DN131 With- out Touch-panel Model						
NT600M	Monochrome LCD: NT600M-DT122 Touch-panel Model NT600M-DF122 Function Key Model	Screen-data Memory Board IC socket type: NT600M-MP251 64K-byte SRAM: NT600M-MR641 128K-byte SRAM: NT600M-MR151 256K-byte SRAM: NT600M-MR251 Screen Memory The screen memory chip must be inserted in the IC socket. Screen data is written with a PROM writer. EPROM/64 KB: ROM-KD-B EPROM/128 KB: ROM13-12B EEPROM/32 KB: EER22-20		NT600M- SMR01- EV1		For connection to a without touch-panel model NT600M-FK210 12-key Function Key Unit	---
	EL display: NT600M-DT211 Touch-panel Model NT600M-DN211 Without Touch-panel Model						

Table of Commands**Polling Commands**

Type	Command	Name	Page
Polling	[ESC] @	Start Polling (RS-422 I/F Unit Read)	25
	[ESC] A	End Polling (RS-422 I/F Unit Read)	25

Operating Commands

Type	Command	Name	Page
Screen control	[ESC] 0	Display Specified Screen	32
	[ESC] X	Request Screen Number	32
Memory table operation	[ESC] B	Write Character-string Memory Table	32
	[ESC] C	4-digit Write Numeral Table	33
	[ESC] D	8-digit Write Numeral Table	33
	[ESC] /	Copy Memory Table	33
Lamp and Touch Switch Display	[ESC] K	Lamp and Touch Switch Display (Bit Specification)	34
	[ESC] Q	Lamp and Touch Switch Display (Address Specification)	34
	[ESC] R	Lamp and Touch Switch Display Status Enquiry	35
Touch Switch and Function Key Input	[ESC] U	Touch Switch and Function Key Disable	35
	[ESC] V	Touch Switch and Function Key Enable	35
System Control	[ESC] O	Backlight Color Switching (NT20M, NT2000M)	36
	[ESC] P	Screen Display Control	36
	[ESC] T	Buzzer Control	36
	[ESC] W	Mode Switch Enable	36
	[ESC] Z	PT Battery Status Enquiry	37
	[ESC]]	Initialize Display History	37
	[ESC] ^	Alarm Output Control	37
	[ESC] _	Display Mode Control (NT600M-D_122 Read)	37
Notification	[ESC] Y	Screen Number Response	38
	[ESC] E	4-digit Number Input Notify	38
	[ESC] F	8-digit Number Input Notify	38
	[ESC] G	Function Key Number Output	39
	[ESC] H	Touch Switch Number Output	39
	[ESC] I	Function Key Bit Output	39
	[ESC] J	Touch Switch Bit Output	40
	[ESC] S	Lamp/Touch Switch Display Status Response	40
	[ESC] [PT Battery Status Response	41

Terminal Commands

Type	Command	Name	Page
Delete	[ESC] &	Clear Screen	44
Character Size	[ESC])	Character Specify Size	44
	[ESC] *	Specify Character Enlargement	44
Character Display Attributes	[ESC] !	Normal Display	45
	[ESC] ”	Set Inverse Display	45
	[ESC] #	End Inverse Display	45
	[ESC] \$	Set Flashing Display	45
	[ESC] %	End Flashing Display	46
Character String Display	[ESC] +	Set Cursor Position	46
	[ESC] 4	Specify Displayed Characters	46
Graphic Display	[ESC] 7	Draw Polyline	47
	[ESC] 8	Draw Circle	47

Online Transfer Commands

Type	Command	Name	Page
Start/Stop Online Transfer	[ESC] x	Online Transfer Start	50
	[ESC] y	Online Transfer End	50
Set Transfer from PT to Host Computer	[ESC] s	Specify Transfer Screen Number (Host Computer to PT)	50
	[ESC] u	Specify Transfer Non-screen Data (Host Computer to PT)	51
Data Type Notification	[ESC] r	Transfer Screen Number Notify (PT to Host Computer)	51
	[ESC] t	Transfer Non-screen Data Notify (PT to Host Computer)	52
Data Transfer and Result Notification	[ESC] z	Transfer Data	52
	[ESC] }	Acknowledged	52
	[ESC] ~	Not-acknowledged	53

Note The commands are only applicable to NT20M or NT600M PTs fitted with SRAM memory.

1-2 RS-232C/RS-422 Interface Unit

The RS-232C/RS-422 Interface Unit supports three command types for control of the PT by the host computer.

Operating Commands

Commands for control of the PT display, status, and notification during run operation. The commands write screen displays and data, and make enquiries. The commands notify the host computer of operations at the PT.

Terminal Commands

Commands for use of the PT as a terminal for the host computer. The commands allow display of information from the host computer as text and graphics, independently of the screens stored in the PT. The commands are used to handle unforeseen events.

Online Transfer Commands

Commands for transfer of screen and memory table data between the host computer and PT.

Types of data transferred:

- Screen data (1 screen/all screens)
- System memory
- Memory table data
- Mark data

- Display history data by sequence or by frequency (from PT to host computer only)

The online transfer commands allow batch data transfer which simplifies system modification and maintenance.

Main applications:

- Partial screen modification
- Screen switching when setting up a production line
- Data backup

1-3 System Configuration

The system configuration using the RS-232C Interface Unit or the RS-422 Interface Unit is shown below.

PT The PT displays monitored data from the production line and instructions to the factory workers. It notifies the host computer of switch ON/OFF settings and numeric inputs.

Host Computer Controls the PT display and status. Processes data notified by the PT.

Support Tool Creates the screens for display by the PT.

RS-232C Interface Unit System Configuration

Create a one-to-one connection between the host computer and PT when the RS-232C Interface Unit is used.

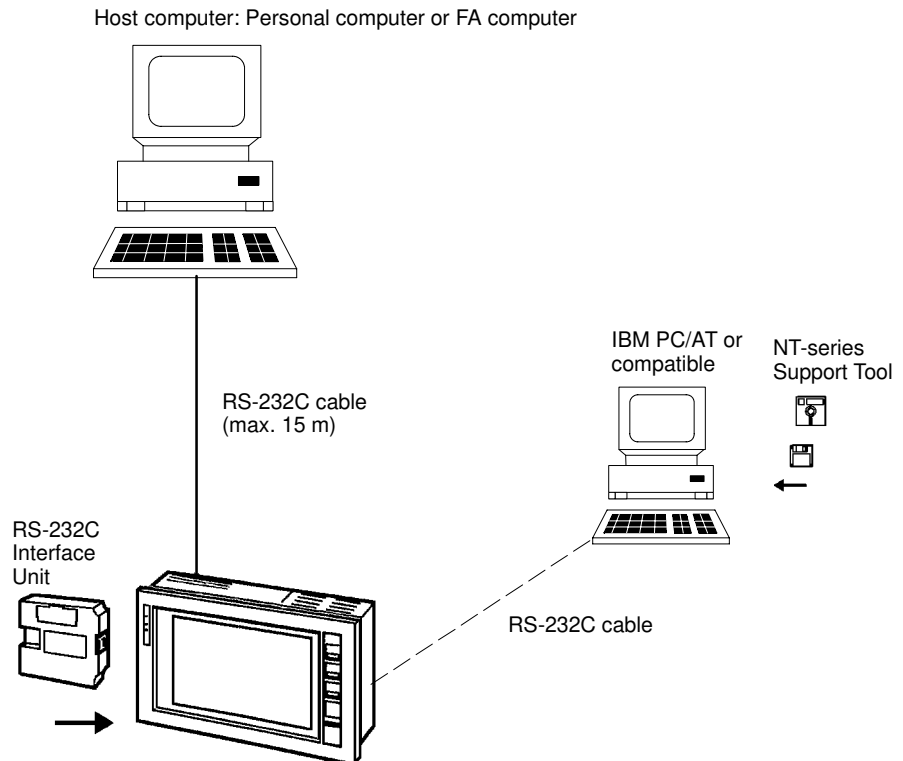

RS-422 Interface Unit System Configuration

Connect a single host computer to a maximum of 16 PTs when the RS-422 Interface Unit is used.

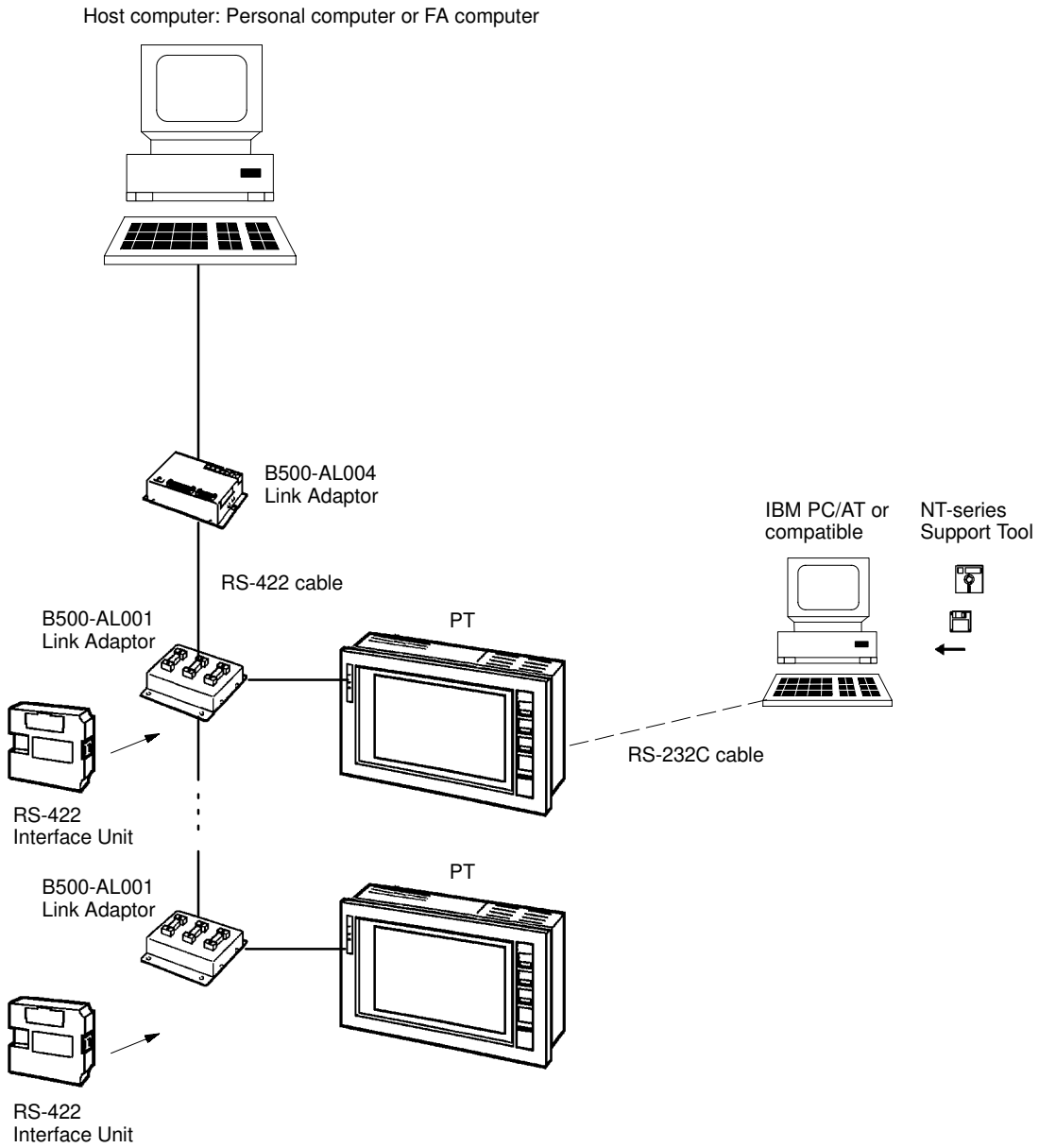

1-4 Before Operating

Follow the procedure indicated below before operating a PT with RS-232C/RS-422 Interface Unit installed.

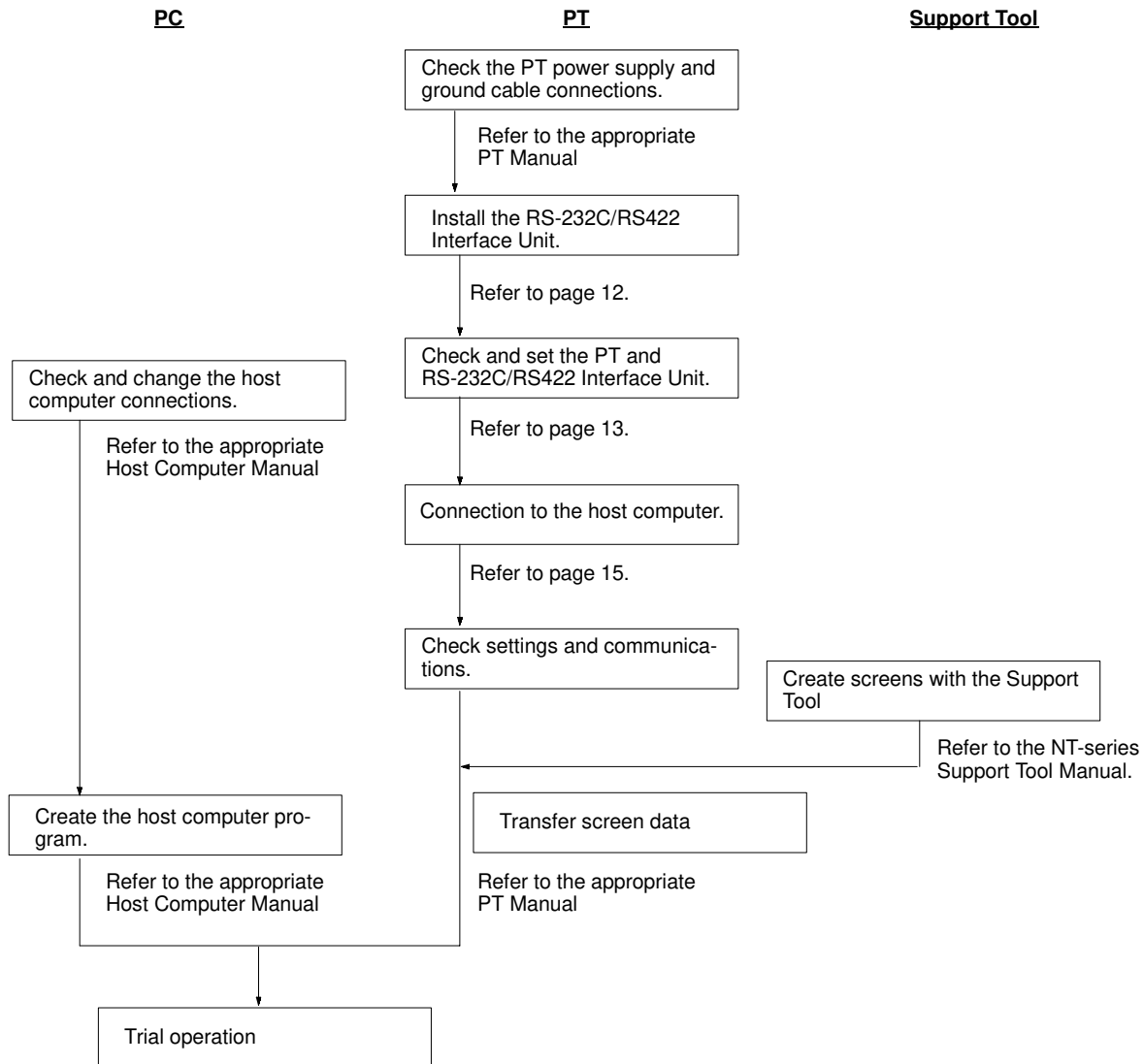

Reference Manuals

The NT20M/NT2000M Series and NT600M Series are covered in the six manuals described below.

Name of Manual	Contents	Manual No.
NT20M/NT2000M Operation Manual	This manual provides specifications, functions, and operating instructions for the NT20M and NT2000M Programmable Terminals.	V001
NT600M Operation Manual	This manual provides specifications, functions, and operating instructions for NT600M Programmable Terminals.	V002
NT-series Host Interface Unit Operation Manual	This manual covers the commands, controls, and communications specifications for operating the NT20M and the NT600M. Refer to this manual when programming host computer communications.	V003
NT20M/NT600M Support Tool Operation Manual	This manual covers methods for creating screens, including screen data preparation, switches, lights, and alarms.	V004
NT-series Host Interface Unit Direct Connection Operation Manual	This manual covers the Direct Connection feature which has been added to the Host Interface Unit.	V015
NT-series RS-232C/RS-422 Interface Unit Operation Manual	This manual covers the commands, controls, and communications specifications for operating the NT20M and the NT600M with the RS-232C/RS-422 Interface Unit. Refer to this manual when programming host computer communications.	V016

SECTION 2

RS-232C Interface Unit Installation and Connection

This section describes how to connect the RS-232C Interface Unit to the PT and the PT to the host computer.

2-1	Components	12
2-2	Installing the RS-232C Interface Unit	12
2-2-1	Installation	12
2-2-2	RS-232C Interface Unit Switch Settings	13
2-2-3	PT Switch Settings	14
2-3	Host Connections	15
2-3-1	Host Computer Communication Settings	15
2-3-2	Connector Pin Arrangement	15

2-1 Components

Before explaining how to connect the RS-232C Interface Unit to the PT, the names and functions of the RS-232C Interface Unit components are described.

Description of Components

The names and functions of the components of the RS-232C Interface Unit are shown in the diagram below.

NT600M-LK201 RS-232C Interface Unit

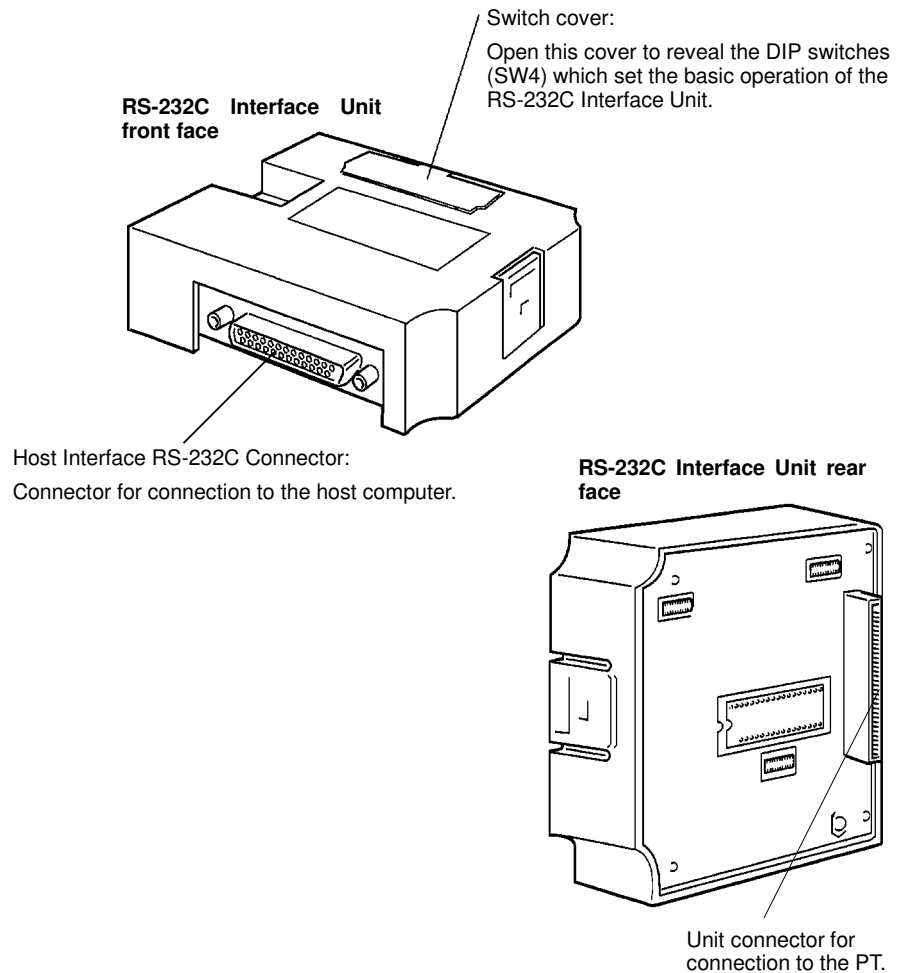

2-2 Installing the RS-232C Interface Unit

The methods of installing the RS-232C Interface Unit in the PT and setting the DIP switches are described below.

2-2-1 Installation

Turn the cut-out in the RS-232C Interface Unit to the left and push the Unit in until a "click" is heard.

In difficult-to-connect situations move the Unit when connecting the RS-232C Interface Unit.

Note Turn off the PT power supply when installing or removing the RS-232C/RS-422 Interface Unit.

Installation in the NT600M

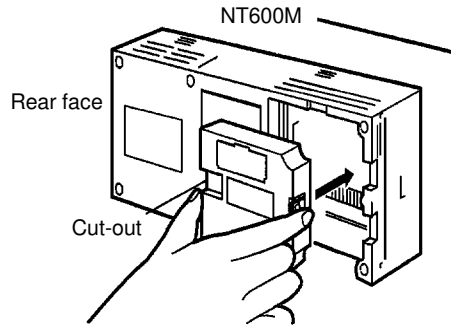

Removal from the NT600M

Hold the RS-232C/RS-422 Interface Unit by the indentations at each side, press inwards and pull out the Unit.

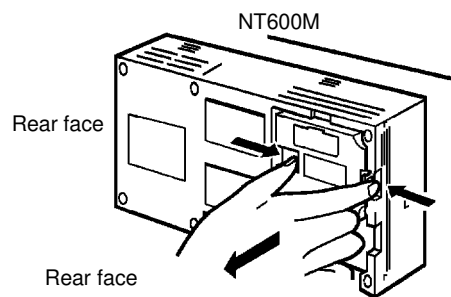

2-2-2 RS-232C Interface Unit Switch Settings

Set the communication conditions with the RS-232C Interface Unit DIP switches (SW4).

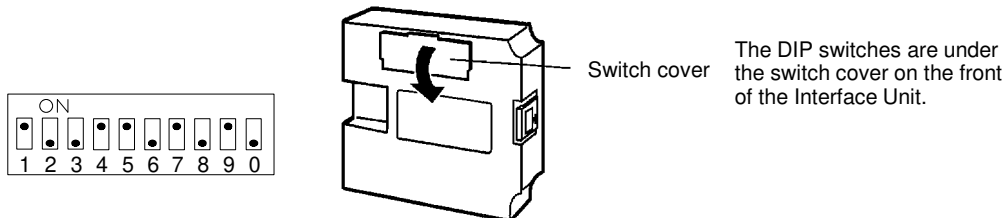

SW4-1 Data Bits

Data bits (see note following the switch settings)
ON: 8 bits, OFF: 7 bits

SW4-2 Stop Bits

Stop bits (see note following the switch settings)
ON: 1 bit, OFF: 2 bits

SW4-3/4 Parity Check

Also see note following the switch settings.

None	Even	Odd
SW4-3: ON SW4-4: ON	SW4-3: OFF SW4-4: ON	SW4-3: OFF SW4-4: OFF

SW4-5/6 Flow Control

None	RS/CS control	XON/XOFF control
SW4-5: ON SW4-6: OFF	SW4-5: OFF SW4-6: ON	SW4-5: OFF SW4-6: OFF

SW4-7/8/9 Baud Rate

Sets the PT Baud Rate

Set to the maximum baud rate supported by both the PT and the host computer. However, the baud rate must be set to the same value on both devices.

19,200 bps	9,600 bps	4,800 bps	2,400 bps	1,200 bps	600 bps	300 bps
SW4-7: ON	SW4-7: ON	SW4-7: ON	SW4-7: OFF	SW4-7: OFF	SW4-7: OFF	SW4-7: OFF
SW4-8: ON	SW4-8: OFF	SW4-8: OFF	SW4-8: ON	SW4-8: ON	SW4-8: OFF	SW4-8: OFF
SW4-9: OFF	SW4-9: ON	SW4-9: OFF	SW4-9: ON	SW4-9: OFF	SW4-9: ON	SW4-9: OFF

SW4-10 Not Used

Note Set the data, stop, parity, and baud rate bits to match one of the combinations as shown in the following.

7 data bits, Even parity, 2 stop bits	8 data bits, No parity, 2 stop bits
7 data bits, Odd parity, 2 stop bits	8 data bits, No parity, 1 stop bit
7 data bits, Even parity, 1 stop bit	8 data bits, Even parity, 1 stop bit
7 data bits, Odd parity, 1 stop bit	8 data bits, Odd parity, 1 stop bit

Caution Turn off the power supply before setting the DIP switches.

2-2-3 PT Switch Settings

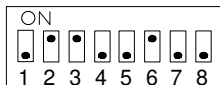
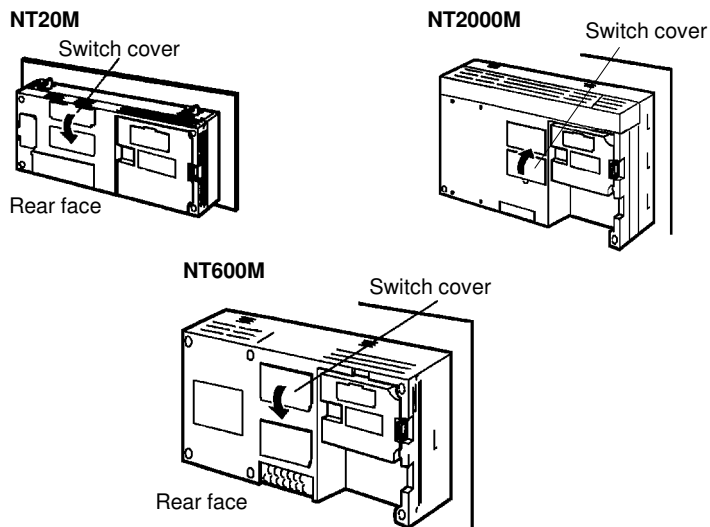

The DIP switches are under the switch cover on the rear of the PT.

SW1-1

Automatic release after communication error.

ON: No automatic release

OFF: Automatic release

SW1-2

Enable/Disable host RUN

ON: Disable

OFF: Enable

SW1-3

Reserved for system use. Always set ON.

SW1-4/5

Not used

SW1-6

Mode change Enable/Disable (NT20M/NT2000M/NT600M)

ON: Enable

OFF: Disable

SW1-7	Not used
SW1-8	Communication specification setting Always set OFF when the RS-232C Interface Unit is installed.

Note Turn off the power supply before setting the DIP switches.
SW1-8 can be set ON or OFF when the RS-422 Interface Unit is installed.

2-3 Host Connections

Connect a PT with an RS-232C Interface Unit installed to the host computer with an RS-232C cable.

RS-232C connection allows a single PT to be connected to the host.

A computer or other control device with a built-in RS-232C interface is a suitable host for connection to the PT.

2-3-1 Host Computer Communication Settings

Set the host communication conditions according to the following table.

Item	Setting
Baud rate	Set to the same baud rate as the PT: 300, 600, 1200, 2400, 4800, 9600, 19200
Data bits	7 bits/8 bits
Stop bits	1 bit/2 bits
Parity	Even, Odd, None
Flow control	RS/CS control XON/XOFF control None

Note Set the same communication conditions at the PT and host computer.

Refer to the appropriate instruction manuals for the method of setting the host computer communication conditions.

Set to the maximum baud rate supported by both the PT and host computer.

2-3-2 Connector Pin Arrangement

The RS-232C connection between the PT and host computer is described below.

RS-232C Interface Unit

The connector and cable specifications are described below.

Electrical characteristics: Conforms to EIA RS-232C specifications.

Signal direction: Signal input and output are relative to the host computer.

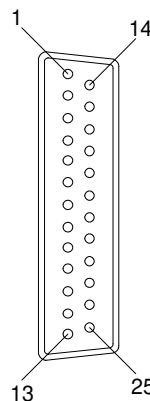

Connector pin #	Signal name	Abbreviation	Signal direction	
			Input	Output
1	Frame ground	FG	---	---
2	Send data	SD (TXD)	---	Yes
3	Receive data	RD (RXD)	Yes	---
4	Request to send	RS (RTS)	---	Yes
5	Clear to send	CS (CTS)	Yes	---
7	Signal ground	SG (GND)	---	---
14	Optical connector +5V	+5 V	---	---

- Note**
1. FG is not connected internally in the PT.
 2. Unlisted pins are not used.

Refer to *Appendix B RS-232C/RS-422 Connector Cables* for details on cable parts and wiring connections.

Connecting to the Host Computer

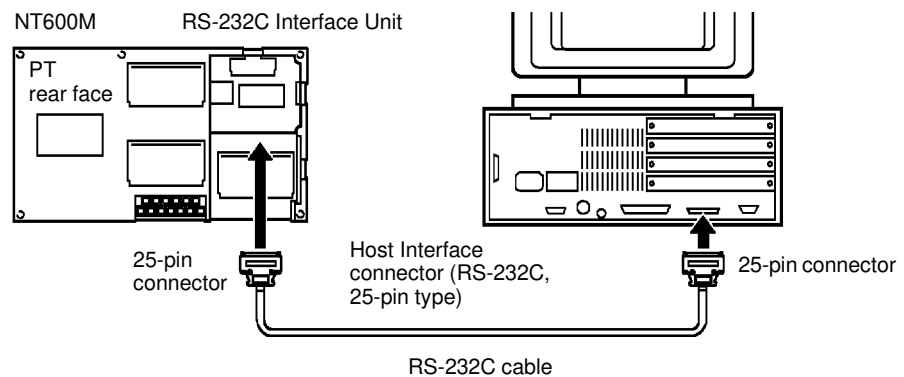

- Note** Turn off the PT power supply when connecting or disconnecting connectors.

Connection Using RS-422 or Optical-fiber Cable

In addition to RS-232C the following two other connection methods are available to connect the PT to host computer. Refer to *Appendix C Connections Using Different Cable Types* for more information on these connection methods.

RS-422

Use RS-422 connections if the PT is more than 15 m from the host computer. Communication is possible up to 500 m through a multicore shielded cable.

Optical-fiber

Optical-fiber cable connections are used in situations where unstable communication occurs because of noise problems. Communication is possible up to 500 m through optical-fiber cable.

SECTION 3

RS-422 Interface Unit Settings and Connection

This section describes how to set the RS-422 Interface Unit and how to connect the PT to the host computer. Installation of the RS-422 Interface Unit in the PT and the PT DIP switch settings are identical to the RS-232C Interface Unit. Refer to *Section 2 RS-232C Interface Unit Installation and Connection* for details.

3-1	Components	18
3-2	RS-422 Interface Unit Switch Settings	18
3-2-1	Switch Settings	18
3-2-2	RS-422 Interface Unit Terminal Number	19
3-3	Host Connections	20
3-3-1	Host Computer Communication Settings	20
3-3-2	Connector Pin Arrangement	20
3-3-3	Precautions	21

3-1 Components

Before explaining how to connect the RS-422 Interface Unit to the PT, the names and functions of the RS-422 Interface Unit Components are described.

Description of Components

The names and functions of the components of the RS-422 Interface Unit are shown in the diagram below.

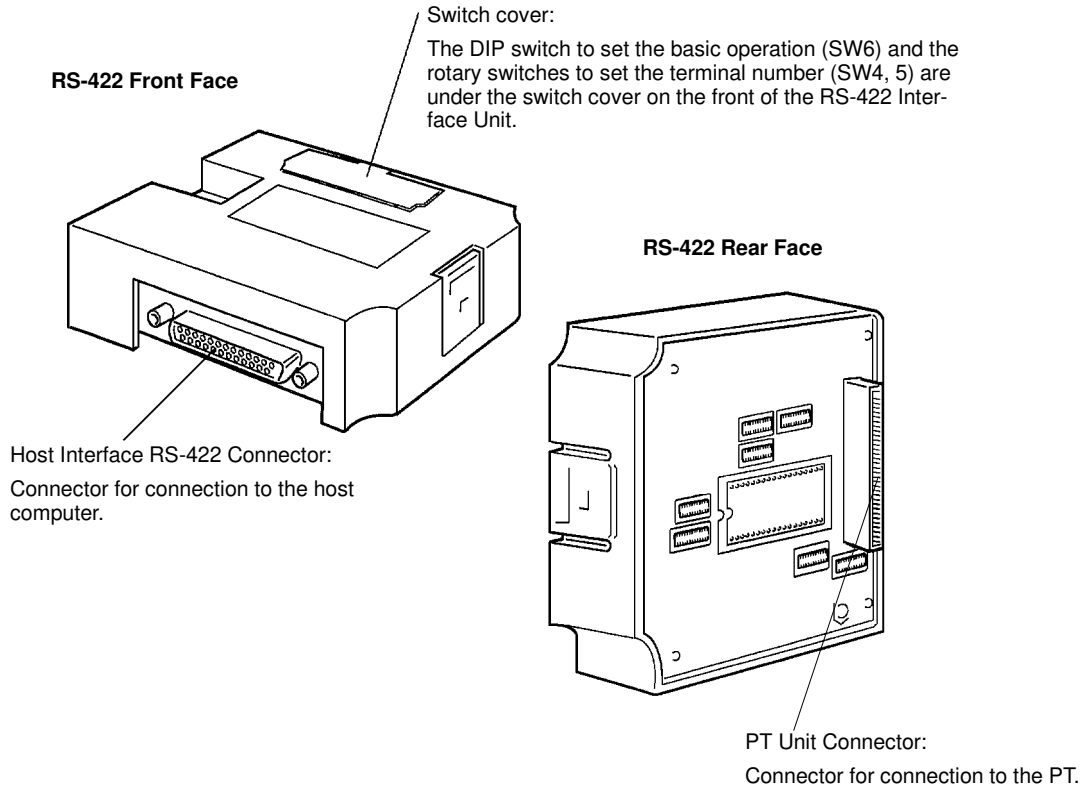

Installation of the RS-422 Interface Unit in the PT is identical to the RS-232C Interface Unit. Refer to *Section 2 RS-232C Interface Unit Installation and Connection* for details.

3-2 RS-422 Interface Unit Switch Settings

3-2-1 Switch Settings

Set the RS-422 Interface Unit rotary and DIP switches.

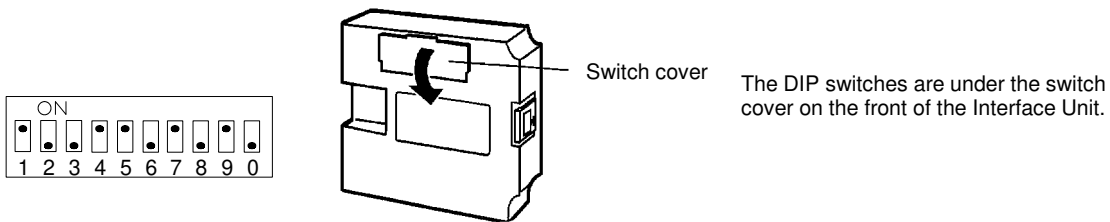

SW6-1 Data Bits

Data bits (see note below)
ON: 8 bits, OFF: 7 bits

SW6-2 Stop Bits

Stop bits (see note below)
ON: 1 bit, OFF: 2 bits

SW6-3/4 Parity Check

None	Even	Odd
SW6-3: ON SW6-4: ON	SW6-3: OFF SW6-4: ON	SW6-3: OFF SW6-4: OFF

SW6-5/6 XON/XOFF Control

ON	OFF
SW6-5: OFF SW6-6: OFF	SW6-5: ON SW6-6: OFF

SW6-7/8/9 Baud Rate

Sets the PT Baud Rate
Set to the maximum baud rate supported by both the PT and the host computer.
However, the baud rate must be set to the same value on both devices.

19,200 bps	9,600 bps	4,800 bps	2,400 bps	1,200 bps	600 bps	300 bps
SW6-7: ON SW6-8: ON SW6-9: OFF	SW6-7: ON SW6-8: OFF SW6-9: ON	SW6-7: ON SW6-8: OFF SW6-9: OFF	SW6-7: OFF SW6-8: ON SW6-9: ON	SW6-7: OFF SW6-8: ON SW6-9: OFF	SW6-7: OFF SW6-8: OFF SW6-9: ON	SW6-7: OFF SW6-8: OFF SW6-9: OFF

SW6-10 Terminal Resistance

Sets the internal 220 Ω termination resistance.
ON: Terminal resistance ON
OFF: Terminal resistance OFF

Note Set the data, stop, parity, and XON/XOFF, baud rate, and terminal resistance bits to match one of the combinations as shown in the following.

7 data bits, Even parity, 2 stop bits	8 data bits, No parity, 2 stop bits
7 data bits, Odd parity, 2 stop bits	8 data bits, No parity, 1 stop bit
7 data bits, Even parity, 1 stop bit	8 data bits, Even parity, 1 stop bit
7 data bits, Odd parity, 1 stop bit	8 data bits, Odd parity, 1 stop bit

Caution Turn off the power supply before setting the DIP switches.

3-2-2 RS-422 Interface Unit Terminal Number

One host computer can be connected to a maximum of 16 PTs with RS-422 cables. A number, called a terminal number, is allocated to identify each PT.

The PT terminal number is set with the RS-422 Interface Unit rotary switches (SW4, 5).

Set the terminal number as a decimal number between 0 and 15.

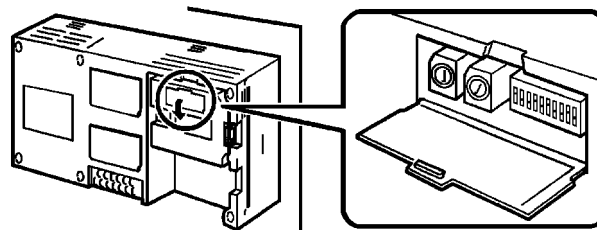

Turn the switch with a flathead screwdriver to the required number setting. Set the tens digit on switch SW4 and the Units digit on switch SW5. The terminal numbers are set independently of the order in which the PTs were connected. The numbers do not have to begin from 0 and do not have to be consecutive.

Examples

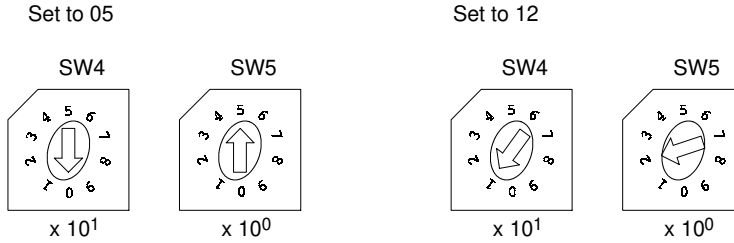

The settings of the PT DIP switches should be identical to those on the RS-232C Interface Unit. Refer to 2-2-3 PT Unit DIP Switch Settings.

3-3 Host Connections

Connect a PT with a RS-422 Interface Unit installed to the hostr with an RS-422 cable.

RS-422 connection allows a a maximum of 16 PTs to be connected to a single host.

A computer or other control device with an RS-422 interface installed is a suitable host for connection to the PT.

3-3-1 Host Computer Communication Settings

Set the host communication conditions according to the following table.

Item	Setting
Baud rate	Set to the same baud rate as the PT: 300, 600, 1200, 2400, 4800, 9600, 19200
Data bits	7 bits/8 bits
Stop bits	1 bit/2 bits
Parity	Even, Odd, None
XON/XOFF control	ON/OFF

Note Set the same communication conditions at the PT and host.

Refer to the appropriate instruction manuals for the method of setting the host computer communication conditions.

Set to the maximum baud rate supported by both the PT and host computer.

3-3-2 Connector Pin Arrangement

The connection between the PT and host with an RS-422 cable is described below.

RS-422 Interface Unit

The connector and cable specifications are described below.

Electrical characteristics: Conforms to EIA RS-422 specifications.

Signal direction: Signal input and output are relative to the host.

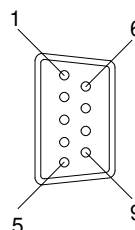

Connector pin #	Signal name	Abbreviation	Signal direction	
			Input	Output
1	Receive data (+)	RD (+)	Yes	
3	Signal ground	SG	---	---
5	Send data (+)	SD (+)		Yes
6	Receive data (-)	RD (-)	Yes	
7	Frame ground	FG	---	---
9	Send data (-)	SD (-)		Yes

- Note**
1. FG is not connected at the RS-422 Interface Unit end of the cable.
 2. Pins #2, #4, and #8 are not used.

Refer to *Appendix B RS-232C/RS-422 Connector Cables* for details on cable parts and wiring connections.

3-3-3 Precautions

Connecting the Shielding Wire to FG

Connect the FG (Pin #7) at one end only to prevent current flowing in the shielding wire, as described below.

Connecting the Link Adaptor and the PT

Connect the shielding wire to FG at the Link Adaptor end of the cable only.

Connecting the Link Adaptors Together

Connect the shielding wire to FG at any one end of the cable.

Setting the Built-in Termination Resistance

Turn ON the DIP switch (SW6-10) on the last RS-422 Interface Unit connected on the cable enable the termination resistance. Refer to *3-2 RS-422 Interface Unit Switch Settings* for information about setting the DIP switches.

Cable Lengths

The cable lengths should not exceed the following limits:

Branch wire: 10 m

Total trunk and branch wires: 500 m

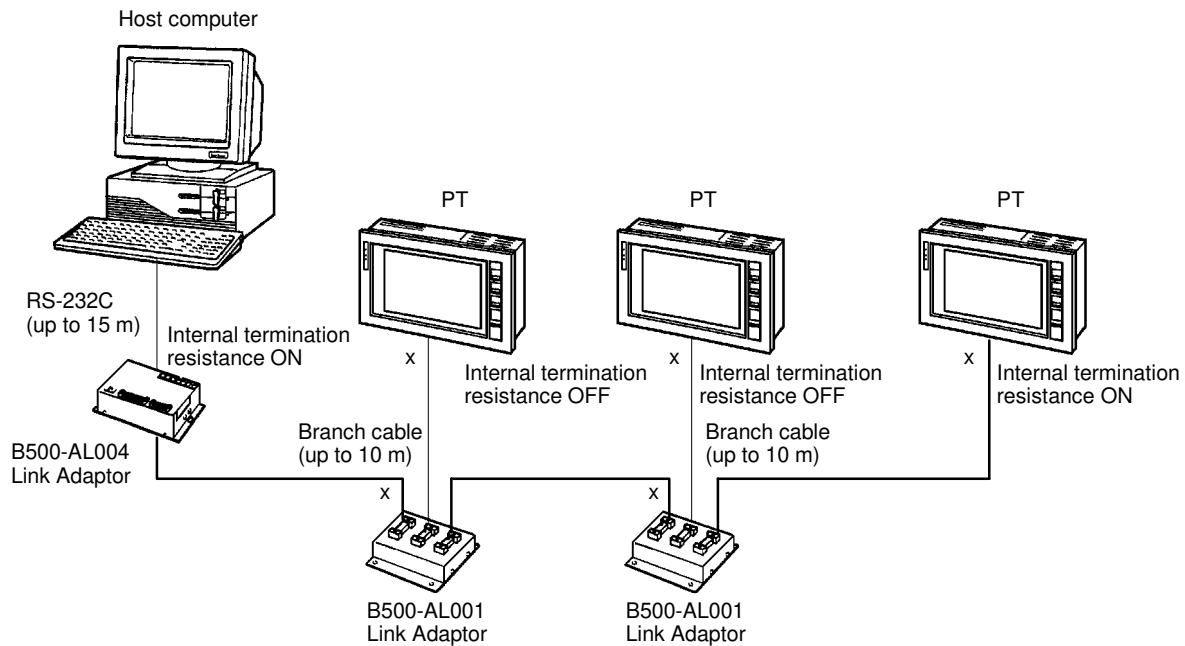

Trunk + branch cable total length up to 500 m.

- : Shield wire connected to FG
- x : Shield wire not connected to FG
- Trunk cable (RS-422)
- Branch cable (RS-422) RS-232C

Connection Using RS-232C or Optical-fiber Cable

In addition to RS-422 the following two other connection methods are available to connect the PT to host computer. Connection through a B500-AL004(-P) Link Adaptor allows connection to the RS-232C connector of a host computer.

Refer to *Appendix C Connections Using Different Cable Types* for more information on these connection methods.

RS-232C

Use for connection to a host computer with a RS-232C connector.

Optical-fiber

Optical-fiber cable connections are used in situations where unstable communication occurs because of noise problems. Communication is possible up to 500 m through optical-fiber cable.

SECTION 4

RS-232C/RS-422 Interface Unit Operation

This section describes RS-232C/RS-422 Interface Unit communication procedures and how to use the commands.

4-1	RS-232C Interface Unit Communications	24
4-1-1	Communication Procedure	24
4-2	RS-422 Interface Unit Communications	24
4-2-1	Communication Procedure	24
4-2-2	Polling Procedure	25
4-3	Flow of Control and Notification Using Commands	26
4-3-1	Operating Commands	26
4-3-2	Terminal Commands	26
4-3-3	Online Transfer Commands	26
4-4	Precautions	29

4-1 RS-232C Interface Unit Communications

The communication procedure through the RS-232C circuit and the program flow using examples in BASIC are described below.

4-1-1 Communication Procedure

The host computer and PT communicate according to the following procedure.

- 1, 2, 3... 1. The RS-232C circuit must be opened (i.e., communication enabled) before communication can start.
2. Commands are used to control the PT and to receive notification from the PT.
3. Close the RS-232C circuit again after communication is complete.

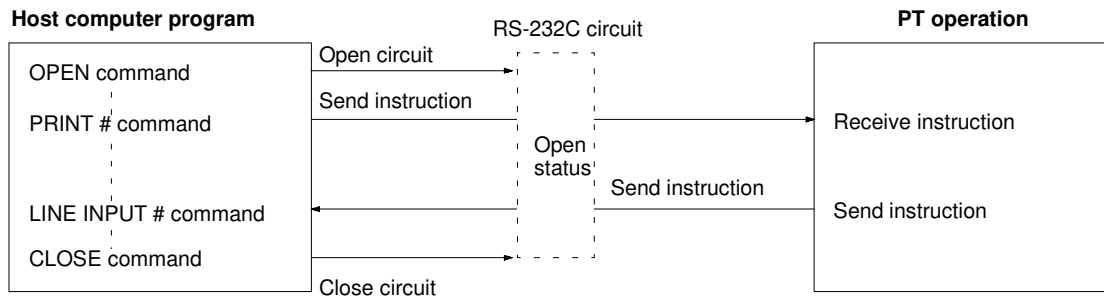

After a circuit has been opened, it can be used until it is closed again.

OPEN

Opens the RS-232C circuit. The host computer communication conditions are also set. Refer to 2-3-1 *Setting the Host Computer Communication Conditions*.

PRINT

Sends an instruction via the RS-232C circuit to the PT.

LINE INPUT

Receives a command from the PT. This command is used because commands from the PT are not delimited by commas or double-quotation marks.

CLOSE

Closes the RS-232C circuit.

Refer to the host computer's BASIC Manual for more details about the commands.

4-2 RS-422 Interface Unit Communications

The communication procedure through the RS-422 circuit and the program flow using examples in BASIC are described below.

4-2-1 Communication Procedure

The RS-422 Interface Unit permits attachment of multiple PTs, so that the object PT must be specified before communication of commands. This object PT specification is known as polling.

The host computer and PT communicate according to the following procedure.

- 1, 2, 3... 1. The RS-422 circuit must be opened (i.e., communication enabled) before communication can commence.
2. Send the Start Polling command to the communication object PT to report that communication is started.
3. Commands are used to control the PT and for notification from the PT.
4. To change the object PT during communication, first send the End Polling command to the communicating PT before sending the Start Polling command to the next object PT.

- Before closing the RS-422 circuit at the end of communication, send the End Polling command to the communicating PT to report that communication is ended.

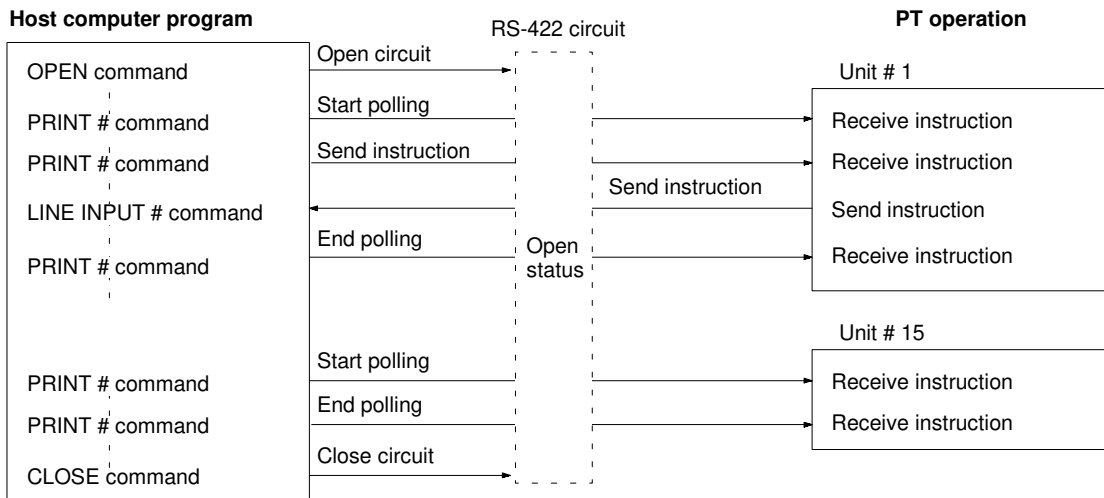

After a circuit has been opened, it can be used until it is closed again. Refer to 4-1 RS-232C Interface Unit Communications for details about the commands.

4-2-2 Polling Procedure

To communicate with the RS-422 Interface Unit, the communication circuit is opened before the polling commands are used.

If a touch switch is pressed or the screen changed on a non-pollled PT, the host computer is not notified until start of communication is indicated with the Start Polling command.

The polling command must be used before commencing communication even when only a single PT is connected to the host computer.

When a PT is polled after a long time, the notify data stored up to that time is sent continuously.

Start Polling Command

This command notifies the PT with the specified terminal number that communication has started. Refer to 3-2-2 RS-422 Interface Unit Terminal Number for details about setting the terminal number.

Format

n_1, n_2 : terminal number 00 to 15 (2-digit decimal)

[ESC]	@	n_1		n_2
1B	40	* *	* *	

Example

PRINT #1,CHR\$ (&H1B);"@05"

End Polling Command

This command notifies the the communicating PT that communication has ended. To switch PTs during communication, first send the End Polling command to the communicating PT before sending the Start Polling command to the next PT.

Format

[ESC]	A
1B	41

Example PRINT #1,CHR\$(&H1B);"A"

4-3 Flow of Control and Notification Using Commands

The flow of control and notification to and from the PT using commands is described below.

Refer to the following sections for information on how to use each command:

Section 5 Operating Commands

Section 6 Terminal Commands

Section 7 Online Transfer Commands

4-3-1 Operating Commands

The operating commands display monitored data from the production line and messages to the factory workers. They are also used for PT control and management.

The communication flow between the host computer and PT differs according to the following three cases:

Message from Host Computer to PT

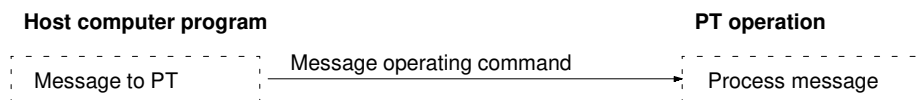

Enquiry from Host Computer to PT

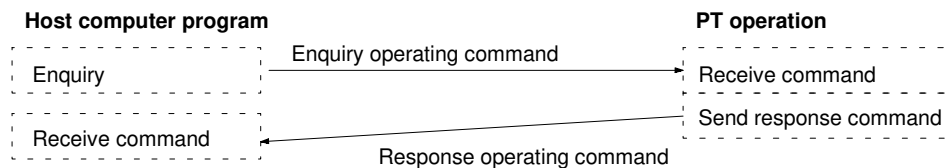

Notification of Operation at PT to the Host Computer

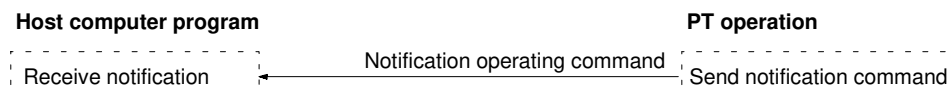

4-3-2 Terminal Commands

The terminal commands allow the PT to be used as a terminal of the host computer to display text and graphics independently of the screens stored in the PT.

The host computer sends a command and the PT processes the message. The PT does not send back a response to the host computer.



4-3-3 Online Transfer Commands

The online transfer commands conduct batch transfer of screens and memory tables.

These commands are used to set up a production process and to back up data for maintenance.

Note The commands cannot be used with NT20M or NT600M PTs fitted with an EPROM or EEPROM image memory. The commands are only applicable to PTs with SRAM memory.

Receivable Data Types

The online transfer commands can be used to receive the following types of data.

Data type	Description
Single screen data	Data for a screen displayed on the PT (host computer ↔ PT)
System memory	The initial screen displayed after the PT power is turned on (host computer ↔ PT).
Memory table data	All character-string memory table data and numeral table data (host computer ↔ PT).
Mark data	All mark data stored in the PT (host computer ↔ PT).
Display history data (by sequence)	All display history data stored in the PT in displayed sequence (PT→ host computer)
Display history data (by frequency)	All display history data stored in the PT in order of frequency (PT→ host computer)

Note It is not possible to transfer character-string memory table data and numeral table data independently.

Command Communication Procedure

The Online Transfer commands allow the transfer of large volumes of important data. To ensure that the data is transferred correctly, several commands are send back and forth during a single transfer operation.

The actual command communication procedure depends on the type of data transferred, as shown below:

Single Screen Data (Host Computer → PT)

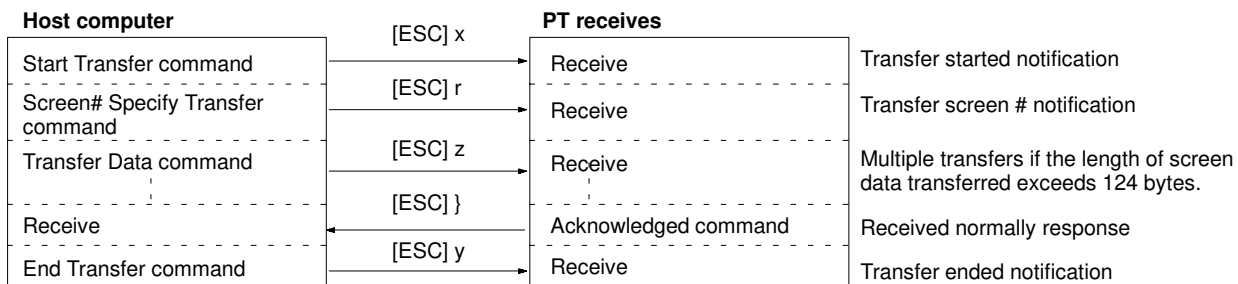

Single Screen Data (PT → Host Computer)

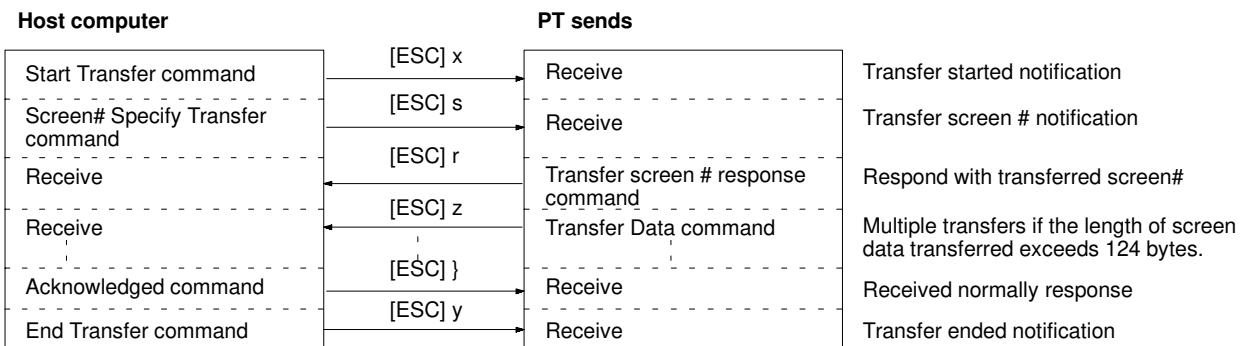

All Screen Data (PT → Host Computer) All screen data stored in the PT is transferred to the host computer.

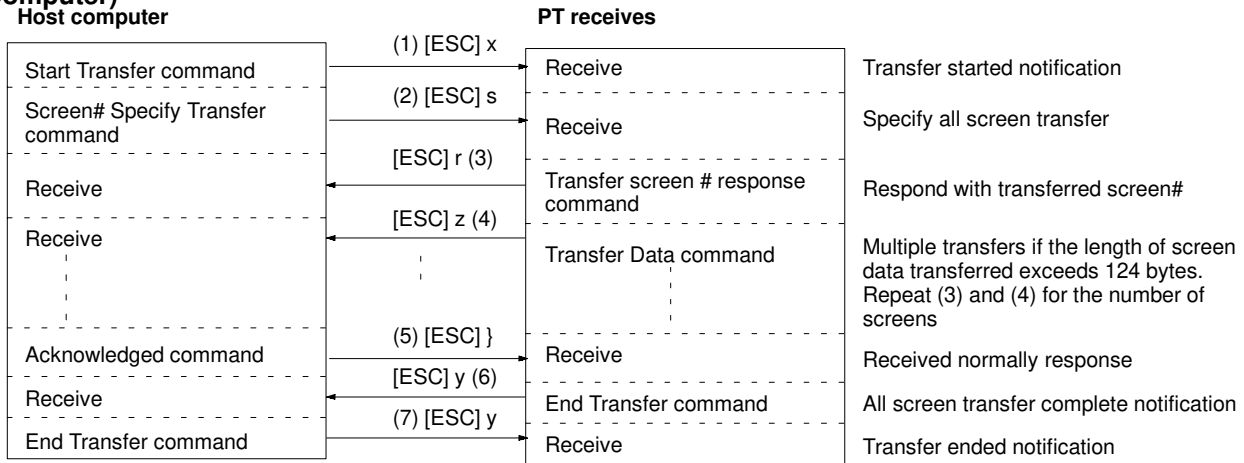

Memory Table Data (Host Computer → PT) Character-string memory table data and the numeral table data is batch transferred from the host computer to the PT.

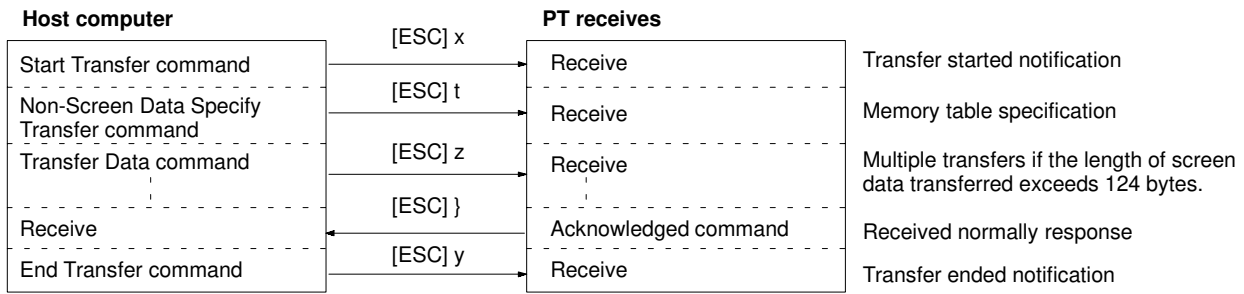

Display History Data (By Sequence) (PT → Host Computer) Transfers the screen data one screen at a time in the order they were displayed on the PT.

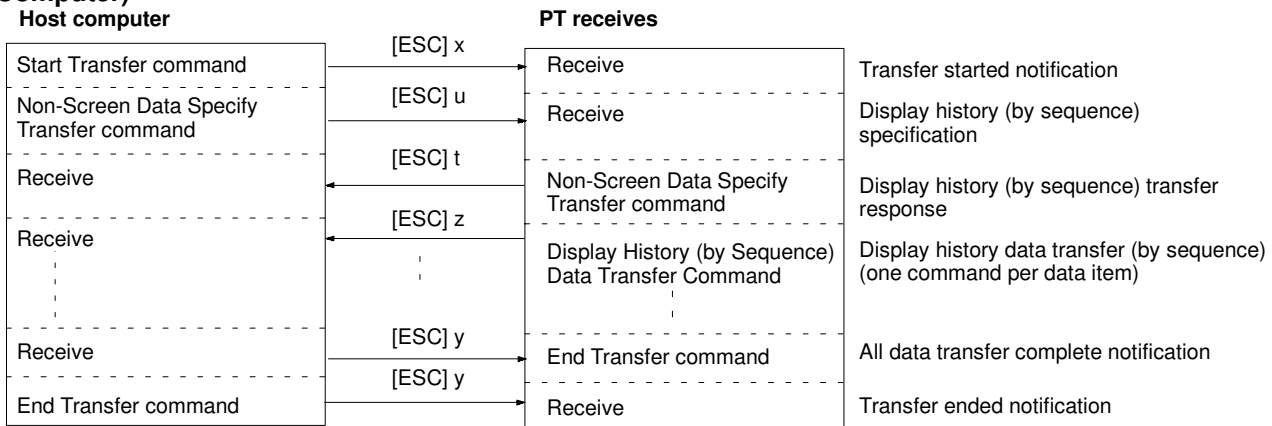

History data can also be transferred in order of frequency from the host computer to the PT using the same procedure.

Checksum Using the Online Transfer Command

The checksum (2-digit hexadecimal) ensures that command communication is normal when using online transfer. The transmitting station sets the checksum in a command and transmits it to the receiving station which confirms that the checksum is correct.

If the received checksum does not match the actual checksum, the receiving station returns a Not-Acknowledged Command (see page 53) to inform the transmitting station that a checksum error occurred.

The PT automatically sets and confirms the checksum but the host computer must be programmed to handle these tasks.

Checksum Calculation

The checksum is the two's compliment (2-digit hexadecimal) of the sum of the code from the [ESC] code (1BH) at the start of the command up to the checksum at the end of the command.

Example

In the case where screen #762 (hexadecimal: 02FAH) is specified with the Screen# Specify Transfer command [ESC] s.

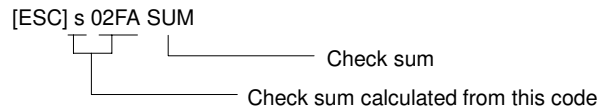

As the commands are sent as character codes the checksum is calculated as follows:

$$\frac{73}{s} + \frac{30}{0} + \frac{32}{2} + \frac{46}{F} + \frac{41}{A} = 15CH$$

The two's compliment is calculated from the least-significant two digits (by subtraction from 100H), as follows:

$$100H - 5CH = A4H$$

The command must appear as follows when it is sent by the program:

```
PRINT #1,CHR$( &H1B);"s02FA";"A4"
```

4-4 Precautions

Some important points to consider when using commands are listed below.

Command Length

If a mistake during command specification results in a command being too long, the correct length of the command is executed and the remainder is ignored.

A timeout error results if a mistake during command specification results in a command being too short.

Interval Between Transmitted Commands

As a small number of bytes is transmitted by the host, the interval between transmissions should not exceed 5 seconds if a command is divided up for transmission. A timeout error occurs if the interval between transmissions exceeds 5 seconds.

When commands are sent too frequently, a buffer overflow error may occur if the PT cannot keep up with the command processing.

The interval between command transmissions should not exceed 60 seconds using the Online Transfer command. A timeout error occurs and operation reverts to Run mode if the interval between transmissions exceeds 60 seconds.

Controlling PT Status with Operating Commands

Control of the PT status by the operating commands is restricted by the PT memory switch settings as listed below.

Operating command	Restriction from memory switch setting
Buzzer control command [ESC] T	Effective when buzzer turned on
Alarm Output control command [ESC] ^	Effective when alarm turned on

Coordinate Specification with the Terminal Commands

The entire command is ignored if any point specified at coordinates X, Y with the Terminal commands lies outside the screen.

Note If the PT's SW1-1 is set OFF (automatic reset after communication error) no message is displayed when a communication error occurs.

SECTION 5

Operating Commands

This section describes the functions of the operating commands and how to use them. The operating commands allows control of the PT by the host computer and notification of PT operations to the host computer.

5-1	Commands Sent by the Host Computer	32
5-1-1	Display Specified Screen	32
5-1-2	Request Screen Number	32
5-1-3	Write Character-string Memory Table	32
5-1-4	4-digit Write Numeral Table	33
5-1-5	8-digit Write Numeral Table	33
5-1-6	Copy Memory Table	33
5-1-7	Lamp and Touch Switch Display (Bit Specification)	34
5-1-8	Lamp and Touch Switch Display (Address Specification)	34
5-1-9	Lamp and Touch Switch Display Status Enquiry	35
5-1-10	Touch Switch and Function Key Disable	35
5-1-11	Touch Switch and Function Key Enable	35
5-1-12	Backlight Color Switching (NT20M, NT2000M)	36
5-1-13	Screen Display Control	36
5-1-14	Buzzer Control	36
5-1-15	Mode Switch Enable	36
5-1-16	PT Battery Status Enquiry	37
5-1-17	Initialize Display History	37
5-1-18	Alarm Output Control	37
5-1-19	Display Mode Control (NT600M)	37
5-2	Commands Sent by the PT	38
5-2-1	Screen Number Response	38
5-2-2	4-digit Number Input Notify	38
5-2-3	8-digit Number Input Notify	38
5-2-4	Function Key Number Output	39
5-2-5	Touch Switch Number Output	39
5-2-6	Function Key Bit Output	39
5-2-7	Touch Switch Bit Output	40
5-2-8	Lamp and Touch Switch Display Status Response	40
5-2-9	PT Battery Status Response	41

5-1 Commands Sent by the Host Computer

The operating commands sent by the host computer are described below.

Note All data values must be sent in ASCII code.

Example:

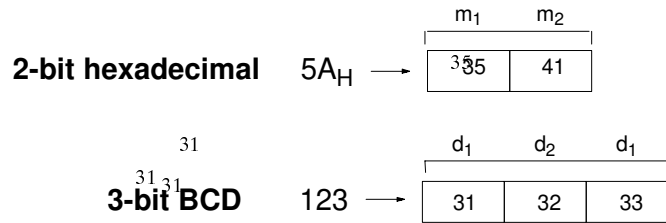

5-1-1 Display Specified Screen

Format



m₁m₂ (m₃m₄): Number of displayed screen (2-digit or 4-digit hexadecimal)

NT20M, NT2000M:

00: No display

01 to FA_H: Screen #1 to #250

NT600M:

0000: No display

0001 to 03E8_H: Screen #1 to #1000

Description

The specified screen is displayed on the PT when a screen# is sent from the host computer with this command.

5-1-2 Request Screen Number

Format

[ESC] x

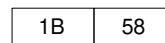

Description

Enquires what number screen is displayed on the PT. The PT returns the number of the displayed screen using the Screen Number Response Command (refer to 5-2-1 Screen Number Response).

5-1-3 Write Character-string Memory Table

Format

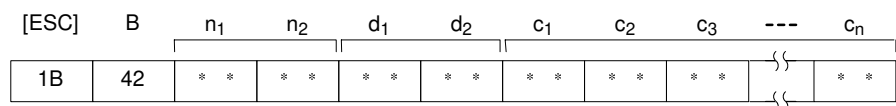

n₁n₂: Character string length as a number of normal characters (2-digit hexadecimal)

NT20M, NT2000M: 01 to 20_H (1 to 32)

NT600M: 01 to 28_H (1 to 40)

d₁d₂: Character-string memory table address of write destination (2-digit hexadecimal)

NT20M, NT2000M: 00 to 1F_H (0 to 31)
 NT600M: 00 to FF_H (0 to 255)

c₁c₂c₃ to c_n: Character-string data

Description

Writes the character-string data to the character-string memory table.
 The character-string data can contain a mixture of normal alphanumeric characters and marks. When determining the character string length, count each mark as two normal characters.

Caution

If the actual character string is longer than the specified character string length, the specified number of characters is written and the remainder are discarded. A timeout error message is displayed if the actual character string is shorter than the specified character string length.

5-1-4 4-digit Write Numeral Table

Format

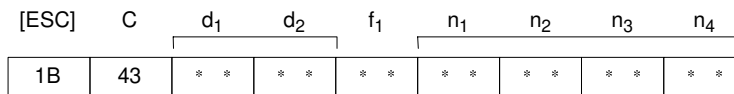

d₁d₂: Numeral table address of write destination (2-digit hexadecimal)
 NT20M, NT2000M: 00 to 7F_H (0 to 127)
 NT600M: 00 to FF_H (0 to 255)

f₁: + (2B_H) or - (2D_H) sign

n₁n₂n₃n₄: Number data (4-digit BCD)

Description

Writes the 4-digit decimal number data to the specified numeral table.
 Always include a + or - sign with the number data.
 The least-significant 4 digits of the display are overwritten if 4-digit number data is written to an 8-digit display.

5-1-5 8-digit Write Numeral Table

Format

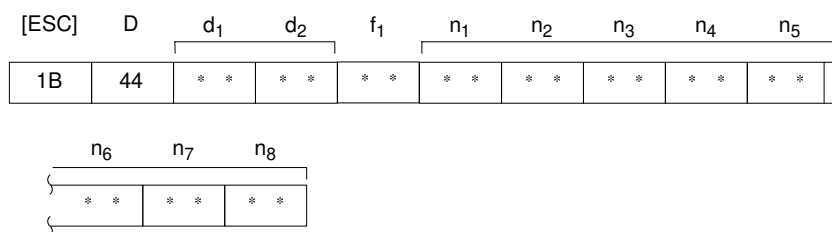

d₁d₂: Numeral table address of write destination (2-digit hexadecimal)
 NT20M, NT2000M: 00 to 7F_H (0 to 127)
 NT600M: 00 to FF_H (0 to 255)

f₁: + (2B_H) or - (2D_H) sign

n₁n₂n₃n₄n₅n₆n₇n₈: Number data (8-digit BCD)

Description

Writes the 8-digit decimal number data to the specified numeral table.
 Always include a + or - sign with the number data.

5-1-6 Copy Memory Table

Format

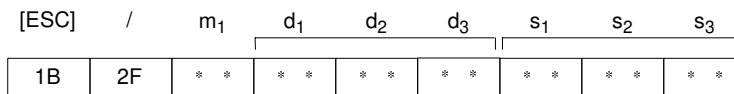

- m₁**: Type of memory table
 0 (30_H): Character-string memory table
 1 (31_H): numeral table
- d₁d₂d₃**: Copy source memory table address (see table below)
- s₁s₂s₃**: Copy destination memory table address (see table below)

Model	Character-string memory table address	Numeral table address
NT20M, NT2000M	000 to 031 (3-digit BCD)	000 to 127 (3-digit BCD)
NT600M	000 to 255 (3-digit BCD)	000 to 255 (3-digit BCD)

Description

Copies the contents of the copy source memory table to the copy destination memory table. The memory table contents are copied to a memory table of the same type: character-string memory table to character-string memory table or numeral table to numeral table.

5-1-7 Lamp and Touch Switch Display (Bit Specification)

Format

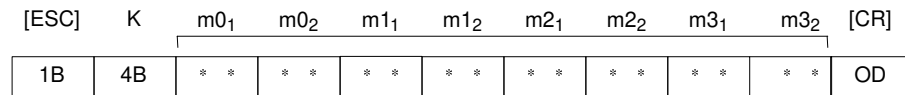

m₀ to m₃: Specification of lamps and touch switches (2-digit hexadecimal)
 The correspondence of the lamp and touch switch numbers to the bit representation in m₀ to m₃ is shown in the following table.

Parameter	m _{x1}				m _{x2}			
	7	6	5	4	3	2	1	0
m ₀	07	06	05	04	03	02	01	00
m ₁	15	14	13	12	11	10	09	08
m ₂	23	22	21	20	19	18	17	16
m ₃	31	30	29	28	27	26	25	24

Bit ON: Lamp or touch switch lights (or flashes)
 Bit OFF: Lamp or touch switch does not light (flash)

Example
 To light lamps and touch switch numbers 1, 5, 6, 7, and 26,
 m₀₁, m₀₂, m₁₁, m₁₂, m₂₁, m₂₂, m₃₁, m₃₂ = E2000004

Description

Changes the lamp or touch switch lighting status.
 The Support Tool sets if the lamp corresponding to a bit lights continuously or flashes.

5-1-8 Lamp and Touch Switch Display (Address Specification)

Format



m₁: Display status

m ₁	NT20M, NT2000M, NT600M
0 (30 _H)	Not lit (normal display)
1 (31 _H)	Lit
2 (32 _H)	Flashing inverse (lamps) Lit (touch switches)
3 (33 _H)	All not lit

n₁n₂: Lamp or touch switch address (2-digit hexadecimal)
 NT20M, NT2000M, NT600M: 00 to FF_H (0 to 255)

Description

Changes the lamp or touch switch lighting status.
 Specify the display status as 3 (all not lit) to turn off all the lamps and touch switches. In this case, specify the lamp or touch switch number to any number in the permitted range.

Caution

The display attributes set with the Support Tool determine if lamps #0 to #111 light continuously or flash. The display status set with this command is ignored.

5-1-9 Lamp and Touch Switch Display Status Enquiry

Format

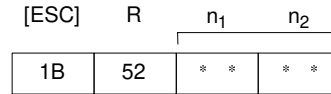

n₁n₂: Lamp or touch switch address (2-digit hexadecimal)
 NT20M, NT2000M, NT600M: 00 to FF_H (0 to 255)

Description

Enquires the status of a lamp or touch switch specified by its address.
 The PT returns the Lamp and Touch Switch Display Status Response Command (refer to 5-2-8 Lamp and Touch Switch Display Status Response) to report the display status.

5-1-10 Touch Switch and Function Key Disable

Format

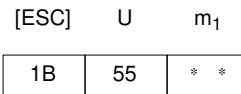

m₁: Type of switch to be disabled
 0 (30_H): Touch switches and function keys
 1 (31_H): Function keys
 2 (32_H): Touch switches

Description

Disables touch switch and function key input and notification to the host computer.

Comment

Use the Touch Switch and Function Key Enable Command (refer to 5-1-11 Touch Switch and Function Key Enable) to use a disabled touch switch or function key again. Disabled touch switches and function keys are also enabled when the PT power is turned off.

5-1-11 Touch Switch and Function Key Enable

Format

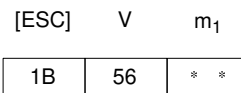

m₁: Type of switch to be enabled
 0 (30_H): Touch switches and function keys
 1 (31_H): Function keys
 2 (32_H): Touch switches

Description

Enables input and notification to the host computer of a disabled touch switch or function key.

Comment Disabled touch switches and function keys are also enabled when the PT power is turned off.

5-1-12 Backlight Color Switching (NT20M, NT2000M)

Format

[ESC] O m₁

1B	4F	* *
----	----	-----

m₁: Backlight color
 0 (30H): white
 1 (31H): red

Description Controls the backlight color.

Caution This command is only valid for the following PTs:
 NT20M-DT131
 NT20M-DN131
 NT2000M-DT131
 NT2000M-DN131

5-1-13 Screen Display Control

Format

[ESC] P m₁

1B	50	* *
----	----	-----

m₁: Display on or off
 0 (30H): on
 1 (31H): off

Description Turns off the backlighting of LCD and color-LCD model PTs; turns off the entire display of EL model PTs.

Comment This command can be used as a screen saver.
 The screen is re-displayed when a key or switch is operated.
 The specified screen is displayed when the when the Display Specified Screen Command (refer to 5-1-1 Display Specified Screen) is transferred.

5-1-14 Buzzer Control

Format

[ESC] T m₁

1B	54	* *
----	----	-----

m₁: Buzzer status
 0 (30H): Buzzer off
 1 (31H): Continuous buzzer
 2 (32H): Short intermittent buzzer

Description Controls the PT buzzer.

Comment The buzzer turned on with this command can be stopped with a stop command, by pressing the PT Buzzer Key, or by displaying a screen with no buzzer attributes.

5-1-15 Mode Switch Enable

Format

[ESC] W m₁

1B	57	* *
----	----	-----

m₁: Mode switching enabled/disabled (NT20M, NT2000M, NT600M)
 0 (30_H): Enabled
 1 (31_H): Disabled

Description

When mode switching is enabled for the NT20M, NT2000M, or NT600M with this command, the System Menu can be displayed and the Run mode or Maintain mode can be selected from the menu to switch the operating mode. When mode switching is disabled, the System Menu can be displayed but the mode cannot be switched from it.

The DIP switch (SW1-6) settings are valid after the PT is turned on or reset.

5-1-16 PT Battery Status Enquiry

Format

[ESC] Z

1B	5A
----	----

Description

Determines if the built-in PT battery voltage is low. The PT returns the PT Battery Status Response Command (see 5-2-9 PT Battery Status Response) to report the battery status.

5-1-17 Initialize Display History

Format

[ESC]]

1B	5D
----	----

Description

Deletes the entire contents of the display history.

5-1-18 Alarm Output Control

Format

[ESC] ^ m₁

1B	5E	* *
----	----	-----

m₁: Turns the alarm output bit on and off.
 0 (30_H): off
 1 (31_H): on

Description

Turns the PT alarm output bit on and off.

Comment

The alarm turned on with this command can be stopped with a stop command.

5-1-19 Display Mode Control (NT600M)

Format

[ESC] _ m₁

1B	5F	* *
----	----	-----

m₁: Display mode
 0 (30_H): Normal display (white)
 1 (31_H): Inverse display (black)

Description

Controls the LCD display mode.

Caution This command is only valid for the following PTs:
 NT600M-DT122
 NT600M-DF122

5-2 Commands Sent by the PT

The operating commands sent by the PT to the host computer are described below.

5-2-1 Screen Number Response

Format

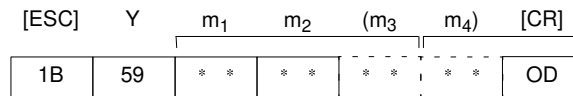

m_1m_2 (m_3m_4): Number of displayed screen (2-digit or 4-digit hexadecimal)
 NT20M, NT2000M: 00 to FA_H (0 to 250)
 NT600M: 0000 to 03E8_H (0 to 1,000)

Description

The PT returns this command to report the currently displayed screen number to the host computer in response to the Request Screen Number Command (refer to 5-1-2 *Request Screen Number*) sent from the host computer. The new screen number is reported to the host computer with this command after the displayed screen is switched with the Stand-alone functions (screen switch function).

5-2-2 4-digit Number Input Notify

Format

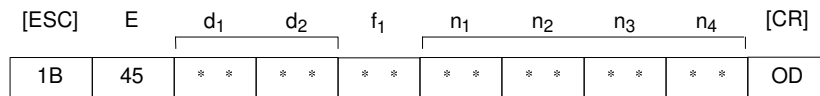

d_1d_2 : Numeral table address to which number was input (2-digit hexadecimal)
 NT20M, NT2000M: 00 to 7F_H (0 to 127)
 NT600M: 00 to FF_H (0 to 255)
 f_1 : + (2B_H) or - (2D_H) sign
 $n_1n_2n_3n_4$: Input number data (4-digit BCD)

Description

A number with 4 transferred digits set with the PT number setting function is reported to the host computer with this command.

5-2-3 8-digit Number Input Notify

Format

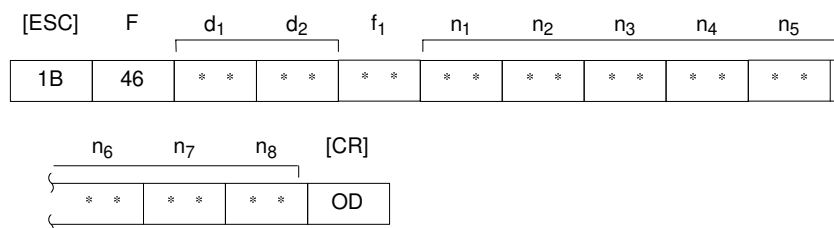

d_1d_2 : Numeral table address to which number was input (2-digit hexadecimal)
 NT20M: 00 to 7F_H
 NT600M: 00 to FF_H
 f_1 : + (2B_H) or - (2D_H) sign

n₁n₂n₃n₄n₅n₆n₇n₈: Input number data (8-digit BCD)

Description A number with 8 transferred digits set with the PT number setting function is reported to the host computer with this command.

5-2-4 Function Key Number Output

Format

[ESC]	G	m ₁	m ₂	[CR]
1B	47	* *	* *	OD

m₁m₁: Pressed function key number (2-digit hexadecimal)
 NT20M, NT2000M, NT600M: 00 to 0B_H, 11 to 3F_H

Description If the Screen Attribute “bit-input-disable” screen is displayed, the function key number corresponding to a pressed function key or input to an input terminal is reported to the host computer with this command.

Caution The permitted range of function key numbers depends on the type of Unit connected, as follows:
 10/02 Terminal: 0 to 9
 32/16 Terminal: 0 to 11, 16 to 31
 12-key Function Key Unit: 0 to 11

Comment If more than one of the Unit input terminals is turned ON, the number of the first terminal to turn ON is notified.
 Function keys allocated as keys on a numeric keypad are not notified when they are pressed for number setting.

5-2-5 Touch Switch Number Output

Format

[ESC]	H	m ₁	m ₂	[CR]
1B	48	* *	* *	OD

m₁m₂: Pressed touch switch number (2-digit hexadecimal)
 NT20M, NT2000M, NT600M: 00 to FE_H (0 to 255)

Description If the Screen Attribute “bit-input-disable” screen is displayed, the touch key number corresponding to a pressed touch key is reported to the host computer with this command.

Comment If more than one touch switch is pressed, the number of the first touch switch pressed is notified.
 Touch keys allocated as keys on a numeric keypad are not notified when they are pressed for number setting.

5-2-6 Function Key Bit Output

Format

[ESC]	I	s ₀ ₁	s ₀ ₂	s ₁ ₁	s ₁ ₂	s ₂ ₁	s ₂ ₂	s ₃ ₁	s ₃ ₂	[CR]
1B	49	* *	* *	* *	* *	* *	* *	* *	* *	OD

s₀ to s₃: Function key status (2-digit hexadecimal)
 The correspondence between the bit representation in s₀ to s₃ and the function key number is shown in the following table.

Parameter	SX ₁				SX ₂			
	7	6	5	4	3	2	1	0
s0	07	06	05	04	03	02	01	00
s1	15	14	13	12	11	10	09	08
s2	23	22	21	20	19	18	17	16
s3	31	30	29	28	27	26	25	24

Bit ON: Function key is ON
 Bit OFF: Function key is OFF

Example
 Function keys number 5, 6, 29, 31 are ON
 s0₁s0₂s1₁s1₂s2₁s2₂s3₁s3₂ = 600000A0

Description

This command is used by the DF type PTs and some DN type PTs. If the Screen Attribute (bit input/function key) screen is displayed, the change in the bit status corresponding to a pressed function key or the change of status of an input terminal is reported to the host computer with this command. The host computer is notified each time a function key or input terminal ON/OFF status changes.

Comment

Function keys allocated as keys on a numeric keypad are not notified when they are pressed for number setting.

5-2-7 Touch Switch Bit Output

Format

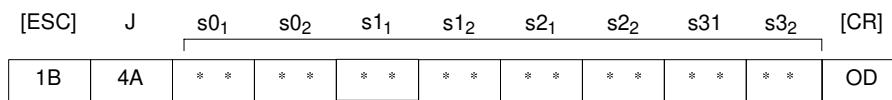

s0 to s3: Touch switch status (2-digit hexadecimal)
 The correspondence between the bit representation in s0 to s3 and the touch switch number is shown in the following table.

Parameter	SX ₁				SX ₂			
	7	6	5	4	3	2	1	0
s0	07	06	05	04	03	02	01	00
s1	15	14	13	12	11	10	09	08
s2	23	22	21	20	19	18	17	16
s3	31	30	29	28	27	26	25	24

Bit ON: Touch switch is ON
 Bit OFF: Touch switch is OFF

Example
 Touch switch numbers 0, 3, 21, 27 are ON
 s0₁s0₂s1₁s1₂s2₁s2₂s3₁s3₂ = 09002008

Description

If the Screen Attribute “bit input / touch switch” screen is displayed, the change in the bit status corresponding to a pressed touch switch is reported to the host computer with this command. The host computer is notified each time a touch switch status changes.

5-2-8 Lamp and Touch Switch Display Status Response

Format

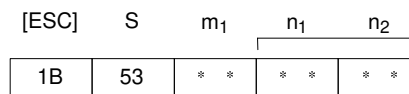

m₁: Display status

m₁	NT20M, NT600M
0 (30 _H)	Not lit (normal display)
1 (31 _H)	Lit
2 (32 _H)	Flashing inverse (lamps) Lit (touch switches)

n₁n₂: Lamp or touch switch address (2-digit hexadecimal)
 NT20M, NT2000M, NT600M: 00 to FF_H (0 to 255)

Description

The PT returns this command to report the lamp or touch switch number display status to the host computer in response to the Lamp and Touch Switch Display Status Enquiry Command (see 5-1-9) sent from the host computer.

Caution

Lamps 0 to 31 are reported as being lit when in the “flashing inverse” status.

5-2-9 PT Battery Status Response

Format

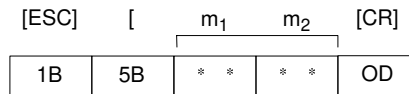

m₁m₂: Battery voltage status (2-digit hexadecimal)
 00: Normal voltage
 01: Low voltage

Description

The PT returns this command to report the battery voltage status to the host computer in response to the PT Battery Status Enquiry Command (refer 5-1-16 *PT Battery Status Enquiry*) sent from the host computer.

SECTION 6

Terminal Commands

This section describes the functions of the terminal commands and how to use them. Terminal commands allow the display of information from the host computer as text and graphics, independently of the screens stored in the PT.

6-1	Terminal Commands	44
6-1-1	Clear Screen	44
6-1-2	Character Specify Size	44
6-1-3	Specify Character Enlargement	44
6-1-4	Normal Display	45
6-1-5	Set Inverse Display	45
6-1-6	End Inverse Display	45
6-1-7	Set Flashing Display	45
6-1-8	End Flashing Display	46
6-1-9	Set Cursor Position	46
6-1-10	Specify Displayed Characters	46
6-1-11	Draw Polyline	47
6-1-12	Draw Circle	47

6-1 Terminal Commands

Note All data values must be sent in ASCII code.

Example:

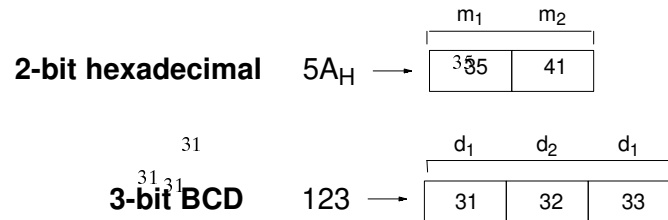

6-1-1 Clear Screen

Format

[ESC] &

1B	26
----	----

Description

Clears all text and graphics on the PT screen.

Comment

After the display of number, text, lamps or touch switches is upgraded, only the upgraded parts are re-displayed.

6-1-2 Character Specify Size

Format

[ESC]) m₁

1B	29	* *
----	----	-----

m₁: Character size

0 (30_H): Normal size, 16 x 8 dots (H x W)

1 (31_H): 1/2 size, 8 x 8 dots (H x W)

Description

Specifies if 1-byte alphanumeric characters sent subsequently are displayed as normal characters or 1/2-size characters.

Comment

The character string is specified with the Specify Displayed Characters Command (refer to 6-1-10 *Specify Displayed Characters*). Both normal characters and 1/2-size characters are enlarged as specified by the Specify Character Enlargement Command (refer to 6-1-3 *Specify Character Enlargement* below). The character size specified with this command remains valid until the screen display is switched or another character size is specified with the command. The default character size is normal characters.

6-1-3 Specify Character Enlargement

Format

[ESC] * m₁

1B	2A	* *
----	----	-----

m₁: Character enlargement

0 (30_H): No enlargement

1 (31_H): Enlarge height

2 (32_H): Enlarge width

3 (33_H): 2 x 2 enlargement
 4 (34_H): 3 x 3 times enlargement
 5 (35_H): 4 x 4 times enlargement
 6 (36_H): 8 x 8 times enlargement (NT600M)

Description All text and marks sent after this command are displayed in the specified size.

Comment The character string is specified with the Specify Displayed Characters Command (refer to *6-1-10 Specify Displayed Characters*).
 The enlargement specified with this command remains valid until the screen display is switched or another enlargement is specified with the command. The default enlargement is no enlargement.

6-1-4 Normal Display

Format

[ESC] !

1B	21
----	----

Description Cancels all display attribute settings (inverse, flashing, flashing inverse) for characters and marks so that all characters are displayed as “normal” characters (not inverse or flashing).

6-1-5 Set Inverse Display

Format

[ESC] "

1B	22
----	----

Description Sets the display attribute to inverse so that all characters and marks sent subsequently are highlighted. Other attributes remain unchanged.

Comment The Set Inverse Display Command is cancelled by the End Inverse Display Command or the Normal Display Command.
 The setting with this command remains valid until the screen display is switched or another display attribute setting is made. The default display attributes are set to a normal display when a screen is initially displayed.
 Use this command with the Set Flashing Display Command (refer *6-1-7 Set Flashing Display*) to produce a flashing inverse display.

6-1-6 End Inverse Display

Format

[ESC] #

1B	23
----	----

Description Clears the inverse display attribute so that all characters and marks sent subsequently are not highlighted. Other attributes remain unchanged.

Comment The inverse display attribute is set with the Set Inverse Display Command.
 The setting with this command remains valid until the screen display is switched or another display attribute setting is made. The default display attributes are set to a normal display when a screen is initially displayed.

6-1-7 Set Flashing Display

Format

[ESC] \$

1B	24
----	----

Description	Sets the display attribute to flashing so that all characters and marks sent subsequently are displayed flashing. Other attributes remain unchanged.
Comment	<p>The Set Flashing Display Command is cancelled by the End Flashing Display Command or the Normal Display Command (refer to 6-1-4 Normal Display and 6-1-8 End Flashing Display).</p> <p>The setting with this command remains valid until the screen display is switched or another display attribute setting is made. The default display attributes are set to a normal display when a screen is initially displayed.</p> <p>Use this command with the Set Inverse Display Command (refer to 6-1-5 Set Inverse Display) to produce a flashing inverse display.</p>

6-1-8 End Flashing Display

Format

[ESC] %

1B	25
----	----

Description	Clears the flashing display attribute so that all characters and marks sent subsequently are not flashing. Other attributes remain unchanged.
Comment	<p>The flashing display attribute is set with the Set Flashing Display Command. The setting with this command remains valid until the screen display is switched or another display attribute setting is made. The default display attributes are set to a normal display when a screen is initially displayed.</p>

6-1-9 Set Cursor Position

Format

[ESC]	+	x ₁	x ₂	x ₃	y ₁	y ₂	y ₃
1B	2B	* *	* *	* *	* *	* *	* *

x₁x₂x₃: X coordinate (3-digit BCD)

y₁y₂y₃: Y coordinate (3-digit BCD)

Description

Model	X coordinate	Y coordinate
NT20M, NT2000M	000 to 255	000 to 127
NT600M	000 to 639	000 to 399

Before displaying a character string with the Terminal commands, use this command to set the bottom-left point of the first character to be displayed.

Comment	The cursor position set with this command is also the bottom-left point of the first character displayed if the displayed characters are enlarged.
----------------	--

6-1-10 Specify Displayed Characters

Format

[ESC]	4	n ₁	n ₂	c ₁	c ₂	c ₃	---	c _n
1B	34	* *	* *	* *	* *	* *	{ }	* *

n₁n₂: Character string length as a number of normal characters (2-digit hexadecimal)

NT20M, NT2000M: 01 to 20_H (1 to 32)

NT600M: 01 to 50_H (1 to 80)

c₁c₂c₃ to c_n: Character-string to display

Description

The character string is displayed from the cursor position. The character-string data can contain a mixture of normal (alphanumeric) characters and marks. Refer to *Appendix D Special Characters* for details. The character string is displayed according to the enlargement and display attributes set with commands.

Comment

The character string continues on the next line if it cannot fit into a single line. Set the position where the character string is displayed with the Set Cursor Position Command (refer to 6-1-9 *Set Cursor Position*).

6-1-11 Draw Polyline

Format

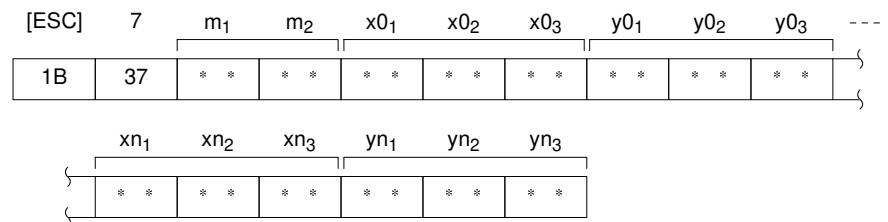

m₁, m₂: Number of lines to draw (2-digit hexadecimal)
01 to 28_H (1 to 40)

x₀₁x₀₂x₀₃ to x_{n1}x_{n2}x_{n3}: X coordinates of line end points (3-digit BCD)

y₀₁y₀₂y₀₃ to y_{n1}y_{n2}y_{n3}: Y coordinates of line end points (3-digit BCD)

Model	X coordinate	Y coordinate
NT20M, NT2000M	000 to 255	000 to 127
NT600M	000 to 639	000 to 399

Description

Draws the specified number of lines between the specified points.

6-1-12 Draw Circle

Format

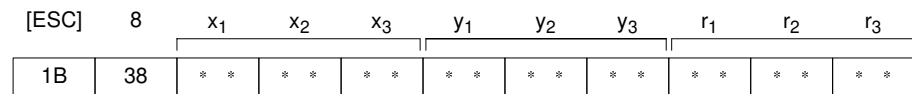

x₁x₂x₃: X coordinate of circle center (3-digit BCD)

y₁y₂y₃: Y coordinate of circle center (3-digit BCD)

Model	X coordinate	Y coordinate
NT20M, NT2000M	000 to 255	000 to 127
NT600M	000 to 639	000 to 399

r₁r₂r₃: circle radius in dots (3-digit BCD)
NT20M, NT2000M: 001 to 063
NT600M: 001 to 199

Description

Draws a circle of the specified radius around the circle center point.

SECTION 7

Online Transfer Commands

This section describes the functions of the online transfer commands to transfer screen and memory table data between the host computer and PT. The commands cannot be used with PTs fitted with an EPROM or EEPROM image memory.

7-1	Commands to Start and End Online Transfer	50
7-1-1	Online Transfer Start	50
7-1-2	Online Transfer End	50
7-2	Commands to Set Transfer from PT to Host Computer	50
7-2-1	Specify Transfer Screen Number (Host Computer to PT)	50
7-2-2	Specify Transfer Non-screen Data (Host Computer to PT)	51
7-3	Commands to Notify the Data Type	51
7-3-1	Transfer Screen Number Notify (PT to Host Computer)	51
7-3-2	Transfer Non-screen Data Notify (PT to Host Computer)	52
7-4	Commands to Transfer Data and Notify Results	52
7-4-1	Transfer Data	52
7-4-2	Acknowledged	52
7-4-3	Not-Acknowledged	53
7-5	Configuration of Display History Data	53

7-1 Commands to Start and End Online Transfer

Note All data values must be sent in ASCII code.

Example:

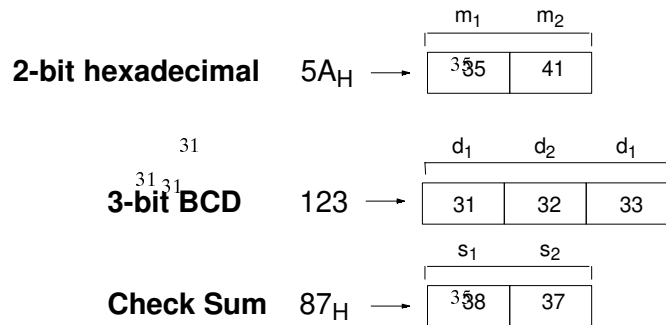

7-1-1 Online Transfer Start

Format

[ESC] x

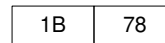

Description

Notifies the PT that online transfer has started.

When the PT receives this command it interrupts Run operation and stands by to receive commands from the host computer (Online Transfer mode).

Caution

An error occurs if the PT receives no further command within 5 seconds of receiving this command. An error message is displayed on the screen and the buzzer sounds. Refer to the PT manual for details.

7-1-2 Online Transfer End

Format

[ESC] y s_1 s_2 [CR]

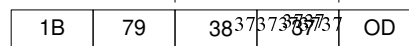

s_1s_2 : Checksum (fixed as 87_H)

Description

Notifies the PT that online transfer has ended.

When the PT receives this command it exits the Online Transfer mode and recommences Run operation.

7-2 Commands to Set Transfer from PT to Host Computer

7-2-1 Specify Transfer Screen Number (Host Computer to PT)

Format

[ESC] s m_1 m_2 (m_3 m_4) s_1 s_2 [CR]



m_1m_2 (m_3m_4): Screen number to send from the PT

NT20M: 00_H All screens

01 to FA_H (2-digit hexadecimal)

NT600M: 0000_H All screens

0001 to 03E8_H (4-digit hexadecimal)

s₁s₂: Checksum (2-digit hexadecimal)

Description

The host computer specifies the screen number of the screen to be sent from the PT with this command. After this command is executed, the PT notifies the screen number to be sent to the host computer with the Transfer Screen Number Notify Command (refer to 7-3-1 *Transfer Screen Number Notify*) before sending the screen data with the Transfer Data Command (refer to 7-4-1 *Transfer Data*).

7-2-2 Specify Transfer Non-screen Data (Host Computer to PT)

Format

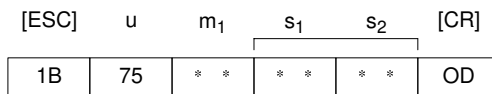

- m₁**: Type of data sent from the PT
 0 (30_H): System memory
 1 (31_H): Number, character-string memory table data
 2 (32_H): Mark data
 4 (34_H): Display history data (by sequence)
 5 (35_H): Display history data (by frequency)

s₁s₂: Checksum (2-digit hexadecimal)

Description

The host computer specifies the type of data to be sent from the PT with this command. After this command is executed, the PT returns the type of data to the host computer with the Transfer Non-screen Data Notify Command (refer to 7-3-2 *Transfer Non-screen Data Notify*) before sending the data with the Transfer Data Command (refer to 7-4-1 *Transfer Data*).

7-3 Commands to Notify the Data Type

7-3-1 Transfer Screen Number Notify (PT to Host Computer)

Format

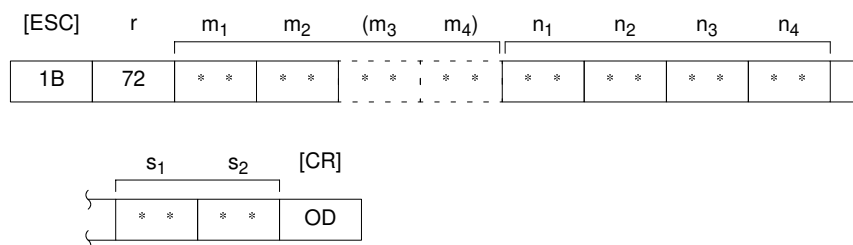

- m₁m₂ (m₃m₄)**: Transferred screen number
 NT20M: 01_H to FA_H (2-digit hexadecimal)
 NT600M: 0001_H to 03E8_H (4-digit hexadecimal)
- n₁n₂n₃n₄**: Data length (number of screen data bytes transferred) (4-digit hexadecimal)
- s₁s₂**: Checksum (2-digit hexadecimal)

Description

The data transmitting station notifies the receiving station of the screen number and the number of bytes to be sent. After this command is executed, the screen data is sent with the Transfer Data Command (refer to 7-4-1 *Transfer Data*). The data length includes all bytes in the transferred data.

Caution

When screen data is transferred to the PT, the transferred data overwrites existing screen data stored under the same screen number.

7-3-2 Transfer Non-screen Data Notify (PT to Host Computer)

Format

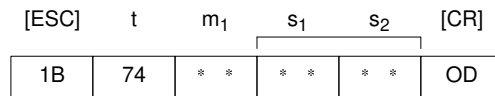

- m₁:** Transferred data type
 - 0 (30_H): System memory
 - 1 (31_H): Number, character-string memory table data
 - 2 (32_H): Mark data
 - 4 (34_H): Display history data (by sequence) (see note)
 - 5 (35_H): Display history data (by frequency) (see note)

Note Valid only for transfer from PT to host computer.

s₁s₂: Checksum (2-digit hexadecimal)

Description

The data transmitting station notifies the receiving station of the type of data sent. After this command is executed, the data is sent with the Transfer Data Command (refer to 7-4-1 Transfer Data).

7-4 Commands to Transfer Data and Notify Results

7-4-1 Transfer Data

Format

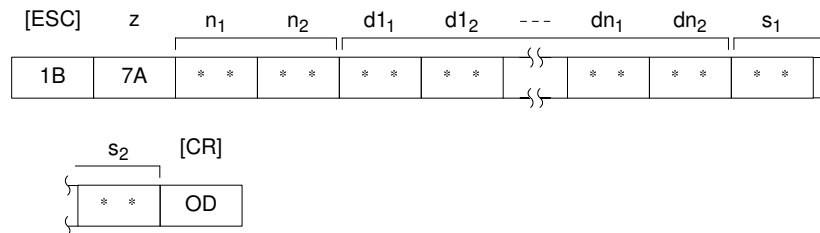

n₁n₂: Data length (number of screen data bytes transferred) (02 to 7C_H, 2-digit hexadecimal)

d₁₁d₁₂ to d_n₁d_n₂: Transferred data (2-digit hexadecimal)

s₁s₂: Checksum (2-digit hexadecimal)

Description

Transfers the specified data length of data. A maximum of 124 bytes can be transferred by this command. Execute this command repeatedly to transfer data exceeding 124 bytes in length. Data must be transferred in a format as an even number of bytes. Divide data longer than 124 bytes into packets containing even numbers of bytes. If the data contains an odd number of bytes, append 00_H to produce an even number of bytes. When long data is divided for transmission, append 00_H to the final data packet only.

7-4-2 Acknowledged

Format

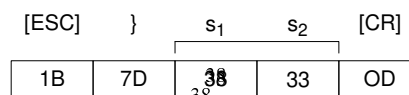

s₁s₂: Checksum (fixed as 83_H)

Description Notifies that data transmission was completed normally.

7-4-3 Not-Acknowledged

Format

[ESC]	~	m ₁	s ₁	s ₂	[CR]
1B	7E	* *	* *	* *	OD

- m₁**: 1-byte error code data
 F0_H: Memory full
 F1_H: Command error 1
 F2_H: Command error 2
 F3_H: Process interrupted
 F4_H: Checksum error
 F9_H: Screen data memory error
- s₁s₂**: Checksum (2-digit hexadecimal)

Description Notifies that an error occurred during data transmission.

Caution If the number of data bits is set to 7 bits, error codes F0_H to F9_H sent from the PT are received by the host computer as 70_H to 79_H. Refer to Checksum when Using the Online Transfer Command (refer to *Section 7 Online Transfer Commands*) for information about calculating the checksum.

7-5 Configuration of Display History Data

Each record is made up of 54 bytes (27 columns) of data, as follows:

- n₁n₂n₃n₄ t₁t₂ c₁c₁₂ to c₂₄c₂₄₂**
- n₁n₂n₃n₄**: Screen number (4-digit hexadecimal)
 NT20M: 0001 to 00FA_H
 NT600M: 0001 to 03E8_H
 - t₁t₂**: Number of times occurred (2-digit hexadecimal)
 - c₁c₁₂ to c₂₄c₂₄₂**: Messages (2-digit hexadecimal)
 Character code
 48 bytes (24 columns) in total

SECTION 8

Sample Programs

This section provides some sample programs using the Transfer commands. Refer to these sample programs for actual information on using the commands.

8-1	Key to Programs	56
	8-1-1 Use of Programs	56
8-2	Program	57

8-1 Key to Programs

The following programs include all the commands that can be used with the the NT600M.

8-1-1 Use of Programs

The sample program appears as follows on the screen.

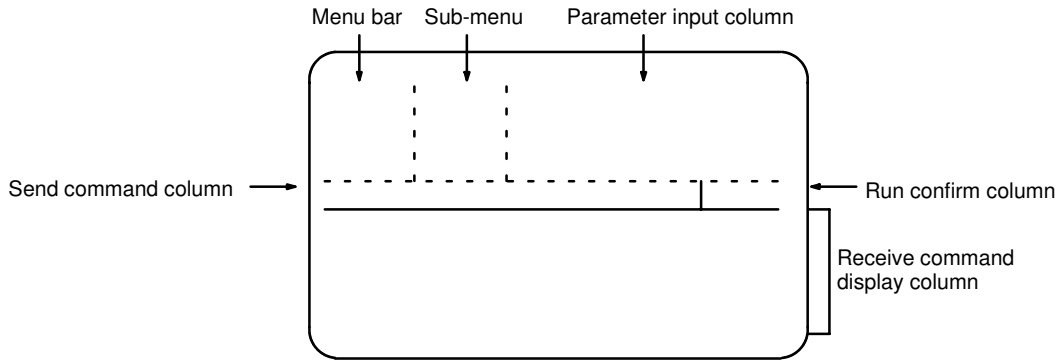

Use the program as shown below.

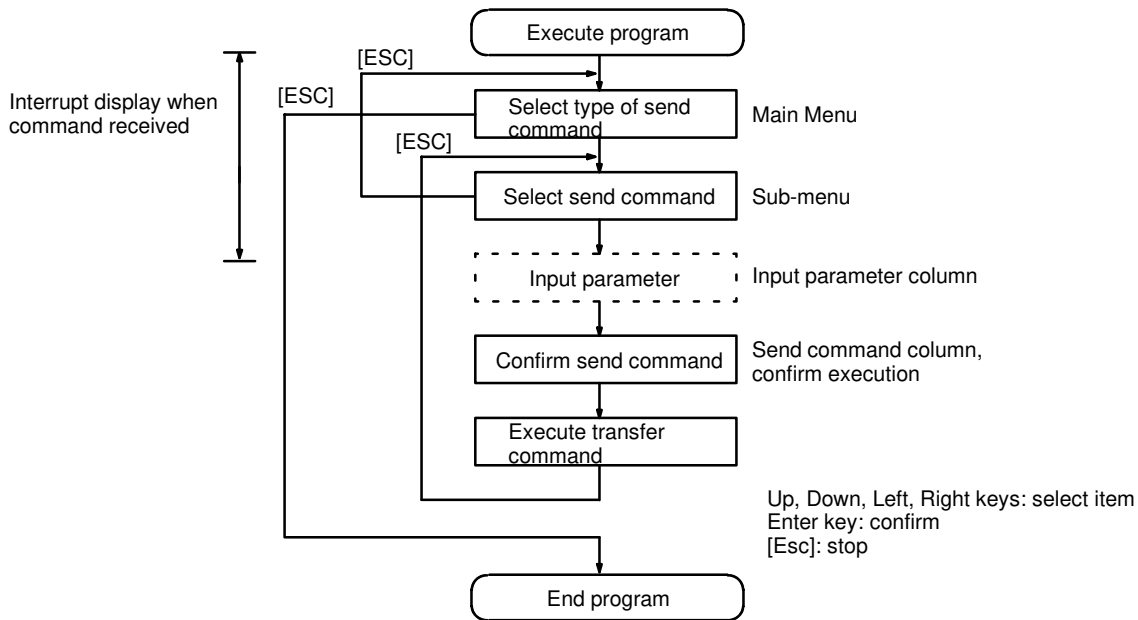

- Note**
1. Modify this program for use with a PT other than the NT600M.
 2. This sample program is written in N88 BASIC (86) (NEC) for a PC-9801 computer. Modify this program for use with any other computer language or computer such as an IBM PC/AT or compatible.
 3. The interval between parameter input and command transmission is a hold interval for interrupt processing of the received command. If an interrupt is permitted between the interval of parameter input and a command is received, all subsequent receive interrupts are displaced. If this occurs, send an enquiry command to read all the accumulated receive data.
 4. When a parameter is input, no check is made that the parameter is in the permitted range. Make sure that parameters are input within the permitted range.

8-2 Program

```

1000 ' *****
1010 ' *   Transfer/Receive Command Sample Program           *
1020 ' *****
1030 ' -----Draw screen frame
1040 SECT=5
1050 DIM CMND$(SECT,10,1),CMND(SECT),TS.B(31)
1060 SCREEN 3:CLS 3:CONSOLE 11,25,0,0
1070 LINE (0,136)-(639,136),7,,&HF0F0
1080 LINE (120,0)-(120,136),7,,&HF0F0
1090 LINE (248,0)-(248,136),7,,&HF0F0
1100 LINE (520,136)-(520,168),7,,&HF0F0
1110 LINE (0,168)-(639,169),7,B
1120 CMND(0)=SECT ' -----Set display character strings
1130 FOR I=1 TO SECT
1140   READ CMND$(0,I,0)
1150 NEXT I
1160 FOR I=1 TO SECT
1170   READ CMND(I)
1180   FOR J=1 TO CMND(I)
1190     READ CMND$(I,J,0),CMND$(I,J,1)
1200   NEXT J
1210 NEXT I
1220 '
1230 RY=11
1240 ON COM(1) GOSUB *RECV ' -----Set receive interrupt routine
1250 OPEN "COM1:E72NN" AS #1 ' -----Open communication port
1260 COM(1) ON
1270 '
1280 *LV0 ' -----Main Menu
1290 LV=0:SECT.NO=0:SEL.NO=1
1300 GOSUB *SELECT
1310 IF SEL.NO=0 THEN GOTO *PRO.END
1320 SECT.NO=SEL.NO
1330 '
1340 *LV1 ' -----Sub-menu
1350 LV=1:SEL.NO=1
1360 GOSUB *SELECT
1370 IF SEL.NO=0 THEN GOTO *LV0
1380 *LV2 ' -----Branch according to command (parameter input)
1390 COM(1) STOP
1400 LV=2:SEND$=CMND$(SECT.NO,SEL.NO,1)
1410 *SECT1
1420 IF SECT.NO<>1 THEN GOTO *SECT2
1430   ON SEL.NO GOSUB *ESC.0,*ESC.X
1440 *SECT2
1450 IF SECT.NO<>2 THEN GOTO *SECT3
1460   ON SEL.NO GOSUB *ESC.B,*ESC.C,*ESC.D,*ESC.2F
1470 *SECT3
1480 IF SECT.NO<>3 THEN GOTO *SECT4
1490   ON SEL.NO GOSUB *ESC.U,*ESC.V
1500 *SECT4
1510 IF SECT.NO<>4 THEN GOTO *SECT5
1520   ON SEL.NO GOSUB *ESC.Q,*ESC.K,*ESC.R
1530 *SECT5

```

```

1540 IF SECT.NO<>5 THEN GOTO *LV2.END
1550   ON SEL.NO GOSUB *ESC.T,*ESC.5E,*ESC.5D,*ESC.Z,*ESC.5F,*ESC.W,*ESC.P
1560 *LV2.END ' -----Confirm transmission
1570 LOCATE 0,9:PRINT SEND$;
1580 LOCATE 66,9:PRINT "OK?";
1590 YN=1
1600 *YN.KY.IN
1610 LOCATE 74,9:COLOR 2+2*YN:PRINT "Y ";:COLOR 2-2*YN:PRINT "N ";
1620 A$=INKEY$:IF A$="" THEN *YN.KY.IN
1630 IF A$=CHR$(&H1C) OR A$=CHR$(&H1D) THEN YN=YN*(-1):GOTO *YN.KY.IN
1640 IF A$<>CHR$(&HD) THEN GOTO *YN.KY.IN
1650 LOCATE 66,9:COLOR 0:PRINT SPACE$(14);
1660 IF YN=-1 THEN GOTO *LV3.END
1670 GOSUB *SEND ' -----Send command
1680 COM(1) ON
1690 LOCATE 32,7:COLOR 4:PRINT "Press ESC Key";:COLOR 0
1700 *SND.KY.IN
1710 A$=INKEY$:IF A$<>CHR$(&H1B) THEN *SND.KY.IN
1720 *LV3.END
1730 LOCATE 0,9:PRINT SPACE$(79);
1740 FOR I=0 TO 7
1750   LOCATE 32,I:PRINT SPACE$(48);
1760 NEXT I
1770 GOTO *LV1 ' -----Return to Sub-menu
1780 '
1790 *PRO.END ' -----End routine
1800 COM(1) OFF:CLOSE ' -----Close communication port
1810 CONSOLE 0,25,0,1:CLS 3
1820 END
1830 '
1840 *SEND ' -----Send command routine
1850 SND$=CHR$(&H1B)+MID$(SEND$,6)
1860 PRINT #1,SND$
1870 RETURN
1880 '
1890 *RCV ' -----Receive interrupt routine
1900 IF LOC(1)=0 THEN GOTO *NORCV
1910 SX=POS(0):SY=CSRLIN
1920 LINE INPUT #1,RCV$
1930 LOCATE 0,RY:COLOR 0
1940 PRINT "[ESC]";MID$(RCV$,2)
1950 R.CODE$=MID$(RCV$,2,1)
1960 *ESC.Y ' -----Notify screen number
1970 IF R.CODE$<>"Y" THEN GOTO *ESC.E
1980 PRINT "Screen Number: ";VAL("&H"+MID$(RCV$,3,4))
1990 PRINT:GOTO *RCV.END
2000 *ESC.E ' -----Notify 4-digit number
2010 IF R.CODE$<>"E" THEN GOTO *ESC.F
2020 PRINT "Numeral table #: ";VAL("&H"+MID$(RCV$,3,2))
2030 PRINT "Input decimal value: ";VAL(MID$(RCV$,5,5))
2040 PRINT:GOTO *RCV.END
2050 *ESC.F ' -----Notify 8-digit number
2060 IF R.CODE$<>"F" THEN GOTO *ESC.H
2070 PRINT "Numeral table #: ";VAL("&H"+MID$(RCV$,3,2))
2080 PRINT "Input decimal value: ";VAL(MID$(RCV$,5,9))
2090 PRINT:GOTO *RCV.END

```

```
2100 *ESC.H ' -----Notify touch switch (number)
2110 IF R.CODE$<>"H" THEN GOTO *ESC.G
2120 PRINT "Pressed touch switch number:";VAL("&H"+MID$(RCV$,3,2))
2130 PRINT:GOTO *RCV.END
2140 *ESC.G ' -----Notify function key (number)
2150 IF R.CODE$<>"G" THEN GOTO *ESC.I
2160 PRINT "Input function key number:";VAL("&H"+MID$(RCV$,3,2))
2170 PRINT:GOTO *RCV.END
2180 *ESC.I ' -----Notify function key bit
2190 IF R.CODE$<>"I" THEN GOTO *ESC.J
2200 PRINT "Input function key number:";
2210 FK=0
2220 FOR I=0 TO 3
2230   S=VAL("&H"+MID$(RCV$,3+I*2,2))
2240   FOR J=0 TO 7
2250     IF (S MOD 2)=1 THEN PRINT FK;" ";
2260     S=S\2:FK=FK+1
2270   NEXT J,I
2280 PRINT:PRINT:GOTO *RCV.END
2290 *ESC.J ' -----Notify touch switch (bit)
2300 IF R.CODE$<>"J" THEN GOTO *ESC.S
2310 PRINT "Pressed touch switch number:";
2320 TS=0
2330 FOR I=0 TO 3
2340   S=VAL("&H"+MID$(RCV$,3+I*2,2))
2350   FOR J=0 TO 7
2360     IF (S MOD 2)=1 THEN PRINT TS;" ";
2370     S=S\2:TS=TS+1
2380   NEXT J,I
2390 PRINT:PRINT:GOTO *RCV.END
2400 *ESC.S ' -----Notify lamp and touch switch status
2410 IF R.CODE$<>"S" THEN GOTO *ESC.5B
2420 PRINT "Lamp/touch switch number:";VAL("&H"+MID$(RCV$,4,2))
2430 M=VAL(MID$(RCV$,3,1))
2440 IF M=0 THEN M$="OFF" ELSE IF M=1 THEN M$="ON" ELSE M$="INVERSE"
2450 PRINT "Display status:";M$
2460 PRINT:GOTO *RCV.END
2470 *ESC.5B ' -----Notify internal status
2480 IF R.CODE$<>"[" THEN GOTO *RCV.ERR
2490 IF MID$(RCV$,3,2)="00" THEN M$="Voltage OK" ELSE M$="Voltage low"
2500 PRINT "Internal battery:";M$
2510 PRINT:GOTO *RCV.END
2520 '
2530 *RCV.ERR
2540 PRINT "Receive data error"
2550 PRINT
2560 '
2570 *RCV.END
2580 RY=CSRLIN
2590 LOCATE SX,SY
2600 *NORCV
2610 RETURN
2620 '
2630 *ESC.0 ' -----Display specified screen
2640 LOCATE 32,0:INPUT "Screen number:";M
2650 M$=RIGHT$("000"+HEX$(M),4)
```

```

2660 SEND$=SEND$+M$
2670 RETURN
2680 *ESC.X ' -----Screen # enquiry
2690 RETURN
2700 *ESC.B ' -----Write character screen
2710 LOCATE 32,0:INPUT "Character-screen memory table number:";M
2720 LOCATE 32,1:INPUT "Write character string:",C$
2730 M$=RIGHT$("0"+HEX$(M),2)
2740 C$=LEFT$(C$,40):L$=RIGHT$("0"+HEX$(LEN(C$)),2)
2750 SEND$=SEND$+L$+M$+C$
2760 RETURN
2770 *ESC.C ' -----Write 4-digit number
2780 LOCATE 32,0:INPUT "Numeral table #:";M
2790 LOCATE 32,1:INPUT "Write 1 to 4-digit number:";N%
2800 IF N%<-9999 OR N%>9999 THEN GOTO 2790
2810 IF N%<0 THEN S$="-" ELSE S$="+"
2820 M$=RIGHT$("0"+HEX$(M),2)
2830 N%=ABS(N%)
2840 N$=STR$(N%):N$=RIGHT$(N$,LEN(N$)-1):N$=RIGHT$("000"+N$,4)
2850 SEND$=SEND$+M$+S$+N$
2860 RETURN
2870 *ESC.D ' -----Write 8-digit number
2880 LOCATE 32,0:INPUT "Numeral table #:";M
2890 LOCATE 32,1:INPUT "Write 1 to 8-digit number:";N#
2900 N#=INT(N#)
2910 IF N#<-99999999# OR N#>99999999# THEN GOTO 2890
2920 IF N#<0 THEN S$="-" ELSE S$="+"
2930 M$=RIGHT$("0"+HEX$(M),2)
2940 N#=ABS(N#)
2950 N$=STR$(N#):N$=RIGHT$(N$,LEN(N$)-1):N$=RIGHT$("0000000"+N$,8)
2960 SEND$=SEND$+M$+S$+N$
2970 RETURN
2980 *ESC.2F ' -----Copy memory table
2990 LOCATE 32,0:INPUT "0:character string/1:number ";M$
3000 IF M$<>"0" AND M$<>"1" THEN 2990
3010 LOCATE 32,1:INPUT "Copy source memory table number:";S%
3020 LOCATE 32,2:INPUT "Copy destination memory table number:";D%
3030 S$=STR$(S%):S$=RIGHT$(S$,LEN(S$)-1):S$=RIGHT$("00"+S$,3)
3040 D$=STR$(D%):D$=RIGHT$(D$,LEN(D$)-1):D$=RIGHT$("00"+D$,3)
3050 SEND$=SEND$+M$+S$+D$
3060 RETURN
3070 *ESC.U ' -----Disable inputs
3080 LOCATE 32,0:PRINT "Set disabled items"
3090 LOCATE 32,1:PRINT " 0:Function key/touch switch"
3100 LOCATE 32,2:PRINT " 1:Function key only"
3110 LOCATE 32,3:PRINT " 2:Touch switch only"
3120 LOCATE 32,4:INPUT " ";M$
3130 IF M$<>"0" AND M$<>"1" AND M$<>"2" THEN GOTO 3120
3140 SEND$=SEND$+M$
3150 RETURN
3160 *ESC.V ' -----Enables inputs
3170 LOCATE 32,0:PRINT "Set enabled items"
3180 LOCATE 32,1:PRINT " 0:Function key/touch switch"
3190 LOCATE 32,2:PRINT " 1:Function key only"
3200 LOCATE 32,3:PRINT " 2:Touch switch only"
3210 LOCATE 32,4:INPUT " ";M$

```

```

3220 IF M$<>"0" AND M$<>"1" AND M$<>"2" THEN GOTO 3210
3230 SEND$=SEND$+M$
3240 RETURN
3250 *ESC.Q ' -----Display lamps and touch switches (number)
3260 LOCATE 32,0:PRINT "Display setting"
3270 LOCATE 32,1:PRINT " 0:OFF"
3280 LOCATE 32,2:PRINT " 1:ON"
3290 LOCATE 32,3:PRINT " 2:Inverse flashing (lamps only)"
3300 LOCATE 32,4:PRINT " 3:All ON"
3310 LOCATE 32,5:INPUT ":",M$
3320 IF M$<>"0" AND M$<>"1" AND M$<>"2" AND M$<>"3" THEN GOTO 3310
3330 LOCATE 32,6:INPUT "Lamp/touch switch number:",N
3340 N$=RIGHT$("0"+HEX$(N),2)
3350 SEND$=SEND$+M$+N$
3360 RETURN
3370 *ESC.K ' -----Display lamps and touch switches (bits)
3380 FOR I=0 TO 31:TS.B(I)=-1:NEXT I
3390 FOR I=0 TO 31
3400   LOCATE 57-(I MOD 8)*3,I\8:PRINT RIGHT$(STR$(I),2)
3410 NEXT I
3420 LOCATE 32,4:PRINT "Input #: Inverse Input: Run input 99: Execute"
3430 *ESC.K.2
3440 COLOR 0:LOCATE 32,5:PRINT SPACE$(47)
3450 LOCATE 32,5:INPUT "Lamp/touch switch number:",N
3460 IF N=99 THEN GOTO *ESC.K.3
3470 IF N<0 OR N>31 THEN GOTO *ESC.K.2
3480 TS.B(N)=TS.B(N)*(-1)
3490 COLOR 2+TS.B(N)*2
3500 LOCATE 57-(N MOD 8)*3,N\8:PRINT RIGHT$(STR$(N),2)
3510 GOTO *ESC.K.2
3520 *ESC.K.3
3530 FOR I=0 TO 3
3540   M=0
3550   FOR J=0 TO 7
3560     IF TS.B(I*8+J)=1 THEN M=M+2^J
3570   NEXT J
3580   SEND$=SEND$+RIGHT$("0"+HEX$(M),2)
3590 NEXT I
3600 COLOR 0
3610 RETURN
3620 *ESC.R ' -----Enquire lamp and touch switch status
3630 LOCATE 32,0:INPUT "Lamp/touch switch number:",N
3640 N$=RIGHT$("0"+HEX$(N),2)
3650 SEND$=SEND$+N$
3660 RETURN
3670 *ESC.T ' -----Buzzer control
3680 LOCATE 32,0:PRINT "Controlled item"
3690 LOCATE 32,1:PRINT " 0:Stop buzzer"
3700 LOCATE 32,2:PRINT " 1:Continuous buzzer"
3710 LOCATE 32,3:PRINT " 2:Intermittent buzzer"
3720 LOCATE 32,4:INPUT ":",M$
3730 IF M$<>"0" AND M$<>"1" AND M$<>"2" THEN GOTO 3720
3740 SEND$=SEND$+M$
3750 RETURN
3760 *ESC.5E ' -----Alarm control
3770 LOCATE 32,0:PRINT "Controlled item"

```

```

3780 LOCATE 32,1:PRINT " 0:Alarm output OFF"
3790 LOCATE 32,2:PRINT " 1:Alarm output ON"
3800 LOCATE 32,3:INPUT ":",M$
3810 IF M$<>"0" AND M$<>"1" THEN GOTO 3800
3820 SEND$=SEND$+M$
3830 RETURN
3840 *ESC.5D ' -----Initialize display history
3850 RETURN
3860 *ESC.Z ' -----Enquire PT status
3870 RETURN
3880 *ESC.5F ' -----Display mode
3890 LOCATE 32,0:PRINT "Controlled item"
3900 LOCATE 32,1:PRINT " 0:Normal display"
3910 LOCATE 32,2:PRINT " 1:Inverse display"
3920 LOCATE 32,3:INPUT ":",M$
3930 IF M$<>"0" AND M$<>"1" THEN GOTO 3920
3940 SEND$=SEND$+M$
3950 RETURN
3960 *ESC.W ' -----Permit mode switching
3970 LOCATE 32,0:PRINT "Controlled item"
3980 LOCATE 32,1:PRINT " 0:Enable"
3990 LOCATE 32,2:PRINT " 1:Disable"
4000 LOCATE 32,3:INPUT ":",M$
4010 IF M$<>"0" AND M$<>"1" THEN GOTO 4000
4020 SEND$=SEND$+M$
4030 RETURN
4040 *ESC.P ' -----Display screen
4050 LOCATE 32,0:PRINT "Controlled item"
4060 LOCATE 32,1:PRINT " 0:Display"
4070 LOCATE 32,2:PRINT " 1:No display"
4080 LOCATE 32,3:INPUT ":",M$
4090 IF M$<>"0" AND M$<>"1" THEN GOTO 4080
4100 SEND$=SEND$+M$
4110 RETURN
4120 '
4130 *SELECT ' -----Item selection routine
4140 COLOR 4:LOCATE LV*16,0:PRINT CMND$(SECT.NO,1,0)
4150 COLOR 0
4160 FOR I=2 TO CMND(SECT.NO)
4170   LOCATE LV*16,I-1:PRINT CMND$(SECT.NO,I,0)
4180 NEXT I
4190 *KY.IN
4200 A$=INKEY$:IF A$="" THEN GOTO *KY.IN
4210 IF A$<>CHR$(&H1B) THEN GOTO *KY1
4220   COLOR 0
4230   FOR I=1 TO CMND(SECT.NO)
4240     LOCATE LV*16,I-1:PRINT SPACE$(14)
4250   NEXT I
4260   SEL.NO=0
4270   GOTO *SEL.RET
4280 *KY1
4290 IF A$<>CHR$(&H1E) AND A$<>CHR$(&H1F) THEN GOTO *KY2
4300   COLOR 0:LOCATE LV*16,SEL.NO-1:PRINT CMND$(SECT.NO,SEL.NO,0)
4310   IF A$=CHR$(&H1E) THEN SEL.NO=SEL.NO-1 ELSE SEL.NO=SEL.NO+1
4320   IF SEL.NO=0 THEN SEL.NO=CMND(SECT.NO)
4330   IF SEL.NO>CMND(SECT.NO) THEN SEL.NO=1

```

```
4340  COLOR 4:LOCATE LV*16,SEL.NO-1:PRINT CMND$(SECT.NO,SEL.NO.0)
4350  GOTO *KY.IN
4360  *KY2
4370  IF A$<>CHR$(&HD) THEN GOTO *KY.IN
4380  *SEL.RET
4390  COLOR 0
4400  RETURN
4410  DATA "Screen control","Memory table ","Tsw/Fky input ",
"Lmp/Tsw disp. ","Control system"
4420  DATA 2
4430  DATA "Display screen ","[ESC]O"
4440  DATA "Enquire screen #","[ESC]X"
4450  DATA 4
4460  DATA "Write chr string","[ESC]B"
4470  DATA "Write 4-digit no","[ESC]C"
4480  DATA "Write 8-digit no","[ESC]D"
4490  DATA "Copy memory tbl ","[ESC]/"
4500  DATA 2
4510  DATA "Disable input  ","[ESC]U"
4520  DATA "Enable input   ","[ESC]V"
4530  DATA 3
4540  DATA "Disp (specify #)","[ESC]Q"
4550  DATA "Disp(spec. bit) ","[ESC]K"
4560  DATA "Enquire display ","[ESC]R"
4570  DATA 7
4580  DATA "Buzzer          ","[ESC]T"
4590  DATA "Alarm            ","[ESC]^"
4600  DATA "Display history ","[ESC]]"
4610  DATA "Enquire PTstatus","[ESC]Z"
4620  DATA "Display mode     ","[ESC]_"
4630  DATA "Switch mode      ","[ESC]W"
4640  DATA "Display screen  ","[ESC]P"
```

SECTION 9

Troubleshooting

This section describes the cause of errors and possible remedies.

9-1	Errors Occurring when the Power is Turned ON	66
9-2	Troubleshooting Communication Errors	66

9-1 Errors Occurring when the Power is Turned ON

Refer to the table below for the causes and remedies for errors occurring when the PT power is turned on.

General source of error	Cause	Remedy
No Host Interface Unit	No RS-232C Interface Unit or RS-422 Interface Unit installed. The installed system ROM is not compatible with the RS-232C Interface Unit or RS-422 Interface Unit.	Install the RS-232C Interface Unit or RS-422 Interface Unit. Check and install the appropriate ROM for the RS-232C Interface Unit or RS-422 Interface Unit.
Memory not formatted	Screen data memory board not installed. EEPROM or EPROM not mounted correctly on the the screen data memory board. The image memory board DIP switch settings do not match the specifications of the memory chip. Memory initialization has not be completed.	Correctly install the screen data memory board. Correctly mount the memory chip on the image memory board. Correctly set the image memory board DIP switches. Perform memory initialization.
Screen data corrupted	The screen data is not compatible with the System ROM. The power supply was turned off during transmission of the screen data.	Create the correct screen data with the Support Tool. Transfer the screen data once more with the Support Tool.
Mark data corrupted	The power supply was turned off during transmission of the screen data. Transmission of the screen data was interrupted.	Transfer the screen data once more with the Support Tool.
Message characters missing/changed	DIP switches 1-3 are incorrectly set.	Turn the Unit's power OFF, set DIP switches 1-3 to ON, and turn power ON.

9-2 Troubleshooting Communication Errors

Refer to the following table for appropriate remedies when a communication error occurs during Run operation.

Description	Cause	Remedy
Timeout	A 5-second gap occurred during transmission of one command.	Make sure the command length is correct. Check the cable connections.
ACIA Parity error ACIA overrun error ACIA framing error	Communication conditions set incorrectly Data corrupted during transmission due to noise.	Make sure that the PT settings for data bits, stop bits, parity, and flow control match the host computer settings. Use a noise-resistant cable for operation in an environment with high noise levels.
Buffer overflow	PT receive buffer is full.	Increase the interval between command transmissions. Send with flow control to increase transmission frequency.

Note A communication error message is displayed and a buzzer sounds if the PT DIP switch (SW1-1) is set off (no automatic reset after communication error). Press the PT Buzzer Key or PT Enter Key to return to the Run mode before correcting the cause of the error.

The command causing the error is invalid and not executed.

Communication Error During Online Transfer

The following communication error may occur during online transfer.

PT operation	Cause	Remedy
Operation returns to Run mode before online transfer is complete.	The interval between online transfer commands exceeded 60 seconds.	Set the interval between online transfer commands to less than 60 seconds.

During online transfer command execution, the following error codes may be notified with the Not-Acknowledged Command.

Error code	Cause	Remedy
F0H (memory full)	Insufficient memory during host computer to PT transfer of screen data.	Replace the screen data memory with one of a larger capacity.
F1H (command error 1)	Data transfer command received although no transfer notify command was sent from the host computer to the PT.	Check the order of the commands and execute the Online Transfer Command again.
	Online Transfer Command received although screen data memory is EPROM.	Replace screen data memory with an SRAM type.
F2H (command error 2)	Another command was received during standby for the Data Transfer Command.	Check the order of the commands and execute the data transfer again.
F3H (process interrupted)	During data transfer the j or i key was pressed or a different Online Transfer Command was received.	Check the order of the commands and execute the Online Transfer Command again.
F4H (checksum error)	Incorrect checksum	Check the checksum.
F9H (screen data memory error)	Online Transfer Command received although screen data memory is EEPROM.	Replace screen data memory with an SRAM type.

Appendix A

Communication Specifications

RS-232C Interface Unit

Item	Specification
Communication standard	EIA RS-232C
Communication settings	Start-stop synchronization Baud rate: 300, 600, 1200, 4800, 9600, 19200 bps Data bits: 7, 8 Stop bits: 1, 2 Parity: Even/Odd/None Flow control: RS/CS control XON/XOFF control None
Connectors	25-pin D-SUB female Optical connection compatible
No. of Units	1-to-1
Transmission distance	Max. 15 m (up to 500 m using optical-fiber cable)

RS-422 Interface Unit

Item	Specification
Communication standard	EIA RS-422
Communication settings	Start-stop synchronization Baud rate: 300, 600, 1200, 4800, 9600, 19200 bps Data bits: 7, 8 Stop bits: 1, 2 Parity: Even/Odd/None Flow control: XON/XOFF control None
Connectors	9-pin D-SUB female
No. of Units	1-to-16 max.
Transmission distance	Max. 500 m (including branch wires/max. branch wire length 10 m)

Appendix B

RS-232C and RS-422 Connector Cables

Preparing RS-232C Connector Cables

Prepare a connector cable to connect a PT to a host computer separated by more than 2 m so that the supplied connector cable (XZ7-10048) cannot be used. The maximum cable length is 15 m.

Recommended Parts

Name	Model	Remarks
Connector (RS-232C Interface Unit end)	XM2A-2501	25-pin, manufactured by OMRON. Supplied with RS-232C Interface Unit.
	DB-25P	25-pin, manufactured by JAE.
Connector cover (RS-232C Interface Unit end)	XM2S-2511	25-pin, manufactured by OMRON. Supplied with RS-232C Interface Unit.
	DB-C2-J9	25-pin, manufactured by JAE.
Cable	AWG28 * 5P IFVV-SB	Multicore cable, manufactured by Fujikura.
	CO-MA-VV-SB 5P * 28AWG	Multicore cable, manufactured by Hitachi Cable.

On the other end of the cable use the type of connector and connector cover which matches the host computer connector type.

Connection For Host

Only the shielded wire on the host side is connected to the connector hood and connector pin 1. The following diagram is for RS/CS control. If no RS/CS control is executed, RS and CS must be short-circuited (turned over) for both the PT and host side.

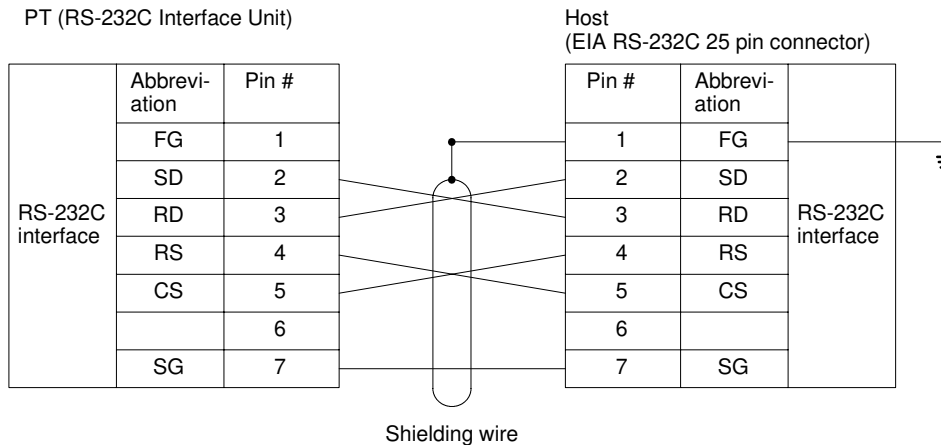

Note For some host computers the combination of pin numbers and signal names may differ from those shown in the diagram above. Refer to the host computer instruction manual before wiring the connector.

Preparing RS-422 Connector Cables

Prepare a connector cable to connect a PT to a host computer separated by more than 15 m. The maximum cable length is 500 m.

Recommended Parts

Name	Model	Remarks
Connector (RS-422 Interface Unit end)	XM2A-0901	9-pin, manufactured by OMRON. Supplied with RS-422 Interface Unit.
	DE-9P	9-pin, manufactured by JAE.
Connector cover (RS-422 Interface Unit end)	XM2S-0911	9-pin, manufactured by OMRON. Supplied with RS-422 Interface Unit.
	DE-CI-J6	9-pin, manufactured by JAE.
Cable	H-9293A (CO-HC-ESV-3P * 7/0.2)	RS-422 cable manufactured by HIRAKAWA HEWTECH.

On the other end of the cable use the type of connector and connector cover which matches the host computer connector type.

Connections

The wiring connection for the B500-AL004 (-P) Link Adaptor is shown below.

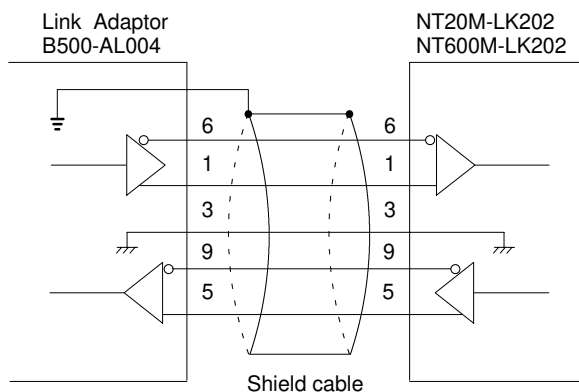

Note When connecting to some equipment, the combination of pin numbers and signal names may differ from those shown in the diagram above. Refer to the equipment instruction manual before wiring the connector.

Appendix C

Connections Using Different Cable Types

The Link Adaptor allows an RS-232C cable to be connected to an RS-422 or an optical fiber cable. The connecting cable wiring to the pins depends on the specification of the host computer connector. Check the specification of the host computer connector before wiring according to the Link Adaptor connector specification.

Link Adaptors

The Link Adaptor is a converter to connect different types of communication cables together. Set the switches as shown below when a Link Adaptor is used.

The B500-AL004 (-P) Link Adaptor is used.

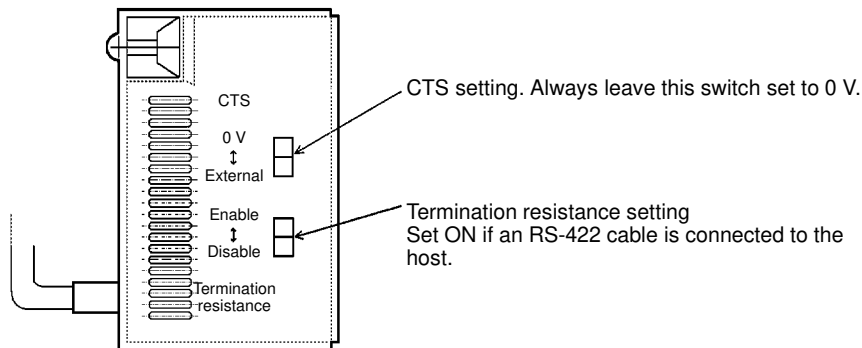

Link Adaptor Connector Specifications

RS-232C Cable Connection

Connector: RS-232C

Electrical characteristics: Complies with EIA RS-232C

Signal direction: Signal input and output is relative to the PT.

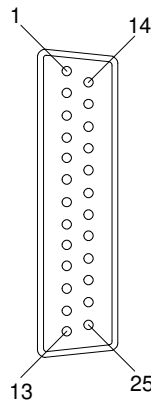

Connector pin #	Signal name	Abbreviation	Signal direction	
			Input	Output
1	Frame ground	FG	---	---
2	Send data	SD (TXD)		Yes
3	Receive data	RD (RXD)	Yes	
4	Request to send	RS (RTS)		Yes
5	Clear to send	CS (CTS)	Yes	
6		DR	---	---
7	Signal ground	SG (GND)	---	---
8		CD		
20	Data terminal ready	ER (DTR)		Yes

RS-422 Cable Connection

Connector: RS-422

Electrical characteristics: Complies with EIA RS-422

Signal direction: Signal input and output is relative to the PT or host.

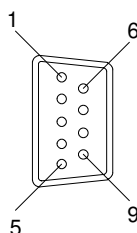

Connector pin #	Signal name	Abbreviation	Signal direction	
			Input	Output
1	Receive data B (+)	RDB	Yes	
3	Signal ground	SG	---	---
5	Send data B (+)	SDB		Yes
6	Receive data A (-)	RDA	Yes	
7	Frame ground	SG (GND)	---	---
9	Send data A (-)	SDA		Yes

Optical-fiber Cable Connections

Maximum connection length is 500 m.

System configuration: 1-to-1 connection

The parts required for the connector cable are shown in the table below.

Name	Model	Remarks
RS-232C connector cable	XZ7-10048	25-pin to 25-pin (2 m) manufactured by OMRON
Optical fiber cable		3 types of optical-fiber cable can be used: APF (plastic optical-fiber cable) PCF (plastic-clad optical-fiber cable) H-PCF (hard plastic-clad quartz optical-fiber cable)
Link Adaptor	B500-AL004(-P)	100/200 VAC, manufactured by OMRON

The transmission distance depends on the type of cable and the type of Link Adaptor.

Optical-fiber cable	B500-AL004-P	B500-AL004
APF	20 m	No connection
H-PCF	100 m	200 m
PCF	200 m	800 m

Refer to the optical fiber and Link Adaptor manuals for information on the optical-fiber cable specifications.

Appendix D

Special Characters

English Character Codes

Pin 3 of SW1 must be ON to enable English language messages to use the following codes.

Example: Hex code is represented by 30, decimal code by 48, and character by 0.

30	0
48	

Code 20 and 32 in the table represents a space, as indicated by "SP".

Hex Digits 1st → 2nd ↓	2-		3-		4-		5-		6-		7-		8-		9-	
-0	20	SP	30	0	40	@	50	P	60	‘	70	p	80	Ç	90	É
	32		48		64		80		96		112		128		144	
-1	21	!	31	1	41	A	51	Q	61	a	71	q	81	ü	91	æ
	33		49		65		81		97		113		129		145	
-2	22	”	32	2	42	B	52	R	62	b	72	r	82	é	92	Æ
	34		50		66		82		98		114		130		146	
-3	23	#	33	3	43	C	53	S	63	c	73	s	83	â	93	ô
	35		51		67		83		99		115		131		147	
-4	24	\$	34	4	44	D	54	T	64	d	74	t	84	ä	94	ö
	36		52		68		84		100		116		132		148	
-5	25	%	35	5	45	E	55	U	65	e	75	u	85	à	95	ò
	37		53		69		85		101		117		133		149	
-6	26	&	36	6	46	F	56	V	66	f	76	v	86	á	96	û
	38		54		70		86		102		118		134		150	
-7	27	’	37	7	47	G	57	W	67	g	77	w	87	ç	97	ù
	39		55		71		87		103		119		135		151	
-8	28	(38	8	48	H	58	X	68	h	78	x	88	ê	98	ÿ
	40		56		72		88		104		120		136		152	
-9	29)	39	9	49	I	59	Y	69	i	79	y	89	ë	99	Û
	41		57		73		89		105		121		137		153	
-A	2A	*	3A	:	4A	J	5A	Z	6A	j	7A	z	8A	è	9A	Ü
	42		58		74		90		106		122		138		154	
-B	2B	+	3B	;	4B	K	5B	[6B	k	7B	{	8B	ï	9B	ç
	43		59		75		91		107		123		139		155	
-C	2C	,	3C	<	4C	L	5C	\	6C	l	7C		8C	î	9C	£
	44		60		76		92		108		124		140		156	
-D	2D	-	3D	=	4D	M	5D]	6D	m	7D	}	8D	ì	9D	¥
	45		61		77		93		109		125		141		157	
-E	2E	.	3E	>	4E	N	5E	^	6E	n	7E	~	8E	Ä	9E	Pt
	46		62		78		94		110		126		142		158	
-F	2F	/	3F	?	4F	O	5F	_	6F	o	7F	◊	8F	Å	9F	f
	47		63		79		95		111		127		143		159	

Hex Digits 1st → 2nd ↓	A-		B-		C-		D-		E-		F-	
-0	A0	á	B0	⋮	C0	└	D0	⊥	E0	α	F0	≡
	160		176	⋮	192	└	208	⊥	224		240	
-1	A1	í	B1	■	C1	└	D1	⊥	E1	β	F1	+
	161		177		193	└	209	⊥	225		241	
-2	A2	ó	B2	⋮	C2	└	D2	⊥	E2	Γ	F2	≥
	162		178	⋮	194	└	210	⊥	226		242	
-3	A3	ú	B3		C3	└	D3	⊥	E3	π	F3	≤
	163		179		195	└	211	⊥	227		243	
-4	A4	ñ	B4	└	C4	—	D4	⊥	E4	Σ	F4	∫
	164		180		196		212	⊥	228		244	
-5	A5	Ñ	B5	⊥	C5	+	D5	⊥	E5	σ	F5	J
	165		181		197		213	⊥	229		245	
-6	A6	á	B6	⊥	C6	⊥	D6	⊥	E6	m	F6	÷
	166		182		198		214	⊥	230		246	
-7	A7	ó	B7	⊥	C7	⊥	D7	⊥	E7	τ	F7	≈
	167		183		199		215	⊥	231		247	
-8	A8	¿	B8	└	C8	⊥	D8	⊥	E8	Φ	F8	%
	168		184		200	⊥	216	⊥	232		248	
-9	A9	└	B9	⊥	C9	└	D9	└	E9	Θ	F9	·
	169		185		201	└	217	└	233		249	
-A	AA	└	BA		CA	⊥	DA	└	EA	w	FA	•
	170		186		202	⊥	218	└	234		250	
-B	AB	1/2	BB	└	CB	⊥	DB	■	EB	δ	FB	√
	171		187		203	⊥	219	■	235		251	
-C	AC	1/4	BC	└	CC	⊥	DC	■	EC	∞	FC	n
	172		188		204	⊥	220	■	236		252	
-D	AD	i	BD	└	CD	=	DD	■	ED	f	FD	2
	173		189		205	=	221	■	237		253	
-E	AE	«	BE	└	CE	⊥	DE	■	EE	ε	FE	■
	174		190		206	⊥	222	■	238		254	
-F	AF	»	BF	└	CF	⊥	DF	■	EF	∩	FF	
	175		191		207	⊥	223	■	239		255	

Revision History

A manual revision code appears as a suffix to the catalog number on the front cover of the manual.

Cat. No. V016-E1-1

↑
Revision code

The following table outlines the changes made to the manual during each revision. Page numbers refer to the previous version.

Revision code	Date	Revised content
1	October 1993	Original production