

# Pushbutton Switch A22

## Install in 22-dia. or 25-dia. Panel Cutout

- Easy mounting and removal of Switch Unit.
- Increase wiring efficiency with three-row mounting of Switch Blocks.
- Finger protection mechanism on Switch Unit provided as a standard feature.
- Use 25-dia. ring to install in 25-dia. panel cutouts.
- Mounted using either open-type (fork-type) or closed-type (round-type) crimp terminals.
- Wide range of shapes and colors.
- IP65 oil resistance (non-lighted models)  
IP65 (lighted models)
- EN60947-5-1
- UL and cUL approved (File No. E41515)



## Model Number Structure

### Model Number Legend

#### Completely Assembled

Shipped as a set which includes the Pushbutton, Lamp (lighted type only), and Switch.

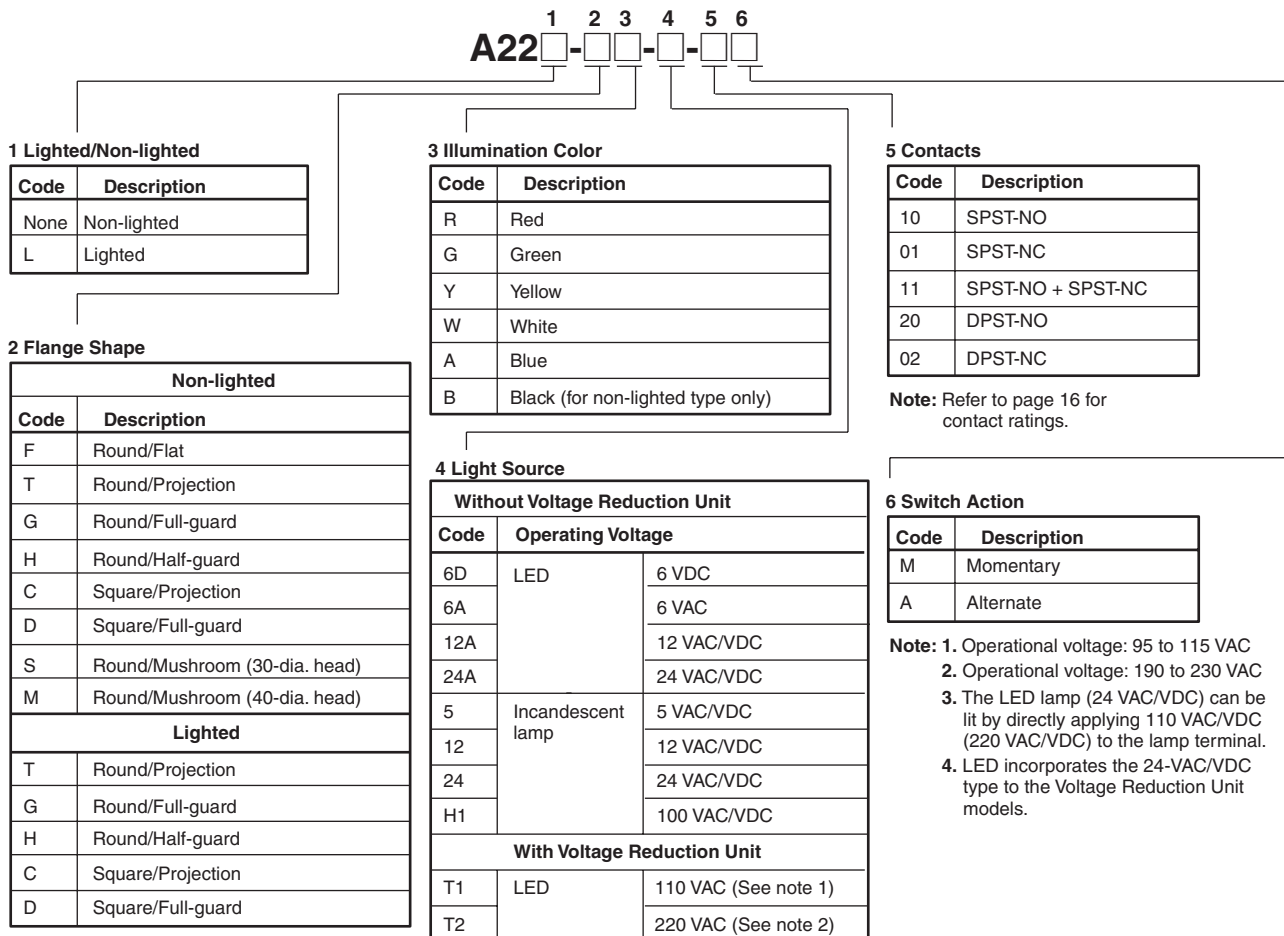

## Subassembled

The Pushbutton, Lamp, or Switch can be ordered separately. Use them in combination for models that are not available as assembled Units. These can also be used as inventory for maintenance parts.

### 1. Pushbutton

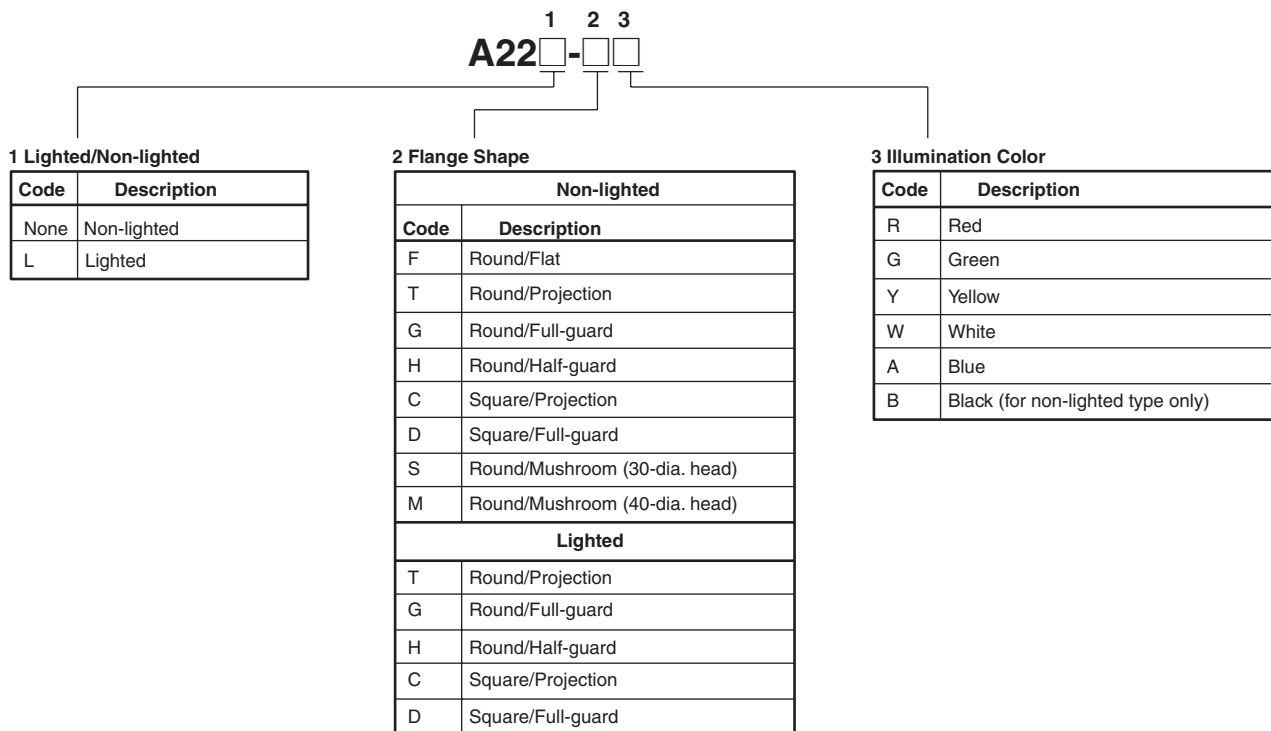

### 2. Lamp

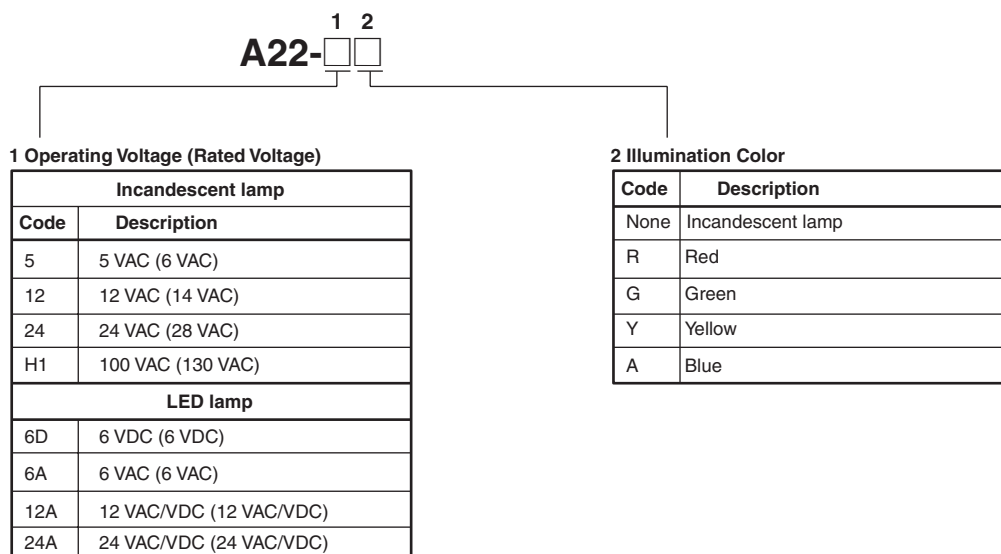

### 3. Switch (Standard Load)

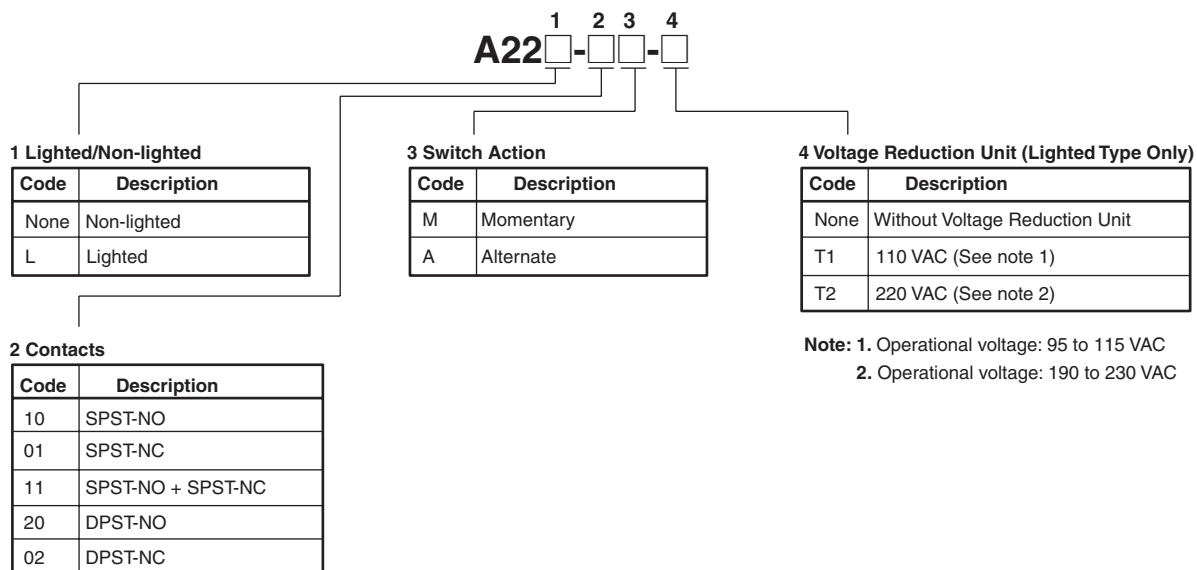



# Ordering Information

## ■ List of Models

### Ordering as a Set

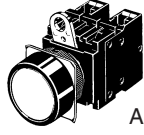
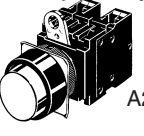
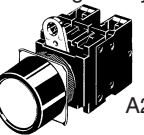
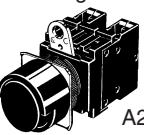
#### Non-lighted (Round Type)

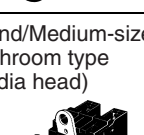
Appearance	Output	Momentary operation (self-resetting)	Alternate operation (self-holding)	Illumination color
Round/Flat type  A22-F	SPST-NO	A22-F□-10M	A22-F□-10A	Insert one of the following letters into the box □. R (red) Y (yellow) G (green) W (white) A (blue) B (black)
	SPST-NC	A22-F□-01M	A22-F□-01A	
	SPST-NO + SPST-NC	A22-F□-11M	A22-F□-11A	
	DPST-NO	A22-F□-20M	A22-F□-20A	
	DPST-NC	A22-F□-02M	A22-F□-02A	
Round/Projection type  A22-T	SPST-NO	A22-T□-10M	A22-T□-10A	
	SPST-NC	A22-T□-01M	A22-T□-01A	
	SPST-NO + SPST-NC	A22-T□-11M	A22-T□-11A	
	DPST-NO	A22-T□-20M	A22-T□-20A	
	DPST-NC	A22-T□-02M	A22-T□-02A	
Round/Full-guard type  A22-G	SPST-NO	A22-G□-10M	A22-G□-10A	
	SPST-NC	A22-G□-01M	A22-G□-01A	
	SPST-NO + SPST-NC	A22-G□-11M	A22-G□-11A	
	DPST-NO	A22-G□-20M	A22-G□-20A	
	DPST-NC	A22-G□-02M	A22-G□-02A	
Round/Half-guard type  A22-H	SPST-NO	A22-H□-10M	A22-H□-10A	Insert one of the following letters into the box □. R (red) Y (yellow) G (green) W (white) A (blue) B (black)
	SPST-NC	A22-H□-01M	A22-H□-01A	
	SPST-NO + SPST-NC	A22-H□-11M	A22-H□-11A	
	DPST-NO	A22-H□-20M	A22-H□-20A	
	DPST-NC	A22-H□-02M	A22-H□-02A	
Round/Small-size Mushroom type (30-dia. head)  A22-S	SPST-NO	A22-S□-10M	A22-S□-10A	
	SPST-NC	A22-S□-01M	A22-S□-01A	
	SPST-NO + SPST-NC	A22-S□-11M	A22-S□-11A	
	DPST-NO	A22-S□-20M	A22-S□-20A	
	DPST-NC	A22-S□-02M	A22-S□-02A	
Round/Medium-size Mushroom type (40-dia head)  A22-M	SPST-NO	A22-M□-10M	A22-M□-10A	
	SPST-NC	A22-M□-01M	A22-M□-01A	
	SPST-NO + SPST-NC	A22-M□-11M	A22-M□-11A	
	DPST-NO	A22-M□-20M	A22-M□-20A	
	DPST-NC	A22-M□-02M	A22-M□-02A	

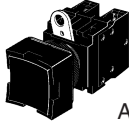

**Non-lighted (Square Type)**

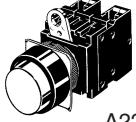

Appearance	Output	Momentary operation (self-reset)	Alternate operation (self-holding)	Illumination color
Square/Projection type  A22-C	SPST-NO	A22-C□-10M	A22-C□-10A	Insert one of the following letters into the box □. R (red) Y (yellow) G (green) W (white) A (blue) B (black)
	SPST-NC	A22-C□-01M	A22-C□-01A	
	SPST-NO + SPST-NC	A22-C□-11M	A22-C□-11A	
	DPST-NO	A22-C□-20M	A22-C□-20A	
	DPST-NC	A22-C□-02M	A22-C□-02A	
Square/Guard type  A22-D	SPST-NO	A22-D□-10M	A22-D□-10A	
	SPST-NC	A22-D□-01M	A22-D□-01A	
	SPST-NO + SPST-NC	A22-D□-11M	A22-D□-11A	
	DPST-NO	A22-D□-20M	A22-D□-20A	
	DPST-NC	A22-D□-02M	A22-D□-02A	

**Lighted (Round Type)**

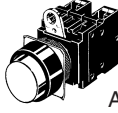
Appearance	Output	Lighting	Operating voltage	Momentary operation (self-resetting)	Alternate operation (self-holding)	Illumination color
Round/Projection type LED lighting (without Voltage Reduction Unit)  A22L-T	SPST-NO	LED	6 VDC	A22L-T□-6D-10M	A22L-T□-6D-10A	Insert one of the following letters into the box □. R (red) Y (yellow) G (green) W (white) A (blue)
			6 VAC	A22L-T□-6A-10M	A22L-T□-6A-10A	
			12 VAC/VDC	A22L-T□-12A-10M	A22L-T□-12A-10A	
			24 VAC/VDC	A22L-T□-24A-10M	A22L-T□-24A-10A	
	SPST-NC		6 VDC	A22L-T□-6D-01M	A22L-T□-6D-01A	
			6 VAC	A22L-T□-6A-01M	A22L-T□-6A-01A	
			12 VAC/VDC	A22L-T□-12A-01M	A22L-T□-12A-01A	
			24 VAC/VDC	A22L-T□-24A-01M	A22L-T□-24A-01A	
	SPST-NO + SPST-NC		6 VDC	A22L-T□-6D-11M	A22L-T□-6D-11A	
			6 VAC	A22L-T□-6A-11M	A22L-T□-6A-11A	
			12 VAC/VDC	A22L-T□-12A-11M	A22L-T□-12A-11A	
			24 VAC/VDC	A22L-T□-24A-11M	A22L-T□-24A-11A	
	DPST-NO		6 VDC	A22L-T□-6D-20M	A22L-T□-6D-20A	
			6 VAC	A22L-T□-6A-20M	A22L-T□-6A-20A	
			12 VAC/VDC	A22L-T□-12A-20M	A22L-T□-12A-20A	
			24 VAC/VDC	A22L-T□-24A-20M	A22L-T□-24A-20A	
	DPST-NC		6 VDC	A22L-T□-6D-02M	A22L-T□-6D-02A	
			6 VAC	A22L-T□-6A-02M	A22L-T□-6A-02A	
			12 VAC/VDC	A22L-T□-12A-02M	A22L-T□-12A-02A	
			24 VAC/VDC	A22L-T□-24A-02M	A22L-T□-24A-02A	



Pushbutton Switches

Appearance	Output	Lighting	Operating voltage	Momentary operation (self-resetting)	Alternate operation (self-holding)	Illumination color	
Round/Projection type LED voltage-reduction lighting (with Voltage Reduction Unit)  A22L-T	SPST-NO	LED	110 VAC	A22L-T□-T1-10M	A22L-T□-T1-10A	Insert one of the following letters into the box □. R (red) Y (yellow) G (green) W (white) A (blue)	
			220 VAC	A22L-T□-T2-10M	A22L-T□-T2-10A		
	SPST-NC		110 VAC	A22L-T□-T1-01M	A22L-T□-T1-01A		
			220 VAC	A22L-T□-T2-01M	A22L-T□-T2-01A		
	SPST-NO + SPST-NC		110 VAC	A22L-T□-T1-11M	A22L-T□-T1-11A		
			220 VAC	A22L-T□-T2-11M	A22L-T□-T2-11A		
	DPST-NO		110 VAC	A22L-T□-T1-20M	A22L-T□-T1-20A		
			220 VAC	A22L-T□-T2-20M	A22L-T□-T2-20A		
	DPST-NC		110 VAC	A22L-T□-T1-02M	A22L-T□-T1-02A		
			220 VAC	A22L-T□-T2-02M	A22L-T□-T2-02A		
	Round/Half-guard type LED lighting (without Voltage Reduction Unit)  A22L-H		SPST-NO	6 VDC	A22L-H□-6D-10M		A22L-H□-6D-10A
				6 VAC	A22L-H□-6A-10M		A22L-H□-6A-10A
12 VAC/VDC		A22L-H□-12A-10M		A22L-H□-12A-10A			
24 VAC/VDC		A22L-H□-24A-10M		A22L-H□-24A-10A			
SPST-NC		6 VDC	A22L-H□-6D-01M	A22L-H□-6D-01A			
		6 VAC	A22L-H□-6A-01M	A22L-H□-6A-01A			
		12 VAC/VDC	A22L-H□-12A-01M	A22L-H□-12A-01A			
		24 VAC/VDC	A22L-H□-24A-01M	A22L-H□-24A-01A			
SPST-NO + SPST-NC		6 VDC	A22L-H□-6D-11M	A22L-H□-6D-11A			
		6 VAC	A22L-H□-6A-11M	A22L-H□-6A-11A			
		12 VAC/VDC	A22L-H□-12A-11M	A22L-H□-12A-11A			
		24 VAC/VDC	A22L-H□-24A-11M	A22L-H□-24A-11A			
DPST-NO		6 VDC	A22L-H□-6D-20M	A22L-H□-6D-20A			
		6 VAC	A22L-H□-6A-20M	A22L-H□-6A-20A			
		12 VAC/VDC	A22L-H□-12A-20M	A22L-H□-12A-20A			
		24 VAC/VDC	A22L-H□-24A-20M	A22L-H□-24A-20A			
DPST-NC		6 VDC	A22L-H□-6D-02M	A22L-H□-6D-02A			
		6 VAC	A22L-H□-6A-02M	A22L-H□-6A-02A			
		12 VAC/VDC	A22L-H□-12A-02M	A22L-H□-12A-02A			
		24 VAC/VDC	A22L-H□-24A-02M	A22L-H□-24A-02A			



Appearance	Output	Lighting	Operating voltage	Momentary operation (self-resetting)	Alternate operation (self-holding)	Illumination color
Round/Half-guard type LED voltage-reduction lighting (with Voltage Reduction Unit)  A22L-H	SPST-NO	LED	110 VAC	A22L-H□-T1-10M	A22L-H□-T1-10A	Insert one of the following letters into the box □. R (red) Y (yellow) G (green) W (white) A (blue)
			220 VAC	A22L-H□-T2-10M	A22L-H□-T2-10A	
	SPST-NC		110 VAC	A22L-H□-T1-01M	A22L-H□-T1-01A	
			220 VAC	A22L-H□-T2-01M	A22L-H□-T2-01A	
	SPST-NO + SPST-NC		110 VAC	A22L-H□-T1-11M	A22L-H□-T1-11A	
			220 VAC	A22L-H□-T2-11M	A22L-H□-T2-11A	
	DPST-NO		110 VAC	A22L-H□-T1-20M	A22L-H□-T1-20A	
			220 VAC	A22L-H□-T2-20M	A22L-H□-T2-20A	
	DPST-NC		110 VAC	A22L-H□-T1-02M	A22L-H□-T1-02A	
			220 VAC	A22L-H□-T2-02M	A22L-H□-T2-02A	
Round/Full-guard type LED lighting (without Voltage Reduction Unit)  A22L-G	SPST-NO	6 VDC	A22L-G□-6D-10M	A22L-G□-6D-10A		
		6 VAC	A22L-G□-6A-10M	A22L-G□-6A-10A		
		12 VAC/VDC	A22L-G□-12A-10M	A22L-G□-12A-10A		
		24 VAC/VDC	A22L-G□-24A-10M	A22L-G□-24A-10A		
	SPST-NC	6 VDC	A22L-G□-6D-01M	A22L-G□-6D-01A		
		6 VAC	A22L-G□-6A-01M	A22L-G□-6A-01A		
		12 VAC/VDC	A22L-G□-12A-01M	A22L-G□-12A-01A		
		24 VAC/VDC	A22L-G□-24A-01M	A22L-G□-24A-01A		
	SPST-NO + SPST-NC	6 VDC	A22L-G□-6D-11M	A22L-G□-6D-11A		
		6 VAC	A22L-G□-6A-11M	A22L-G□-6A-11A		
		12 VAC/VDC	A22L-G□-12A-11M	A22L-G□-12A-11A		
		24 VAC/VDC	A22L-G□-24A-11M	A22L-G□-24A-11A		
	DPST-NO	6 VDC	A22L-G□-6D-20M	A22L-G□-6D-20A		
		6 VAC	A22L-G□-6A-20M	A22L-G□-6A-20A		
		12 VAC/VDC	A22L-G□-12A-20M	A22L-G□-12A-20A		
		24 VAC/VDC	A22L-G□-24A-20M	A22L-G□-24A-20A		
	DPST-NC	6 VDC	A22L-G□-6D-02M	A22L-G□-6D-02A		
		6 VAC	A22L-G□-6A-02M	A22L-G□-6A-02A		
		12 VAC/VDC	A22L-G□-12A-02M	A22L-G□-12A-02A		
		24 VAC/VDC	A22L-G□-24A-02M	A22L-G□-24A-02A		
Round/Full-guard type LED voltage-reduction lighting (with Voltage Reduction Unit)  A22L-G	SPST-NO	110 VAC	A22L-G□-T1-10M	A22L-G□-T1-10A		
		220 VAC	A22L-G□-T2-10M	A22L-G□-T2-10A		
	SPST-NC	110 VAC	A22L-G□-T1-01M	A22L-G□-T1-01A		
		220 VAC	A22L-G□-T2-01M	A22L-G□-T2-01A		
	SPST-NO + SPST-NC	110 VAC	A22L-G□-T1-11M	A22L-G□-T1-11A		
		220 VAC	A22L-G□-T2-11M	A22L-G□-T2-11A		
	DPST-NO	110 VAC	A22L-G□-T1-20M	A22L-G□-T1-20A		
		220 VAC	A22L-G□-T2-20M	A22L-G□-T2-20A		
	DPST-NC	110 VAC	A22L-G□-T1-02M	A22L-G□-T1-02A		
		220 VAC	A22L-G□-T2-02M	A22L-G□-T2-02A		

Pushbutton Switches

Lighted (Square Type)

Appearance	Output	Lighting	Operating voltage	Momentary operation (self-resetting)	Alternate operation (self-holding)	Illumination color
Square/Projection type LED lighting (without Voltage Reduction Unit)  A22L-C	SPST-NO	LED	6 VDC	A22L-C□-6D-10M	A22L-C□-6D-10A	Insert one of the following letters into the box □. R (red) Y (yellow) G (green) W (white) A (blue)
			6 VAC	A22L-C□-6A-10M	A22L-C□-6A-10A	
			12 VAC/VDC	A22L-C□-12A-10M	A22L-C□-12A-10A	
			24 VAC/VDC	A22L-C□-24A-10M	A22L-C□-24A-10A	
	SPST-NC		6 VDC	A22L-C□-6D-01M	A22L-C□-6D-01A	
			6 VAC	A22L-C□-6A-01M	A22L-C□-6A-01A	
			12 VAC/VDC	A22L-C□-12A-01M	A22L-C□-12A-01A	
			24 VAC/VDC	A22L-C□-24A-01M	A22L-C□-24A-01A	
	SPST-NO + SPST-NC		6 VDC	A22L-C□-6D-11M	A22L-C□-6D-11A	
			6 VAC	A22L-C□-6A-11M	A22L-C□-6A-11A	
			12 VAC/VDC	A22L-C□-12A-11M	A22L-C□-12A-11A	
			24 VAC/VDC	A22L-C□-24A-11M	A22L-C□-24A-11A	
	DPST-NO		6 VDC	A22L-C□-6D-20M	A22L-C□-6D-20A	
			6 VAC	A22L-C□-6A-20M	A22L-C□-6A-20A	
			12 VAC/VDC	A22L-C□-12A-20M	A22L-C□-12A-20A	
			24 VAC/VDC	A22L-C□-24A-20M	A22L-C□-24A-20A	
	DPST-NC		6 VDC	A22L-C□-6D-02M	A22L-C□-6D-02A	
			6 VAC	A22L-C□-6A-02M	A22L-C□-6A-02A	
			12 VAC/VDC	A22L-C□-12A-02M	A22L-C□-12A-02A	
			24 VAC/VDC	A22L-C□-24A-02M	A22L-C□-24A-02A	
Square/Projection type LED voltage-reduction lighting (with Voltage Reduction Unit)  A22L-C	SPST-NO	110 VAC	A22L-C□-T1-10M	A22L-C□-T1-10A		
		220 VAC	A22L-C□-T2-10M	A22L-C□-T2-10A		
	SPST-NC	110 VAC	A22L-C□-T1-01M	A22L-C□-T1-01A		
		220 VAC	A22L-C□-T2-01M	A22L-C□-T2-01A		
	SPST-NO + SPST-NC	110 VAC	A22L-C□-T1-11M	A22L-C□-T1-11A		
		220 VAC	A22L-C□-T2-11M	A22L-C□-T2-11A		
	DPST-NO	110 VAC	A22L-C□-T1-20M	A22L-C□-T1-20A		
		220 VAC	A22L-C□-T2-20M	A22L-C□-T2-20A		
	DPST-NC	110 VAC	A22L-C□-T1-02M	A22L-C□-T1-02A		
		220 VAC	A22L-C□-T2-02M	A22L-C□-T2-02A		





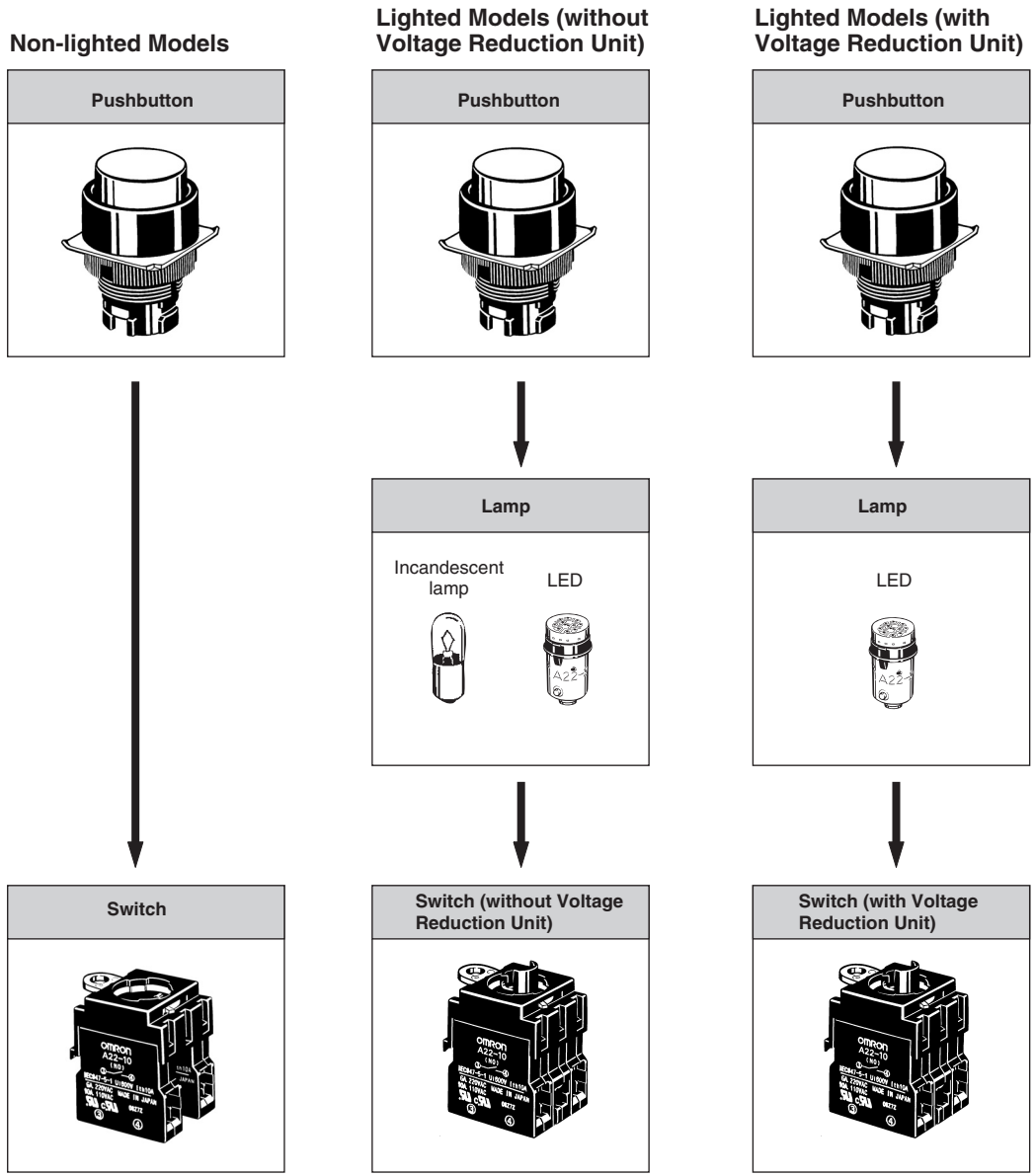

Appearance	Output	Lighting	Operating voltage	Momentary operation (self-resetting)	Alternate operation (self-holding)	Illumination color
Square/Full-guard type LED lighting (without Voltage Reduction Unit)  A22L-D	SPST-NO	LED	6 VDC	A22L-D□-6D-10M	A22L-D□-6D-10A	Insert one of the following letters into the box □. R (red) Y (yellow) G (green) W (white) A (blue)
			6 VAC	A22L-D□-6A-10M	A22L-D□-6A-10A	
			12 VAC/VDC	A22L-D□-12A-10M	A22L-D□-12A-10A	
			24 VAC/VDC	A22L-D□-24A-10M	A22L-D□-24A-10A	
	SPST-NC		6 VDC	A22L-D□-6D-01M	A22L-D□-6D-01A	
			6 VAC	A22L-D□-6A-01M	A22L-D□-6A-01A	
			12 VAC/VDC	A22L-D□-12A-01M	A22L-D□-12A-01A	
			24 VAC/VDC	A22L-D□-24A-01M	A22L-D□-24A-01A	
	SPST-NO + SPST-NC		6 VDC	A22L-D□-6D-11M	A22L-D□-6D-11A	
			6 VAC	A22L-D□-6A-11M	A22L-D□-6A-11A	
			12 VAC/VDC	A22L-D□-12A-11M	A22L-D□-12A-11A	
			24 VAC/VDC	A22L-D□-24A-11M	A22L-D□-24A-11A	
	DPST-NO		6 VDC	A22L-D□-6D-20M	A22L-D□-6D-20A	
			6 VAC	A22L-D□-6A-20M	A22L-D□-6A-20A	
			12 VAC/VDC	A22L-D□-12A-20M	A22L-D□-12A-20A	
			24 VAC/VDC	A22L-D□-24A-20M	A22L-D□-24A-20A	
	DPST-NC		6 VDC	A22L-D□-6D-02M	A22L-D□-6D-02A	
			6 VAC	A22L-D□-6A-02M	A22L-D□-6A-02A	
			12 VAC/VDC	A22L-D□-12A-02M	A22L-D□-12A-02A	
			24 VAC/VDC	A22L-D□-24A-02M	A22L-D□-24A-02A	
Square/Full-guard type LED voltage-reduction lighting (with Voltage Reduction Unit)  A22L-D	SPST-NO	110 VAC	A22L-D□-T1-10M	A22L-D□-T1-10A		
	SPST-NC	220 VAC	A22L-D□-T2-10M	A22L-D□-T2-10A		
		110 VAC	A22L-D□-T1-01M	A22L-D□-T1-01A		
	SPST-NO + SPST-NC	220 VAC	A22L-D□-T2-01M	A22L-D□-T2-01A		
		110 VAC	A22L-D□-T1-11M	A22L-D□-T1-11A		
	DPST-NO	220 VAC	A22L-D□-T2-11M	A22L-D□-T2-11A		
		110 VAC	A22L-D□-T1-20M	A22L-D□-T1-20A		
	DPST-NC	220 VAC	A22L-D□-T2-20M	A22L-D□-T2-20A		
		110 VAC	A22L-D□-T1-02M	A22L-D□-T1-02A		
			220 VAC	A22L-D□-T2-02M	A22L-D□-T2-02A	





**Ordering Individually**





**Pushbutton**

**Non-lighted**

Color	IP65 oil-resistant models			
	Flat type 	Projection type 	Full-guard type 	Half-guard type 
<b>Red</b>	A22-FR	A22-TR	A22-GR	A22-HR
<b>Green</b>	A22-FG	A22-TG	A22-GG	A22-HG
<b>Yellow</b>	A22-FY	A22-TY	A22-GY	A22-HY
<b>White</b>	A22-FW	A22-TW	A22-GW	A22-HW
<b>Blue</b>	A22-FA	A22-TA	A22-GA	A22-HA
<b>Black</b>	A22-FB	A22-TB	A22-GB	A22-HB

Color	IP65 oil-resistant models			
	Square/Projection type 	Square/Full-guard type 	Round/Mushroom type (30-dia. head) 	Round/Mushroom type (40-dia. head) 
<b>Red</b>	A22-CR	A22-DR	A22-SR	A22-MR
<b>Green</b>	A22-CG	A22-DG	A22-SG	A22-MG
<b>Yellow</b>	A22-CY	A22-DY	A22-SY	A22-MY
<b>White</b>	A22-CW	A22-DW	A22-SW	A22-MW
<b>Blue</b>	A22-CA	A22-DA	A22-SA	A22-MA
<b>Black</b>	A22-CB	A22-DB	A22-SB	A22-MB

**Lighted**

Color	IP65		
	Projection type 	Full-guard type 	Half-guard type 
<b>Red</b>	A22L-TR	A22L-GR	A22L-HR
<b>Green</b>	A22L-TG	A22L-GG	A22L-HG
<b>Yellow</b>	A22L-TY	A22L-GY	A22L-HY
<b>White</b>	A22L-TW	A22L-GW	A22L-HW
<b>Blue</b>	A22L-TA	A22L-GA	A22L-HA

**Note:** Common to incandescent lamps and LED lamps.

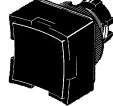
Color	IP65	
	Square/Projection 	Square/Full-guard type 
<b>Red</b>	A22L-CR	A22L-DR
<b>Green</b>	A22L-CG	A22L-DG
<b>Yellow</b>	A22L-CY	A22L-DY
<b>White</b>	A22L-CW	A22L-DW
<b>Blue</b>	A22L-CA	A22L-DA

## Lamp

### LED Lamp

Appearance	Operating voltage		6 V	12 V	24 V	24 V Super-bright
	AC/DC	LED light	Model			
	DC	Red	A22-6DR	---	---	---
		Green	A22-6DG	---	---	---
		Yellow (See note 2.)	A22-6DY	---	---	---
		Blue	A22-6DA	---	---	---
	AC	Red	A22-6AR	---	---	---
		Green	A22-6AG	---	---	---
		Yellow (See note 2.)	A22-6AY	---	---	---
		Blue	A22-6AA	---	---	---
	AC and DC	Red	---	A22-12AR	A22-24AR	A22-24ASR
		Green	---	A22-12AG	A22-24AG	A22-24ASG
		Yellow (See note 2.)	---	A22-12AY	A22-24AY	A22-24ASY
		Blue	---	A22-12AA	A22-24AA	A22-24ASA

- Note:** 1. For voltage-reduction lighting, use the A22-24A□.  
 2. Used when the Pushbutton color is yellow or white.

### Incandescent Lamp



Operating voltage	5 VAC/VDC	12 VAC/VDC	24 VAC/VDC	100 VAC/VDC
	A22-5	A22-12	A22-24	A22-H1

## Switch (Standard Load)

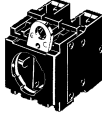
### Non-lighted

Switch operation	Contacts	Model
	SPST-NO	A22-10M
	SPST-NC	A22-01M
	SPST-NO + SPST-NC	A22-11M
	DPST-NO	A22-20M
	DPST-NC	A22-02M
	Alternate	SPST-NO
SPST-NC		A22-01A
SPST-NO + SPST-NC		A22-11A
DPST-NO		A22-20A
DPST-NC		A22-02A



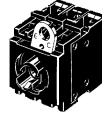



Lighted

Switch operation	Contacts	Voltage reduction circuits		
		Without Voltage Reduction Unit	With Voltage Reduction Unit	
			110 VAC	220 VAC
				
Momentary	SPST-NO	A22L-10M	A22L-10M-T1	A22L-10M-T2
	SPST-NC	A22L-01M	A22L-01M-T1	A22L-01M-T2
	SPST-NO + SPST-NC	A22L-11M	A22L-11M-T1	A22L-11M-T2
	DPST-NO	A22L-20M	A22L-20M-T1	A22L-20M-T2
	DPST-NC	A22L-02M	A22L-02M-T1	A22L-02M-T2
Alternate	SPST-NO	A22L-10A	A22L-10A-T1	A22L-10A-T2
	SPST-NC	A22L-01A	A22L-01A-T1	A22L-01A-T2
	SPST-NO + SPST-NC	A22L-11A	A22L-11A-T1	A22L-11A-T2
	DPST-NO	A22L-20A	A22L-20A-T1	A22L-20A-T2
	DPST-NC	A22L-02A	A22L-02A-T1	A22L-02A-T2









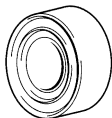
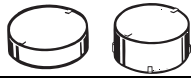

**Note:** 1. The above diagrams show the DPST-NO contact models as representative examples.  
 2. For voltage-reduction lighting, use the A22-24A□.





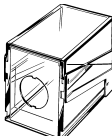

■ Accessories (Order Separately)

Common to A22, A22S/W, A22K, M22, and A22E

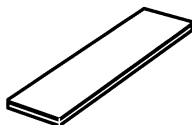
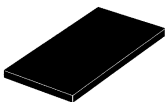
Item		Appearance	Classification		Model	Remarks
Switch Blocks			SPST-NO	Standard load	A22-10	Provided as standard. Order Switch Blocks only when adding or replacing them.
				Microload	A22-10S	
			SPST-NC	Standard load	A22-01	
				Microload	A22-01S	
			DPST-NO	Standard load	A22-20	
				Microload	A22-20S	
DPST-NC	Standard load	A22-02				
	Microload	A22-02S				
Lamp Sockets			Direct lighting		A22-TN	Used when changing the lighting method. (LED only)
			Voltage-reduction lighting	110 VAC	A22-T1	
				220 VAC	A22-T2	
Mounting Latches			For momentary models		A22-3200	Provided as standard. Order Mounting Latches only when mounting Switch Blocks or Lamp Sockets that are purchased individually.
			For alternate models		A22-3210	
Legend Plate Frames	Standard size		With Snap-in Legend Plate (Without text)	White	A22Z-3321	Snap-in Legend Plate is acrylic.
				Red	A22Z-3322	
				Black	A22Z-3323	
	Large size		With Snap-in Legend Plate (Without text)	White	A22Z-3331	
				Red	A22Z-3332	
				Black	A22Z-3333	
		Without Snap-in Legend Plate		A22Z-3320		
		Without Snap-in Legend Plate		A22Z-3330		
Lock Ring			Round		A22Z-3360	The body is equipped with a Lock Ring. This Lock Ring is used when a more secure lock feature is required.
Metallic Bezel Rings			For flat or projection models		A22Z-3580	Replace with the standard model. Material: nickel-plated zinc
			For full-guard models		A22Z-3582	

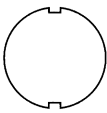
Pushbutton Switches

Item	Appearance	Classification	Model	Remarks	
Sealing Caps		For flat models	A22Z-3600F	Used to prevent dust or water from entering the Operation Unit (Pushbutton, etc.). Color: opaque Material: silicon	
		For projection models	A22Z-3600T		
		For full-guard models	A22Z-3600G		
Caps	For A22    For M22 	For projection, full-guard, or half-guard models	A22Z-3490	Material: polycarbonate resin	
		For round models	A22Z-3495		
Color Caps		Red	A22Z-30TR	Used for changing the Pushbutton color of the (round) Pushbutton Switches.	
		Green	A22Z-30TG		
		Yellow	A22Z-30TY		
		White	A22Z-30TW		
		Blue	A22Z-30TA		
Three-throw Spacer			A22Z-3003	Used when mounting three Non-lighted Switches. (See page 105.)	
Hole Plug		Round	A22Z-3530	Can be plugged into pre-cut panel holes for future expansion. The color is black.	
Control Boxes (Enclosures)		One hole	Exclusively for A22	A22Z-B101	For those designed exclusively for A22, DPST-NO or DPST-NC Switches cannot be used. Material: Polycarbonate resin
			Compatible with A3T	A22Z-B201	
		One hole, yellow box (for emergency stop)	Exclusively for A22	A22Z-B101Y	
			Compatible with A3T	A22Z-B201Y	
		Two holes	Exclusively for A22	A22Z-B102	
			Compatible with A3T	A22Z-B202	
Three holes	Exclusively for A22	A22Z-B103			
	Compatible with A3T	A22Z-B203			
Connectors		Applicable cable diameter (mm)	7 to 9 dia.	A22Z-3500-1	Plastic connector used to extend a cable from the Switch Box. (See page 103.)
			9 to 11 dia.	A22Z-3500-2	
25-dia. Ring		---	A22Z-R25	Use when mounting to a panel with a 25-dia. hole. For details, refer to page 94. Since this is not attached to the main body, order separately.	
30-dia. Metal Flange		Flat, projecting	A22Z-F30	Use instead of the standard flange when mounting into a panel with a 30-dia. hole. For details of mounting hole dimensions, refer to the corresponding section for the A30.	
		Full guard	A22Z-G30		
30-dia. Resin Attachment		Round	A22Z-A30	Use when mounting to a panel with a 30-dia. hole. For details, refer to page 96.	
Lock Plate		---	A22Z-3380	Use to fix the lever on the Switch.	
Simple Protective Cover		---	A11Z-3700	Prevents foreign matter entering into the Switch from the back of the panel.	

Item		Appearance	Classification		Model	Remarks
Snap-in Legend Plates	Standard size		Without text	Black	A22Z-3443B	Attached to the Standard-size Legend Plate Frame. Material: Acrylic (See page 95.)
				Red	A22Z-3443R	
				White	A22Z-3443W	
				Transparent	A22Z-3443C	
			White text on red background	m	A22Z-3443R-2	
				STOP	A22Z-3443R-4	
			White text on black background		A22Z-3443B-1	
				START	A22Z-3443B-3	
				ON	A22Z-3443B-5	
				OFF	A22Z-3443B-6	
	UP	A22Z-3443B-7				
	DOWN	A22Z-3443B-8				
	Large size		Without text	Black	A22Z-3453B	Attached to the Large-size Legend Plate Frame Material: Acrylic (See page 95.)
				Red	A22Z-3453R	
White				A22Z-3453W		
Transparent				A22Z-3453C		
For Emergency Stop Switch		60-dia. round plate with black letters on a yellow background	A22Z-3466-1	"EMERGENCY STOP" is engraved on the plate. Used as an Emergency Stop Switch Legend Plate		
		90-dia. round plate with black letters on a yellow background	A22Z-3476-1			
Character Films		No print (Round)		A22Z-3460	After printing on a film, affix to the indicator plate of the Lighted Pushbutton Switch. (The back is coated with adhesive.)	
		Character print (Round)		A22Z-3460-1		
			m	A22Z-3460-2		
			START	A22Z-3460-3		
		STOP	A22Z-3460-4			
No print (Square)		A22Z-3480				
Lamp Extractor		---	A22Z-3901	Rubber tool used to easily replace Lamps		
Tightening Wrench		---	A22Z-3905	Tool used to tighten nuts from the back of the panel		
Cap Tightening Tool		---	A22Z-3908	Used for replacing the cap of the Half-guard Pushbutton Switch.		
Cap Puller		---	A3PJ-5080	Used for removing the cap from the Pushbutton of the Square Lighted Pushbutton Switch.		

Pushbutton Switches

# Specifications

## Common to A22, A22S/W, A22K, and A22E

### ■ Approved Standards

Recognized organization	Standards	File No.
UL, cUL (See note.)	UL508	E41515
---	EN60947-5-1	---

Note: cUL: CSA C22.2 No. 14

### ■ Approved Standard Ratings

#### UL, cUL (File No. E41515)

6 A at 220 VAC, 10 A at 110 VAC

#### EN60947-5-1 (Low Voltage Directive)

10 A at 220 VAC

### ■ Ratings

#### Contacts (Standard Load)

Rated carry current	Rated voltage	Rated current (A)			
		AC15 (inductive load)	AC12 (resistive load)	DC13 (inductive load)	DC12 (resistive load)
10	24 VAC	10	10	---	---
	110 VAC	5	10		
	220 VAC	3	6		
	380 VAC	2	3		
	440 VAC	1	2		
	24 VDC	---	---	1.5	10
	110 VDC			0.5	2
	220 VDC			0.2	0.6
	380 VDC			0.1	0.2

Note: 1. Rated current values are determined according to the testing conditions. The above ratings were obtained by conducting tests under the following conditions.

- (1) Ambient temperature: 20<sup>o</sup>±2<sup>o</sup>C
- (2) Ambient humidity: 65±5%
- (3) Operating frequency: 20 operations/minute

2. Minimum applicable load: 10 mA at 5 VDC

#### Contacts (Microload)

Rated applicable load	Minimum applicable load
50 mA at 5 VDC (Resistive load)	1 mA at 5 VDC

#### LED Indicators without Voltage Reduction Unit

Rated voltage	Rated current	Operating voltage
6 VDC	60 mA (20 mA)	6 VDC±5%
6 VAC	60 mA (20 mA)	6 VAC/VDC±5%
12 VAC/VDC	30 mA (10 mA)	12 VAC/VDC±5%
24 VAC/VDC	15 mA (10 mA)	24 VAC/VDC±5%

Note: Values in parentheses are for blue Pushbuttons.

#### Super-bright LED Indicator

Rated voltage	Rated current	Operating voltage
24 VAC/VDC	15 mA	24 VAC/VDC ±5%

#### Incandescent Lamp

Rated voltage	Rated current	Operating voltage
6 VAC/VDC	200 mA	5 VAC/VDC
14 VAC/VDC	80 mA	12 VAC/VDC
28 VAC/VDC	40 mA	24 VAC/VDC
130 VAC/VDC	20 mA	100 VAC/VDC

#### Voltage-reduction Lighting

Rated voltage	Operational voltage	Applicable lamp (BA8S/13□ gold)
110 VAC	95 to 115 VAC	LED Lamp (A22-24A□)
220 VAC	190 to 230 VAC	



■ Characteristics

Item		Pushbutton Switches		Emergency Stop Switches		Knob-type Selector Switches		Key-type Selector Switch
		Non-lighted models: A22-F A22-T A22-G A22-S A22-C A22-D A22-H A22-M	Lighted models: A22L-T A22L-G A22L-H A22L-D A22L-C	Non-lighted model: A22E	Lighted model: A22EL	Non-lighted model: A22S	Lighted model: A22W	Non-lighted model: A22K
Allowable operating frequency	Mechanical	Momentary operation: 60 operations/minute max.		30 operations/minute max.		Manual release: 30 operations/minute max. Automatic release: 30 operations/minute max.		
	Electrical	30 operations/minute max.				30 operations/minute max.		
Insulation resistance		100 MΩ min. (at 500 VDC)						
Dielectric strength		2,500 VAC, 50/60 Hz for 1 min between terminals of same polarity 2,500 VAC, 50/60 Hz for 1 min between terminals of different polarity and also between each terminal and ground						
Vibration resistance		Malfunction (See note 2.): 10 to 55 Hz, 1.5-mm double amplitude						
Shock resistance	Mechanical	1,000 m/s <sup>2</sup>	1,000 m/s <sup>2</sup>	1,000 m/s <sup>2</sup>		1,000 m/s <sup>2</sup>	1,000 m/s <sup>2</sup>	1,000 m/s <sup>2</sup>
	Malfunction (See note 2.)	1,000 m/s <sup>2</sup> max.	600 m/s <sup>2</sup> max.	250 m/s <sup>2</sup> max.		1,000 m/s <sup>2</sup> max.	600 m/s <sup>2</sup> max.	1,000 m/s <sup>2</sup> max.
Durability	Mechanical	Momentary operation: 5,000,000 operations min.		Momentary operation: 300,000 operations min.		500,000 operations min.	100,000 operations min.	500,000 operations min.
	Electrical	500,000 operations min.		300,000 operations min.	300,000 operations min.	500,000 operations min.	100,000 operations min.	500,000 operations min.
Ambient temperature (See note 1.)		Operating: -20°C to 70°C Storage: -40°C to 70°C	Operating: -20°C to 55°C Storage: -40°C to 70°C	Operating: -20°C to 70°C Storage: -40°C to 70°C	Operating: -20°C to 55°C Storage: -40°C to 70°C	Operating: -20°C to 70°C Storage: -40°C to 70°C	Operating: -20°C to 55°C Storage: -40°C to 70°C	Operating: -20°C to 70°C Storage: -40°C to 70°C
Ambient humidity		Operating: 35% to 85%						
Degree of protection		IP65 (oil-resistant)	IP65	IP65 (oil-resistant)	IP65	IP65 (oil-resistant)	IP65	IP65 (oil-resistant)
Electric shock protection class		Class II						
PTI (tracking characteristic)		175						
Degree of contamination		3 (IEC947-5-1)						

Note: 1. With no icing or condensation.  
2. Malfunction within 1 ms.

## ■ Operating Characteristics (for SPST-NO/SPST-NC)

Item	Pushbutton Switches	Emergency Stop Switches	Knob-type Selector Switches		Key-type Selector Switch	
	Lighted Non-lighted Pushbutton Switches	Push-lock turn-reset system	Manual release	Automatic release	Manual release	Automatic release
	A22-F A22-G A22-C A22-S A22-T A22-H A22-D A22-M A22L-T A22L-H A22L-D A22L-G A22L-C	A22E, A22EL	A22S, A22W	A22S, A22W	A22K	
Total travel force (TTF) max.	29.4 N	44.1 N	0.34 N·m (See note.)	0.25 N·m for two notches (See note.)	0.34 N·m (See note.)	0.25 N·m for three notches (See note.)
				0.34 N·m for three notches (See note.)		0.34 N·m for three notches (See note.)
Total travel (TT)	5.5 mm max.	10±1 mm	Approx. 90° for two notches (Approx. 45° for three notches)		Approx. 90° for two notches (Approx. 45° for three notches)	
Releasing force (RF) min.	---	0.25 N·m max. (See note.)	0.34 N·m max. (See note.)	---	0.34 N·m max. (See note.)	---

**Note:** Rotation torque for Emergency Stop Pushbutton, Knob-type Selector, and Key-type Selector Switches.

## Nomenclature

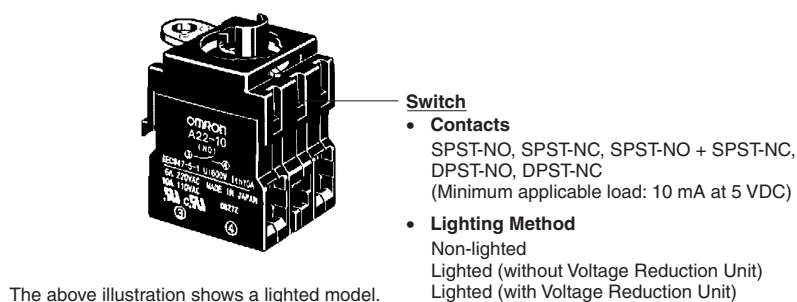
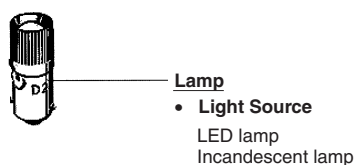
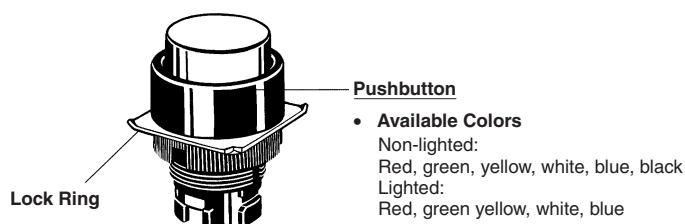

# Dimensions

**Note:** 1. All units are in millimeters unless otherwise indicated.  
 2. The following illustrations are for momentary operation.

## Lighted/Non-lighted Pushbutton Switches

### Flat Type A22-F

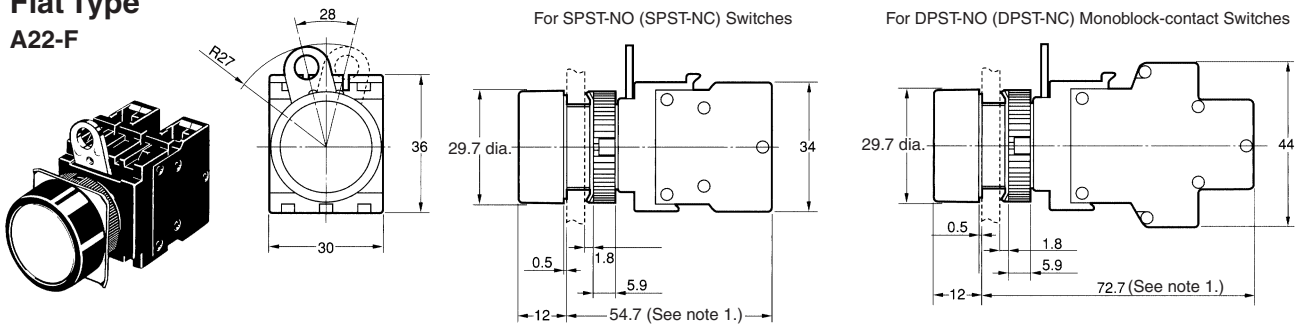

### Round/Half-guard Type A22-H, A22L-H

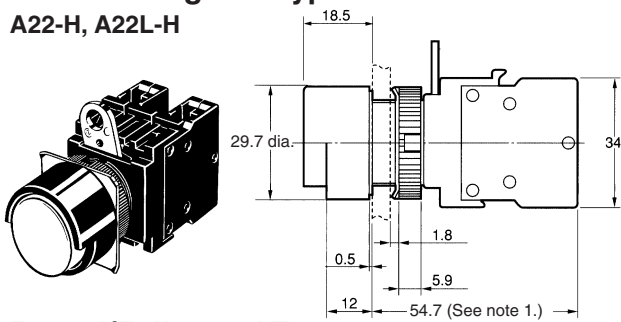

### Round/Projection Type A22-T, A22L-T

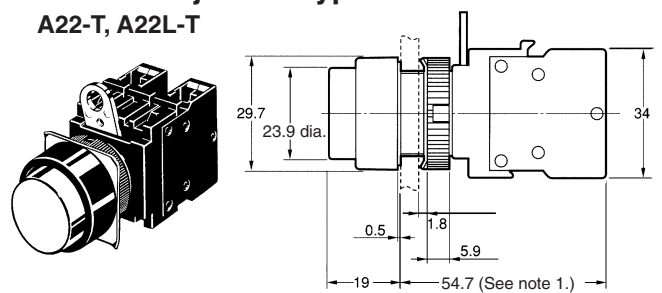

### Round/Full-guard Type A22-G, A22L-G

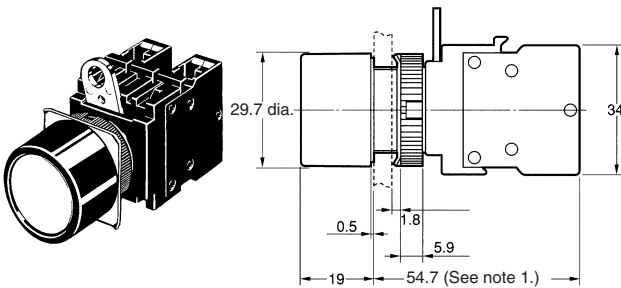

### 40-dia. Mushroom Type A22-M

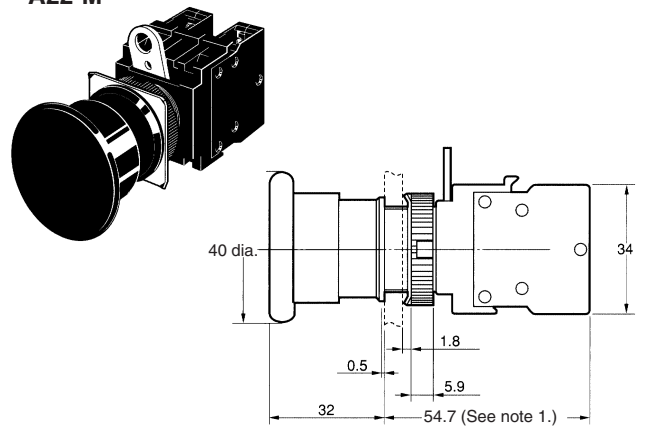

### Square/Projection Type A22-C, A22L-C

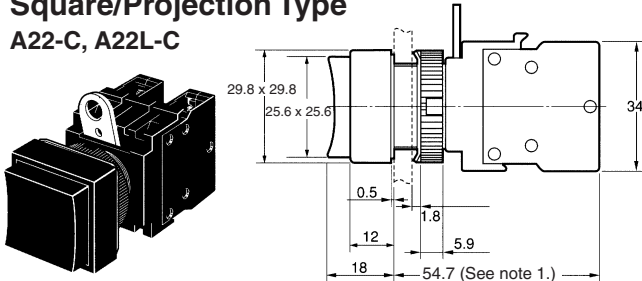

### Square/Full-guard Type A22-D, A22L-D

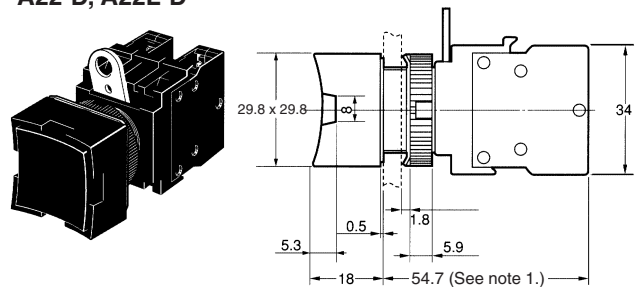

**Note:** 1. Alternate operation models are 9.3 mm longer.  
 2. Lighted models have the same dimensions as shown above, whether they are with or without Voltage Reduction Units.

Pushbutton Switches

## ■ Accessories

Note: All units are in millimeters unless otherwise indicated.

### Legend Plate Frames

**A22Z-332** □

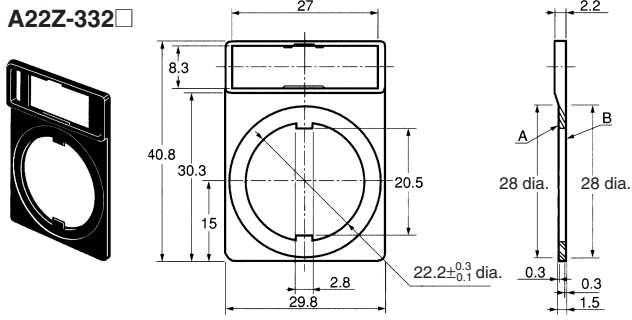

**A22Z-333** □

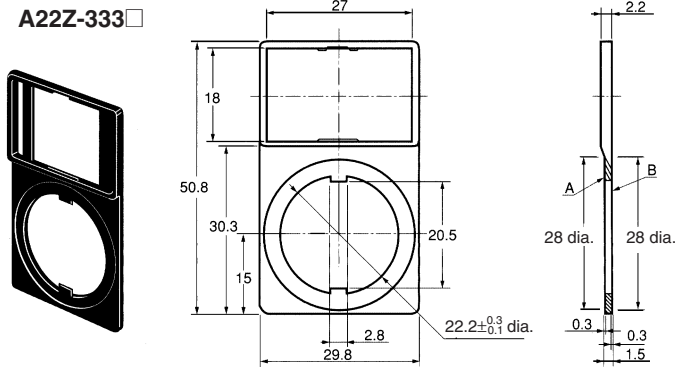

### Lock Ring

**A22Z-3360**

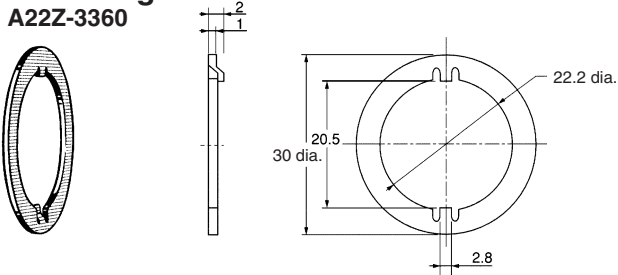

### 25-dia. Ring

**A22Z-R25**

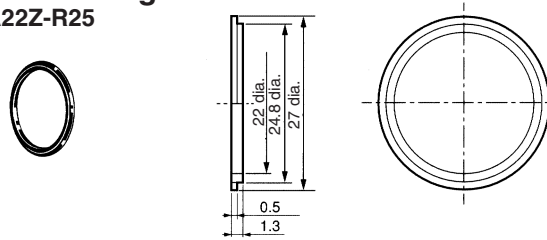

### Color Cap

**A22L-30T** □

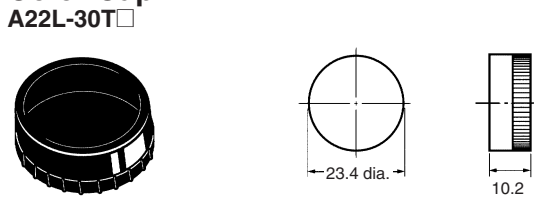

### Hole Plug (Round)

**A22Z-3530**

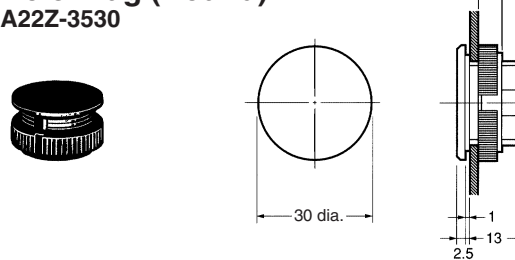

### Sealing Caps

**For Flat Models  
A22Z-3600F**

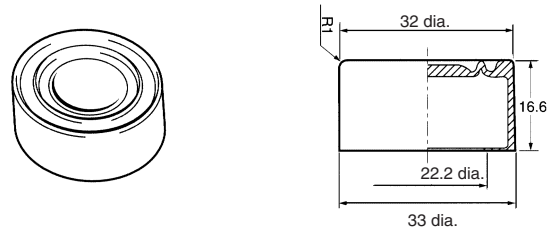

**For Projection Models  
A22Z-3600T**

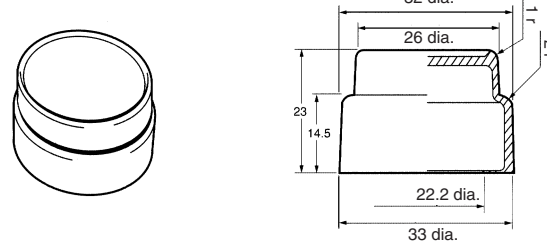

**For Full-guard Models  
A22Z-3600G**

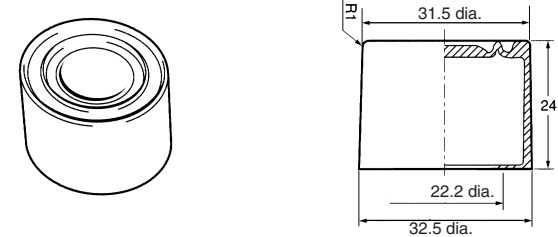

**Three-throw Spacer**

A22Z-3003

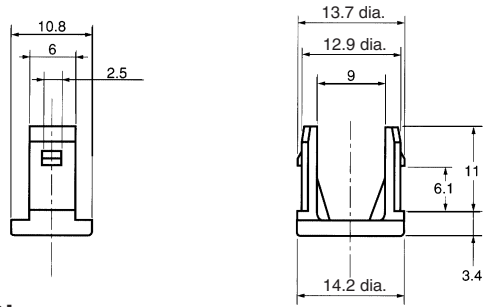
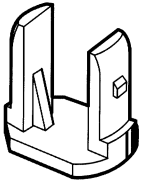

**Metallic Bezel Rings**

For Flat/Projection Models

A22Z-3580

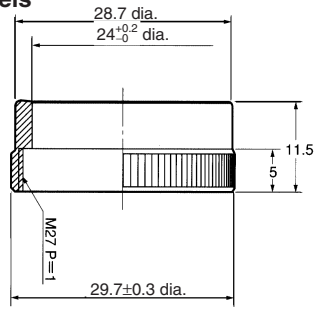
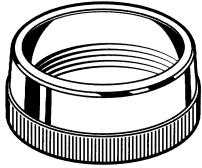

For Full-guard Models

A22Z-3582

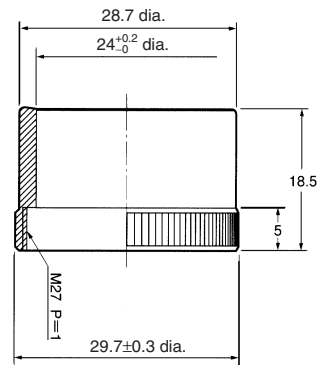
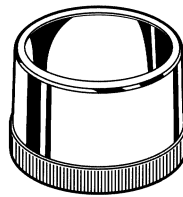

**Snap-in Legend Plates**

For Standard Models

A22L-3443 □-□

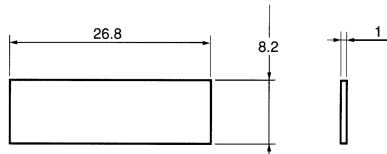
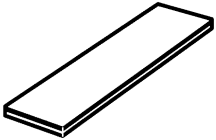

For Large Models

A22Z-3453 □

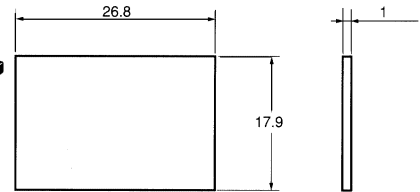
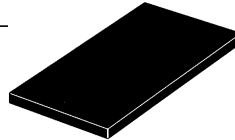

For Emergency-stop Models

A22Z-3476-1 (90 dia.)

A22Z-3466-1 (60 dia.)

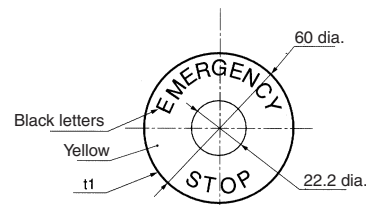
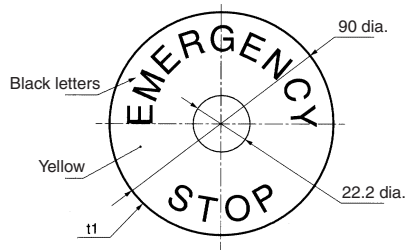

**Character Film**

For Round Models

A22Z-3460-□

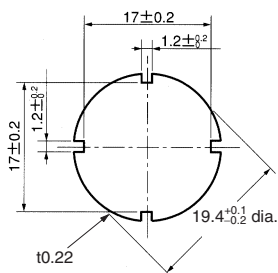
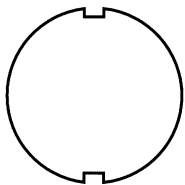

For Square Models

A22Z-3480

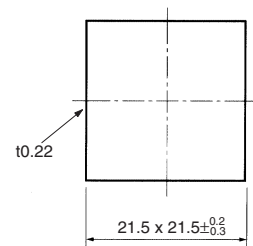
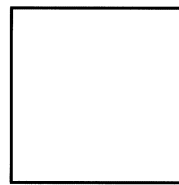

Pushbutton Switches

**Lamp Extractor**

A22Z-3901

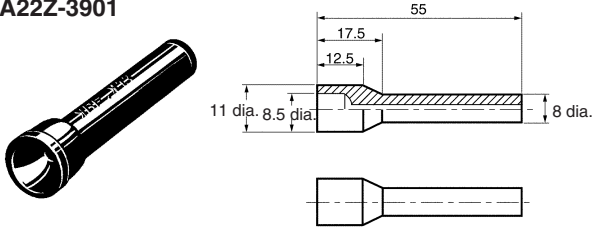

**30-dia. Metal Flange**

A22Z-F30

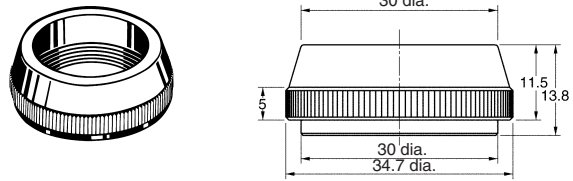

**Tightening Wrench**

A22Z-3905

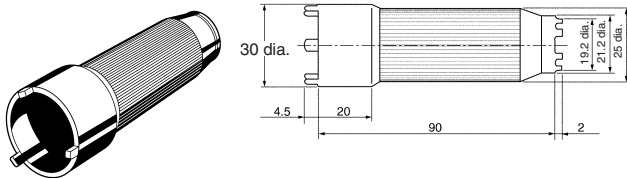

**30-dia. Metal Flange**

A22Z-G30

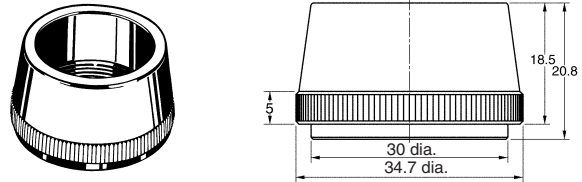

**Cap Tightening Tool**

A22Z-3908

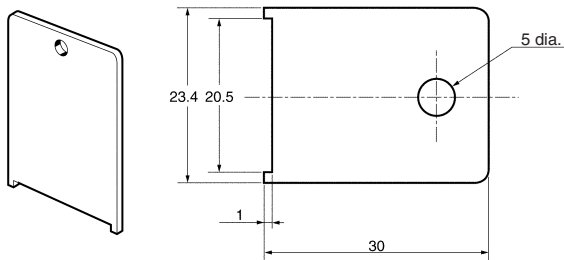

**30-dia. Resin Attachment**

A22Z-A30

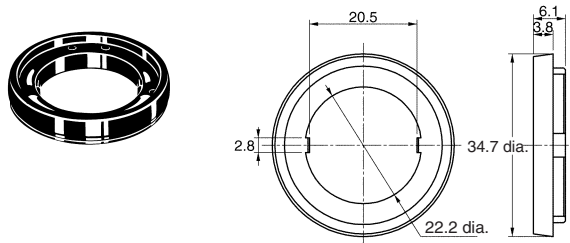

**Cap Puller**

A3PJ-5080

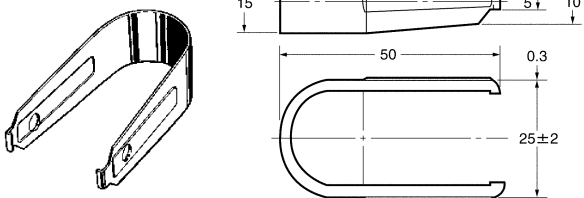

**Lock Plate**

A22Z-3380

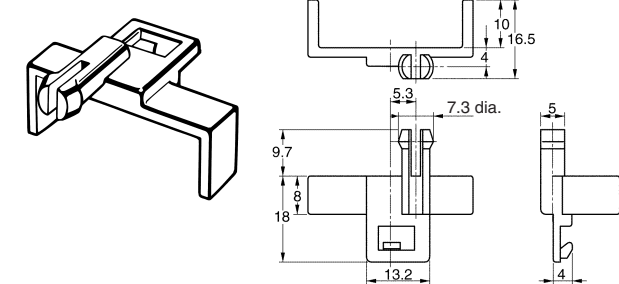

**Simple Protective Cover**

A22Z-3700

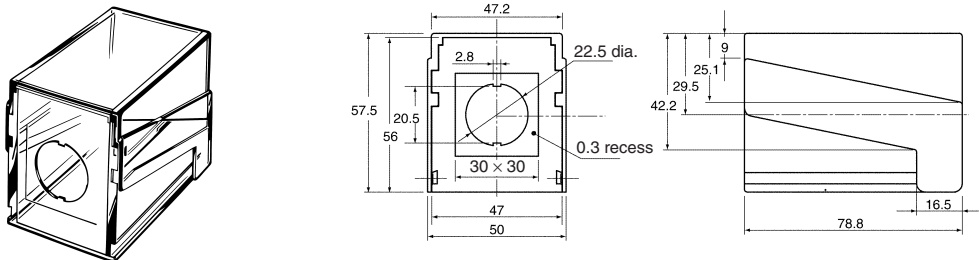

Control Box (Enclosure)

A22Z-B10□

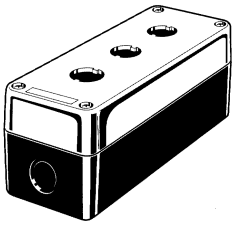

A22Z-B101 (One Hole)  
A22Z-B101Y

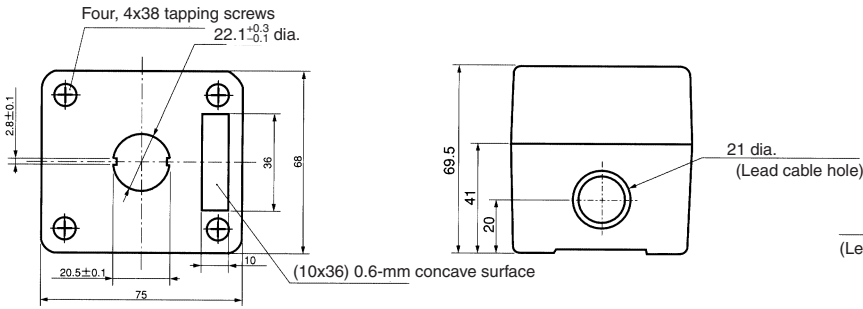

Cable Port Hole (Top View)

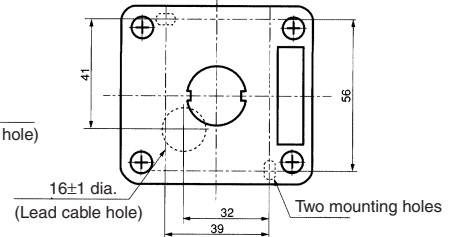

A22Z-B102 (Two Holes)

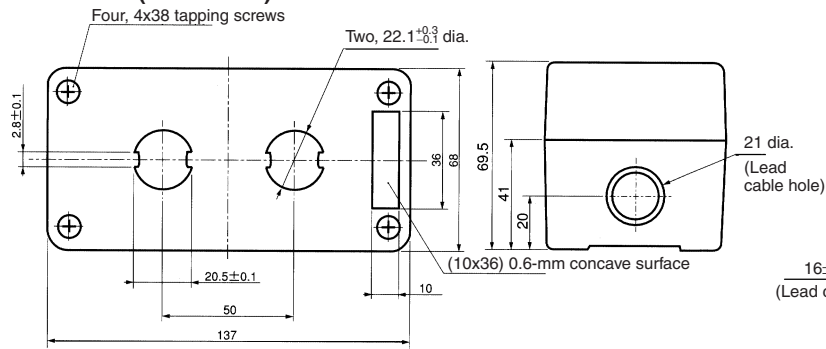

Cable Port Hole (Top View)

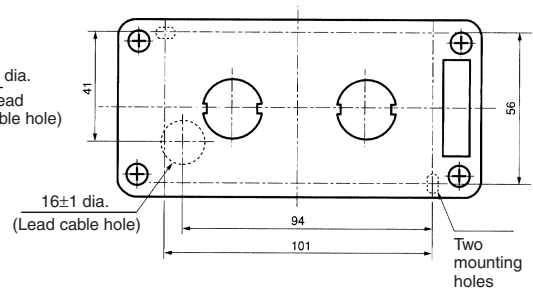

A22Z-B103 (Three Holes)

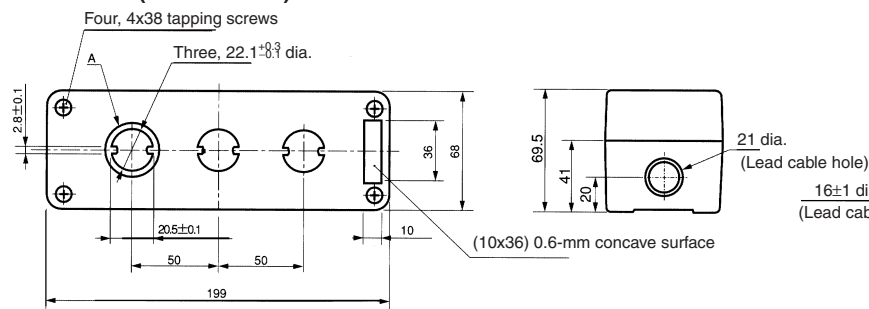

Cable Port Hole (Top View)

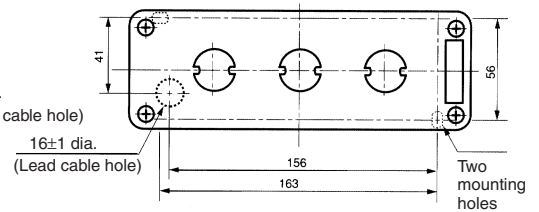

Panel Mounting Hole

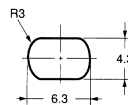

Pushbutton Switches

**A22Z-B201 (One Hole)  
A22Z-B201Y**

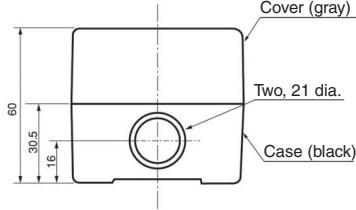
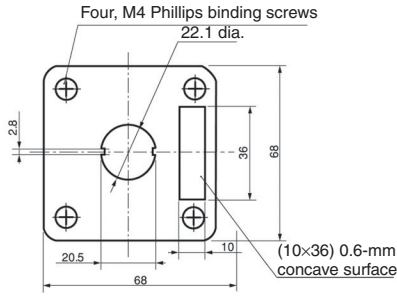

**Cable Port Hole (Top View)**

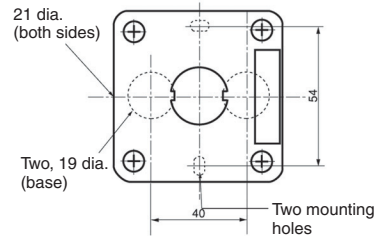

**A22Z-B202 (Two Holes)**

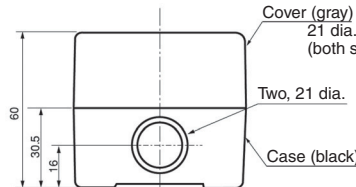
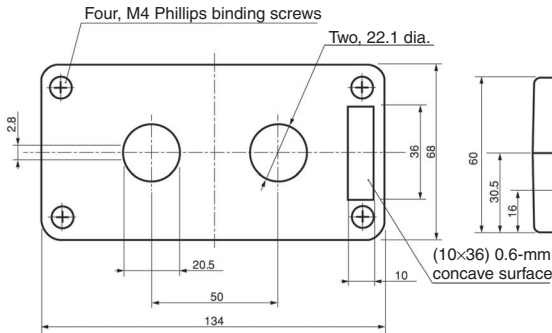

**Cable Port Hole (Top View)**

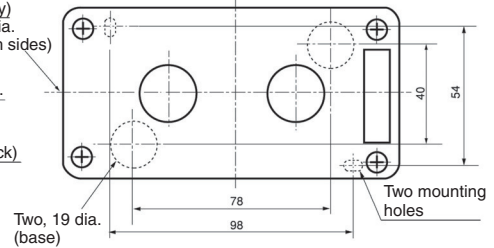

**A22Z-B203 (Three Holes)**

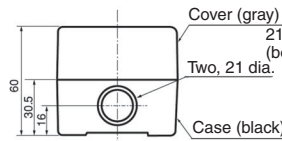
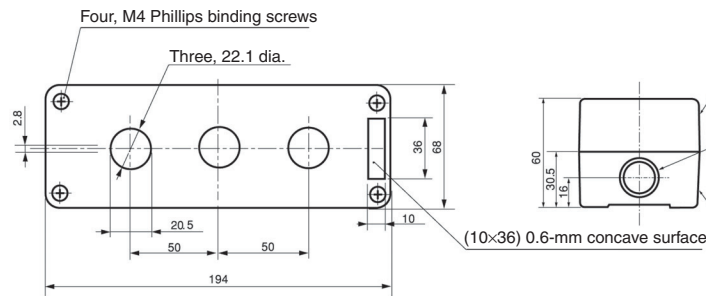

**Cable Port Hole (Top View)**

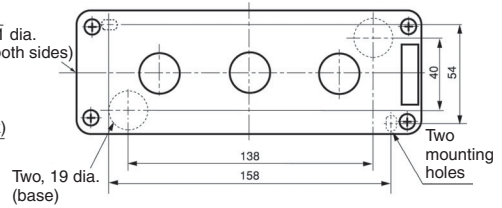

**Panel Mounting Hole**

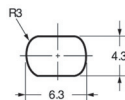

**Terminal Arrangement (Bottom View)**

Non-lighted (SPST-NO + SPST-NC)	Lighted (SPST-NO + SPST-NC)	Non-lighted (DPST-NO + DPST-NC)



## Terminal Connection

Type	Terminal connection
Non-lighted (SPST-NO + SPST-NC)	<p>Bottom view</p>
Non-lighted (DPST-NO + DPST-NC)	<p>Bottom view</p>
Lighted without Voltage Reduction Unit (SPST-NO + SPST-NC)	<p>Bottom view</p>
Lighted with Voltage Reduction Unit (SPST-NO + SPST-NC)	<p>Bottom view</p>

## Panel Cutouts

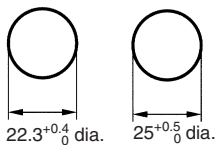

- Note:**
1. When applying coating such as paint to the panel, the dimensions should be those after the application of coating. Lock ring is provided as a standard item.
  2. Recommended panel thickness: 1 to 5 mm.
  3. Use an A22Z-R25 Ring when mounting to a panel with 25-mm holes.

# Installation

## Common to A22, A22S/W, A22K, M22, and A22E

### ■ Mounting to the Panel

#### Panel Hole Dimensions

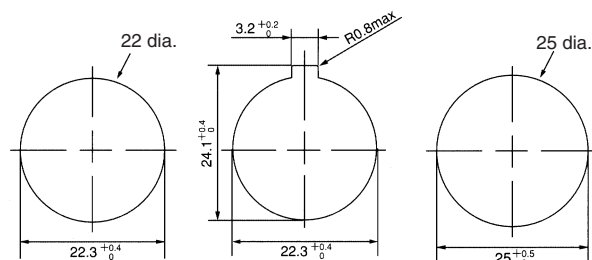

For 25-dia. holes, always use 25-dia. Rings. (Since the cutout dimensions are large, IP65 cannot be guaranteed unless 25-dia. Rings are used.)

If outer surface treatment such as coating is performed for the panel, the panel dimensions after outer surface treatment must meet the specified panel dimensions.

**Note:** Recommended panel thickness: 1 to 5 mm.

#### Matrix Installation

1. The following panel hole dimensions apply when Switch Unit and the Standard-size Legend Plate Frame and Lock Ring are mounted, and lead wires are connected directly to the Switch Block.

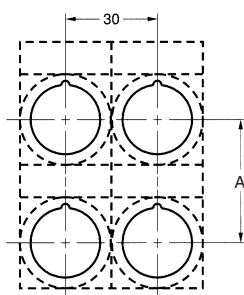

2. The following panel hole dimensions apply when the Large-size Legend Plate Frame is mounted, and when crimp terminals are connected to the Switch Block terminals.

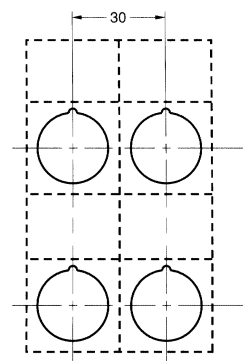

Pitches A and B between the centers of the mounting holes are as follows:

For 1. above:

Switch Blocks	A
A22-10, A22-10S, A22-01, A22-01S	45 mm min.
A22-20, A22-20S, A22-02, A22-02S, A22-11, A22-11S	55 mm min.

For 2. above:

Type of crimp terminal	Switch Blocks	B
Bare crimp terminals	A22-10, A22-10S, A22-01, A22-01S	51 mm min.
	A22-20, A22-20S, A22-02, A22-02S, A22-11, A22-11S	61 mm min.
Crimp terminals with insulating sheath	A22-10, A22-10S, A22-01, A22-01S	60 mm min.
	A22-20, A22-20S, A22-02, A22-02S, A22-11, A22-11S	70 mm min.

**Note: 1.** The above dimensions are the minimum dimensions for when the wires described under *Applicable Wire Size* on page 106 are used. If a different wires are used, the wiring dimensions may be different so determine an appropriate pitch before setup.

**2.** With pushbuttons of external dimensions greater than 30 mm, set the pitch according to the dimensions. (When using matrix installation for the A22-M□, mount with a pitch of 40 mm instead of 30 mm in the diagram above.)

**3.** When using a pushbutton with external dimensions exceeding 30 mm, use a pitch appropriate for the pushbutton.

## Mounting the Operation Unit on the Panel

Insert the Operation Unit (Pushbutton, etc.) from the front surface of the panel, insert the Lock Ring and the mounting nut from the terminal side, then tighten the nut. Before tightening, check that the rubber washer is present between the Pushbutton Unit and the panel.

When using a Legend Plate Frame, put one rubber washer each between the Legend Plate Frame and the panel and between the Operation Unit and the Legend Plate Frame. (One rubber washer will be provided when one Legend Plate Frame is ordered.)

Align the Lock Ring with the groove in the casing, then insert the Lock Ring so that its edge is located on the panel side.

Tighten the mounting nut at a torque of 0.98 to 1.96 N·m.

When using a Lock Ring, replace with the supplied Lock Ring, insert the projecting part into the lock slot, and then tighten the mounting nut.

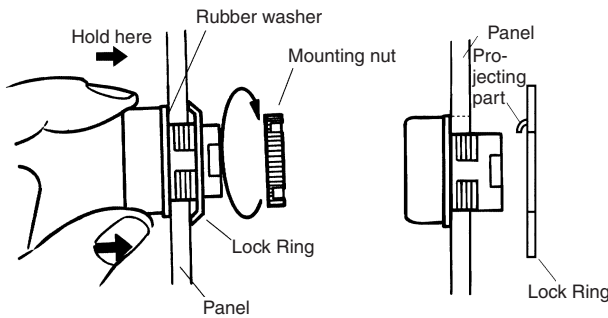

When the panel cutout dimension is 25 dia., remove the supplied rubber washer and mount the 25-dia. Ring as shown below. (Since the A22Z-R25 is not attached to the main body, order separately.)

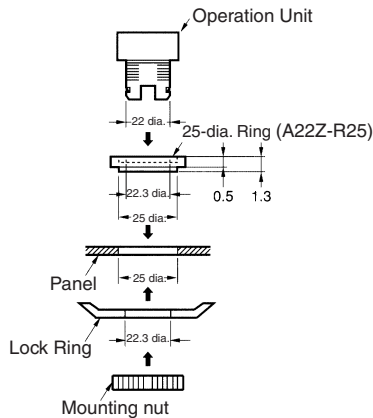

## Mounting the Switch on the Pushbutton Unit

Insert the Pushbutton Unit into the Switch Unit, aligning the arrow mark inscribed on the Case with the lever on the Switch Blocks, then move the lever in the direction indicated by the arrow in the following figure.

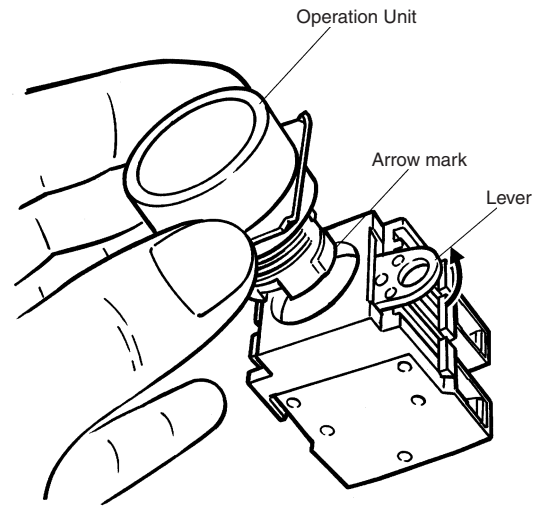

## Removing the Switch

Move the lever in the direction indicated by the arrow in the following figure, then pull the Pushbutton Unit or the Switch Blocks.

Since the lever has a hole with an inside diameter of 6.5 mm, the lever can be moved in the specified direction by inserting a screwdriver into the hole and then moving the screwdriver.

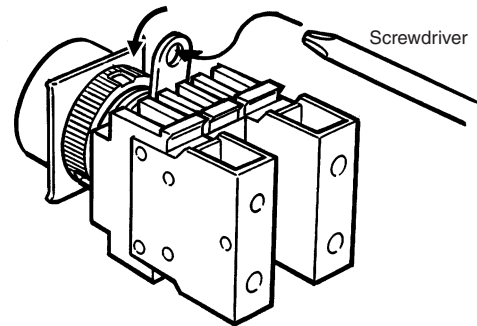

## Mounting/Replacing the Color Cap

### Projection, Fall-guard

Grip and rotate the Color Cap with your fingers.

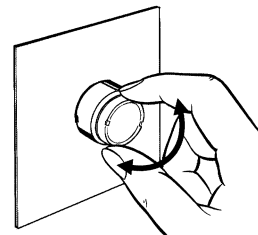

## Half-guard Indicators

Put the tips of the Cap Tightening Tool (A22Z-3908) into the Color Cap slot and turn the Tool.

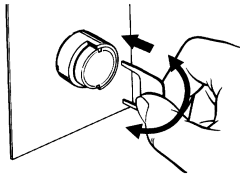

## ■ Assembling the Cap

### Lighted Pushbutton Switch

Mount the Color Cap so that the protrusions inside the cap fit into the grooves in the Pushbutton Unit.

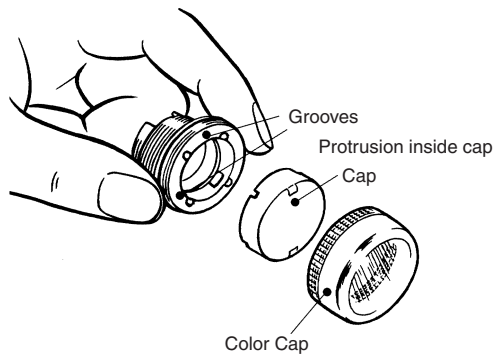

### Indicator

Mount the Color Cap so that the protrusions inside the Pushbutton Unit fit into the grooves in the cap.

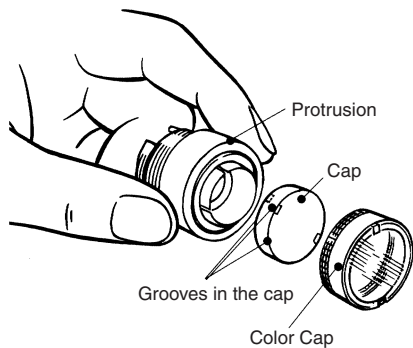

## Square Pushbutton/Indicator

Removing the Color Cap:  
Insert the protruding tip of the Cap Puller (A3PJ-5080) into the Cap slot, hold the plate spring, and pull them to remove the Color Cap.

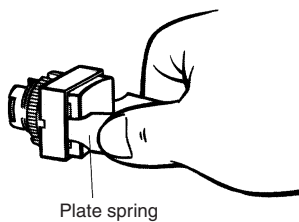

Mounting the Color Cap:  
Mount the Color Cap on the flange and firmly push the Color Cap. When the Color Cap is inserted, check whether it operates properly. When replacing the Lamp, remove the Color Cap and diffusion plate with fingers or Cap Puller. Attach the Character Film properly so that it fits inside the protruding part of the diffusion plate. Then, match the diffusion plate to the square flange and insert the Cap.

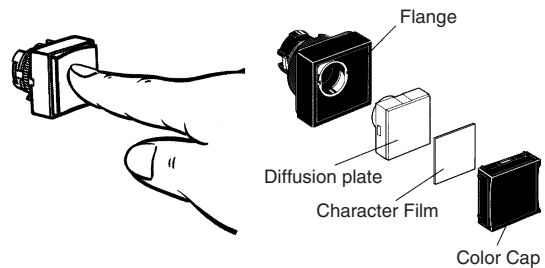

## Emergency Stop Switch

Insert the protrusion of the Tightening Wrench (A22Z-3905) into the Cap slot and then turn to remove the Cap.

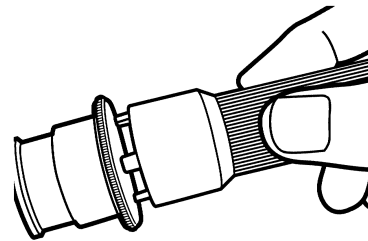

## ■ Installing/Replacing the Lamp

### Installing/Replacing from the Panel Surface

Insert the Lamp Extractor (A22Z-3901) into the lamp, then rotate the Extractor while pressing it.

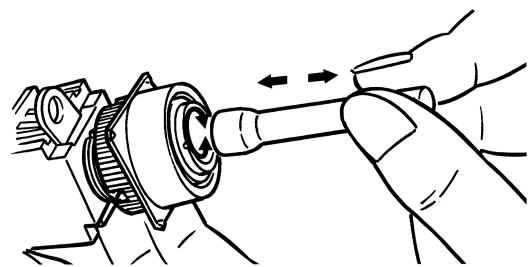

### Installing/Replacing on the Switch

Grip the indicator with your fingers, then rotate the indicator while pressing it against the Switch.

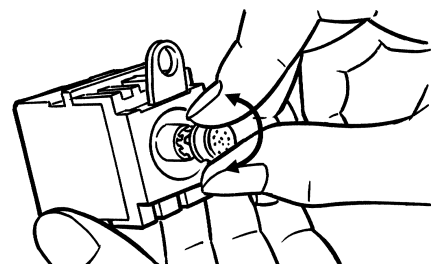

## ■ Control Box (Enclosure)

### Mounting the Switch

The Standard-size Legend Plate Frame can be mounted. Mount the Frame as shown in the following diagram. Mount the Switch in the same way as for an ordinary panel.

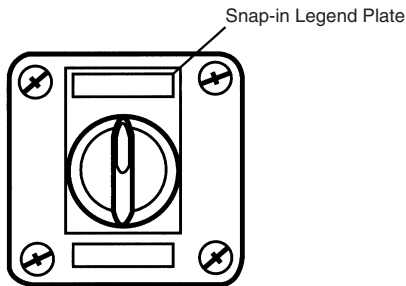

### Creating a Cable Port Hole

Place the tip of a screwdriver on the surface where the cable port hole is to be created with the cover attached and strike the screwdriver to punch a hole. Attempts to punch a hole on the other side of the case will damage the Box.

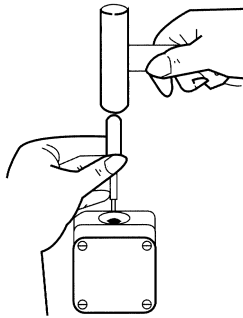

### Securing the Connector Cable

1. Insert the connector into the cable port hole in the Box and secure with the fixing nut inside the box.
2. Open a hole in the thin rubber section of the rubber ring.
3. Pass the tightening cap through the cable, insert the cable into the connector, and tighten the hexagonal nut to secure the cable.

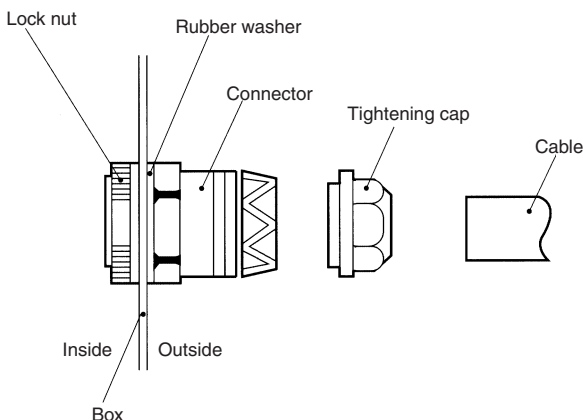

Cable diameter	Connector
7 to 9 dia.	A22Z-3500-1
9 to 11 dia.	A22Z-3500-2

## ■ Installing/Removing the Switch Blocks

### Installing the Switch Blocks

Hook the small protrusion on the Mounting Latch into the groove on the other side of the lever, then push up the Switch Block in the direction indicated by the arrow in the figure below.

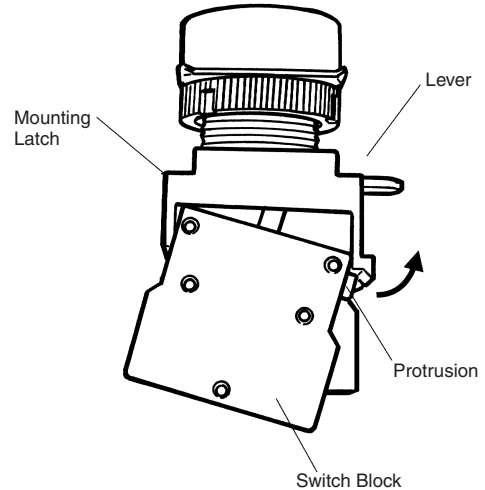

### Removing the Switch Blocks

Insert a screwdriver between the Mounting Latch and the Switch Block, then push down the screwdriver in the direction indicated by the arrow in the following figure.

Use either of the following screwdrivers.

Flat-head screwdriver 3 to 6 mm

Phillips screwdriver 3 to 6 mm

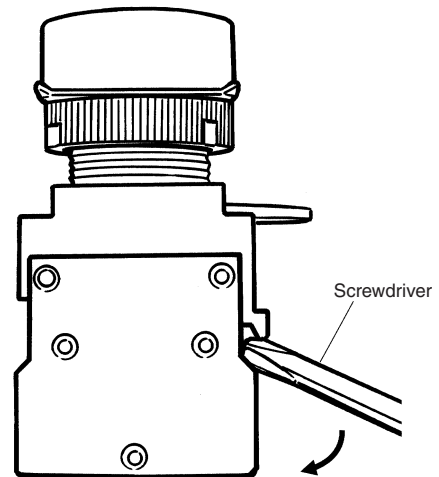

## ■ Wiring

### Wiring Round Crimp Terminals

Loosen the terminal screw from the Switch Unit until it completely comes off the groove, insert a screwdriver as shown in the following figure, then push up the washer in the direction indicated by the arrow to temporarily secure it. Now, a round crimp terminal can be connected. After inserting the terminal, tighten the screws to complete wiring.

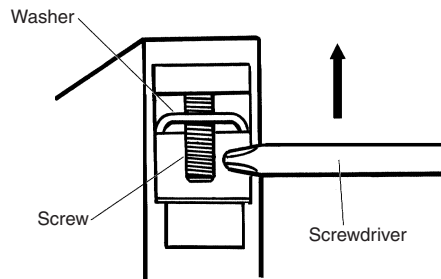

## ■ Engraving

Engrave the characters on the surface on the Cap. Make sure that the characters are aligned parallel to the imaginary line connecting the two protruding portions to the left and right of the Cap.

The characters must not be engraved deeper than 0.5 mm. Apply an alcohol-based paint coating, such as melamine, alkyd, or acrylic resin paint coating, to the engraved characters.

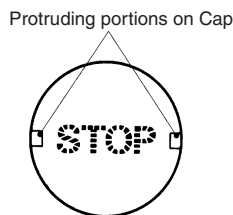

## ■ Affixing Character Film

Hold the Cap, remove the cardboard on the Film, and attach the Film to the Cap. Make sure that the protruding portions of the Cap engage the cutout portions of the Film and that the characters are aligned parallel to the imaginary line connecting the two protruding portions to the left and right of the Cap.

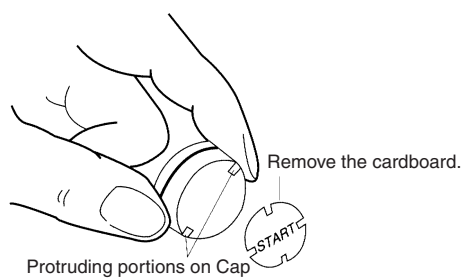

## ■ Mounting and Dismounting Snap-in Legend

Press and secure the Snap-in Legend Plate onto the Legend Plate Frame.

The direction of the characters will vary with the mounting direction of the control panel if the Switch is a knob or key selector model.

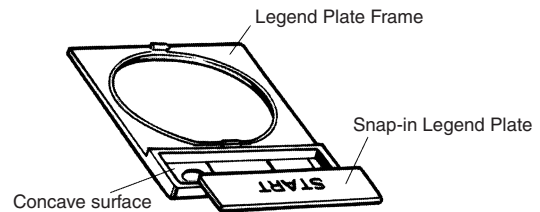

To easily remove the Snap-in Legend Plate from the Legend Plate Frame mounted to the panel, insert a Tool with a thin tip into the space between the Snap-in Legend Plate and the Legend Plate Frame.

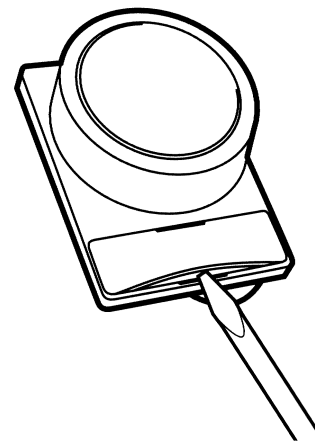

The Snap-in Legend Plate is easily removed by pressing the Snap-in Legend Plate from the back of the Legend Plate Frame.

The Legend Plate Frame is made of acrylic resin, which is easily damaged by shock. Be sure to handle the Legend Plate Frame with care.

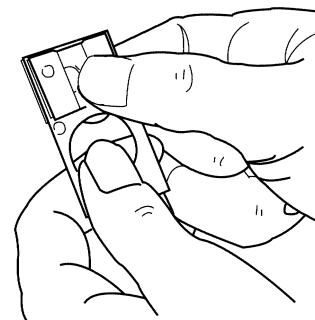

## ■ Engraving Method

### Material: Acrylic

Engrave the characters directly on the matted side of the Snap-in Legend Plate.

The characters must be engraved no deeper than 0.5 mm.

Apply alcohol-based paint coating to the engraved characters.

If the Snap-in Legend Plate is transparent, engrave the mirror-written characters on the back of the Snap-in Legend Plate and apply paint coating to the characters. Then apply paint coating of a different color to the remaining part of the Snap-in Legend Plate.

## ■ Mounting Three-throw Spacer (A22Z-3003)

Press and secure the two protruding portions of the Three-throw Spacer to the two indented portions of the inner side of the control panel.

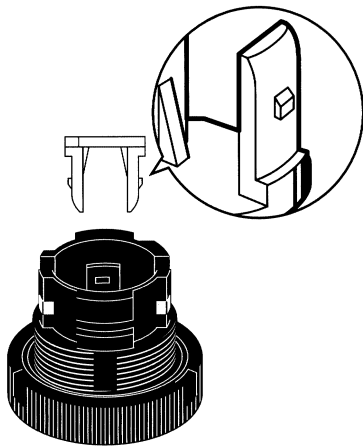

# Precautions

## Common to A22, A22S/W, A22K, M22, and A22E

### ⚠ WARNING

Do not apply a voltage between the incandescent lamp and the terminal that is greater than the rated voltage. If the incandescent lamp is broken, the Operation Units may pop out. Always turn OFF the power and wait for 10 minutes before replacing the incandescent lamp. If the lamp is replaced immediately after the power is turned OFF, the remaining heat may cause burns.

## ■ Correct Use

### Mounting

Always make sure that the power is turned OFF before mounting, removing, or wiring the Switch, or performing maintenance.

Do not tighten the mounting ring more than necessary using tools such as pointed-nose pliers. Doing so will damage the mounting ring. The tightening torque is 0.98 to 1.96 N·m.

Recommended panel thickness: 1 to 5 mm.

### Wiring

After wiring the Switch, maintain an appropriate clearance and creepage distance.

When DC-specific LEDs are used, wire the Switch so that the X1 terminal is positive.

Terminal screws must be Phillips or slotted M3.5 screws with a square washer.

The tightening torque is 1.08 to 1.27 N·m.

Single wires, stranded wires, and crimp terminals can be connected to the Switch.

### Applicable Wire Size

Stranded wire: 2 mm<sup>2</sup> max.

Solid wire: 1.6 dia. max.

#### Bare Crimp Terminals

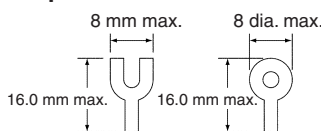

#### Crimp Terminals with Insulating Sheath

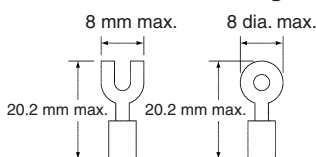

ALL DIMENSIONS SHOWN ARE IN MILLIMETERS.  
To convert millimeters into inches, multiply by 0.03937. To convert grams into ounces, multiply by 0.03527.

## Operating Environment

The IP65 model is designed with a degree of protection so that it will not sustain damage if it is subjected to water from any direction to the front of the panel.

## Using the Microload

Insert a contact protection circuit, if necessary, to prevent the reduction of life expectancy due to extreme wear on the contacts caused by loads where inrush current occurs when the contact is opened and closed.

The minimum applicable load is the N-level reference value. This value indicates the malfunction reference level for the reliability level of 60% ( $\lambda 60$ ) (conforming to JIS C5003).

The equation,  $\lambda 60 = 0.5 \times 10^{-6}/\text{operations}$  indicates that the estimated malfunction rate is less than 1/2,000,000 operations with a reliability level of 60%.

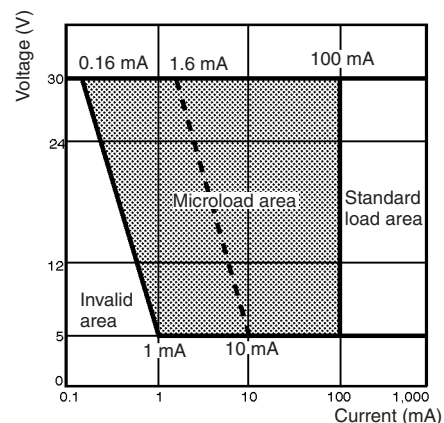

## LED

The LED current-limiting resistor is built-in, so internal resistance is not required.

If commercially available LEDs are used, select the ones that meet the following conditions:

Base: BA9S/13□

Overall length: 26 mm max.

Power consumption: 2.6 W max.

## Others

If the panel is to be finished with coating, etc., make sure that the panel meets the specified dimensions after the coating.

Do not subject the Switch to extreme shock or vibration. Doing so will cause malfunctions and damage to the Switch.