

From 1D, 2D to 3D!

Sensing lineup that expands dimension of quality problem solution

**1D** laser  
Smart Sensor ZS Series

High-precision measurement of targeted point



**2D** wide laser  
Smart Sensor ZG2 Series

Measuring height and width at the same time by wide laser beam

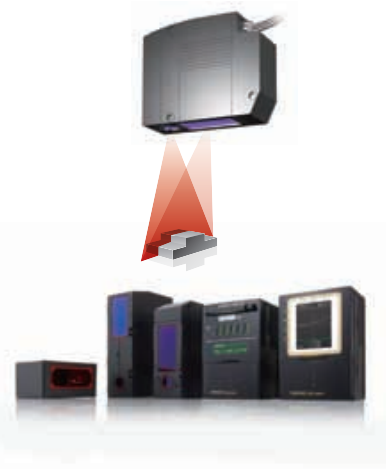

**3D** image processing  
Vision Sensor FZD Series

Practical in-line 3D measurement first in the industry!

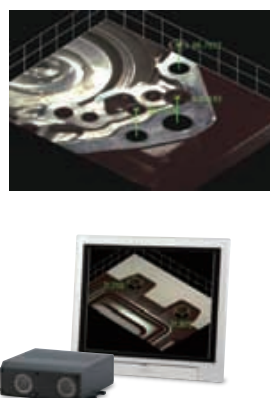

**OMRON**

**Smart Sensor**

ZG2 Series 2D Measurement Sensor



**2D Laser Profile Measurement System**

Achieving stable measurement through innovative technology



**Safety Precautions for Laser Equipment**

**WARNING**

Do not expose your eyes to laser radiation either directly or reflected from a mirrored surface. The emitted laser beams have a high power density and direct exposure may result in loss of eyesight.

The warning and explanatory label on the side of the Sensor Head in the ZG2 Series is in Japanese. Replace it with the English label that comes with the product.

**Class2**

**WARNING**

LASER RADIATION  
DO NOT STARE INTO BEAM  
CLASS 2 LASER PRODUCT  
MAXIMUM OUTPUT : 1.0mW  
PULSE DURATION : 20msec  
WAVE LENGTH : 650nm  
EN 60825-1:1994  
+A1:2002, +A2:2001

**Class2M**

**WARNING**

LASER RADIATION  
DO NOT STARE INTO THE BEAM OR VIEW DIRECTLY INTO OPTICAL INSTRUMENTS (SUNGLASSES) CLASS 2M LASER PRODUCT  
MAXIMUM OUTPUT : 5mW  
MINIMUM PULSE REPEAT RATE OF OPTICAL INSTRUMENTS : 10Hz  
PULSE DURATION : 15msec  
WAVE LENGTH : 650nm  
MEDIUM POWER CONDUCTOR LASER  
EN 60825-1:1994 +A2:2001 +A1:2002

This document provides information mainly for selecting suitable models. Please read the User's Manual carefully for information that the user must understand and accept before purchase, including information on warranty, limitations of liability, and precautions.

**Note: Do not use this document to operate the Unit.**

**OMRON Corporation**  
Industrial Automation Company  
Sensing Devices Division H.Q.  
Application Sensors Division  
Shiokoji Horikawa, Shimogyo-ku,  
Kyoto, 600-8530 Japan  
Tel: (81) 75-344-7068/Fax: (81) 75-344-7107

**Regional Headquarters**  
**OMRON EUROPE B.V.**  
Sensor Business Unit  
Carl-Benz-Str. 4, D-71154 Nufringen,  
Germany  
Tel: (49) 7032-811-0/Fax: (49) 7032-811-199

**OMRON ELECTRONICS LLC**  
One Commerce Drive Schaumburg,  
IL 60173-5302 U.S.A.  
Tel: (1) 847-843-7900/Fax: (1) 847-843-7787

**OMRON ASIA PACIFIC PTE. LTD.**  
No. 438A Alexandra Road # 05-05/08 (Lobby 2),  
Alexandra Technopark, Singapore 119967  
Tel: (65) 6835-3011/Fax: (65) 6835-2711

**OMRON (CHINA) CO., LTD.**  
Room 2211, Bank of China Tower,  
200 Yin Cheng Zhong Road,  
PuDong New Area, Shanghai, 200120, China  
Tel: (86) 21-5037-2222/Fax: (86) 21-5037-2200

**Authorized Distributor:**

© OMRON Corporation 2008 All Rights Reserved.  
In the interest of product improvement,  
specifications are subject to change without notice.

OMRON Industrial Automation Global: [www.ia.omron.com](http://www.ia.omron.com)

Cat. No. Q167-E1-01A

Printed in Japan  
1208-1M(0109)(AS)

realizing



# Easier and much more accurate for profile measurement

Stable measurement regardless of color, material, and shape complexity

## <Simple configuration>

Plug & play! Just connecting Sensor head and Controller.

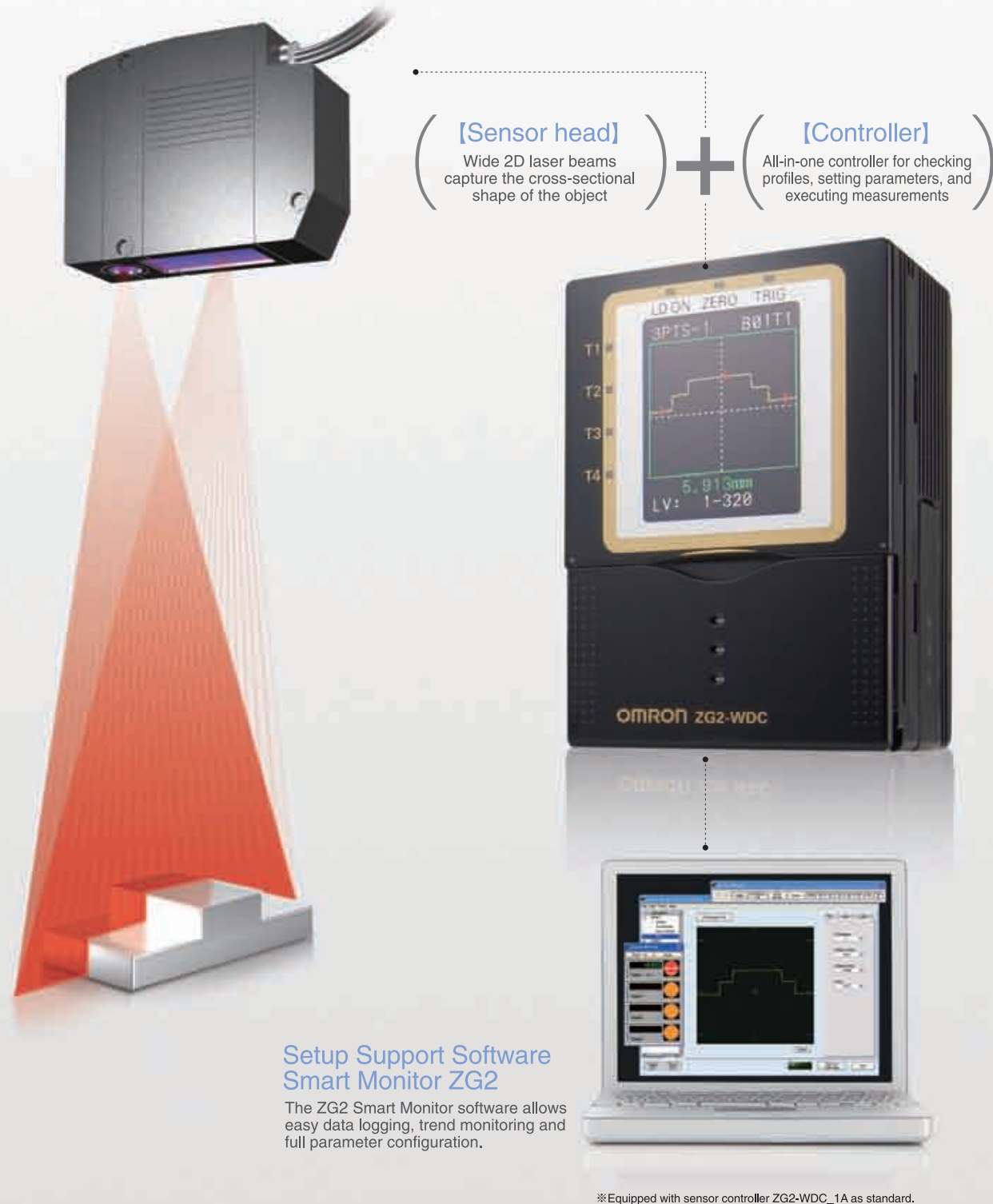

## <Outstanding Performance>

Through innovative technology the ZG2 offers superior performance to conventional 2D sensors.

**Industry's best**  
**12x** the conventional sensitivity

Stable measurements can be achieved even on low reflective materials and under difficult ambient light conditions.

Shiny objects and black rubber  
page 4

**Industry's best**  
**2.5x** the conventional inclination tolerance

Stable measurements on inclined or shaking objects.

Inclined, transparent or shaking objects  
page 5

**10x** the conventional speed

High speed measurement performance on challenging objects.

High-speed cycle time  
page 5

## A wide variety of measurement items

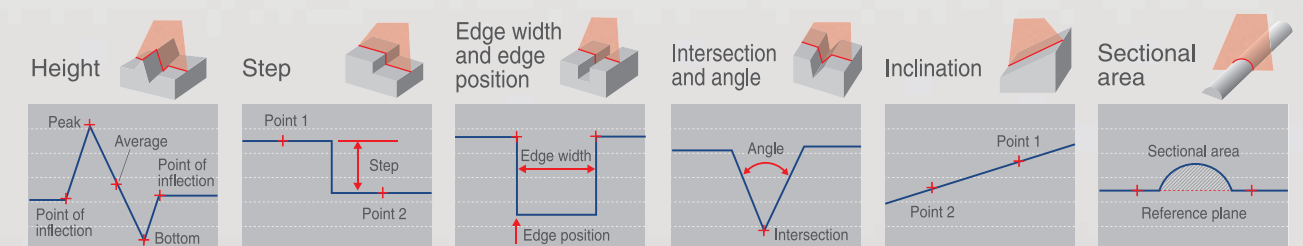



Industry's best **12x** the conventional sensitivity

**7x** the conventional ambient illumination

## Shiny objects and black rubber

Dark colored materials or materials with a matt finish, like black rubber often do not reflect sufficient light to maintain a stable measurement. They are also susceptible to the influences of ambient light so are difficult to measure using conventional laser measurement sensors. The ZG2 solves these problems because it is supersensitive and significantly reduces ambient noise. It also has an APS function to automatically tune parameters such as a receiver's sensitivity and background suppression level at optimal levels according to the ambient light conditions. Shape profiles can also be easily reproduced at optimal conditions to achieve high precision measurement. Measurement of moving objects is possible because measurement can be performed within a short exposure time.

※ For details, see descriptions of the APS function (page 9) and new optical system ONPS (page 8).

### Flush and Gap on car doors

Gaps on car doors can be measured at a stable level without being influenced by the color.



### Overlap or damage when manufacturing tires

The ZG2 can check for overlap or damage of black rubber.



Industry's best **2.5x** the conventional inclination tolerance

## Inclined, transparent or shaking objects

On a shiny and transparent object with strong regular reflection, the amount of light reflection significantly reduces when the object is slightly inclined and is lowering the measurement stability. The sensor head ZG2-WDS3VT with a high-performance gauss lens is the solution for the problem. Its inclination tolerance range has been increased to 2.5 times as compared to conventional models so transparent objects can be measured up to a  $\pm 5^\circ$  inclination at a stable level. ZG2 is the ideal solution for assembly inspections for lenses and glass.

※ For details, see descriptions of the high-performance gauss lens (page 8).

### Assembly inspection of electronic parts

The ZG2 can measure parts with glass or a glossy object such as CCDs, CMOSs, and crystal splinters of quartz resonators at a stable level. It can be used for assembly inspections of parts because it can measure steps on a substrate or package side.

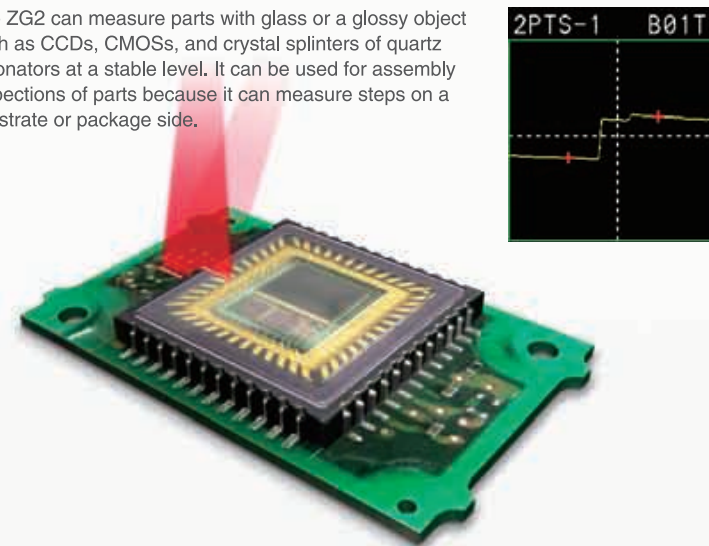

### Assembly inspection of lenses

The ZG2 can measure the step between the peak of a lens and lens holder to check if they are assembled properly.

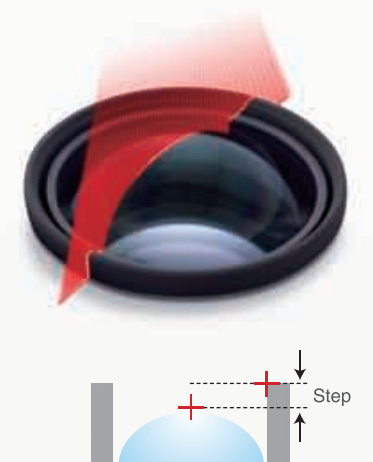

**10x** the conventional speed

## High-speed cycle time

Reproducing a clear, stable profile is difficult for objects with both black and metal surfaces, cylindrical or complex-shaped objects, because the amount of laser reflection and reflection angle differ according to the positions of different materials on such objects. Omron's unique "multi-sensitivity function" enables high speed profile measurement on these challenging objects.

※ For details, see descriptions of high-speed multi sensitivity (page 9).

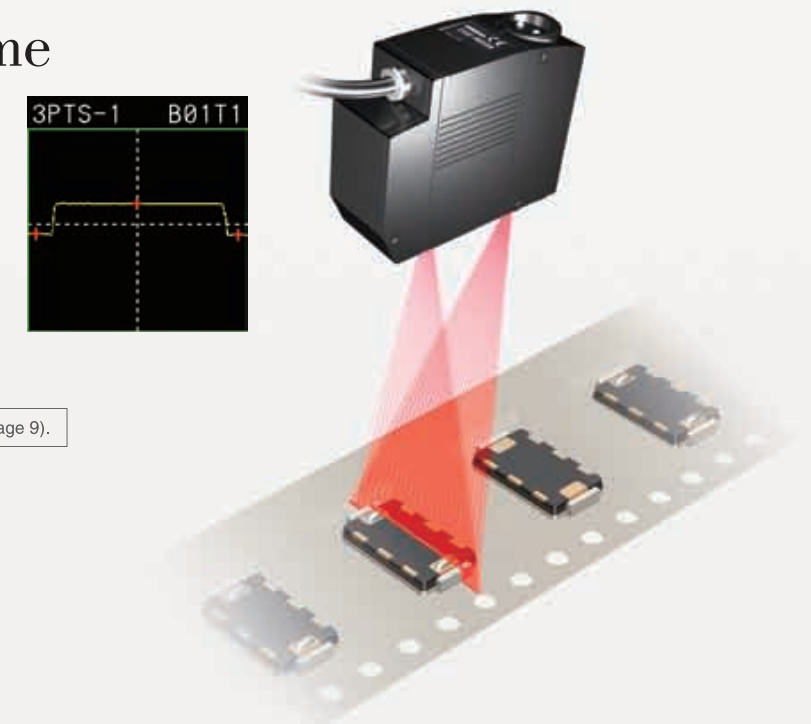

## Measurement of wide profiles

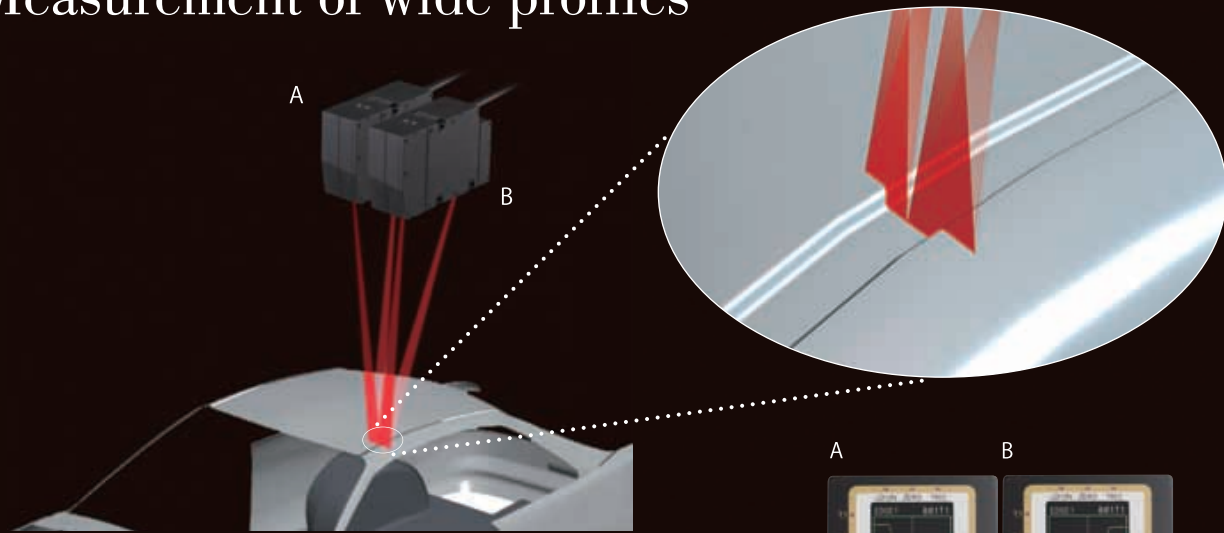

Two sensor controllers are linked and two sensor heads perform synchronous measurement to increase the measurement range to 140 mm. With the link method, the ZG2 Series provides the optimum solution for any intended purpose.

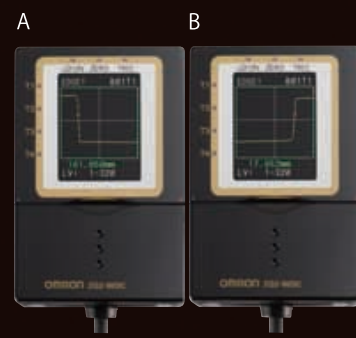

## Measurement by finding the inflection point of the object

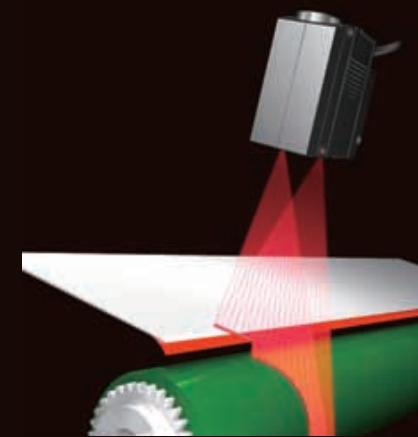

The sensor has a measurement function to capture points where an angle varies on a target as an "inflection point." This function enables the measurement of a step or edge width of a feature point of a target.

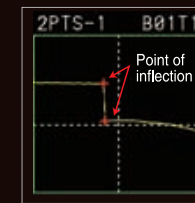

## Measurement of position and angle of intersection

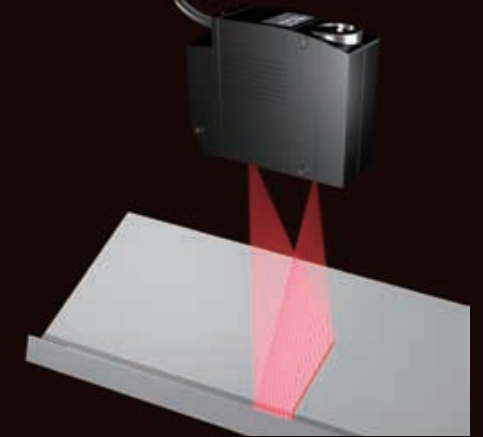

The sensor has a function to measure the "intersection coordinates" and "intersection angle" on two linear lines on a target. An example of a useful application of this function is tracer control for a welding torch for targets to be welded.



## Simplified Sensor Head Adjustment

The "installation correction function" automatically makes adjustments to parallelly align the sensor head with the target. The function eliminates the gap between the reference plane and sensor head inclination caused during setup and in turn significantly reduces the time spent for adjustment during the setup of the sensor head.

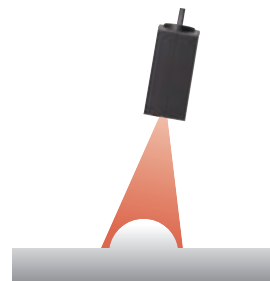

※When inclination is great, a measurement error may occur. Check the measurement accuracy in actual measurement conditions prior to use.

## Intuitive setting

Basic setting requires only three steps. Omron's unique interface maximizes the sensing performance with extremely simple operation.

1st STEP	2nd STEP	3rd STEP
<p>Display a profile.</p> <p>A profile is displayed as soon as the power is turned ON.* Adjust the Sensor Head position while viewing the profile on the screen.</p> <p>*In the FUN mode</p>	<p>Select a measurement item.</p> <p>Select the icon for the item to be measured, such as height, step, or sectional area.</p>	<p>Specify the measurement range.</p> <p>Simply enclose the range to be measured with the box on the profile. The ZG2 automatically optimizes the sensing conditions.</p>

※ Screen images are simulated.

## Simultaneous measurement of two or more points

Measurements can be performed for up to eight measurement points selected from a profile simultaneously so different types of inspections can be carried out at the same time when necessary. Measurement items can be selected from among 20 items including edge width, height, inclination, step, and sectional area according to the intended purpose.

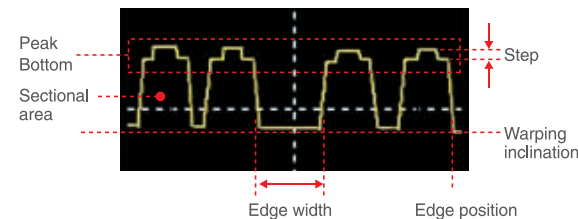

## Active Position Compensation Control

The position and inclination are automatically corrected even for targets for which positioning is difficult. This helps to perform stable in-line measurement.

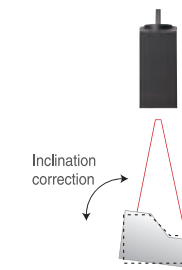

Example) 2-point step measurement

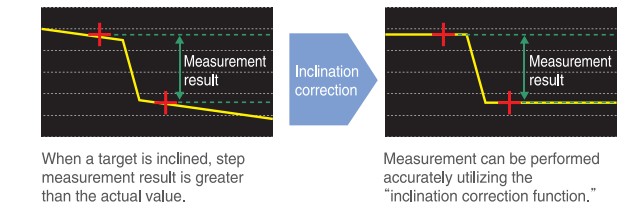

## Data Storage and Trend Analysis

A data storage unit is now available for storing measurement values and profile data. Data can be loaded on a PC from a memory card or via serial communication and can be used to manage manufacturing history, monitor tendency, or analyze defects.



※For logging capacity, see System Configuration (page 10).

## Large Programme Capacity

Measurement conditions for up to 16 items (16 banks) can be registered in the sensor controller unit. Banks can be easily switched by inputting a signal, inputting a command, or operating a key. When the data storage unit is used, up to 4,096 banks can be registered for quick response to flexible production lines.

<p>Measurement conditions for up to <b>4,096</b> items can be stored in the data storage unit.</p>		<p>Measurement conditions for up to <b>16</b> items can be stored in the sensor controller.</p>
--	--	---



# Sensor Head

## 2 Dimensional Measurement

A light-cutting method is used. The widely-spread laser beam is projected on the measurement object to measure its cross-sectional shape.

### Measurement principle

A band-like laser beam is projected on the measurement object, and the reflection from the object is received by the CCD. A shape profile of the measurement object is formed based on the principle of triangular distance measurement. Since 2D data of the X and Z axes are measured simultaneously, there is no need to move either the sensor or measurement object.

#### [ Three CCD modes ]

Since three CCD modes are available; high-speed mode, standard mode, and high-precision mode, the ZG2 can be used for processes that require high speed or inspections that require higher precision. The measurement center distance remains fixed even when the mode is changed so the sensor head position does not need to be adjusted.

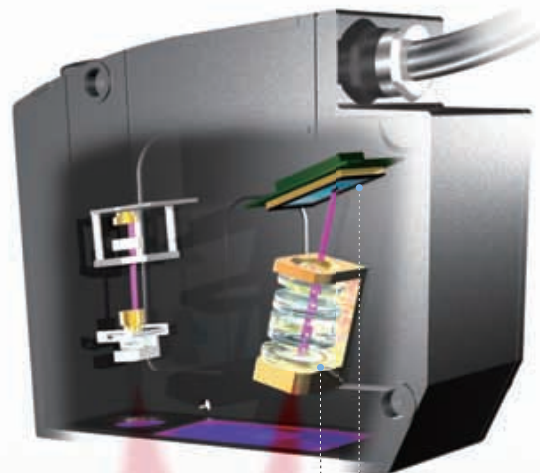

• CCD  
• High-performance gauss lens [TAGG]

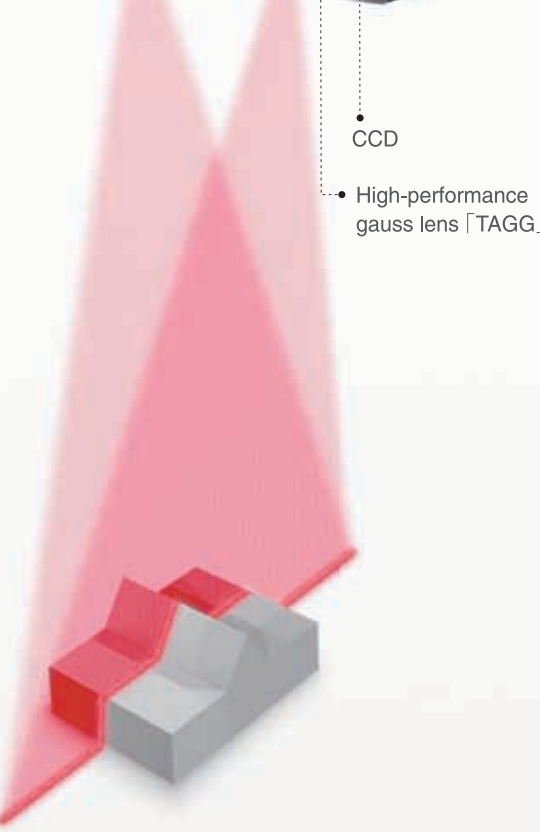

## Suitable for transparent and mirror surface objects

# High-performance gauss lens [TAGG]

Patent pending Mounted on the ZG2-WDS3VT

The new gauss lens was born out of Omron's passion for sensing technology. In the lens, a coupling lens structure including an aspherical lens is used, which allows for clear, bright images with low aberration, even though it is a wide-angle lens. Previous lens designs could not receive sufficient light reflection when objects were inclined. Using the new TAGG lens design, light reflection can be received at angles up to  $\pm 5^\circ$ . The lens shows excellent performance for stable measurement of mirror and gloss surfaces with large amounts of regular reflection components and also transparent objects such as glass.

[TAGG]: Transparency And Gloss surface detector by Gauss composition

## Resists the effects of ambient light

# New optical system ONPS Patent pending

Utilizing its unique optical filter technology, Omron has developed a new optical system where ambient light components are effectively removed so that only necessary reflection components from the object can be received. A control system is also used in which the laser exposure period and the CCD receiving period are synchronized. The combined effect of these has achieved ambient illumination resistance of 7,000 lx, seven times higher than conventional models. Measurement can be performed at a stable level without being influenced by fluorescent light or other surrounding conditions.

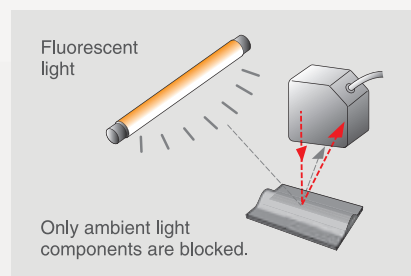

[ONPS]: Optical Noise Protection System

# Sensor Controller

## Powerful functionality in a compact design

The business card sized ZG2 controller incorporates a built in LCD monitor for profile visualization. The LCD display also gives access to the ZG2's intuitive and simple to use setup screens. The controller also includes a USB and RS-232C interface for easy connectivity.

### Operation interface

Measurement conditions are indicated by easy-to-understand icons.

Select an icon directly with a function key.



### Input/output interface

Equipped with USB and RS-232C port as standard.

The real-time parallel output unit for extending a parallel port is available (optional).

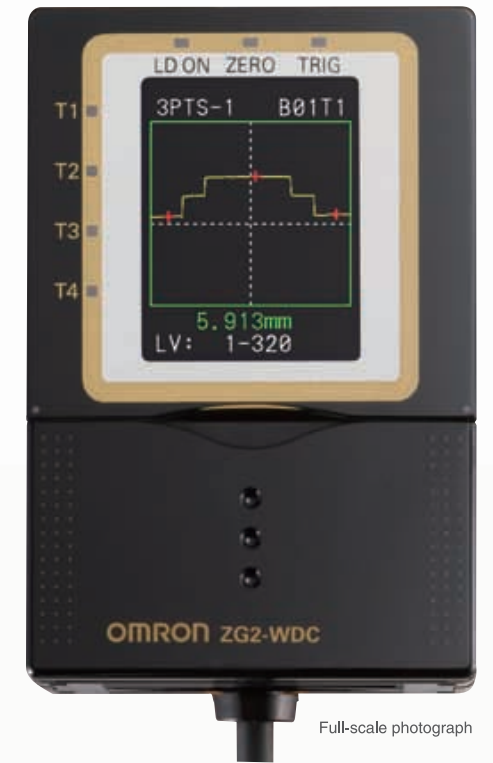

Full-scale photograph

## Stable measurement regardless of material and color

# APS function Patent pending

A 2D measurement sensors is projecting a wide beam onto an object to simultaneously check its dimensions such as the width and gap. Since light reflects differently according to the material, color, and shape of an object's surface, it may require a long setup time to obtain a complete profile, without any interrupts. The ZG2 has an "APS function" which combines a variety of techniques for obtaining profiles. An ideal profile without lost parts can be obtained with the simple push of a button. Black objects and difficult ambient light conditions are no longer a problem compared to conventional sensors. Tuning is simple and easy to reduce the initial setup time significantly.



Optimal tuning for the measurement object with the simple push of a button

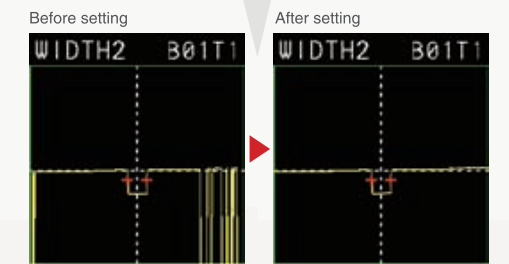

Lost part on a profile due to insufficient amount of light received

[APS]: Auto Profile Search

## Stable measurement for complex shapes

# High-speed multi sensitivity Patent No. 3575693

Omron's unique "multi-sensitivity function" is used to measure complex shapes by varying the intensity of the laser light over different areas of reflectivity across the object. The ZG2 can now perform measurements on higher-speed production lines.

### Principle

While switching sensitivity levels for workpieces of which reflectivity varies from part to part, the sensor inputs multiple images and combines parts taken at the optimal sensitivity into a single image. This produces an image of the entire workpiece.

### Effect

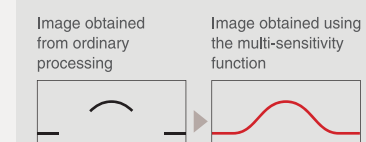

[Example] A workpiece with a mountain-shaped reference plane. Reflectivity varies from part to part.

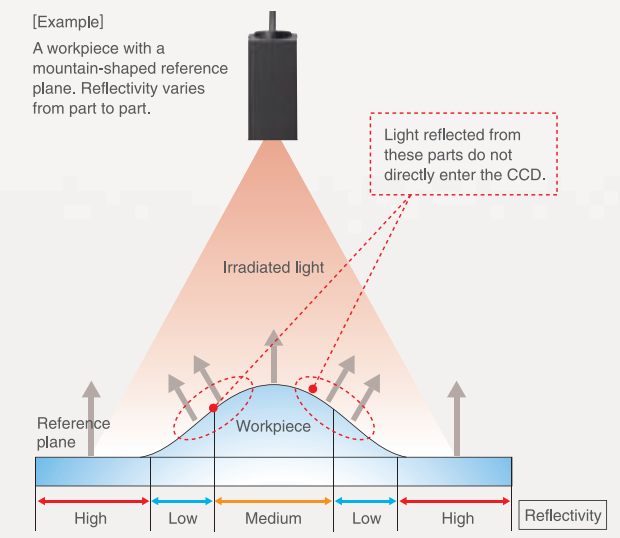

# System Configuration

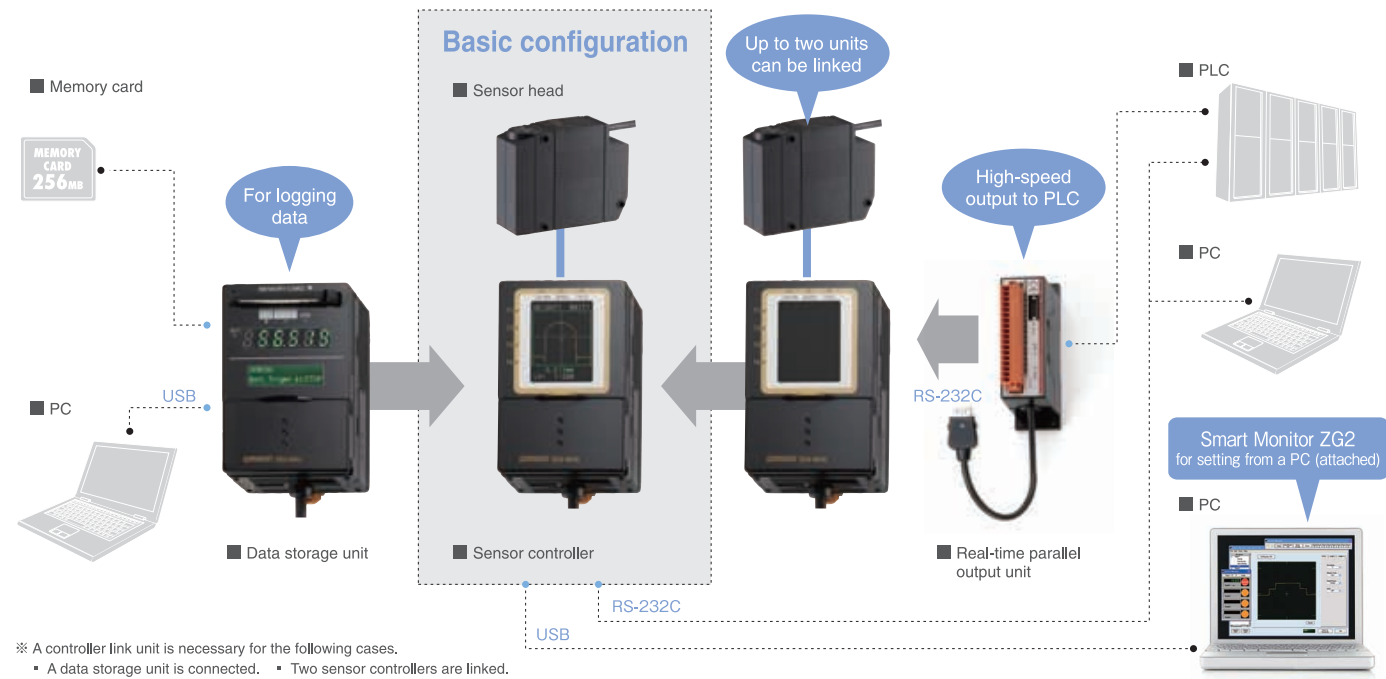

## 27 m max. Sensor Head Extension Cables

Highly-flexible extension cables of four different lengths are available. The distance between the sensor head and sensor controller can be extended up to 27 m without delaying image input periods.



## Multi function unit Data Storage Unit ZG2-DSU

### [ Collect measurement values ]

Up to 65,000 values can be stored in the memory of the main unit. Up to 7,150,000 values (65,000 values x 110 files) can be saved in a memory card (256 MB).

### [ Save profile data ]

Up to 5,120 object profiles can be saved. Up to 35,328 profiles (256 profiles x 138 files) can be saved in a memory card (256 MB). Saved data can be used for analyzing defects.

### [ Readiness for high-mix production ]

Up to 4,096 banks of data for stage replacement can be saved for quick response for high-mix production lines.

※ Saving capacity differs according to set conditions. See the Ratings and Specifications table.

## Setting, Analysis, and Data Storage via PC Smart Monitor Software

Using the software equipped with the sensor controller ZG2-WDC\_1A, sensing conditions can be easily specified using a PC. Intricate profiles, which cannot be sufficiently checked on the Controller's LCD monitor, can be enlarged for thorough checking on a PC screen.

### [ Measurement value logging ]

Measurement value logging results are displayed in a time series. They are useful for trend management.

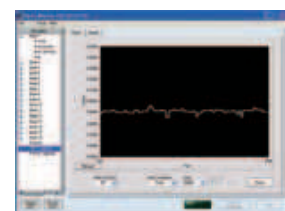

### [ Profile logging ]

In addition to measurement values, profile data logging is now enabled.

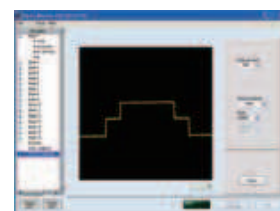

### [ Setup support ]

Helps to check intricate profiles that cannot be sufficiently checked on the controller's LCD monitor and provides easy-to-view setting lists for easy setting.

Profiles are displayed on a large screen. They can be enlarged by the [Zoom] button.

Connect the PC where Smart Monitor ZG2 is used and the sensor controller by the USB cable attached to the sensor controller (ZG2-WDC\_1A) together with Smart Monitor ZG2.

# Order Information

## Sensor Heads

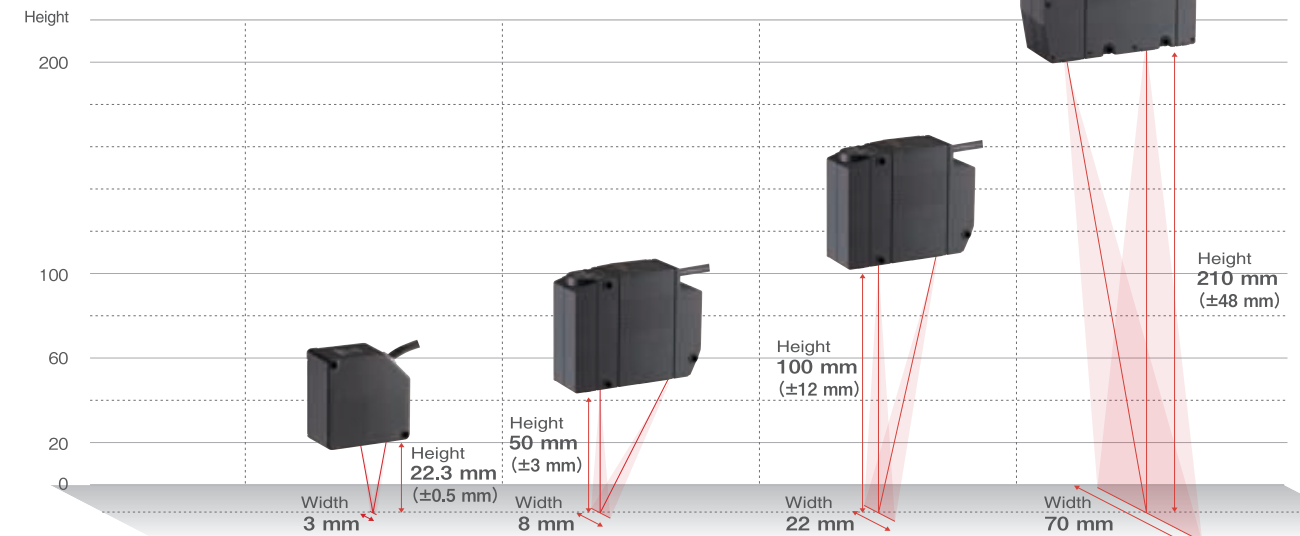

Optical system		Regular reflective	Diffuse reflective	Diffuse reflective	Regular reflective	Diffuse reflective	Regular reflective	Diffuse reflective	
		Measurement range	Height direction	22.3±0.5 mm	10.6±0.4 mm	50±3 mm	44±2 mm	100±12 mm	94±10 mm
Resolution	Width direction	3 mm (typical)	8 mm (typical)	22 mm (typical)	70 mm (typical)	5 μm	13 μm (8 mm/631 pixels)	35 μm (22 mm/631 pixels)	111 μm (70 mm/631 pixels)
	Height direction	0.25 μm	1 μm	2.5 μm	6 μm	Model	ZG2-WDS3VT	ZG2-WDS8T	ZG2-WDS22

※ For details, see the Ratings and Specifications Table. ※ When ordering, specify the cable length (0.5 m, 2 m).

## Sensor Controllers

Note : Setup support software for PC is attached.

Appearance	Power supply	Output type	Model
	24 VDC	NPN	ZG2-WDC11A (See note.)
			ZG2-WDC11
		PNP	ZG2-WDC41A (See note.)
			ZG2-WDC41

## Data Storage Unit

Appearance	Power supply	Output type	Model
	24 VDC	NPN	ZG2-DSU11
		PNP	ZG2-DSU41

## Accessories (Order Separately)

### Real-time Parallel Output Unit

Appearance	Output type	Model
	NPN	ZG-RPD11
	PNP	ZG-RPD41

### RS-232C Cable

Connecting device	Model	Qty
For PLC/PT connection (2 m)	ZS-XPT2	1
For personal computer connection (2 m)	ZS-XRS2	1

## Controller Link Unit

Appearance	Model
	ZS-XCN

### Sensor Head Extension Cable (Robot Cable)

Appearance	Cable length	Model	Qty
	25 m	ZG2-XC25CR	1
	15 m	ZG2-XC15CR	1
	8 m	ZG2-XC8CR	1
	3 m	ZG2-XC3CR	1

### Parallel Mounting Adaptor

Appearance	Model
	ZS-XPM1 For 1 Unit
	ZS-XPM2 For 2 Units or more

## Memory Card

Capacity	Model
128 MB	F160-N1285
256 MB	F160-N2565



# Ratings and Specifications

## Sensor Heads

Item		ZG2-WDS8T		ZG2-WDS22		ZG2-WDS70		ZG2-WDS3VT	
Optical system		Diffuse reflective	Regular reflective	Diffuse reflective	Regular reflective	Diffuse reflective		Regular reflective	Diffuse reflective
Measurement range	Height direction	50 ± 3 mm	44 ± 2 mm	100 ± 12 mm	94 ± 10 mm	210 ± 48 mm (In the high-precision mode)		22.3 ± 0.5 mm	10.6 ± 0.4 mm
	Width direction	8 mm (typical)		22 mm (typical)		70 mm (typical)		3 mm (typical)	
Resolution	Height direction (See note 1.)	1 μm		2.5 μm		6 μm		0.25 μm	
	Width direction	13 μm (8 mm / 631 pixels)		35 μm (22 mm / 631 pixels)		111 μm (70 mm / 631 pixels)		5 μm (3 mm / 631 pixels)	
Linearity (in the height direction) (See note 2.)		± 0.1 %F.S.							
Temperature characteristic (See note 3.)		0.03 %F.S./°C			0.02 %F.S./°C			0.08 %F.S./°C	
Light source	Type	Visible semiconductor laser							
	Wavelength	658 nm				650 nm			
	Output	5 mW max. output, 1 mW max. exposure (without using optical instruments)							
	Laser class	Class 2M of EN60825-1 / IEC60825-1 Class IIIB of FDA (21CFR 1040.10 and 1040.11)				Class 2 of EN60825-1 / IEC60825-1 Class II of FDA (21CFR 1040.10 and 1040.11)			
Beam shape (at measurement center distance) (See note 4.)		30 μm × 24 mm (typical)		60 μm × 45 mm (typical)		120 μm × 75 mm (typical)		25 μm × 4 mm (typical)	
LED		STANDBY : Lights when laser irradiation preparation is complete (indication color : green) LD_ON : Lights when the laser is irradiating (indication color : green)							
Measurement object		Surface of non-transparent / transparent objects				Surface of non-transparent objects		Surface of non-transparent / transparent objects	
Environmental resistance	Ambient light intensity	Illumination on the photo-receiving face 7,000 lx max. : Incandescent lamp							
	Ambient temperature	Operating : 0 to 50°C, Storage : -15 to 60°C (with no icing or condensation)							
	Ambient humidity	Operating and storage : 35 to 85 % (with no condensation)							
	Degree of protection	IP66 (IEC60529)				IP67 (IEC60529)			
	Vibration resistance (destruction)	10 to 150 Hz with 0.35 mm single amplitude for 80 min each in X, Y, and Z directions							
	Shock resistance (destruction)	150 m/s <sup>2</sup> , 3 times each in 6 directions (up / down, right / left, forward / backward)							
Materials		Case: Aluminum diecast, Front cover : Glass, Cable insulation : Heat-resistive polyvinyl chloride (PVC), Connector : Zinc alloy or brass							
Cable length		0.5 m, 2 m (flexible cable)							
Weight		Approx. 500 g		Approx. 500 g		Approx. 650 g		Approx. 300 g	
Accessories		Laser labels (EN : 2 labels, FDA : 3 labels), Ferrite core (1), Instruction manual							

Note : 1. Obtained by setting an OMRON standard measurement object at the measurement center distance and determining the average height of the beam line. The conditions are given in the table below. However, satisfactory resolution cannot be attained in strong electromagnetic fields. The minimum resolution of the ZG2-WDS8T/WDS3VT is 0.25 μm, even when the average number of operations is increased. Resolution does not go any lower.

Model	CCD mode	Average No. of operations	Measurement object	
			Regular reflective	Diffuse reflective
ZG2-WDS8T/ZG2-WDS22/ZG2-WDS70	High-precision mode	64	OMRON standard white alumina ceramic object	
ZG2-WDS3VT			OMRON standard mirrored object	OMRON standard diffuse reflective object

Note : 2. The tolerance for and ideal straight line obtained by determining the average height of and OMRON standard measurement object for the beam line. The CCD standard mode is used. Linearity varies depending on the measurement object.

Model	Measurement object	
	Regular reflective	Diffuse reflective
ZG2-WDS8T/ZG2-WDS22/ZG2-WDS70	OMRON standard white alumina ceramic object	
ZG2-WDS3VT	OMRON standard mirrored object	OMRON standard diffuse reflective object

Note : 3. A value attained by using an aluminum jig to secure the distance between the Head and the measurement object. The CCD standard mode is used.

Note : 4. Defined as 1/e<sup>2</sup> (13.5%) of the center light intensity. This may be influenced when light leakage also exists outside the defined area and the reflectivity of the light around the measurement object is higher than that of the measurement object.

## Sensor Controllers

Item		ZG2-WDC11/WDC11A	ZG2-WDC41/WDC41A
Input/output type		NPN	PNP
No. of connectable Sensor Heads		1 per Controller	
No. of connectable Controllers		2	
Measurement cycle (See note 1.)		16 ms (high-precision mode), 8 ms (standard mode), 5 ms (high-speed mode)	
Min. display unit		10 nm	
Display range		-999.99999 to 999.99999	
Display	LCD monitor	1.8-inch TFT color LCD (557 x 234 pixels)	
	LEDs	<ul style="list-style-type: none"> <li>Judgment indicators for each task (indication color : orange) : T1, T2, T3, T4</li> <li>Laser indicator (indication color : green) : LD_ON</li> <li>Zero reset indicator (indication color : green) : ZERO</li> <li>Trigger indicators (indication color : green) : TRIG</li> </ul>	
External interface	Input/output signal lines	Analog outputs	Select voltage or current (using the sliding switch on the bottom surface) <ul style="list-style-type: none"> <li>Voltage output : -10 to 10 V, output impedance : 40 Ω</li> <li>Current output : 4 to 20 mA, maximum load resistance : 300 Ω</li> </ul>
		Judgment output (ALL-PASS/NG/ERROR)	NPN open collector 30 VDC, 50 mA max. Residual voltage : 1.2 V max.
	Trigger auxiliary output (ENABLE/GATE)	PNP open collector 50 mA max. Residual voltage : 1.2 V max.	
	Laser stop input (LD-OFF)	ON : 0 V short or 1.5 V max.	
	Zero reset input (ZERO)	ON : Power supply voltage short or power supply voltage -1.5 V max.	
	Measurement trigger input (TRIG)	OFF : Open (leakage current : 0.1 mA max.)	
	Bank switching input (BANK A-D)	OFF : Open (leakage current : 0.1 mA max.)	
	Serial I/O	USB2.0	1 port, full speed (12 Mbps), MINI-B
		RS-232C	1 port, 115,200 bps max.
		Parallel output (when ZG-RPD is mounted)	Output
Main functions	No. of setting banks	16	
	Sensitivity adjustment	Multi, High-speed multi, Auto, Fixed	
	Measurement items	Height, 2-point Step, 3-point Step, Edge position, Edge width, Angle, Intersection coordinates, Intersection angle, Sectional area (up to eight items can be measured simultaneously)	
	Auxiliary functions	Filter, Laser power adjustment, Position correction (height, position, slope), Linked operation, Point of inflection measurement	
	Profiles saved	16 profiles (1 profile per bank)	
	Trigger modes	External trigger / continuous	
Ratings	Power supply voltage	21.6 to 26.4 VDC (including ripple current)	
	Current consumption	0.8 A max. (per sensor head)	
	Insulation resistance	20 MΩ at 250 V between lead wires and Controller case	
	Dielectric strength	1,000 VAC, 50 / 60 Hz for 1 min between lead wires and Controller case	
	Environmental resistance	Ambient temperature	Operating : 0 to 50°C, Storage : -15 to 60°C (with no icing or condensation)
Ambient humidity		Operating and storage : 35 to 85 % (with no condensation)	
Degree of protection		IP20 (IEC60529)	
Vibration resistance (destruction)		Vibration frequency : 10 to 150 Hz, single amplitude : 0.35 mm, acceleration : 50 m/s <sup>2</sup>	
Shock resistance (destruction)		150 m/s <sup>2</sup> , 3 times each in 6 directions (up / down, right / left, forward / backward)	
Material		Case : Polycarbonate (PC), Cable insulation : Heat-resistive polyvinyl chloride (PCV)	
Cable length		2 m	
Weight		Approx. 300 g (including cable) (Packed state: Approx. 450 g)	
Accessories		ZG2-WDC_1 : Large Ferrite Core (1 piece), Instruction Manual ZG2-WDC_1A : Large Ferrite Core (1 piece), Small Ferrite Core (2 pieces), Instruction Manual, Setup Support Software (CD-ROM), USB cable (1 m)	

Note : 1. The image input periods listed here are for fixed/auto sensitivity. The image input period will be longer for multi-sensitivity, high-speed multi-sensitivity, or other settings. When the high-power mode is ON, the shortest image input period is 95 ms regardless of the setting of the CCD mode. Use the eco monitor in the RUN mode to determine the actual image input period.

## Data Storage Unit

Item		ZG2-DSU11	ZG2-DSU41
Input/output type		NPN	PNP
No. of connectable Controllers		2 (See note 1.)	
Connectable Controllers		ZG2-WDC11/WDC41	
External interface	Input/output signal lines	Inputting starting/terminating logging	ON : 0 V short or 1.5 V max. OFF : Open (leakage current : 0.1 mA max.)
		Judgment output (HIGH/PASS/LOW/ERROR)	NPN open collector 30 VDC, 50 mA max. Residual voltage : 1.2 V max.
	Serial I/O	USB2.0	1 port, full speed (12 Mbps), MINI-B
		RS-232C	1 port, 115,200 bps max.
Functions	No. of logged data (See note 2.)	Memory of the main unit	Profiles saved : 5,120 profiles Measurement values saved : 65,000 values max. (See note 3.)
		Memory card (256 MB) (See note 4.)	Profiles saved : 35,328 profiles max. (256 profiles x 138 files) Measurement values saved : 7,150,000 values max. (65,000 values x 110 files)
	Logging trigger functions		External triggers, data triggers (self-triggers), and time triggers
	External banks functions		4096
Other functions		Alarm output functions	
Ratings	Power supply voltage	21.6 to 26.4 VDC (including ripple current)	
	Current consumption	0.5 A max.	
Environmental resistance	Ambient temperature	Operating : 0 to 50°C, Storage : 0 to 60°C (with no icing or condensation)	
	Ambient humidity	Operating and storage : 35 to 85 % (with no condensation)	
Material		Case : Polycarbonate (PC)	
Cable length		2 m	
Weight		Approx. 280 g	
Accessories		Ferrite Core (1 piece), Instruction Manual	

Note : 1. The controller link unit is necessary for linking.  
Note : 2. Data is saved in the memory of the main unit during logging. The data is automatically saved in a memory card after logging is completed. The maximum number of logging differs according to set conditions. For details, refer to the Users Manual.  
Note : 3. Measurement values for 65,000 measurements can be saved even when two sensor controllers are connected and each performs eight tasks.  
Note : 4. The value is the maximum number achieved in the following conditions.

- One sensor controller performs one measurement task.
- Either profiles or measurement values are logged.

# Dimensions

## Sensor Heads

ZG2-WDS3VT  
<Regular reflection>

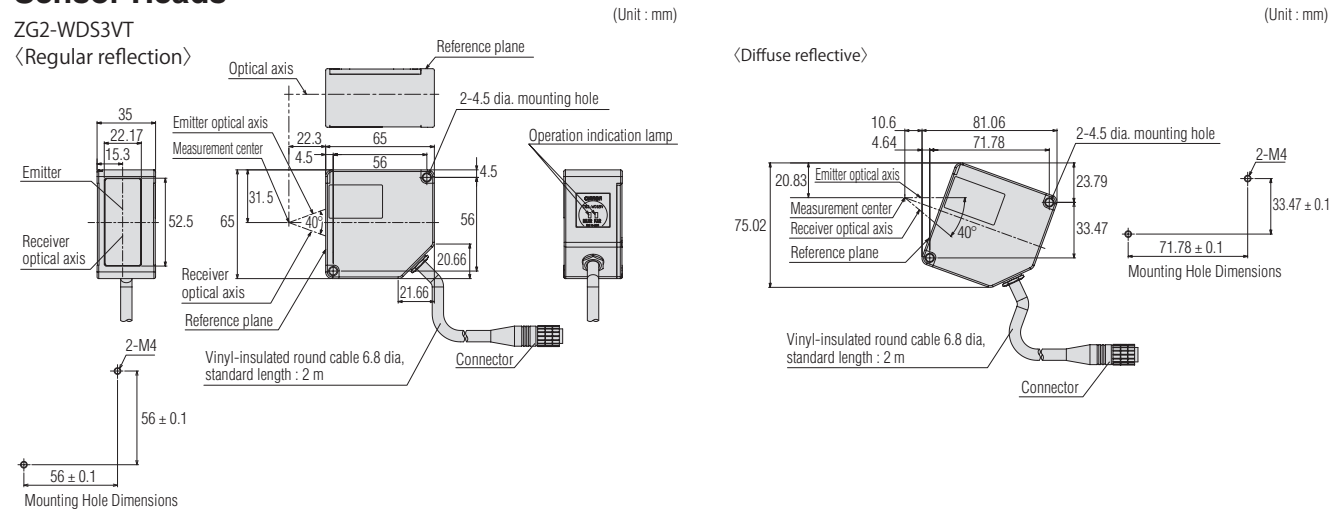

## Sensor Heads

ZG2-WDS70  
<Diffuse reflective>

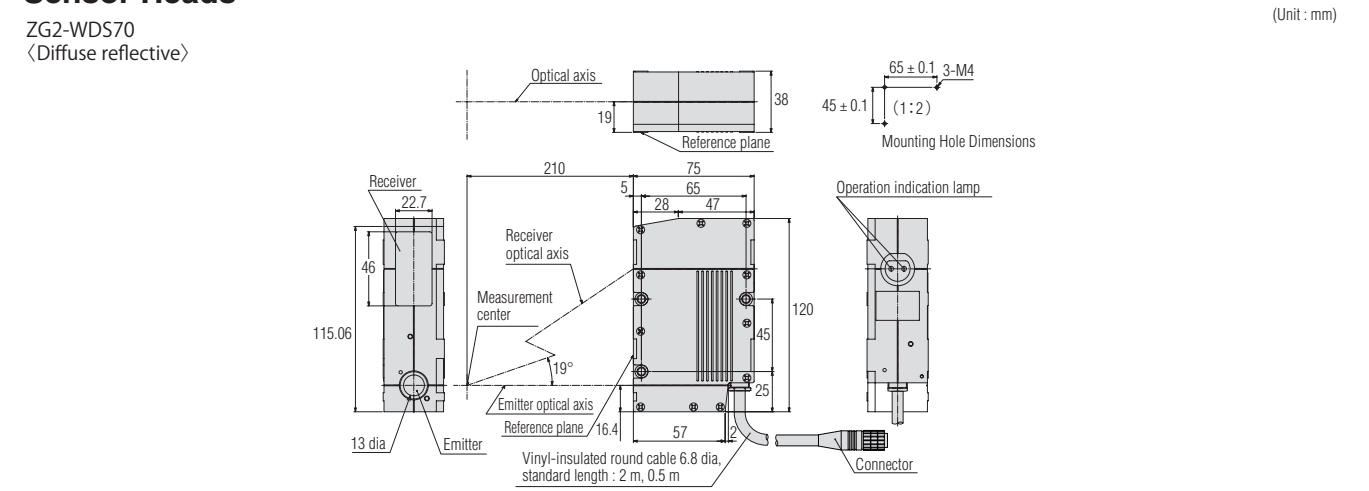

## Sensor Heads

ZG2-WDS8T/WDS22  
<Diffuse reflective>

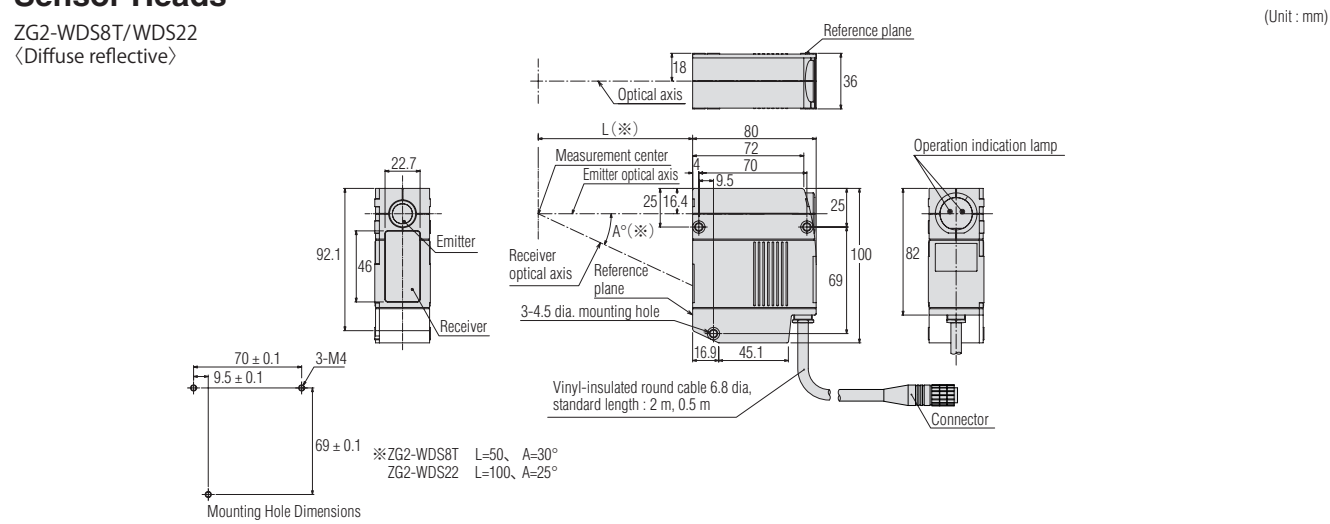

## Sensor Controller

ZG2-WDC11/WDC41

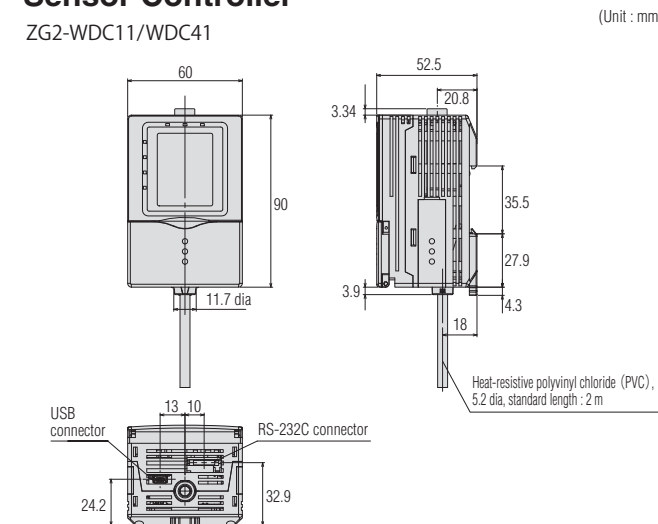

## Data Storage Unit

ZG2-DSU11/DSU41

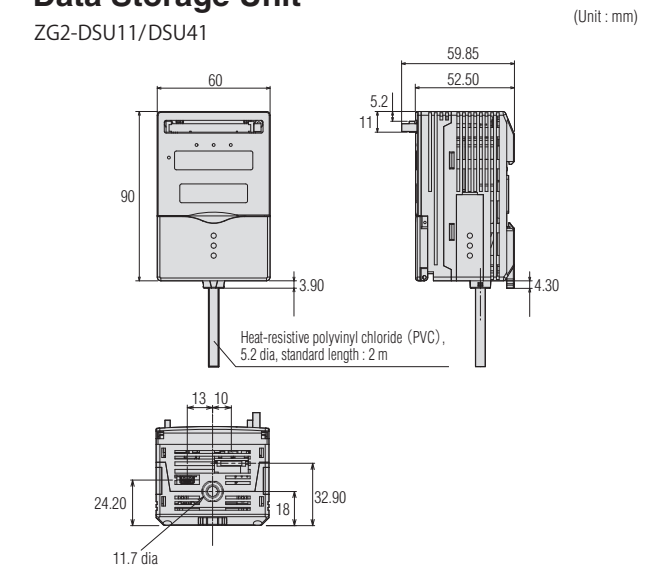

## Sensor Heads

ZG2-WDS8T  
<Regular reflection>

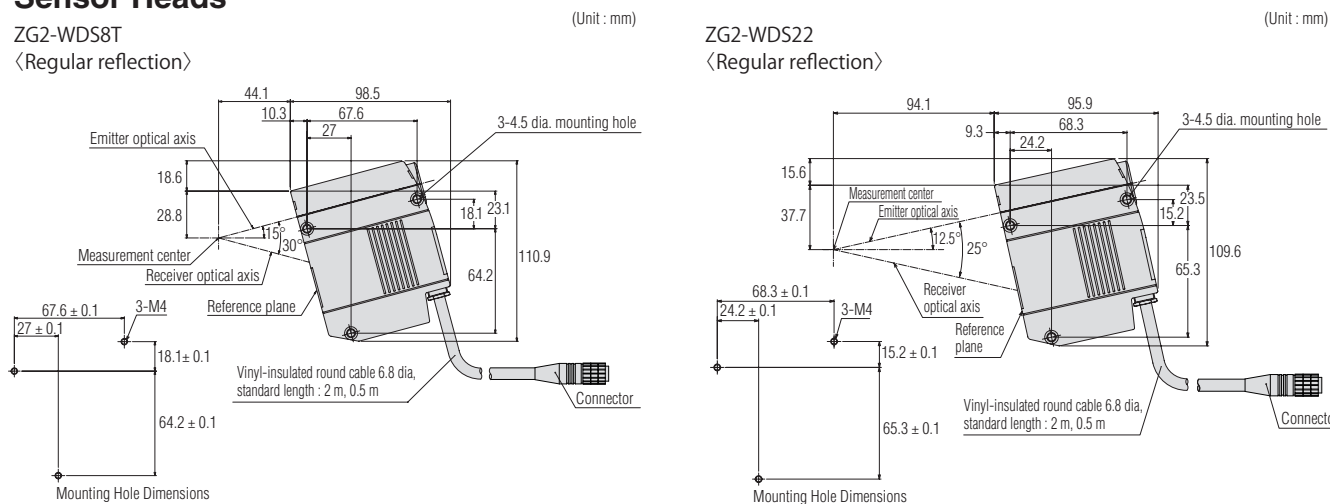

ZG2-WDS22  
<Regular reflection>

## Panel Mounting Adaptor

ZS-XPM1/XPM2 (Dimensions for mounting on a control panel)

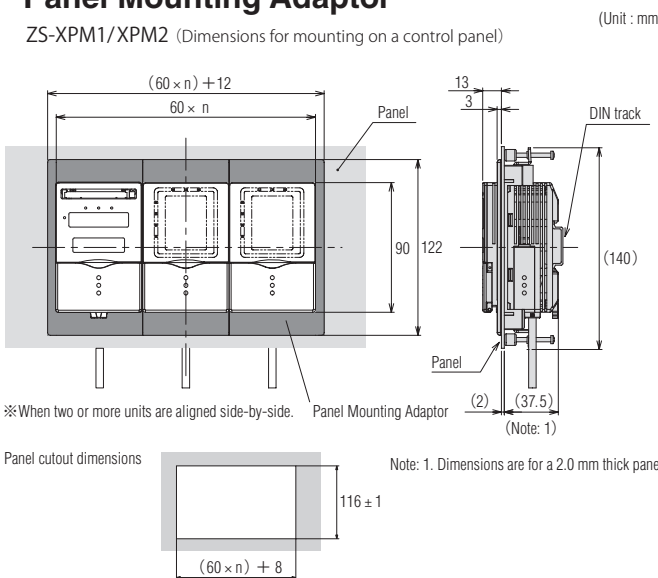

## Real-time Parallel Output Unit

ZG-RPD11/RPD41

