

NT-series

Host Interface Units

OPERATION MANUAL

OMRON

NT-series Host Interface Units

Operation Manual

Revised October 1993

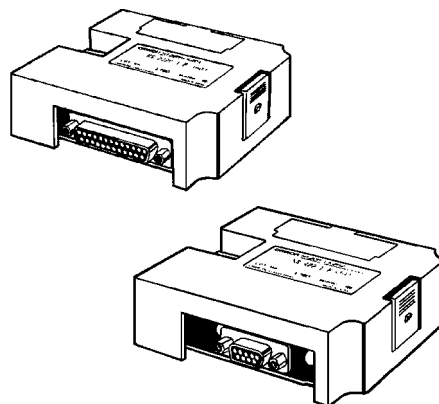

Notice:

OMRON products are manufactured for use according to proper procedures by a qualified operator and only for the purposes described in this manual.

The following conventions are used to indicate and classify warnings in this manual. Always heed the information provided with them.

DANGER! Indicates information that, if not heeded, could result in loss of life or serious injury.

Caution Indicates information that, if not heeded, could result in minor injury or damage to the product.

OMRON Product References

All OMRON products are capitalized in this manual. The word "Unit" is also capitalized when it refers to an OMRON product, regardless of whether or not it appears in the proper name of the product.

The abbreviation "Ch," which appears in some displays and on some OMRON products, often means "word" and is abbreviated "Wd" in documentation in this sense.

The abbreviation "PC" means Programmable Controller and is not used as an abbreviation for anything else.

IBM and IBM PC/AT are registered trademarks of International Business Machines Corporation.

MS-DOS is a registered trademark of Microsoft Corporation.

Visual Aids

The following headings appear in the left column of the manual to help you locate different types of information.

Note Indicates information of particular interest for efficient and convenient operation of the product.

1, 2, 3... Indicates lists of one sort or another, such as procedures, precautions, etc.

© OMRON, 1991

All rights reserved. No part of this publication may be reproduced, stored in a retrieval system, or transmitted, in any form, or by any means, mechanical, electronic, photocopying, recording, or otherwise, without the prior written permission of OMRON.

No patent liability is assumed with respect to the use of the information contained herein. Moreover, because OMRON is constantly striving to improve its high-quality products, the information contained in this manual is subject to change without notice. Every precaution has been taken in the preparation of this manual. Nevertheless, OMRON assumes no responsibility for errors or omissions. Neither is any liability assumed for damages resulting from the use of the information contained in this publication.

TABLE OF CONTENTS

SECTION 1

Introduction	1
1-1 Terminology and NT-series Manuals	2
1-2 System ROM and Screen Data Memory Board EEPROM	2
1-3 Nomenclature and Functions	3
1-4 Installing and Removing Units	4

SECTION 2

SYSMAC WAY Interface	5
2-1 Introduction	6
2-2 Specifications and Switch Settings	7
2-3 Connection to the CPU/Host Link Unit	10
2-4 DM Word Allocation and Data Transfer	15
2-5 PC-to-PT Commands	20
2-6 PT-to-PC Commands	27
2-7 System Startup	31
2-8 Communications Errors	32

SECTION 3

SYSMAC BUS Interface	35
3-1 Features and System Configuration	36
3-2 Specifications and Switch Settings	37
3-3 Connection to the PC	39
3-4 Data Transmission and I/O Word Allocation	41
3-5 PC-to-PT Commands	45
3-6 PT-to-PC Commands	52
3-7 System Startup	57
3-8 Transfer Time	60
3-9 Communications Errors	62

SECTION 4

C200H Interface Unit	67
4-1 Features and System Configuration	68
4-2 Specifications and Switch Settings	69
4-3 DM Word Allocation	76
4-4 PC-to-PT Commands	80
4-5 PT-to-PC Commands	87
4-6 Communications Check	93
4-7 Communications Errors	94
4-8 Connection to Mini H-type PCs	96

Appendix

A Special Characters	101
----------------------------	-----

Index	103
--------------------	------------

Revision History	105
-------------------------------	------------

About this Manual:

This manual describes the installation and operation of the Host Interface Units for the NT20M and NT600M Programmable Terminals (PTs). The following Host Interface Unit models are included.

NT20M/NT600M Series

NT600M-LK201	SYSMAC WAY Host Interface Unit
NT600M-RT121	Wired SYSMAC BUS Host Interface Unit
NT600M-LB121	C200H Interface Unit

This manual contains the following sections. Please read this manual completely and be sure you understand the information provide before attempting to install and operation a Host Interface Unit

Section 1 provides basic terminology and reference manual lists along with basic installation procedures. Details on installation, such as system configurations are provided in later sections because these depend on the interface being used.

Section 2 provides information for Host Interface Units used with an RS-232C interface to a Host Link Unit mounted to a PC in a SYSMAC WAY Host Link System.

Section 3 provides information for Host Interface Units used with an RS-485 interface to a Remote I/O Master Unit mounted to a PC in a SYSMAC BUS Wired Remote I/O System.

Section 4 provides the hardware and commands for the NT20M-LB121-V2 and NT600M-LB121 C200H Interface Units. Except where a distinction needs to be made, both of these Units will be referred to simply as the (C200H) Interface Units.

The **Appendix** provides a list of special character codes.

SECTION 1

Introduction

This section covers nomenclature and features of all the Host Interface Units and provides methods for installing them in the Programmable Terminals. Basic terminology and NT-series manuals are also introduced.

1-1	Terminology and NT-series Manuals	2
1-2	System ROM and Screen Data Memory Board EEPROM	2
1-2-1	System ROM and Compatible PTs	2
1-3	Nomenclature and Functions	3
1-4	Installing and Removing Units	4
1-4-1	Installation	4
1-4-2	Removal	4

1-1 Terminology and NT-series Manuals

Names of items in this manual related to the NT Series of Programmable Terminal and SYSMAC C-series Programmable Controllers are defined next.

Abbreviations

The following abbreviations are used in the text.

Abbreviation	Term	Meaning
PT	Programmable Terminal	Refers to an OMRON NT-series Programmable Terminal.
PC	Programmable Controller	Refers to an OMRON SYSMAC C-series or CV-series Programmable Controller, or programmable controllers manufactured by other companies.
I/F	Interface	A communications device that connects the Programmable Terminal with peripheral devices.
I/O	Input/Output	Refers to PT and PC inputs and outputs.

SYSMAC Terminology

Terminology	Explanation
SYSMAC	A generic name for OMRON's Programmable Controllers.
Host Link System (SYSMAC WAY)	A system employing SYSMAC C-series Host Link Units used to create a communications bus between PCs, between PCs and PTs, etc.
SYSMAC BUS	A remote I/O network created between SYSMAC C-series PCs and input/output devices.

Reference Manuals

The NT20M/NT2000M Series and NT600M Series are covered in the six manuals described below. Actual manual numbers also include suffixes indicating the version of the manual.

Name of Manual	Contents	Manual No.
NT20M/NT2000M Operation Manual	This manual provides specifications, functions, and operating instructions for the NT20M and NT2000M Programmable Terminals.	V001
NT600M Operation Manual	This manual provides specifications, functions, and operating instructions for NT600M Programmable Terminals.	V002
NT-series Host Interface Unit Operation Manual	This manual covers the commands, controls, and communications specifications for operating the NT20M and the NT600M. Refer to this manual when programming host computer communications.	V003
NT20M/NT600M Support Tool Operation Manual	This manual covers methods for creating screens, including screen data preparation, switches, lights, and alarms.	V004
NT-series Host Interface Unit Direct Connection Operation Manual	This manual covers the Direct Connection feature which has been added to the Host Interface Unit.	V015
NT-series RS-232C/RS-422 Interface Unit Operation Manual	This manual covers the commands, controls, and communications specifications for operating the NT20M and the NT600M with the RS-232C/RS-422 Interface Unit. Refer to this manual when programming host computer communications.	V016

1-2 System ROM and Screen Data Memory Board EEPROM

1-2-1 System ROM and Compatible PTs

Depending on the PT model, System ROM (sold separately) might be required when using a Interface Unit to communicate with a PC or personal computer.

The various programs used by the Interface Unit to control the PT are written in the System ROM.

The following table shows the required System ROM for various PT/Interface Unit combinations. The PT will not operate properly if combinations other than the ones shown below are used.

NT20M PTs

System ROM is required with the NT20M-DT121-V2/DN121-V2 and NT20M-DT131/DN131 PTs.

PTs	Compatible Interface Units	Required System ROM
NT20M-DT121-V2 NT20M-DN121-V2 NT20M-DT131 NT20M-DN131	SYSMAC WAY (NT600M-LK201) SYSMAC BUS (NT600M-RT121)	NT20M-SMR01-E
	C200H (NT600M-LB121)	NT20M-SMR02-E

NT600M PTs

System ROM is required with all NT600M PTs.

PTs	Compatible Interface Units	Required System ROM
NT600M-DT122/211 NT600M-DF122 NT600M-DN211	SYSMAC WAY (NT600M-LK201) SYSMAC BUS (NT600M-RT121)	NT600M-SMR01-EV1
	C200H (NT600M-LB121)	NT600M-SMR02-EV1

EEPROM

When EEPROM is installed in the Screen Data Memory Board and a backup battery is not being used, the following settings will be initialized to their default settings if the PT is reset or restarted.

Setting	Default value
Key Press Sound	ON
Backlight OFF ¹	10 min
Display ²	Normal

- Note**
1. This is the Backlight OFF function in the NT600M-DT211/DF211.
 2. The Display setting is available in the NT600M only.

1-3 Nomenclature and Functions

Host Interface Units components are illustrated and described below.

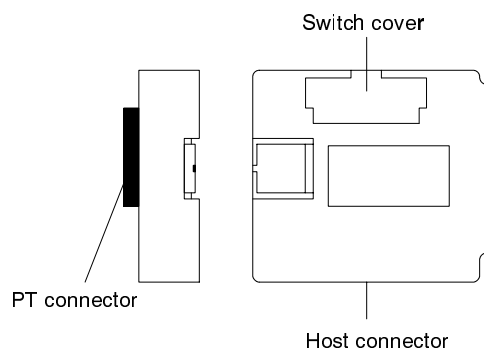

Component	Functions
PT connector	The PT connector is for connecting to an NT-series PT.
Switch cover	The DIP switch is located under this cover. If it is difficult to open the cover by hand, use a standard screwdriver. Set the DIP switch before mounting the Unit to a PT. Refer to the sections on specifications and switch settings for each Host Interface Unit later in this manual for actual settings.
Host connector	The host connector is for connecting to the host. The shapes of host connectors vary from Unit to Unit.

1-4 Installing and Removing Units

1-4-1 Installation

Installing NT20M Units

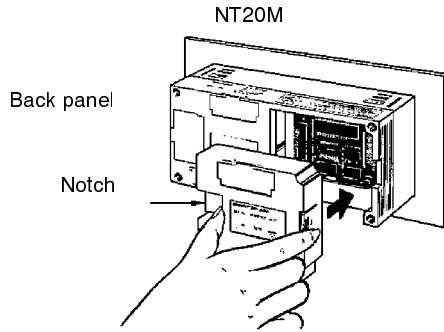

Installing NT600M Units

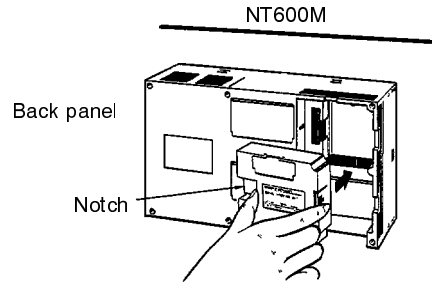

Hold the Unit with the notch on the left side, as shown in the illustration, and snap it into place. If the Unit's connector does not line up properly with the connector of the PT, then slightly shift the position of the Host Interface Unit as you insert it.

1-4-2 Removal

Removing NT20M Units

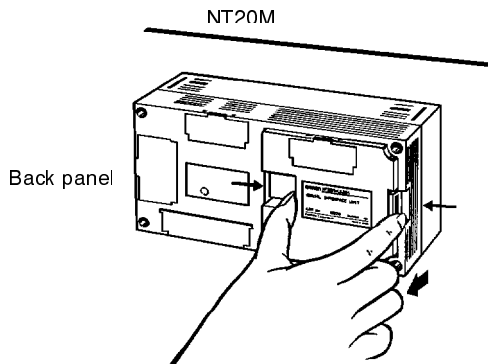

Removing NT600M Units

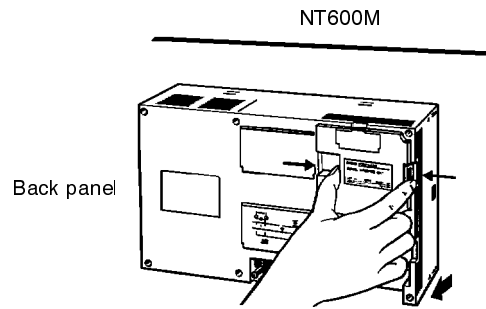

As shown in the illustrations above, grasp the Unit by the slots on both sides and squeeze them toward the center while pulling the Unit out.

- Note**
1. If you place the Unit on a desk or other surface, place it with the printed circuit board side up.
 2. Do not touch the printed circuit board surface.
 3. Do not put the Unit where it may be exposed to dust, chemicals, or water spray.
 4. Do not subject the Unit to strong shocks, by dropping it for example.
 5. Never disassemble or attempt to alter the Unit.

SECTION 2

SYSMAC WAY Interface

This section covers hardware and commands for the NT20M-LK203-V2 and NT600M-LK201 SYSMAC WAY Interface Units. With a SYSMAC WAY interface, one-to-one connections can be made between a Programmable Controller (PC) and Programmable Terminal (PT).

2-1	Introduction	6
2-1-1	SYSMAC WAY Interface Unit Features	6
2-1-2	System ROM and Compatible PTs	6
2-1-3	Compatible Host Link Units and CPUs	6
2-2	Specifications and Switch Settings	7
2-2-1	PT Switch Settings	7
2-2-2	Communications Specifications	8
2-2-3	Components	8
2-2-4	Communications Settings	9
2-3	Connection to the CPU/Host Link Unit	10
2-3-1	System Configuration	10
2-3-2	Connector Pin Arrangement	12
2-3-3	Connections	12
2-3-4	Host Link Unit Settings	13
2-3-5	Checking Settings	14
2-4	DM Word Allocation and Data Transfer	15
2-4-1	DM Word Allocation	15
2-4-2	Operational Flow and Strobe	20
2-5	PC-to-PT Commands	20
2-5-1	Designated Screen Display	21
2-5-2	Numeral Table Settings	22
2-5-3	String Table Settings	23
2-5-4	Writing Character String	23
2-5-5	Lamp and Touch Switch Display Control	24
2-5-6	Screen Number Request	25
2-5-7	Copy Memory Table Entry	26
2-5-8	System Status Control	26
2-6	PT-to-PC Commands	27
2-6-1	PT Status Flags	28
2-6-2	Touch Switch Input	28
2-6-3	Function Key Input	29
2-6-4	Numeral Table Editing	30
2-6-5	Response to Screen Number Request	31
2-7	System Startup	31
2-7-1	Preliminary Procedures	31
2-7-2	Checking the Settings	32
2-8	Communications Errors	32
2-8-1	Communications Errors	32
2-8-2	Processing Communications Errors	33
2-8-3	Troubleshooting	34

2-1 Introduction

2-1-1 SYSMAC WAY Interface Unit Features

SYSMAC WAY Interface Units (NT20M-LK203-V2 and NT600M-LK201) are used to make one-to-one connections between a Programmable Controller (PC) and Programmable Terminal (PT). With CV-series PCs and Mini H-type PCs, the connection is made directly to the CPU; with other C-series PCs, the connection is made to a Host Link Unit mounted to the PC.

The SYSMAC WAY Interface Unit periodically reads data from the PC's DM Area and writes this data to the PT, so PT operation can be controlled just by writing data to the PC's DM Area. A communications program is not required.

2-1-2 System ROM and Compatible PTs

System ROM (sold separately) is required when using a SYSMAC WAY Interface Unit. The following table shows the required System ROM as well as the PTs that are compatible with the NT20M-LK203-V2 and NT600M-LK201.

SYSMAC WAY Interface Unit	Compatible PTs	Required System ROM
NT600M-LK201	NT20M-DT121-V2/ DN121-V2, NT20M-DT131, NT20M-DN131	NT20M-SMR01-E, NT2000M-DT131/DN131
	NT600M-DT122/211, NT600M-DF122, NT600M-DN122/211	NT600M-SMR01-V1

Note The communications specifications of the NT2000M are the same as those of the NT20M. Any description on the NT20M hereinafter also applies to the NT2000M.

2-1-3 Compatible Host Link Units and CPUs

Host Link Units

The following Host Link Units are compatible with the NT20M-LK203-V2 and NT600M-LK201 SYSMAC WAY Interface Units.

Transmission Medium	Host Link Units
Optical Fiber Cable ¹	C200H-LK101-P, C500-LK103-P
Multiconductor Wire Cable ²	C200H-LK201/202, C500-LK103/203

Note 1. Optical Modules, Optical Fiber Cable, and an AC Adapter (all sold separately) are required when using Optical Fiber Cable.
2. A Link Adapter (sold separately) is required when connecting to a Host Link Unit's RS-422 connector because the PT's connector is RS-232C.

CPUs

The RS-232C connector on the following CPUs can be connected directly to the RS-232C connector on the NT600M-LK201 SYSMAC WAY Interface Unit to form a Host Link System connection.

PC Series	Compatible CPUs
CV-series	CV500-CPU01, CV1000-CPU01
C-series	Mini H-type PCs (C20H, C28H, C40H, and C60H)

Note Refer to 2-3 *Connection to the CPU/Host Link Unit* for more details on Connecting Cables.

2-2 Specifications and Switch Settings

The SYSMAC WAY Interface Units communicate with the PC through the PC's DM Area. The following table shows the Read/Write memory available in the DM Area of CV and C-series PCs.

PC	Read/Write DM Area
C20H/C28H/ C40H/C60H	DM 0000 to DM 0999 (DM 0900 to DM 0999 are used for System DM)
C120/C500	DM 000 to DM 511
C200H	DM 0000 to DM 0999 (DM 0969 to DM 0999 are used for System DM in the CPU11)
C1000H	DM 0000 to DM 4095
C2000H	DM 0000 to DM 6655
CV500	D00000 to D08191
CV1000	D00000 to D09999

Refer to the PC's Operation Manual when setting the number of memory table entries and beginning DM word.

2-2-1 PT Switch Settings

Pin 8 of SW1 on the Programmable Terminal is used to set the host interface for either a normal RS-232C interface or a Host Link System (SYSMAC WAY) interface. This section covers only the SYSMAC WAY interface.

Be sure to set pins 3 and 8 to ON, since it is set to OFF at the factory. Always turn the power off before changing these switch settings. Refer to your PT's *Operation Manual* for details.

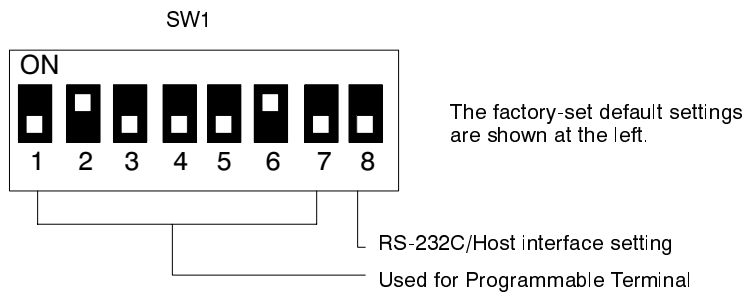

Switch no.	Setting	Content
SW1, pins 1 to 7	Used for Programmable Terminal	These pins are used by the PT. Refer to your PT's <i>Operation Manual</i> .
SW1, pin 8	ON: SYSMAC WAY OFF: RS-232C	This setting determines the communications protocol of the Host Interface Unit. Always set to ON when using a SYSMAC WAY Interface Unit.

2-2-2 Communications Specifications

Item	Specifications
Communication standards	EIA RS-232C
Communications settings	Start-stop synchronization Baud rate: 300, 600, 1200, 2400, 4800, 9600, 19200 bps Data length: 7 bits Stop bits: 2 bits Parity: Even
Connector	25-pin D-sub connector (female)
Number of connections	1:1
Transmission distance	15 m max. (500 m max. when using Optical Fiber Cable)
Communications protocol	SYSMAC C-series SYSMAC WAY Host Link System (1:N) protocol

2-2-3 Components

The following diagram shows the major components of the SYSMAC WAY Interface Unit that are used during operation.

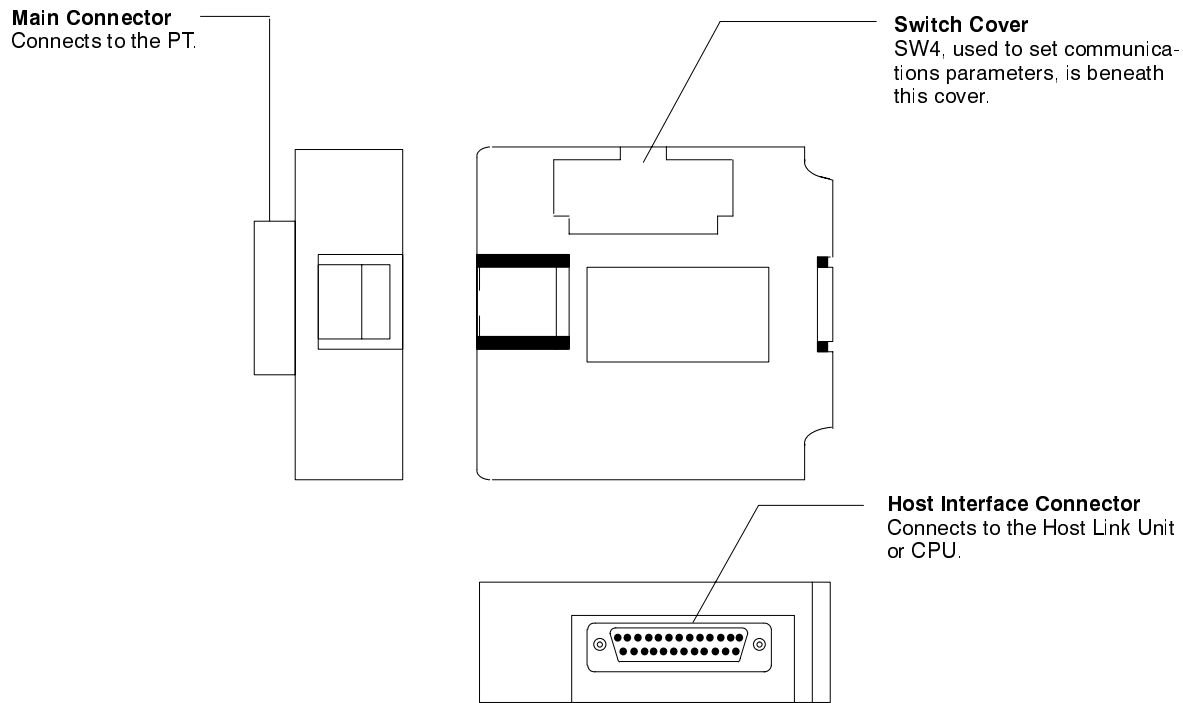

2-2-4 Communications Settings

Communications parameters are set with SW4. Refer to *1-3 Nomenclature and Functions* for a diagram showing the location of SW4.

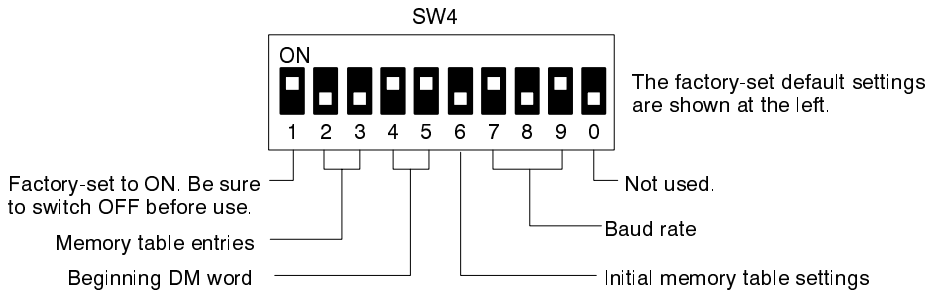

Memory Table Entries

Pins 2 and 3 determine the number of entries in the DM Area for the numeral table and character string table. The beginning DM word “n” is set with pins 4 and 5, as described in the next section.

Up to 250 numeral tables and 250 string tables can be used on the NT600M. Up to 128 entries can be allocated for the string table and 128 entries can be allocated for the numeral table in the NT600M, and up to 128 entries can be allocated for the string table and 32 entries can be allocated for the numeral table in the NT20M, as shown in the following table.

Pin		Numeral table		String table			
2	3	Number of entries	DM words used	Number of entries		DM words used	
				NT600M	NT20M	NT600M	NT20M
OFF	OFF	32	n+16 to n+79	8	8	n+272 to n+431	n+272 to n+399
ON	OFF	64	n+16 to n+143	32	16	n+272 to n+911	n+272 to n+527
OFF	ON	128	n+16 to n+271	128	32	n+272 to n+2831	n+272 to n+783
ON	ON	Not used	---	Not used		---	

- Note**
1. The number of entries cannot be set to zero. The minimum settings are 32 for the numeral table and 8 for the string table.
 2. In some PCs, the number of entries is limited by the size of the DM Area. Refer to the PC’s Operation Manual for details on the DM Area.

Beginning DM Word

Pins 4 and 5 determine the beginning DM word for the numeral and character string tables.

Pin 4	Pin 5	Beginning word
OFF	OFF	DM 0000
ON	OFF	DM 0256
OFF	ON	DM 1024
ON	ON	DM 2048

Initial Memory Table Settings

Pin 6 determines the source used for the initial memory table settings when system is started or switched to RUN mode. If pin 6 is ON, the initial values set with a Support Tool are used. If pin 6 is OFF, the values in the PC’s DM Area are used.

For example, pin 6 would be turned OFF (DM Area value) when displaying the product number on the PT’s screen, so the previous product number would be displayed. Pin 6 would be turned ON (value set with Support Tool) to display the initial value.

Transmission Rate

Pins 7, 8, and 9 determine the transmission rate. This setting should agree with the transmission rate set in the PC or Host Link Unit.

Pin 7	Pin 8	Pin 9	Baud rate
OFF	OFF	OFF	300 bps
OFF	OFF	ON	600 bps
OFF	ON	OFF	1,200 bps
OFF	ON	ON	2,400 bps
ON	OFF	OFF	4,800 bps
ON	OFF	ON	9,600 bps
ON	ON	OFF	19,200 bps

2-3 Connection to the CPU/Host Link Unit

2-3-1 System Configuration

RS-232C Cable Connection The C120, C200H, C500, C1000H, and C2000H PCs are connected to the PT through a Host Link Unit, as shown below.

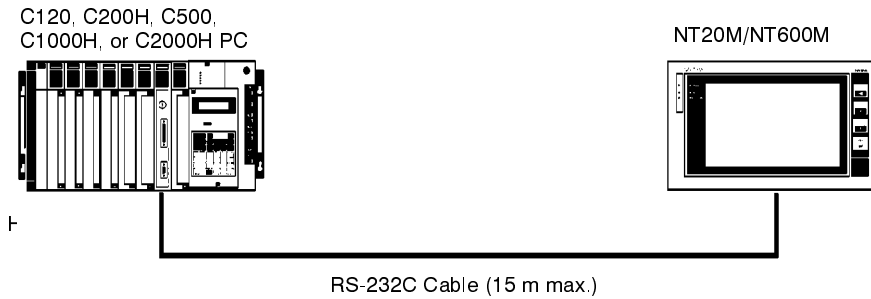

The Mini H-type and CV-series PCs can be connected to the PT directly.

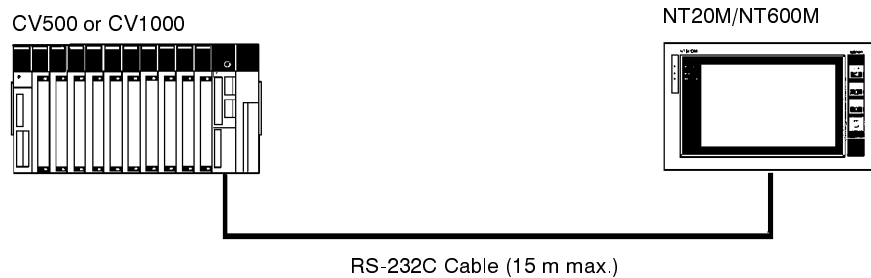
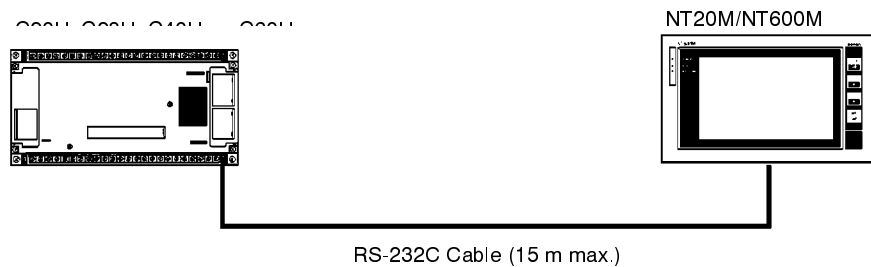

Optical Fiber Cable Connection

An Optical Fiber Cable connection can be used when the PC and PT are more than 15 m apart or local conditions are unfavorable for RS-232C connections.

The following table shows the appropriate Optical Module, Optical Fiber Cable, and AC Adapter to use in Optical Fiber Cable connections.

Unit	Model Number	Comments
Optical Module	Z3RN-A	25-pin type OMRON product or equivalent. Two modules are required.
Optical Fiber Cable	Z3F2-4D□M (□= 1 to 500 m)	OMRON product
AC Adapter	Z3GP-01	100 VAC OMRON product. Two are required.

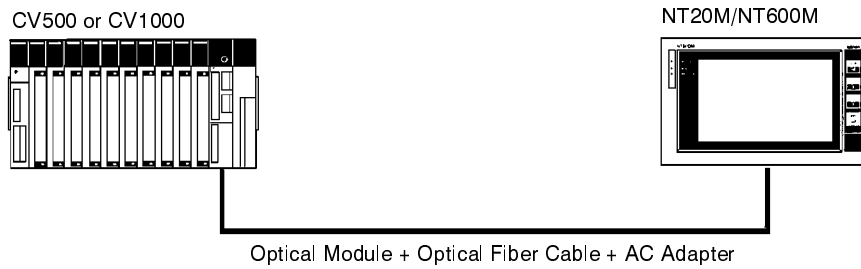
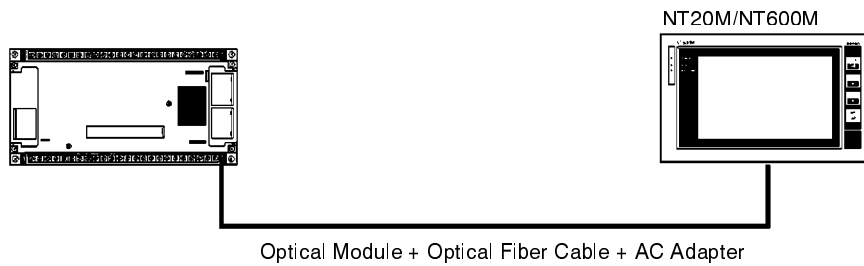
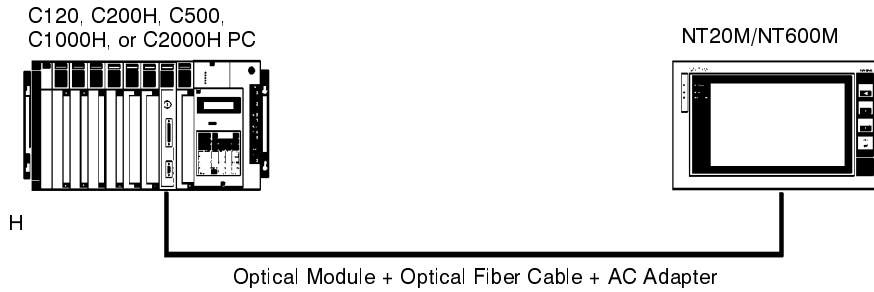

2-3-2 Connector Pin Arrangement

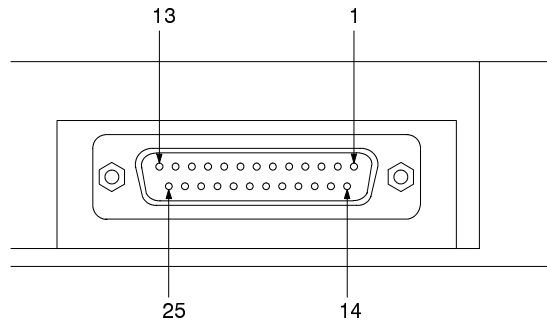

Pin no.	Symbol	Name
1	FG	Frame Ground (not used)
2	SD	Send Data
3	RD	Receive Data
4	RS	Request to Send
5	CS	Clear to Send
7	SG	Signal Ground
14	+5 VDC	For Optical Connector use

- Note**
1. FG is not connected inside of the PT.
 2. Pin numbers not listed above are not used.

2-3-3 Connections

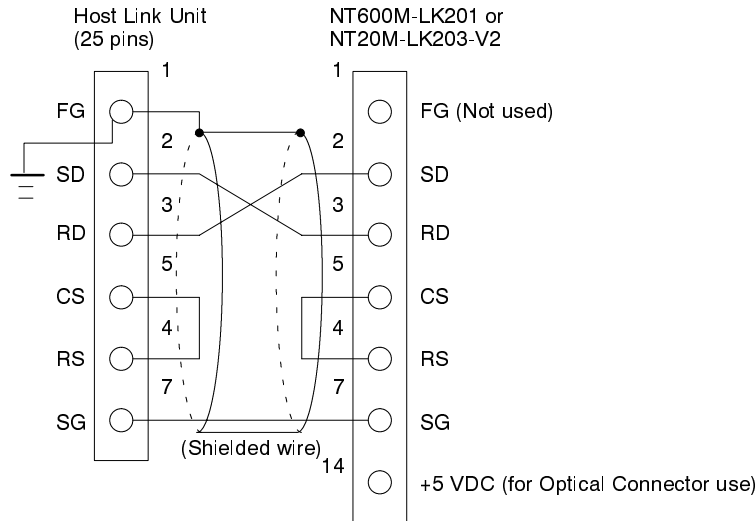

- Note**
1. Do not attach or remove connectors while the power is on. Always make sure first that the power is off.
 2. Short-circuit RS and CS.
 3. The pin numbers and names might vary depending on the Unit being connected. Be sure to check the Unit's *Operation Manual* before wiring the connector.
 4. In CV-series Units, the SG is pin 9.

Applicable Cable Connectors Plug: XM2A-2501 (OMRON)
 Hood: XM2S-2511 (OMRON)

One plug and one hood are included with the Unit. Wire the connector in accordance with the description in the Unit's *Operation Manual*.

Recommended Cable

Cable only:
 AWG28 x 5P IFVV-SB (Fujikura, Ltd.)
 CO-MA-VV-SB 5P x 28AWG (Hitachi Cable, Ltd.)

Cable with attached connectors (2 m length only):
 XZ7-10048 (for the C120, C200H, or C500)
 XZ7-10049 (for Mini H-type PCs, CV500, or CV1000)

The following diagram shows the pin allocation for XZ7-10049 Cable:

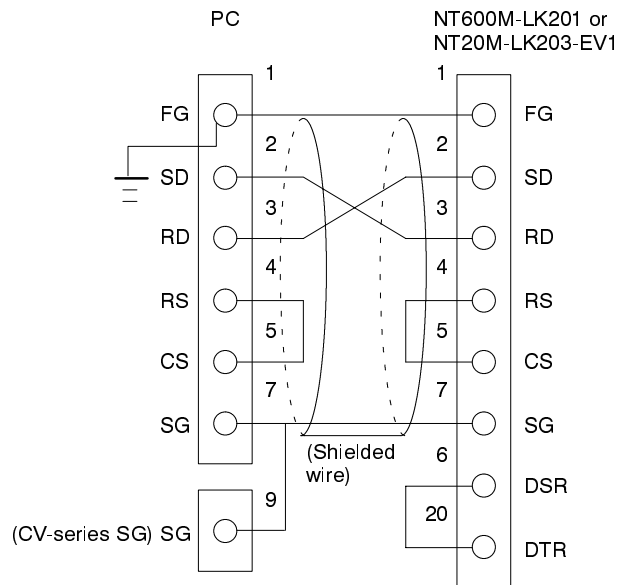

- Note**
1. Do not attach or remove connectors while the power is on. Always make sure first that the power is off.
 2. Short-circuit between RS and CS.

2-3-4 Host Link Unit Settings

Make the following settings for Host Link Units mounted to a PC.

Item	Switch setting
I/O port	RS-232C
Baud rate	Same as for PT.
Transmission code	ASCII 7 bits, 2 stop bits
Parity	Even
1:1/1:N	1:N (see note)
Command level	Level 1
Unit no.	00

Note The 1:N settings enable BCC (Block Check Character). The Host Link Unit and PT cannot be connected with 1:N.

2-3-5 Checking Settings

You can check PT settings by using the PT's System Menu. For details, refer to the NT600M or NT20M *Operation Manual*.

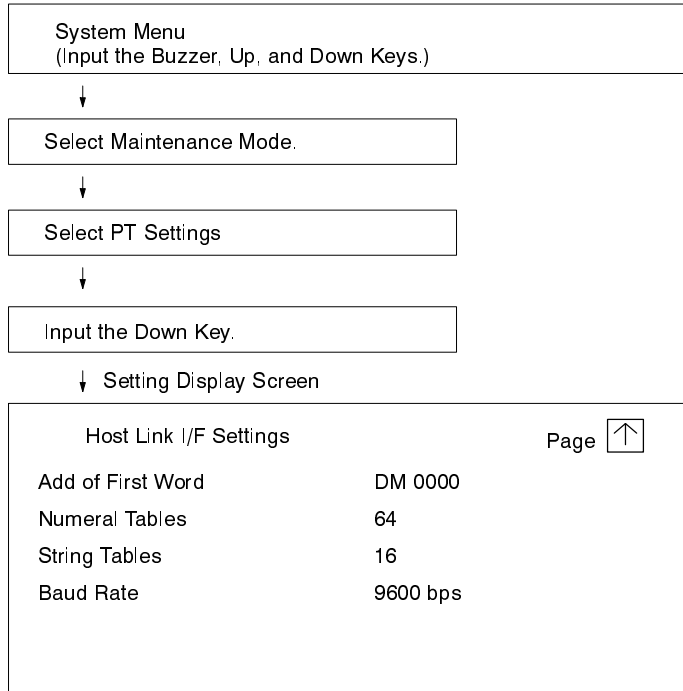

Note To return to RUN Mode, press the Buzzer, Up, and Down Keys.

2-4 DM Word Allocation and Data Transfer

The SYSMAC WAY Interface Unit issues commands and transfers data through the PC's DM Area. This section describes the allocation of the DM Area and the various commands used by the SYSMAC WAY Interface Unit.

2-4-1 DM Word Allocation

Pins 4 and 5 of SW4 specify "n", the beginning word of the DM Area used by the Unit. Refer to *2-2-4 Communications Settings* for details on setting SW4.

Function	DM Word(s)	Bits	Usage
PC-to-PT Communications	n	00 to 11	Output data
		12 to 15	Command Code
	n+1	00 to 15	Output data
	n+2	00 to 15	Output data
	n+3	00 to 15	Output data
	n+4	00 to 15	Lamp/switch 00 to 15
	n+5	00 to 15	Lamp/switch 16 to 31
	n+6	00 to 15	Lamp/switch 32 to 47
PT-to-PC Communications	n+8	00 to 07	Input data
		08 to 11	Command Code
		12 to 15	PT status
	n+9	00 to 15	Input data
	n+10	00 to 15	Input data
	n+11	00 to 15	Input data
	n+12	00 to 11	Switch/function keys 00 to 11
		11 to 15	Switch/function keys 12 to 15
	n+13	00 to 15	Switch/function keys 16 to 31
	n+14	00 to 15	Switch 32 to 47
	n+15	00 to 15	Switch 48 to 63
Numeral Table	n+16 and n+17	00 to 15	No. 0 numeral table entry
	n+18 and n+19	00 to 15	No. 1 numeral table entry
	⋮	⋮	⋮
	n+270 and n+271	00 to 15	No. 127 numeral table entry

DM word allocation for the string table differs in the NT20M and NT600M.

Function	Word(s)	Bits	Usage
String Table (NT20M)	n+272 to n+287	00 to 15	No. 0 string table entry
	n+288 to n+303	00 to 15	No. 1 string table entry
	⋮	⋮	⋮
	n+768 to n+783	00 to 15	No. 31 string table entry

Function	Word(s)	Bits	Usage
String Table (NT600M)	n+272 to n+291	00 to 15	No. 0 string table entry
	n+292 to n+311	00 to 15	No. 1 string table entry
	⋮	⋮	⋮
	n+2812 to n+2831	00 to 15	No. 127 string table entry

PC-to-PT Communications

Communications from the PC to the PT are divided into communications commands to the PT and display controls for lamps and touch switches.

Communications Commands

Communications commands consist of a command code and output data contained in words n through n+3.

The command code is a one-digit hexadecimal value (0 to F) using bits 12 to 15 of word n used to control PT operations (such as screen display, writing numeral and string tables). Each operation is explained in detail later. The output data provides various BCD data required by each operation.

The data used to specify the numbers of the numeral memory table and string memory table to which the data and screen number to be displayed are written.

The data is set in BCD with bits 0 to 11 of word n and bits 0 to 15 of words n+1 to n+3.

Refer to the following table to set the communications command used to set the number of the screen specified.

Word	Bits	Function
n	0 to 11	The number of the screen to be displayed is set.
	12 to 15	Command code is set.

Lamp and Touch Switch Display Control

Display control bits in words n+4 through n+7 are used to control the display of lamps and touch switches 00 to 63. When one of these bits is ON, the lamp/touch switch indicated by the number allocated to the bit is lit; when the bit is OFF, the lamp/touch switch is not lit.

The bits in words n+4 through n+7 can be used to control lamp and touch switches 00 through 63 only. A command (command code 7 or 8) must be used to control lamp and touch switches 64 through 255. Refer to 2-5-5 *Lamp and Touch Switch Display Control* for details.

PT-to-PC Communications

Communications from the PT to the PC are divided into communications commands from the PT and input information from touch switches and function keys.

Communications Commands

Communications commands consist of PT status, a command code, and input data contained in n+8 through n+11.

The PT status flags (bits 12 to 15 of word n+8) provide information on the operating status of the PT, as shown in the following table.

Bit	Name	Function
12	Strobe	Sets the timing for data transmissions from the PT to the PC. For details, see 2-4-2 <i>Operational Flow and Strobe</i> .
13	BAT LOW	ON when the PT's battery voltage drops.
14	BUSY	ON when data cannot be output from the PC to the PT.
15	PT RUN	ON when the PT is in RUN mode.

The command code is a one-digit hexadecimal value (0 to F) in bits 8 to 11 of n+8. The command code indicates the type of information to be transmitted from the PT, such as switch/function key and numeral inputs at the PT. Each command is explained in detail later. The input data words receive the various data requested by each command.

Switch and Key Inputs

Touch switch and function key inputs can be detected from the PC through bit status in words n+12 through n+15. Touch switch numbers range from 00 to 63, and function switch numbers from 00 to 31. If a bit is ON, the corresponding switch or key was turned ON. Inputs are valid only when bit input attributes have been set in advance with the Support Tool. Refer to the Support Tool's Operation Manual for more details on setting input attributes.

Refer to 2-6-2 *Touch Switch Input* and 2-6-3 *Function Key Input* for details on the allocation of words n+12 to n+15 to switch and key numbers.

Note The PT's strobe signal will not be turned ON when the status of bits in n+12 through n+15 is changed.

Memory Table Area

The memory table area is the area containing the PT's memory tables (numeral table and string table). The number of numeral table and string table entries is set with pins 2 and 3 of SW4.

Numeral Table

DM words are automatically allocated to the numeral table entries beginning at n+16. Each table entry (8 digits of BCD) is stored in two DM words.

In the NT20M, up to 128 memory table entries can be used. Up to 128 entries can be allocated in the PC's DM Area.

In the NT600M, up to 256 memory table entries can be used. Up to 128 entries can be allocated in the PC's DM Area.

Table Entry	Table Entry Digits	DM Word
No. 0	Leftmost 4 digits	n+16
	Rightmost 4 digits	n+17
No. 1	Leftmost 4 digits	n+18
	Rightmost 4 digits	n+19
⋮	⋮	⋮
No. 127	Leftmost 4 digits	n+270
	Rightmost 4 digits	n+271

Note If fewer than 128 entries are specified with pins 2 and 3 of SW4, the DM words from the end of the numeral table to n+271 can be used as normal DM.

String Table

DM words are automatically allocated to the string table entries beginning at n+272. Each string table entry is stored in 16 DM words for the NT20M, or 20 DM words for the NT600M.

In the NT20M, up to 32 memory table entries can be used. Up to 32 entries can be allocated in the PC's DM Area. Each string table entry is allocated 16 DM words.

NT20M Table Entry	DM Words
No. 0	n+272 to n+287
No. 1	n+288 to n+303
⋮	⋮
No. 31	n+768 to n+783

The 16 words allocated to each table entry can contain 32 normal characters. The following table shows the distribution of 32 normal characters in table entry No. 0. Other table entries follow the same pattern.

DM Word	Bits	Character
n+272	00 to 07	(2)
	08 to 15	(1)
n+273	00 to 07	(4)
	08 to 15	(3)
⋮	⋮	⋮
n+287	00 to 07	(32)
	08 to 15	(31)

In the NT600M, up to 256 memory table entries can be used. Up to 128 entries can be allocated in the PC's DM Area. Each string table entry is allocated 20 DM words.

NT600M Table Entry	DM Words
No. 0	n+272 to n+291
No. 1	n+292 to n+311
⋮	⋮
No. 127	n+2812 to n+2831

The 20 words allocated to each table entry can contain 40 normal characters. The following table shows the distribution of 40 normal characters in table entry No. 0. Other table entries follow the same pattern.

The start word number of the string table is fixed at n+272. If the number of numeral tables set is less than 128, the numeral tables are allocated from word n+272, in which case, the next word number of the last numeral table to word n+271 are not used (i.e., the words are not used by the PT but can be used as a normal DM area).

Character data is set in the string tables as follows:

In this example, normally spaced characters are set at string table 0 and string table nos. 1 to 40 express the setting order of the character data.

DM Word	Bits	Character
n+272	00 to 07	(2)
	08 to 15	(1)
n+273	00 to 07	(4)
	08 to 15	(3)
⋮	⋮	⋮
n+291	00 to 07	(40)
	08 to 15	(39)

Communication Commands and DM Word Allocation

The SYSMAC WAY Interface Unit periodically reads the DM words specified by the SW4 settings and writes that data to PT memory. The following data is read from DM and sent to the PT.

- Lamp and touch switch display control (no. 00 to 63)
- Touch and function key data (for bit-input screen display key inputs)
- Numeral table entries (the range set on pins 2 and 3 of SW4)
- String table entries (the range set on pins 2 and 3 of SW4)

The contents of the DM Area cannot be changed using communication commands. Change the contents of the DM Area from the PC's program or write data directly to DM.

2-4-2 Operational Flow and Strobe

Operational Flow

Initial processing is executed internally in the PT when the power is turned on. If there are no errors, Read and Write DM, screen display refreshing, and so on, are repeated in cyclic fashion.

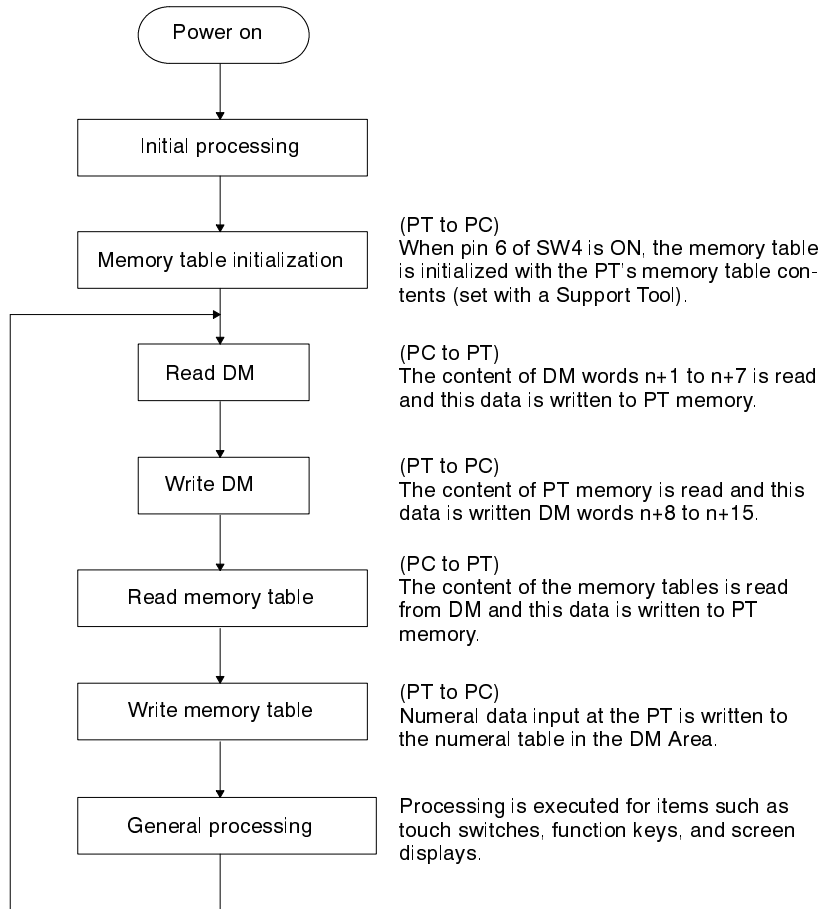

Note The “Read memory table” process is executed only when numeral table entries or string table entries are being used for the screen currently being displayed.

Strobe

The strobe signal (bit 12 of DM word n+8) is used to synchronize the transmission of data from the PT to the PC.

The ON/OFF status of the strobe is refreshed during the “Write DM” process shown in the operational flowchart above. The following diagram shows the strobe/transmission timing when data is transmitted from the PT to the PC two consecutive times. Have the PC take in data on the rising edge of the strobe signal.

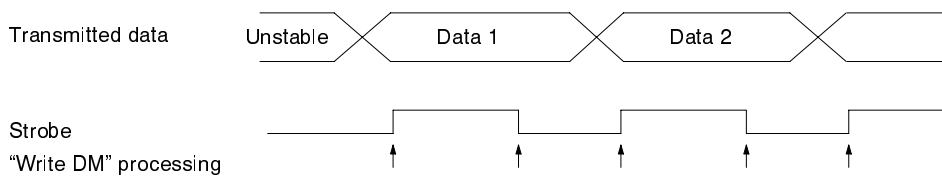

2-5 PC-to-PT Commands

In the following descriptions of commands, “n” is the beginning DM word set on pins 4 and 5 of SW4. The status of words n through n+7 can be manipu-

lated in the PC to control various aspects of PT operation or to access various data from the PT. Refer to the following table for details on the function of bits in DM words n through n+7.

DM Word(s)	Bits	Usage
n	00 to 11	Output data
	12 to 15	Command Code
n+1	00 to 15	Output data
n+2	00 to 15	Output data
n+3	00 to 15	Output data
n+4	00 to 15	Lamp/switch 00 to 15
n+5	00 to 15	Lamp/switch 16 to 31
n+6	00 to 15	Lamp/switch 32 to 47
n+7	00 to 15	Lamp/switch 48 to 63

Commands are all designated by single-digit hexadecimal numbers (0 to F). All other data is designated in BCD (binary coded decimal).

Command code	Function
0	Designated screen display
1	Designated screen display (NT600M only)
2	Not used.
3	Numeral table setting (positive numbers)
4	Numeral table setting (negative numbers)
5	String table setting (setting string table entry number)
6	String table setting (writing character string data)
7	Lamp/touch switch display control (setting lamp/touch switch number)
8	Lamp/touch switch display control (bit setting)
9	Not used.
A	Screen number request
B	Not used.
C	Copy memory table entry
D	System status control
E and F	Not used.

Note The PT will disregard commands with command codes 2, 9, B, E, or F.

2-5-1 Designated Screen Display

A command code of 0 or 1 is used to display a designated screen. Command code "1" is valid only for the NT600M.

Word	15 to 12	11 to 08	07 to 04	03 to 00	
n	Command code		Screen number (rightmost 3 digits)		
	0 or 1	N	N	N	

NT20M

Command code "0" is used to display a designated screen. The screen number (001 to 250, BCD) is specified in the rightmost 3 digits. A screen number of 000 will clear the PT's display.

Data beyond DM word n is ignored.

NT600M

Command code "0" is used to display a designated screen with a screen number from 000 to 999, BCD. The screen number is specified in the rightmost 3 digits. A screen number of 000 will clear the PT's display.

Command code "1" is used to display screen number 1000. The rightmost 3 digits should be set to 000.

Data beyond DM word n is ignored.

2-5-2 Numeral Table Settings

The numeral table can be set by using a communications command or by writing data directly to the DM words allocated to the numeral table.

Communications Command These commands are used to write 2 words of data to the specified numeral table entry. A command code of 3 is used to write positive numbers and a command code of 4 is used for negative numbers. The PT's display will change if the specified numeral table entry or a flag that depends on that entry is being displayed.

Numeral table entries are specified in 3-digit BCD and can be from 000 to 127 with the NT20M or 000 to 255 with the NT600M. The numeral data is written in 8-digit BCD from 00000000 to 99999999. Write the 4 leftmost digits in n+1 and the 4 rightmost digits in n+2. Data in n+3 is ignored.

The content of DM words allocated to the numeral table will be displayed even if the numeral table is changed with this command.

The same numeral table is used for PT-to-PC transmission. Items allocated specific DM words are given priority even if designated with this command.

Positive Numbers

A command code of 3 is used to write positive numbers to the numeral table by designating the table entry number.

Word	15 to 12	11 to 08	07 to 04	03 to 00
n	Command code	Table entry number		
	3	N	N	N
n + 1	Numeral data (leftmost 4 digits)			
	N	N	N	N
n + 2	Numeral data (rightmost 4 digits)			
	N	N	N	N

Negative Numbers

A command code of 4 is used to write negative numbers to the numeral table by designating the table entry number.

Word	15 to 12	11 to 08	07 to 04	03 to 00
n	Command code	Table entry number		
	4	N	N	N
n + 1	Numeral data (leftmost 4 digits)			
	N	N	N	N
n + 2	Numeral data (rightmost 4 digits)			
	N	N	N	N

Writing Directly to DM

It is not necessary to use the communications commands described above to change the numeral table. Data can be written to the PT's numeral table by

writing directly to the DM words that have been allocated to the numeral table.

The PT's display will change if a numeral table entry or a flag that depends on that entry is being displayed and new data is written to the DM words allocated to that entry.

2-5-3 String Table Settings

There are two ways to change the string table. New data can be written to the table with communications commands (command codes 5 and 6) or the data can be written directly to the DM words allocated to the string table.

Designating the String Table Entry Number

A command code of 5 is used to designate the entry number in the string table that is to be written to using the next string write command (command code 6).

Word	15 to 12	11 to 08	07 to 04	03 to 00
n	Command code	String table entry number		
	5	N	N	N

String table entry numbers are designated in 3 digits of BCD (000 to 031 for the NT20M, and 000 to 255 for the NT600M). The designated number is valid until again designated with a command code 5. When power is first turned on, 0 is set as the default.

Data beyond word n is ignored.

2-5-4 Writing Character String

A command code of 6 is used to write a character string to the string table entry that has been designated under command code 5.

The PT's display will change if a new data is written to a string table entry while the character string is being displayed.

Word	15 to 12	11 to 08	07 to 04	03 to 00
n	Command code	Not used.	Character string position	
	6	x	D	D
n + 1	Character data 1	Character data 2		
	C1	C1	C2	C2
n + 2	Character data 3	Character data 4		
	C3	C3	C4	C4
n + 3	Character data 5	Character data 6		
	C5	C5	C6	C6

Note Data in the area marked by x will be ignored at the PT.

Character positions are designated by 2-digit BCD numbers (01 to 40 for the NT600M, and 01 to 32 for the NT20M). Designate the first character as 1, the next as 2, and so on. Refer to the appendices for character codes.

Character data is given in ASCII (half-size or normal characters).

If 00 is given as character data, data from that point on will be ignored.

The content of DM words allocated to the string table are given priority even if the string table is changed with this command.

Character data will be written to the string table when command code 6 is received by the PT.

Example: Writing “OMRON PC” to String Table Entry 3

Order	Word	Data	Meaning
1	n n + 1 n + 2 n + 3	5003 xxxx xxxx xxxx	Designates string table no. 3. Not used. Not used. Not used.
2	n n + 1 n + 2 n + 3	6x01 4F4D 524F 4E20	Designates 1st position. “OM” “RO” “N ”
3	n n + 1 n + 2 n + 3	6x07 5043 00xx xxxx	Designates 7th position. “PC” Remainder of character string data Ignored.

Writing Directly to DM

It is not necessary to use the communications commands described above to change the string table. Data can be written to the PT’s string table by writing directly to the DM words that have been allocated to the string table.

The PT’s display will change if a new data is written to a string table entry while the character string is being displayed.

2-5-5 Lamp and Touch Switch Display Control

A lamp or touch switch can be controlled (turned on, off, or made to blink) if the Support Tool was used to set it in the screen being displayed. A total of 256 lamps and touch switches (numbers 000 through 255) can be set with a Support Tool. These 256 lamps and touch switches are divided into three groups and each group is controlled differently.

Numbers 00 through 63 are allocated bits in DM words n+4 to n+7. These lamps and touch switches are turned on and off by turning the corresponding bits on and off.

Numbers 64 through 111 are controlled by a communications command (command code 8), and numbers 112 through 255 are controlled by another communications command (command code 7).

Numbers 00 to 63

Lamps and touch switches 00 through 63 are turned on and off by turning on and off the corresponding bits in n+4 through n+7. The following table shows the bit allocation for these lamps and touch switches.

DM Word	Bits	Allocation
n+4	00 to 15	Lamps/switches 00 to 15
n+5	00 to 15	Lamps/switches 16 to 31
n+6	00 to 15	Lamps/switches 32 to 47
n+7	00 to 15	Lamps/switches 48 to 63

If the lamp display attributes are set to ON when the lamps are created, lamps 00 to 63 will be turned on when the corresponding bit is ON; they will blink if the attributes are set to FLASH when they are created.

Numbers 64 to 111

Lamps and touch switches 64 through 111 are controlled by the communications command with command code 8.

The lamps and touch switches are turned on and off by turning on and off the corresponding bits in n+1 through n+3. The following table shows the bit allocation for the lamps and touch switches with numbers 64 through 111.

Word	15 to 12	11 to 08	07 to 04	03 to 00
n	Command code	Not used.		
	8	x	x	x
n + 1	79 to 76	75 to 72	71 to 68	68 to 64
	N	N	N	N
n + 2	95 to 92	91 to 88	87 to 84	83 to 80
	N	N	N	N
n + 3	111 to 108	107 to 104	103 to 100	99 to 96
	N	N	N	N

Note Data in the areas marked by x will be ignored at the PT.

If the lamp display attributes are set to ON when the lamps are created, lamps 64 to 111 will be turned on when the corresponding bit is ON; they will blink if the attributes are set to FLASH when they are created.

Numbers 112 to 255

Lamps and touch switches 112 through 255 can be set to be off, to light, or to blink by the communications command with command code. Lamp and touch switch numbers are designated by 3-digit BCD numbers (N: 112 to 255).

Word	15 to 12	11 to 08	07 to 04	03 to 00
n	Command code	Function code	Not used.	
	7	m	x	x
n + 1	Not used.	Lamp/switch number		
	x	N	N	N

Note Data in the areas marked by x will be ignored at the PT.

The function code “m” determines whether the designated lamp or touch switch will be set to on, off, or blink, as shown in the following table. If m=3, all lamps and touch switches will be turned off. Codes 4 to 9 are ignored.

Function code (m)	Lamp status	Touch switch status
0	OFF	OFF
1	ON	ON
2	Blinking	ON
3*	All OFF	All OFF
4 to 9	No effect	No effect

Note *Lamps and touch switches numbers 00 through 111 should also be turned off by the procedures described above. (Set bits in n+4 through n+7 to 0, and issue command 8 with the bits in n+1 through n+3 set to 0.)

2-5-6 Screen Number Request

This command (command code A) is used to determine which screen number is currently being displayed on the PT. Upon reception this command, the PT transmits the screen number to the host with the “screen number request response” command. Refer to 2-6-5 *Response to Screen Number Request* for details.

There will not be a response from the PT if a system menu (including the maintenance menu) is displayed.

Word	15 to 12	11 to 08	07 to 04	03 to 00
n	Command code	Not used.		
	A	x	x	x

Note Data in the area marked by x will be ignored at the PT. Data beyond n+1 will be ignored.

2-5-7 Copy Memory Table Entry

This command (command code C) is used to copy the contents of a memory table entry (numeral or string) to another entry. The contents of the source table entry remain unchanged.

By setting data and marks to be displayed on the original memory table and copying these data and marks to a memory table which is displayed on the PT's screen, it is possible to change the display of the screen. This is convenient if the same data is to be used on different screens or if screen messages have to be changed frequently.

The numbers of the source and destination memory table entries are specified in 3-digit BCD, as shown in the following table. String table entry numbers can be 000 to 031 for the NT20M or 000 to 255 for the NT600M. Numeral table entry numbers can be 000 to 127 for the NT20M or 000 to 255 for the NT600M.

Word	15 to 12	11 to 08	07 to 04	03 to 00
n	Command code	Source table entry number		
	C	N	N	N
n + 1	Sub-code	Destination table entry number		
	m	N	N	N

- Note**
1. Data beyond n+1 will be ignored.
 2. The sub-code "m" determines whether the table entry is a string or numeral table entry. Set m=0 to indicate a string table entry; set m=1 to indicate a numeral table entry.

2-5-8 System Status Control

This command (command code D) is used to control the PT's operating status.

Word	15 to 12	11 to 08	07 to 04	03 to 00
n	Command code	Not used.		
	D	x	x	x
n + 1	Status control bits			
	N	N	x	x

Note Data in the areas marked "x" and data beyond word n+1 will be ignored.

Bits 10 through 15 of n+1 control various aspects of PT operation, as shown in the following table.

Bit	ON	OFF	Notes
00 to 09	Not used.	Not used.	---
10	Red backlight	White backlight	See note 1.
11	History initialization	Not used.	---
12	Intermittent buzzer ON	Intermittent buzzer OFF	See note 2.
13	Continuous buzzer ON	Continuous buzzer OFF	See note 2.
14	Alarm output ON	Alarm output OFF	---
15	Backlight ON	Backlight OFF	---

Note 1. Red/white backlight selection is valid for the NT20M-DT131/DN131 only.

Bit 10 status	Bit 15 status	Backlight
0	1	White
1	1	Red
0 or 1	0	Backlight off

2. A continuous buzzer will be produced if both intermittent buzzer and continuous buzzer are designated.

2-6 PT-to-PC Commands

In the following descriptions of commands, “n” is the beginning DM word set on pins 4 and 5 of SW4. The following table shows the function of bits in DM words n+8 through n+15. Refer to 2-4-1 *DM Word Allocation* for more details.

DM Word	Bits	Usage
n+8	00 to 07	Input data
	08 to 11	Command Code
	12 to 15	PT status
n+9	00 to 15	Input data
n+10	00 to 15	Input data
n+11	00 to 15	Input data
n+12	00 to 11	Touch switches/function keys 00 to 11
	11 to 15	Touch switches/function keys 12 to 15
n+13	00 to 15	Touch switches/function keys 16 to 31
n+14	00 to 15	Touch switches 32 to 47
n+15	00 to 15	Touch switches 48 to 63

Commands are all designated by single-digit hexadecimal numbers (0 to F) in bits 08 to 11 of n+8. All input data is designated in BCD (binary coded decimal).

Command code	Function
0 to 2	Not used.
3	Numeral editing input (writing positive numbers)
4	Numeral editing input (writing negative numbers)
5 to 7	Not used.
8	Response to screen number request
9	Touch switch input (numeral input)
A	Not used.
B	Function key input (numeral input)
C to F	Not used.

2-6-1 PT Status Flags

The PT status flags (bits 12 to 15 of word n+8) provide information on the operating status of the PT, as shown in the following table. This data is transmitted to the PC when a PT-to-PC command is executed. Refer to *2-4 DM Word Allocation and Data Transfer* for details on PT status and the strobe signal.

Bit	Name	Function
12	Strobe	Sets the timing for data transmissions from the PT to the PC. For details, see <i>2-4-2 Operational Flow and Strobe</i> . Data should be input to words n+8 through n+11 when this bit goes from OFF to ON.
13	BAT LOW	ON when the PT's battery voltage drops. Replace the battery within 5 days after this bit goes ON.
14	BUSY	ON when data cannot be output from the PC to the PT.
15	PT RUN	ON when the PT is in RUN mode.

2-6-2 Touch Switch Input

There are two ways to indicate touch switch input, numeral input indication (command code 9) and bit input indication. The numeral input method is valid for all touch switches (000 to 255), while the bit input method is valid for touch switches 00 to 63 only.

These operations are valid with touch switch-type PTs only.

Numeral Input Indication

This method uses a communications command (command code 9) to transmit the touch switch numbers to the PC. The numbers of touch switches that have been input can be transmitted to the PC when the screen used to set the switches is being displayed on the PT.

This operation is valid only when the Support Tool has been used to disable the "Bit Input" setting in the screen attributes.

Word	15 to 12	11 to 08	07 to 04	03 to 00
n + 8	PT status	Command code	Not used.	
	?	9	x	x
n + 9	Not used.	Touch switch number		
	x	N	N	N

- Note**
1. The question mark (?) indicates change according to the status of the PT.
 2. Data in the areas marked by x and in words beyond n+9 will be ignored. (Touch switch data will not appear in words n+12 through n+15.)
- Touch switch numbers are designated by 3-digit BCD numbers (000 to 255).
The input occurs only when a touch switch is pressed, and there is no indication of when it is released.

Bit Input Indication

When a screen in which the touch switches have been set is being displayed on the PT, inputs to touch switches 00 to 63 can also be detected through bits allocated in n+12 through n+15. The following table shows the bit allocation for these touch switches.

DM Word	Bits	Allocation
n+12	00 to 15	Touch switches 00 to 15
n+13	00 to 15	Touch switches 16 to 31
n+14	00 to 15	Touch switches 32 to 47
n+15	00 to 15	Touch switches 48 to 63

This operation is valid only when the Support Tool has been used to enable the “Bit Input” setting and the inputs have been set for touch switches in the screen attributes.

Bit operation is unrelated to command codes and is always valid.

- Note** The PT’s strobe signal will not be turned ON when touch switch inputs are indicated by the status of bits in n+12 through n+15.

2-6-3 Function Key Input

There are two ways to indicate function key inputs, numeral input indication (command code B) and bit input indication. These operations are valid with function key-type PTs only.

Numeral Input Indication

This method uses a communications command (command code B) to transmit to the PC the function key number that was input. Function key numbers 00 to 31 can be transmitted.

The function key numbers that can be transmitted depend on the PT model and Unit installed, as shown in the following table.

PT model	Unit installed	Function key numbers
NT600M-DF122	---	00 through 11
NT20M-DN131/121 NT600M-DN122/211	12-key Function Key Unit	00 through 11

This operation is valid only when the Support Tool has been used to disable the “Bit Input” setting in the screen attributes.

Word	15 to 12	11 to 08	07 to 04	03 to 00
n + 8	PT status	Command code	Not used.	
	?	B	x	x
n + 9	Not used.	Function key number		
	x	N	N	N

- Note**
1. The question mark (?) indicates change according to the status of the PT.
 2. Data in the areas marked by x and in words beyond n+9 will be ignored. (Switch data will not appear in words n+12 through n+15.)

Function key numbers are designated by 2-digit BCD numbers (00 to 31).

The function key number is transmitted when a function key is pressed, and there is no indication of when it is released.

Bit Input Indication

With function key-type PTs, inputs to function keys can also be detected through bits allocated in $n+12$ and $n+13$. The following table shows the bit allocation for the function keys (numbers 00 to 31).

DM Word	Bits	Allocation
$n+12$	00 to 15	Function keys 00 to 15
$n+13$	00 to 15	Function keys 16 to 31

This operation is valid only when the Support Tool has been used to enable the “Bit Input” setting and the inputs have been set for function keys in the screen attributes.

Bit operation is unrelated to command codes and is always valid.

2-6-4 Numeral Table Editing

When the numeral table editing screen is being displayed on the PT, numeral input on the touch switches or function keys can be written to the numeral table entry specified with the Support Tool.

Positive numbers are set with a command code of 3, and negative numbers are set with a command code of 4. If the numeral table entry specified with the Support Tool has been allocated memory in the DM Area, the contents of that memory will be overwritten with the data input on the touch switches or function keys.

The numeral table entry in the DM Area is not overwritten until the strobe signal goes ON, so use the data in words $n+10$ and $n+11$ until that time. Also, negative numbers cannot be written to the numeral table entry in the DM Area.

Writing Positive Numbers

A command code of 3 is used to inform the PC of positive numbers that have been registered in the numeral table.

Word	15 to 12	11 to 08	07 to 04	03 to 00
$n + 8$	PT status	Command code	Not used.	
	?	3	x	x
$n + 9$	Not used.	Table entry number		
	x	N	N	N
$n + 10$	Number data (leftmost 4 digits)			
	N	N	N	N
$n + 11$	Number data (rightmost 4 digits)			
	N	N	N	N

Note The question mark (?) indicates variable data representing PT status. See 2-6-1 PT Status Flags for details. Data in the areas marked by x is ignored.

Numeral table entry numbers are designated by 3 digits of BCD (000 to 127 for the NT20M, and 000 to 255 for the NT600M).

Numeral data is expressed in 8-digit BCD (00000000 to 99999999). The leftmost 4 digits are designated in word $n+10$ and the rightmost 4 digits are designated in word $n+11$.

The same numeral table is used for PC-to-PT transmission.

Writing Negative Numbers

A command code of 4 is used to notify the PC of negative numbers that have been registered in the numeral table.

Word	15 to 12	11 to 08	07 to 04	03 to 00
n + 8	PT status	Command code	Not used	
	?	4	x	x
n + 9	Not used	Table entry number		
	x	N	N	N
n + 10	Number data (leftmost 4 digits)			
	N	N	N	N
n + 11	Number data (rightmost 4 digits)			
	N	N	N	N

Note The question mark (?) indicates variable data representing PT status. See 2-6-1 *PT Status Flags* for details. Data in the areas marked by x is ignored.

Numeral table entry numbers are designated by 3 digits of BCD (000 to 127 for the NT20M, and 000 to 255 for the NT600M).

Numeral data is expressed in 8-digit BCD (00000000 to 99999999). The leftmost 4 digits are designated in word n+10 and the rightmost 4 digits are designated in word n+11.

The same numeral table is used for PC-to-PT transmission.

2-6-5 Response to Screen Number Request

When a "screen number request" command (command code A) is received from the PC, the PT uses this command (command code 8) to transmit the number of the screen being displayed back to the PC. This command uses a "stand alone" function and will automatically transmit the screen number even when the screen was switched.

Word	15 to 12	11 to 08	07 to 04	03 to 00
n + 8	PT status	Command code	Not used	
	?	8	x	x
n + 9	Screen number			
	N	N	N	N

Note 1. The question mark (?) indicates variable data representing PT status.
2. Refer to 2-5-6 *Screen Number Request* for details on that command.

2-7 System Startup

2-7-1 Preliminary Procedures

The following flowchart shows the procedures to be performed before system startup, such as writing screen data with the Support Tool, transferring it to

the PT, and writing the PC program. It is recommended to perform these procedures as shown in the flowchart.

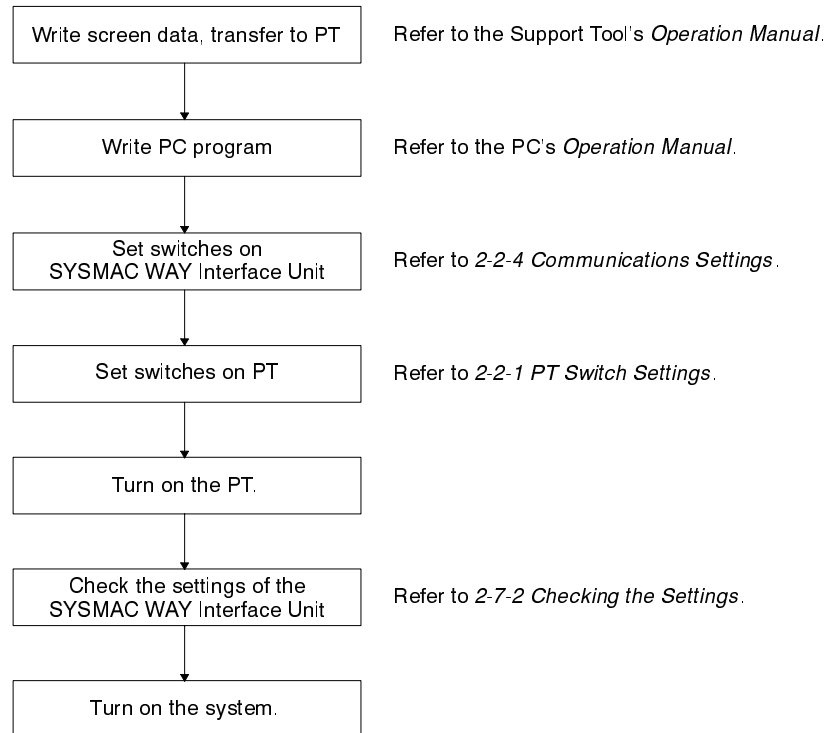

2-7-2 Checking the Settings

The SYSMAC WAY Interface Unit's settings can be checked using the PT's system menu. The Unit's settings should be checked before turning on the system and when troubleshooting communications errors. Refer to the PT's *Operation Manual* for more details.

Follow the procedure listed below to check the SYSMAC WAY Interface Unit's settings.

- 1, 2, 3...**
1. Bring up the system menu display. (Press the Buzzer Key, Up Arrow Key, and Down Arrow Key.)
 2. Select maintenance mode.
 3. Select PT settings.
 4. Press the Down Arrow Key.
- The SYSMAC WAY Interface Unit's current settings should be displayed. Check that the settings are correct.

Note To return to RUN mode, press the Buzzer Key, Up Arrow Key, and Down Arrow Key simultaneously.

2-8 Communications Errors

2-8-1 Communications Errors

The following five communications errors can be detected.

- 1, 2, 3...**
1. Parity Error, Overrun Error, Framing Error
An error occurred in the reception of data.
ACIA Parity error: Parity bits were not consistent.
ACIA Overrun error: There was a mistake in the reception data.
ACIA Framing error: A frame could not be constructed for data received.

- 2. Timeout
A timeout occurred during reception of a communications command because no response was received from the PC after 5 retries. A timeout occurs after 5 s.
- 3. NAK Error
NAK was received. Transmission was retried 5 times, but the results were all NAK.
- 4. Unit Number Error
A different unit number was designated in the middle of a communications command.
- 5. FCS Error
The FCS value does not agree with the calculated value.

2-8-2 Processing Communications Errors

When communications errors occur, the PT executes the following internal processing.

- 1, 2, 3... 1. PT Internal Processing
If a communications error occurs, the cause of the error will be displayed on the screen and the buzzer will sound.
- 2. Response
Restart operation by pressing the Buzzer Key or the Return Key. Recheck the settings.

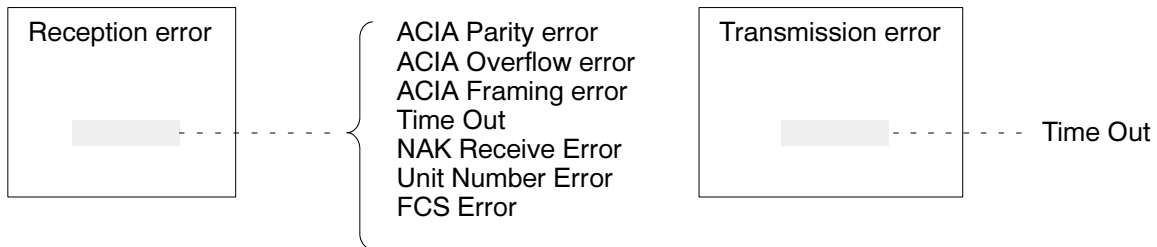

Communications Error Processing

Error	Probable cause	Possible correction
Parity error Overflow error Framing error	Communications settings are not correct.	Check to see that the parity bit, frame length, baud rate, and stop bit settings are the same between the PC and PT.
	Data changed during transmission.	Use noise-resistant cables in locations subject to excessive noise.
Timeout	A cable is disconnected.	Recheck cable connections.
	The PC stopped.	Check the PC's RUN status.
NAK Error	There is an erroneous switch setting, and the wrong DM was accessed.	Set the switches to match the PC DM.
	There is an error in communications data from the PT.	The PT may be malfunctioning. Check the operation of the PT.
	Data changed during transmission.	Use noise-resistant cables in locations subject to excessive noise.
Unit Number Error	The PC's unit number was changed.	Return to RUN mode.
	The PC transmitted erroneous data.	Check the operation of the PC.
	Data changed during transmission.	Use noise-resistant cables in locations subject to excessive noise.
FCS Error	The PC transmitted erroneous data.	Check the operation of the PC.
	Data changed during transmission.	Use noise-resistant cables in locations subject to excessive noise.

2-8-3 Troubleshooting

With some errors, the Unit's status cannot be checked with the PT's maintenance mode. The following table provides possible causes and possible remedies for these errors.

Symptom	Probable cause	Possible remedy
No display on screen	Waiting for command from PC or there is no screen data.	Issue a command from the PC. Record screen data with Support Tool.
Cannot transmit from SYSMAC WAY Interface Unit	Switch settings are incorrect.	Check the settings in maintenance mode, and be sure that they agree with the PC's.
	SYSMAC WAY Interface Unit is connected incorrectly.	Check the connecting cable wiring. Use shielded cable. Be sure that the cable length does not exceed the maximum.
Display indicates no SYSMAC WAY Interface Unit	SYSMAC WAY Interface Unit is not connected.	Connect SYSMAC WAY Interface Unit.
The PT's "RUN LED" is not lit during operation and the buzzer sounds continuously.	PT is running uncontrolled or external noise is affecting PT.	Install the connecting cables away from high voltage lines or equipment that generates noise. Also install noise filters in power supply lines.
	System ROM installed incorrectly.	Install the System ROM correctly and be sure that it is fastened securely.

SECTION 3

SYSMAC BUS Interface

This section covers hardware and commands for NT600M-RT121 and NT20M-RT121-V2 Wired SYSMAC BUS Host Interface Units. These Host Interface Units can be connected to SYSMAC C-series Wired Remote I/O Master Units as part of a SYSMAC BUS Remote I/O System.

3-1	Features and System Configuration	36
3-1-1	Features	36
3-1-2	System Configuration	36
3-2	Specifications and Switch Settings	37
3-2-1	Communications Specifications	37
3-2-2	Components	37
3-2-3	Switch Settings	38
3-2-4	LED Indicators	39
3-3	Connection to the PC	39
3-3-1	Connections	39
3-4	Data Transmission and I/O Word Allocation	41
3-4-1	Data Transmission	41
3-4-2	C200H I/O Word Allocation	41
3-4-3	C500 I/O Word Allocation	42
3-4-4	C1000H/C2000H I/O Word Allocation	43
3-4-5	CV500/CV1000 I/O Word Allocation	44
3-5	PC-to-PT Commands	45
3-5-1	I/O Allocations	45
3-5-2	Command Codes	46
3-5-3	Designated Screen Display	46
3-5-4	Numeral Table Settings	46
3-5-5	String Table Settings	48
3-5-6	Lamp and Touch Switch Display Control	49
3-5-7	Screen Number Request	50
3-5-8	System Status Control	51
3-5-9	Copy Memory Table Entry	52
3-6	PT-to-PC Commands	52
3-6-1	I/O Allocations	52
3-6-2	Command Codes	52
3-6-3	PT Status Flags	53
3-6-4	Numeral Table Editing	53
3-6-5	Response to Screen Number Request	54
3-6-6	Touch Switch Input	55
3-6-7	Function Key Input	56
3-7	System Startup	57
3-7-1	Preliminary Procedures	57
3-7-2	SYSMAC BUS Remote I/O System Startup	58
3-7-3	Checking the Settings	58
3-7-4	Communications Check	59
3-8	Transfer Time	60
3-8-1	C200H Example	61
3-8-2	C500 Example	61
3-8-3	C1000H/C2000H Example	62
3-9	Communications Errors	62
3-9-1	Processing Communications Errors	63
3-9-2	Troubleshooting	65

3-1 Features and System Configuration

3-1-1 Features

SYSMAC BUS Interface Units are used to connect up to 8 Programmable Terminals (PTs) to a SYSMAC PC through a SYSMAC BUS Wired Remote I/O System.

Automatic Data Transfer

In a SYSMAC BUS Wired Remote I/O System, the Master mounted to the PC controls communications with PTs and other Slaves. Data transfer to and from the Slaves takes place in a specially allocated region of the PC's memory. This automatic data transfer greatly simplifies programming and communication.

Reduced Wiring

Connections between the Master and Slaves can be made with just a twisted-pair cable in a SYSMAC BUS Wired Remote I/O System, greatly reducing wiring costs.

3-1-2 System Configuration

Up to 8 PTs can be connected to a single C-series PC, and the maximum wiring distance is 200 m.

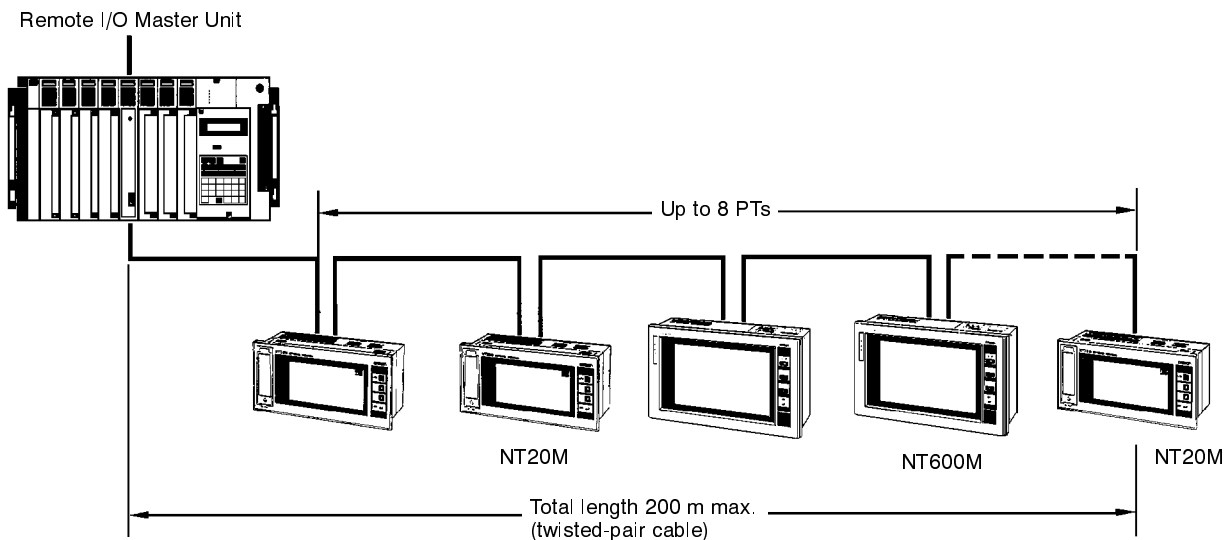

Max. Number of PTs

The following table shows the maximum number of PTs that can be connected to a given PC.

PC	Master	Max. number of Masters	Max. number of PTs
C200H	C200H-RM201	2	8
C500	C500-RM201	2	8
C1000H/ C2000H		4	32
CV500		4	8
CV1000		8	16

System ROM and Compatible PTs

System ROM (sold separately) is required when using an NT600M-RT121 SYSMAC BUS Interface Unit. The following table shows the required System

ROM as well as the PTs that are compatible with the NT20M-RT121-V2 and NT600M-RT121.

SYSMAC BUS Interface Unit	Compatible PTs	Required System ROM
NT600M-RT121	NT20M-DT121/125-V2, NT20M-DN121-V2, NT2000M-DT/DN131, NT20M-DT131, NT20M-DN131	NT20M-SMR01-E
	NT600M-DT122/211, NT600M-DF122, NT600M-DN122/211	NT600M-SMR01-EV1

Note The communications specifications of the NT2000M are the same as those of the NT20M. Any description of the NT20M hereafter also applies to the NT2000M.

3-2 Specifications and Switch Settings

3-2-1 Communications Specifications

Item	Specifications
Communications method	Two-wire half-duplex
Synchronization method	Start-stop synchronization
Transmission route	Two-wire cable (VCTF 0.75 x 2C recommended.)
Interface	RS-485
Baud rate	187.5 kbps
Transmission distance	Cable length: 200 m max. total
Diagnostic functions	Transmission error check (BCC + reverse 2 continuous transmission check) and CPU error monitor
Number of nodes (per Master)	C500, C200H, C1000H, C2000H, CV500, or CV1000: A maximum of eight NT20M-RT121-V2 or NT600M-RT121 Host Interface Units can be connected.

3-2-2 Components

The following diagram shows the major components of the SYSMAC BUS Interface Unit that are used during operation.

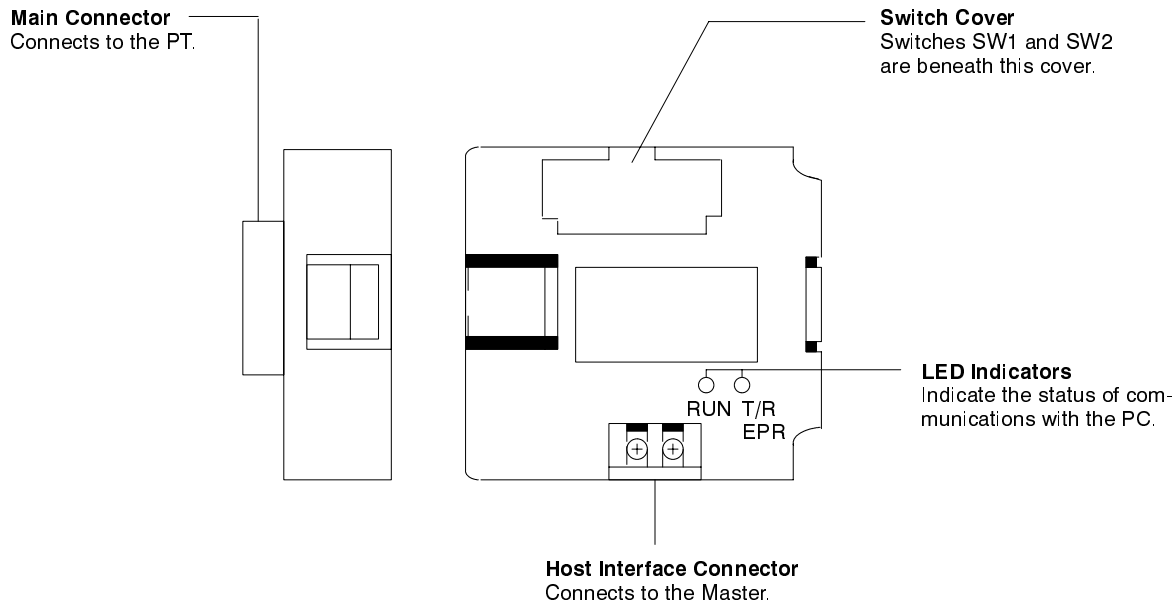

3-2-3 Switch Settings

Underneath the cover on the back panel, there are two switches. SW1 is for setting words, the strobe cycle, and output hold or stop. SW2 is for setting the terminator. Make sure that the power is off when making switch settings.

SW1, Pins 1 through 3

The diagram below shows SW1 and the functions of its pins. The output hold/stop and strobe cycle settings are described below, but the word allocation settings (pins 1 through 3) are described in *3-4 Data Transmission and I/O Word Allocation*.

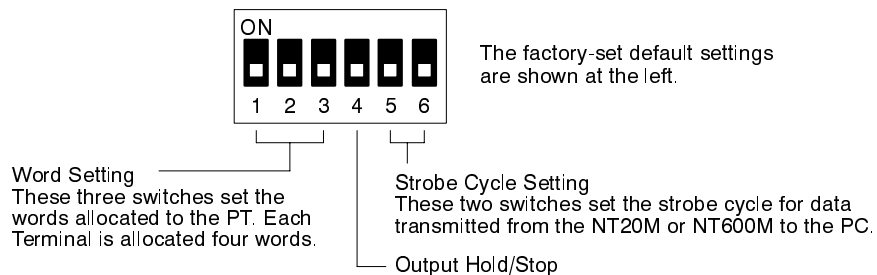

SW1, Pin 4

Pin 4 of SW1 determines whether outputs hold their previous status or go OFF when transmission errors occur. Transmission errors occur for errors in data or no data sent from the Master.

Pin 4	Operation
OFF	Holding Mode: When there is an error in transmission, the output status immediately prior to the error is retained.
ON	STOP Mode: All outputs turns OFF (low) for transmission errors.

SW1, Pins 5 and 6

Pins 5 and 6 of SW1 are used to set the strobe cycle, as shown in the following table. The strobe signal (bit 12 of DM word n+8) is used to synchronize the transmission of data from the PT to the PC.

When writing programs to receive data from the PC, have the PC take in data on the rising edge of the strobe signal.

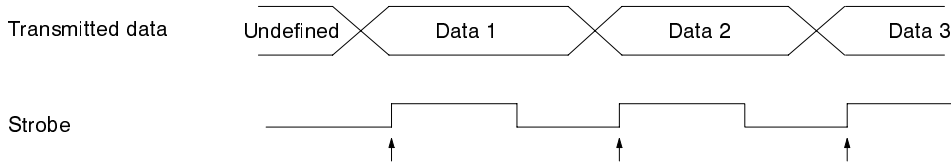

If the strobe cycle is shorter than the PC's scan time, the PC might not input data transmitted from the PT. Be sure that the strobe cycle is longer than the PC's scan time. Refer to 3-6-3 PT Status Flags for more details.

Pin 5	Pin 6	Strobe cycle	Strobe signal ON time
OFF	OFF	120 ms	60 ms
OFF	ON	240 ms	120 ms
ON	OFF	480 ms	240 ms
ON	ON	Not used.	

SW2 (Terminator Setting)

Switch 2 connects termination resistance. Connect the termination resistance only on the last Terminal (NT600M-RT121) in line from the Master. (Turn this switch OFF if the Unit is not at the end of the line.)

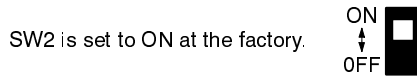

ON	Sets this Unit as the terminator.
OFF	Does not set this Unit as the terminator.

3-2-4 LED Indicators

SYSMAC BUS Host Interface Units have two indicators, as shown below. These indicators show the status of the transmission path.

Name	Color	Status	Content
RUN	Green	Lit	Lit when PT's power is on and the Unit is operating.
		Not lit.	Not lit while operation is stopped.
T/R ERR	Red	Flashing	Flashes during normal transmission.
		Lit	Lit during standby or transmission errors.
		Not lit.	Not lit when there is a PT error.

3-3 Connection to the PC

Connections in the SYSMAC BUS Wired Remote I/O System are made with RS-485 interfaces. Slaves are wired in order from the Master with twisted-pair cable. The Slave at the end of the line is set as the terminator.

3-3-1 Connections

Connect Remote I/O Master Unit, Remote I/O Slave Units, and the Host Interface Units with twisted-pair cable.

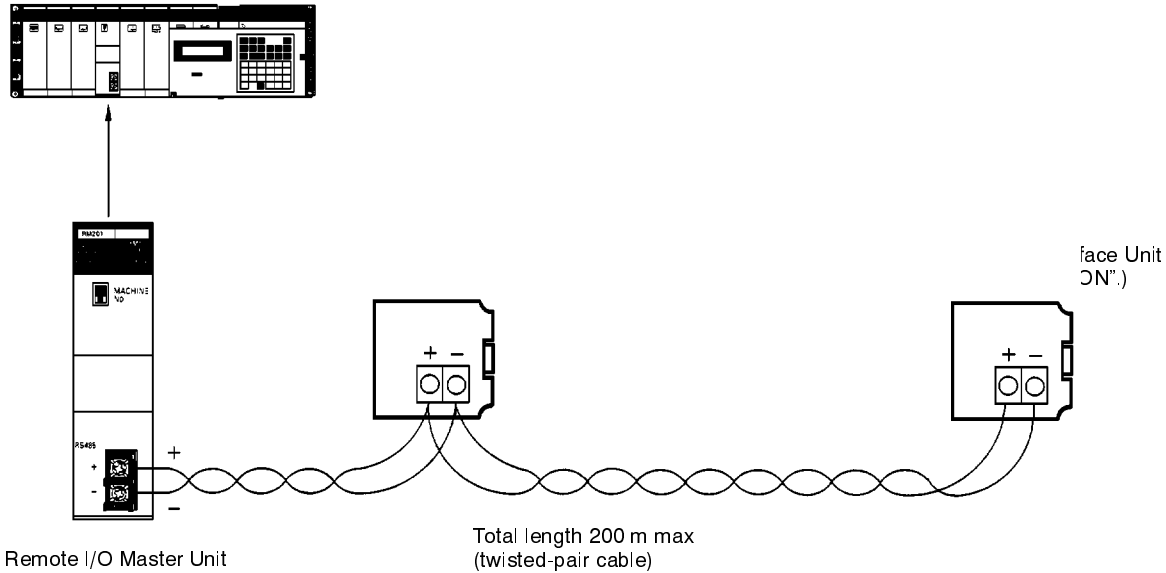

Wiring Procedure

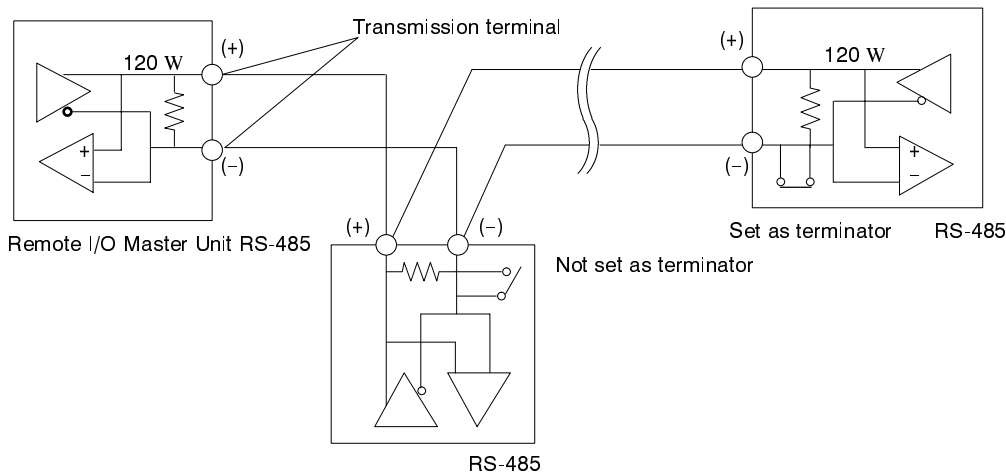

- 1, 2, 3...** 1. Use VCTF two-wire cable (tough vinyl cable), 0.75 X 2C. The total cable length must not exceed 200 m.
 2. Connect Units in order from the Master, wiring positive terminals to positive, and negative to negative. Never connect more than one Slave directly from the Master or branch off from the line.
 3. Set the terminator (SW2) ON in the Slave at the end of the line. Set the terminator OFF in all other Slaves.
- SYSMAC BUS Interface Units are shipped from the factory with SW2 set to ON. Be sure that this switch is OFF unless the Unit is the last in line. Refer to 3-2-3 *Switch Settings* for details.
4. The SYSMAC BUS transmission lines can be installed along with ordinary I/O lines and ordinary power lines. Do not, however, lay transmission lines in parallel or in proximity to lines with high voltage or current.
 5. When connecting Slave Racks, be careful not to use the same word addresses for the Slave Racks and the PTs. Refer to 3-4 *Data Transmission and I/O Word Allocation* for details.
 6. Use crimp terminals like those shown below when wiring.

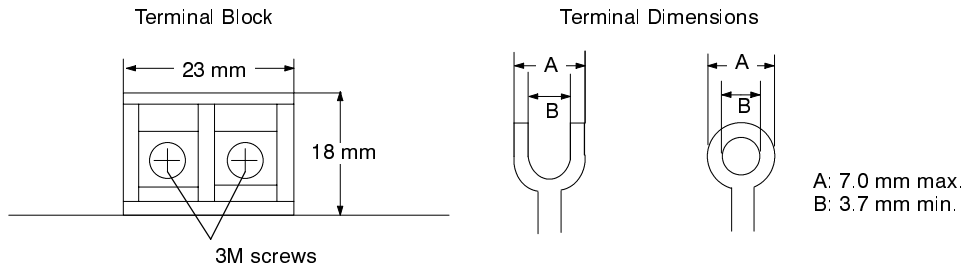

3-4 Data Transmission and I/O Word Allocation

3-4-1 Data Transmission

The transfer of data and operating instructions between the PC and PT is carried out with communications commands. These commands use a dedicated part of the PC's IR Area to write operating instructions and data from the PC to the PT, and read input information and data from the PT to the PC.

SYSMAC BUS Host Interface Units are each allocated 4 words. The settings on pins 1 to 3 of SW1 and the PC model determine which 4 words in the PC are allocated to the Unit. The following diagram shows how these 4 words are used in data transmission.

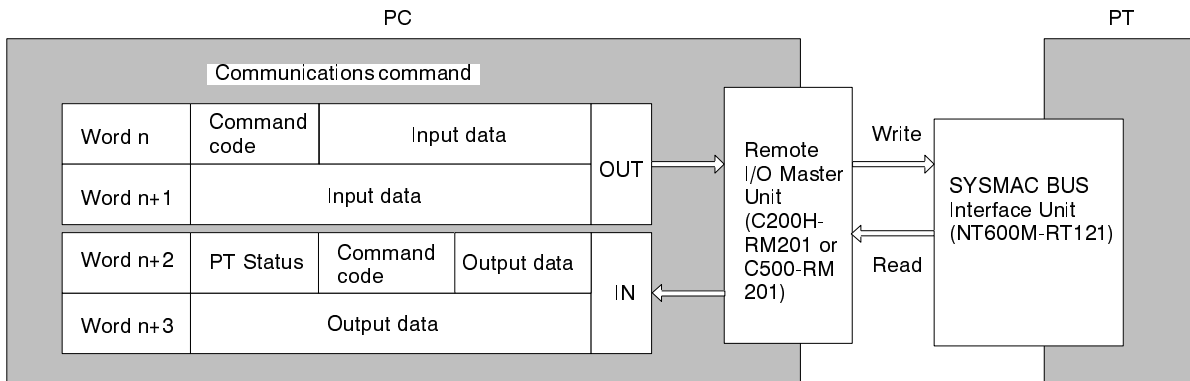

I/O Word Usage

The following table shows the usage of the 4 I/O words allocated to the SYSMAC BUS Interface Unit. The beginning I/O word "n" is determined by the settings of SW1 pins 1 to 3.

Type of I/O	I/O Word	Bits			
		15 to 12	11 to 08	07 to 04	03 to 00
Output (PC to PT)	n	Command code (Write)	Input data (3-digit BCD or binary)		
	n + 1	Input data (4-digit BCD or binary)			
Input (PT to PC)	n + 2	PT status flags	Command code (Read)	Output data (2-digit BCD)	
	n + 3	Output data (4-digit BCD or binary)			

3-4-2 C200H I/O Word Allocation

In the C200H, each PT is allocated four words between IR 200 and IR 231 (set aside for Optical I/O Units). C200H Slave Racks used IR 050 to IR 099, so 8 PTs can be installed in addition to 5 Slave Racks.

Pin			Allocated IR words			
SW1, pin 1	SW1, pin 2	SW1, pin 3	n	n+1	n+2	n+3
OFF	OFF	OFF	200	201	202	203
OFF	OFF	ON	204	205	206	207
OFF	ON	OFF	208	209	210	211
OFF	ON	ON	212	213	214	215
ON	OFF	OFF	216	217	218	219
ON	OFF	ON	220	221	222	223
ON	ON	OFF	224	225	226	227
ON	ON	ON	228	229	230	231

Example

The following example shows I/O word allocation in a system containing two Masters.

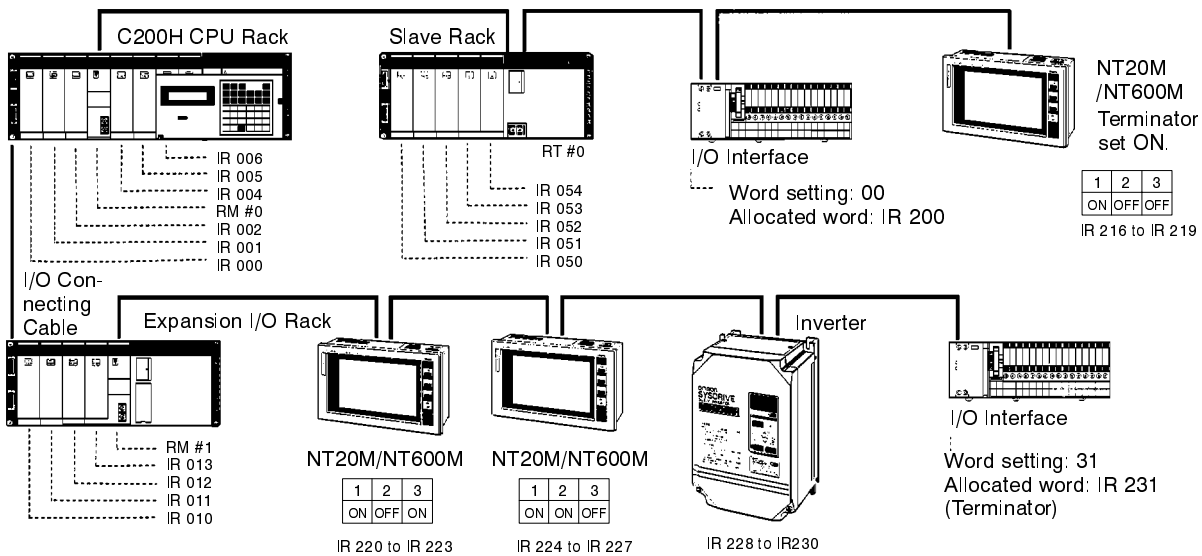

- Note**
1. Remote I/O Master Units cannot be mounted to C200H PCs with C200H-CPU02/22 CPUs.
 2. Be sure not to allocate the same I/O words to another Slave (such as an I/O Terminal or I/O Interface).

3-4-3 C500 I/O Word Allocation

Like ordinary Remote I/O Slave Units, each PT is allocated four words between IR 00 and IR 31. When setting the words, be sure they have not already been allocated to another Slave (such as an I/O Terminal or I/O Interface).

Pin settings			Allocated IR words			
SW1, pin 1	SW1, pin 2	SW1, pin 3	n	n+1	n+2	n+3
OFF	OFF	OFF	0	1	2	3
OFF	OFF	ON	4	5	6	7
OFF	ON	OFF	8	9	10	11
OFF	ON	ON	12	13	14	15
ON	OFF	OFF	16	17	18	19
ON	OFF	ON	20	21	22	23
ON	ON	OFF	24	25	26	27
ON	ON	ON	28	29	30	31

Note In order to avoid allocating I/O words that have already been allocated to another Unit, it is recommended to allocated words in reverse order (beginning with IR 28 through IR 31).

Example

The following example shows I/O word allocation in a C500 system.

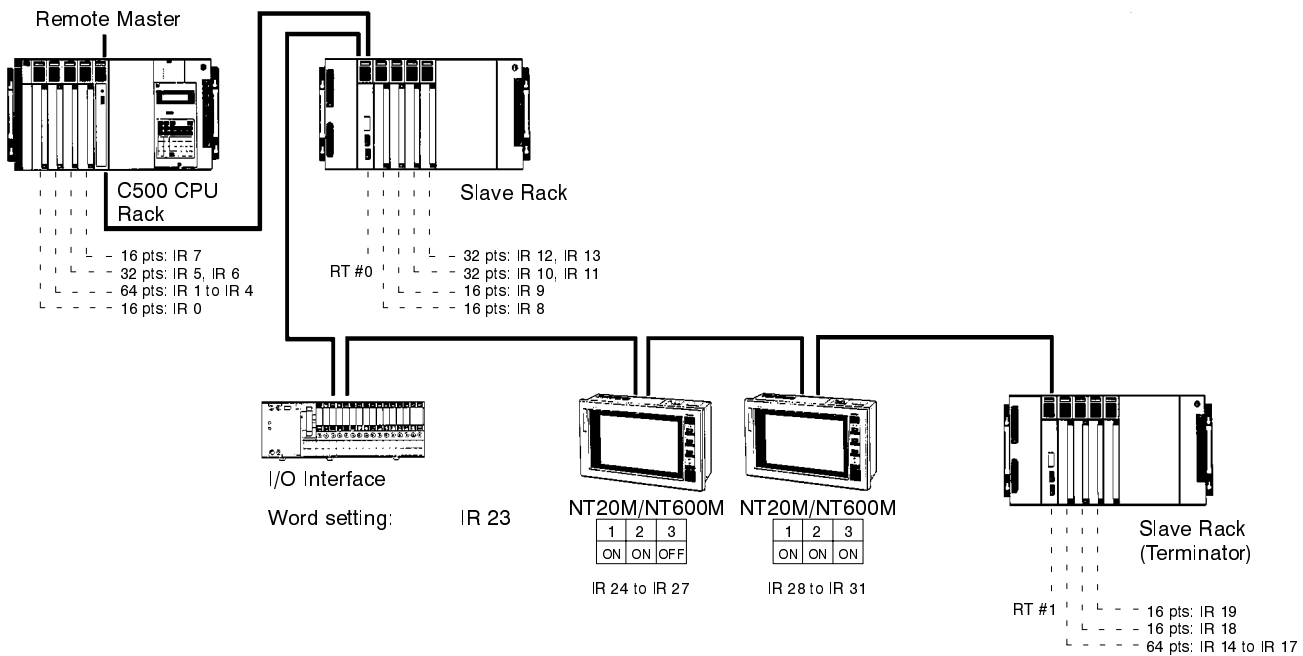

3-4-4 C1000H/C2000H I/O Word Allocation

Like ordinary Remote I/O Slave Units, each PT is allocated four words between IR 000 and IR 127. When setting the words, be sure they have not already been allocated to another Unit.

There are only 8 combinations of SW1 pins 1, 2, and 3, but the word multiplier setting (0 to 3) on the Master increases the number of combinations by a factor of 4. For instructions on setting word multipliers, refer to the *Wired Remote I/O System Manual*.

Pin			Allocated IR words															
SW1, pin 1	SW1, pin 2	SW1, pin 3	Word multiplier: 0				Word multiplier: 1				Word multiplier: 2				Word multiplier: 3			
			n	n+1	n+2	n+3	n	n+1	n+2	n+3	n	n+1	n+2	n+3	n	n+1	n+2	n+3
OFF	OFF	OFF	0	1	2	3	32	33	34	35	64	65	66	67	96	97	98	99
OFF	OFF	ON	4	5	6	7	36	37	38	39	68	69	70	71	100	101	102	103
OFF	ON	OFF	8	9	10	11	40	41	42	43	72	73	74	75	104	105	106	107
OFF	ON	ON	12	13	14	15	44	45	46	47	76	77	78	79	108	109	110	111
ON	OFF	OFF	16	17	18	19	48	49	50	51	80	81	82	83	112	113	114	115
ON	OFF	ON	20	21	22	23	52	53	54	55	84	85	86	87	116	117	118	119
ON	ON	OFF	24	25	26	27	56	57	58	59	88	89	90	91	120	121	122	123
ON	ON	ON	28	29	30	31	60	61	62	63	92	93	94	95	124	125	126	127

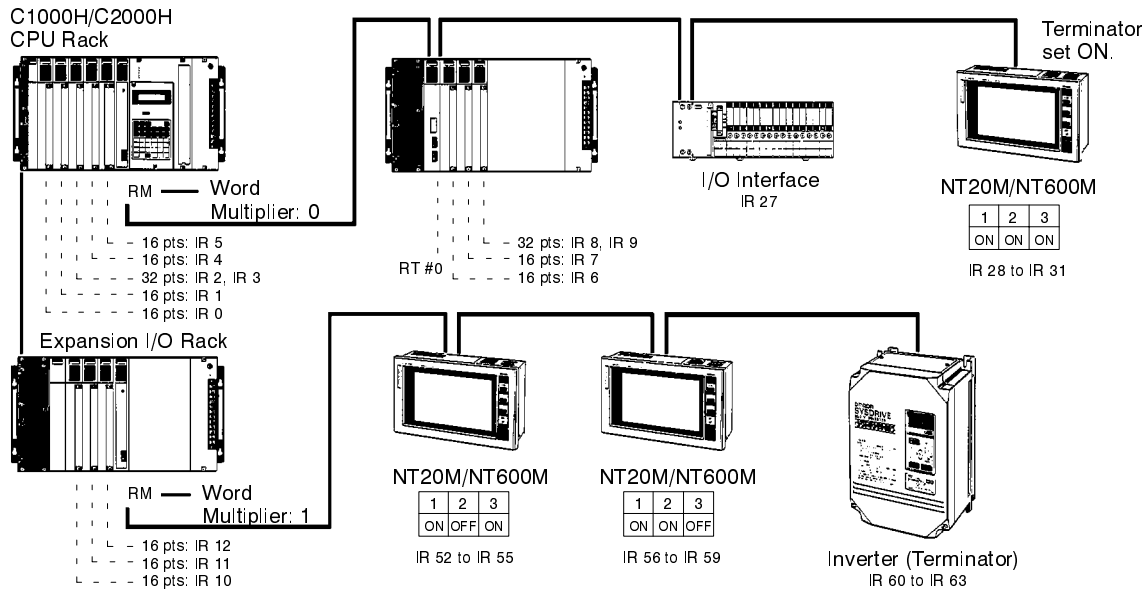

3-4-5 CV500/CV1000 I/O Word Allocation

A part of the CV500/CV1000 PC's CIO Area is allocated to the SYSMAC BUS Remote I/O System. SYSMAC BUS Area addresses range from CIO 2300 through CIO 2555. These 256 words are divided into 8 groups of 32 words each and are allocated to Masters according to their number settings.

The 4 words allocated to each PT depends on the Master's number setting and the settings on pins 1 to 3 of SW1, as shown in the following tables. (For SW1 pin settings: 0=OFF, 1=ON)

SW1 pin			Allocated CIO words															
1	2	3	Master number: 0				Master number: 1				Master number: 2				Master number: 3			
			n	n+1	n+2	n+3	n	n+1	n+2	n+3	n	n+1	n+2	n+3	n	n+1	n+2	n+3
0	0	0	2300	2301	2302	2303	2332	2333	2334	2335	2364	2365	2366	2367	2396	2397	2398	2399
0	0	1	2304	2305	2306	2307	2336	2337	2338	2339	2368	2369	2370	2371	2400	2401	2402	2403
0	1	0	2308	2309	2310	2311	2340	2341	2342	2343	2372	2373	2374	2375	2404	2405	2406	2407
0	1	1	2312	2313	2314	2315	2344	2345	2346	2347	2376	2377	2378	2379	2408	2409	2410	2411
1	0	0	2316	2317	2318	2319	2348	2349	2350	2351	2380	2381	2382	2383	2412	2413	2414	2415
1	0	1	2320	2321	2322	2323	2352	2353	2354	2355	2384	2385	2386	2387	2416	2417	2418	2419
1	1	0	2324	2325	2326	2327	2356	2357	2358	2359	2388	2389	2390	2391	2420	2421	2422	2423
1	1	1	2328	2329	2330	2331	2360	2361	2362	2363	2392	2393	2394	2395	2424	2425	2426	2427

SW1 pin			Allocated CIO words															
1	2	3	Master number: 4				Master number: 5				Master number: 6				Master number: 7			
			n	n+1	n+2	n+3	n	n+1	n+2	n+3	n	n+1	n+2	n+3	n	n+1	n+2	n+3
0	0	0	2428	2429	2430	2431	2460	2461	2462	2463	2492	2493	2494	2495	2524	2525	2526	2527
0	0	1	2432	2433	2434	2435	2464	2465	2466	2467	2496	2497	2498	2499	2528	2529	2530	2531
0	1	0	2436	2437	2438	2439	2468	2469	2470	2471	2500	2501	2502	2503	2532	2533	2534	2535
0	1	1	2440	2441	2442	2443	2472	2473	2474	2475	2504	2505	2506	2507	2536	2537	2538	2539
1	0	0	2444	2445	2446	2447	2476	2477	2478	2479	2508	2509	2510	2511	2540	2541	2542	2543
1	0	1	2448	2449	2450	2451	2480	2481	2482	2483	2512	2513	2514	2515	2544	2545	2546	2547
1	1	0	2452	2453	2454	2455	2484	2485	2486	2487	2516	2517	2518	2519	2548	2549	2550	2551
1	1	1	2456	2457	2458	2459	2488	2489	2490	2491	2520	2521	2522	2523	2552	2553	2554	2555

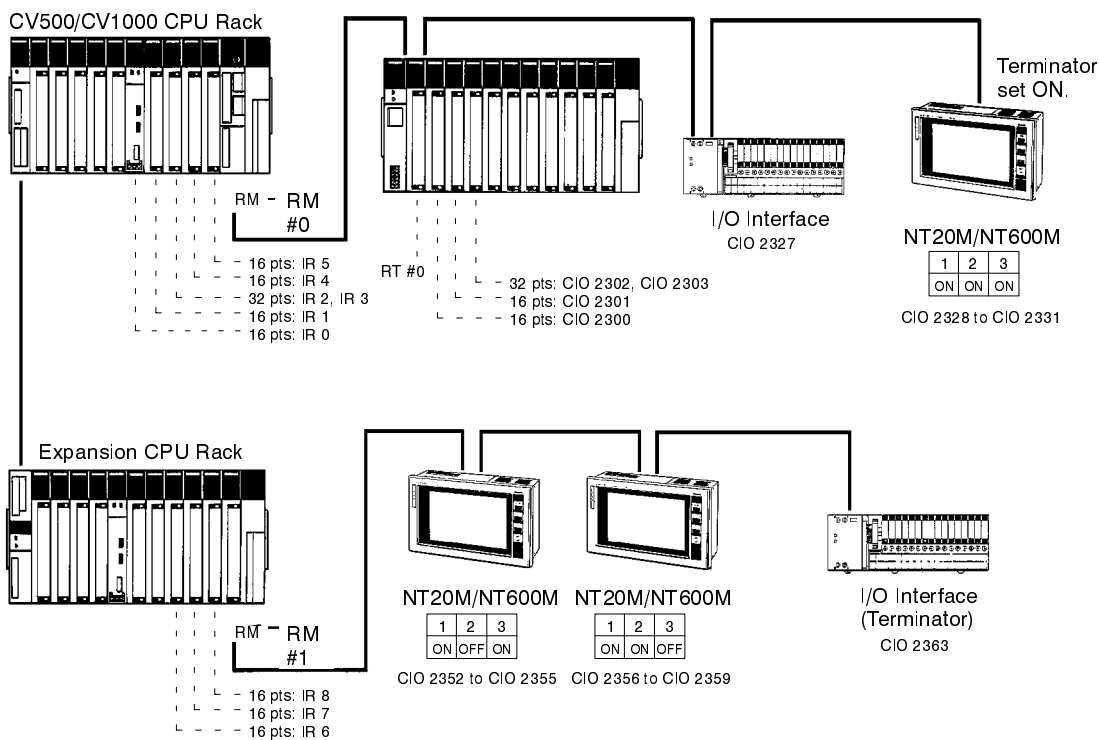

3-5 PC-to-PT Commands

3-5-1 I/O Allocations

Of the four words allocated to each Host Interface Unit, words n and n+1 are used for output and n+2 and n+3 are used for input, as shown below. For switch setting instructions, refer to 3-2 Specifications and Switch Settings. For details on PC word allocations, refer to 3-4 Data Transmission and I/O Word Allocation.

3-5-2 Command Codes

Commands are all designated by 1-digit (0 to F) hexadecimal numbers. Other data shown in the I/O allocation is BCD (binary code decimal).

Command code	Function
0	Designated screen display (Screen numbers: 000 to 999 for NT600M; 000 to 250 for NT20M)
1	Designated screen display (Screen numbers: 1000 for NT600M; None for NT20M)
2	Numeral table setting (setting numeral table entry number)
3	Numeral table setting (writing positive number)
4	Numeral table setting (writing negative number)
5	String table setting (setting string table entry number)
6	String table setting (writing character string data)
7	Lamp/touch switch control (numeral setting)
8	Lamp control (bit setting)
9	Not used.
A	Screen number request
B	Not used.
C	Copy memory table entry
D	System status control
E and F	Not used.

3-5-3 Designated Screen Display

A command code of 0 or 1 is used to display a designated screen. Command code "1" is valid only for the NT600M.

Word	15 to 12	11 to 08	07 to 04	03 to 00
n	Command code	Screen number (rightmost 3 digits)		
	0 or 1	N	N	N

NT20M

Command code "0" is used to display a designated screen. The screen number (001 to 250, BCD) is specified in the rightmost 3 digits. A screen number of 000 will clear the PT's display.

Data beyond DM word n is ignored.

Note Screen numbers higher than 250 will be ignored by the NT20M.

NT600M

Command code "0" is used to display a designated screen with a screen number from 000 to 999, BCD. The screen number is specified in the rightmost 3 digits. A screen number of 000 will clear the PT's display.

Command code "1" is used to display screen number 1000. The rightmost 3 digits should be set to 000.

Data beyond DM word n is ignored.

3-5-4 Numeral Table Settings

These commands are used to write 2 words of data to the specified numeral table entry. A command code of 2 is used to specify the table entry and then a command code of 3 (for positive numbers) or a command code of 4 (for negative numbers) is used to write the new data to the specified entry.

Designating the Numeral Table Entry Number

A command code of 2 is used to designate the entry number in the numeral table to which new data will be written.

Word	15 to 12	11 to 08	07 to 04	03 to 00
n	Command code	Numeral table entry number		
	2	N	N	N

Numeral table entry numbers are designated in 3-digit BCD (000 to 127 for the NT20M, and 000 to 255 for the NT600M). The designated number is valid until again designated with a command code 2. When power is first turned on, 0 is set as the default.

Data outside of word n is ignored.

Writing Positive Numbers

A command code of 3 is used to write a positive number to the numeral table entry that has been designated under command code 2. Each numeral table entry contains 8 digits, but only 4 digits can be transferred from the PC to the PT at a time.

Word	15 to 12	11 to 08	07 to 04	03 to 00
n	Command code	Not used.		Digit setting
	3	x	x	D
n + 1	Numeric data			
	N	N	N	N

Note Data in the area marked by x will be ignored at the PT.

Digits are designated by a 1-digit BCD number (1 to 8): the 1's digit is designated by 1, the 10's digit by 2, the 100's digit by 3, etc., as shown below.

Table entry digit	8	7	6	5	4	3	2	1
Value	10 ⁷	10 ⁶	10 ⁵	10 ⁴	10 ³	10 ²	10 ¹	10 ⁰

The numeric data is written in 4-digit BCD (0000 to 9999). The digit setting "D" specifies the first digit to which data will be written. For example, set D=1 to overwrite digits 1 through 4; set D=5 to overwrite digits 5 through 8.

In the following example, the number "0728" is written to digits 1 through 4.

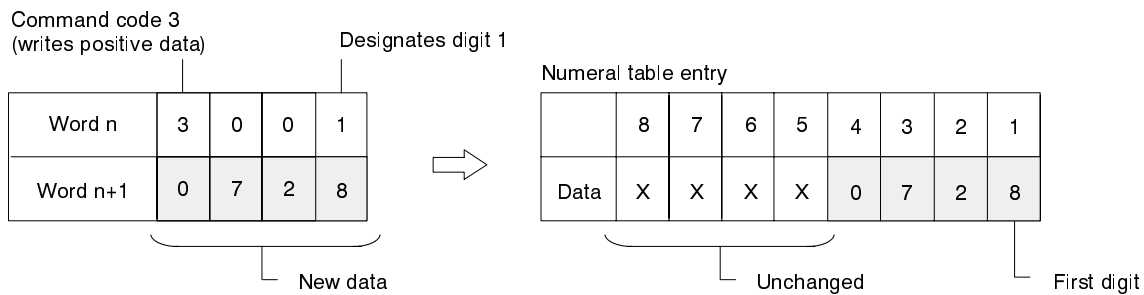

Writing Negative Numbers

A command code of 4 is used to write a negative number to the numeral table entry that has been designated under command code 2.

Word	15 to 12	11 to 08	07 to 04	03 to 00
n	Command code	Not used.		Digit setting
	4	x	x	D
n + 1	Numeric data			
	N	N	N	N

Note Data in the area marked by x will be ignored at the PT.

Negative numbers are written in the same way as positive numbers (just the command code is different). For details, refer to the preceding explanation under the heading *Writing Positive Numbers*.

3-5-5 String Table Settings

These commands are used to write 1 word of character string data to the specified string table entry. A command code of 5 is used to specify the table entry and then a command code of 6 is used to specify the string location and write the new data.

Designating the String Table Entry Number

A command code of 5 is used to designate the table entry that is to be written to using the next string write command (command code 6).

Word	15 to 12	11 to 08	07 to 04	03 to 00
n	Command code	String table entry number		
	5	N	N	N

String table entry numbers are designated in 3 digits of BCD (000 to 031 for the NT20M, and 000 to 255 for the NT600M). The designated number is valid until again designated with a command code 5. When power is first turned on, 0 is set as the default.

Data beyond word n is ignored.

Writing Character String

A command code of 6 is used to write 2 characters to the string table entry that has been designated under command code 5.

Word	15 to 12	11 to 08	07 to 04	03 to 00
n	Command code	Not used.	Character string position	
	6	x	D	D
n + 1	Character data 1		Character data 2	
	C1	C1	C2	C2

Note Data in the area marked by x will be ignored at the PT.

Character positions are designated by 2-digit BCD numbers (01 to 40 for the NT600M, and 01 to 32 for the NT20M). Designate the first character as 1, the next as 2, and so on. Refer to the appendices for character codes.

Character data is given in ASCII (half-size or normal characters).

If 00 is given as character data, data from that point on will be ignored.

Example: Writing "OMRON PC" to String Table Entry 3

Order	Word	Data	Meaning
1	n n + 1	5003 xxxx	Designates string table no. 3. Not used.
2	n n + 1	6x01 4F4D	Designates 1st position. "OM"
3	n n + 1	6x03 524F	Designates 3rd position. "RO"
4	n n + 1	6x05 4E20	Designates 5th position. "N "
5	n n + 1	6x07 5043	Designated 7th position. "PC"

3-5-6 Lamp and Touch Switch Display Control

Two commands can be used to control lamps and touch switches. With command code 7, any single lamp or touch switch (000 to 255) can be set to be off, to light, or to blink. With command code 8, the ON/OFF status of 28 lamps and touch switches (000 to 011 and 016 to 031) can be set simultaneously.

**Numeral setting
(Command Code 7)**

Any single lamp or touch switch can be set to be off, to light, or to blink by using a command code of 7. Lamp and touch switch numbers are designated by 3-digit BCD numbers (N: 000 to 255).

Word	15 to 12	11 to 08	07 to 04	03 to 00
n	Command code	Function code	Not used.	
	7	m	x	x
n + 1	Not used.	Lamp/switch number		
	x	N	N	N

Note Data in the areas marked by x will be ignored at the PT.

The function code “m” determines whether the designated lamp or touch switch will be set to on, off, or blink, as shown in the following table. If m=3, all lamps and touch switches will be turned off. Codes 4 to 9 are ignored.

Function code (m)	Lamp status	Touch switch status
0	OFF	OFF
1	ON	ON
2	Blinking	ON
3	All OFF	All OFF
4 to 9	No effect	No effect

Note Lamps and touch switches 000 through 011 and 016 through 031 will blink if blinking is specified when setting the attributes.

The following diagram shows how long the lamps and touch switches are on and off when blinking.

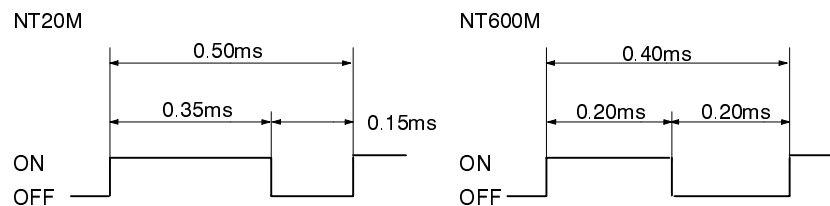

To stop the blinking, send another command with command code 7 and m=0. The lamp or touch switch will retain its ON or blinking status until a command with command code 7 and m=0 is received, even if the display is switched.

For lamps and touch switches 000 to 011 and 016 to 031, the display attributes setting will override the function code setting in the code 7 command.

The opposite is true for numbers 012 to 015 and 032 to 255, as shown in the following table.

Lamp number	Display attributes	Lamp status		
		With m=1 (ON)	With m=2 (Blink)	With m=0 (OFF)
000 to 011, 016 to 031	ON	ON	ON	OFF
	Blink	Blink	Blink	OFF
012 to 015, 032 to 255	ON	ON	Blink	OFF
	Blink	ON	Blink	OFF

**Bit Setting
(Command Code 8)**

The ON/OFF status of 28 lamps and touch switches (000 to 011 and 016 to 031) can be set simultaneously. These lamps and touch switches can also be set to be off or to light by using the lamp control bits shown on the next page.

When the bit for a lamp/touch switch number is turned ON, the corresponding lamp/touch switch is lit. When the bit is OFF, the lamp/touch switch is turned off. To cause a lamp/touch switch to blink, use the program at the PC to turn ON and OFF the bit corresponding to the lamp/touch switch you want to blink.

Word	15 to 12	11 to 08	07 to 04	03 to 00
n	Command code	Lamp control bits (000 to 011)		
	8	N	N	N
n + 1	Lamp control bit (016 to 031)			
	N	N	N	N

The following table shows the correspondence between bits in word n and lamp/touch switch numbers. (Bits 12 to 15 contain command code 8.)

Bit	11	10	09	08	07	06	05	04	03	02	01	00
Lamp number	11	10	09	08	07	06	05	04	03	02	01	00

The following table shows the correspondence between bits in word n+1 and lamp/touch switch numbers.

Bit	15	14	13	12	11	10	09	08	07	06	05	04	03	02	01	00
Lamp number	31	30	29	28	27	26	25	24	23	22	21	20	19	18	17	16

3-5-7 Screen Number Request

This command (command code A) is used to determine which screen number is currently being displayed on the PT. Upon reception this command, the PT transmits the screen number to the host with the “screen number request response” command. Refer to 3-6-5 *Response to Screen Number Request* for details.

This command code can be used with the NT20M-SMR01-E and NT600M-SMR01-EV1 only.

There will not be a response from the PT if a system menu (including the maintenance menu) is displayed.

Word	15 to 12	11 to 08	07 to 04	03 to 00
n	Command code	Not used.		
	A	x	x	x

Note Data in the area marked by x will be ignored at the PT.

3-5-8 System Status Control

This command (command code D) is used to control the PT's operating status.

Word	15 to 12	11 to 08	07 to 04	03 to 00
n	Command code	Not used.		
	D	x	x	x
n + 1	Status control bits			
	N	N	x	x

Note Data in the areas marked "x" will be ignored.

Bits 10 through 15 of n+1 control various aspects of PT operation, as shown in the following table.

Bit	ON	OFF	Notes
00 to 09	Not used.	Not used.	---
10	Red backlight	White backlight	See note 1.
11	History initialization	Not used.	---
12	Intermittent buzzer ON	Intermittent buzzer OFF	See note 2.
13	Continuous buzzer ON	Continuous buzzer OFF	See note 2.
14	Alarm output ON	Alarm output OFF	---
15	Backlight ON	Backlight OFF	---

Note 1. Red/white backlight selection is valid for the NT20M-DT131/DN131 only.

Bit 10 status	Bit 15 status	Backlight
OFF	ON	White
ON	ON	Red
OFF or ON	OFF	Backlight off

2. A continuous buzzer will be produced if both intermittent buzzer and continuous buzzer are designated.

History Initialization

The PT can save and display the order or frequency of occurrence of screen displays. This control bit initializes (clears) the display history that has been recorded in the PT.

The display history data can also be cleared by selecting "Init. Hist" from the PT's Maintenance Mode Menu. Refer to the PT's *Operation Manual* for details.

Buzzer Operation

The intermittent buzzer sounds at 0.5 s intervals. It can be stopped by turning off bit 12 of n+1 or pressing the PT's buzzer key. The continuous buzzer can be stopped by turning off bit 13 of n+1 or pressing the PT's buzzer key.

Alarm Output

The ALM OUTPUT terminal, located in the terminal block on the rear panel of the PT, can be turned ON and OFF from the PC.

Backlight Operation

The backlight can be set to turn off automatically after 10 min. or 1 hr. (or remain on indefinitely) from the PT's System Menu. Refer to the PT's *Operation Manual* for details.

The PT's backlight can be turned on and off from the PC freely, regardless of the settings on the PT itself.

Red/white backlight selection is valid for the NT20M-DT131/DN131 only.

3-5-9 Copy Memory Table Entry

This command (command code C) is used to copy the contents of a memory table entry (numeral or string) to another entry. The contents of the source table entry remain unchanged.

The numbers of the source and destination memory table entries are specified in 3-digit BCD, as shown in the following table. String table entry numbers can be 000 to 031 for the NT20M or 000 to 255 for the NT600M. Numeral table entry numbers can be 000 to 127 for the NT20M or 000 to 255 for the NT600M.

Word	15 to 12	11 to 08	07 to 04	03 to 00
n	Command code	Source table entry number		
	C	N	N	N
n + 1	Sub-code	Destination table entry number		
	m (0 or 1)	N	N	N

The sub-code “m” determines whether the table entry is a string or numeral table entry. Set m=0 to indicate a string table entry; set m=1 to indicate a numeral table entry. The command will be ignored if m does not equal 0 or 1.

3-6 PT-to-PC Commands

3-6-1 I/O Allocations

Of the four words allocated to each Host Interface Unit, words n and n+1 are used for output and n+2 and n+3 are used for input, as shown below. For switch setting instructions, refer to 3-2 *Specifications and Switch Settings*. For details on PC word allocations, refer to 3-4 *Data Transmission and I/O Word Allocation*.

3-6-2 Command Codes

Commands are all designated by 1-digit (0 to F) hexadecimal numbers. Other data shown in the I/O allocation is BCD (binary code decimal).

Command code	Function
0 to 1	Not used.
2	Numeral table setting (setting numeral table entry number)
3	Numeral editing input (writing positive numbers)
4	Numeral editing input (writing negative numbers)
5 to 7	Not used.
8	Response to screen number request
9	Touch switch input (numeral setting)
A	Touch switch input (bit setting)
B	Function key input (numeral setting)
C	Function key input (bit setting)
D to F	Not used.

3-6-3 PT Status Flags

The PT status flags (bits 12 to 15 of word n+2) provide information on the operating status of the PT, as shown in the following table. This data is transmitted to the PC when a PT-to-PC command is executed.

Bit	Name	Function
12	Strobe	Sets the timing for data transmissions from the PT to the PC. For details, see 3-2-3 <i>Switch Settings</i> . Data should be input to words n+2 and n+3 when this bit goes from OFF to ON.
13	BAT LOW	ON when the PT's battery voltage drops. Replace the battery within 5 days after this bit goes ON.
14	BUSY	ON when data cannot be output from the PC to the PT.
15	PT RUN	ON when the PT is in RUN mode.

Allow the following amount of time when using the BUSY flag to control transmissions. ($T_{RT} = 1.4 \text{ ms} + (n \times 0.2 \text{ ms})$, where n is the total number of I/O words on other Slaves.)

$$PC \text{ scan time} + (\text{Number of PTs} \times 8 \text{ ms}) + T_{RT}$$

3-6-4 Numeral Table Editing

These commands are used to transmit numeral table data to the PC. Command code 2 is used to specify the table entry and then a command code of 3 (for positive numbers) or a command code of 4 (for negative numbers) is used to write the new data to the specified entry.

The numeral table data is input at the PT using touch keys or function keys while the numeral setting screen is being displayed. When the data is set at the PT and the return key is pressed, then the numeral table entry number and numeric data are transmitted to n+2 and n+3 in the PC.

In the following example, 327219 is transmitted to a numeral table entry.

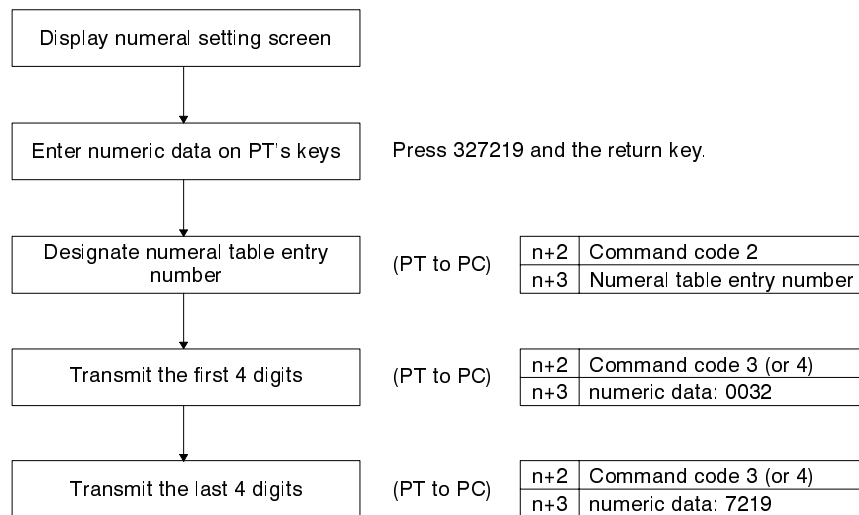

Each command and its accompanying data will be transmitted on the rising edge of the strobe signal.

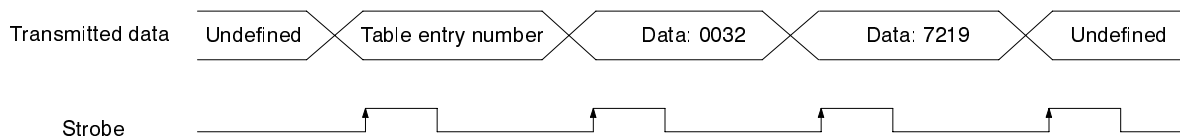

Up to 4 digits of numeric data can be transmitted at one time, so if 5 or more digits of data are being transmitted they must be divided into two parts.

Designating the Numeral Table Entry Number

A command code of 2 is used to designate the entry number in the numeral table provided in the next input command (command code 3 or 4).

Word	15 to 12	11 to 08	07 to 04	03 to 00
n + 2	PT status	Command code	Not used.	
	?	2	0	0
n + 3	Not used.	Table entry number (3-digit BCD)		
	0	N	N	N

Note The question mark (?) indicates change according to the status of the PT. Numeral table entry numbers are designated in 3 digits of BCD (000 to 127 for the NT20M, and 000 to 255 for the NT600M).

Writing Positive Numbers

A command code of 3 is used to transmit positive numbers to the table entry in the PC designated in the last command code 2 transmission.

Word	15 to 12	11 to 08	07 to 04	03 to 00
n + 2	PT status	Command code	Not used.	Digit setting
	?	3	0	D
n + 3	Numeric data			
	N	N	N	N

Note The question mark (?) indicates change according to the status of the PT. Digits are designated by a 1-digit BCD number (1 to 8): the 1's digit is designated by 1, the 10's digit by 2, the 100's digit by 3, etc., as shown below.

Table entry digit	8	7	6	5	4	3	2	1
Value	10 ⁷	10 ⁶	10 ⁵	10 ⁴	10 ³	10 ²	10 ¹	10 ⁰

The numeric data is written in 4-digit BCD (0000 to 9999). The digit setting "D" specifies the first digit to which data will be written. For example, set D=1 to overwrite digits 1 through 4; set D=5 to overwrite digits 5 through 8.

Note If the numeric data range has been set to 4 digits or less with the Support Tool, D cannot be set to 5.

Writing Negative Numbers

A command code of 4 is used to transmit negative numbers to the table entry in the PC designated in the last command code 2 transmission.

Word	15 to 12	11 to 08	07 to 04	03 to 00
n + 2	PT status	Command code	Not used.	Digit setting
	?	4	0	D
n + 3	Numeric data			
	N	N	N	N

Note The question mark (?) indicates change according to the status of the PT. Negative numbers are written in the same way as positive numbers (just the command code is different). For details, refer to the preceding explanation under the heading *Writing Positive Numbers*.

3-6-5 Response to Screen Number Request

When a "screen number request" command (command code A) is received from the PC, the PT uses this command (command code 8) to transmit the

number of the screen being displayed back to the PC. This command uses a “stand alone” function and will automatically transmit the screen number even when the screen was switched.

Word	15 to 12	11 to 08	07 to 04	03 to 00
n + 8	PT status	Command code	Not used	
	?	8	x	x
n + 9	Screen number			
	N	N	N	N

- Note**
1. The question mark (?) indicates variable data representing PT status.
 2. Refer to 3-5-7 *Screen Number Request* for details on that command.

3-6-6 Touch Switch Input

Numeral Input (Command Code 9)

If the Support Tool has been used to disable the “Bit Input” setting in the screen attributes, this command is automatically transmitted to the PC when a touch switch is input during operation.

The touch switch number will be transmitted to the PC when the status changes from OFF to ON. There will be no transmission when the status changes from ON to OFF. (In other words, the command is issued only when a touch switch is pressed, and there is no indication of when it is released.)

Word	15 to 12	11 to 08	07 to 04	03 to 00
n + 2	PT status	Command code	Not used.	
	?	9	x	x
n + 3	Not used.		Touch switch number	
	x	N	N	N

- Note** The question mark (?) indicates change according to the status of the PT. Data in the areas marked by x will be ignored.

Touch switch numbers are designated by 3-digit BCD numbers (000 to 255).

Bit Input (Command Code A)

If the Support Tool has been used to enable the “Bit Input” setting and the inputs have been set for touch switches in the screen attributes, this command is automatically transmitted to the PC when a touch switch is input during operation.

Unlike the numeral input (command code 9), this command can indicate the input of several switch numbers and distinguish ON/OFF status, but only touch switch numbers 00 to 07 and 16 to 31 are indicated.

Word	15 to 12	11 to 08	07 to 04	03 to 00
n + 2	PT status	Command code	Touch switch status	
	?	A	0 to F	0 to F
n + 3	Touch switch status			
	0 to F	0 to F	0 to F	0 to F

- Note** The question mark (?) indicates change according to the status of the PT. Data in the areas marked by x is ignored.

An input will occur whenever there is a change in the status of the touch switch.

The following tables show the correspondence between touch switch numbers and the bits in words n+2 and n+3. The corresponding bit will be turned ON when the touch switch is input.

Bits in word n+2	15	14	13	12	11	10	09	08	07	06	05	04	03	02	01	00
Touch switch numbers	PT status flags				Command code A				07	06	05	04	03	02	01	00

Bits in word n+3	15	14	13	12	11	10	09	08	07	06	05	04	03	02	01	00
Touch switch numbers	31	30	29	28	27	26	25	24	23	22	21	20	19	18	17	16

3-6-7 Function Key Input

Numeral Input (Command Code B)

If the Support Tool has been used to disable the “Bit Input” setting in the screen attributes, this command is automatically transmitted to the PC when a function key is input during operation.

Word	15 to 12	11 to 08	07 to 04	03 to 00
n + 2	PT status	Command code	Not used.	
	?	B	x	x
n + 3	Not used.		Function key number	
	x	x	N	N

Note The question mark (?) indicates variable data representing PT status. Data in the areas marked by x is ignored.

The function key number will be transmitted to the PC one time in 2-digit BCD when the status changes from OFF to ON. There will be no transmission when the status changes from ON to OFF. Use bit input indication (command code C, below) when changes from ON to OFF must be detected.

There will be no indication when more than one key is pressed.

The function key numbers that will be transmitted depend on the PT model and Unit installed, as shown in the following table.

PT model	Unit installed	Function key numbers
NT600M-DF122	---	00 through 11
NT20M-DN131/DN121, NT600M-DN211	12-key Function Key Unit	00 through 11

Bit Input (Command Code C)

If the Support Tool has been used to enable the “Bit Input” setting and the inputs have been set for function keys in the screen attributes, this command is automatically transmitted to the PC when a function key is input (or a input goes off) during operation.

Unlike the numeral input (command code B), this command can indicate the simultaneous input of several function keys and distinguish ON/OFF status, but only function key numbers 00 to 23 are indicated.

Word	15 to 12	11 to 08	07 to 04	03 to 00
n + 2	PT status	Command code	Function key status	
	?	C	0 to F	0 to F
n + 3	Function key status			
	0 to F	0 to F	0 to F	0 to F

Note The question mark (?) indicates change according to the status of the PT. Data in the areas marked by x is ignored.

The following tables show the correspondence between function key numbers and the bits in words n+2 and n+3. The corresponding bit will be turned ON when the function key is input.

Bits in word n+2	15	14	13	12	11	10	09	08	07	06	05	04	03	02	01	00
Function key numbers	PT status flags				Command code C				07	06	05	04	03	02	01	00

Bits in word n+3	15	14	13	12	11	10	09	08	07	06	05	04	03	02	01	00
Function key numbers	23	22	21	20	19	18	17	16	15	14	13	12	11	10	09	08

3-7 System Startup

3-7-1 Preliminary Procedures

The following flowchart shows the procedures to be performed before system startup, such as writing screen data with the Support Tool, transferring it to the PT, and writing the PC program. It is recommended to perform these procedures as shown in the flowchart.

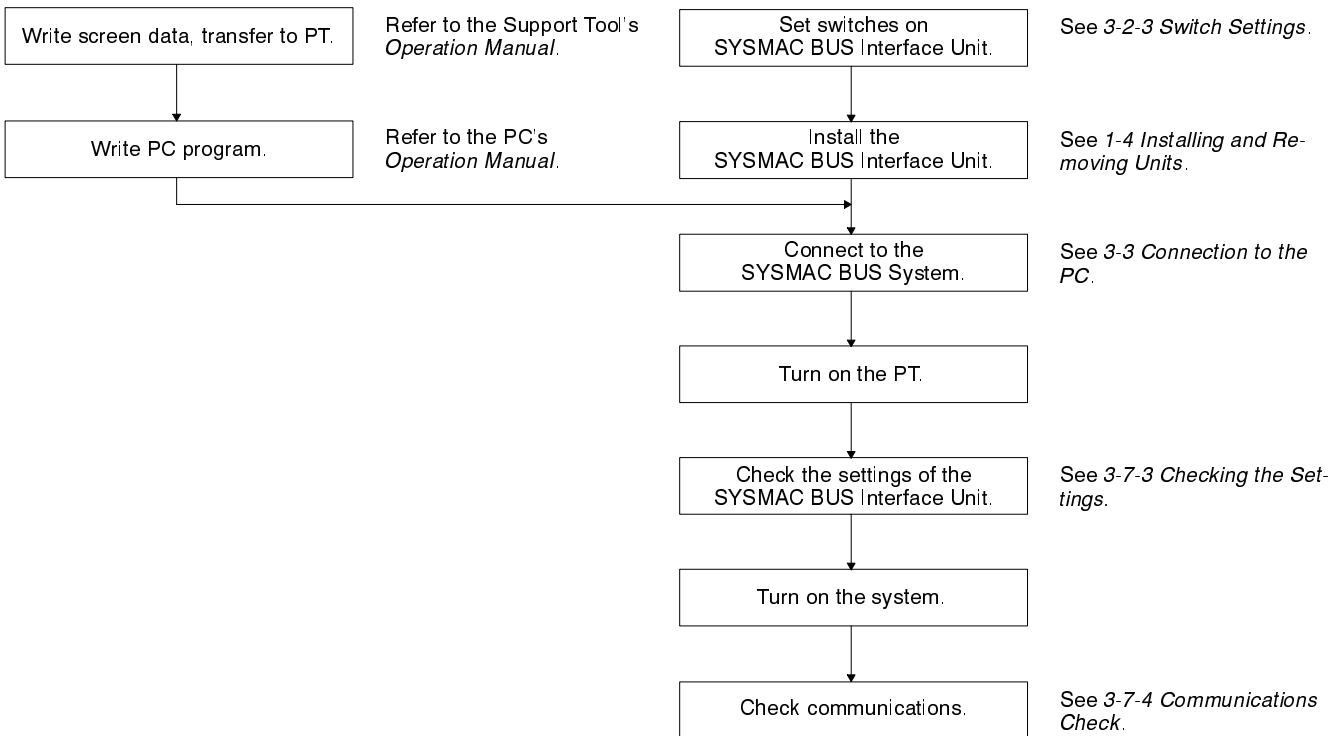

3-7-2 SYSMAC BUS Remote I/O System Startup

The following flowcharts show the procedure to be performed when first starting up the system and for normal operation. Refer to the *SYSMAC BUS Remote I/O System Manual* for details.

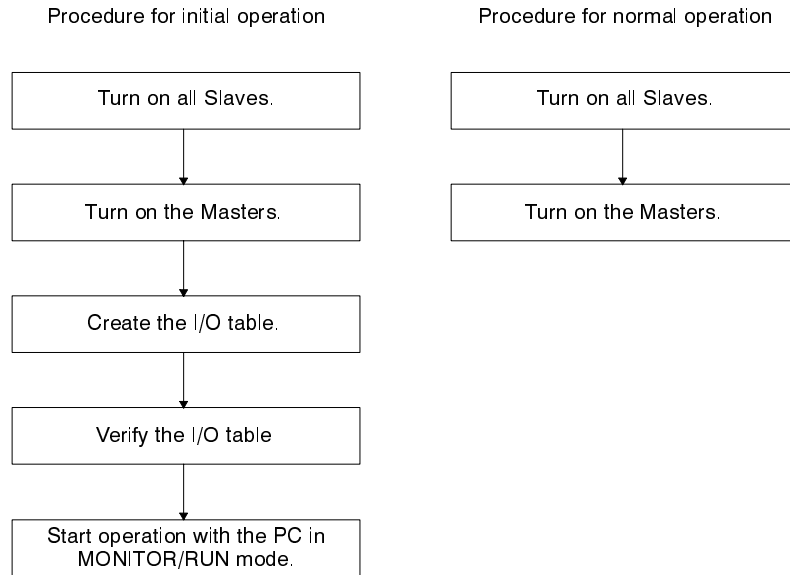

3-7-3 Checking the Settings

The SYSMAC BUS Interface Unit's settings can be checked on the PT's screen from the PT's System Menu. Follow the procedure listed below to check the settings.

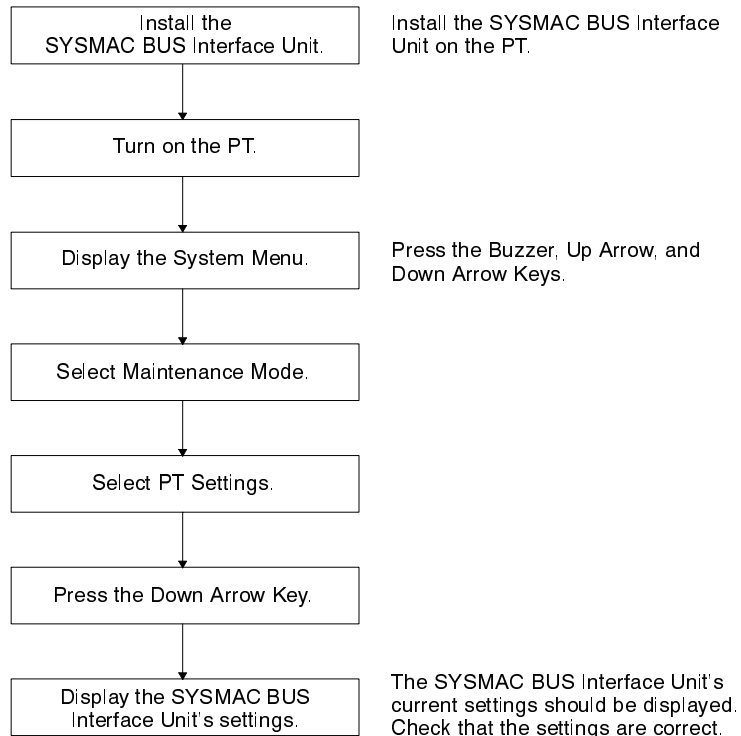

Note To return to RUN mode, press the Buzzer Key, Up Arrow Key, and Down Arrow Key simultaneously.

3-7-4 Communications Check

Communications between the PT and PC can be checked from the PT's System Menu.

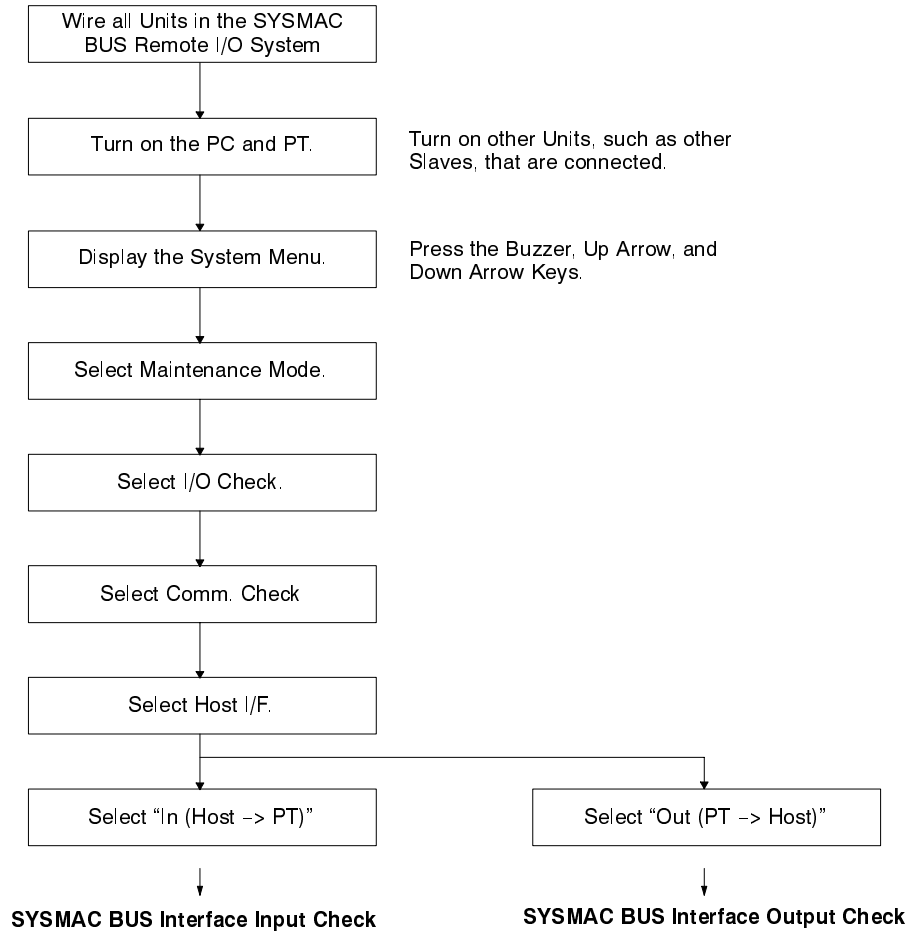

SYSMAC BUS Interface Input Check

Inputs that are ON are indicated by inverted displays.

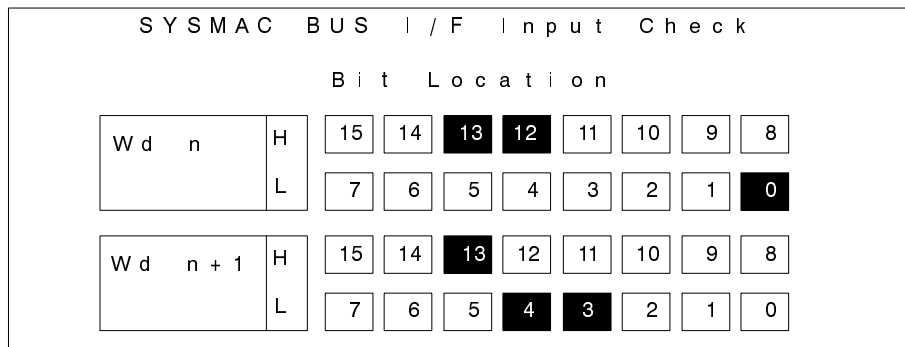

SYSMAC BUS Interface Output Check

As the Up and Down Arrow Keys are used to move the reverse video display location, the corresponding bits in words n+2 and n+3 will be turned on one at a time.

The Up Arrow Key will move the position upward through the bits in n+2 and n+3, and the Down Arrow Key will move the position downward through the bits in n+3 and n+2.

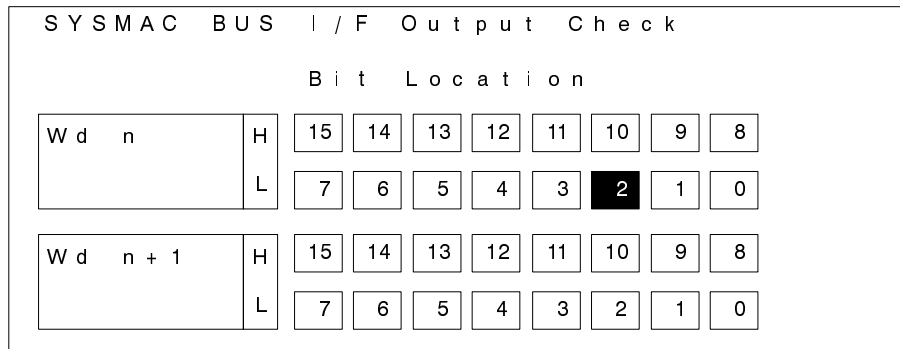

Note In the output check screen, Wd n refers to n+2 and Wd n+1 refers to n+3.

3-8 Transfer Time

The time required for communications in a SYSMAC BUS Wired Remote I/O System includes program execution in the PC and processing in the PT. The system's operation can be affected by the timing of program execution and communication with Slaves.

This section explains how to calculate the minimum and maximum I/O response times, i.e., the time from when a PT touch switch or function key is pressed until the new PT screen is displayed. Terms used in this section are defined below.

Cycle Time

Also called the scan time in C-series PCs, the cycle time is the time required to complete one cycle of CPU processing. The main CPU processes are hardware checks, program execution, and I/O refreshing.

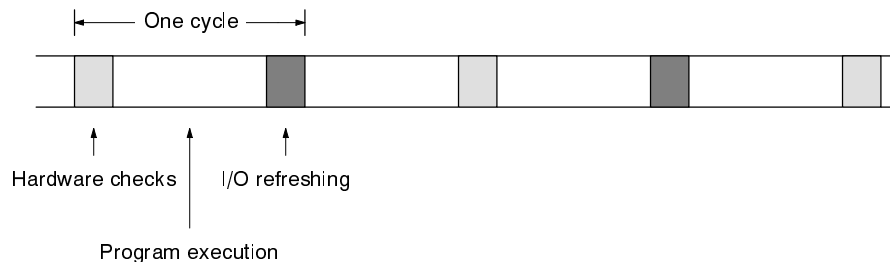

I/O Refreshing

I/O refreshing is the CPU process of updating output status sent to external devices so that it agrees with the status of output bits held in memory and of updating input bits in memory so that they agree with the status of inputs from external devices.

Input ON Delay

This is the total time from the point when the PT's touch switch or function key is pressed until the SYSMAC BUS Interface Unit is capable of transmitting. (Approximately 120 ms.)

Output ON Delay

This is the total time from the point when the PT receives a command until it is executed. For a screen change command, this is the time until the screen change is completed. The output ON delay depends upon the information being displayed, but use 300 ms as a target value.

Master Transfer Time (T_{RM})

This is the total time required for a Master to communicate with all of the Slaves connected to it (Slave Units and Racks). This time depends on the number of Slaves and the number of I/O words on those Slaves.

3-8-1 C200H Example

In the C200H, program execution is synchronized with the Master's transfer processing. The Master's transfer processing is started after the CPU's I/O refreshing and Remote I/O refreshing are completed.

These equations apply when the scan time is longer than master transfer time (T_{RM}). The values in the following table are used in the calculations:

Item	Time
C200H scan time	20 ms
Input ON delay	120 ms
Output ON delay	300 ms
Master transfer time	0 ms

Programming Example

In the following program section, touch switch 000 is pressed and screen number 000 is displayed.

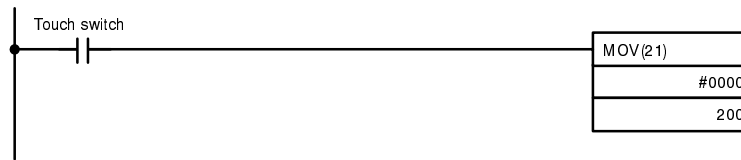

Min. I/O Response Time

Minimum I/O response time
 = input ON delay + (scan time × 3) + T_{RM} + output ON delay
 = 120 ms + 20 ms × 3 + 0 ms + 300 ms = 480 ms

Max. I/O Response Time

Maximum I/O response time
 = input ON delay + (scan time × 4) + T_{RM} + output ON delay
 = 120 ms + 20 ms × 4 + 0 ms + 300 ms = 500 ms

3-8-2 C500 Example

In the C500 Remote I/O System, program execution is not synchronized with the Master's transfer processing, so there is a 1 scan offset between I/O refreshing and the Master's transfer processing. The Master's transfer processing time also varies with the number of Slaves and the number of I/O words on those Slaves, so the total difference between the minimum and maximum I/O response times is one scan plus the Master's transfer processing time.

These equations apply when the scan time is longer than master transfer time (T_{RM}). The values in the following table are used in the calculations:

Item	Time
C500 scan time	20 ms
Input ON delay	120 ms
Output ON delay	300 ms
Master transfer time (T_{RM})	8 ms
SYSMAC BUS Interface Unit transfer time (T_{TT})	8 ms per Unit

Programming Example

In the following program section, touch switch 000 is pressed and screen number 000 is displayed.

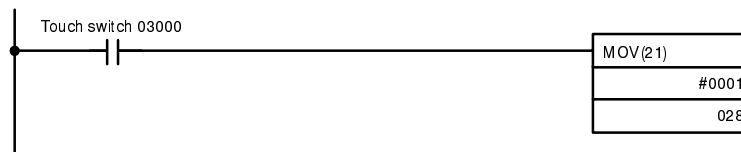

Min. I/O Response Time Minimum I/O response time
 = input ON delay + scan time + T_{RM} + output ON delay
 = 120 ms + 20 ms + 8 ms + 300 ms = 448 ms

Max. I/O Response Time Maximum I/O response time
 = input ON delay + (scan time \times 2) + $T_{RM} \times 2$ + T_{TT} + output ON delay
 = 120 ms + 20 ms \times 2 + 8 ms \times 2 + 8 ms + 300 ms = 484 ms

Note T_{TT} = SYSMAC BUS Interface Unit transfer time

Transmission Errors The above calculations apply to cases where there is no remote I/O errors (including power failure). If a remote I/O error occurs, the total transfer time will be extended by approximately 5 ms for each Host Interface Unit, due to the retry processing.

3-8-3 C1000H/C2000H Example

In the C1000H/C2000H PCs, there are 2 CPUs. One executes the program and the other controls the Master's transfer processing. These 2 CPUs are synchronized, so the required processing time is 1 scan longer than it is in the C500.

These equations apply when the scan time is longer than master transfer time (T_{RM}). The values in the following table are used in the calculations:

Item	Time
C1000H/C2000H scan time	20 ms
Input ON delay	120 ms
Output ON delay	300 ms
Master transfer time (T_{RM})	8 ms
SYSMAC BUS Interface Unit transfer time (T_{TT})	8 ms per Unit

Min. I/O Response Time Minimum I/O response time
 = input ON delay + (scan time \times 2) + T_{RM} + output ON delay
 = 120 ms + 20 ms \times 2 + 8 ms + 300 ms = 468 ms

Max. I/O Response Time Maximum I/O response time
 = input ON delay + (scan time \times 3) + $T_{RM} \times 2$ + T_{TT} + output ON delay
 = 120 ms + 20 ms \times 2 + 8 ms \times 3 + 8 ms + 300 ms = 504 ms

Note T_{TT} = SYSMAC BUS Interface Unit transfer time

3-9 Communications Errors

If a communications error occurs, the host error screen will be displayed on the PT's screen.

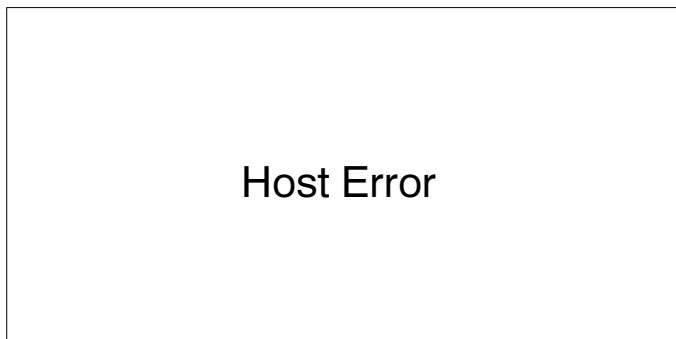

Depending on the error, however, error screens might not be displayed if pin 1 of SW1 on the PT is OFF.

3-9-1 Processing Communications Errors

Automatic Reset

When pin 1 of SW1 on the PT is OFF, communication errors are reset automatically.

The following table shows the internal processing that will be executed when a communications error (buffer overflow) occurs.

SW1 pin 1 setting	Internal PT process				Remedy
	Command execution?	Error display?	Buzzer sound?	Continued operation?	
ON	The command that caused the buffer overflow will not be executed.	Yes	Yes	Subsequent commands will not be executed.	Press the Buzzer Key or Return Key to return to RUN mode. (See note.)
OFF		No	No	Subsequent commands will be executed.	(See note.)

Note When errors such as this occur, check whether the PT is BUSY or not and change the program so that the command can be transmitted.

Initialization Errors

The following table shows errors that occur at the start of operation.

Programming Console display	Master LEDs				I/F Unit LEDs		Error and possible correction
	T/R ERR	TEST OK	END RS CHK	LINE ERR	RUN	T/R ERR	
CPU waiting	Flashing	Not lit	Lit	Not lit	Not lit	Lit	No terminator is designated. Designate the Unit furthest from the Master as the terminator.
						Not lit	The transmission line is interrupted or erroneously wired. Correctly wire the transmission line.
							The total number of points on Slaves connected to the Master exceeds the maximum limit. Reduce the number of points to an acceptable level.
	Flashing	Not lit	Flashing	Not lit	Not lit	Lit	More than one terminator is designated. Designate only the Unit furthest from the Master as the terminator.
CPU waiting Remote I/O error	Flashing/Lit	Not lit	Not lit	Not lit	Not lit	Lit	The transmission line is short-circuited. Correctly wire the transmission line.
						Lit	The same word is set for a Slave. Set the words with no overlapping.

Programming Console display	Master LEDs				I/F Unit LEDs		Error and possible correction
	T/R ERR	TEST OK	END RS CHK	LINE ERR	RUN	T/R ERR	
Remote I/O error I/O verification error	Not lit	Not lit	Not lit	Not lit	Not lit	Lit	The Master is malfunctioning. Replace the Master.
I/O verification error	Not lit	Not lit	Not lit	Not lit	Not lit	Lit	No I/O table is created (not necessary in the C200H) or the I/O table is wrong. For several seconds the Master's T/R ERR indicator flashes and the END RS CHK indicator stays lit, then all indicators go out. Verify the I/O tables at the PC. If there is no problem, then create an I/O table. If the I/O table verification matches, then check the Slaves other than the terminator.

Operating Errors

The following table shows errors that can occur during operation.

Programming Console display	Master LEDs				I/F Unit LEDs		Error and possible correction
	T/R ERR	TEST OK	END RS CHK	LINE ERR	RUN	T/R ERR	
Remote I/O error	Lit	Not lit	Lit	Not lit	Not lit	Lit	The transmission line is interrupted or erroneously wired. Correctly wire the transmission line.
	Lit	Not lit	---	Lit	Not lit	Lit	The transmission line is short-circuited. Correctly wire the transmission line.
	Lit	Not lit	Not lit	Not lit	Not lit	Not lit	The I/F Unit is malfunctioning. Replace the I/F Unit.
	Not lit	Not lit	Not lit	Not lit	Not lit	Lit	The Master is malfunctioning. Replace the Master.
	Lit	---	---	Not lit	Not lit	Not lit	The PT's power is out. Turn the power on again at the I/F Unit.
I/O verification error	Flashing	Not lit	Not lit	Not lit	Not lit	---	I/F Units have been removed and added or word settings for the PC and the I/F Unit overlap. Verify the I/O table at the PC, and reset it.

- Note**
1. A (–) mark indicates that the status of the indicator makes no difference.
 2. If a malfunction occurs which is not covered in this table, check the PT's operation by connecting it to the Master alone (through a SYSMAC BUS Interface Unit).

3-9-2 Troubleshooting

With some errors, the Unit's status cannot be checked with the PT's maintenance mode. The following table provides possible causes and possible remedies for these errors.

Symptom	Probable cause	Possible remedy
No display on screen	Waiting for command from PC or there is no screen data.	Issue a command from the PC. Record screen data with Support Tool.
	Screen number 0 is being displayed.	There is no error. Display a screen that has screen data.
Cannot transmit from SYSMAC BUS Interface Unit	The timing signal for transmission with the Interface Unit has not been detected.	Check the switch settings and the Interface Unit's strobe time. Check communications in maintenance mode.
Display indicates no SYSMAC BUS Interface Unit	Interface Unit is not connected.	Connect SYSMAC BUS Interface Unit.
The PT's "RUN LED" is not lit during operation and the buzzer sounds continuously.	PT is running uncontrolled or external noise is affecting PT.	Install the connecting cables away from high voltage lines or equipment that generates noise. Also install noise filters in power supply lines.
	System ROM installed incorrectly.	Install the System ROM correctly and be sure that it is fastened securely.

SECTION 4

C200H Interface Unit

This section covers the hardware and commands for the NT20M-LB121-V2 and NT600M-LB121 C200H Interface Units. Except where a distinction needs to be made, both of these Units will be referred to simply as the (C200H) Interface Units.

4-1	Features and System Configuration	68
4-1-1	Features	68
4-1-2	System ROM and Compatible PTs	68
4-1-3	System Configuration	69
4-2	Specifications and Switch Settings	69
4-2-1	Components	69
4-2-2	Interface Unit Switch Settings	69
4-2-3	PT Switch Settings	72
4-2-4	Connector Shape and Connection Method	72
4-2-5	Checking PT Settings	75
4-2-6	Precautions when Turning Power On or Off	75
4-3	DM Word Allocation	76
4-3-1	PC-to-PT Communications	77
4-3-2	PT-to-PC Communications	78
4-3-3	Numeral and String Tables	78
4-4	PC-to-PT Commands	80
4-4-1	Interchanging SYSMAC WAY and C200H Programs	81
4-4-2	Designated Screen Display	82
4-4-3	Numeral Table Settings	82
4-4-4	String Table Settings	83
4-4-5	Writing Character String	84
4-4-6	Lamp and Touch Switch Display Control	84
4-4-7	Screen Number Request	86
4-4-8	Copy Memory Table Entry	86
4-4-9	System Status Control	87
4-5	PT-to-PC Commands	87
4-5-1	Interchanging SYSMAC WAY and C200H Programs	88
4-5-2	PT Status Flags	89
4-5-3	Touch Switch Input	90
4-5-4	Function Key Input	91
4-5-5	Numeral Table Editing	91
4-5-6	Response to Screen Number Request	93
4-6	Communications Check	93
4-7	Communications Errors	94
4-7-1	Processing Communications Errors	95
4-7-2	Troubleshooting	95
4-8	Connection to Mini H-type PCs	96
4-8-1	System Configuration	96
4-8-2	Connections	96
4-8-3	Unit Number Settings	97
4-8-4	System Settings	97

4-1 Features and System Configuration

4-1-1 Features

The C200H Interface Units (NT600M-LB121) are used to enable the PT to communicate with C200H and Mini H-type PCs. The interface connection can be made simply by connecting the Interface Unit to a CPU Rack.

Note Refer to *4-8 Connection to Mini H-type PCs* for details on using the C200H Interface Units with Mini H-type PCs.

C200H Interface Units are classified as C200H Special I/O Units, but have the functions of an Expansion I/O Rack as well as those of a Special I/O Unit. Communications with the C200H are carried out through the PC's DM Area, so a special communications sub-program is not required.

The following diagram shows the breakdown of the Interface Unit's functions.

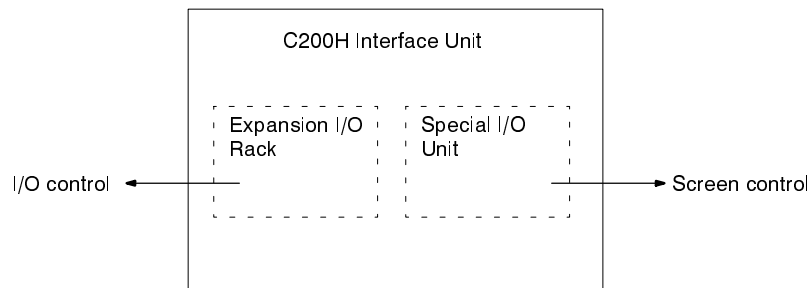

C200H Interface Units have the following limitations:

- 1, 2, 3...**
1. C200H Interface Units cannot be connected to a Remote I/O Slave Rack.
 2. C200H Interface Units cannot be used with the C200H-CPU02/22 CPUs.
 3. Refer to *4-8 Connection to Mini H-type PCs* when connecting the C20H, C28H, C40H, or C60H.

4-1-2 System ROM and Compatible PTs

System ROM (sold separately) is required when using an NT600M-LB121 C200H Interface Unit. The following table shows the required System ROM as well as the PTs that are compatible with the NT600M-LB121.

The PT will not operate properly if combinations other than the ones shown below are used.

C200H Interface Unit	Compatible PTs	Required System ROM
NT600M-LB121	NT20M-DT121-V2, NT20M-DN121-V2 NT20M-DT131, NT20M-DN131	NT20M-SMR02-E
	NT600M-DT122/211, NT600M-DF122, NT600M-DN211	NT600M-SMR02-EV1

4-1-3 System Configuration

Connect the C200H Interface Unit to a CPU Rack or Expansion I/O Rack using an I/O Connecting Cable such as the C200H-CN221. The Interface Unit and Rack must be connected 1-to-1, as shown in the following diagram.

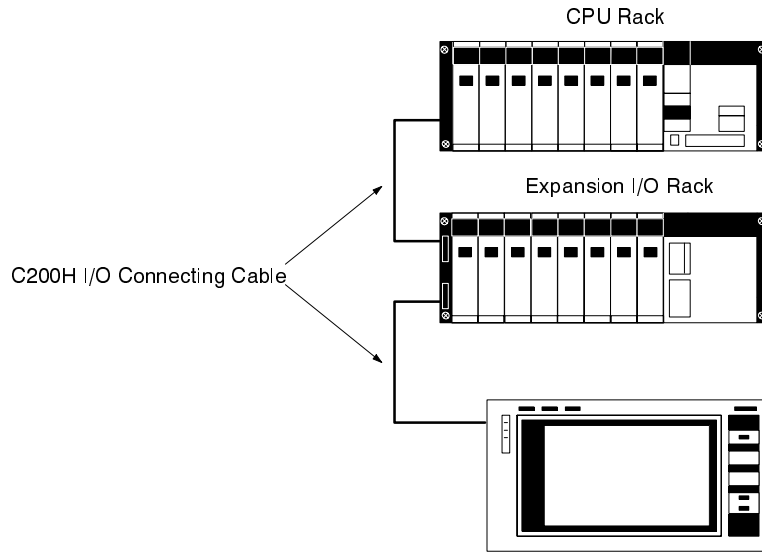

4-2 Specifications and Switch Settings

4-2-1 Components

The following diagram shows the major components of the Interface Unit that are used during operation.

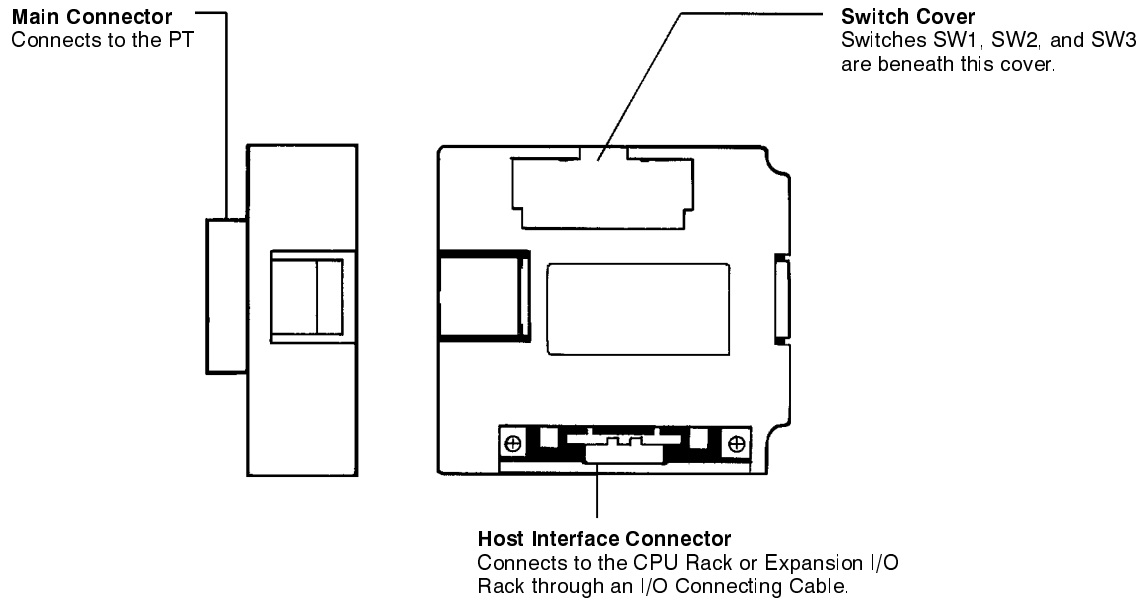

4-2-2 Interface Unit Switch Settings

DIP switches SW1 and SW2 are located under the back panel cover, along with rotary switch SW3. The two DIP switches are for settings such as the first word allocated to the Interface Unit, and the rotary switch is for setting the unit number.

Note Refer to 4-8 Connection to Mini H-type PCs for details on using the C200H Interface Units with Mini H-type PCs.

Unit Number (SW3)

Because the Interface Unit functions as a Special I/O Unit, it must be assigned a unit number. When setting the unit number with SW3, be careful not to set a number than has already been set for another Special I/O Unit.

The factory-set default setting is shown at the right.

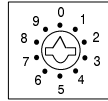

When the unit number has been set, the Special I/O Unit will be allocated the corresponding words in C200H memory, as shown in the following table. The words which are allocated to the Interface Unit, however, are not used because Interface Unit processing is handled in the DM area. The words allocated to the Interface Unit as a Special I/O Unit can therefore be used as work bits/words.

Unit	Words
0	100 to 109
1	110 to 119
2	120 to 129
3	130 to 139
4	140 to 149
5	150 to 159
6	160 to 169
7	170 to 179
8	180 to 189
9	190 to 199

Setting First Word and Memory Table Areas

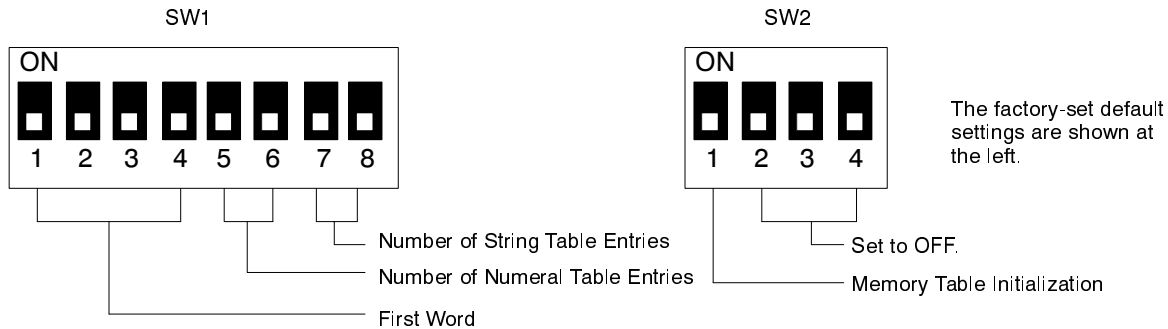

First Word (SW1)

All data transfers between the C200H Interface Unit and the C200H PC are executed using the C200H's DM area. The first word in the DM area is set with SW1. The Command area, the Bit Information area, and the Memory Table area are all allocated automatically from that first word onwards. For details on data memory arrangement, refer to 4-3 *DM Word Allocation*.

Pin 1	Pin 2	Pin 3	Pin 4	First word
OFF	OFF	OFF	OFF	DM 0000
ON	OFF	OFF	OFF	DM 0064
OFF	ON	OFF	OFF	DM 0128
ON	ON	OFF	OFF	DM 0192
OFF	OFF	ON	OFF	DM 0256
ON	OFF	ON	OFF	DM 0320
OFF	ON	ON	OFF	DM 0384
ON	ON	ON	OFF	DM 0448
OFF	OFF	OFF	ON	DM 0512
ON	OFF	OFF	ON	DM 0576
OFF	ON	OFF	ON	DM 0640
ON	ON	OFF	ON	DM 0704
OFF	OFF	ON	ON	DM 0768
ON	OFF	ON	ON	DM 0832
OFF	ON	ON	ON	DM 0896
ON	ON	ON	ON	Cannot be set.

Setting the Number of Numeral Table Entries

The Memory Table area for the C200H Interface Unit is allocated in the C200H DM area, just as for the SYSMAC WAY Interface Units (NT600M-LK201). Use pins 5 and 6 of SW1 to set the number of numeral table entries to 0, 32, 64, or 128, as shown in the following table.

Pin 5	Pin 6	No. of entries	Entry numbers
OFF	OFF	0	---
ON	OFF	32	00 to 31
OFF	ON	64	00 to 63
ON	ON	128	00 to 127

Each numeral table entry is stored in two DM words, and numeral table entries are allocated in order beginning with table no. 000.

Note In the NT600M-LK201, 256 numeral table entry numbers (000 to 256) can be used, but only 128 (000 to 127) can be stored in the C200H's DM Area.

Setting the Number of String Table Entries

The string table is set in the DM Area following the numeral table. Use pins 7 and 8 of SW1 to set the number of string table entries to 0, 8, 16, or 32, as shown in the following table.

Pin 7	Pin 8	No. of entries	Entry numbers
OFF	OFF	0	---
ON	OFF	8	00 to 07
OFF	ON	16	00 to 15
ON	ON	32	00 to 31

Each string table entry is allocated 20 DM words. Since the string table follows the numeral table, the first DM word allocated to the string table depends on the

size of the numeral table set with pins 5 and 6. Refer to 4-3 DM Word Allocation for details on the allocation of DM words to the string table.

- Note**
1. In the NT600M-LK201, 256 string table entry numbers (000 to 256) can be used, but only 32 (00 to 31) can be stored in the C200H's DM Area.
 2. When a C200H-CPU11-E is used as the CPU, DM 0969 through DM 0999 are reserved for system use and cannot be used for the string table.

Memory Table Initialization (SW2)

Pin 1 of SW2 determines whether the initial memory table values are taken from the PT (set from the Support Tool) or the the PC's DM Area.

For example, pin 1 would be turned OFF (DM Area value) when displaying the production quantity number on the PT's screen, so the previous production quantity would be displayed. Pin 1 would be turned ON (value set from Support Tool) to display the initial value.

Pin 1	Memory table initial value
OFF	Initial values from PT (set by the Support Tool)
ON	Initial values from PC's DM Area

4-2-3 PT Switch Settings

Pin 1 of DIP switch SW1 on the PT determines whether or not the PT will automatically reset when a communications error occurs.

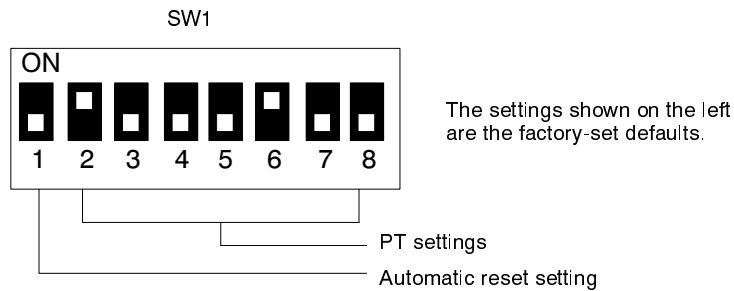

SW1 pin	Status	Function
1	ON	No automatic reset
	OFF	Automatic reset: When a communications error occurs, an error message will not be displayed and the PT will automatically return to RUN mode.
2 to 8	---	Refer to the PT's Operation Manual for details on these PT settings.

- Note** Refer to 4-7-1 Processing Communications Errors for more details on automatic reset after a communications error.

4-2-4 Connector Shape and Connection Method

Connector Shape

The connector for the Interface Unit has the same shape as the connectors for the C200H CPU Rack and Expansion I/O Rack.

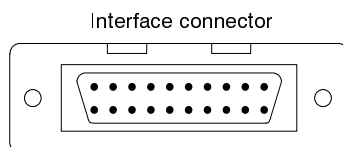

Connection Method

When connecting the C200H Interface Unit to a C200H PC, use C200H I/O connecting cable to connect the Unit directly to the CPU Rack or Expansion I/O

Rack connectors. You can connect the C200H Interface Unit to a single CPU Rack and a Expansion I/O Rack, as shown in the illustration below. If you use two Expansion I/O Racks, however, you cannot connect a C200H Interface Unit. The C200H Interface Unit has only one interface connector, and therefore cannot be connected between a CPU Rack and an Expansion I/O Rack. It must be connected as the last Rack in the PC System. In addition, the C200H Interface Unit cannot be connected to a Slave Rack. The maximum total cable length is 12 meters.

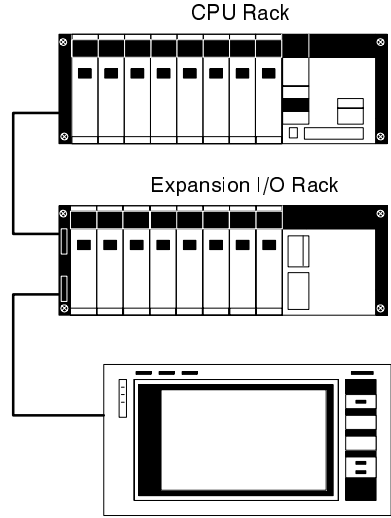
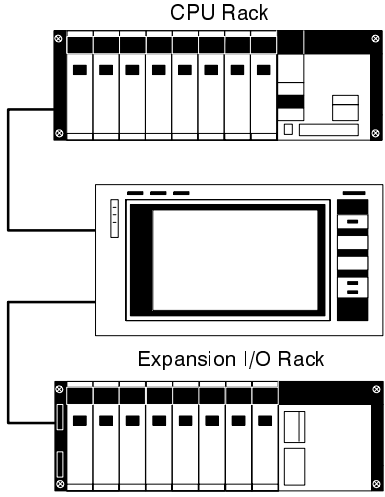
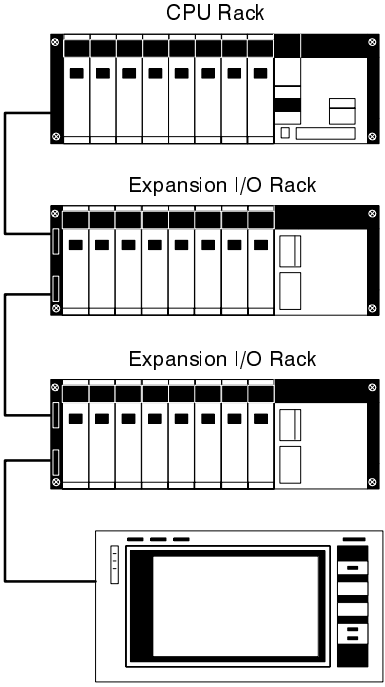
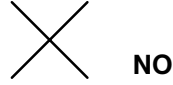
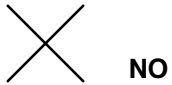

Use the I/O Connecting Cables shown in the following table. The maximum total length for all I/O Connecting Cables in the system is 12 m. Be sure to insert the connector carefully and secure it with screws.

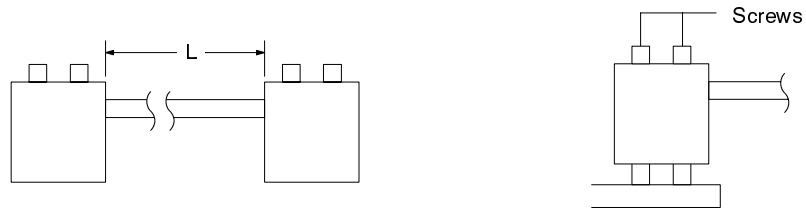

PC Model	Cable length (L)	Cable Model	
		Standard	Small Connector ¹
C200H	30 cm	C200H-CN311	---
	70 cm	C200H-CN711	NT20M-CNP711
	2 m	C200H-CN221	NT20M-CNP221
	5 m	C200H-CN521	NT20M-CNP521
	10 m	C200H-CN131	NT20M-CNP131
C20H/C28H/ C40H/C60H	30 cm	C20H-CN311	---
	70 cm	C20H-CN712	NT20M-CNP712
	2 m	C20H-CN222	NT20M-CNP222

- Note**
1. The connector that connects to the Interface Unit is small-sized (the same size as the one on the C200H-PRO27 Programming Console).
 2. When passing the I/O connecting cable through a hole, the hole must have a diameter of at least 53 mm. If the cover is removed, the cable can pass through a hole of 33 mm or larger, but be sure to replace the cover and secure it with the screws.
 3. The maximum tensile load for the cable is 5 kg. Do not place a load greater than 5 kg on the cable.

4-2-5 Checking PT Settings

You can check PT settings by using the PT's System Menu. For details, refer to the *NT600M* or *NT20M/NT2000M Operation Manual*.

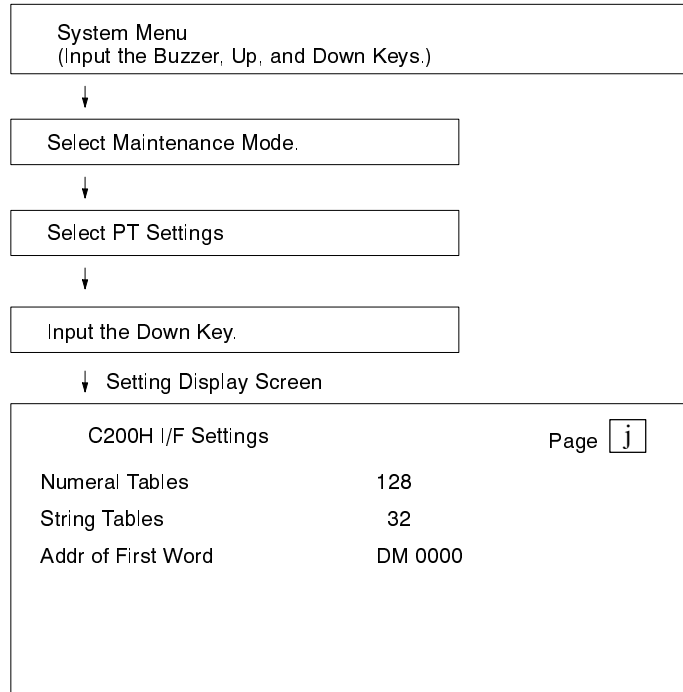

Note To return to Run Mode, press the Buzzer, Up, and Down Keys simultaneously.

4-2-6 Precautions when Turning Power On or Off

Because the Interface Unit performs the functions of an Expansion I/O Rack, you must exercise caution when turning the power on or off. In particular, be aware that if the power is turned off at a PT in which a C200H Interface Unit is mounted or an I/O connecting cable is removed while the PC System is in operation, the entire PC System will stop.

If an I/O connecting cable is removed while the System is in operation, an I/O bus error will be generated at the C200H PC and operation will stop. In order to restore operation, you must reinstall the cable and then clear the error.

Turning Power On

When first powering up the PT and then the C200H PC	When the PT is powered up, a message will appear on its screen indicating that the PT is connecting to the host. Then when the PC is powered up, that display will continue for approximately one second before normal operation begins (assuming that the PT is registered in the I/O table). Nothing will be displayed on the PT screen if you select PT Settings in Maintenance Mode and press the Down Key while power is turned off to the C200H PC and the "connecting to host" message is being displayed.
When first powering up the C200H PC and then the PT	When the PC is powered up, the C200H CPU will be reset and the Programming Console cannot be operated. Then when the PT is powered up, a message will appear on its screen for approximately one second indicating that the PT is connecting to the host. After that, normal operation will begin (given that the PT is registered in the I/O table).
When powering up the C200H PC and the PT simultaneously	A message will appear on the screen of the PT for several seconds indicating that the PT is connecting to the host. Then normal operation will begin.

Turning Power Off

When turning off power first at the PT and then at the C200H PC	When the power is turned off first at the PT, the C200H CPU will be reset and the Programming Console cannot be operated.
When turning off power first at the C200H PC and then at the PT	When the power is turned off first at the PC, the PC can no longer output commands. Therefore the screen displayed at the PT before turning off the power will remain.

Caution Always take safety into consideration before turning off the power. If a PT becomes defective and must be replaced, stop the PC System before replacing it. If you turn off power only to the PT, the PC System will momentarily stop and there will be a risk of an accident or damage to the control system.

4-3 DM Word Allocation

The C200H Interface Unit issues commands and transfers data through the PC's DM Area. The PT's operation controlled just by writing data to DM, such as screen numbers to be displayed on the PT, lamp and touch switch numbers, and data to be written to numeral and string tables. It is not necessary to write a separate communications sub-program.

In the following table, "n" is the first DM word set on pins 1 through 4 of SW1. Refer to *4-2-2 Interface Unit Switch Settings* for details on setting SW1. The maximum number of numeral table and string table entries are shown. DM

word allocation to the numeral and string tables will differ when fewer entries are specified with SW1 pins 5 through 8.

Function	DM Word(s)	Bits	Usage
PC-to-PT Communications	n	00 to 11	Output data
		12 to 15	Command Code
	n+1	00 to 15	Output data
	n+2	00 to 15	Output data
	n+3	00 to 15	Output data
	n+4	00 to 15	Lamp/switch 00 to 15
	n+5	00 to 15	Lamp/switch 16 to 31
	n+6	00 to 15	Lamp/switch 32 to 47
PT-to-PC Communications	n+8	00 to 07	Input data
		08 to 11	Command Code
		12 to 15	PT status
	n+9	00 to 15	Input data
	n+10	00 to 15	Input data
	n+11	00 to 15	Input data
	n+12	00 to 11	Switch 00 to 11
		11 to 15	Switch 12 to 15
	n+13	00 to 15	Switch 16 to 31
	n+14	00 to 15	Switch 32 to 47
	n+15	00 to 15	Switch 48 to 63
Numeral Table	n+16 and n+17	00 to 15	No. 0 numeral table entry
	n+18 and n+19	00 to 15	No. 1 numeral table entry
	⋮	⋮	⋮
	n+270 and n+271	00 to 15	No. 127 numeral table entry
String Table	n+272 to n+291	00 to 15	No. 0 string table entry
	n+292 to n+311	00 to 15	No. 1 string table entry
	⋮	⋮	⋮
	n+892 to n+911	00 to 15	No. 31 string table entry

In most C200H PCs, DM 0000 to DM 0999 can be used for communications and the numeral and string tables, but in the C200H-CPU11, DM 0969 through 0999 are reserved for system use. DM 1000 to DM 1999 is read-only in all C200H PCs and cannot be used.

4-3-1 PC-to-PT Communications

Communications from the PC to the PT are divided into communications commands to the PT and display controls for lamps and touch switches.

Communications Commands

Communications commands consist of a command code and output data contained in words n through n+3.

The command code is a one-digit hexadecimal value (0 to F) used to control PT operations such as screen display, and writing to numeral and string

tables. Each command is explained in detail later. The output data provides various BCD data required by each operation.

Lamp and Touch Switch Display Control

Display control bits in words n+4 through n+7 are used to control the display of lamps and touch switches 00 to 63. When one of these bits is ON, the lamp/touch switch indicated by the number allocated to the bit is lit; when the bit is OFF, the lamp/touch switch is not lit.

A lamp can be caused to blink when its corresponding bit is ON by setting the display attributes to blink when the lamp is created using the Support Tool. Refer to the Support Tool's *Operation Manual* for details.

Lamps and touch switches 64 to 111 can be controlled with command code 8. Refer to *4-4-6 Lamp and Touch Switch Display Control* for more details on controlling lamps and touch switches 00 to 111.

4-3-2 PT-to-PC Communications

Communications from the PT to the PC are divided into communications commands from the PT and input information from touch switches and function keys.

Communications Commands

Communications commands consist of PT status, a command code, and input data contained in n+8 through n+11.

The PT status flags (bits 12 to 15 of word n+8) provide information on the operating status of the PT, as shown in the following table.

Bit	Name	Function
12	Strobe	Sets the timing for data transmissions from the PT to the PC. For details, see <i>2-4-2 Operational Flow and Strobe</i> .
13	BAT LOW	ON when the PT's battery voltage drops.
14	BUSY	ON when data cannot be output from the PC to the PT.
15	PT RUN	ON when the PT is in RUN mode.

The command code is a one-digit hexadecimal value (0 to F) in bits 8 to 11 of n+8. The command code indicates the type of information to be transmitted from the PT, such as switch/function key and numeric inputs at the PT. Each command is explained in detail later. The input data words receive the various data that accompany each command.

Switch and Key Inputs

Touch switch and function key inputs can be detected from the PC through bit status in words n+12 through n+15.

This function is valid only when a screen is being displayed in which the bit inputs have been enabled in the screen attributes and the input attributes have been set to touch switch or function key. Refer to the Support Tool's *Operation Manual* for more details on setting input attributes.

4-3-3 Numeral and String Tables

The area containing the PT's memory tables (numeral table and string table) is known as the memory table area. The Interface Unit periodically reads the contents of the DM Area allocated to the memory table and writes the data to the PT. Thus, the PT's numeral and string tables can be changed just by writing new data to the region of the DM Area allocated to these tables.

Memory Table Initialization

To ensure that the memory tables in the PC and PT agree, the Interface Unit must use either the memory table stored in the PC's DM Area or the table in the PT whenever the Unit is turned on, reset, or switched to RUN mode. Pin 1 of SW2 determines which table will be used.

When pin 1 of SW2 is ON, the memory table data in the C200H's DM will be written to the PT's memory table.

When pin 1 of SW2 is OFF, the PT's memory table data (set with the Support Tool) will be written to the section of the C200H's DM that has been allocated to the memory table.

Numeral Table

DM words are automatically allocated to the numeral table entries beginning at $n+16$. The number of numeral table entries is set with pins 5 and 6 of SW4. Each table entry (8 digits of BCD) is stored in two DM words.

In the NT20M, up to 128 table entries can be used. Up to 128 entries can be allocated in the PC's DM Area.

In the NT600M, up to 256 table entries can be used. Up to 128 entries can be allocated in the PC's DM Area.

Table Entry	Table Entry Digits	DM Word
No. 0	Leftmost 4 digits	$n+16$
	Rightmost 4 digits	$n+17$
No. 1	Leftmost 4 digits	$n+18$
	Rightmost 4 digits	$n+19$
⋮	⋮	⋮
No. 127	Leftmost 4 digits	$n+270$
	Rightmost 4 digits	$n+271$

The leftmost four digits (BCD) are stored in the first table entry word m and the rightmost four digits (BCD) are stored on word $m+1$. Negative values are indicated by setting the value of the leftmost digit (bits 12 to 15 of m) to F. Since one digit is used to indicate the sign, negative numbers can be only 7 digits long.

Example: 12345678

m	1	2	3	4
$m+1$	5	6	7	8

Example: -1234567

m	F	1	2	3
$m+1$	4	5	6	7

String Table

DM words are automatically allocated to the string table entries following the numeral table. The number of string table entries is set with pins 7 and 8 of SW4. Each string table entry is allocated 20 DM words.

The 20 words allocated to each table entry can contain 40 normal characters. The following table shows the distribution of 40 normal characters in a table entry. ("m" is the first word allocated to the string entry.)

DM Word	Bits	Character
m	00 to 07	(2)
	08 to 15	(1)
$m+1$	00 to 07	(4)
	08 to 15	(3)
⋮	⋮	⋮
$m+19$	00 to 07	(40)
	08 to 15	(39)

In the NT20M, up to 32 memory table entries can be used and all of these can be allocated in the PC's DM Area. Only the first 16 allocated words in each entry are used. The last 4 words are not used. Thus, each entry can contain up to 32 normal characters or 16 marks.

In the NT600M, up to 256 memory table entries can be used, but only 32 entries can be allocated in the PC's DM Area. All 20 allocated words are used, so each entry can contain up to 40 normal characters or 20 marks.

DM Word Allocation

The following table shows the DM word ranges for every combination of numeral and string table sizes. The maximum possible value for "n" (the first DM word) is also shown for each combination.

Number of entries		Table range		Maximum "n"
Numeral	String	Numeral	String	
0	0	---	---	DM 0896
32	0	n+16 to n+79	---	DM 0896
64	0	n+16 to n+143	---	DM 0832
128	0	n+16 to n+271	---	DM 0704
0	8	---	n+16 to n+175	DM 0768
32	8	n+16 to n+79	n+80 ton+239	DM 0704
64	8	n+16 to n+143	n+144 to n+303	DM 0640
128	8	n+16 to n+271	n+272 to n+431	DM 0512
0	16	---	n+16 to n+335	DM 0640
32	16	n+16 to n+79	n+80 ton+399	DM 0576
64	16	n+16 to n+143	n+144 to n+463	DM 0512
128	16	n+16 to n+271	n+272 to n+591	DM 0384
0	32	---	n+16 to n+655	DM 0320
32	32	n+16 to n+79	n+80 ton+719	DM 0256
64	32	n+16 to n+143	n+144 to n+783	DM 0192
128	32	n+16 to n+271	n+272 to n+911	DM 0064

Allocation Example

The table below shows DM word allocation when the Interface Unit is set for 32 numeral table entries and 16 string table entries.

DM Words	Table Entry
n+16 and n+17	No. 0 numeral table entry
⋮	⋮
n+78 and n+79	No. 31 numeral table entry
n+80 to n+99	No. 0 string table entry
⋮	⋮
n+380 to n+399	No. 15 string table entry

4-4 PC-to-PT Commands

In the following descriptions of commands, "n" is the beginning DM word set on pins 1 through 4 of SW4. The status of words n through n+7 can be manipulated in the PC to control various aspects of PT operation or to access

various data from the PT, as shown in the following table. Refer to 4-3 *DM Word Allocation* for more details.

DM Word	Bits	Usage
n	00 to 11	Output data
	12 to 15	Command Code
n+1	00 to 15	Output data
n+2	00 to 15	Output data
n+3	00 to 15	Output data
n+4	00 to 15	Lamps/touch switches 00 to 15
n+5	00 to 15	Lamps/touch switches 16 to 31
n+6	00 to 15	Lamps/touch switches 32 to 47
n+7	00 to 15	Lamps/touch switches 48 to 63

Command Codes

Commands are all designated by single-digit hexadecimal numbers (0 to F) in bits 12 to 15 of n. All output data is in BCD (binary coded decimal).

Command code	Function
0	Designated screen display
1	Designated screen display (NT600M only)
2	Not used.
3	Numeral table setting ¹ (positive numbers)
4	Numeral table setting ¹ (negative numbers)
5	String table setting ² (setting string table entry number)
6	String table setting ² (writing character string data)
7	Lamp/touch switch display control ³ (setting lamp/touch switch no.)
8	Lamp/touch switch display control ⁴ (bit setting)
9	Not used.
A	Screen number request
B	Not used.
C	Copy memory table entry
D	System status control
E and F	Not used.

- Note**
1. The contents of the PT's numeral table can be changed with this command or by writing to the DM words allocated to the numeral table.
 2. The contents of the PT's string table can be changed with this command or by writing to the DM words allocated to the string table.
 3. This command is used to control lamps and touch switches 112 and higher.
 4. This command is used to control lamps and touch switches 064 to 111.
 5. The PT will disregard commands with command codes 2, 9, B, E, or F.

4-4-1 Interchanging SYSMAC WAY and C200H Programs

Because C200H Interface Unit command codes and functions are basically the same as those of SYSMAC WAY Interface Units, the same program can be used as long as the precautions outlined below are followed.

Memory Table Area

Unlike the SYSMAC WAY Interface Unit, the C200H Interface Unit's Memory Table area can change, so the word addresses used in the SYSMAC WAY Inter-

face Unit's program might differ from the corresponding addresses in the C200H Interface Unit's program.

Take the following precautions when using the same program for a SYSMAC WAY Interface Unit and a C200H Interface Unit.

- 1, 2, 3...
 1. Set the first DM word to DM 0000 or DM 0256.
 2. In the C200H Interface Unit, the first word in the string table depends on the number of entries in the numeral table, but in the SYSMAC WAY Interface Unit the first word in the string table is fixed at n+272.
Set the number of numeral table entries to 128 by setting pins 5 and 6 of SW1 to ON. The first word in the C200H and SYSMAC WAY Interface Units' string tables will agree only when the number of numeral table entries is set to 128.
 3. It is necessary to set the number of string table entries higher than the number actually needed.
 4. If different entries in the Memory Table area accessed simultaneously, lower-number numeral table entries will be given priority. Higher-number numeral table entries and string table entries might not be refreshed. In such cases, create sub-programs so that Memory Table entries are refreshed as needed.

Processing Speed

Because the C200H Interface Unit uses the C200H Special I/O Unit handshake for communicating with the C200H PC, it can operate faster than the SYSMAC WAY Interface Unit. Therefore, if you take a program that was used with the C200H Interface Unit and then use it with the SYSMAC WAY Interface Unit, you may have to slow down transmission, using timers, for example.

The maximum I/O response time for the C200H Interface Unit is 8.5 ms, but it is 2.0 ms if there are no changes to the numeral and string tables in DM.

4-4-2 Designated Screen Display

A command code of 0 or 1 is used to display a designated screen. Command code "1" is valid only for the NT600M.

Word	15 to 12	11 to 08	07 to 04	03 to 00
n	Command code	Screen number (rightmost 3 digits)		
	0 or 1	N	N	N

NT20M

Command code "0" is used to display a designated screen. The screen number (001 to 250, BCD) is specified in the rightmost 3 digits. A screen number of 000 will clear the PT's display.

Data beyond DM word n is ignored.

NT600M

Command code "0" is used to display a designated screen with a screen number from 000 to 999, BCD. The screen number is specified in the rightmost 3 digits. A screen number of 000 will clear the PT's display.

Command code "1" is used to display screen number 1000. The rightmost 3 digits should be set to 000.

Data beyond DM word n is ignored.

4-4-3 Numeral Table Settings

The numeral table can be set by using a communications command or by writing data directly to the DM words allocated to the numeral table.

Communications Command

These commands are used to write 2 words of data to the specified numeral table entry. A command code of 3 is used to write positive numbers and a com-

mand code of 4 is used for negative numbers. The PT's display will change if the specified numeral table entry or a flag that depends on that entry is being displayed.

Numeral table entries are specified in 3-digit BCD and can be from 000 to 127 with the NT20M or 000 to 255 with the NT600M. The numeric data is written in 8-digit BCD from 00000000 to 99999999. Write the 4 leftmost digits in n+1 and the 4 rightmost digits in n+2. Data in n+3 is ignored.

Positive Numbers

A command code of 3 is used to write positive numbers to the numeral table by designating the table entry number.

Word	15 to 12	11 to 08	07 to 04	03 to 00
n	Command code	Table entry number		
	3	N	N	N
n + 1	Numeric data (leftmost 4 digits)			
	N	N	N	N
n + 2	Numeric data (rightmost 4 digits)			
	N	N	N	N

Negative Numbers

A command code of 4 is used to write negative numbers to the numeral table by designating the table entry number.

Word	15 to 12	11 to 08	07 to 04	03 to 00
n	Command code	Table entry number		
	4	N	N	N
n + 1	Numeric data (leftmost 4 digits)			
	N	N	N	N
n + 2	Numeric data (rightmost 4 digits)			
	N	N	N	N

Writing Directly to DM

It is not necessary to use the communications commands described above to change the numeral table. Data can be changed in the PT's numeral table by writing directly to the DM words that have been allocated to the numeral table.

The PT's display will change if a numeral table entry or a flag that depends on that entry is being displayed and new data is written to the DM words allocated to that entry.

4-4-4 String Table Settings

There are two ways to change the string table. New data can be written to the table with communications commands (command codes 5 and 6) or the data can be written directly to the DM words allocated to the string table.

Designating the String Table Entry Number

A command code of 5 is used to designate the entry number in the string table that is to be written to using the next string write command (command code 6).

Word	15 to 12	11 to 08	07 to 04	03 to 00
n	Command code	String table entry number		
	5	N	N	N

String table entry numbers are designated in 3 digits of BCD (000 to 031 for the NT20M, and 000 to 255 for the NT600M). The designated number is valid

until again designated with a command code 5. When power is first turned on, 0 is set as the default.

Data beyond word n is ignored.

4-4-5 Writing Character String

A command code of 6 is used to write a character string to the string table entry that has been designated under command code 5.

The PT's display will change if a new data is written to a string table entry while the character string is being displayed.

Word	15 to 12	11 to 08	07 to 04	03 to 00
n	Command code	Not used.	Character string position	
	6	x	D	D
n + 1	Character data 1		Character data 2	
	C1	C1	C2	C2
n + 2	Character data 3		Character data 4	
	C3	C3	C4	C4
n + 3	Character data 5		Character data 6	
	C5	C5	C6	C6

Note Data in the area marked by x will be ignored at the PT.

Character positions are designated by 2-digit BCD numbers (01 to 40 for the NT600M, and 01 to 32 for the NT20M). Designate the first character as 1, the next as 2, and so on. Refer to the appendices for character codes.

Character data is given in ASCII (half-size or normal characters).

If 00 is given as character data, data from that point on will be ignored.

Character data will be written to the string table when command code 6 is received by the PT.

Example: Writing "OMRON PC" to String Table Entry 3

Order	Word	Data	Meaning
1	n	5003	Designates string table no. 3.
	n + 1	xxxx	Not used.
	n + 2	xxxx	Not used.
	n + 3	xxxx	Not used.
2	n	6x01	Designates 1st position.
	n + 1	4F4D	"OM"
	n + 2	524F	"RO"
	n + 3	4E20	"N "
3	n	6x07	Designates 7th position.
	n + 1	5043	"PC"
	n + 2	00xx	Remainder of character string data
	n + 3	xxxx	Ignored.

Writing Directly to DM

It is not necessary to use the communications commands described above to change the string table. Data can be changed in the PT's string table by writing directly to the DM words that have been allocated to the string table.

The PT's display will change if a new data is written to a string table entry while the character string is being displayed.

4-4-6 Lamp and Touch Switch Display Control

A lamp or touch switch can be controlled (turned on, off, or made to blink) if the Support Tool was used to set it in the screen being displayed. A total of

256 lamps and touch switches (numbers 000 through 255) can be set with a Support Tool. These 256 lamps and touch switches are divided into three groups and each group is controlled differently.

Numbers 00 through 63 are allocated bits in DM words n+4 to n+7. These lamps and touch switches are turned on and off by turning the corresponding bits on and off.

Numbers 64 through 111 are controlled by a communications command (command code 8), and numbers 112 through 255 are controlled by another communications command (command code 7).

Numbers 00 through 63 are controlled when DIP Switch 1-4 is turned to ON, and 00 through 111 are controlled when it is turned to OFF.

Numbers 00 to 63

Lamps and touch switches 00 through 63 are turned on and off by turning on and off the corresponding bits in n+4 through n+7. The following table shows the bit allocation for these lamps and touch switches.

DM Word	Bits	Allocation
n+4	00 to 15	Lamps/switches 00 to 15
n+5	00 to 15	Lamps/switches 16 to 31
n+6	00 to 15	Lamps/switches 32 to 47
n+7	00 to 15	Lamps/switches 48 to 63

If the lamp display attributes are set to ON when the lamps are created, lamps 00 to 63 will be turned on when the corresponding bit is ON; they will blink if the attributes are set to FLASH when they are created.

Numbers 64 to 111

Lamps and touch switches 64 through 111 are controlled by the communications command with command code 8.

The lamps and touch switches are turned on and off by turning on and off the corresponding bits in n+1 through n+3. The following table shows the bit allocation for the lamps and touch switches with numbers 64 through 111.

Word	15 to 12	11 to 08	07 to 04	03 to 00
n	Command code	Not used.		
	8	x	x	x
n + 1	79 to 76	75 to 72	71 to 68	68 to 64
	N	N	N	N
n + 2	95 to 92	91 to 88	87 to 84	83 to 80
	N	N	N	N
n + 3	111 to 108	107 to 104	103 to 100	99 to 96
	N	N	N	N

Note Data in the areas marked by x will be ignored at the PT.

If the lamp display attributes are set to ON when the lamps are created, lamps 00 to 63 will be turned on when the corresponding bit is ON; they will blink if the attributes are set to FLASH when they are created.

Numbers 112 to 255

Lamps and touch switches 112 through 255 can be set to be off, to light, or to blink by the communications command with command code. Lamp and touch switch numbers are designated by 3-digit BCD numbers (N: 112 to 255).

Word	15 to 12	11 to 08	07 to 04	03 to 00
n	Command code	Function code	Not used.	
	7	m	x	x
n + 1	Not used.		Lamp/switch number	
	x	N	N	N

Note Data in the areas marked by x will be ignored at the PT.

The function code “m” determines whether the designated lamp or touch switch will be set to on, off, or blink, as shown in the following table. If m=3, all lamps and touch switches will be turned off. Codes 4 to 9 are ignored.

Function code (m)	Lamp status	Touch switch status
0	OFF	OFF
1	ON	ON
2	Blinking	ON
3*	All OFF	All OFF
4 to 9	No effect	No effect

Note *Lamps and touch switches numbers 00 through 111 should also be turned off by the procedures described above. (Set bits in n+4 through n+7 to 0, and issue command 8 with the bits in n+1 through n+3 set to 0.)

4-4-7 Screen Number Request

This command (command code A) is used to determine which screen number is currently being displayed on the PT. Upon reception this command, the PT transmits the screen number to the host with the “screen number request response” command. Refer to *4-5-6 Response to Screen Number Request* for details.

There will not be a response from the PT if a system menu (including the maintenance menu) is displayed.

Word	15 to 12	11 to 08	07 to 04	03 to 00
n	Command code	Not used.		
	A	x	x	x

Note Data in the area marked by x will be ignored at the PT. Data beyond n+1 will be ignored.

4-4-8 Copy Memory Table Entry

This command (command code C) is used to copy the contents of a memory table entry (numeral or string) to another entry. The contents of the source table entry remain unchanged.

By setting data and marks to be displayed on the original memory table and copying these data and marks to a memory table which is displayed on the PT’s screen, it is possible to change the display of the screen. This is convenient if the same data is to be used on different screens or if screen messages have to be changed frequently.

The numbers of the source and destination memory table entries are specified in 3-digit BCD, as shown in the following table. String table entry num-

bers can be 000 to 031 for the NT20M or 000 to 255 for the NT600M. Numerical table entry numbers can be 000 to 127 for the NT20M or 000 to 255 for the NT600M.

Word	15 to 12	11 to 08	07 to 04	03 to 00
n	Command code	Source table entry number		
	C	N	N	N
n + 1	Sub-code	Destination table entry number		
	m	N	N	N

- Note**
1. Data beyond n+1 will be ignored.
 2. The sub-code “m” determines whether the table entry is a string or numeral table entry. Set m=0 to indicate a string table entry; set m=1 to indicate a numeral table entry.

4-4-9 System Status Control

This command (command code D) is used to control the PT's operating status.

Word	15 to 12	11 to 08	07 to 04	03 to 00
n	Command code	Not used.		
	D	x	x	x
n + 1	Status control bits			
	N	N	x	x

- Note** Data in the areas marked “x” and data beyond word n+1 will be ignored.

Bits 10 through 15 of n+1 control various aspects of PT operation, as shown in the following table.

Bit	ON	OFF	Notes
00 to 09	Not used.	Not used.	---
10	Red backlight	White backlight	See note 1.
11	History initialization	Not used.	---
12	Intermittent buzzer ON	Intermittent buzzer OFF	See note 2.
13	Continuous buzzer ON	Continuous buzzer OFF	See note 2.
14	Alarm output ON	Alarm output OFF	---
15	Backlight ON	Backlight OFF	---

- Note** 1. Red/white backlight selection is valid for the NT20M-DT131/DN131 only.

Bit 10 status	Bit 15 status	Backlight
0	1	White
1	1	Red
0 or 1	0	Backlight off

2. A continuous buzzer will be produced if both intermittent buzzer and continuous buzzer are designated.

4-5 PT-to-PC Commands

In the following descriptions of commands, “n” is the beginning DM word set on pins 1 through 4 of SW4. The following table shows the function of bits in

DM words n+8 through n+15. Refer to 4-3 DM Word Allocation for more details.

DM Word	Bits	Usage
n+8	00 to 07	Input data
	08 to 11	Command Code
	12 to 15	PT status
n+9	00 to 15	Input data
n+10	00 to 15	Input data
n+11	00 to 15	Input data
n+12	00 to 11	Touch switches 00 to 11
	11 to 15	Touch switches 12 to 15
n+13	00 to 15	Touch switches 16 to 31
n+14	00 to 15	Touch switches 32 to 47
n+15	00 to 15	Touch switches 48 to 63

Commands are all designated by single-digit hexadecimal numbers (0 to F) in bits 08 to 11 of n+8, as shown in the following table. All input data is in BCD (binary coded decimal).

Command Codes

Commands are all designated by single-digit hexadecimal numbers (0 to F) in bits 12 to 15 of n. All output data is in BCD (binary coded decimal).

Command code	Function
0 to 2	Not used.
3	Numeral editing input (writing positive numbers)
4	Numeral editing input (writing negative numbers)
5 to 7	Not used.
8	Response to screen number request
9	Touch switch input (numeric designation)
A	Not used.
B	Function key input (numeric designation)
C to F	Not used.

4-5-1 Interchanging SYSMAC WAY and C200H Programs

Because C200H Interface Unit command codes and functions are basically the same as those of SYSMAC WAY Interface Units, the same program can be used as long as the precautions outlined below are followed.

Memory Table Area

Unlike the SYSMAC WAY Interface Unit, the C200H Interface Unit's Memory Table area can change, so the word addresses used in the SYSMAC WAY Interface Unit's program might differ from the corresponding addresses in the C200H Interface Unit's program.

Take the following precautions when using the same program for a SYSMAC WAY Interface Unit and a C200H Interface Unit.

- 1, 2, 3... 1. Set the first DM word to DM 0000 or DM 0256.
- 2. In the C200H Interface Unit, the first word in the string table depends on the number of entries in the numeral table, but in the SYSMAC WAY Interface Unit the first word in the string table is fixed at n+272.
Set the number of numeral table entries to 128 by setting pins 5 and 6 of SW1 to ON. The first word in the C200H and SYSMAC WAY Interface Units'

string tables will agree only when the number of numeral table entries is set to 128.

3. It is necessary to set the number of string table entries higher than the number actually needed.
4. If different entries in the Memory Table area accessed simultaneously, lower-number numeral table entries will be given priority. Higher-number numeral table entries and string table entries might not be refreshed. In such cases, create sub-programs so that Memory Table entries are refreshed as needed.

Commands can also be used to give certain table entries a higher priority.

Processing Speed

Because the C200H Interface Unit uses the C200H Special I/O Unit handshake for communicating with the C200H PC, it can operate faster than the SYSMAC WAY Interface Unit. Therefore, if you take a program that was used with the C200H Interface Unit and then use it with the SYSMAC WAY Interface Unit, you may have to slow down transmission, using timers, for example.

The maximum I/O response time for the C200H Interface Unit is 8.5 ms, but it is 2.0 ms if there are no changes to the numeral and string tables in DM.

4-5-2 PT Status Flags

The PT status flags (bits 12 to 15 of word n+8) provide information on the operating status of the PT. This data is transmitted to the PC when a PT-to-PC command is executed.

Bit	Name	Function
12	Strobe	Sets the timing for data transmissions from the PT to the PC. For details, see 2-4-2 <i>Operational Flow and Strobe</i> . Data should be input to words n+8 through n+11 when this bit goes from OFF to ON.
13	BAT LOW	ON when the PT's battery voltage drops. Replace the battery within 5 days after this bit goes ON.
14	BUSY	ON when data cannot be output from the PC to the PT.
15	PT RUN	ON when the PT is in RUN mode.

Strobe

The strobe signal is used to synchronize the transmission of data from the PT to the PC. When writing programs to receive data from the PC, have the PC take in data on the rising edge of the strobe signal.

The ON/OFF status of the strobe is refreshed during the I/O refreshing, so the strobe cycle depends on the PC's scan time. The strobe signal does not turn ON when a Touch Switch input is transmitted to the PC by bit input indication.

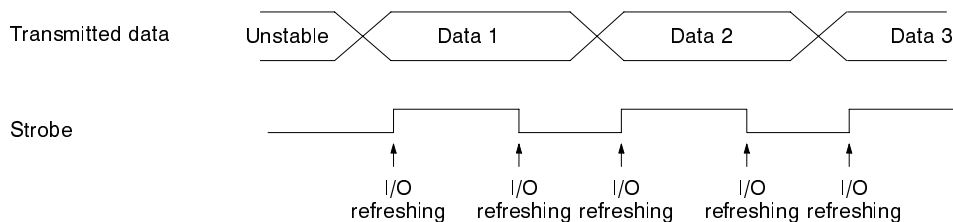

When data is output continuously from the PT as shown above, two PC scans are required from when one batch of output data is received until the next is received.

If an input such as touch switch is pressed while the strobe goes from ON to OFF, that data will not be output.

- Note**
1. The PT cannot take in data until the strobe goes from ON to OFF, so data such as an input from a touch switch will not be output if the switch is pressed while the strobe goes from ON to OFF.
 2. The strobe signal is output only when the contents of n+8 to n+11 (used for PT-to-PC commands and accompanying data) have been changed. The strobe signal will not be output when the contents of n+12 to n+15 (used for bit input data and memory tables) have been changed.

4-5-3 Touch Switch Input

There are two ways to indicate touch switch input, numeral input indication (command code 9) and bit input indication. The numeral input method is valid for all touch switches (000 to 255), while the bit input method is valid for touch switches 00 to 63 only.

These operations are valid with touch switch-type PTs only.

Numeric Input Indication

This method uses a communications command (command code 9) to transmit the touch switch numbers to the PC. The numbers of touch switches that have been input can be transmitted to the PC when the screen used to set the switches is being displayed on the PT.

This operation is valid only when the Support Tool has been used to disable the “Bit Input” setting in the screen attributes.

Word	15 to 12	11 to 08	07 to 04	03 to 00
n + 8	PT status	Command code	Not used.	
	?	9	x	x
n + 9	Not used.	Touch switch number		
	x	N	N	N

- Note**
1. The question mark (?) indicates change according to the status of the PT.
 2. Data in the areas marked by x and in words beyond n+9 will be ignored. (Touch switch data will not appear in words n+12 through n+15.)

Touch switch numbers are designated by 3-digit BCD numbers (000 to 255).

The input occurs only when a touch switch is pressed, and there is no indication of when it is released.

Bit Input Indication

When a screen in which the touch switches have been set is being displayed on the PT, inputs to touch switches 00 to 63 can also be detected through bits allocated in n+12 through n+15. The following table shows the bit allocation for these touch switches.

DM Word	Bits	Allocation
n+12	00 to 15	Touch switches 00 to 15
n+13	00 to 15	Touch switches 16 to 31
n+14	00 to 15	Touch switches 32 to 47
n+15	00 to 15	Touch switches 48 to 63

This command is valid only when the Support Tool has been used to enable the “Bit Input” setting and the inputs have been set for touch switches in the screen attributes.

Bit operation is unrelated to command codes and is always valid.

- Note** The PT’s strobe signal will not be turned ON when touch switch inputs are indicated by the status of bits in n+12 through n+15.

4-5-4 Function Key Input

There are two ways to indicate function key inputs, numeric input indication (command code B) and bit input indication. These operations are valid with function key-type PTs only.

Numeric Input Indication

This method uses a communications command (command code B) to transmit to the PC the function key number that was input. Function key numbers 00 to 31 can be transmitted.

The function key numbers that can be transmitted depend on the PT model and Unit installed, as shown in the following table.

PT model	Unit installed	Function key numbers
NT600M-DF122	---	00 through 11
NT20M-DN131 /DN121-V2 NT600M-DN122/211	12-key Function Key Unit	00 through 11

This operation is valid only when the Support Tool has been used to disable the “Bit Input” setting in the screen attributes.

Word	15 to 12	11 to 08	07 to 04	03 to 00
n + 8	PT status	Command code	Not used.	
	?	B	x	x
n + 9	Not used.		Function key number	
	x	x	N	N

- Note**
1. The question mark (?) indicates change according to the status of the PT.
 2. Data in the areas marked by x and in words beyond n+9 will be ignored. (Switch data will not appear in words n+12 through n+15.)

Function key numbers are designated by 2-digit BCD numbers (00 to 31).

The function key number is transmitted when a function key is pressed, and there is no indication of when it is released.

Bit Input Indication

With function key-type PTs, inputs to function keys can also be detected through bits allocated in n+12 and n+13. When a function key is pressed its corresponding bit in n+12 or n+13 will be turned ON. The following table shows the bit allocation for the function keys (numbers 00 to 31).

DM Word	Bits	Allocation
n+12	00 to 15	Function keys 00 to 15
n+13	00 to 15	Function keys 16 to 31

This operation is valid only when the Support Tool has been used to enable the “Bit Input” setting and the inputs have been set for function keys in the screen attributes.

Bit operation is unrelated to command codes and is always valid.

4-5-5 Numeral Table Editing

When a screen is being displayed on the PT in which numeral table editing has been set with the Support Tool, numbers input on the PT’s touch switches or function keys can be written to the numeral table entry specified with the Support Tool.

Positive numbers are written with a command code of 3, and negative numbers are written with a command code of 4. If the numeral table entry speci-

fied with the Support Tool has been allocated memory in the DM Area, the contents of that memory will be overwritten with the data input on the touch switches or function keys.

The numeral table entry in the DM Area is not overwritten until the strobe signal goes ON, so use the data in words $n+10$ and $n+11$ after that point. Also, negative numbers cannot be written to numeral table entries in the DM Area.

Writing Positive Numbers

A command code of 3 is used to inform the PC of positive numbers that have been registered in the numeral table.

Word	15 to 12	11 to 08	07 to 04	03 to 00
n + 8	PT status	Command code	Not used.	
	?	3	x	x
n + 9	Not used.	Table entry number		
	x	N	N	N
n + 10	Number data (leftmost 4 digits)			
	N	N	N	N
n + 11	Number data (rightmost 4 digits)			
	N	N	N	N

Note The question mark (?) indicates variable data representing PT status. See 4-5-2 *PT Status Flags* for details. Data in the areas marked by x is ignored.

Numeral table entry numbers are designated by 3 digits of BCD (000 to 127 for the NT20M, and 000 to 255 for the NT600M).

Numeric data is expressed in 8-digit BCD (00000000 to 99999999). The leftmost 4 digits are designated in word $n+10$ and the rightmost 4 digits are designated in word $n+11$.

Writing Negative Numbers

A command code of 4 is used to notify the PC of negative numbers that have been registered in the numeral table. Negative numbers cannot be written to the PC's DM Area.

Word	15 to 12	11 to 08	07 to 04	03 to 00
n + 8	PT status	Command code	Not used	
	?	4	x	x
n + 9	Not used	Table entry number		
	x	N	N	N
n + 10	Number data (leftmost 4 digits)			
	N	N	N	N
n + 11	Number data (rightmost 4 digits)			
	N	N	N	N

Note The question mark (?) indicates variable data representing PT status. See 4-5-2 *PT Status Flags* for details. Data in the areas marked by x is ignored.

Numeral table entry numbers are designated by 3 digits of BCD (000 to 127 for the NT20M, and 000 to 255 for the NT600M).

Numeric data is expressed in 8-digit BCD (00000000 to 99999999). The leftmost 4 digits are designated in word $n+10$ and the rightmost 4 digits are designated in word $n+11$.

4-5-6 Response to Screen Number Request

When a “screen number request” command (command code A) is received from the PC, the PT uses this command (command code 8) to notify the PC of the screen number being displayed. This command uses a “stand alone” function and will automatically transmit the screen number even when the screen was switched.

Word	15 to 12	11 to 08	07 to 04	03 to 00
n + 8	PT status	Command code	Not used	
	?	8	x	x
n + 9		Screen number		
	x	N	N	N

- Note**
1. The question mark (?) indicates variable data representing PT status.
 2. Refer to 4-4-7 *Screen Number Request* for details on that command.

4-6 Communications Check

Communications between the PT and PC can be checked from the PT’s System Menu. Refer to the PT’s *Operation Manual* for more details.

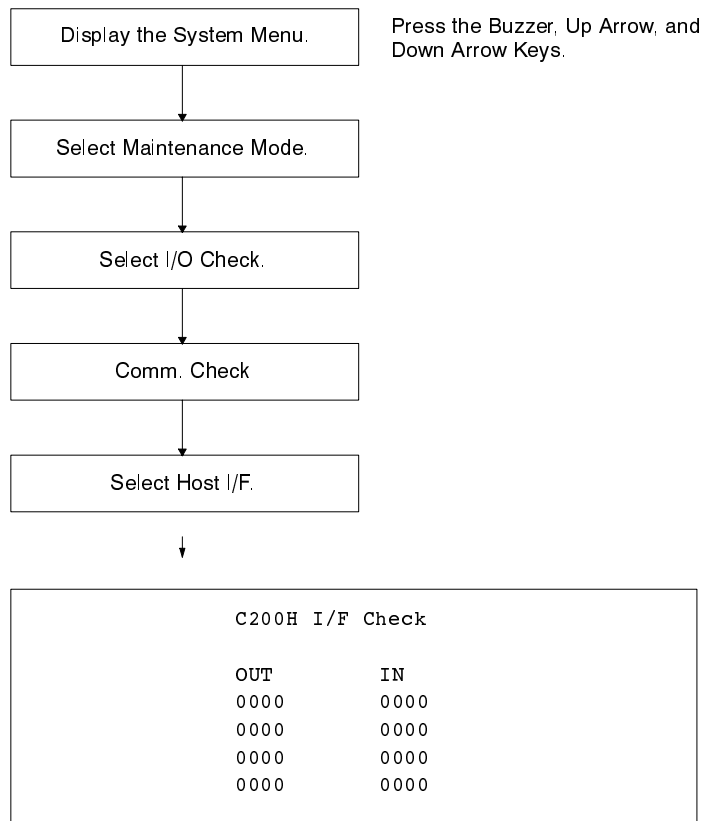

- Note** Return to I/O Check Menu by pressing the Buzzer, Up, and Down Keys simultaneously.

“Output” refers to the data written in word n+12 to n+15 of the DM area. The 12 data patterns shown below are transmitted automatically from the C200H Interface Unit. Check both the display and the contents of the C200H DM area. If the

data has been transmitted correctly, then the display and the DM contents should match.

Word	1	2	3	4	5	6	7	8	9	10	11	12
n+12	0000	0055	55AA	AAFF	FF00	0000	0000	0000	0000	0000	0000	FFFF
n+13	0000	0000	0000	0055	55AA	AAFF	FF00	0000	0000	0000	0000	FFFF
n+14	0000	0000	0000	0000	0000	0055	55AA	AAFF	FF00	0000	0000	FFFF
n+15	0000	0000	0000	0000	0000	0000	0000	0055	55AA	AAFF	FF00	FFFF

This data will be sent repeatedly until the I/O Check has been completed.

“Input” refers to the DM contents of n+4 to n+7. By changing the data in n+4 to n+7 from the C200H PC, the display is changed. Check both the display and the contents of the C200H DM area. If the data has been transmitted correctly, then the display and the DM contents should match.

The output and input operations can be checked simultaneously by writing a PC program that transfers the data in words n+12 through n+15 to words n+4 through n+7. If communications are normal, the “OUT” and “IN” displays on the PT’s screen will match.

Caution Be sure to switch the PC to PROGRAM mode before performing an I/O Check, because the contents of the touch switch/function key input area will be changed.

4-7 Communications Errors

If a communications error occurs, the host error screen will be displayed on the PT’s screen.

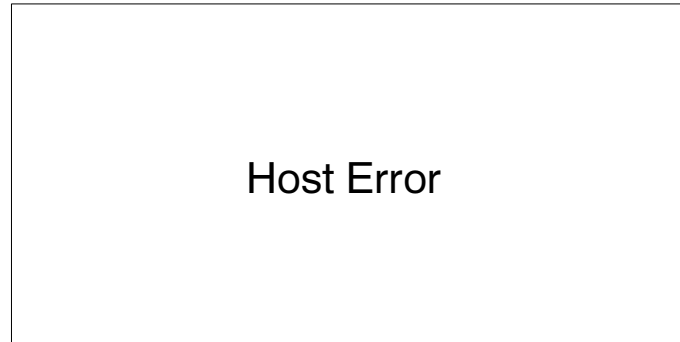

Error screens, however, may not be displayed depending on the setting of pin 1 of SW1 on the PT and on the type of error.

4-7-1 Processing Communications Errors

When communications errors occur, the PT executes the following internal processing.

No Automatic Reset after Communications Error (Pin 1 of PT's SW1: ON)

Error	PT internal processing	Possible correction
Communications command error	The command in error is not executed. Error contents are not displayed.	Recheck the contents of the data.
Host error	If a communications error should occur, the error message will be displayed and a buzzer will sound. After the error, no commands can be received. Once the host error has been cleared, the Run Mode will be automatically reinstated.	Return to RUN mode by pressing the Buzzer Key or the Enter Key. Check cable connections and C200H PC status.
C200H Interface Unit error	If a communications error should occur, the error message will be displayed and a buzzer will sound. After the error, no commands can be received.	Return to RUN mode by pressing the Buzzer Key or the Enter Key. Check whether the Unit is installed correctly. If so, then replace the Unit.

Automatic Reset after Communications Error (Pin 1 of PT's SW1: OFF)

Error	PT internal processing	Possible correction
Communications command error	The command in error is not executed. Error contents are not displayed.	Recheck the contents of the data.
Other	Even if an error should occur, no error message will be displayed. Commands cannot be received until the error has been cleared.	Check cable connections and C200H PC status, and check whether the Unit is installed correctly.

4-7-2 Troubleshooting

With some errors, the Unit's status cannot be checked with the PT's maintenance mode. The following table provides possible causes and possible remedies for these errors.

Symptom	Probable cause	Possible remedy
No display on screen	Waiting for command from PC or there is no screen data.	Issue a command from the PC. Record screen data with Support Tool.
Cannot transmit from C200H Interface Unit	The timing signal for transmission with the Interface Unit has not been detected.	Check the switch settings and the Interface Unit's strobe time. Check communications in maintenance mode.
Display indicates no C200H Interface Unit	Interface Unit is not connected.	Connect C200H Interface Unit.
The PT's "RUN LED" is not lit during operation and the buzzer sounds continuously.	PT is running uncontrolled or external noise is affecting PT.	Install the connecting cables away from high voltage lines or equipment that generates noise. Also install noise filters in power supply lines.
	System ROM installed incorrectly.	Install the System ROM correctly and be sure that it is fastened securely.

- Note**
1. The connector that connects to the Interface Unit is small-sized (the same size as the one on the C200H-PRO27 Programming Console).
 2. The maximum cable length between two Units is 2 m. The maximum length of all I/O Connecting Cables is 6 m.

NT20M-CNP□□1 (For the C200H)

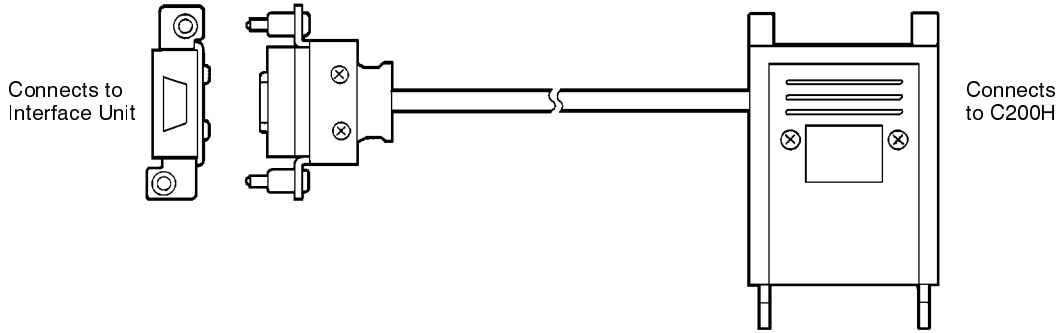

NT20M-CNP□□2 (For Mini H-type PCs)

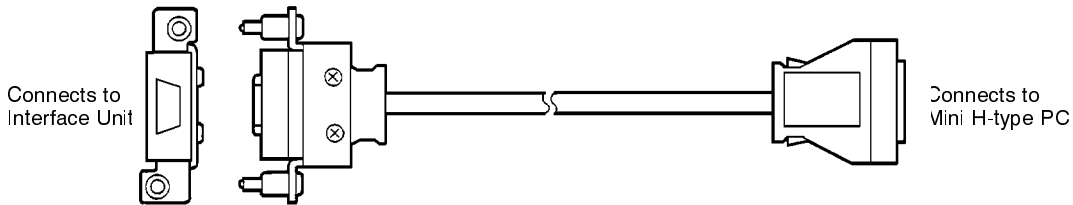

4-8-3 Unit Number Settings

The C200H Interface Unit is a Special I/O Unit which requires a unit number setting. Unit numbers 0 through 7 can be set with SW3. Usually the unit number is set to 0. An error will result if the unit number is set to 8 or 9.

The C200H Interface Unit does not use any of the IR words allocated to it because it transfers and stores data in DM, so IR 100 to IR 179 can be used as work bits.

Unit number	IR Words
0	100 to 109
1	110 to 119
2	120 to 129
3	130 to 139
4	140 to 149
5	150 to 159
6	160 to 169
7	170 to 179

- Note** The C200H Expansion I/O Rack cannot be connected when the C200H Interface Unit is connected, so other Special I/O Units cannot be connected and the unit number of the Interface Unit can be set to any number between 0 and 7.

4-8-4 System Settings

In Mini H-type PCs, words DM 0900 to DM 0999 are allocated as the PC's system setting area. This area and the memory table area must not overlap, so the first word setting must be lower for Mini H-type PCs than it is for the C200H. Refer to 4-2 Specifications and Switch Settings for more details.

Setting First Word and Memory Table Areas

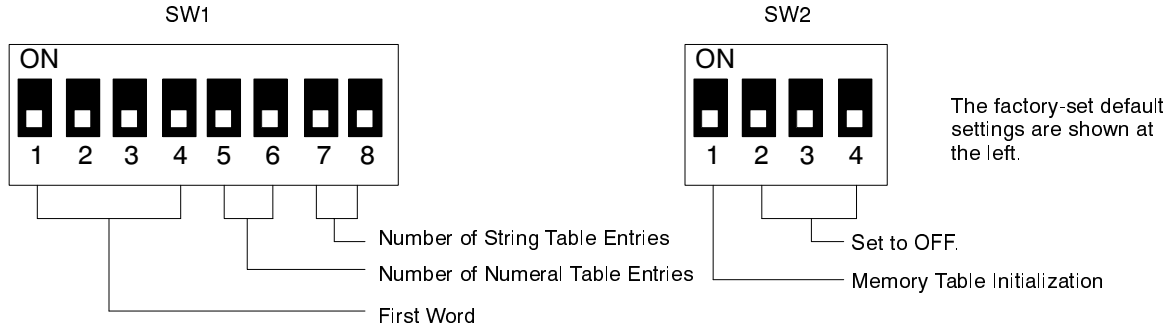

Setting the First Word

All data transfers between the C200H Interface Unit and the PC are executed using the PC's DM area. The first word used in the DM area is set with SW1, as shown in the following table.

Pin 1	Pin 2	Pin 3	Pin 4	First word
OFF	OFF	OFF	OFF	DM 0000
ON	OFF	OFF	OFF	DM 0064
OFF	ON	OFF	OFF	DM 0128
ON	ON	OFF	OFF	DM 0192
OFF	OFF	ON	OFF	DM 0256
ON	OFF	ON	OFF	DM 0320
OFF	ON	ON	OFF	DM 0384
ON	ON	ON	OFF	DM 0448
OFF	OFF	OFF	ON	DM 0512
ON	OFF	OFF	ON	DM 0576
OFF	ON	OFF	ON	DM 0640
ON	ON	OFF	ON	DM 0704
OFF	OFF	ON	ON	DM 0768
ON	OFF	ON	ON	DM 0832
OFF	ON	ON	ON	Cannot be set. See note.
ON	ON	ON	ON	Cannot be set.

Note This setting (DM 0896) is allowed in the C200H, but not in Mini H-type PCs.

Setting the Number of Numeral Table Entries

Use pins 5 and 6 of SW1 to set the number of numeral table entries to 0, 32, 64, or 128.

Pin 5	Pin 6	No. of entries	Entry numbers
OFF	OFF	0	---
ON	OFF	32	00 to 31
OFF	ON	64	00 to 63
ON	ON	128	00 to 127

Setting the Number of String Table Entries

Use pins 7 and 8 of SW1 to set the number of string table entries to 0, 8, 16, or 32.

Pin 7	Pin 8	No. of entries	Entry numbers
OFF	OFF	0	---
ON	OFF	8	00 to 07
OFF	ON	16	00 to 15
ON	ON	32	00 to 31

Memory Table Initialization (SW2)

Pin 1 of SW2 determines whether the initial memory table values used are the ones in the PT (set from the Support Tool) or the ones in the PC's DM Area.

For example, pin 1 would be turned OFF (DM Area value) when displaying the production quantity number on the PT's screen, so the previous production quantity would be displayed. Pin 1 would be turned ON (value set from Support Tool) to display the initial value.

Pin 1	Memory table initial value
OFF	Initial values set by the Support Tool
ON	Initial values in the PC's DM

DM Word Allocation

The following table shows the DM word ranges for every combination of numeral and string table sizes. The maximum possible value for "n" (the first DM word) in the C200H and Mini H-type PCs is also shown for each combination.

Number of entries		Table range		Maximum "n"	
Numeral	String	Numeral	String	C200H	Mini H-type
0	0	---	---	DM 0896	DM 0832
32	0	n+16 to n+79	---	DM 0896	DM 0768
64	0	n+16 to n+143	---	DM 0832	DM 0704
128	0	n+16 to n+271	---	DM 0704	DM 0576
0	8	---	n+16 to n+175	DM 0768	DM 0704
32	8	n+16 to n+79	n+80 to n+239	DM 0704	DM 0640
64	8	n+16 to n+143	n+144 to n+303	DM 0640	DM 0576
128	8	n+16 to n+271	n+272 to n+431	DM 0512	DM 0448
0	16	---	n+16 to n+335	DM 0640	DM 0512
32	16	n+16 to n+79	n+80 to n+399	DM 0576	DM 0448
64	16	n+16 to n+143	n+144 to n+463	DM 0512	DM 0384
128	16	n+16 to n+271	n+272 to n+591	DM 0384	DM 0256
0	32	---	n+16 to n+655	DM 0320	DM 0192
32	32	n+16 to n+79	n+80 to n+719	DM 0256	DM 0128
64	32	n+16 to n+143	n+144 to n+783	DM 0192	DM 0064
128	32	n+16 to n+271	n+272 to n+911	DM 0064	Cannot set.

Note The string table will overlap the Mini H-type PC's system setting area if the combination of 128 numeral tables and 32 string tables is set.

Appendix Special Characters

English Character Codes

Pin 3 of SW1 must be ON to enable English language messages to use the following codes.

Example: Hex code is represented by 30, decimal code by 48, and character by 0.

30	0
48	

Code 20 and 32 in the table represents a space, as indicated by "SP".

Hex Digits 1st → 2nd ↓	2-		3-		4-		5-		6-		7-		8-		9-	
-0	20	SP	30	0	40	@	50	P	60	'	70	p	80	Ç	90	É
	32		48		64		80		96		112		128		144	
-1	21	!	31	1	41	A	51	Q	61	a	71	q	81	ü	91	æ
	33		49		65		81		97		113		129		145	
-2	22	"	32	2	42	B	52	R	62	b	72	r	82	é	92	Æ
	34		50		66		82		98		114		130		146	
-3	23	#	33	3	43	C	53	S	63	c	73	s	83	â	93	ô
	35		51		67		83		99		115		131		147	
-4	24	\$	34	4	44	D	54	T	64	d	74	t	84	ä	94	ö
	36		52		68		84		100		116		132		148	
-5	25	%	35	5	45	E	55	U	65	e	75	u	85	à	95	ò
	37		53		69		85		101		117		133		149	
-6	26	&	36	6	46	F	56	V	66	f	76	v	86	â	96	û
	38		54		70		86		102		118		134		150	
-7	27	'	37	7	47	G	57	W	67	g	77	w	87	ç	97	ù
	39		55		71		87		103		119		135		151	
-8	28	(38	8	48	H	58	X	68	h	78	x	88	ê	98	ÿ
	40		56		72		88		104		120		136		152	
-9	29)	39	9	49	I	59	Y	69	i	79	y	89	ë	99	Ö
	41		57		73		89		105		121		137		153	
-A	2A	*	3A	:	4A	J	5A	Z	6A	j	7A	z	8A	è	9A	Ü
	42		58		74		90		106		122		138		154	
-B	2B	+	3B	;	4B	K	5B	[6B	k	7B	{	8B	ï	9B	ç
	43		59		75		91		107		123		139		155	
-C	2C	,	3C	<	4C	L	5C	\	6C	l	7C		8C	î	9C	£
	44		60		76		92		108		124		140		156	
-D	2D	-	3D	=	4D	M	5D]	6D	m	7D	}	8D	ì	9D	¥
	45		61		77		93		109		125		141		157	
-E	2E	.	3E	>	4E	N	5E	^	6E	n	7E	~	8E	Ä	9E	Pt
	46		62		78		94		110		126		142		158	
-F	2F	/	3F	?	4F	O	5F	_	6F	o	7F	△	8F	Å	9F	f
	47		63		79		95		111		127		143		159	

Hex Digits 1st → 2nd ↓	A-		B-		C-		D-		E-		F-	
-0	A0	á	B0	⋮	C0	┌	D0	⊥	E0	α	F0	≡
	160		176	⋮	192		208		224		240	
-1	A1	í	B1	■	C1	└	D1	⊥	E1	β	F1	+
	161		177		193		209		225		241	
-2	A2	ó	B2	⋮	C2	┐	D2	⊥	E2	Γ	F2	≥
	162		178		194		210		226		242	
-3	A3	ú	B3	┌	C3	└	D3	┌	E3	π	F3	≤
	163		179		195		211		227		243	
-4	A4	ñ	B4	└	C4	—	D4	┌	E4	Σ	F4	∫
	164		180		196		212		228		244	
-5	A5	Ñ	B5	≡	C5	+	D5	F	E5	σ	F5	J
	165		181		197		213		229		245	
-6	A6	ä	B6	┌	C6	F	D6	⊥	E6	m	F6	÷
	166		182		198		214		230		246	
-7	A7	ö	B7	┐	C7	┌	D7	≡	E7	τ	F7	≈
	167		183		199		215		231		247	
-8	A8	¿	B8	└	C8	┌	D8	≡	E8	Φ	F8	%
	168		184		200		216		232		248	
-9	A9	┌	B9	┌	C9	┌	D9	┌	E9	Θ	F9	.
	169		185		201		217		233		249	
-A	AA	┐	BA		CA	⊥	DA	┌	EA	W	FA	•
	170		186		202		218		234		250	
-B	AB	1/2	BB	┐	CB	⊥	DB	■	EB	δ	FB	√
	171		187		203		219		235		251	
-C	AC	1/4	BC	┌	CC	┌	DC	■	EC	∞	FC	n
	172		188		204		220		236		252	
-D	AD	i	BD	┌	CD	≡	DD	■	ED	f	FD	2
	173		189		205		221		237		253	
-E	AE	«	BE	┌	CE	≡	DE	■	EE	ε	FE	■
	174		190		206		222		238		254	
-F	AF	»	BF	┐	CF	⊥	DF	■	EF	∩	FF	
	175		191		207		223		239		255	

Index

A-C

abbreviations, 2

command codes

- C200H
 - PC-to-PT, 81
 - PT-to-PC, 88
- SYSMAC BUS, 46, 52
- SYSMAC WAY, PC to PT, 20, 27, 81, 88

command operation

- PC to PT, SYSMAC BUS, 45
- PT-to-PC, SYSMAC BUS, 52

commands

- DM word allocation
 - C200H, 76
 - SYSMAC WAY, 15
- I/O allocation, SYSMAC BUS, 45, 52

communications

- check
 - C200H, 93
 - SYSMAC BUS, 59
- errors
 - C200H, 94
 - SYSMAC WAY, 31

connections

- C200H, method, 73
- C20H, 96
- Mini H-type, 96
- SYSMAC BUS, 39
- SYSMAC WAY, 12

connectors, C200H, shape, 72

copy memory table entry, 25, 52, 86

D

designated screen display, 20, 46, 82

display control, lamp and touch switch, 23, 84

- bit designation, 50
- numeric designation, 49

DM word allocation

- C200H, 76
- SYSMAC WAY, 15

E

editing, numeral table, 29, 53, 91

EEPROM, 3

error processing, SYSMAC BUS, 62

I

I/O allocation

- memory table area, 17
- PC to PT, 16
- PT to PC, 16

I/O response time

- C1000H/C2000H, SYSMAC BUS, 62
- C200H, SYSMAC BUS, 61
- C500, 61
- SYSMAC BUS, 61

I/O word allocation

- C1000H, 43
- C2000H, 43
- C200H, 41
- C500, 42
- CV1000, 44
- CV500, 44

indicators, SYSMAC BUS, 39

input

- function key, 28, 91
- bit input, 56
- numeric input, 56
- touch switch, 27, 90
- bit input, 28, 29, 55, 90, 91
- numeric input, 55

installation, 4

L-O

lamp, display control, 23, 84

LED indicators, SYSMAC BUS, 39

major components, SYSMAC WAY, 8

manuals, 2

nomenclature

- host connector, 4
- PT connector, 4
- switch cover, 4

operational flow, 19

P

pin arrangement, connector, SYSMAC WAY, 12

precautions, C200H, 75

programming, interchanging SYSMAC WAY and C200H programs, 81, 88

PT status flags, 27, 89

- SYSMAC BUS, 53

R-S

removal, 4

response to screen number request
 SYSMAC BUS, 54
 SYSMAC WAY, 30, 93

screen number request, 24, 50, 86
 response to
 SYSMAC BUS, 54
 SYSMAC WAY, 30, 93

settings
 C200H, 97
 checking
 C200H, 75
 SYSMAC WAY, 14
 communications, SYSMAC WAY, 9
 first word
 C200H, 71
 C200H (for Mini H-type PCs), 98
 host link unit, RS-422, 13
 memory table initialization, C200H, 72, 78, 99
 numeral table
 C200H, 71, 98
 SYSMAC BUS, 46
 SYSMAC WAY, 20, 82
 string table
 C200H, 71, 99
 SYSMAC BUS, 48
 SYSMAC WAY, 21, 83
 switches, SYSMAC BUS, 7
 unit number, C200H, 70, 97

special characters, 101

specifications
 SYSMAC bus, 37
 SYSMAC WAY, 7, 8

strobe, SYSMAC WAY, 19, 89

system configuration, Mini H-type, 96

system settings
 C200H, 97
 Mini H-type, 97

system status control, 25, 51, 87

T

terminals, SYSMAC BUS, 40

terminology, 2

touch switch, display control, 23, 84

transfer time
 C1000H/C2000H Wired Remote I/O system, 62
 C200H Wired Remote I/O system, 61
 C500 Wired Remote I/O system, 60, 61

Revision History

A manual revision code appears as a suffix to the catalog number on the front cover of the manual.

V003-E1-3

↑
Revision code

The following table outlines the changes made to the manual during each revision. Page numbers refer to the previous version.

Revision code	Date	Revised content
1	October 1991	Original production
2	October 1992	Section 6, dealing with the C200H Interface, was added to the manual. Page 17: "ESC Z" has been changed to "ESC z" in the "Communications Format for History Data" table. Pages 40, 42, 47: A note relating to the C200H Interface has been added. Page 77: The appearance/position of the character has been altered for DC, DF, F9, and FA.
3	October 1993	<i>Section 2 RS-232C Interface</i> and <i>Section 3 RS-422 Interface</i> were removed from the manual. These sections are now parts of the <i>RS-232C/RS422 Interface Units Operation Manual (V016)</i> . The rest of the manual has been extensively rewritten and added to.