

# Solid-state timer

## H3RN-□-B

### Compact, Multi-function Timers for G2R Relay Socket



- The Push-In Plus Terminal Block Socket-compatible H3RN-□-B Timers in a black design join the Compact, Multi-function H3RN Timers.

- Standard multiple time ranges and multiple operating modes.

- UL listed.\*

Conforms to CSA and CE Marking.

\* When used in combination with a Push-In Plus Terminal Block Socket (P2RF-□-PU).

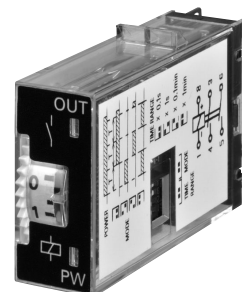

For the most recent information on models that have been certified for safety standards, refer to your OMRON website.

Refer to *Safety Precautions* on page 6.

## Model Number Structure

### Model Number Legend

H3RN-□□-B  
1 2

#### 1. Output

- 1: SPDT
- 2: DPST-NO

#### 2. Time Range

- None: Short-time range (0.1 s to 10 min)
- 1: Long-time range (0.1 min to 10 hrs)

## Ordering Information

### List of Models

Supply voltage	Time-limit contact	Short-time range model (0.1 s to 10 min)	Long-time range model (0.1 min to 10 h)
24 VAC; 12, 24 VDC	SPDT	H3RN-1-B	H3RN-11-B
	DPST-NO	H3RN-2-B	H3RN-21-B

**Note:** Specify both the model number and supply voltage when ordering.

Example: H3RN-1-B 24 VAC

Supply voltage

### Accessories (Order Separately)

#### Socket

Timer	Track mounting/Front connecting socket
H3RN-1-B/-11-B	P2RF-05-PU
H3RN-2-B/-21-B	P2RF-08-PU

# H3RN-□-B

## Specifications

### Ratings

Item	H3RN-1-B/H3RN-2-B	H3RN-11-B/H3RN-21-B
Time ranges	0.1 s to 10 min (1 s, 10 s, 1 min, or 10 min max. selectable)	0.1 min to 10 h (1 min, 10 min, 1 h, or 10 hrs max. selectable)
Rated supply voltage *2	24 VAC (50/60 Hz); 12, 24 VDC	
Pin type	Plug-in	
Operating mode	ON-delay, interval, flicker OFF-start, or flicker-ON start selectable by DIP switch	
Operating voltage range	85% to 110% of rated supply voltage (12 VDC: 90% to 110% of rated supply voltage) *1	
Reset voltage	10% max. of rated supply voltage	
Power consumption	24 VAC: Relay ON: approx. 0.8 VA 12 VDC: Relay ON: approx. 0.5 W 24 VDC: Relay ON: approx. 0.4 W	
Control outputs	3 A at 250 VAC, resistive load (cosφ = 1) (G6B-2□14P-FD-US used (Contact materials : AgSnIn)) The minimum applicable load is 10 mA at 5 VDC (P reference value).	

\*1. When using the H3RN in any place where the ambient temperature is more than 50°C, supply 90% to 110% of the rated voltages (12 VDC: 95% to 110% of the rated voltage).

\*2. Refer to *Safety Precautions for All Times* when combining the Timer with an AC 2-wire proximity sensor.

### Characteristics

Item	H3RN-1-B/H3RN-2-B	H3RN-11-B/H3RN-21-B
Accuracy of operating time	±1% FS max. (1 s range: ±1%±10 ms max.)	
Setting error	±15%±50 ms FS max.	
Reset time	Min. power-opening time: 12, 24 VDC: 0.1 s max. (including halfway reset) 24 VAC: 0.5 s max. (including halfway reset)	
Influence of voltage	±2% FS max.	
Influence of temperature	±2% FS max.	
Insulation resistance	100 MΩ min. (at 500 VDC)	
Dielectric strength	2,000 VAC, 50/60 Hz for 1 min (between operating circuit and control output, or contacts of different poles) 1,000 VAC, 50/60 Hz for 1 min (between non-continuous contacts)	
Vibration resistance	Destruction: 10 to 55 Hz, 0.75-mm single amplitude for 1 h each in 3 directions Malfunction: 10 to 55 Hz, 0.5-mm single amplitude for 10 min each in 3 directions	
Shock resistance	Destruction: 980 m/s <sup>2</sup> *1 Malfunction: 100 m/s <sup>2</sup>	
Ambient temperature	Operating: -10°C to 55°C (with no icing) Storage: -25°C to 65°C (with no icing)	
Ambient humidity	Operating: 35% to 85%	
Life expectancy	Mechanical: 10,000,000 operations min. (under no load at 1,800 operations/h) Electrical: 100,000 operations min. (3 A at 250 VAC, resistive load at 1,800 operations/h)	
Impulse withstand voltage	Between power terminals: 1 kV	
Noise immunity	±1.5 kV, square-wave noise by noise simulator (pulse width: 100 ns/1 μs, 1-ns rise)	
Static immunity	Destruction: 8 kV Malfunction: 4 kV	
Degree of protection	IP40 (Terminal screw sections are excluded.)	
Weight	Approx. 18 g	
EMC	(EMI) EN 61812-1 Emission Enclosure: EN 55011 Group 1 class A Emission AC Mains: EN 55011 Group 1 class A (EMS) EN 61812-1 Immunity ESD: IEC 61000-4-2 Immunity RF-interference: IEC 61000-4-3 Immunity Burst: IEC 61000-4-4 Immunity Surge: IEC 51000-4-5 Immunity Conducted Disturbance: IEC 61000-4-6 Immunity Voltage Dip/Interruption: IEC 61000-4-11	
Approved standards	cULus (or cURus): UL 508/CSA C22.2 No.14 *2, CSA C22.2 No.14 Conforms to EN 61812-1, IEC 60664-1 4 kV/2.	

\*1. The destructive shock resistance test was performed on a standalone Timer.

\*2. cULus (Listing): Applicable when an OMRON P2RF-□-PU Socket is used.  
cURus (Recognition): Applicable when any other socket is used.

# Connections

## Connection

### H3RN-1-B/H3RN-11-B

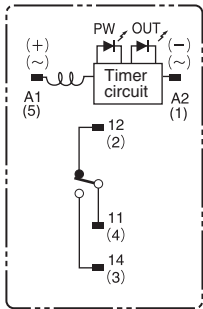

Bottom View

#### DIN Indication

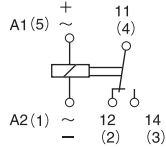

### H3RN-2-B/H3RN-21-B

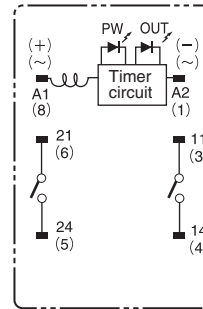

Bottom View

#### DIN Indication

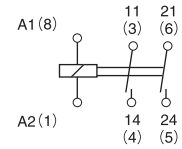

## Pulse Operation

A pulse output for a certain period can be obtained with a random external input signal. Use the H3RN in interval mode as shown in the following timing charts.

### H3RN-2-B/H3RN-21-B

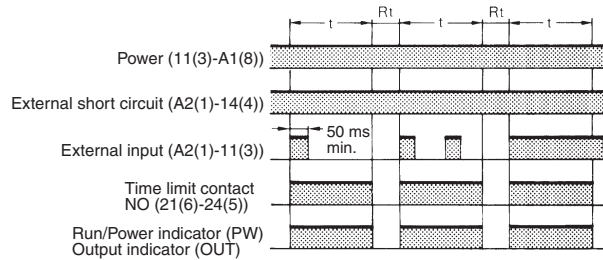
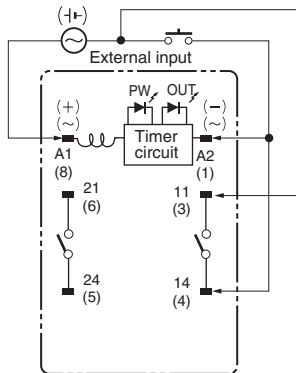

**Note:** t: Set time  
Rt: Reset time

### Caution

Be careful when connecting wires.

Mode	Terminals
<b>Pulse operation</b>	Power supply between 11(3) and A1(8) Short-circuit between 14(4) and A2(1) Input signal between 11(3) and A2(1)
<b>Operating mode; interval and all other modes</b>	Power supply between A2(1) and A1(8)

# H3RN-□-B

## Nomenclature

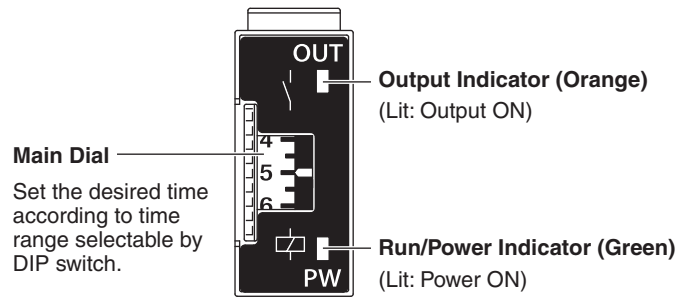

## Dimensions

(Unit: mm)

### Timers

#### H3RN-1-B/H3RN-11-B Front Mounting

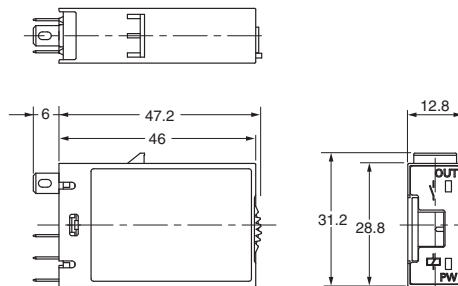
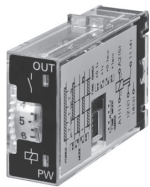

**Note:** Use the P2RF-08-PU Front-mounting Sockets.

#### H3RN-2-B/H3RN-21-B Front Mounting

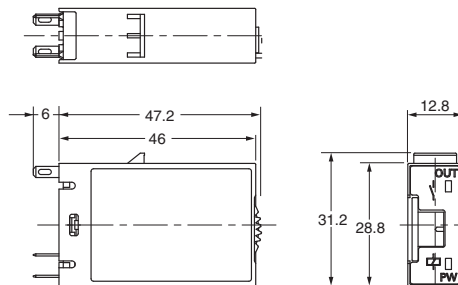
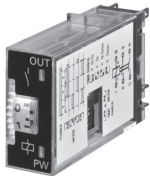

**Note:** Use the P2RF-08-PU Front-mounting Sockets.

#### P2RF-□-E

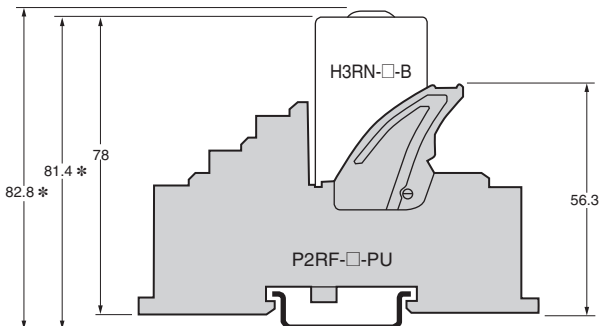

**Note:** There are no restrictions to the mounting direction.

\* These values apply when the PFP-□N is used.

Add 9 mm if you use the PFP-□N2.

## Connecting Sockets

### P2RF-05-PU

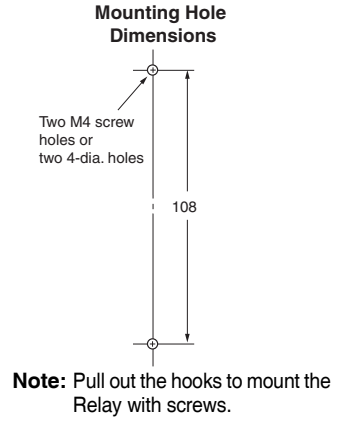
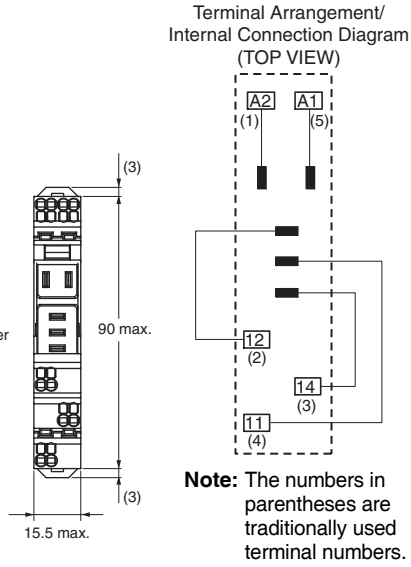
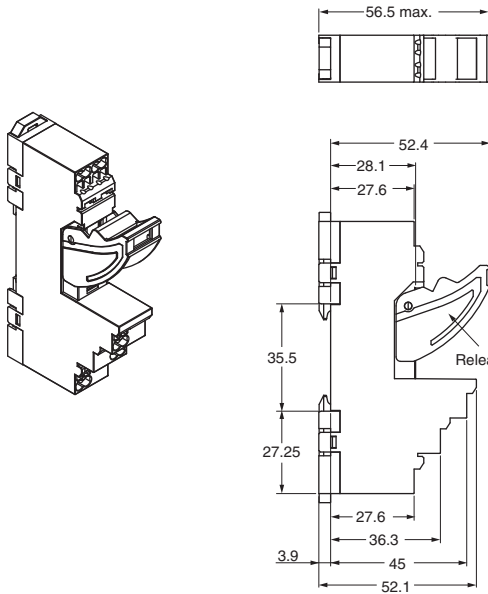

### P2RF-08-PU

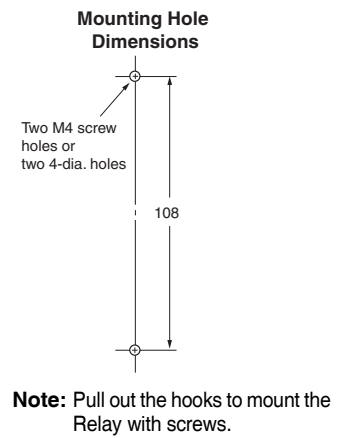
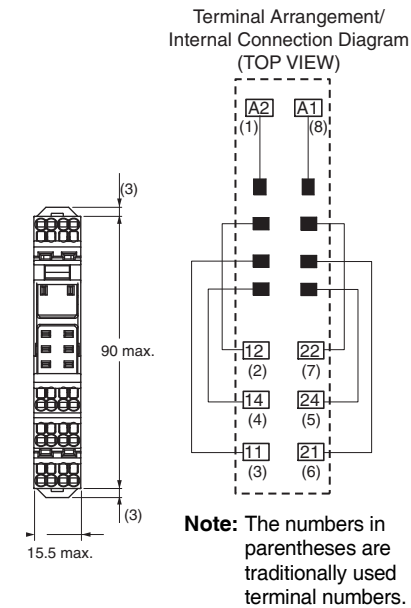
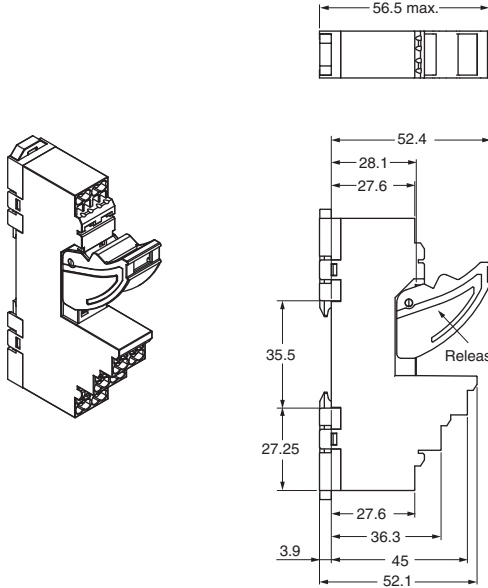

## Safety Precautions

### Precautions for Correct Use

- When using the H3RN-□-B in any place where the ambient temperature is more than 50°C, supply 90% to 110% of the rated voltages (at 12 VDC: 95% to 110%).
- Do not leave the H3RN-□-B in time-up condition (i.e., with the internal relay in an ON state) for a long period of time (for example, more than one month in any place where the ambient temperature is high), otherwise the internal parts may become damaged. Therefore, the use of the H3RN-□-B with a relay as shown in the following circuit diagram is recommended.

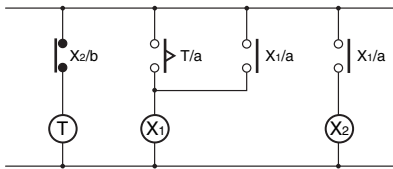

⊗ : Auxiliary relay such as G2R Relay

- The H3RN must be disconnected from the socket when setting the DIP switch, otherwise the user may touch a terminal imposed with a high voltage and get an electric shock.
- Do not connect the H3RN-□-B as shown in the following circuit diagram on the right hand side, otherwise the H3RN-□-B's internal contacts different from each other in polarity may become short-circuited.

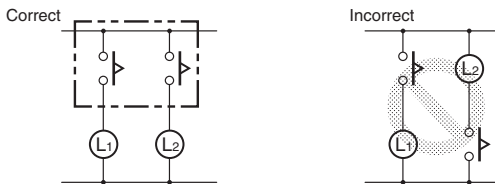

- Use the following safety circuit when building a self-holding circuit with the H3RN-□-B and an auxiliary relay, such as a G2R Relay, in combination.

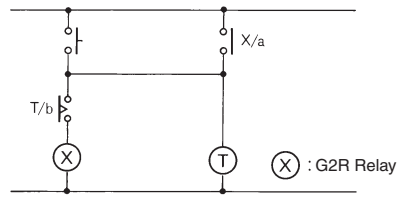

- In the case of the above circuit, the H3RN-□-B will be in pulse operation. Therefore, if the circuit shown on page 3 is used, no auxiliary relay will be required.
- Do not use the SPDT contact in a circuit which may cause short-circuiting at three points (otherwise, short-circuiting of the power supply may occur) because the SPDT contact of H3RN-1-B/-11-B is composed of an SPST-NC contact.

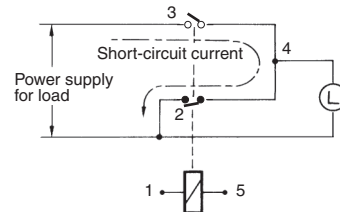

- Do not set to the minimum setting in the flicker modes, otherwise the contact may be damaged.
- Do not use the H3RN-□-B in places where there is excessive dust, corrosive gas, or direct sunlight.
- Make sure that there is a space of 3 mm or more between any H3RN-□-B Models next to each other. (When using the P2RF-08-PU Socket, a space of 3 mm or more will be secured.) If a space of 3 mm or more is not secured, the ambient temperature must be less than 50°C.
- The internal parts may become damaged if a supply voltage other than the rated ones is imposed on the H3RN-□-B.

## Precautions for EN 61812-1 Conformance

The H3RN-□-B as a built-in timer conforms to EN 61812-1 provided that the following conditions are satisfied.

### Handling

- Do not touch the DIP switch while power is supplied to the H3RN-□-B.
- Before dismounting the H3RN-□-B from the socket, make sure that no voltage is imposed on any terminal of the H3RN-□-B.

### Wiring

- Basic insulation is ensured between the H3RN-□-B's operating circuit and control output.  
Basic insulation: Overvoltage category III, pollution degree 2 (with a clearance of 3.0 mm and a creepage distance of 3.0 mm at 240 VAC)
- When using the P2RF-□-PU Socket, basic insulation is ensured in the mounted condition for a voltage of 250 VAC max.

## Recommended Replacement Periods and Periodic Replacement as Preventive Maintenance

The recommended replacement period for preventive maintenance is greatly influenced by the application environment of the product. As a guideline for models that do not have a Maintenance Forecast Monitor, the recommended replacement period is 7 to 10 years.\* To prevent failures that can be caused by using a product beyond its service life, we recommend that you replace the product as early as possible within the recommended replacement period. However, realize that the recommended replacement period is for reference only and does not guarantee the life of the product.

Many electronic components are used in the product and the product depends on the correct operation of these components to achieve product functions and performance. However, the influence of the ambient temperature on aluminum electrolytic capacitors is large, and the service life is reduced by half for each 10°C rise in temperature (Arrhenius law). When the capacity reduction life of the electrolytic capacitor is reached, the product may fail. We therefore recommend that you replace the product periodically to minimize product failures in advance.

\* The following conditions apply: rated input voltage, load rate of 50% max., ambient temperature of 35°C max., and the standalone mounting method.

This product model is designed with a service life of 10 years minimum under the above conditions.

## Operation

### DIP Switch Settings

The 1-s range and ON-delay mode for H3RN-1-B/-2-B, 1-min range and ON-delay mode for H3RN-11-B/-21-B are factory-set before shipping.

### Time Ranges

Model	Time range	Time setting range	Setting	Factory-set
H3RN-1-B, H3RN-2-B	1 s	0.1 to 1 s		Yes
	10 s	1 to 10 s		No
	1 min	0.1 to 1 min		No
	10 min	1 to 10 min		No
H3RN-11-B, H3RN-21-B	1 min	0.1 to 1 min		Yes
	10 min	1 to 10 min		No
	1 h	0.1 to 1 h		No
	10 h	1 to 10 h		No

**Note:** The left two DIP switch pins are used to select the time ranges.

### Operating Modes

Operating mode	Setting	Factory-set
ON-delay		Yes
Interval		No
Flicker OFF-start		No
Flicker ON-start		No

**Note:** The right two DIP switch pins are used to select the operating modes.

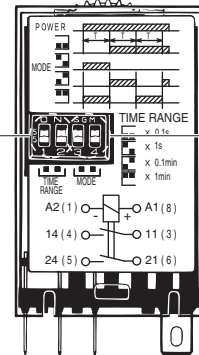

## Timing Chart

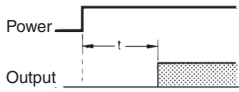
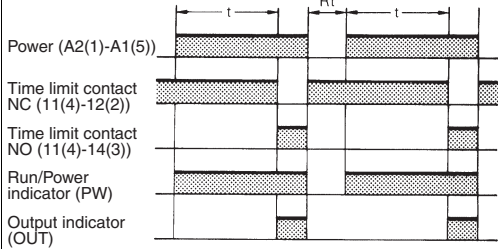
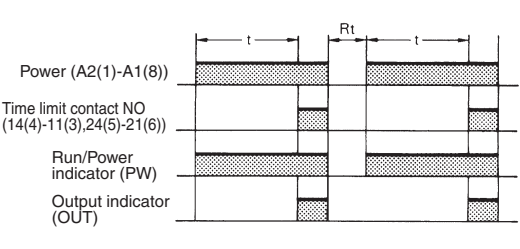
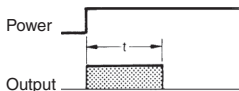
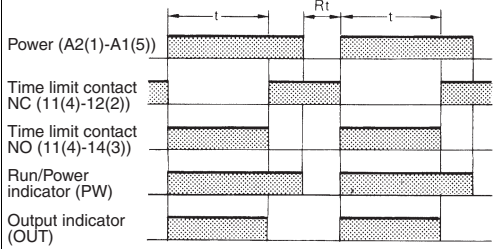
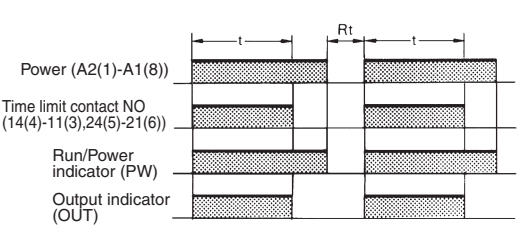
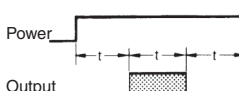
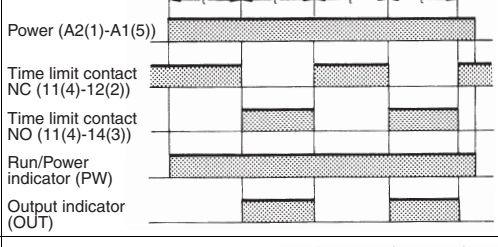
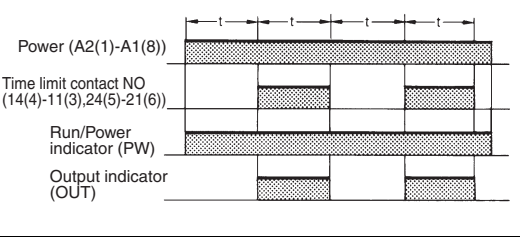
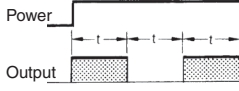
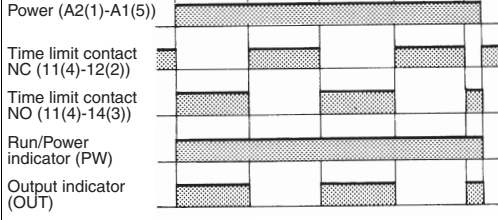
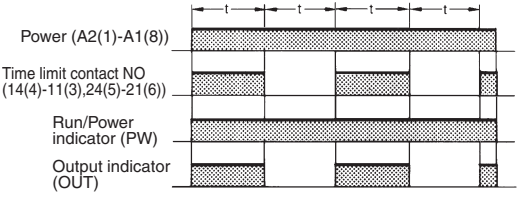
Operating mode	Timing chart	
	H3RN-1-B/H3RN-11-B	H3RN-2-B/H3RN-21-B
<b>ON-delay</b> 		
<b>Interval</b> 		
<b>Flicker OFF-start</b> 		
<b>Flicker ON-start</b> 		

**Note:** t: Set time  
Rt: Reset time



# Terms and Conditions Agreement

## **Read and understand this catalog.**

Please read and understand this catalog before purchasing the products. Please consult your OMRON representative if you have any questions or comments.

## **Warranties.**

- (a) Exclusive Warranty. Omron's exclusive warranty is that the Products will be free from defects in materials and workmanship for a period of twelve months from the date of sale by Omron (or such other period expressed in writing by Omron). Omron disclaims all other warranties, express or implied.
- (b) Limitations. OMRON MAKES NO WARRANTY OR REPRESENTATION, EXPRESS OR IMPLIED, ABOUT NON-INFRINGEMENT, MERCHANTABILITY OR FITNESS FOR A PARTICULAR PURPOSE OF THE PRODUCTS. BUYER ACKNOWLEDGES THAT IT ALONE HAS DETERMINED THAT THE PRODUCTS WILL SUITABLY MEET THE REQUIREMENTS OF THEIR INTENDED USE.

Omron further disclaims all warranties and responsibility of any type for claims or expenses based on infringement by the Products or otherwise of any intellectual property right. (c) Buyer Remedy. Omron's sole obligation hereunder shall be, at Omron's election, to (i) replace (in the form originally shipped with Buyer responsible for labor charges for removal or replacement thereof) the non-complying Product, (ii) repair the non-complying Product, or (iii) repay or credit Buyer an amount equal to the purchase price of the non-complying Product; provided that in no event shall Omron be responsible for warranty, repair, indemnity or any other claims or expenses regarding the Products unless Omron's analysis confirms that the Products were properly handled, stored, installed and maintained and not subject to contamination, abuse, misuse or inappropriate modification. Return of any Products by Buyer must be approved in writing by Omron before shipment. Omron Companies shall not be liable for the suitability or unsuitability or the results from the use of Products in combination with any electrical or electronic components, circuits, system assemblies or any other materials or substances or environments. Any advice, recommendations or information given orally or in writing, are not to be construed as an amendment or addition to the above warranty.

See <http://www.omron.com/global/> or contact your Omron representative for published information.

## **Limitation on Liability; Etc.**

OMRON COMPANIES SHALL NOT BE LIABLE FOR SPECIAL, INDIRECT, INCIDENTAL, OR CONSEQUENTIAL DAMAGES, LOSS OF PROFITS OR PRODUCTION OR COMMERCIAL LOSS IN ANY WAY CONNECTED WITH THE PRODUCTS, WHETHER SUCH CLAIM IS BASED IN CONTRACT, WARRANTY, NEGLIGENCE OR STRICT LIABILITY.

Further, in no event shall liability of Omron Companies exceed the individual price of the Product on which liability is asserted.

## **Suitability of Use.**

Omron Companies shall not be responsible for conformity with any standards, codes or regulations which apply to the combination of the Product in the Buyer's application or use of the Product. At Buyer's request, Omron will provide applicable third party certification documents identifying ratings and limitations of use which apply to the Product. This information by itself is not sufficient for a complete determination of the suitability of the Product in combination with the end product, machine, system, or other application or use. Buyer shall be solely responsible for determining appropriateness of the particular Product with respect to Buyer's application, product or system. Buyer shall take application responsibility in all cases.

NEVER USE THE PRODUCT FOR AN APPLICATION INVOLVING SERIOUS RISK TO LIFE OR PROPERTY OR IN LARGE QUANTITIES WITHOUT ENSURING THAT THE SYSTEM AS A WHOLE HAS BEEN DESIGNED TO ADDRESS THE RISKS, AND THAT THE OMRON PRODUCT(S) IS PROPERLY RATED AND INSTALLED FOR THE INTENDED USE WITHIN THE OVERALL EQUIPMENT OR SYSTEM.

## **Programmable Products.**

Omron Companies shall not be responsible for the user's programming of a programmable Product, or any consequence thereof.

## **Performance Data.**

Data presented in Omron Company websites, catalogs and other materials is provided as a guide for the user in determining suitability and does not constitute a warranty. It may represent the result of Omron's test conditions, and the user must correlate it to actual application requirements. Actual performance is subject to the Omron's Warranty and Limitations of Liability.

## **Change in Specifications.**

Product specifications and accessories may be changed at any time based on improvements and other reasons. It is our practice to change part numbers when published ratings or features are changed, or when significant construction changes are made. However, some specifications of the Product may be changed without any notice. When in doubt, special part numbers may be assigned to fix or establish key specifications for your application. Please consult with your Omron's representative at any time to confirm actual specifications of purchased Product.

## **Errors and Omissions.**

Information presented by Omron Companies has been checked and is believed to be accurate; however, no responsibility is assumed for clerical, typographical or proofreading errors or omissions.

**OMRON Corporation Industrial Automation Company**  
Kyoto, JAPAN

Contact: [www.ia.omron.com](http://www.ia.omron.com)

**Regional Headquarters**

**OMRON EUROPE B.V.**

Wegalaan 67-69, 2132 JD Hoofddorp  
The Netherlands  
Tel: (31)2356-81-300/Fax: (31)2356-81-388

**OMRON ELECTRONICS LLC**

2895 Greenspoint Parkway, Suite 200  
Hoffman Estates, IL 60169 U.S.A.  
Tel: (1) 847-843-7900/Fax: (1) 847-843-7787

**OMRON ASIA PACIFIC PTE. LTD.**

No. 438A Alexandra Road # 05-05/08 (Lobby 2),  
Alexandra Technopark,  
Singapore 119967  
Tel: (65) 6835-3011/Fax: (65) 6835-2711

**OMRON (CHINA) CO., LTD.**

Room 2211, Bank of China Tower,  
200 Yin Cheng Zhong Road,  
PuDong New Area, Shanghai, 200120, China  
Tel: (86) 21-5037-2222/Fax: (86) 21-5037-2200

**Authorized Distributor:**

© OMRON Corporation 2016 All Rights Reserved.  
In the interest of product improvement,  
specifications are subject to change without notice.

**Cat. No. M093-E1-01**

0316 (0316)